



Ex Libris

D.H. Lehmer

D. N. Lelund

U. of California 1904.

417 Mk

copy #10

Scarce.

A TREATISE ON THE ANALYTIC GEOMETRY
OF THREE DIMENSIONS.

CAMBRIDGE :
PRINTED BY W. METCALFE AND SON, TRINITY STREET.

A TREATISE
ON THE
ANALYTIC GEOMETRY
OF
THREE DIMENSIONS.

BY
GEORGE SALMON, D.D., D.C.L., LL.D., F.R.S.,
REGIUS PROFESSOR OF DIVINITY IN THE UNIVERSITY OF DUBLIN.

FOURTH EDITION.

Dublin:
HODGES, FIGGIS, & CO., GRAFTON STREET,
BOOKSELLERS TO THE UNIVERSITY.

MDCCCLXXXII.



PREFACE TO THE THIRD EDITION.

IN the preface to the second edition of my *Higher Plane Curves*, I have explained the circumstances under which I obtained Professor Cayley's valuable help in the preparation of that volume. I have now very gratefully to acknowledge that the same assistance has been continued to me in the re-editing of the present work. The changes from the preceding edition are not so numerous here as in the case of the *Higher Plane Curves*, partly because the book not having been so long out of print required less alteration, partly because the size to which the volume had already swelled made it necessary to be sparing in the addition of new matter. Prof. Cayley having read all the proof sheets, the changes made at his suggestion are too numerous to be particularized; but the following are the parts which, on now looking through the pages, strike me as calling for special acknowledgement, as being entirely or in great measure derived from him; Arts.* 51—53 on the six coordinates of a line, the account of focal lines Art. 146, Arts.† 314—322 on Gauss's method of representing the coordinates of a point on a surface by two parameters. The discussion of Orthogonal Surfaces is taken from a manuscript memoir of Prof. Cayley's,

* These articles have been altered in the present edition.

† Now Arts. 377—384.

Arts.* 332—337 nearly without alteration, and the following articles with some modifications of my own. Prof. Cayley has also contributed Arts.† 347 and 359 on Curves, Art.‡ 468 on Complexes, Arts. 567 to the end of the chapter on Quartics, and Arts.§ 600 to the end. Prof. Casey and Prof. Cayley had each supplied me with a short note on Cyclides, but I found the subject so interesting that I wished to give it fuller treatment, and had recourse to the original memoirs.

I have omitted the appendix on Quaternions which was given in the former editions, the work of Professors Kelland and Tait having now made information on this subject very easy to be obtained. I have also omitted the appendix on the order of Systems of Equations, which has been transferred to the Treatise on Higher Algebra.

I have, as on several former occasions, to acknowledge help given me, in reading the proof sheets, by my friends Dr. Hart, Mr. Cathcart and Dr. Fiedler.

* Now Arts. 476—479.

† Now Art. 453.

‡ Now Arts. 316 and 328.

§ Now Art. 620.

Owing to the continued pressure of other engagements I have been able to take scarcely any part in the revision of this fourth edition. My friend, Mr. Cathcart, has laid me under the great obligation of taking the work almost entirely off my hands, and it is at his suggestion that some few changes have been made from the last edition.

CONTENTS.

The following selected course is recommended to Junior Readers: The Theory of Surfaces of the Second Order, pp. 1—125, omitting articles specially indicated in footnotes. Confocal Surfaces, Arts. 157—170. The Curvature of Quadrics, pp. 167—172, The General Theory of Surfaces, Chap. XI. The Theory of Curves, Arts. 314—323, 358—360, 364—366, 373—375. And the Chapter on Families of Surfaces, Arts. 422—445.

CHAPTER I.

THE POINT.

	PAGE
Method of coordinates	1
Properties of projections	3
Coordinates of point cutting in a given ratio the distance between two points	5
Coordinates of centre of a tetrahedron	6
Distance between two points (rectangular coordinates)	6
Direction-cosines of a line	7
Area of a figure in terms of areas of its projections	7
Angle between two lines in terms of their direction-cosines	8
Perpendicular distance of a point from a line	8
Direction-cosines of the perpendicular to the plane of two lines	9
TRANSFORMATION OF COORDINATES	9
Distance between two points (oblique coordinates)	11
Degree of an equation unaltered by transformation	11

CHAPTER II.

INTERPRETATION OF EQUATIONS.

Meaning of a single equation ; of a system of two or three equations	12
Every plane section of a surface of the n^{th} degree is a curve of the n^{th} degree	14
Every right line meets a surface of the n^{th} degree in n points	14
Order of a curve in space defined	14
Three surfaces of degrees m, n, p intersect in mnp points	15
Cylindrical surfaces defined	15

CHAPTER III.

THE PLANE AND RIGHT LINE.

Every equation of the first degree represents a plane	16
Equation of a plane in terms of its direction-cosines and perpendicular from origin	16
Angle between two planes	17
Condition that two planes may be mutually perpendicular	17
Equation of plane in terms of intercepts made on axes	17

	PAGE
Equation of plane through three points	18
Interpretation of terms in this equation	19
Value of determinant of the direction-cosines of three right lines	19
Length of perpendicular from a given point on a given plane	20
Coordinates of intersection of three planes	21
Condition that four planes may meet in a point	21
Volume of tetrahedron in terms of coordinates of its vertices	21
Volume of tetrahedron, the equations of whose faces are given	22
Equations of surfaces passing through intersection of given surfaces	22
The equation of any plane can be expressed in terms of those of four given planes	23
QUADRIPLANAR COORDINATES, AND THEIR DUAL INTERPRETATION	23
Anharmonic ratio of four planes	24
THE RIGHT LINE	24
Equations of a right line include four constants	24
Condition that two lines may intersect	25
Direction-cosines of a line whose equations are given	26
Equations of perpendicular from a given point on a given plane	27
Direction-cosines of the bisectors of the angle between two lines	27
Equation of plane bisecting the angle between two given planes	28
Angle between two lines	28
Conditions that a line may lie in a given plane	29
Number of conditions that a line may lie in a given surface	29
Existence of right lines on surfaces of the second and third degrees	29
Equation of plane drawn through a given line perpendicular to a given plane	29
Equation of plane parallel to two given lines	30
Equations and length of shortest distance between two given lines	31
THE SIX COORDINATES OF A LINE	33
Identical relation connecting them	33
Moment of two right lines	34
Relation connecting the mutual distances of four points in a plane	34
Volume of a tetrahedron in terms of its edges	35
Relation connecting mutual distances of four points on a sphere	35
Radius of sphere circumscribing a tetrahedron	37
Shortest distance between two opposite sides	37
Angle of inclination of two opposite sides	37
General formulæ for linear transformation of quadriplanar coordinates	37
Volume of tetrahedron in terms of homogeneous coordinates of vertices	39
Homogeneous coordinates of right line as ray and as axis	40
Passage from one system to the other	42
Condition of intersection of right lines	43
Lines meeting four right lines	43
Transformation of homogeneous coordinates of line	44

CHAPTER IV.

PROPERTIES OF QUADRICS IN GENERAL.

Number of conditions necessary to determine a quadric	45
Result of transformation to parallel axes	46
Equation of tangent plane at any point	47
Equation of polar plane	48
Cones defined—tangent cone	48

	PAGE
Cylinder the limiting case of a cone	48
Locus of extremities of harmonic means of radii through a point	48
Every homogeneous equation in x, y, z represents a cone whose vertex is the origin	49
Polar plane of a point with regard to a cone	50
Discriminant of a quadric	51
Coordinates of centre	52
Conditions that a quadric may have an infinity of centres	52
Equation of diametral plane	52
Conjugate diameters	54
A quadric has three principal diametral planes	55
Formation of equation representing the three principal planes	55
Rectangles under segments of intersecting chords proportional to the rectangles under the segments of a pair of parallel chords	56
Equations of tangent plane and cone, &c., derived by Joachimsthal's method	56
Condition that a plane may touch the surface	58
Coordinates of the pole of a given plane	58
Condition that a line may touch the surface	59
This condition a quadratic function of the six coordinates of a line	59
This condition derived from the former condition	59
Coordinates of polar line of a given line	60
Determination of points of contact of tangent planes through a given right line	62
Complex of lines	63
Conditions that a right line lie in a quadric	64

CHAPTER V.

CLASSIFICATION OF QUADRICS.

Functions of coefficients which are unaltered by rectangular transformation	66
Discriminating cubic	66
Cauchy's proof that its roots are real	67
Ellipsoids	68
Hyperboloids of one and of two sheets	69
Asymptotic cones	69
Paraboloids	72
Actual reduction of equation of a paraboloid	73

CHAPTER VI.

PROPERTIES OF QUADRICS DEDUCED FROM SPECIAL FORMS OF THEIR EQUATIONS.

CENTRAL SURFACES	75
Equation referred to axes	75
Length of normal	76
Sum of squares of reciprocals of three rectangular diameters is constant	76
Locus of intersection of three tangent planes which cut at right angles	77
CONJUGATE DIAMETERS	77
Sum of squares of three conjugate diameters is constant	78
Parallelepiped constant whose edges are conjugate diameters	78
Sum of squares of projections of conjugate diameters constant on any line or plane	79
Locus of intersection of tangent planes at extremities of conjugate diameters	80
Quadratic which determines lengths of axes of a central section	81
One section through any semi-diameter has it as an axis	81
Axes found when the quadric is given by the general equation	82

	PAGE
CIRCULAR SECTIONS	82
Form of equations of concyclic surfaces	83
Two circular sections of opposite systems lie on the same sphere	84
Umbilics defined	85
RECTILINEAR GENERATORS	85
Two lines of opposite systems must intersect	87
No two lines of the same system intersect	87
Ruled surfaces defined	87
Distinction between developable and skew surfaces	89
A right line whose motion is regulated by <i>three</i> conditions generates a surface	89
Surface generated by a line meeting three director lines	90
Ditto, when lines are given by their six coordinates	92
Four generators of one system cut any generator of the other in a constant anharmonic ratio	92
Surface generated by lines joining corresponding points on two homographically divided lines	92
NON-CENTRAL SURFACES	92
Functions unaltered by transformation of coordinates	93
Circular sections of paraboloids	93
Right lines on hyperbolic paraboloid	94
Method of constructing hyperbolic paraboloid	95
Conditions for SURFACES OF REVOLUTION	96
EXAMPLES OF LOCI	99
Locus of intersection of three rectangular tangent lines to a quadric	100
Method of finding equation of cone, given its vertex, and a curve through which it passes	101
Reciprocal cones	101
Orthogonal hyperboloids, equilateral hyperboloids	100, 102

CHAPTER VII.

METHODS OF ABRIDGED NOTATION.

RECIPROCAL SURFACES	103
Degree of the reciprocal of a surface, how measured	103
Reciprocal of a curve in space	104
Osculating plane of a curve defined	104
Plane section of one surface answers to tangent cone of reciprocal	104
Reciprocal of quadric, when ellipsoid, hyperboloid, or paraboloid	105
Reciprocal of ruled surface is ruled surface of same degree	105
Reciprocal cones defined	105
Sections by any plane of reciprocal cones are reciprocal	105
Focal lines of a cone defined	106
Reciprocal of sphere	106
Properties of surfaces of revolution obtained by reciprocation	107
Equation of reciprocal of a quadric	108
TANGENTIAL EQUATIONS	109
Tangential equation of a quadric	109
Equation of system of quadrics having common curve	111
All quadrics through seven points pass through an eighth	111
Locus of centres of quadrics touching eight planes	112
„ passing through eight points	113

	PAGE
Four cones pass through the intersection of two quadrics	113
Properties of systems of quadrics having double contact	115
Properties of three quadrics having one plane curve common	115
Similar quadrics	115
Geometrical solution of problem of circular sections	116
Twelve umbilics lie three by three on eight lines	116
Quadrics touching along a plane curve	117
Properties of their sections	117
Two quadrics enveloped by the same third intersect in plane curves	117
Form of equation referred to self-conjugate tetrahedron	117
Lines joining vertices of tetrahedron to corresponding vertices of polar tetrahedron all generators of same hyperboloid	118
Analogues of Pascal's theorem	122
Hexagon of generators of a hyperboloid	123

CHAPTER VIII.

FOCI AND CONFOCAL SURFACES.

Focus and directrix of a quadric defined	126
Focus defined as intersection of two generators of circumscribed developable through circle at infinity	127
Foci in general lie on a curve locus	128
Surfaces when confocal	128
Two kinds of foci	128
Focal conics	129
Analysis of species of focal conics for each kind of quadric	130
Foci of sections normal to a focal conic	132
Focal lines of a cone	133
Focal conics of paraboloids	134
Focus and directrix property of quadrics	135
Tangent cone, whose vertex is a focus, is a right cone	136
Reciprocal of a quadric with regard to a focus is a surface of revolution	137
Property of umbilicar foci obtained by reciprocation	138
Focal properties of quadrics obtained by reciprocation	138
FOCAL CONICS AND CONFOCAL SURFACES	139
Three confocals through a point all real and of different species	141
Coordinates of intersection of three confocals	142
Coordinates of umbilics	142
Two confocals cut at right angles	143
Axes of central section in terms of axes of confocals through extremity of conjugate diameter	144
Expression for length of perpendicular on tangent plane	145
pD constant along the intersection of two confocals	146
Locus of pole of fixed plane with regard to a system of confocals	146
Axes of tangent cone are the three normals through its vertex	147
Transformation of equation of tangent cone to the three normals as axes of coordinates	149
Cones circumscribing confocal surfaces are confocal	151
The focal lines of these cones are the generators of the hyperboloid through the vertex	152
Reciprocals of confocals are concyclic	152

	PAGE
Tangent planes through any line to the two confocals which it touches are mutually perpendicular	153
Two confocals seen from any point appear to cut at right angles	153
Normals to tangent planes through a given line generate a hyperbolic paraboloid	153
Chasles's method of obtaining equation of tangent cone	155
Locus of intersection of three rectangular planes each touching a confocal	155
Intercept on bifocal chord between tangent plane and parallel central plane	157
Given three conjugate diameters of a quadric, to find the axes	157
Locus of vertices of right cones enveloping a quadric; which stand on given conic	158
Either of two focal conics may be considered as a locus of foci of the other	159
Locus of intersection of three mutually perpendicular tangent lines	160
Corresponding points on confocals	161
Elliptic coordinates	162
Projections of curves on ellipsoid, on planes of circular section	163
Ivory's theorem as to the distance of two corresponding points	164
Jacobi's analogue to the plane theorem that the sum of focal distances is constant	164
Locus of points of contact of parallel planes touching a series of confocals	166
CURVATURE OF QUADRICS	167
Radii of curvature of a normal and of an oblique section	168
Line of curvature defined	170
Construction for principal centres of curvature	170
Surface of centres; its sections by principal planes	171
Equation of its reciprocal	172

CHAPTER IX.

INVARIANTS AND COVARIANTS OF SYSTEMS OF QUADRICS.

Fundamental invariants of a system of two quadrics	173
Condition that a tetrahedron can be inscribed in one quadric, and self-conjugate with regard to another	175
Hesse's theorem as to vertices of two self-conjugate tetrahedra	175
Faure's property of spheres circumscribing self-conjugate tetrahedra	175
Condition that two quadrics should touch	175
Equation of surface parallel to a quadric	176
Point of contact of two surfaces, a double point on their curve of intersection	177
Stationary contact defined	178
Equation of surface of centres formed	179
Condition that a tetrahedron can be inscribed in one quadric having two pairs of opposite edges on another	180
Equation of quadric touching four planes	181
Invariants of a cone and a quadric	182
Two kinds of equilateral hyperboloids	183
Orthogonal hyperboloids	183
Tangential equation of imaginary circle at infinity	184
Two planes at right angles conjugate with regard to imaginary circle	184
Tangential equation of curve in space	184
How to form reciprocal of tangential equation of a conic	185
Equation of cone touching a quadric along a given plane section	185
Contravariants of a system of two quadrics	186
Two principal covariant quadrics of a system of two quadrics	187
Equation of developable circumscribing two quadrics	188

CONTENTS.

xiii

	PAGE
Its sections by the principal planes	189
Complex of lines meeting curve of intersection of two quadrics	190
Condition that a line should be cut harmonically by two quadrics	190
Equation of developable generated by intersection of two quadrics	190
Intersection of this developable with either quadric	191
Coordinates of a tangent to the common curve expressed by a parameter	194
Coordinates of point on curve and of osculating plane how expressed	195
A system of confocals is touched by a common developable	195
Locus of points whence three rectangular lines or planes can be drawn to a quadric	196
Two quadrics having a common curve can be described to touch a line, and three to touch a plane	197
Properties of confocals deduced from those of a system inscribed in a common developable	197
Method of finding equations of focal conics of quadric given by general equation	198
Quadriplanar equation of system of confocals	199
Theorems respecting perpendiculars, how generalized	200
Tangential equation of sphere inscribed in a tetrahedron	201
Equation of circumscribing sphere	201
Conditions that quadriplanar equation should represent a sphere	202
Condition that a plane section should be a parabola or equilateral hyperbola	202
Coordinates of foci of a plane section	203
Locus of foci of central section of a given quadric	203
Jacobian of a system of four quadrics	205
Locus of vertices of cones which pass through six given points	205
Jacobian of four spheres	206
Reduction of two quadrics to their canonical form	206
Invariants of a system of three quadrics	208
Condition for three quadrics to be each the sum of five squares same as for each to be polar quadric of a point with regard to a cubic	210
Tact-invariants	211
Discriminants of discriminants	212
Jacobian curve of three quadrics	213
Complex of lines cut in involution by three quadrics	214

CHAPTER X.

CONES AND SPHERO-CONICS.

A cone may have sheets of two kinds	215
Spherical coordinates	216
Cyclic arcs of sphero-conics analogous to asymptotes	220
Sum of focal distances constant	222
Focus and directrix property of sphero-conics	223
Any generator of hyperboloid makes with planes of circular section angles the product of whose sines is constant	223
Difference of squares of reciprocals of axes of central section of a quadric, proportional to product of sines of angles it makes with cyclic planes	225
Locus of intersection of rectangular tangents to a sphero-conic	225
Equation in spherical coordinates of imaginary circle at infinity	227
Equation of sphere inscribed in a tetrahedron	227
Equation of a right cone	227
Investigation of Hart's extension of Feuerbach's theorem	229

CHAPTER XI.

GENERAL THEORY OF SURFACES.

	PAGE
Number of terms in general equation	233
Section of surface by tangent plane has point of contact for a double point .	234
A surface in general has triple tangent planes	235
Inflexional tangents defined	236
The indicatrix ; elliptic, hyperbolic, and parabolic points	236
Asymptotic curves on a surface	238
Conjugate tangents	239
Tangent plane at a parabolic point is a double tangent plane	240
Double or conical points on a surface	240
Reciprocal of a conical point	241
Application of Joachimsthal's method	242
Number of double tangent lines which can be drawn through a point on the surface	244
Formation of equation of tangent cone to a surface	245
Number of inflexional tangents which can be drawn through any point	245
Number of double tangents through any point	246
Characteristics of tangent cone	247
Polar properties of surfaces in general	247
Degree of reciprocal surface	248
Discriminant of a surface	249
Polar quadric of a parabolic point is a cone	249
Hessian of a surface	250
Number of stationary tangent planes which pass through a point	250
Every right line on a surface touches the Hessian	251
CURVATURE OF SURFACES	252
Radius of curvature of normal section	253
Euler's formula	254
Meunier's theorem	256
Two spheres have stationary contact with a surface	257
Values of principal radii at any point	258
Locus of points where radii are equal and opposite	258
Equation determining directions of principal sections	260
Conditions for an umbilic	261
Lines of spherical curvature	262
Number of umbilics on a surface of the n^{th} order	263
Stationary contact implies contact at two points	264
Determination of normals which meet a consecutive normal	264
Bertrand's theory of curvature	265
Special case of the umbilic considered	266
Lines of curvature	266
Of surfaces of revolution	267
Their differential equation	268
Lines of curvature of ellipsoid	269
Dupin's theorem	269
If two surfaces cut at right angles, their intersection, if a line of curvature on one, is so on the other	270
Locus of centres along a line of curvature is a cuspidal edge on surface of normals	271
Properties of surface of centres	271
In what cases it can have a double line	272
Geodesic line defined	273

CONTENTS.

XV

	PAGE
Its osculating plane normal to the surface	273
This property derived from Meunier's theorem	274
Curve on centro-surface answering to line of curvature is a geodesic	275
If a line of curvature be plane, it makes constant angle with tangent plane	276
Lancret's theorem of variation of angle between tangent plane and osculating plane of line of curvature	277
A geodesic line of curvature must be plane	277

CHAPTER XII.

CURVES AND DEVELOPABLES.

SEC. I. PROJECTIVE PROPERTIES	279
Different modes of representing a curve in space	281
Direction-cosines of tangent to a curve	283
Theory of developables explained	284
Envelope of a plane whose equation contains one parameter	286
Tangent planes to developables touch along a line	289
Characteristics	290
Cuspidal edge of a developable	290
Stationary points and planes	291
Cayley's equations connecting singularities of a curve in space	291
Developable generated by tangents is of same degree as reciprocal developable	294
Special singularities	295
Double or nodal curve on developable	297
Table of singularities	298
SEC. II. CLASSIFICATION OF CURVES	299
A twisted cubic can be described through six points	301
Projection of a twisted cubic has a double point	302
Properties of twisted cubics	303
Their different species	306
Singularities of curve of intersection of two surfaces	308
Number of apparent double points of intersection	309
Case of surfaces which touch	310
Equations connecting singularities of curves which together make up intersection of two surfaces	311
Two distinct families of quartics	312
Four quartics of second family through eight points	316
Special case of second family	316
Twisted Cartesians	317
Classification of quintics	318
Planar and multiplanar developables	318
Deficiency of a curve in space	319
Common curve on three surfaces equivalent to how many points of intersection	321
Singularities of a double curve connected with those of its complementary	322
SEC. III. NON-PROJECTIVE PROPERTIES OF CURVES	323
Direction-cosines of normal plane	324
Equation of osculating plane	324
The helix	325
Equation of osculating plane of intersection of two surfaces	327
Condition that four consecutive points may lie in a plane	329
Radius of absolute and of spherical curvature	331

	PAGE
Expressions for angle of contact	332
Radius of curvature of intersection of two surfaces	333
Expression for angle of torsion	334
Osculating right cone	335
Rectifying developable	336
Rectifying surface is surface of centres of original developable	337
Angle between two successive radii of curvature	337
Cuspidal edge of polar developable is locus of centres of spherical curvature	339
Every curve has an infinity of evolutes	339
These are geodesics on the polar developable	340
Characteristics of polar developable	340
Radius of sphere through four consecutive points	341
Coordinates of its centre	341
History of theory of non-plane curves	342
SEC. IV. CURVES TRACED ON SURFACES	343
Gauss's method of representing the position of a point on a surface	343
Equations of lines of curvature, &c., in Gauss's notation	344
Differential equation satisfied by coordinates, when $p = \text{const.}$, $q = \text{const.}$, denote lines of curvature	349
Gauss's measure of curvature of a surface	350
It varies inversely as product of two principal radii	351
Measure of curvature unaltered by deformation	355
Total curvature of geodesic triangle on any surface	356
Differential equation of a geodesic	358
Line joining extremities of indefinitely near and equal geodesics cuts them at right angles	358
Radius of geodesic curvature	360
pD constant for a geodesic on a quadric	361
Value of the constant the same for all geodesics through an umbilic	364
Mr. M. Roberts's deductions from this theorem	365
Liouville's transformation of equation $pD = \text{constant}$	366
Chasles's proofs of this theorem	368
„ „ and extensions of it	369
Elliptic coordinates	370
Area of surface of ellipsoid	371
Second integral of equation of geodesic	372
Length of geodesic	373
Geodesic polar coordinates	373
Dr. Hart's proof of Mr. Roberts's expressions	376
Umbilical geodesics do not return on themselves	378
Lines of level	380
Lines of greatest slope	381

CHAPTER XIII.

FAMILIES OF SURFACES.

SEC. I. PARTIAL DIFFERENTIAL EQUATIONS	383
Equations involving a single arbitrary function	384
Cylindrical surfaces	386
Conical surfaces	387
Conoidal surfaces	389

CONTENTS.

xvii

	PAGE
Surfaces of revolution	390
Order of differential equation of a family involving n functions	393
Surfaces generated by lines parallel to a fixed plane	396
Or by lines which meet a fixed axis	398
Differential equation of ruled surfaces	400
Theory of envelopes	401
Determination of arbitrary functions	403
Partial differential equation of developables	407
Their Pro-Hessian	408
Nature of its intersection with the developable	408
Tubular surfaces	409
Differential equation of characteristics	410
Of cuspidal edge of enveloping developable	413
Differential equation of geodesic on a cone	413
SEC. II. COMPLEXES, CONGRUENCIES, RULED SURFACES	416
Complexes	418
Congruencies	419
Lines of a congruency in general bitangents to a surface	420
Tangent plane at any point on a ruled surface, how constructed	422
Normals along a generator generate paraboloid	423
Lines of striction	424
Nature of contact along any generator	425
Double curves generally exist on ruled surfaces	428
Surfaces generated by a line resting on three fixed directors	429
Surfaces generated by a line which meets a curve twice and another curve once	431
„ by a line which meets a curve three times	432
Order of condition that three surfaces should have a line in common	433
SEC. III. ORTHOGONAL SURFACES	436
Differential equation of a system of orthogonal surfaces	441, 443
Bouquet's special case of the differential equation	449
Systems of orthogonal surfaces by Serret, Darboux, and Roberts	450

CHAPTER XIV.

SURFACES DERIVED FROM QUADRICS.

WAVE SURFACE	453
Its sections by principal planes	454
Apsidal surfaces	455
Polar reciprocal of apsidal same as apsidal of reciprocal	456
Degree of reciprocal of wave surface	457
Geometrical investigation of planes which touch along circles	458
Equation in elliptic coordinates	460
Expression for angle between tangent plane and radius vector	463
Construction for tangent plane at any point	463
Lines of curvature of wave surface	464
SURFACE OF CENTRES OF QUADRIC	465
Its sections by principal planes	467
Its cuspidal curves	469
Its nodal curves	470
Characteristics of centro-surface in general	471
Its class	472

	PAGE
Its order	473
Relation between class and order of a congruency, and of its focal surface	473
Normopolar surface of quadric, synnormals	475
Characteristics of parallel surfaces	475
Theory of derived pedal surfaces	478
Properties of inverse surfaces	479
Order and class of inverse surfaces, and of pedals	481
Application of inversion to the obtaining of focal properties	481
Lines of curvature of surface of elasticity	481
First negative pedal of a quadric	482
Problem of finding negative pedals identical with that of finding parallel surfaces	483

CHAPTER XV.

SURFACES OF THE THIRD DEGREE.

Cubics having double lines	486
Cubics having double points	488
Analysis of various kinds of double points	488
Torsal and oscular lines	489
Twenty-three possible kinds of cubics	490
Cubics whose tangent cones from points on surface break up into two of second degree	491
Steiner's quartic	491
Characteristics of surface the equation of whose tangent plane is an algebraic function of two parameters	491
Sylvester's canonical form for equation of cubic	492
Steinerians	493
Corresponding points on the Hessian	493
Relation of the five planes to the Hessian	494
Polar cubic of a plane	495
These all touch the Hessian	495
Right lines on cubics	496
Number of triple tangent planes	498
Schläfli's scheme for the twenty-seven lines	499
Analysis of species of cubics	501
Section by tangent plane, how met by polar plane with regard to Hessian	502
INVARIANTS AND COVARIANTS OF CUBICS	503
Method of obtaining contravariants in five letters	504
Five fundamental invariants	508
Equation of surface which determines twenty-seven right lines	510

CHAPTER XVI.

SURFACES OF THE FOURTH ORDER.

Quartics with triple lines	512
Their reciprocals	514
Quartic scrolls with double lines	516
Pinch points	519
Quartics with nodal lines ordinarily contain right lines	522
Different kinds of nodal lines	523
Plücker's "complex" quartic	524

CONTENTS.

xix

	PAGE
Quartics with nodal conic	526
Sixteen lines on the surface	527
Cyclides	527
Generated as envelope of spheres	528
Their focal curves	529
Their five-fold generation	530
Identical relation between equations of five mutually orthogonal spheres	531
Confocal cyclides cut each other orthogonally	533
Sphero-quartics	535
Cartesians	535
Dupin's cyclide	535
Nodal quartics	537
The symmetroid	540
The 16-nodal quartic	541
The wave surface, a case of the above	542

CHAPTER XVII.

GENERAL THEORY OF SURFACES.

Jacobian of four surfaces	544
Degree of tact-invariant of three surfaces	545
Degree of condition that two surfaces may touch	546
Order of developable enveloping a surface along a given curve	547
Of developable generated by a line meeting two given curves	547
On the properties of systems of surfaces	547
Principle of correspondence	549
Unicursal surfaces	553
Correspondence between points of surface and of plane	555
Expression for deficiency of a surface	557
CONTACT OF LINES WITH SURFACES	558
Locus of points of contact of flecnodal tangents	559
Clebsch's calculation of surface S	560
Locus of points of contact of triple tangents	569
Number of points at which two tangents are biflecnodal	572
Number of points at which lines can be drawn to meet in five consecutive points	574
CONTACT OF PLANES WITH SURFACES	576
Locus of points of contact of double tangent planes	579
THEORY OF RECIPROCAL SURFACES	580
Number of triple tangent planes to a surface	584
Effect of multiple lines on degree of reciprocal	587
Application to developables of theory of reciprocals	588
Singularities of developable generated by a line resting twice on a given curve	590
Application to ruled surfaces	590
Hessian of ruled surface where meets the surface	591
PROF. CAYLEY'S ADDITION ON THE THEORY OF RECIPROCAL SURFACES	592

ERRATA, &C.

PAGE

- 7, note, line 6, for "a," read "α."
 8, line 7, supply "= 0."
 62, lines 12, 13, read " dw_1, dw_2 ," as last terms of the equations.
 90, line 6 from bottom, and 91 line 8 from bottom read "parallelepiped."
 122, ,, 5, supply "= 0."
 136, note, line 3, read "M. Amiot (see *Liouville*, VIII. p. 161, and X. p. 109)."
 214, last line but one, read "are," for "is."
 251, to last line, Art. 286, add "see Art. 607."
 273, last line, read "normal," second note, end of line 2 add "of."
 276, line 9 from bottom, for "radius," read "axis."
 297, ,, 6, read " $+(k-2)dt^{k-3}+$," line 6 from bottom, add "see p. 588."
 319, Art. 354, line 2, for "(p. 298)" read "(p. 297)."
 329, first line, Art. 363, read "four consecutive points."
 356, end of first line, add "see p. 374."
 376, in figure read " $d\phi'$," for " $d\phi_1$."
 382, Ex. 2 the expression for $\frac{z}{c}$ is $\frac{1-\lambda\mu}{\lambda+\mu}$.
 407, line 2 from bottom insert "Art 285."
 444, ,, 10 ,, ,, read "condition."
 476, ,, 3 ,, ,, "l. c."
 568, ,, 1 and 8 read "Article 588," for "577."

Add at end of Chapter IX.

[It ought to have been stated in this Chapter, that Dr. Casey has remarked in the *Annali di Matematica*, that the investigation given, *Conics*, p. 358, is capable of immediate extension to space of three dimensions; that we can thus at once write down an invariant relation between five quadrics whose equations are each of the form $S - L^2 = 0$, and which touch another quadric also inscribed in S , and that hence the equation of the quadric touching four others, all being inscribed in S , is

$$\begin{vmatrix} 0, & (12), & (13), & (14), & \mathcal{J}(S) - L \\ (12), & 0, & (23), & (24), & \mathcal{J}(S) - M \\ (13), & (23), & 0, & (34), & \mathcal{J}(S) - N \\ (14), & (24), & (34), & 0, & \mathcal{J}(S) - P \\ \mathcal{J}(S) - L, & \mathcal{J}(S) - M, & \mathcal{J}(S) - N, & \mathcal{J}(S) - P, & 0 \end{vmatrix} = 0.$$

These formulæ include the invariant condition that five spheres should all touch the same sixth, and the equation of the sphere touching four given spheres.]

ANALYTIC GEOMETRY OF THREE DIMENSIONS.

CHAPTER I.

THE POINT.

1. WE have seen already how the position of a point C in a plane is determined, by referring it to two coordinate axes OX, OY drawn in the plane. To determine the position of any point P in space, we have only to add to our apparatus a third axis OZ not in the plane (see figure next page). Then, if we knew the distance measured parallel to the line OZ of the point P from the plane XOY , and also knew the x and y coordinates of the point C , where PC parallel to OZ meets the plane, it is obvious that the position of P would be completely determined.

Thus, if we were given the three equations $x = a, y = b, z = c$, the first two equations would determine the point C , and then drawing through that point a parallel to OZ , and taking on it a length $PC = c$, we should have the point P .

We have seen already how a change in the sign of a or b affects the position of the point C . In like manner the sign of c will determine on which side of the plane XOY the line PC is to be measured. If we conceive the plane XOY to be horizontal, it is customary to consider lines measured upwards as positive, and lines measured downwards as negative. In this case, then, the z of every point above that plane is counted as positive, and of every point below it as negative. It is obvious that every point on the plane has its $z = 0$.

The angles between the axes may be any whatever; but the axes are said to be rectangular when the lines OX , OY are at right angles to each other, and the line OZ perpendicular to the plane XOY .

2. We have stated the method of representing a point in space, in the manner which seemed most simple for readers already acquainted with Plane Analytic Geometry. We proceed now to state the same more symmetrically. Our apparatus evidently consists

of *three* coordinate axes OX , OY , OZ meeting in a point O , which, as in Plane Geometry, is called the origin. The three axes are called the axes of x , y , z respectively. These three *axes* determine also three coordinate *planes*, namely, the planes YOZ , ZOX , XOY , which we shall call the planes yz , zx , xy , respectively.

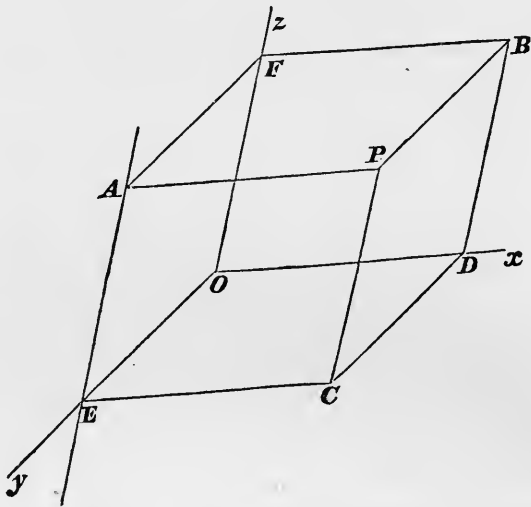

Now since it is plain that $PA = CE = a$, $PB = CD = b$, we may say that the position of any point P is known if we are given its three coordinates; viz. PA drawn parallel to the axis of x to meet the plane yz , PB parallel to the axis of y to meet the plane zx , and PC parallel to the axis of z to meet the plane xy .

Again, since $OD = a$, $OE = b$, $OF = c$, the point given by the equations $x = a$, $y = b$, $z = c$ may be found by the following symmetrical construction: measure on the axis of x , the length $OD = a$, and through D draw the plane $PBCD$ parallel to the plane yz : measure on the axis of y , $OE = b$, and through E draw the plane $PACE$ parallel to zx : measure on the axis of z , $OF = c$, and through F draw the plane $PABF$ parallel to xy : the intersection of the three planes so drawn is the point P , whose construction is required.

3. The points A, B, C , are called the *projections* of the point P on the three coordinate planes; and when the axes are rectangular they are its *orthogonal* projections. In what follows we shall be almost exclusively concerned with orthogonal projections, and therefore when we speak simply of projections, are to be understood to mean orthogonal projections, unless the contrary is stated. There are some properties of orthogonal projections which we shall often have occasion to employ, and which we therefore collect here, though we have given the proof of some of them already. (See *Conics*, Art. 368).

The length of the orthogonal projection of a finite right line on any plane is equal to the line multiplied by the cosine of the angle which it makes with the plane.*

Let $PC, P'C'$ be drawn perpendicular to the plane XOY ; and CC' is the orthogonal projection of the line PP' on that plane. Complete the rectangle by drawing PQ parallel to CC' , and PQ will also be equal to CC' . But $PQ = PP' \cos P'PQ$.

4. *The projection on any plane of any area in another plane is equal to the original area multiplied by the cosine of the angle between the planes.*

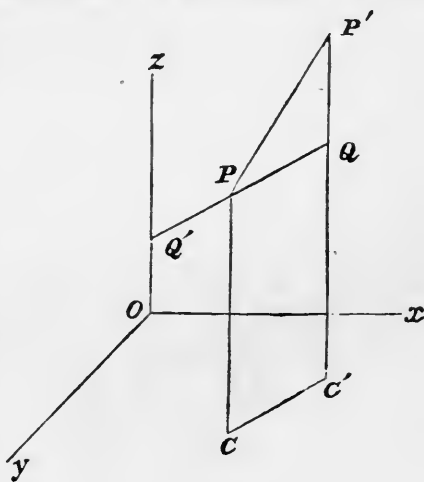

* The angle a line makes with a plane is measured by the angle which the line makes with its orthogonal projection on that plane.

The angle between two planes is measured by the angle between the perpendiculars drawn in each plane to their line of intersection at any point of it. It may also be measured by the angle between the perpendiculars let fall on the planes from any point.

The angle between two lines which do not intersect, is measured by the angle between parallels to both drawn through any point.

When we speak of the angle between two lines, it is desirable to express without ambiguity whether we mean the acute or the obtuse angle which they make with each other. When therefore we speak of the angle between two lines (for instance PP', CC' in the figure), we shall understand that these lines are measured in the *directions* from P to P' and from C to C' , and that PQ parallel to CC' is measured in the same direction. The angle then between the lines is acute. But if we spoke of the

For if ordinates of both figures be drawn perpendicular to the intersection of the two planes, then, by the last article, every ordinate of the projection is equal to the corresponding ordinate of the original figure multiplied by the cosine of the angle between the planes. But it was proved (*Conics*, Art. 394), that when two figures are such that the ordinates corresponding to equal abscissæ have to each other a constant ratio, then the areas of the figures have to each other the same ratio.

5. The projection of a point on any *line* is the point where the line is met by a plane drawn through the point perpendicular to the line. Thus, in figure, p. 2, if the axes be rectangular, D, E, F are the projections of the point P on the three axes.

The projection of a finite right line upon another right line is equal to the first line multiplied by the cosine of the angle between the lines.

Let PP' be the given line, and DD' its projection on OX . Through P draw PQ parallel to OX to meet the plane $P'C'D'$; and since it is perpendicular to this plane, the angle PQP' is right, and $PQ = PP' \cos P'PQ$. But PQ and DD' are equal, since they are the intercepts made by two parallel planes on two parallel right lines.

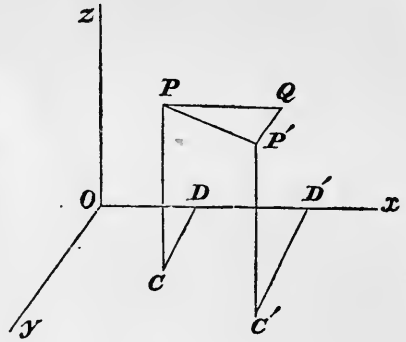

6. *If there be any three points P, P', P'' , the projection of PP'' on any line will be equal to the sum of the projections on that line of PP' and $P'P''$.*

Let the projections of the three points be D, D', D'' , then if D' lie between D and D'' , DD'' is evidently the sum of DD'

angle between PP' and $C'C$, we should draw the parallel PQ' in the opposite direction, and should wish to express the obtuse angle made by the lines with each other.

When we speak of the angles made by any line OP with the axes, we shall always mean the angles between OP and the *positive* directions of the axes, viz. OX, OY, OZ .

and $D'D''$. If D' lie between D and D' , DD'' is the difference of DD' and $D'D''$; but since the direction from D to D'' is the opposite of that from D to D' , DD'' is still the algebraic sum of DD' and $D'D''$. It may be otherwise seen that the projection of $P'P''$ is in the latter case to be taken with a negative sign, from the consideration that in this case the length of the projection is found by multiplying $P'P''$ by the cosine of an *obtuse* angle (see note, Art. 3). In general, if there be any number of points $P, P', P'', P''', \&c.$, the projection of PP'' on any line is equal to the sum of the projections of $PP', P'P'', P''P''', \&c.$ The theorem may also be expressed in the form that the sum of the projections on any line of the sides of a closed polygon = 0.

7. We shall frequently have occasion to make use of the following particular case of the preceding.

If the coordinates of any point P be projected on any line, the sum of the three projections is equal to the projection of the radius vector on that line.

For consider the points O, D, C, P (see figure, p. 2) and the projection of OP must be equal to the sum of the projections of $OD (= x)$, $DC (= y)$, and $CP (= z)$.

8. Having established those principles concerning projections which we shall constantly have occasion to employ, we return now to the more immediate subject of this chapter.

The coordinates of the point P dividing the distance between two points $P' (x'y'z')$, $P'' (x''y''z'')$ so that $P'P : PP'' :: m : l$, are

$$x = \frac{lx' + mx''}{l + m}, \quad y = \frac{ly' + my''}{l + m}, \quad z = \frac{lz' + mz''}{l + m}.$$

The proof is precisely the same as that given at *Conics*, Art. 7, for the corresponding theorem in Plane Analytic Geometry. The lines PM, QN in the figure there given now represent the ordinates drawn from the two points to any one of the coordinate planes.

If we consider the ratio $l : m$ as indeterminate, we have the coordinates of *any* point on the line joining the two given points.

9. Any side of a triangle $P'''P''$ is cut in the ratio $m : n$, and the line joining this point to the opposite vertex P' is cut in the ratio $m + n : l$, to find the coordinates of the point of section.

Ans.

$$x = \frac{lx' + mx'' + nx'''}{l + m + n}, \quad y = \frac{ly' + my'' + ny'''}{l + m + n}, \quad z = \frac{lz' + mz'' + nz'''}{l + m + n}.$$

This is proved as in Plane Analytic Geometry (see *Conics*, Art. 7). If we consider l, m, n as indeterminate, we have the coordinates of any point in the plane determined by the three points.

Ex. The lines joining middle points of opposite edges of a tetrahedron meet in a point. The x 's of two such middle points are $\frac{1}{2}(x' + x'')$, $\frac{1}{2}(x''' + x''')$, and the x of the middle point of the line joining them is $\frac{1}{4}(x' + x'' + x''' + x''')$. The other coordinates are found in like manner, and their symmetry shews that this is also a point on the line joining the other middle points. Through this same point will pass the line joining each vertex to the centre of gravity of the opposite triangle. For the x of one of these centres of gravity is $\frac{1}{3}(x' + x'' + x''')$, and if the line joining this to the opposite vertex be cut in the ratio of $3 : 1$, we get the same value as before.

10. To find the distance between two points P, P' , whose rectangular coordinates are $x'y'z', x''y''z''$.

Evidently (see figure, p. 3) $PP'^2 = PQ^2 + QP'^2$. But $QP' = z' - z''$, and $PQ^2 = CC'^2$ is by Plane Analytic Geometry $= (x' - x'')^2 + (y' - y'')^2$. Hence

$$PP'^2 = (x' - x'')^2 + (y' - y'')^2 + (z' - z'')^2.$$

COR. The distance of any point $x'y'z'$ from the origin is given by the equation

$$OP^2 = x'^2 + y'^2 + z'^2.$$

11. The position of a point is sometimes expressed by its radius vector and the angles it makes with three rectangular axes. Let these angles be α, β, γ . Then since the coordinates x, y, z are the projections of the radius vector on the three axes, we have

$$x = \rho \cos \alpha, \quad y = \rho \cos \beta, \quad z = \rho \cos \gamma.$$

And, since $x^2 + y^2 + z^2 = \rho^2$, the three cosines (which are

sometimes called the direction-cosines of the radius vector) are connected by the relation

$$\cos^2\alpha + \cos^2\beta + \cos^2\gamma = 1.*$$

Moreover (compare Art. 7), $x \cos\alpha + y \cos\beta + z \cos\gamma = \rho$.

The position of a point is also sometimes expressed by the following polar coordinates—the radius vector, the angle γ which the radius vector makes with a fixed axis OZ , and the angle $COD(= \phi)$ which OC the projection of the radius vector on a plane perpendicular to OZ (see figure, p. 4) makes with a fixed line OX in that plane. Since then $OC = \rho \sin \gamma$, the formulæ for transforming from rectangular to these polar coordinates are

$$x = \rho \sin \gamma \cos \phi, \quad y = \rho \sin \gamma \sin \phi, \quad z = \rho \cos \gamma.$$

12. *The square of the area of any plane figure is equal to the sum of the squares of its projections on three rectangular planes.*

Let the area be A , and let a perpendicular to its plane make angles α, β, γ with the three axes; then (Art. 4) the projections of this area on the planes yz, zx, xy respectively, are $A \cos\alpha, A \cos\beta, A \cos\gamma$. And the sum of the squares of these three $= A^2$, since $\cos^2\alpha + \cos^2\beta + \cos^2\gamma = 1$.

13. *To express the cosine of the angle θ between two lines OP, OP' in terms of the direction-cosines of these lines.*

We have proved (Art. 10) that

$$PP'^2 = (x - x')^2 + (y - y')^2 + (z - z')^2.$$

* I have followed the usual practice in denoting the position of a line by these angles, but in one point of view there would be an advantage in using instead the complementary angles, namely, the angles which the line makes with the coordinate planes. This appears from the corresponding formulæ for oblique axes which I have not thought it worth while to give in the text, as we shall not have occasion to use them afterwards. Let a, β, γ be the angles which a line makes with the planes yz, zx, xy , and let A, B, C be the angles which the axis of x makes with the plane of yz , of y with the plane of zx , and of z with the plane of xy , then the formulæ which correspond to those in the text are

$$x \sin A = \rho \sin \alpha, \quad y \sin B = \rho \sin \beta, \quad z \sin C = \rho \sin \gamma.$$

These formulæ are proved by the principle of Art. 7. If we project on a line perpendicular to the plane of yz , since the projections of y and of z on this line vanish, the projection of x must be equal to that of the radius vector, and the angles made by x and ρ with this line are the complements of A and α .

But also $PP'^2 = \rho^2 + \rho'^2 - 2\rho\rho' \cos \theta$.

And since $\rho^2 = x^2 + y^2 + z^2$, $\rho'^2 = x'^2 + y'^2 + z'^2$,

we have $\rho\rho' \cos \theta = xx' + yy' + zz'$,

or $\cos \theta = \cos \alpha \cos \alpha' + \cos \beta \cos \beta' + \cos \gamma \cos \gamma'$.

COR. The condition that two lines should be at right angles to each other is

$$\cos \alpha \cos \alpha' + \cos \beta \cos \beta' + \cos \gamma \cos \gamma' = 0$$

14. The following formula is also sometimes useful :

$$\begin{aligned} \sin^2 \theta = & (\cos \beta \cos \gamma' - \cos \gamma \cos \beta')^2 + (\cos \gamma \cos \alpha' - \cos \alpha \cos \gamma')^2 \\ & + (\cos \alpha \cos \beta' - \cos \beta \cos \alpha')^2. \end{aligned}$$

This may be derived from the following elementary theorem for the sum of the squares of three determinants (*Lessons on Higher Algebra*, Art. 26), but which can also be verified at once by actual expansion,

$$\begin{aligned} (bc' - cb')^2 + (ca' - ac')^2 + (ab' - ba')^2 \\ = (a^2 + b^2 + c^2)(a'^2 + b'^2 + c'^2) - (aa' + bb' + cc')^2. \end{aligned}$$

For when $a, b, c; a', b', c'$ are the direction-cosines of two lines, the right-hand side becomes $1 - \cos^2 \theta$.

Ex. To find the perpendicular distance from a point $x'y'z'$ to a line through the origin whose direction-angles are α, β, γ .

Let P be the point $x'y'z'$, OQ the given line, PQ the perpendicular, then it is plain that $PQ = OP \sin POQ$; and using the value just obtained for $\sin POQ$, and remembering that $x' = OP \cos \alpha'$, &c., we have

$$PQ^2 = (y' \cos \gamma - z' \cos \beta)^2 + (z' \cos \alpha - x' \cos \gamma)^2 + (x' \cos \beta - y' \cos \alpha)^2.$$

15. To find the direction-cosines of a line perpendicular to two given lines, and therefore perpendicular to their plane.

Let $\alpha'\beta'\gamma', \alpha''\beta''\gamma''$ be the direction-angles of the given lines, and $\alpha\beta\gamma$ of the required line, then we have to find $\alpha\beta\gamma$ from the three equations

$$\cos \alpha \cos \alpha' + \cos \beta \cos \beta' + \cos \gamma \cos \gamma' = 0,$$

$$\cos \alpha \cos \alpha'' + \cos \beta \cos \beta'' + \cos \gamma \cos \gamma'' = 0,$$

$$\cos^2 \alpha + \cos^2 \beta + \cos^2 \gamma = 1.$$

From the first two equations we can easily derive, by eliminating in turn $\cos\alpha$, $\cos\beta$, $\cos\gamma$,

$$\lambda \cos\alpha = \cos\beta' \cos\gamma'' - \cos\beta'' \cos\gamma',$$

$$\lambda \cos\beta = \cos\gamma' \cos\alpha'' - \cos\gamma'' \cos\alpha',$$

$$\lambda \cos\gamma = \cos\alpha' \cos\beta'' - \cos\alpha'' \cos\beta',$$

where λ is indeterminate; and substituting in the third equation, we get (see Art. 14), if θ be the angle between the two given lines,

$$\lambda^2 = \sin^2\theta.$$

This result may be also obtained as follows: take any two points P, Q , or $x'y'z', x''y''z''$, one on each of the two given lines. Now double the area of the projection on the plane of xy of the triangle POQ , is (see *Conics*, Art. 36) $x'y'' - y'x''$, or $\rho'\rho''(\cos\alpha' \cos\beta'' - \cos\alpha'' \cos\beta')$. But double the area of the triangle is $\rho'\rho'' \sin\theta$, and therefore the projection on the plane of xy is $\rho'\rho'' \sin\theta \cos\gamma$. Hence, as before,

$$\sin\theta \cos\gamma = \cos\alpha' \cos\beta'' - \cos\alpha'' \cos\beta',$$

and in like manner

$$\sin\theta \cos\alpha = \cos\beta' \cos\gamma'' - \cos\beta'' \cos\gamma';$$

$$\sin\theta \cos\beta = \cos\gamma' \cos\alpha'' - \cos\gamma'' \cos\alpha'.$$

TRANSFORMATION OF COORDINATES.

16. *To transform to parallel axes through a new origin, whose coordinates referred to the old axes, are x', y', z' .*

The formulæ of transformation are (as in Plane Geometry)

$$x = X + x', \quad y = Y + y', \quad z = Z + z'.$$

For let a line drawn through the point P parallel to one of the axes (for instance z) meet the old plane of xy in a point C , and the new in a point C' ; then $PC = PC' + C'C$.

But PC is the old z , PC' is the new z ; and since parallel planes make equal intercepts on parallel right lines, $C'C$ must be equal to the line drawn through the new origin O' parallel to the axis of z , to meet the old plane of xy .

17. *To pass from a rectangular system of axes to another system of axes having the same origin.*

Let the angles made by the new axes of x, y, z with the old axes be $\alpha, \beta, \gamma; \alpha', \beta', \gamma'; \alpha'', \beta'', \gamma''$ respectively. Then if we project the new coordinates on one of the old axes, the sum of the three projections will (Art. 7) be equal to the projection of the radius vector, which is the corresponding old coordinate. Thus we get the three equations

$$\left. \begin{aligned} x &= X \cos \alpha + Y \cos \alpha' + Z \cos \alpha'' \\ y &= X \cos \beta + Y \cos \beta' + Z \cos \beta'' \\ z &= X \cos \gamma + Y \cos \gamma' + Z \cos \gamma'' \end{aligned} \right\} \dots\dots\dots(A).$$

We have, of course, (Art. 11)

$$\left. \begin{aligned} \cos^2 \alpha + \cos^2 \beta + \cos^2 \gamma &= 1, \quad \cos^2 \alpha' + \cos^2 \beta' + \cos^2 \gamma' = 1, \\ \cos^2 \alpha'' + \cos^2 \beta'' + \cos^2 \gamma'' &= 1 \dots\dots\dots(B). \end{aligned} \right\}$$

Let λ, μ, ν be the angles between the new axes of y and z , of z and x , of x and y respectively, then (Art. 13)

$$\left. \begin{aligned} \cos \lambda &= \cos \alpha' \cos \alpha'' + \cos \beta' \cos \beta'' + \cos \gamma' \cos \gamma'' \\ \cos \mu &= \cos \alpha'' \cos \alpha + \cos \beta'' \cos \beta + \cos \gamma'' \cos \gamma \\ \cos \nu &= \cos \alpha \cos \alpha' + \cos \beta \cos \beta' + \cos \gamma \cos \gamma' \end{aligned} \right\} \dots(C).$$

18. If the new axes be also rectangular, we have therefore

$$\left. \begin{aligned} \cos \alpha' \cos \alpha'' + \cos \beta' \cos \beta'' + \cos \gamma' \cos \gamma'' &= 0 \\ \cos \alpha'' \cos \alpha + \cos \beta'' \cos \beta + \cos \gamma'' \cos \gamma &= 0 \\ \cos \alpha \cos \alpha' + \cos \beta \cos \beta' + \cos \gamma \cos \gamma' &= 0 \end{aligned} \right\} \dots(D).$$

When the new axes are rectangular, since $\alpha, \alpha', \alpha''$ are the angles made by the old axis of x with the new axes, &c. we must have

$$\left. \begin{aligned} \cos^2 \alpha + \cos^2 \alpha' + \cos^2 \alpha'' &= 1, \quad \cos^2 \beta + \cos^2 \beta' + \cos^2 \beta'' = 1, \\ \cos^2 \gamma + \cos^2 \gamma' + \cos^2 \gamma'' &= 1 \dots\dots\dots(E), \end{aligned} \right\}$$

$$\left. \begin{aligned} \cos \beta \cos \gamma + \cos \beta' \cos \gamma' + \cos \beta'' \cos \gamma'' &= 0 \\ \cos \gamma \cos \alpha + \cos \gamma' \cos \alpha' + \cos \gamma'' \cos \alpha'' &= 0 \\ \cos \alpha \cos \beta + \cos \alpha' \cos \beta' + \cos \alpha'' \cos \beta'' &= 0 \end{aligned} \right\} \dots(F),$$

and the new coordinates expressed in terms of the old are

$$\left. \begin{aligned} X &= x \cos \alpha + y \cos \beta + z \cos \gamma \\ Y &= x \cos \alpha' + y \cos \beta' + z \cos \gamma' \\ Z &= x \cos \alpha'' + y \cos \beta'' + z \cos \gamma'' \end{aligned} \right\} \dots\dots\dots(G).$$

The two corresponding systems of equations A and G may be briefly expressed by the diagram

	X	Y	Z
x	α	α'	α''
y	β	β'	β''
z	γ	γ'	γ''

It is not difficult to derive analytically equations E, F, G , from equations A, B, D , but we shall not spend time on what is geometrically evident.

19. If we square and add equations (A) (Art. 17), attending to equations (C), we find

$$x^2 + y^2 + z^2 = X^2 + Y^2 + Z^2 + 2YZ \cos \lambda + 2ZX \cos \mu + 2XY \cos \nu.$$

Thus we obtain the radius vector from the origin to any point expressed in terms of the oblique coordinates of that point. It is proved in like manner that the square of the distance between two points, the axes being oblique, is

$$(x' - x'')^2 + (y' - y'')^2 + (z' - z'')^2 + 2(y' - y'')(z' - z'') \cos \lambda + 2(z' - z'')(x' - x'') \cos \mu + 2(x' - x'')(y' - y'') \cos \nu.*$$

20. *The degree of any equation between the coordinates is not altered by transformation of coordinates.*

This is proved, as at *Conics*, Art. 11, from the consideration that the expressions given (Arts. 16, 17) for x, y, z , only involve the new coordinates *in the first degree*.

* As we rarely require in practice the formulæ for transforming from one set of oblique axes to another, we only give them in a note.

Let A, B, C have the same meaning as at note, p. 7, and let $\alpha, \beta, \gamma; \alpha', \beta', \gamma'; \alpha'', \beta'', \gamma''$ be the angles made by the new axes with the old coordinate *planes*; then by projecting on lines perpendicular to the old coordinate planes, as in the note referred to, we find

$$\begin{aligned} x \sin A &= X \sin \alpha + Y \sin \alpha' + Z \sin \alpha'', \\ y \sin B &= X \sin \beta + Y \sin \beta' + Z \sin \beta'', \\ z \sin C &= X \sin \gamma + Y \sin \gamma' + Z \sin \gamma''. \end{aligned}$$

CHAPTER II.

INTERPRETATION OF EQUATIONS.

21. IT appears from the construction of Art. 1 that if we were given merely the two equations $x=a$, $y=b$, and if the z were left indeterminate, the two given equations would determine the point C , and we should know that the point P lay *somewhere* on the line PC . These two equations then are considered as representing that right line, it being the locus of all points whose $x=a$, and whose $y=b$. We learn then that any two equations of the form $x=a$, $y=b$ represent a right line parallel to the axis of z . In particular, the equations $x=0$, $y=0$ represent the axis of z itself. Similarly for the other axes.

Again, if we were given the single equation $x=a$, we could determine nothing but the point D . Proceeding, as at the end of Art. 2, we should learn that the point P lay *somewhere* in the plane $PBCD$, but its position in that plane would be indeterminate. This plane then being the locus of all points whose $x=a$, is represented analytically by that equation. We learn then that any equation of the form $x=a$ represents a plane parallel to the plane yz . In particular, the equation $x=0$ denotes the plane yz itself. Similarly, for the other two coordinate planes.

22. In general, *any single equation between the coordinates represents a surface of some kind; any two simultaneous equations between them represent a line of some kind, either straight or curved; and any three equations denote one or more points.*

I. If we are given a *single* equation, we may take for x and y any arbitrary values; and then the given equation solved for z will determine one or more corresponding values of z . In other words, if we take arbitrarily any point C in the plane of xy , we can always find on the line PC one or

more points whose coordinates will satisfy the given equation. The assemblage then of points so found on the lines PC will form a surface which will be the geometrical representation of the given equation (see *Conics*, Art. 16).

II. When we are given *two* equations, we can, by eliminating z and y alternately between them, throw them into the form $y = \phi(x)$, $z = \psi(x)$. If then we take for x any arbitrary value, the given equations will determine corresponding values for y and z . In other words, we can no longer take the point C *anywhere* on the plane of xy , but this point is limited to a certain locus represented by the equation $y = \phi(x)$. Taking the point C anywhere on this locus, we determine as before on the line PC a number of points P , the assemblage of which is the locus represented by the two equations. And since the points C , which are the projections of these latter points, lie on a certain line, straight or curved, it is plain that the points P must also lie on a line of some kind, though of course they do not necessarily lie all in any one plane.

Otherwise thus: when two equations are given, we have seen in the first part of this article that the locus of points whose coordinates satisfy either equation separately is a surface. Consequently, the locus of points whose coordinates satisfy *both* equations is the assemblage of points common to the two surfaces which are represented by the two equations considered separately: that is to say, the locus is the line of intersection of these surfaces.

III. When *three* equations are given, it is plain that they are sufficient to determine absolutely the values of the three unknown quantities x , y , z , and therefore that the given equations represent one or more *points*. Since each equation taken separately represents a surface, it follows hence that any three surfaces have one or more common points of intersection, real or imaginary.

23. Surfaces, like plane curves, are classed according to the degrees of the equations which represent them. Since every point in the plane of xy has its $z = 0$, if in any equation

we make $z=0$, we get the relation between the x and y coordinates of the points in which the plane xy meets the surface represented by the equation: that is to say, we get the equation of the plane curve of section, and it is obvious that the equation of this curve will be in general of the same degree as the equation of the surface. It is evident, in fact, that the degree of the equation of the section cannot be *greater* than that of the surface, but it appears at first as if it might be *less*. For instance, the equation

$$zx^2 + ay^2 + b^2x = c^3$$

is of the third degree; but when we make $z=0$, we get an equation of the second degree. But since the original equation would have been unmeaning if it were not homogeneous, every term must be of the third dimension in some linear unit (see *Conics*, Art. 69), and therefore when we make $z=0$, the remaining terms must still be regarded as of three dimensions. They will form an equation of the second degree multiplied by a constant, and denote (see *Conics*, Art. 67) a conic and a line at infinity. If then we take into account lines at infinity, we may say that the section of a surface of the order n by the plane of xy will be *always* of the order n ; and since any plane may be made the plane of xy , and since transformation of coordinates does not alter the degree of an equation, we learn that *every plane section of a surface of the order n is a curve of the order n* .

In like manner it is proved that *every right line meets a surface of the order n in n points*. The right line may be made the axis of z , and the points where it meets the surface are found by making $x=0$, $y=0$ in the equation of the surface, when in general we get an equation of the degree n to determine z . If the degree of the equation happened to be less than n , it would only indicate that some of the n points where the line meets the surface are at infinity (*Conics*, Art. 135).

24. *Curves in space* are classified according to the number of points in which they are met by any plane. *Two equations of the degrees m and n respectively represent a curve of the order mn* . For the surfaces represented by the equations

are cut by any plane in curves of the orders m and n respectively, and these curves intersect in mn points.

Conversely, if the degree of a curve be decomposed in any manner into the factors m, n , then the curve *may be* the intersection of two surfaces of the degrees m, n respectively; and it is in this case said to be a complete intersection. But not every curve is a complete intersection: in particular we have curves, the degree of which is a prime number, which are not plane curves.

Three equations of the degrees m, n , and p respectively, denote mnp points.

This follows from the theory of elimination, since if we eliminate y and z between the equations, we obtain an equation of the degree mnp to determine x (see *Lessons on Higher Algebra*, Arts. 73, 78). This proves also that *three surfaces of the orders m, n, p respectively intersect in mnp points.*

25. If an equation only contain two of the variables $\phi(x, y) = 0$, the learner might at first suppose that it represents a curve in the plane of xy , and so that it forms an exception to the rule that it requires *two* equations to represent a curve. But it must be remembered that the equation $\phi(x, y) = 0$ will be satisfied not only for any point of this curve in the plane of xy , but also for any other point having the same x and y though a different z ; that is to say, for any point of the surface generated by a right line moving along this curve, but remaining parallel to the axis of z .* The curve in the plane of xy can only be represented by *two* equations, namely, $z = 0, \phi(x, y) = 0$.

If an equation contain only *one* of the variables, x , we know by the theory of equations that it may be resolved into n factors of the form $x - a = 0$, and therefore (Art. 21) that it represents n planes parallel to one of the coordinate planes.

* A surface generated by a right line moving parallel to itself is called a *cylindrical surface*.

CHAPTER III.

THE PLANE AND THE RIGHT LINE.

26. IN the discussion of equations we commence of course with equations of the first degree, and the first step is to prove that *every equation of the first degree represents a plane*, and conversely, that *the equation of a plane is always of the first degree*. We commence with the latter proposition, which may be established in two or three different ways.

In the first place we have seen (Art. 21) that the plane of xy is represented by an equation of the first degree, viz. $z=0$; and transformation to any other axes cannot alter the *degree* of this equation (Art. 20).

We might arrive at the same result by forming the equation of the plane determined by three given points, which we can do by eliminating l, m, n from the three equations given Art. 9, when we should arrive at an equation of the first degree. The following method, however, of expressing the equation of a plane leads to one of the forms most useful in practice.

27. *To find the equation of a plane, the perpendicular on which from the origin = p , and makes angles α, β, γ with the axes.*

The length of the projection on the perpendicular of the radius vector to any point of the plane is of course = p , and (Art. 7) this is equal to the sum of the projections on that line of the three coordinates. Hence we obtain for the equation of the plane

$$x \cos \alpha + y \cos \beta + z \cos \gamma = p.*$$

* In what follows we suppose the axes rectangular, but this equation is true whatever be the axes.

28. Now, conversely, any equation of the first degree

$$Ax + By + Cz + D = 0,$$

can be reduced to the form just given, by dividing it by a factor R . We are to have $A = R \cos \alpha$, $B = R \cos \beta$, $C = R \cos \gamma$, whence, by Art. 11, R is determined to be $= \sqrt{(A^2 + B^2 + C^2)}$. Hence any equation $Ax + By + Cz + D = 0$ may be identified with the equation of a plane, the perpendicular on which from the origin $= \frac{-D}{\sqrt{(A^2 + B^2 + C^2)}}$, and makes angles with the axes whose cosines are A , B , C , respectively divided by the same square root. We may give to the square root the sign which will make the perpendicular positive, and then the signs of the cosines will determine whether the angles which the perpendicular makes with the positive directions of the axes are acute or obtuse.

29. To find the angle between two planes.

$$Ax + By + Cz + D = 0, \quad A'x + B'y + C'z + D' = 0.$$

The angle between the planes is the same as the angle between the perpendiculars on them from the origin. By the last article we have the angles these perpendiculars make with the axes, and thence, Arts. 13, 14, we have

$$\cos \theta = \frac{AA' + BB' + CC'}{\sqrt{\{(A^2 + B^2 + C^2)(A'^2 + B'^2 + C'^2)\}}},$$

$$\sin^2 \theta = \frac{(BC' - B'C)^2 + (CA' - C'A)^2 + (AB' - A'B)^2}{(A^2 + B^2 + C^2)(A'^2 + B'^2 + C'^2)}.$$

Hence the condition that the planes should cut at right angles is $AA' + BB' + CC' = 0$.

They will be parallel if we have the conditions

$$BC' = B'C, \quad CA' = C'A, \quad AB' = A'B;$$

in other words, if the coefficients A , B , C be proportional to A' , B' , C' , in which case it is manifest from the last article that the directions of the perpendiculars on both will be the same.

30. To express the equation of a plane in terms of the intercepts a , b , c , which it makes on the axes.

The intercept made on the axis of x by the plane

$$Ax + By + Cz + D = 0$$

is found by making y and z both $= 0$, when we have $Aa + D = 0$. And similarly, $Bb + D = 0$, $Cc + D = 0$. Substituting in the general equation the values just found for A , B , C , it becomes

$$\frac{x}{a} + \frac{y}{b} + \frac{z}{c} = 1.$$

If in the general equation any term be wanting, for instance if $A = 0$, the point where the plane meets the axis of x is at infinity, or the plane is parallel to the axis of x . If we have both $A = 0$, $B = 0$, then the axes of x and y meet at infinity the given plane which is therefore parallel to the plane of xy (see also Art. 21). If we have $A = 0$, $B = 0$, $C = 0$, all three axes meet the plane at infinity, and we see, as at *Conics*, Art. 67, that an equation $0 \cdot x + 0 \cdot y + 0 \cdot z + D = 0$ must be taken to represent a plane at infinity.

31. To find the equation of the plane determined by three points.

Let the equation be $Ax + By + Cz + D = 0$; and since this is to be satisfied by the coordinates of each of the given points, A , B , C , D must satisfy the equations

$$\begin{aligned} Ax' + By' + Cz' + D &= 0, & Ax'' + By'' + Cz'' + D &= 0, \\ Ax''' + By''' + Cz''' + D &= 0. \end{aligned}$$

Eliminating A , B , C , D between the four equations, the result is the determinant

$$\begin{vmatrix} x & y & z & 1 \\ x' & y' & z' & 1 \\ x'' & y'' & z'' & 1 \\ x''' & y''' & z''' & 1 \end{vmatrix} = 0.$$

Expanding this by the common rule, the equation is

$$\begin{aligned} &x \{y'(z'' - z''') + y''(z''' - z') + y'''(z' - z'')\} \\ &+ y \{z'(x'' - x''') + z''(x''' - x') + z'''(x' - x'')\} \\ &+ z \{x'(y'' - y''') + x''(y''' - y') + x'''(y' - y'')\} \\ &= x'(y''z''' - y'''z'') + x''(y'''z' - y'z''') + x'''(y'z'' - y''z'). \end{aligned}$$

If we consider x, y, z as the coordinates of any fourth point, we have the condition that four points should lie in one plane.

32. The coefficients of x, y, z in the preceding equation are evidently double the areas of the projections on the coordinate planes of the triangle formed by the three points.

If now we take the equation (Art. 27)

$$x \cos \alpha + y \cos \beta + z \cos \gamma = p,$$

and multiply it by twice A (A being the area of the triangle formed by the three points), the equation will become identical with that of the last article, since $A \cos \alpha, A \cos \beta, A \cos \gamma$, are the projections of the triangle on the coordinate planes (Art. 4). The absolute term then must be the same in both cases. Hence the quantity

$$x' (y'' z''' - y''' z'') + x'' (y''' z' - y' z''') + x''' (y' z'' - y'' z')$$

represents double the area of the triangle formed by the three points multiplied by the perpendicular on its plane from the origin; or, in other words, *six times the volume of the triangular pyramid, whose base is that triangle, and whose vertex is the origin.**

* If in the preceding values we substitute for $x', y', z'; \rho' \cos \alpha', \rho' \cos \beta', \rho' \cos \gamma'$, &c., we find that six times the volume of this pyramid = $\rho' \rho'' \rho'''$ multiplied by the determinant

$$\begin{vmatrix} \cos \alpha', & \cos \beta', & \cos \gamma' \\ \cos \alpha'', & \cos \beta'', & \cos \gamma'' \\ \cos \alpha''', & \cos \beta''', & \cos \gamma''' \end{vmatrix}.$$

Now let us suppose the three radii vectores cut by a sphere whose radius is unity, having the origin for its centre, and meeting it in a spherical triangle $R'R''R'''$. Then if a denote the side $R'R''$, and p the perpendicular on it from R''' , six times the volume of the pyramid will be $\rho' \rho'' \rho''' \sin a \sin p$; for $\rho' \rho'' \sin a$ is double the area of one face of the pyramid, and $\rho''' \sin p$ is the perpendicular on it from the opposite vertex. It follows then that the determinant above written is equal to double the function

$$\Delta \{ \sin s \sin (s - a) \sin (s - b) \sin (s - c) \}$$

of the sides of the above-mentioned spherical triangle. The same thing may be proved by forming the square of the same determinant according to the ordinary rule; when if we write

$$\cos \alpha'' \cos \alpha''' + \cos \beta'' \cos \beta''' + \cos \gamma'' \cos \gamma''' = \cos a, \text{ \&c.,}$$

We can at once express A itself in terms of the coordinates of the three points by Art. 12, and must have $4A^2$ equal to the sum of the squares of the coefficients of x , y , and z , in the equation of the last article.

33. *To find the length of the perpendicular from a given point $x'y'z'$ on a given plane, $x \cos \alpha + y \cos \beta + z \cos \gamma = p$.*

If we draw through $x'y'z'$ a plane parallel to the given plane, and let fall on the two planes a common perpendicular from the origin, then the intercept on this line will be equal to the length of the perpendicular required, since parallel planes make equal intercepts on parallel lines. But the length of the perpendicular on the plane through $x'y'z'$ is, by definition (Art. 5), the projection on that perpendicular of the radius vector to $x'y'z'$, and therefore (Art. 27) is equal to

$$x' \cos \alpha + y' \cos \beta + z' \cos \gamma.$$

The length required is therefore

$$x' \cos \alpha + y' \cos \beta + z' \cos \gamma - p.$$

N.B. This supposes the perpendicular on the plane through $x'y'z'$ to be greater than p ; or, in other words, that $x'y'z'$ and the origin are on opposite sides of the plane. If they were on the same side, the length of the perpendicular would be $p - (x' \cos \alpha + y' \cos \beta + z' \cos \gamma)$. If the equation of the plane had been given in the form $Ax + By + Cz + D = 0$, it is re-

we get

$$\begin{vmatrix} 1, & \cos c, & \cos b \\ \cos c, & 1, & \cos a \\ \cos b, & \cos a, & 1 \end{vmatrix},$$

which expanded is $1 + 2 \cos a \cos b \cos c - \cos^2 a - \cos^2 b - \cos^2 c$, which is known to have the value in question.

It is useful to remark that when the three lines are at right angles to each other the determinant

$$\begin{vmatrix} \cos \alpha', & \cos \beta', & \cos \gamma' \\ \cos \alpha'', & \cos \beta'', & \cos \gamma'' \\ \cos \alpha''', & \cos \beta''', & \cos \gamma''' \end{vmatrix}$$

has unity for its value. In fact we see, as above, that its square is

$$\begin{vmatrix} 1, & 0, & 0 \\ 0, & 1, & 0 \\ 0, & 0, & 1 \end{vmatrix}.$$

duced, as in Art. 28, to the form here considered, and the length of the perpendicular is found to be

$$\frac{Ax' + By' + Cz' + D}{\sqrt{A^2 + B^2 + C^2}}.$$

It is plain that all points for which $Ax' + By' + Cz' + D$ has the same sign as D , will be on the same side of the plane as the origin; and *vice versa* when the sign is different.

34. *To find the coordinates of the intersection of three planes.*

This is only to solve three equations of the first degree for three unknown quantities (see *Lessons on Higher Algebra*, Art. 29). The values of the coordinates will become infinite if the determinant $(AB'C'')$ vanishes, or

$$A(B'C'' - B''C') + A'(B''C - BC'') + A''(BC' - B'C) = 0.$$

This then is the condition that the three planes should be parallel to the same line. For in such a case the line of intersection of any two would be also parallel to this line, and could not meet the third plane at any finite distance.

35. *To find the condition that four planes should meet in a point.*

This is evidently obtained, by eliminating x, y, z between the equations of the four planes, and is therefore the determinant $(AB'C''D''')$, or

$$\begin{vmatrix} A, & B, & C, & D \\ A', & B', & C', & D' \\ A'', & B'', & C'', & D'' \\ A''', & B''', & C''', & D''' \end{vmatrix} = 0.$$

36. *To find the volume of the tetrahedron whose vertices are any four given points.*

If we multiply the area of the triangle formed by three points, by the perpendicular on their plane from the fourth, we obtain three times the volume. The length of the perpendicular on the plane, whose equation is given (Art. 31), is found by substituting in that equation the coordinates of the fourth point, and dividing by the square root of the sum of the squares of the coefficients of x, y, z . But (Art. 32) that

square root is double the area of the triangle formed by the three points. Hence *six times the volume of the tetrahedron in question is equal to the determinant*

$$\begin{vmatrix} x', & y', & z', & 1 \\ x'', & y'', & z'', & 1 \\ x''', & y''', & z''', & 1 \\ x''', & y''', & z''', & 1 \end{vmatrix} .*$$

37. It is evident, as in Plane Geometry (see *Conics*, Art. 40), that if S, S', S'' represent any three surfaces, then $aS + bS'$, where a and b are any constants, represents a surface passing through the line of intersection of S and S' ; and that $aS + bS' + cS''$ represents a surface passing through the points of intersection of $S, S',$ and S'' . Thus then, if L, M, N denote any three planes, $aL + bM$ denotes a plane passing through the line of intersection of the first two, and $aL + bM + cN$ denotes a plane passing through the point common to all three.† As a particular case of the preceding $aL + b$ denotes a plane parallel to L , and $aL + bM + c$ denotes a plane parallel to the intersection of L and M (see Art. 30).

So again, four planes L, M, N, P will pass through the same point if their equations are connected by an identical relation

$$aL + bM + cN + dP = 0,$$

for then any coordinates which satisfy the first three must satisfy the fourth. Conversely, given any four planes intersecting in a common point, it is easy to obtain such an identical relation. For multiply the first equation by the determinant

* The volume of the tetrahedron formed by four planes, whose equations are given, can be found by forming the coordinates of its angular points, and then substituting in the formula given above. The result is (see *Lessons on Higher Algebra*, Art. 30), that six times the volume is equal to

$$\frac{R^3}{(AB'C'')(A'B''C''')(A''B'''C''')(A'''BC''')}$$

where R is the determinant $(AB'C''D''')$ Art. 35, and the factors in the denominator express the conditions (Art. 34) that any three of the planes should be parallel to the same line.

† German writers distinguish the system of planes having a line common by the name *Büschel* from the system having only one point common, which they call *Bündel*.

($A'B''C'''$), the second by $-(A''B'''C)$, the third by ($A'''BC'$), and the fourth by $-(AB'C'')$, and add, then (*Lessons on Higher Algebra*, Art. 7) the coefficients of x, y, z vanish identically; and the remaining term is the determinant which vanishes (Art. 35), because the planes meet in a point. Their equations are therefore connected by the identical relation

$$L(A'B''C''') - M(A''B'''C) + N(A'''BC') - P(AB'C'') = 0.$$

38. Given any four planes L, M, N, P not meeting in a point, it is easy to see (as at *Conics*, Art. 60) that the equation of any other plane can be thrown into the form

$$aL + bM + cN + dP = 0.$$

And in general the equation of any surface of the degree n can be expressed by a homogeneous equation of the degree n between L, M, N, P (see *Conics*, Art. 289). For the number of terms in the *complete* equation of the degree n between *three* variables is the same as the number of terms in the *homogeneous* equation of the degree n between *four* variables.

Accordingly, in what follows, we shall use these *quadriplanar* coordinates, whenever by so doing our equations can be materially simplified; that is, we shall represent the equation of a surface by a homogeneous equation between four coordinates x, y, z, w ; where these may be considered as denoting the perpendicular distances, or quantities proportional to the perpendicular distances (or to given multiples of the perpendicular distances) of the point from four given planes $x=0, y=0, z=0, w=0$.

It is at once apparent that, as in *Conics*, Art. 70, there is also a second system of interpretation of our equations, in which an equation of the first degree represents a point, and the variables are the coordinates of a plane. In fact, if $L'M'N'P'$ denote the coordinates of a fixed point, the above plane passes through it if $aL' + bM' + cN' + dP' = 0$, and the coordinates of any plane through this point are subject only to this relation. The quantities, a, b, c, d may be considered as denoting the perpendicular distances, or quantities proportional to the perpendicular distances (or to given multiples of the perpendicular distances) of the plane from four given points $a=0, b=0, c=0, d=0$.

Ex. 1. To find the equation of the plane passing through $x'y'z'$, and through the intersection of the planes

$$Ax + By + Cz + D, \quad A'x + B'y + C'z + D' \text{ (see Conics, Art. 40, Ex. 3).}$$

Ans. $(A'x + B'y + C'z + D')(Ax + By + Cz + D) = (Ax' + By' + Cz' + D)(A'x + B'y + C'z + D')$.

Ex. 2. Find the equation of the plane passing through the points ABC , figure, p. 2.

The equations of the line BC are evidently $\frac{x}{a} = 1, \frac{y}{b} + \frac{z}{c} = 1$. Hence obviously the equation of the required plane is $\frac{x}{a} + \frac{y}{b} + \frac{z}{c} = 2$, since this passes through each of the three lines joining the three given points.

Ex. 3. Find the equation of the plane PEF in the same figure.

The equations of the line EF are $x = 0, \frac{y}{b} + \frac{z}{c} = 1$; and forming as above the equation of the plane joining this line to the point abc , we get $\frac{y}{b} + \frac{z}{c} - \frac{x}{a} = 1$.

39. *If four planes which intersect in a right line be met by any plane, the anharmonic ratio of the pencil so formed will be constant.* For we could by transformation of coordinates make the transverse plane the plane of xy , and we should then obtain the equations of the intersections of the four planes with this plane by making $z = 0$ in the equations. The resulting equations will be of the form $aL + M, bL + M, cL + M, dL + M$, whose anharmonic ratio (see *Conics*, Art. 59) depends solely on the constants a, b, c, d ; and does not alter when by transformation of coordinates L and M come to represent different lines.

THE RIGHT LINE.

40. The equations of any two planes taken together will represent their line of intersection, which will include all the points whose coordinates satisfy *both* the equations. By eliminating x and y alternately between the equations we reduce them to a form commonly used, viz.

$$x = mz + a, \quad y = nz + b.$$

The first represents the projection of the line on the plane of xz and the second that on the plane of yz . The reader will observe that *the equations of a right line include four independent constants.*

We might form independently the equations of the line joining two points; for taking the values given (Art. 8) of the

coordinates of any point on that line, solving for the ratio $m : l$ from each of the three equations there given, and equating results, we get

$$\frac{x - x'}{x' - x''} = \frac{y - y'}{y' - y''} = \frac{z - z'}{z' - z''},$$

for the required equations of the line. It thus appears that the equations of the projections of the line are the same as the equations of the lines joining the projections of two points on the line, as is otherwise evident.

41. Two right lines in space will in general not intersect. If the first line be represented by any two equations $L=0$, $M=0$, and the second by any other two $N=0$, $P=0$, then if the two lines meet in a point, each of these four planes must pass through that point, and the condition that the lines should intersect is the same as that already given (Art. 35).

Two intersecting lines determine a plane whose equation can easily be found. For we have seen (Art. 37) that when the four planes intersect, their equations satisfy an identical relation

$$aL + bM + cN + dP = 0.$$

The equations therefore $aL + bM = 0$, and $cN + dP = 0$ must be identical and must represent the same plane. But the form of the first equation shows that this plane passes through the line L, M , and that of the second equation shows that it passes through the line N, P .

Ex. When the given lines are represented by equations of the form

$$x = mz + a, \quad y = nz + b; \quad x = m'z + a', \quad y = n'z + b',$$

the condition that they should intersect is easily found. For solving for z from the first and third equations, and equating it to the value found by solving from the second and fourth, we get

$$\frac{a - a'}{m - m'} = \frac{b - b'}{n - n'}.$$

Again, if this condition is satisfied, the four equations are connected by the identical relation

$$(n - n') \{(x - mz - a) - (x - m'z - a')\} = (m - m') \{(y - nz - b) - (y - n'z - b')\},$$

and therefore $(n - n') (x - mz - a) = (m - m') (y - nz - b)$

is the equation of the plane containing both lines.

42. To find the equations of a line passing through the point $x'y'z'$, and making angles α, β, γ with the axes.

The projections on the axes, of the distance of $x'y'z'$ from any variable point xyz on the line, are respectively $x - x', y - y', z - z'$; and since these are each equal to that distance multiplied by the cosine of the angle between the line and the axis in question, we have

$$\frac{x - x'}{\cos \alpha} = \frac{y - y'}{\cos \beta} = \frac{z - z'}{\cos \gamma};$$

a form of writing the equations of the line which, although it includes two superfluous constants, yet on account of its symmetry between x, y, z is often used in preference to the first form in Art. 40.

Reciprocally, if we desire to find the angles made with the axes by any line, we have only to throw its equation into the form $\frac{x - x'}{A} = \frac{y - y'}{B} = \frac{z - z'}{C}$ when the direction-cosines of the line will be respectively A, B, C , each divided by the square root of the sum of the squares of these three quantities.

Ex. 1. To find the direction-cosines of $x = mz + a, y = nz + b$. Writing the equations in the form $\frac{x - a}{m} = \frac{y - b}{n} = \frac{z}{1}$, the direction-cosines are

$$\frac{m}{\sqrt{(1 + m^2 + n^2)}}, \frac{n}{\sqrt{(1 + m^2 + n^2)}}, \frac{1}{\sqrt{(1 + m^2 + n^2)}}.$$

Ex. 2. To find the direction-cosines of $\frac{x}{l} = \frac{y}{m}, z = 0$. Ans. $\frac{l}{\sqrt{(l^2 + m^2)}}, \frac{m}{\sqrt{(l^2 + m^2)}}, 0$.

Ex. 3. To find the direction-cosines of

$$Ax + By + Cz + D, A'x + B'y + C'z + D'.$$

Eliminating y and z alternately we reduce to the preceding form, and the direction-cosines are $\frac{BC' - B'C}{R}, \frac{CA' - C'A}{R}, \frac{AB' - A'B}{R}$, where R^2 is the sum of the squares of the three numerators.

Ex. 4. To find the equation of the plane through the two intersecting lines

$$\frac{x - x'}{\cos \alpha} = \frac{y - y'}{\cos \beta} = \frac{z - z'}{\cos \gamma}; \quad \frac{x - x'}{\cos \alpha'} = \frac{y - y'}{\cos \beta'} = \frac{z - z'}{\cos \gamma'}.$$

The required plane passes through $x'y'z'$ and its perpendicular is perpendicular to two lines whose direction-cosines are given; therefore (Art. 15), the required equation is

$$(x - x')(\cos \beta \cos \gamma' - \cos \gamma \cos \beta') + (y - y')(\cos \gamma \cos \alpha' - \cos \gamma' \cos \alpha) \\ + (z - z')(\cos \alpha \cos \beta' - \cos \alpha' \cos \beta) = 0.$$

Ex. 5. To find the equation of the plane passing through the two parallel lines

$$\frac{x-x'}{\cos \alpha} = \frac{y-y'}{\cos \beta} = \frac{z-z'}{\cos \gamma}; \quad \frac{x-x''}{\cos \alpha} = \frac{y-y''}{\cos \beta} = \frac{z-z''}{\cos \gamma}.$$

The required plane contains the line joining the given points, whose direction-cosines are proportional to $x'-x''$, $y'-y''$, $z'-z''$; the direction-cosines of the perpendicular to the plane are therefore proportional to

$$(y'-y'') \cos \gamma - (z'-z'') \cos \beta, \quad (z'-z'') \cos \alpha - (x'-x'') \cos \gamma, \\ (x'-x'') \cos \beta - (y'-y'') \cos \alpha.$$

These may therefore be taken as the coefficients of x, y, z , in the required equation, while the absolute term determined by substituting $x'y'z'$ for xyz in the equation is

$$(y'z'' - y''z') \cos \alpha + (z'x'' - z''x') \cos \beta + (x'y'' - x''y') \cos \gamma.$$

43. To find the equations of the perpendicular from $x'y'z'$ on the plane $Ax + By + Cz + D$. The direction-cosines of the perpendicular on the plane (Art. 28) are proportional to A, B, C ; hence the equations required are

$$\frac{x-x'}{A} = \frac{y-y'}{B} = \frac{z-z'}{C}.$$

44. To find the direction-cosines of the bisector of the angle between two given lines.

As we are only concerned with *directions* it is of course sufficient to consider lines through the origin. If we take points $x'y'z'$, $x''y''z''$ one on each line, equidistant from the origin, then the middle point of the line joining these points is evidently a point on the bisector, whose equation therefore is

$$\frac{x}{x'+x''} = \frac{y}{y'+y''} = \frac{z}{z'+z''},$$

and whose direction-cosines are therefore proportional to

$$x' + x'', \quad y' + y'', \quad z' + z'';$$

but since x', y', z' ; x'', y'', z'' are evidently proportional to the direction-cosines of the given lines, the direction-cosines of the bisector are

$$\cos \alpha' + \cos \alpha'', \quad \cos \beta' + \cos \beta'', \quad \cos \gamma' + \cos \gamma'',$$

each divided by the square root of the sum of the squares of these three quantities.

The bisector of the supplemental angle between the lines is got by substituting for the point $x''y''z''$ a point equidistant

from the origin measured in the opposite direction, whose coordinates are $-x''$, $-y''$, $-z''$; and therefore the direction-cosines of this bisector are

$$\cos\alpha' - \cos\alpha'', \quad \cos\beta' - \cos\beta'', \quad \cos\gamma' - \cos\gamma'',$$

each divided by the square root of the sum of the squares of these three quantities. The square roots in question are obviously $\sqrt{2 \pm 2 \cos \delta}$; that is, $2 \cos \frac{1}{2} \delta$ and $2 \sin \frac{1}{2} \delta$, if δ is the angle between the two lines.

N.B. The equation of the *plane* bisecting the angle between two given *planes* is found precisely as at *Conics*, Art. 35, and is $(x \cos \alpha + y \cos \beta + z \cos \gamma - p) = \pm (x \cos \alpha' + y \cos \beta' + z \cos \gamma' - p')$.

45. To find the angle made with each other by two lines

$$\frac{x-a}{l} = \frac{y-b}{m} = \frac{z-c}{n}; \quad \frac{x-a}{l'} = \frac{y-b}{m'} = \frac{z-c}{n'}.$$

Evidently (Arts. 13, 42),

$$\cos \theta = \frac{ll' + mm' + nn'}{\sqrt{(l^2 + m^2 + n^2)} \sqrt{(l'^2 + m'^2 + n'^2)}}.$$

COR. The lines are at right angles to each other if

$$ll' + mm' + nn' = 0.$$

Ex. To find the angle between the lines $\frac{x}{2} = \frac{y}{\sqrt{3}} = \frac{z}{\sqrt{2}}$; $\frac{x}{\sqrt{3}} = y, z = 0$. *Ans.* 30° .

46. To find the angle between the plane $Ax + By + Cz + D$, and the line $\frac{x-a}{l} = \frac{y-b}{m} = \frac{z-c}{n}$.

The angle between the line and the plane is the complement of the angle between the line and the perpendicular on the plane, and we have therefore

$$\sin \theta = \frac{Al + Bm + Cn}{\sqrt{(l^2 + m^2 + n^2)} \sqrt{(A^2 + B^2 + C^2)}}.$$

COR. When $Al + Bm + Cn = 0$, the line is parallel to the plane, for it is then perpendicular to a perpendicular on the plane.

47. To find the conditions that a line $x = mz + a$, $y = nz + b$ should be altogether in a plane $Ax + By + Cz + D$. Substitute for x and y in the equation of the plane, and solve for z , when we have

$$z = - \frac{Aa + Bb + D}{Am + Bn + C},$$

and if both numerator and denominator vanish, the value of z is indeterminate and the line is altogether in the plane. We have just seen that the vanishing of the denominator expresses the condition that the line should be parallel to the plane; while the vanishing of the numerator expresses that one of the points of the line is in the plane, viz. the point ab where the line meets the plane of xy .

In like manner in order to find the conditions that a right line should lie altogether in any surface, we should substitute for x and y in the equation of the surface, and then equate to zero the coefficient of every power of z in the resulting equation. It is plain that the number of conditions thus resulting is one more than the degree of the surface.*

48. To find the equation of the plane drawn through a given line perpendicular to a given plane.

Let the line be given by the equations

$$Ax + By + Cz + D = 0, \quad A'x + B'y + C'z + D' = 0,$$

and let the plane be

$$A''x + B''y + C''z + D'' = 0.$$

Then any plane through the line will be of the form

$$\lambda(Ax + By + Cz + D) + \mu(A'x + B'y + C'z + D') = 0,$$

and, in order that it should be perpendicular to the plane, we must have

$$(\lambda A + \mu A') A'' + (\lambda B + \mu B') B'' + (\lambda C + \mu C') C'' = 0.$$

* Since the equations of a right line contain four constants, a right line can be determined which shall satisfy any four conditions. Hence any surface of the second degree must contain an infinity of right lines, since we have only three conditions to satisfy and have four constants at our disposal. Every surface of the third degree must contain a finite number of right lines, since the number of conditions to be satisfied is equal to the number of disposable constants. A surface of higher degree will not necessarily contain any right line lying altogether in the surface.

This equation determines $\lambda : \mu$, and the equation of the required plane is

$$(A'A'' + B'B'' + C'C'')(Ax + By + Cz + D) \\ = (AA'' + BB'' + CC'')(A'x + B'y + C'z + D').$$

When the equations of the given plane and line are given in the form

$$x \cos \alpha + y \cos \beta + z \cos \gamma = p; \quad \frac{x - x'}{\cos \alpha'} = \frac{y - y'}{\cos \beta'} = \frac{z - z'}{\cos \gamma'};$$

we can otherwise easily determine the equation of the required plane. For it is to contain the given line whose direction-angles are α' , β' , γ' ; and it is also to contain a perpendicular to the given plane whose direction-angles are α , β , γ . Hence (Art. 15) the direction-cosines of a perpendicular to the required plane are proportional to

$$\cos \beta' \cos \gamma - \cos \beta \cos \gamma', \cos \gamma' \cos \alpha - \cos \gamma \cos \alpha', \cos \alpha' \cos \beta - \cos \alpha \cos \beta',$$

and since the required plane is also to pass through $x'y'z'$, its equation is

$$(x - x')(\cos \beta \cos \gamma' - \cos \beta' \cos \gamma) + (y - y')(\cos \gamma \cos \alpha' - \cos \gamma' \cos \alpha) \\ + (z - z')(\cos \alpha \cos \beta' - \cos \alpha' \cos \beta) = 0.$$

49. *Given two lines to find the equation of a plane drawn through either parallel to the other.*

First, let the given lines be the intersections of the planes $L, M; N, P$, whose equations are given in the most general form. Then proceeding exactly as in Art. 37, we obtain the identical relation

$$L(A'B''C''') - M(A''B'''C) + N(A'''BC') - P(AB'C'') = (A'B''C'''D),$$

the right-hand side of the equation being the determinant, whose vanishing expresses that the four planes meet in a point. It is evident then that the equations

$$L(A'B''C''') - M(A''B'''C) = 0, \quad N(A'''BC') - P(AB'C'') = 0$$

represent parallel planes, since they only differ by a constant quantity; but these planes pass each through one of the given lines.

Secondly, let the lines be given by equations of the form

$$\frac{x-x'}{\cos\alpha} = \frac{y-y'}{\cos\beta} = \frac{z-z'}{\cos\gamma}; \quad \frac{x-x''}{\cos\alpha'} = \frac{y-y''}{\cos\beta'} = \frac{z-z''}{\cos\gamma'}.$$

Then since a perpendicular to the sought plane is perpendicular to the direction of each of the given lines, its direction-cosines (Art. 15) are the same as those given in the last example, and the equations of the sought parallel planes are

$$(x-x')(\cos\beta\cos\gamma' - \cos\beta'\cos\gamma) + (y-y')(\cos\gamma\cos\alpha' - \cos\gamma'\cos\alpha) \\ + (z-z')(\cos\alpha\cos\beta' - \cos\alpha'\cos\beta) = 0,$$

$$(x-x'')(\cos\beta\cos\gamma' - \cos\beta'\cos\gamma) + (y-y'')(\cos\gamma\cos\alpha' - \cos\gamma'\cos\alpha) \\ + (z-z'')(\cos\alpha\cos\beta' - \cos\alpha'\cos\beta) = 0.$$

The perpendicular distance between two parallel planes is equal to the difference between the perpendiculars let fall on them from the origin, and is therefore equal to the difference between their absolute terms, divided by the square root of the sum of the squares of the common coefficients of x, y, z . Thus the perpendicular distance between the planes last found is

$$(x'-x'')(\cos\beta\cos\gamma' - \cos\beta'\cos\gamma) + (y'-y'')(\cos\gamma\cos\alpha' - \cos\gamma'\cos\alpha) \\ + (z'-z'')(\cos\alpha\cos\beta' - \cos\alpha'\cos\beta) \text{ divided by } \sin\theta,$$

where θ (see Art. 14) is the angle between the directions of the given lines. It is evident that the perpendicular distance here found is shorter than any other line which can be drawn from any point of the one plane to any point of the other.

50. *To find the equations and the magnitude of the shortest distance between two non-intersecting lines.*

The shortest distance between two lines is a line perpendicular to both, which can be found as follows: Draw through each of the lines, by Art. 48, a plane perpendicular to either of the parallel planes determined by Art. 49; then the intersection of the two planes so drawn will be perpendicular to the parallel planes, and therefore to the given lines which lie in these planes. From the construction it is evident that the line so determined meets both the given lines. Its magnitude is plainly that determined in the last article. Calculating

by Art. 48 the equation of a plane passing through a line whose direction-angles are α, β, γ , and perpendicular to a plane whose direction-cosines are proportional to

$\cos\beta' \cos\gamma - \cos\beta \cos\gamma', \cos\gamma' \cos\alpha - \cos\gamma \cos\alpha', \cos\alpha' \cos\beta - \cos\alpha \cos\beta'$,

we find that the line sought is the intersection of the two planes

$$\begin{aligned} (x - x')(\cos\alpha' - \cos\theta \cos\alpha) + (y - y')(\cos\beta' - \cos\theta \cos\beta) \\ + (z - z')(\cos\gamma' - \cos\theta \cos\gamma) = 0, \\ (x - x'')(\cos\alpha - \cos\theta \cos\alpha') + (y - y'')(\cos\beta - \cos\theta \cos\beta') \\ + (z - z'')(\cos\gamma - \cos\theta \cos\gamma') = 0. \end{aligned}$$

The direction-cosines of the shortest distance must plainly be proportional to

$\cos\beta' \cos\gamma - \cos\beta \cos\gamma', \cos\gamma' \cos\alpha - \cos\gamma \cos\alpha', \cos\alpha' \cos\beta - \cos\alpha \cos\beta'$.

Ex. To find the shortest distance δ between the right line

$$\begin{aligned} x \cos\alpha' + y \cos\beta + z \cos\gamma = p, \\ x \cos\alpha' + y \cos\beta' + z \cos\gamma' = p', \end{aligned}$$

and that joining the points $P'(x', y', z')$ and $P''(x'', y'', z'')$.

Denoting by L, M the perpendiculars from any point xyz on the two given planes and by $L'M', L''M''$ those from the points P', P'' ; $L + \lambda M = 0$ is the equation of any plane passing through the first right line, and $\frac{lx' + mx''}{l + m}$ &c. are the coordinates of any point on the second. Hence, if the point in which this second right line meets $L + \lambda M = 0$ be taken infinitely remote, or having $l + m = 0$, λ can be found so as to determine the plane through the first line parallel to the second. This gives

$$L' + \lambda M' = L'' + \lambda M''.$$

Hence $LM'' - L''M = LM' - L'M$ is the plane through L, M required.

$$\text{Again,} \quad LM'' - L''M = LM' - L'M + L'M'' - L''M'$$

differs from the former only by a constant, therefore is parallel to it, but also this equation is satisfied by the coordinates of the points P' and P'' , therefore it passes through the second line.

Thus by dividing $L'M'' - L''M'$ by the square root of the sum of squares of coefficients of x, y and z in either of these equations, we find the required shortest distance.

The result of reducing this expression can also be arrived at thus: $L'M'$ are the lengths of perpendiculars from P' on the two given planes. They are both contained in a plane through P' at right angles to the right line LM . In like manner $L''M''$ are contained in a parallel plane through P'' . Now considering projections on either of these planes, if ϕ be the angle between the planes L and M , double the area of the triangle subtended by the projection of $P'P''$ at the intersection of L, M multiplied by $\sin\phi = L'M'' - L''M'$. But that double area is evidently the product of the required shortest distance δ between the two given lines by the projection of $P'P''$. Hence, calling θ the angle between the two lines, we see that

$$L'M'' - L''M' = (P'P'') \cdot \delta \cdot \sin\theta \sin\phi.$$

51. When the equations of a right line are written in the form $\frac{x-x'}{l} = \frac{y-y'}{m} = \frac{z-z'}{n}$ to any system of coordinate axes they appear to involve five independent quantities, viz. $x'y'z'$, and the ratios $l : m : n$. But it is easily seen that $x'y'z'$ occur in groups which are not independent, and the total number of independent constants is only four, as we saw in Art. 40. In fact, if we denote respectively by a, b, c the quantities $mz' - ny'$, $nx' - lz'$, $ly' - mx'$, we have at once the relation $la + mb + nc = 0$, and subject to this the equations of the right line are any two of the four equations

$$\begin{aligned} ny - mz + a &= 0, \\ -nx \quad + lz + b &= 0, \\ mx - ly \quad + c &= 0, \\ ax + by + cz &= 0, \end{aligned}$$

for by the above relation the remaining two can in all cases be deduced.

We have now six quantities a, b, c, l, m, n which serve to determine the position of a right line provided the relation $la + mb + nc = 0$ hold, and these we shall call the six coordinates of the right line. If we examine the conditions, as in Art. 47, that this right line may be wholly contained in the plane

$$Ax + By + Cz + D = 0,$$

we find they are any two of the four equations

$$\begin{aligned} Bc - Cb + Dl &= 0, \\ -Ac \quad + Ca + Dm &= 0, \\ Ab - Ba \quad + Dn &= 0, \\ Al + Bm + Cn &= 0, \end{aligned}$$

from which also by the universal relation $al + bm + cn = 0$, the remaining two can in all cases be deduced. It is important to observe that the quantities a, b, c which are the functions $mz - ny, nx - lz, ly - mx$ of the coordinates x, y, z of any point on the right line have the same values for each point on it. We are thus enabled to express in x, y, z coordinates the relation equivalent to any given relation in a, b, c . Again, if

we suppose the x, y, z axes rectangular, so that $l = \cos \alpha$, $m = \cos \beta$, $n = \cos \gamma$, it is easily seen, by Art. 15, that a, b, c are the coordinates of a point on the perpendicular through the origin to the plane passing through the origin and the given line, and at a distance from the origin equal to that of the given line.

Ex. To express by the coordinates of two right lines the shortest distance between them.

The expression found at the close of Art. 49 for the product of the shortest distance δ between two right lines by the sine of the angle θ at which they are inclined may be written

$$\begin{vmatrix} x' - x'', \cos \alpha, \cos \alpha' \\ y' - y'', \cos \beta, \cos \beta' \\ z' - z'', \cos \gamma, \cos \gamma' \end{vmatrix}$$

if we replace $\cos \alpha$, &c., by l , &c., $\cos \alpha'$, &c., by l' , &c. this may be written

$$= \begin{vmatrix} x', l, l' \\ y', m, m' \\ z', n, n' \end{vmatrix} - \begin{vmatrix} x'', l', l'' \\ y'', m', m'' \\ z'', n', n'' \end{vmatrix},$$

in which we see that the coordinates of the points x' , &c. occur only in the groups mentioned above.

Hence in the notation of this article, also omitting reference to sign,

$$\delta \sin \theta = l'a'' + m'b'' + n'c'' + l''a' + m''b' + n''c'.$$

This quantity has been called by Prof. Cayley (*Trans. Cambridge Phil. Soc.*, vol. XI. part ii. 1868) the *moment* of the two lines.

52. Before proceeding to further considerations on the coordinates of a right line we introduce some properties of tetrahedra obtained by various methods, which will be useful in the sequel.

To find the relation between the six lines joining any four points in a plane.

Let a, b, c be the sides of the triangle formed by any three of them ABC , and let d, e, f be the lines joining the fourth point D to these three. Let the angles subtended at D by a, b, c be α, β, γ ; then we have $\cos \alpha = \cos(\beta \pm \gamma)$, whence

$$\cos^2 \alpha + \cos^2 \beta + \cos^2 \gamma - 2 \cos \alpha \cos \beta \cos \gamma = 1.$$

This relation will be true whatever be the position of D , either within or without the triangle ABC . But

$$\cos \alpha = \frac{e^2 + f^2 - a^2}{2ef}, \quad \cos \beta = \frac{f^2 + d^2 - b^2}{2fd}, \quad \cos \gamma = \frac{d^2 + e^2 - c^2}{2de}.$$

Substituting these values and reducing, we find for the required relation

$$a^2(d^2 - e^2)(d^2 - f^2) + b^2(e^2 - f^2)(e^2 - d^2) + c^2(f^2 - d^2)(f^2 - e^2) + a^2d^2(a^2 - b^2 - c^2) + b^2e^2(b^2 - c^2 - a^2) + c^2f^2(c^2 - a^2 - b^2) + a^2b^2c^2 = 0,$$

a relation otherwise deduced *Conics*, p. 134.

53. *To express the volume of a tetrahedron in terms of its six edges.*

Let the sides of a triangle formed by any face ABC be a, b, c ; the perpendicular on that face from the remaining vertex be p , and the distances of the foot of that perpendicular from A, B, C be d', e', f' . Then a, b, c, d', e', f' are connected by the relation given in the last article. But if d, e, f be the remaining edges $d^2 = d'^2 + p^2, e^2 = e'^2 + p^2, f^2 = f'^2 + p^2$; whence $d^2 - e^2 = d'^2 - e'^2, \&c.$, and putting in these values, we get

$$-F = p^2(2b^2c^2 + 2c^2a^2 + 2a^2b^2 - a^4 - b^4 - c^4),$$

where F is the quantity on the left-hand side of the equation in the last article. Now the quantity multiplying p^2 is 16 times the square of the area of the triangle ABC , and since p multiplied by this area is three times the volume of the pyramid, we have $F = -144V^2$.

54. *To find the relation between the six arcs joining four points on the surface of a sphere.*

We proceed precisely as in Art. 52, only substituting for the formulæ there used the corresponding formulæ for spherical triangles, and if $\alpha, \beta, \gamma, \delta, \varepsilon, \phi$ represent the *cosines* of the six arcs in question, we get

$$\alpha^2 + \beta^2 + \gamma^2 + \delta^2 + \varepsilon^2 + \phi^2 - \alpha^2\delta^2 - \beta^2\varepsilon^2 - \gamma^2\phi^2 + 2\alpha\beta\delta\varepsilon + 2\beta\gamma\varepsilon\phi + 2\gamma\alpha\delta\phi - 2\alpha\beta\gamma - 2\alpha\varepsilon\phi - 2\beta\delta\phi - 2\gamma\delta\varepsilon = 1.$$

This relation may be otherwise proved as follows: Let the direction-cosines of the radii to the four points be

$$\begin{array}{lll} \cos\alpha, & \cos\beta, & \cos\gamma, \\ \cos\alpha', & \cos\beta', & \cos\gamma', \\ \cos\alpha'', & \cos\beta'', & \cos\gamma'', \\ \cos\alpha''', & \cos\beta''', & \cos\gamma'''. \end{array}$$

Now from this matrix we can form (by the method of *Lessons on Higher Algebra*, Art. 25) a determinant which shall vanish identically, and which (substituting $\cos^2\alpha + \cos^2\beta + \cos^2\gamma = 1$, $\cos\alpha \cos\alpha' + \cos\beta \cos\beta' + \cos\gamma \cos\gamma' = \cos ab$, &c.) is

$$\begin{vmatrix} 1, & \cos ab, & \cos ac, & \cos ad \\ \cos ba, & 1, & \cos bc, & \cos bd \\ \cos ca, & \cos cb, & 1, & \cos cd \\ \cos da, & \cos db, & \cos dc, & 1 \end{vmatrix} = 0,$$

which expanded has the value written above.

This relation might have been otherwise derived from the properties of tetrahedra as follows:

Calling the areas of the four faces of a tetrahedron A, B, C, D ; and denoting by AB the internal angle between the planes A and B , &c. we have evidently any face equal to the sum of the projections on it of the other three faces. Hence we can write down

$$\begin{aligned} -A &+ B \cos AB + C \cos AC + D \cos AD = 0, \\ A \cos BA &- B + C \cos BC + D \cos BD = 0, \\ A \cos CA + B \cos CB &- C + D \cos CD = 0, \\ A \cos DA + B \cos DB + C \cos DC &- D = 0, \end{aligned}$$

from which we can eliminate the areas A, B, C, D , and get a determinant relation between the six angles of intersection of the four planes.

Now as these are any four planes, the perpendiculars let fall on them from any point will meet a sphere described with that point as centre in four quite arbitrary points, say a, b, c, d , and each angle as ab is the supplement of the corresponding angle AB between the planes, hence the former condition.

N.B. The vanishing of a determinant (see *Higher Algebra*, Art 33, Ex. 1) shows that the first minors of any one row are respectively proportional to the corresponding first minors of any other. We see by this article that the minors of the second-determinant are proportional to the areas of the faces of the tetrahedron.

The reader will not find it difficult to show that for any

four points on the sphere, each first minor of the corresponding determinant is that function of one of the four spherical triangles formed by the points which we mentioned in the note to Art. 32 and which has been called by v. Staudt, *Crelle*, 24, p. 252, 1842, the sine of the solid angle that triangle subtends at the centre of the sphere.

55. To find the radius of the sphere circumscribing a tetrahedron.

Since any side a of the tetrahedron is the chord of the arc whose cosine is α , we have $\alpha = 1 - \frac{a^2}{2r^2}$, with similar expressions for β , γ , &c.; and making these substitutions, the first formula of the last paragraph becomes

$$\frac{F}{4r^6} + \frac{2a^2d^2b^2e^2 + 2b^2e^2c^2f^2 + 2c^2f^2a^2d^2 - a^4d^4 - b^4e^4 - c^4f^4}{16r^8} = 0,$$

whence if $ad + be + cf = 2S$,

we have $r^2 = \frac{S(S-ad)(S-be)(S-cf)}{36V^2}$,

which has been otherwise deduced, see *Higher Algebra*, Art. 26.

The reader may exercise himself in proving that the shortest distance between two opposite edges of the tetrahedron is equal to six times the volume divided by the product of those edges multiplied by the sine of their angle of inclination to each other, which may be expressed in terms of the edges by the help of the relation $2ad \cos \theta = b^2 + e^2 - c^2 - f^2$.

56.* We can establish the general formulæ for transformation of quadriplanar coördinates by proceeding one step farther in finding the centre of mean position than we did in Art. 9. We see that if in the tetrahedron whose vertices are P_1, P_2, P_3, P_4 , the line joining P_3 to P_4 be cut in P' , in the ratio $n : m$, then the line joining P' to P_2 in P'' in the ratio $l : m + n$, and lastly that joining P'' to P_1 in P in the ratio $k : l + m + n$, the

* The student may omit the rest of this chapter on first reading..

perpendicular x from P on any plane on which the perpendiculars from P_1, P_2, P_3, P_4 are x_1, x_2, x_3, x_4 , is

$$x = \frac{kx_1 + lx_2 + mx_3 + nx_4}{k + l + m + n}.$$

Now it is evident that $k : k + l + m + n$ as the pyramid on $P_2P_3P_4$ whose vertex is at P is to the pyramid on the same base whose vertex is at P_1 , or, as the perpendiculars from those points on the plane $P_2P_3P_4$. We have similar values for the coefficients of x_2, x_3, x_4 .

Now suppose we call ξ the perpendicular from P on the plane $P_2P_3P_4$, η that from P on the plane $P_3P_4P_1$, ζ that on the plane $P_4P_1P_2$, and ω that on $P_1P_2P_3$. Also if the perpendicular from P_1 on $P_2P_3P_4$ be ξ_0 , from P_2 on $P_3P_4P_1$, η_0 , from P_3 on $P_4P_1P_2$, ζ_0 , and from P_4 on $P_1P_2P_3$, ω_0 , we may write our equation

$$x = \frac{\xi x_1}{\xi_0} + \frac{\eta x_2}{\eta_0} + \frac{\zeta x_3}{\zeta_0} + \frac{\omega x_4}{\omega_0}.$$

Evidently similar equations give the perpendiculars from P on the other planes of reference; for instance,

$$y = \frac{\xi y_1}{\xi_0} + \frac{\eta y_2}{\eta_0} + \frac{\zeta y_3}{\zeta_0} + \frac{\omega y_4}{\omega_0} \text{ \&c.}$$

Thus, writing down these four equations, we have the full system requisite for a transformation of coordinates from the old planes of x, y, z, w to the planes ξ, η, ζ, ω .

It will sometimes be convenient to use a single letter for $\xi : \xi_0$ &c., whereby our expressions will gain in compactness, but at the expense of apparent homogeneity.

It is evident that the transformation of coordinates is quite similar for the coordinates of planes.

57. If we denote by x_0, y_0, z_0, w_0 the perpendiculars from the vertices on the opposite sides of the original tetrahedron, we have obviously, if A, B, C, D be the areas of those faces,

$$Ax_0 = By_0 = Cz_0 = Dw_0 = 3V,$$

where V denotes the volume of that tetrahedron.

By this we may write down the solutions of the equations in last article in the form

$$\xi = \frac{x\xi_1}{x_0} + \frac{y\xi_2}{y_0} + \frac{z\xi_3}{z_0} + \frac{w\xi_4}{w_0} \text{ \&c.},$$

where $\xi_1, \xi_2, \xi_3, \xi_4$ are the perpendiculars on the plane ξ from the vertices of the original tetrahedron.

Also the relation which can at once be written down by equating the volume of the tetrahedron of reference to the sum of the four tetrahedra which its faces subtend at any point, viz. $Ax + By + Cz + Dw = 3V$ may be written

$$\frac{x}{x_0} + \frac{y}{y_0} + \frac{z}{z_0} + \frac{w}{w_0} = 1,$$

and in like manner we have

$$\frac{\xi}{\xi_0} + \frac{\eta}{\eta_0} + \frac{\zeta}{\zeta_0} + \frac{\omega}{\omega_0} = 1$$

as the relations connecting in each system the homogeneous coordinates with an absolute numerical quantity (cf. *Conics*, Art. 63).

Ex. To express the volume of a tetrahedron by the homogeneous coordinates of its vertices.

If we multiply the determinant expression, found Art. 36, for six times the volume W by

$$\begin{vmatrix} \cos \alpha & \cos \beta & \cos \gamma & 0 \\ \cos \alpha' & \cos \beta' & \cos \gamma' & 0 \\ \cos \alpha'' & \cos \beta'' & \cos \gamma'' & 0 \\ 0 & 0 & 0 & 1 \end{vmatrix},$$

which is the same as the determinant in note Art. 32, and as in the transformation (*G*) Art. 18, we find

$$\begin{vmatrix} X' & Y' & Z' & 1 \\ X'' & Y'' & Z'' & 1 \\ X''' & Y''' & Z''' & 1 \\ X'''' & Y'''' & Z'''' & 1 \end{vmatrix}$$

as the product of six times the volume W by the quantity which we may call the sine of the solid angle (XYZ) Art. 54.

Now these coordinates are measured along the axes, and we want to refer to perpendiculars on the coordinate planes. Hence we may write the new coordinates $x = X \sin p$, $y = Y \sin q$, $z = Z \sin r$, where p, q, r are the angles the axes of X, Y, Z make with the planes YZ, r , &c.; therefore

$$\begin{vmatrix} x' & y' & z' & 1 \\ x'' & y'' & z'' & 1 \\ x''' & y''' & z''' & 1 \\ x'''' & y'''' & z'''' & 1 \end{vmatrix} = 6W \sin p \sin q \sin r \sin (XYZ),$$

or by the relations

$$\frac{x}{x_0} + \frac{y}{y_0} + \frac{z}{z_0} + \frac{w}{w_0} = 1, \text{ \&c.},$$

$$\begin{vmatrix} x' & y' & z' & w' \\ x'' & y'' & z'' & w'' \\ x''' & y''' & z''' & w''' \\ x'''' & y'''' & z'''' & w'''' \end{vmatrix} = 6Ww_0 \sin p \sin q \sin r \sin (XYZ).$$

We may give this another form by remarking that the determinant reduces for the tetrahedron of reference to the continued product, which is its leading term, hence

$$x_0 y_0 z_0 w_0 = 6Vw_0 \sin p \sin q \sin r \sin (XYZ),$$

whence, dividing the former equation by this,

$$\frac{(x'y''z'''w''')}{x_0 y_0 z_0 w_0} = \frac{W}{V}.$$

57a. If we had employed quadriplanar coordinates in Art. 40, we should have used for the coordinates of any point P on the line joining P_1, P_2 ,

$x = lx_1 + mx_2, y = ly_1 + my_2, z = lz_1 + mz_2, w = lw_1 + mw_2$,
from which, by eliminating l and m , we find each determinant of the matrix

$$\begin{vmatrix} x & y & z & w \\ x_1 & y_1 & z_1 & w_1 \\ x_2 & y_2 & z_2 & w_2 \end{vmatrix} = 0.$$

These four determinants contain the coordinates of P_1, P_2 only in the groups

$$(y_1 z_2), (z_1 x_2), (x_1 y_2), \\ (x_1 w_2), (y_1 w_2), (z_1 w_2),$$

which are connected by the identity

$$(y_1 z_2)(x_1 w_2) + (z_1 x_2)(y_1 w_2) + (x_1 y_2)(z_1 w_2) = 0.$$

Thus these six quantities so connected amount to four independent ratios determining the equations, and are homogeneous coordinates of the right line; we shall frequently denote them, for brevity, by the letters

$$p, \quad q, \quad r, \\ s, \quad t, \quad u,$$

with or without two suffixes to indicate, as may sometimes be required, the two points determining the right line; in all cases these quantities are subject to the relation

$$ps + qt + ru = 0.$$

The geometrical value of these coordinates was obtained Ex. Art. 50, where we saw that each of them, as, for instance, $(y_1 z_2)$ is the product of the distance $P_1 P_2$, by the sine of the angle between the planes, which are named in it, multiplied into the shortest distance of $P_1 P_2$ from the edge in which those planes intersect and into the sine of the angle between that edge and $P_1 P_2$.

Thus the equations connecting the coordinates of any point with the coordinates of any right line passing through it are any two of the four

$$\begin{aligned} yu - zt + wp &= 0, \\ -xu + zs + wq &= 0, \\ xt - ys + wr &= 0, \\ xp + yq + zr &= 0, \end{aligned}$$

from which always by $ps + qt + ru = 0$ the remaining two can be deduced. These are the equations of a line as *locus* or *ray*.

57b. In like manner, Art. 38, if $a_1 b_1 c_1 d_1$, $a_2 b_2 c_2 d_2$ be the coordinates of two planes Π_1 , Π_2 , the coordinates of any plane through their line of intersection are

$$a = \lambda a_1 + \mu a_2, \quad b = \lambda b_1 + \mu b_2, \quad c = \lambda c_1 + \mu c_2, \quad d = \lambda d_1 + \mu d_2,$$

hence for a line regarded as *envelope* or *axis*, we have the system of equations

$$\begin{vmatrix} a, & b, & c, & d \\ a_1, & b_1, & c_1, & d_1 \\ a_2, & b_2, & c_2, & d_2 \end{vmatrix} = 0,$$

which, adopting a notation in analogy with what precedes,

$$\begin{aligned} (b_1 c_2) &= \pi_{12}, & (c_1 a_2) &= \kappa_{12}, & (a_1 b_2) &= \rho_{12}, \\ (a_1 d_2) &= \sigma_{12}, & (b_1 d_2) &= \tau_{12}, & (c_1 d_2) &= \nu_{12} \end{aligned}$$

may be written, omitting suffixes,

$$\begin{aligned} bv - c\tau + d\pi &= 0, \\ -av + c\sigma + d\kappa &= 0, \\ a\tau - b\sigma + d\rho &= 0, \\ a\pi + b\kappa + c\rho &= 0, \end{aligned}$$

subject to

$$\pi\sigma + \kappa\tau + \rho\nu = 0.$$

If this line contain the point P_1 , since then

$$ax_1 + by_1 + cz_1 + dw_1 = 0,$$

we may substitute for a and b in terms of c and d and make the coefficients of c and d vanish; and similarly for the others, hence in this case

$$\begin{aligned} y_1\rho - z_1\kappa + w_1\sigma &= 0, \\ -x_1\rho + z_1\pi + w_1\tau &= 0, \\ x_1\kappa - y_1\pi + w_1\nu &= 0, \\ x_1\sigma + y_1\tau + z_1\nu &= 0. \end{aligned}$$

In like manner, if in the last article we had sought for the conditions that the ray should be contained in the plane a, b, c, d , we should have found

$$\begin{aligned} br - cq + ds &= 0, \\ -ar + cp + dt &= 0, \\ aq - bp + du &= 0, \\ as + bt + cu &= 0. \end{aligned}$$

Further, if we have the point P_2 also on the axis, we find

$$p : q : r : s : t : u = \sigma : \tau : \nu : \pi : \kappa : \rho,$$

or in full, if the line joining P_1 to P_2 be identical with the line in which Π_1, Π_2 intersect, each determinant vanishes in the matrix,

$$\left\| \begin{array}{cccccc} (y_1z_2), & (z_1x_2), & (x_1y_2), & (x_1w_2), & (y_1w_2), & (z_1w_2) \\ (a_1d_2), & (b_1d_2), & (c_1d_2), & (b_1c_2), & (c_1a_2), & (a_1b_2) \end{array} \right\|.$$

Thus we see, that equations in the homogeneous coordinates of a right line are capable of being expressed in either system, the passage from one to the other being effected by an interchange of the coordinates p and s, q and t, r and u .

N.B. These results are merely another way of presenting the four simultaneous relations

$$\begin{aligned} a_1x_1 + b_1y_1 + c_1z_1 + d_1w_1 &= 0, \\ a_1x_2 + b_1y_2 + c_1z_2 + d_1w_2 &= 0, \\ a_2x_1 + b_2y_1 + c_2z_1 + d_2w_1 &= 0, \\ a_2x_2 + b_2y_2 + c_2z_2 + d_2w_2 &= 0. \end{aligned}$$

57c. The determinant of the homogeneous coordinates of four points

$$\begin{vmatrix} x_1, & y_1, & z_1, & w_1 \\ x_2, & y_2, & z_2, & w_2 \\ x_3, & y_3, & z_3, & w_3 \\ x_4, & y_4, & z_4, & w_4 \end{vmatrix},$$

whose geometric value we deduced in Ex. Art. 57, may be written out in full, as in *Higher Algebra*, Art. 7; and it is easily seen that the terms occur only in the groups of second minors, which are the homogeneous coordinates of the lines arrived at in 57a.

Now when the line joining points 1 and 2 intersects the line joining 3 and 4, the four points are coplanar and the determinant vanishes.

Hence it appears that the condition that two right lines

$$\left(\begin{matrix} p, & q, & r \\ s, & t, & u \end{matrix} \right), \quad \left(\begin{matrix} p', & q', & r' \\ s', & t', & u' \end{matrix} \right)$$

should intersect is

$$ps' + sp' + qt' + tq' + ru' + ur' = 0.$$

57d. By what precedes we can see how to determine the lines which meet four given right lines. For if the coordinates of the

required line be $\begin{matrix} p, & q, & r \\ s, & t, & u \end{matrix}$ and of the given lines $\begin{matrix} p_1, & q_1, & r_1 \\ s_1, & t_1, & u_1 \end{matrix}$ &c.,

we have

$$ps_1 + qt_1 + ru_1 + sp_1 + tq_1 + ur_1 = 0,$$

$$ps_2 + qt_2 + ru_2 + sp_2 + tq_2 + ur_2 = 0,$$

$$ps_3 + qt_3 + ru_3 + sp_3 + tq_3 + ur_3 = 0,$$

$$ps_4 + qt_4 + ru_4 + sp_4 + tq_4 + ur_4 = 0,$$

which determine p, q, r, s linearly in terms of t and u , and when these values are substituted in the universal relation

$$ps + qt + ru = 0,$$

a quadratic is found in $t : u$, which determines the lines, two in number, which are required.

57e. In the coordinates of a line we have in transformation to consider the transformed coordinates of two points or planes.

Ex. gr. considering

$$x = x_1X + x_2Y + x_3Z + x_4W, \quad x' = x_1X' + x_2Y' + x_3Z' + x_4W',$$

$$y = y_1X + y_2Y + y_3Z + y_4W, \quad y' = y_1X' + y_2Y' + y_3Z' + y_4W',$$

&c., we have

$$\begin{vmatrix} y, z \\ y', z' \end{vmatrix} = \begin{vmatrix} y_1, y_2, y_3, y_4 \\ z_1, z_2, z_3, z_4 \end{vmatrix} \begin{vmatrix} X, Y, Z, W \\ X', Y', Z', W' \end{vmatrix},$$

or

$$p = p_{23}P + p_{31}Q + p_{12}R + p_{14}S + p_{24}T + p_{34}U,$$

$$q = q_{23}P + q_{31}Q + q_{12}R + q_{14}S + q_{24}T + q_{34}U,$$

$$r = r_{23}P + r_{31}Q + r_{12}R + r_{14}S + r_{24}T + r_{34}U,$$

$$s = s_{23}P + s_{31}Q + s_{12}R + s_{14}S + s_{24}T + s_{34}U,$$

$$t = t_{23}P + t_{31}Q + t_{12}R + t_{14}S + t_{24}T + t_{34}U,$$

$$u = u_{23}P + u_{31}Q + u_{12}R + u_{14}S + u_{24}T + u_{34}U,$$

the coefficients of the transformation evidently being the coordinates of the edges of the new tetrahedron referred to the old.

If we multiply these equations in order by s_{14} , t_{14} , u_{14} , p_{14} , q_{14} , r_{14} and add, we evidently solve for P in terms of the old coordinates, and (Art. 57c) the factor on P is the modulus of transformation; it is easy to complete the solution.

CHAPTER IV.

*PROPERTIES COMMON TO ALL SURFACES OF THE
SECOND DEGREE.

58. WE shall write the general equation of the second degree

$$(a, b, c, d, f, g, h, l, m, n) (x, y, z, 1)^2 =$$

$$\text{or } ax^2 + by^2 + cz^2 + d + 2fyz + 2gzx + 2hxy + 2lx + 2my + 2nz = 0.$$

This equation contains ten terms, and since its signification is not altered, if by division we make one of the coefficients unity, it appears that nine conditions are sufficient to determine a surface of the second degree, or, as we shall call it for shortness, a *quadric*† surface. Thus, if we are given nine points on the surface, by substituting successively the coordinates of each in the general equation, we obtain nine equations which are sufficient to determine the nine unknown quantities $\frac{b}{a}$, $\frac{c}{a}$, &c.

And, in like manner, the number of conditions necessary to determine a surface of the n^{th} degree is one less than the number of terms in the general equation.

The equation of a quadric may also (see Art. 38) be expressed as a homogeneous function of the equations of four given planes x, y, z, w .

$$(a, b, c, d, f, g, h, l, m, n) (x, y, z, w)^2 =$$

$$\text{or } ax^2 + by^2 + cz^2 + dw^2 + 2fyz + 2gzx + 2hxy + 2lxw + 2myw + 2nzw = 0.$$

For the nine independent constants in the equation last written may be so determined that the surface shall pass through nine

* The reader will compare the corresponding discussion of the equation of the second degree (*Conics*, Chap. x.) and observe the identity of the methods now pursued and the similarity of many of the results obtained.

† In the *Treatise on Solid Geometry* by Messrs. Frost and Wolstenholme, surfaces of the second degree are called *conicoids*.

given points, and therefore may coincide with any given quadric. In like manner (see *Conics*, Art. 69) any ordinary x, y, z equations may be made homogeneous by the introduction of the linear unit (which we shall call w); and we shall frequently employ equations written in this form for the sake of greater symmetry in the results. We shall however, for simplicity, commence with x, y, z coordinates.

59. The coordinates are transformed to any parallel axes drawn through a point $x'y'z'$, by writing $x + x', y + y', z + z'$ for x, y, z respectively (Art. 16). The result of this substitution will be that the coefficients of the highest powers of the variables (a, b, c, f, g, h) will remain unaltered, that the new absolute term will be U' (where U' is the result of substituting x', y', z' for x, y, z in the given equation), that the new coefficient of x will be $2(ax' + hy' + gz' + l)$ or $\frac{dU'}{dx'}$, and, in like manner, that the new coefficients of y and z will be $\frac{dU'}{dy'}$ and $\frac{dU'}{dz'}$. We shall find it convenient to use the abbreviations U_1, U_2, U_3 for $\frac{1}{2} \frac{dU}{dx}, \frac{1}{2} \frac{dU}{dy}, \frac{1}{2} \frac{dU}{dz}$.

60. We can transform the general equation to polar coordinates by writing $x = \lambda\rho, y = \mu\rho, z = \nu\rho$ (where, if the axes be rectangular, λ, μ, ν are equal to $\cos\alpha, \cos\beta, \cos\gamma$ respectively, and if they are oblique (see note, p. 7) λ, μ, ν are still quantities depending only on the angles the line makes with the axes) when the equation becomes

$$\rho^2 (a\lambda^2 + b\mu^2 + c\nu^2 + 2f\mu\nu + 2g\nu\lambda + 2h\lambda\mu) + 2\rho (l\lambda + m\mu + n\nu) + d = 0.$$

This being a quadratic gives *two* values for the length of the radius vector corresponding to any given direction; in accordance with what was proved (Art. 23), viz. that *every right line meets a quadric in two points*.

61. Let us consider first the case where the origin is on the surface (and therefore $d = 0$), in which case one of the roots of

the above quadratic is $\rho = 0$; and let us seek the condition that the radius vector should touch the surface at the origin. In this case obviously the second root of the quadratic will also vanish, and the required condition is therefore $l\lambda + m\mu + n\nu = 0$. If we multiply by ρ and replace $\lambda\rho, \mu\rho, \nu\rho$ by x, y, z , this becomes

$$lx + my + nz = 0,$$

and evidently expresses that the radius vector lies in a certain fixed plane. And since λ, μ, ν are subject to no restriction but that already written, every radius vector through the origin drawn in this plane touches the surface.

Hence we learn that at a given point on a quadric an infinity of tangent lines can be drawn, that these lie all in one plane which is called the *tangent plane* at that point; and that if the equation of the surface be written in the form $u_2 + u_1 = 0$, then $u_1 = 0$ is the equation of the tangent plane at the origin.

62. We can find by transformation of coordinates the equation of the tangent plane at any point $x'y'z'$ in the surface. For when we transform to this point as origin, the absolute term vanishes, and the equation of the tangent plane is (Art. 59)

$$xU'_1 + yU'_2 + zU'_3 = 0,$$

or, transforming back to the old axes,

$$(x - x')U'_1 + (y - y')U'_2 + (z - z')U'_3 = 0.$$

This may be written in a more symmetrical form by the introduction of the linear unit w , when, since U is now a homogeneous function, and the point $x'y'z'w'$ is to satisfy the equation of the surface, we have

$$x'U'_1 + y'U'_2 + z'U'_3 + w'U'_4 = U' = 0.$$

Adding this to the equation last found, we have the equation of the tangent plane in the form

$$xU'_1 + yU'_2 + zU'_3 + wU'_4 = 0;$$

or, writing at full length,

$$\begin{aligned} x(ax' + hy' + gz' + lw') + y(hx' + by' + fz + mw') \\ + z(gx' + fy' + cz' + nw') + w(lx' + my' + nz' + dw') = 0. \end{aligned}$$

This equation, it will be observed, is symmetrical between $xyzw$ and $x'y'z'w'$, and may likewise be written

$$x'U_1 + y'U_2 + z'U_3 + w'U_4 = 0.$$

63. To find the point of contact of a tangent line or plane drawn through a given point $x'y'z'w'$ not on the surface.

The equation last found expresses a relation between $xyzw$, the coordinates of any point on the tangent plane, and $x'y'z'w'$ its point of contact; and since now we wish to indicate that the former coordinates are given and the latter sought, we have only to remove the accents from the latter and accentuate the former coordinates, when we find that the point of contact must lie in the plane

$$xU'_1 + yU'_2 + zU'_3 + wU'_4 = 0,$$

which is called the *polar plane* of the given point. Since the point of contact need satisfy no other condition, the tangent plane at *any* of the points where the polar plane meets the surface will pass through the given point; and the line joining that point of contact to the given point will be a tangent line to the surface. If all the points of intersection of the polar plane and the surface be joined to the given point, we shall have all the lines which can be drawn through that point to touch the surface, and the assemblage of these lines forms what is called the *tangent cone* through the given point.

N.B. In general a surface generated by right lines which all pass through the same point is called a *cone*, and the point through which the lines pass is called its *vertex*. A cylinder (see p. 15) is the limiting case of a cone when the vertex is infinitely distant.

64. The polar plane may be also defined as the locus of harmonic means of radii passing through the pole. In fact, let us examine the locus of points of harmonic section of radii passing through the origin; then if ρ', ρ'' be the roots of the quadratic of Art. 60, and ρ the radius vector of the locus, we are to have

$$\frac{2}{\rho} = \frac{1}{\rho'} + \frac{1}{\rho''} = -\frac{2(\lambda l + \mu m + \nu n)}{d},$$

or, returning to x, y, z coordinates,

$$lx + my + nz + d = 0;$$

but this is the polar plane of the origin, as may be seen by making x', y', z' all $= 0$ in the equation written in full (Art. 62).

From this definition of the polar plane, it is evident that if a section of a surface be made by a plane passing through any point, the polar of that point with regard to the section will be the intersection of the plane of section with the polar plane of the given point. For the locus of harmonic means of *all* radii passing through the point must include the locus of harmonic means of the radii which lie in the plane of section.

65. If the polar plane of any point A pass through B , then the polar plane of B will pass through A .

For since the equation of the polar plane is symmetrical with respect to $xyz, x'y'z'$, we get the same result whether we substitute the coordinates of the second point in the equation of the polar plane of the first, or *vice versa*.

The intersection of the polar planes of A and of B will be a line which we shall call the polar line, with respect to the surface, of the line AB . It is easy to see that the polar line of the line AB is the locus of the poles of all planes which can be drawn through the line AB .

66. If in the original equation we had not only $d = 0$, but also l, m, n each $= 0$, then the equation of the tangent plane at the origin, found (Art. 61), becomes illusory since every term vanishes; and no single plane can be called the tangent plane at the origin. In fact, the coefficient of ρ (Art. 60) vanishes whatever be the direction of ρ , and therefore *every* line drawn through the origin meets the surface in two consecutive points, and the origin is said to be a double point on the surface.

In the present case, the equation denotes a cone whose vertex is the origin, as in fact does every homogeneous equation in x, y, z . For if such an equation be satisfied by any coordinates x', y', z' , it will be satisfied by the coordinates kx', ky', kz' (where k is any constant), that is to say, by the coordinates of every point on the line joining $x'y'z'$ to the origin.

This line then lies wholly in the surface, which must therefore consist of a series of right lines drawn through the origin.

The equation of the tangent plane at any point of the cone now under consideration may be written in either of the forms

$$xU'_1 + yU'_2 + zU'_3 = 0, \quad x'U_1 + y'U_2 + z'U_3 = 0.$$

The former (wanting an absolute term) shews that the tangent plane at every point on the cone passes through the origin; the latter form shews that the tangent plane at any point $x'y'z'$ touches the surface at every point of the line joining $x'y'z'$ to the vertex; for the equation will represent the same plane if we substitute kx', ky', kz' for x', y', z' .

When the point $x'y'z'$ is not on the surface, the equation we have been last discussing represents the polar of that point, and it appears in like manner that the polar plane of every point passes through the vertex of the cone, and also that all points which lie on the same line passing through the vertex of a cone have the same polar plane.

To find the polar plane of any point with regard to a cone we need only take any section through that point, and take the polar line of the point with regard to that section; then the plane joining this polar line to the vertex will be the polar plane required. For it was proved (Art. 64) that the polar plane must contain the polar line, and it is now proved that the polar plane must contain the vertex.

67. We can easily find the condition that the general equation of the second degree should represent a cone. For if it does it will be possible by transformation of coordinates to make the new l, m, n, d vanish. The coordinates of the new vertex must therefore (Art. 59) satisfy the conditions

$$U'_1 = 0, \quad U'_2 = 0, \quad U'_3 = 0, \quad U' = 0,$$

which last combined with the others is equivalent to $U'_4 = 0$. And if we eliminate x', y', z' from the four equations

$$\begin{aligned} ax' + hy' + gz' + l &= 0, \\ hx' + by' + fz' + m &= 0, \\ gx' + fy' + cz' + n &= 0, \\ lx' + my' + nz' + d &= 0, \end{aligned}$$

we obtain the required condition in the form of the determinant

$$\begin{vmatrix} a, & h, & g, & l \\ h, & b, & f, & m \\ g, & f, & c, & n \\ l, & m, & n, & d \end{vmatrix} = 0,$$

which, written at full length, is

$$abcd + 2afmn + 2bgnl + 2chlm + 2dfgh - bcl^2 - cam^2 - abn^2 - adf^2 - bdg^2 - cdh^2 + f^2l^2 + g^2m^2 + h^2n^2 - 2ghmn - 2hfnl - 2fglm = 0.$$

We shall often write this equation $\Delta = 0$, and (as in *Conics*, p. 153) shall call Δ the *discriminant* of the given quadric.

It will be found convenient hereafter to use the abbreviations $A, B, C, D, 2F, 2G, 2H, 2L, 2M, 2N$, to denote the differential coefficients of Δ taken with respect to a, b, c , &c. Thus

$$\begin{aligned} A &= bcd + 2fmn - bn^2 - cm^2 - df^2, \\ B &= cda + 2gnl - cl^2 - an^2 - dg^2, \\ C &= dab + 2hlm - am^2 - bl^2 - dh^2, \\ D &= abc + 2fgh - af^2 - bg^2 - ch^2, \\ F &= amn + dgh - adf + fl^2 - hnl - glm, \\ G &= bnl + dhf - bdg + gm^2 - flm - hmn, \\ H &= clm + dfg - cdh + hn^2 - gmn - fnl, \\ L &= bgn + chm - bcl + lf^2 - hfn - gfm, \\ M &= chl + afn - cam + mg^2 - fgl - ghn, \\ N &= afm + bgl - abn + nh^2 - ghm - hfl. \end{aligned}$$

68. Let us return now to the quadratic of Art. 60, in which d is not supposed to vanish, and let us examine the condition that the radius vector should be bisected at the origin. It is obviously necessary and sufficient that the coefficient of ρ in that quadratic should vanish, since we should then get for ρ values equal with opposite signs. The condition required then is

$$l\lambda + m\mu + n\nu = 0,$$

which multiplied by ρ shews that the radius vector must lie in the plane $lx + my + nz = 0$. Hence (Art. 64) every right line drawn through the origin in a plane parallel to its polar plane is bisected at the origin.

69. If, however, we had $l=0, m=0, n=0$, then every line drawn through the origin would be bisected and the origin would be called the *centre* of the surface. Every quadric has in general one and but one centre. For if we seek by transformation of coordinates to make the new $l, m, n=0$, we obtain three equations, viz.

$$U_1' = 0, \text{ or } ax' + hy' + gz' + l = 0,$$

$$U_2' = 0, \text{ or } hx' + by' + fz' + m = 0,$$

$$U_3' = 0, \text{ or } gx' + fy' + cz' + n = 0,$$

which are sufficient to determine the three unknowns x', y', z' .

The resulting values are $x' = \frac{L}{D}, y' = \frac{M}{D}, z' = \frac{N}{D}$, where L, M, N, D have the same meaning as in Art. 67.

If, however, $D=0$, the coordinates of the centre become infinite and the surface has no finite centre. If we write the original equation $u_2 + u_1 + u_0 = 0$, it is evident that D is the discriminant of u_2 .*

70. To find the locus of the middle points of chords parallel to a given line $\frac{x}{\lambda} = \frac{y}{\mu} = \frac{z}{\nu}$.

If we transform the equation to any point on the locus as origin, the new l, m, n must fulfil the condition (Art. 68) $l\lambda + m\mu + n\nu = 0$, and therefore (Art. 59) the equation of the locus is

$$\lambda U_1 + \mu U_2 + \nu U_3 = 0.$$

This denotes a plane through the intersection of the planes U_1, U_2, U_3 , that is to say, through the centre of the surface.

* It is possible that the numerators of these fractions might vanish at the same time with the denominator, in which case the coordinates of the centre would become indeterminate, and the surface would have an infinity of centres. Thus if the three planes U_1, U_2, U_3 all pass through the same line, any point on this line will be a centre. The conditions that this should be the case may be written

$$\left\| \begin{array}{cccc} a, & h, & g, & l \\ h, & b, & f, & m \\ g, & f, & c, & n \end{array} \right\| = 0,$$

the notation indicating that all the four determinants must $= 0$, which are got by erasing any of the vertical lines. We shall reserve the fuller discussion of these cases for the next chapter.

It is called the diametral plane conjugate to the given direction of the chords.

If $x'y'z'$ be any point on the radius vector drawn through the origin parallel to the given direction, the equation of the diametral plane may be written

$$x' U_1 + y' U_2 + z' U_3 = 0.$$

If now we take the equation of the polar plane of kx', ky', kz' ,

$$kx' U_1 + ky' U_2 + kz' U_3 + U_4 = 0,$$

divide it by k , and then make k infinite, we see that the diametral plane is the polar of the point at infinity on a line drawn in the given direction, as we might also have inferred from geometrical considerations (see *Conics*, Art. 324). In like manner, the centre is the pole of the plane at infinity, for if the origin be the centre, its polar plane (Art. 64) is $d=0$, which (Art. 30) represents a plane situated at an infinite distance.

In the case where the given surface is a cone, it is evident that the plane which bisects chords parallel to any line drawn through the vertex is the same as the polar plane of any point in that line. In fact it was proved that all points on the line have the same polar plane, therefore the polar of the point at infinity on that line is the same as the polar plane of any other point in it.

71. The plane which bisects chords parallel to the axis of x is found, by making $\mu = 0$, $\nu = 0$ in the equation of Art. 70, to be

$$U_1 = 0, \text{ or } ax + hy + gz + l = 0,*$$

and this will be parallel to the axis of y , if $h = 0$. But this is also the condition that the plane conjugate to the axis of y should be parallel to the axis of x . Hence *if the plane conjugate to a given direction be parallel to a second given line, the plane conjugate to the latter will be parallel to the former.*

* It follows that the plane $x = 0$ will bisect chords parallel to the axis of x , if $h = 0$, $g = 0$, $l = 0$; or, in other words, if the original equation do not contain any odd power of x . But it is otherwise evident that this must be the case in order that for any assigned values of y and z we may obtain equal and opposite values of x .

When $h = 0$, the axes of x and y are evidently parallel to a pair of conjugate diameters of the section by the plane of xy ; and it is otherwise evident that the plane conjugate to one of two conjugate diameters of a section passes through the other. For the locus of middle points of *all* chords of the surface parallel to a given line must include the locus of the middle points of all such chords which are contained in a given plane.

Three diametral planes are said to be conjugate when each is conjugate to the intersection of the other two, and three diameters are said to be conjugate when each is conjugate to the plane of the other two. Thus we should obtain a system of three conjugate diameters by taking two conjugate diameters of any central section together with the diameter conjugate to the plane of that section. If we had in the equation $f = 0$, $g = 0$, $h = 0$, it appears from the commencement of this article that the coordinate planes are parallel to three conjugate diametral planes.

When the surface is a cone, it is evident from what was said (Arts. 66, 70) that a system of three conjugate diameters meets any plane section in points such that each is the pole with respect to the section of the line joining the other two.

72. A diametral plane is said to be principal if it be perpendicular to the chords to which it is conjugate.

The axes being rectangular, and λ , μ , ν the direction-cosines of a chord, we have seen (Art. 70) that the corresponding diametral plane is

$$\lambda(ax + hy + gz + l) + \mu(hx + by + fz + m) + \nu(gx + fy + cz + n) = 0,$$

and this will be perpendicular to the chord, if (Art. 43) the coefficients of x , y , z be respectively proportional to λ , μ , ν . This gives us the three equations

$$\lambda a + \mu h + \nu g = k\lambda, \quad \lambda h + \mu b + \nu f = k\mu, \quad \lambda g + \mu f + \nu c = k\nu.$$

From these equations, which are linear in λ , μ , ν , we can eliminate λ , μ , ν , when we obtain the determinant

$$\begin{vmatrix} a - k, & h, & g \\ h, & b - k, & f \\ g, & f, & c - k \end{vmatrix} = 0,$$

which expanded gives a cubic for the determination of k , viz.

$$k^3 - k^2(a + b + c) + k(bc + ca + ab - f^2 - g^2 - h^2) - (abc + 2fgh - af^2 - bg^2 - ch^2) = 0.$$

And the three values hence found for k being successively substituted in the preceding equations enables us to determine the corresponding values of λ , μ , ν . Hence, a quadric has in general three principal diametral planes, the three diameters perpendicular to which are called the *axes* of the surface. We shall discuss this equation more fully in the next chapter.

Ex. To find the principal planes of

$$7x^2 + 6y^2 + 5z^2 - 4xy - 4yz = 6.$$

The cubic for k is

$$k^3 - 18k^2 + 99k - 162 = 0,$$

whose roots are 3, 6, 9. Now our three equations are

$$7\lambda - 2\mu = k\lambda, \quad -2\lambda + 6\mu - 2\nu = k\mu, \quad -2\mu + 5\nu = k\nu.$$

If in these we substitute $k = 3$, we find $2\lambda = \mu = \nu$. Multiplying by ρ , and substituting x for $\lambda\rho$, &c., we get for the equations of one of the axes $2x = y = z$. And the plane drawn through the origin (which is the centre), perpendicular to this line, is $x + 2y + 2z = 0$. In like manner the other two principal planes are $2x - 2y + z = 0$, $2x + y - 2z = 0$.*

73. *The sections of a quadric by parallel planes are similar to each other.*

Since any plane may be taken for the plane of xy , it is sufficient to consider the section made by it, which is found by putting $z = 0$ in the equation of the surface. But the section by any parallel plane is found by transforming the equation to parallel axes through any new origin, and then making $z = 0$.

If we retain the planes yz and zx , and transfer the plane xy parallel to itself, the section by this plane is got at once by writing $z = c$ in the equation of the surface, since it is evident that it is the same thing whether we write $z + c$ for z , and then make $z = 0$, or whether we write at once $z = c$.

* If U denote the terms of highest degree in the equation, and S denote $(bc - f^2)x^2 + (ca - g^2)y^2 + (ab - h^2)z^2 + 2(g h - af)yz + 2(hf - bg)zx + 2(fg - ch)xy$, then the equation of the three principal planes, the centre being origin, is denoted by the determinant

$$\begin{vmatrix} x & y & z \\ U_1 & U_2 & U_3 \\ S_1 & S_2 & S_3 \end{vmatrix} = 0.$$

And since the coefficients of x^2 , xy , and y^2 are unaltered by this transformation, the curves are similar.

It is easy to prove algebraically, that the locus of centres of parallel sections is the diameter conjugate to their plane, as is geometrically evident.

74. If ρ' , ρ'' be the roots of the quadratic of Art. 60, their product $\rho'\rho''$ is $=d$ divided by the coefficient of ρ^2 . But if we transform to parallel axes, and consider a radius vector drawn parallel to the first direction, the coefficient of ρ^2 remains unchanged, and the product is proportional to the new d . Hence, if through two given points A , B , any parallel chords be drawn meeting the surface in points R , R' ; S , S' , then the products $RA.AR'$, $SB.BS'$ are to each other in a constant ratio, namely, $U' : U''$ where U' , U'' are the results of substituting the coordinates of A and of B in the given equation.

75. We shall conclude this chapter by shewing how the theorems already deduced from the discussion of lines passing through the origin might have been derived by a more general process, such as that employed (*Conics*, Art. 91). For symmetry we use homogeneous equations with four variables.

To find the points where a given quadric is met by the line joining two given points $x'y'z'w'$, $x''y''z''w''$.

Let us take as our unknown quantity the ratio $\mu : \lambda$, in which the joining line is cut at the point where it meets the quadric, then (Art. 8) the coordinates of that point are proportional to

$$\lambda x' + \mu x'', \lambda y' + \mu y'', \lambda z' + \mu z'', \lambda w' + \mu w'';$$

and if we substitute these values in the equation of the surface, we get for the determination of $\lambda : \mu$, a *quadratic*

$$\lambda^2 U' + 2\lambda\mu P + \mu^2 U'' = 0.$$

The coefficients of λ^2 and μ^2 are easily seen to be the results of substituting in the equation of the surface the coordinates of each of the points, while the coefficient of $2\lambda\mu$ may be seen (by Taylor's theorem, or otherwise) to be capable of being written in either of the forms

$$\begin{aligned} & x' U_1'' + y' U_2'' + z' U_3'' + w' U_4'', \\ \text{or} & x'' U_1' + y'' U_2' + z'' U_3' + w'' U_4'. \end{aligned}$$

Having found from this quadratic the values of $\lambda : \mu$, substituting each of them in the expressions $\lambda x' + \mu x''$, &c., we find the coordinates of the points where the quadric is met by the given line.

76. If $x'y'z'w'$ be on the surface, then $U' = 0$, and one of the roots of the last quadratic is $\mu = 0$, which corresponds to the point $x'y'z'w'$, as evidently ought to be the case. In order that the second root should also be $\mu = 0$, we must have $P = 0$. If then the line joining $x'y'z'w'$ to $x''y''z''w''$ touch the surface at the former point, the coordinates of the latter must satisfy the equation

$$xU'_1 + yU'_2 + zU'_3 + wU'_4 = 0,$$

and since $x''y''z''w''$ may be *any* point on *any* tangent line through $x'y'z'w'$, it follows that every such tangent lies in the plane whose equation has been just written.

77. If $x'y'z'w'$ be *not* on the surface, and yet the relation $P = 0$ be satisfied, the quadratic of Art. 75 takes the form $\lambda^2 U' + \mu^2 U'' = 0$, which gives values of $\lambda : \mu$, equal with opposite signs. Hence the line joining the given points is cut by the surface externally and internally in the same ratio; that is to say, is cut harmonically. It follows then that the locus of points of harmonic section of radii drawn through $x'y'z'w'$ is the polar plane

$$xU'_1 + yU'_2 + zU'_3 + wU'_4 = 0.$$

78. In general if the line joining the two points touch the surface, the quadratic of Art. 75 must have equal roots, and the coordinates of the two points must be connected by the relation $U'U'' = P^2$. If the point $x'y'z'w'$ be fixed, this relation ought to be fulfilled if the other point lie on any of the tangent lines which can be drawn through it. Hence the cone generated by all these tangent lines will have for its equation $UU' = P^2$, where

$$P = xU'_1 + yU'_2 + zU'_3 + wU'_4.$$

Ex. To find the equation of the tangent cone from the point $x'y'z'$ to the surface $\frac{x^2}{a^2} + \frac{y^2}{b^2} + \frac{z^2}{c^2} = 1$. *Ans.* $\left(\frac{x'^2}{a^2} + \frac{y'^2}{b^2} + \frac{z'^2}{c^2} - 1\right)\left(x^2 + \frac{y^2}{b^2} + \frac{z^2}{c^2} - 1\right) = \left(\frac{xx'}{a^2} + \frac{yy'}{b^2} + \frac{zz'}{c^2} - 1\right)^2$.

79. To find the condition that the plane $\alpha x + \beta y + \gamma z + \delta w$ should touch the surface given by the general equation.

First, if x, y, z, w be the coordinates of the pole of this plane, and k an indeterminate multiplier, we have (Art. 63) in general

$$k\alpha = ax + hy + gz + lw, \quad k\beta = hx + by + fz + mw,$$

$$k\gamma = gx + fy + cz + nw, \quad k\delta = lx + my + nz + dw,$$

to determine the pole of the given plane. Solving for x, y, z, w from these equations, we find

$$\Delta x = k(A\alpha + H\beta + G\gamma + L\delta),$$

$$\Delta y = k(H\alpha + B\beta + F\gamma + M\delta),$$

$$\Delta z = k(G\alpha + F\beta + C\gamma + N\delta),$$

$$\Delta w = k(L\alpha + M\beta + N\gamma + D\delta),$$

where $\Delta, A, B, C,$ &c. have the same meaning as in Art. 67. Now if these values satisfy the equation $\alpha x + \beta y + \gamma z + \delta w = 0$, we get by eliminating them

$$A\alpha^2 + B\beta^2 + C\gamma^2 + D\delta^2$$

$$+ 2F\beta\gamma + 2G\gamma\alpha + 2H\alpha\beta + 2L\alpha\delta + 2M\beta\delta + 2N\gamma\delta = 0,$$

which is the required relation that this plane should touch the surface.

The result of eliminating k, x, y, z, w from the four equations first written, and $\alpha x + \beta y + \gamma z + \delta w = 0$ may evidently be written in the determinant form

$$\begin{vmatrix} \alpha, & \beta, & \gamma, & \delta \\ \alpha, & a, & h, & g, & l \\ \beta, & h, & b, & f, & m \\ \gamma, & g, & f, & c, & n \\ \delta, & l, & m, & n, & d \end{vmatrix} = 0.$$

Each of these is a form in which we may write the condition which must be satisfied by the coordinates of a plane if the plane touch the surface (see Art. 38); that is to say, the tangential

equation of the surface, or the equation of the surface as an envelope of planes.

80. *To find the condition that the surface should be touched by any line*

$$\alpha x + \beta y + \gamma z + \delta w = 0, \quad \alpha' x + \beta' y + \gamma' z + \delta' w = 0.$$

If the line touches, the equation of the tangent plane at the point of contact will be of the form

$$(\alpha + \lambda\alpha') x + (\beta + \lambda\beta') y + \&c. = 0.$$

If then we write in the first four equations of the last article $\alpha + \lambda\alpha'$ for α , &c., and then between these equations and the two equations of the line, eliminate $k, k\lambda, x, y, z, w$, we have the result in the determinant form

$$\begin{vmatrix} \alpha, & \beta, & \gamma, & \delta \\ \alpha', & \beta', & \gamma', & \delta' \\ \alpha, & \alpha', & a, & h, & g, & l \\ \beta, & \beta', & h, & b, & f, & m \\ \gamma, & \gamma', & g, & f, & c, & n \\ \delta, & \delta', & l, & m, & n, & d \end{vmatrix} = 0.$$

This is plainly of the second degree in the coefficients of the quadric, and is also a quadratic function of the determinants $\alpha\beta' - \beta\alpha'$, &c., that is, of the six coordinates of the line.

If in the condition of Art. 79 we write $\alpha + \lambda\alpha'$ for α , &c., and then form the condition that the equation in λ should have equal roots, the result will be the condition as just written multiplied by the discriminant (Ex. 2, Art. 33, *Higher Algebra*). For the two planes which can be drawn through a given line to touch a quadric, will coincide either if the line touches the quadric, or if the surface has a double point.

80a.* *Given the six coordinates of any right line (p, q, r, s, t, u) to determine the coordinates of its polar line (Art. 65).*

* The rest of this chapter may be omitted on first reading.

Since the polar line is the intersection of the polar planes of the two points determining the ray (Art. 57a),

$$U_1'x + U_2'y + U_3'z + U_4'w,$$

$$U_1''x + U_2''y + U_3''z + U_4''w,$$

its coordinates as an axis (Art. 57b) are

$$\pi' = (U_2'U_3''), \quad \kappa' = (U_3'U_1''), \quad \rho' = (U_1'U_2''),$$

$$\sigma' = (U_1'U_4''), \quad \tau' = (U_2'U_4''), \quad \nu' = (U_3'U_4''),$$

Now if we expand

$$(U_2'U_3'') = \left\| \begin{array}{cccc} h, & b, & f, & m \\ g, & f, & c, & n \end{array} \right\| \cdot \left\| \begin{array}{cccc} x', & y', & z', & w' \\ x'', & y'', & z'', & w'' \end{array} \right\|$$

as in Art. 57e, and the others likewise, we get, by a transformation of line coordinates, from the ray coordinates of one line the axial coordinates of its polar line, since all the coefficients are the second minors of a determinant of the fourth order—in this case a symmetrical one, viz. the discriminant of the quadric.

As it is sometimes convenient to have abbreviations to denote these second minors of the discriminant in the determinant form of Art. 67, we shall adopt a double suffix notation, thus writing the axial coordinates or their corresponding ray coordinates in the form

$$\pi' = a_{11}p + a_{12}q + a_{13}r + a_{14}s + a_{15}t + a_{16}u = s',$$

$$\kappa' = a_{21}p + a_{22}q + a_{23}r + a_{24}s + a_{25}t + a_{26}u = t',$$

$$\rho' = a_{31}p + a_{32}q + a_{33}r + a_{34}s + a_{35}t + a_{36}u = u',$$

$$\sigma' = a_{41}p + a_{42}q + a_{43}r + a_{44}s + a_{45}t + a_{46}u = p',$$

$$\tau' = a_{51}p + a_{52}q + a_{53}r + a_{54}s + a_{55}t + a_{56}u = q',$$

$$\nu' = a_{61}p + a_{62}q + a_{63}r + a_{64}s + a_{65}t + a_{66}u = r'.^*$$

Now, if we multiply these equations in order by $p, q, r,$

* The following are the values of the coefficients $a_{11}, a_{12},$ &c. as they stand in the above equations :

$$\begin{array}{cccccccc} bc - f^2, & fg - ch, & hf - bg, & hn - gm, & bn - fm, & fn - cm, \\ fg - ch, & ca - g^2, & gh - af, & gl - an, & fl - hn, & cl - gn, \\ hf - bg, & gh - af, & ab - h^2, & am - hl, & hm - bl, & gm - fl, \\ hn - gm, & gl - an, & am - hl, & ad - l^2, & hd - ml, & gd - nl, \\ bn - fm, & fl - hn, & hm - bl, & hd - ml, & bd - m^2, & fd - nm, \\ fn - cm, & cl - gn, & gm - fl, & gd - nl, & fd - nm, & cd - n^2. \end{array}$$

s, t, u and add, the quantity on the right side vanishes if the line intersect its polar line (57c); but this happens only when the given line is a tangent to one of the plane sections through itself, that is, when it touches the surface. In this case, therefore, each of the lines touches the surface in their common point.

Thus the condition that the right line should touch is

$$a_{11}p^2 + \&c. + a_{66}u^2 + 2a_{12}pq + \dots + 2a_{56}tu = 0, \text{ or briefly } \Psi = 0.$$

This can also be derived from the condition in Art. 78, which may be written

$$\left\| \begin{matrix} U'_1 & U'_2 & U'_3 & U'_4 \\ U''_1 & U''_2 & U''_3 & U''_4 \end{matrix} \right\| \cdot \left\| \begin{matrix} x' & y' & z' & w' \\ x'' & y'' & z'' & w'' \end{matrix} \right\| = 0,$$

and reduced by the process of this article, the quantity on the left is found to be Ψ .

80b. The same problem may be treated as follows if the right line be given as the intersection of two planes

$$\alpha x + \beta y + \gamma z + \delta w, \quad \alpha' x + \beta' y + \gamma' z + \delta' w.$$

Forming the coordinates of the right line joining their poles (Art. 79) we have, for instance, omitting a common multiplier,

$$p' = \left\| \begin{matrix} H & B & F & M \\ G & F & C & N \end{matrix} \right\| \cdot \left\| \begin{matrix} \alpha & \beta & \gamma & \delta \\ \alpha' & \beta' & \gamma' & \delta' \end{matrix} \right\|,$$

which we may write

$$\begin{aligned} p' &= \alpha_{11}\pi + \alpha_{12}\kappa + \alpha_{13}\rho + \alpha_{14}\sigma + \alpha_{15}\tau + \alpha_{16}v = \sigma', \\ q' &= \&c. &= \tau', \&c., \end{aligned}$$

where $BC - F^2 = \alpha_{11}$, &c. But, *Higher Algebra*, Art. 33, this $= \Delta(ad - l^2) = \Delta a_{44}$, and so for each of the others. We thus see how to solve the six equations in the last article. To find p , for instance, we must multiply in order by a_{44} , a_{64} , a_{64} , a_{14} , a_{24} , a_{34} , and add; this gets

$$\begin{aligned} &a_{14}\sigma' + a_{24}\tau' + a_{34}v' + a_{44}\pi' + a_{54}\kappa' + a_{64}\rho' = \Delta p \\ &= a_{14}p' + a_{24}q' + a_{34}r' + a_{44}s' + a_{54}t' + a_{64}u'. \end{aligned}$$

As before, this right line (axis) meets the polar right line

(axis) when each touches the surface; thus the relation that this may happen may be written in any of the forms

$$\alpha_{11}\pi^2 + \dots + \alpha_{66}v^2 + 2\alpha_{12}\pi\kappa + \dots + 2\alpha_{56}\tau v = 0,$$

$$a_{11}p'^2 + a_{44}s'^2 + \dots + 2a_{12}p'q' + \dots + \dots = 0,$$

or
$$a_{44}\pi'^2 + a_{11}\sigma'^2 + \dots + 2a_{12}\sigma'\tau' + \dots + \dots = 0.$$

80c. To determine the points of contact of tangent planes through the line (p, q, r, s, t, u) to the quadric.

The coordinates of the plane determined by three points $xyzw, x_1y_1z_1w_1, x_2y_2z_2w_2$ are found by solving between the equations

$$ax + by + cz + dw = 0,$$

$$ax_1 + by_1 + cz_1 + d_1w = 0,$$

$$ax_2 + by_2 + cz_2 + d_2w = 0,$$

and with θ an undetermined multiplier we may write them, introducing the coordinates p, q, r, s, t, u of the line 1, 2

$$yu - zt + wp = \theta a,$$

$$-xu + zs + wq = \theta b,$$

$$xt - ys + wr = \theta c,$$

$$xp + yq + zr = -\theta d.$$

These may be regarded as equations determining the coordinates of any plane passing through the right line by means of the coordinates of any definite point not upon the right line, through which the plane is to pass.

Now if in the equations just written we assume that $a : b : c : d$ are the values of $U_1 : U_2 : U_3 : U_4$ for the point; this amounts to enquiring what is the point whose polar plane passes through the point itself and through the given right line. In other words, the point of contact of a tangent plane through the given line.

Thus, by eliminating x, y, z, w we get, to determine θ , the biquadratic

$$\begin{vmatrix} \theta a & , & \theta h - u, & \theta g + t, & \theta l - p \\ \theta h + u, & \theta b & , & \theta f - s, & \theta m - q \\ \theta g - t, & \theta f + s, & \theta c & , & \theta n - r \\ \theta l + p, & \theta m + q, & \theta n + r, & \theta d & \end{vmatrix} = 0,$$

which evidently reduces to a pure quadratic, and this is found

to be $\theta^2\Delta + \Psi = 0$. Substituting θ from this equation, we determine the coordinates x, y, z, w of the point of contact by solving between any three of the four following equations

$$\begin{aligned} \theta a \cdot x + (\theta h - u) y + (\theta g + t) z + (\theta l - p) w &= 0, \\ (\theta h + u) x + \&c. &= 0, \&c. \end{aligned}$$

The two points of contact arise from the double sign

$$\theta \sqrt{(\Delta)} = \pm \sqrt{(-\Psi)}.$$

Now if we solve the quadratic of Art. 75 we find under the radical the quantity, $-\Psi$, as noticed in Art. 80a. Hence we may draw the following inferences as to the reality of the intersections of a right line with a quadric, and of the tangent planes which may be drawn through it, viz. we have taking Δ positive, Ψ positive; intersections imaginary, contacts imaginary; for Δ positive, Ψ negative; intersections real, contacts real; for Δ negative, Ψ positive; intersections imaginary, contacts real; for Δ negative, Ψ negative; intersections real, contacts imaginary. As the contacts coincide if $\Psi = 0$ this establishes once more the relation that the line may touch.

80d. We have thus found that whether considered as a ray or as an axis the coordinates of any line touching a surface of the second degree satisfy a relation of the second order. We saw already (Art. 57c) that in like manner the coordinates of any line which meets a given line satisfy a relation of the first order. But in neither case is the relation the most general one of its order which can subsist between those six coordinates. In fact, we saw that instead of the coordinates of the fixed right line being perfectly arbitrary, the universal relation of line coordinates must subsist between them. And again, the relation of the second degree just found instead of containing the full number (21) of independent constants, has that number of coefficients indeed, but all of them are functions of the 10 coefficients in the equation of the quadric surface touched.

Plücker has applied the term *complex of lines* to the entire system of lines which satisfy a single relation. In the case of the complex of lines which satisfy a homogeneous relation of the first degree between the six ray coordinates of a line, by

supposing fixed one of the points determining any ray, we evidently get the equation of a plane through that point. If we replace the ray coordinates by the axial coordinates, on supposing one of the planes determining the line fixed, we have the equation of a point in that plane. In like manner, for a relation of the second degree, the ray coordinates give, for a fixed point, a cone of the second degree with the fixed point as vertex, and, the axial coordinates, taking a fixed plane through the axis, give a conic section in that plane. In particular if the relation be that establishing contact between the right line and a quadric surface, the cone becomes the tangent cone from the special point, and the conic the conic of intersection of the special plane.

80e. *To find the conditions that a right line be wholly contained in the surface.*

It should be observed that whereas in plane quadrics we cannot have in the quadratic of Art. 75 each of the coefficients zero without a certain relation holding between the coefficients of the conic, in quadric surfaces the vanishing of those coefficients implies no such relation. In fact, if we write down $U' = 0, P = 0, U'' = 0$ in full, as

$$U_1' x' + U_2' y' + U_3' z' + U_4' w' = 0,$$

$$U_1' x'' + U_2' y'' + U_3' z'' + U_4' w'' = 0,$$

$$U_1'' x' + U_2'' y' + U_3'' z' + U_4'' w' = 0,$$

$$U_1'' x'' + U_2'' y'' + U_3'' z'' + U_4'' w'' = 0,$$

we see (as in Art. 57b) that they imply only the identity of the line joining the two points with its polar line. Thus as the quadratic in $\lambda : \mu$ is now indeterminate the line is wholly contained in the surface.

We noticed (Art. 80a) regarding the condition for contact that $\Psi = U' U'' - P^2$. Hence, differentiating Ψ in succession with regard to each of the coefficients of the quadric, as each result is of the form $\theta U' + \phi U'' + \chi P$, we see, that for a line to be wholly contained in the quadric, its coordinates satisfy each of the ten relations $\frac{d\Psi}{da} = 0$, &c., $\frac{d\Psi}{df} = 0$, &c., and these amount to no more than three independent relations.

CHAPTER V.

CLASSIFICATION OF QUADRICS.

81. OUR object in this chapter is the reduction of any equation of the second degree in three variables to the simplest form of which it is susceptible, and the classification of the different surfaces which it is capable of representing.

Let us commence by supposing the quantity which we called D (Art. 67) *not* to be $= 0$. By transforming the equation to parallel axes through the centre, the coefficients l, m, n are made to vanish, and the equation becomes

$$ax^2 + by^2 + cz^2 + 2fyz + 2gzx + 2hxy + d' = 0,$$

where d' is the result of substituting the coordinates of the centre in the equation of the surface. Remembering that

$$U' = x'U'_1 + y'U'_2 + z'U'_3 + w'U'_4,$$

and that the coordinates of the centre make U'_1, U'_2, U'_3 vanish, it is easy to calculate that

$$d' = \frac{lL + mM + nN + dD}{D} = \frac{\Delta}{D},$$

where Δ, D, L, M, N have the same meaning as in Art. 67.

82. Having by transformation to parallel axes made the coefficients of x, y, z vanish, we can next make the coefficients of $yz, zx,$ and xy vanish by changing the direction of the axes, retaining the new origin; and so reduce the equation to the form

$$a'x^2 + b'y^2 + c'z^2 + d' = 0.$$

It is easy to shew from Art. 17 that we have constants enough at our disposal to effect this reduction, but the method we shall follow is the same as that adopted, *Conics*, Art. 157,

namely, to prove that there are certain functions of the coefficients which remain unaltered when we transform from one rectangular system to another, and by the help of these relations to obtain the actual values of the new a, b, c .

Let us suppose that by using the most general transformation which is of the form

$$x = \lambda\bar{x} + \mu\bar{y} + \nu\bar{z}, \quad y = \lambda'\bar{x} + \mu'\bar{y} + \nu'\bar{z}, \quad z = \lambda''\bar{x} + \mu''\bar{y} + \nu''\bar{z},$$

the function $ax^2 + by^2 + cz^2 + 2fyz + 2gzx + 2hxy$

becomes $a'\bar{x}^2 + b'\bar{y}^2 + c'\bar{z}^2 + 2f'\bar{y}\bar{z} + 2g'\bar{z}\bar{x} + 2h'\bar{x}\bar{y}$,

which we write for shortness $U = \bar{U}$. And if both systems of coordinates be rectangular, we must have

$$x^2 + y^2 + z^2 = \bar{x}^2 + \bar{y}^2 + \bar{z}^2,$$

which we write for shortness $S = \bar{S}$. Then if k be any constant, we must have $kS - U = k\bar{S} - \bar{U}$. Now if the first side be resolvable into factors, so must also the second. The discriminants of $kS - U$ and of $k\bar{S} - \bar{U}$ must therefore vanish for the same values of k . But the first discriminant is

$$k^3 - k^2(a + b + c) + k(bc + ca + ab - f^2 - g^2 - h^2) - (abc + 2fgh - af^2 - bg^2 - ch^2).$$

Equating, then, the coefficients of the different powers of k to the corresponding coefficients in the second, we learn that if the equation be transformed from one set of rectangular axes to another, we must have

$$a + b + c = a' + b' + c',$$

$$bc + ca + ab - f^2 - g^2 - h^2 = b'c' + c'a' + a'b' - f'^2 - g'^2 - h'^2,$$

$$abc + 2fgh - af^2 - bg^2 - ch^2 = a'b'c' + 2f'g'h' - a'f'^2 - b'g'^2 - c'h'^2.*$$

83. The above three equations at once enable us to transform the equation so that the new f, g, h shall vanish, since

* There is no difficulty in forming the corresponding equations for oblique coordinates. We should then substitute for S (see Art. 19),

$$x^2 + y^2 + z^2 + 2yz \cos \lambda + 2zx \cos \mu + 2xy \cos \nu,$$

and proceeding exactly as in the text, we should form a cubic in k , the coefficients of which would bear to each other ratios unaltered by transformation.

they determine the coefficients of the cubic equation whose roots are the new a, b, c . This cubic is then

$$*a'^3 - (a + b + c)a'^2 + (bc + ca + ab - f^2 - g^2 - h^2)a' - (abc + 2fgh - af^2 - bg^2 - ch^2) = 0,$$

which may also be written

$$(a' - a)(a' - b)(a' - c) - f^2(a' - a) - g^2(a' - b) - h^2(a' - c) - 2fgh = 0.$$

We give here Cauchy's proof that the roots of this equation are all real. The proof of a more general theorem, in which this is included, will be found in *Lessons on Higher Algebra*, Lesson VI.

Let the cubic be written in the form

$$(a' - a) \{ (a' - b)(a' - c) - f^2 \} - g^2(a' - b) - h^2(a' - c) - 2fgh = 0.$$

Let α, β be the values of a' which make $(a' - b)(a' - c) - f^2 = 0$, and it is easy to see that the greater of these roots α is greater than either b or c , and that the less root β is less than either. † Then if we substitute in the given cubic $a' = \alpha$, it reduces to

$$- \{ (\alpha - b)g^2 + 2fgh + (\alpha - c)h^2 \},$$

and since the quantity within the brackets is a perfect square in virtue of the relation $(\alpha - b)(\alpha - c) = f^2$, the result of substitution is essentially negative. But if we substitute $a' = \beta$, the result is

$$(b - \beta)g^2 - 2fgh + (c - \beta)h^2,$$

which is also a perfect square, and positive. Since then, if we substitute $a' = \infty, a' = \alpha, a' = \beta, a' = -\infty$, the results are alternately positive and negative, the equation has three real roots lying within the limits just assigned. The three roots are the coefficients of x^2, y^2, z^2 in the transformed equation, but it is of course arbitrary which shall be the coefficient of x^2 or of y^2 , since we may call whichever axis we please the axis of x .

84. Quadrics are classified according to the signs of the roots of the preceding cubic.

* This is the same cubic as that found, Art. 72, as the reader will easily see ought to be the case.

† We may see this either by actually solving the equation, or by substituting successively $a' = \infty, a' = b, a' = c, a' = -\infty$, when we get results +, -, -, +, shewing that one root is greater than b , and the other less than c .

I. First, let all the roots be positive, and the equation can be transformed to

$$a'x^2 + b'y^2 + c'z^2 + d' = 0.*$$

The surface makes real intercepts on each of the three axes, and if the intercepts be a, b, c , it is easy to see that the equation of the surface may be written in the form

$$\frac{x^2}{a^2} + \frac{y^2}{b^2} + \frac{z^2}{c^2} = 1.$$

As it is arbitrary which axis we take for the axis of x , we suppose the axes so taken that a the intercept on the axis of x may be the longest, and c the intercept on the axis of z may be the shortest.

The equation transformed to polar coordinates is

$$\frac{1}{\rho^2} = \frac{\cos^2 \alpha}{a^2} + \frac{\cos^2 \beta}{b^2} + \frac{\cos^2 \gamma}{c^2},$$

which (remembering that $\cos^2 \alpha + \cos^2 \beta + \cos^2 \gamma = 1$) may be written in either of the forms

$$\begin{aligned} \frac{1}{\rho^2} &= \frac{1}{a^2} + \left(\frac{1}{b^2} - \frac{1}{a^2}\right) \cos^2 \beta + \left(\frac{1}{c^2} - \frac{1}{a^2}\right) \cos^2 \gamma \\ &= \frac{1}{c^2} - \left(\frac{1}{c^2} - \frac{1}{a^2}\right) \cos^2 \alpha - \left(\frac{1}{c^2} - \frac{1}{b^2}\right) \cos^2 \beta, \end{aligned}$$

from which it is easy to see that a is the maximum and c the minimum value of the radius vector. The surface is consequently limited in every direction, and is called an *ellipsoid*.

Every section of it is therefore necessarily also an ellipse.

Thus the section by any plane $z = k$ is $\frac{x^2}{a^2} + \frac{y^2}{b^2} = 1 - \frac{k^2}{c^2}$, and we shall obviously cease to have any real section when k is greater than c . The surface therefore lies altogether between the planes $z = \pm c$. Similarly for the other axes.

If two of the coefficients be equal (for instance, $a = b$), then

† I suppose in what follows that d' ($= \frac{\Delta}{D}$, Art. 81) is negative. If it were positive we should only have to change all the signs in the equation. If it were $= 0$ the surface would represent a cone (Art. 67).

all sections by planes parallel to the plane of xy are circles, and the surface is one of *revolution*, generated by the revolution of an ellipse round its axis major or axis minor, according as it is the two less or the two greater coefficients which are equal. These surfaces are also sometimes called the *prolate* and the *oblate* spheroid.

If all three coefficients be equal, the surface is a sphere.

85. II. Secondly, let one root of the cubic be negative. We may then write the equation in the form

$$\frac{x^2}{a^2} + \frac{y^2}{b^2} - \frac{z^2}{c^2} = 1,$$

where a is supposed greater than b , and where the axis of z evidently does not meet the surface in real points. Using the polar equation

$$\frac{1}{\rho^2} = \frac{\cos^2 \alpha}{a^2} + \frac{\cos^2 \beta}{b^2} - \frac{\cos^2 \gamma}{c^2},$$

it is evident that the radius vector meets the surface or not according as the right-hand side of the equation is positive or negative; and that putting it = 0, (which corresponds to $\rho = \infty$) we obtain a system of radii which separate the diameters meeting the surface from those that do not. We obtain thus the equation of the *asymptotic cone*

$$\frac{x^2}{a^2} + \frac{y^2}{b^2} - \frac{z^2}{b^2} = 0.$$

Sections of the surface parallel to the plane of xy are ellipses; those parallel to either of the other two principal planes are hyperbolas. The equation of the elliptic section by the plane $z = k$ being $\frac{x^2}{a^2} + \frac{y^2}{b^2} = 1 + \frac{k^2}{c^2}$, we see that a real section is found whatever be the value of k , and therefore that the surface is continuous. It is called the *Hyperboloid of one sheet*.

If $a = b$, it is a surface of revolution.

86. III. Thirdly, let two of the roots be negative, and the equation may be written

$$\frac{x^2}{a^2} - \frac{y^2}{b^2} - \frac{z^2}{c^2} = 1.$$

The sections parallel to two principal planes are hyperbolas, while that parallel to the plane of yz is an ellipse

$$\frac{y^2}{b^2} + \frac{z^2}{c^2} = \frac{k^2}{a^2} - 1.$$

It is evident that this will not be real so long as k is within the limits $\pm a$, but that any plane $x = k$ will meet the surface in a real section provided k is outside these limits. No portion of the surface will then lie between the planes $x = \pm a$, but the surface will consist of two separate portions outside these boundary planes. This surface is called the *Hyperboloid of two sheets*. It is of revolution if $b = c$.

By considering the surfaces of revolution, the reader can easily form an idea of the distinction between the two kinds of hyperboloids. Thus, if a common hyperbola revolve round its transverse axis, the surface generated will evidently consist of two separate portions; but if it revolve round the conjugate axis it will consist but of one portion, and will be a case of the hyperboloid of one sheet.

IV. If the three roots of the cubic be negative, the equation

$$\frac{x^2}{a^2} + \frac{y^2}{b^2} + \frac{z^2}{c^2} = -1$$

can evidently be satisfied by no real values of the coordinates.

V. When the absolute term vanishes, we have the cone as a limiting case of the above. Forms I. and IV. then become

$$\frac{x^2}{a^2} + \frac{y^2}{b^2} + \frac{z^2}{c^2} = 0,$$

which can be satisfied by no real values of the coordinates, while forms II. and III. give the equation of the cone in the form

$$\frac{x^2}{a^2} + \frac{y^2}{b^2} - \frac{z^2}{c^2} = 0.$$

The forms already enumerated exhaust all the varieties of central surfaces.

Ex. 1.

$$7x^2 + 6y^2 + 5z^2 - 4yz - 4xy = 6.$$

The discriminating cubic is $a'^3 - 18a'^2 + 99a' - 162 = 0$,

and the transformed equation $x^2 + 2y^2 + 3z^2 = 2$, an ellipsoid.

Ex. 2. $11x^2 + 10y^2 + 6z^2 - 12xy - 8yz + 4zx = 12.$
 Discriminating cubic $a^3 - 27a^2 + 180a' - 324 = 0.$
 Transformed equation $x^2 + 2y^2 + 6z^2 = 4,$ an ellipsoid.

Ex. 3. $7x^2 - 13y^2 + 6z^2 + 24xy + 12yz - 12zx = \pm 84.$
 Discriminating cubic $a^3 - 343a' - 2058 = 0.$
 Transformed equation $x^2 + 2y^2 - 3z^2 = \pm 12,$
 a hyperboloid of one or of two sheets, according to the sign of the last term.

Ex. 4. $2x^2 + 3y^2 + 4z^2 + 6xy + 4yz + 8zx = 8.$
 Discriminating cubic is $a^3 - 9a^2 - 3a' + 20 = 0.$
 By Des Cartes's rule of signs this equation has two positive and one negative root, and therefore represents a hyperboloid of one sheet.

87. Let us proceed now to the case where we have $D = 0.$ In this case we have seen (Art. 69) that it is generally impossible by any change of origin to make the terms of the first degree in the equation to vanish. But it is in general quite indifferent whether we commence, as in Art. 69, by transforming to a new origin, and so remove the coefficients of $x, y, z,$ or whether we first, as in this chapter, transform to new axes retaining the same origin, and so reduce the terms of highest degree to the form $a'x^2 + b'y^2 + c'z^2.$ When $D = 0,$ the first transformation being impossible, we must commence with the latter. And since the absolute term of the cubic of Art. 83 is $D,$ one of its roots, that is to say, one of the three quantities a', b', c' must in this case $= 0.$ The terms of the second degree are therefore reducible to the form $a'x^2 \pm b'y^2.$ This is otherwise evident from the consideration that $D = 0$ is the condition that the terms of highest degree should be resolvable into two real or imaginary factors, in which case they may obviously be also expressed as the difference or sum of two squares. In this way the equation is reduced to the form

$$a'x^2 \pm b'y^2 + 2l'x + 2m'y + 2n'z + d = 0.$$

We can then, by transforming to a new origin, make the coefficients of x and y to vanish, but not that of $z,$ and the equation takes the form

$$a'x^2 \pm b'y^2 + 2n'z + d' = 0.$$

I. If $n' = 0.$ The equation then does not contain $z,$ and therefore (Art. 25) represents a cylinder which is elliptic or hyperbolic, according as a' and b' have the same or different signs. Since the terms of the first degree are absent from

the equation the origin is a centre, but so is also equally every other point on the axis of z , which is called the axis of the cylinder. The possibility of the surface having a line of centres is indicated by both numerator and denominator vanishing in the coordinates of the centre, Art. 69, note.

If it happened that not only n' but also $d' = 0$, the surface would reduce to two intersecting planes.

II. If n' be not $= 0$, we can by a change of origin make the absolute term vanish, and reduce the equation to the form

$$a'x^2 \pm b'y^2 + 2n'z = 0.$$

Let us first suppose the sign of b' to be positive. In this case, while the sections by planes parallel to the planes of xz or yz are parabolas, those parallel to the plane of xy are ellipses, and the surface is called the *Elliptic Paraboloid*. It evidently extends only in one direction, since the section by any plane $z = k$ is $a'x^2 + b'y^2 = -2kn'$, and will not be real unless the right-hand side of the equation is positive. When therefore n' is positive, the surface lies altogether on the negative side of the plane of xy , and when n' is negative, on the positive side.

III. If the sign of b' be negative, the sections by planes parallel to that of xy are hyperbolas, and the surface is called a *Hyperbolic Paraboloid*. This surface extends indefinitely in both directions. The section by the plane of xy is a pair of right lines; the parallel sections above and below this plane are hyperbolas having their transverse axes at right angles to each other, and their asymptotes parallel to the pair of lines in question, the section by the plane of xy forming the transition between the two series of hyperbolas: the form of the surface resembles a saddle or mountain pass.

IV. If $b' = 0$, that is, if *two* roots of the discriminating cubic vanish, the equation takes the form

$$a'x^2 + 2m'y + 2n'z + d = 0,$$

but by changing the axes of y and z in their own plane, and taking for new coordinate planes the plane $m'y + n'z$ and a plane perpendicular to it through the axis of x , the equation

is brought to the form

$$a'x^2 + 2m'y + d = 0,$$

which (Art. 25) represents a cylinder whose base is a parabola.

V. If we have also $m' = 0$, $n' = 0$, the equation $a'x^2 + d = 0$ being resolvable into factors would evidently denote a pair of parallel planes.

88. The actual work of reducing the equation of a paraboloid to the form $a'x^2 + b'y^2 + 2n'z = 0$ is shortened by observing that the discriminant is an invariant; that is to say, a function of the coefficients which is not altered by transformation of coordinates (*Higher Algebra*, Art. 120, also noticing that since we are transforming from one set of rectangular axes to another the modulus of transformation is unity, as seen above Note to Art. 32). Now the discriminant of $a'x^2 + b'y^2 + 2n'z$ is simply $-a'b'n'^2$, which is therefore equal to the discriminant of the given equation. And as a' and b' are known, being the two roots of the discriminating cubic which do not vanish, n' is also known. The calculation of the discriminant is facilitated by observing that it is in this case a perfect square (*Higher Algebra*, Art. 37). Thus let us take the example

$$5x^3 - y^2 + z^2 + 6zx + 4xy + 2x + 4y + 6z = 8.$$

Then the discriminating cubic is $\lambda^3 - 5\lambda^2 - 14\lambda = 0$ whose roots are 0, 7, and -2 . We have therefore $a' = 7$, $b' = -2$. The discriminant in this case is $(l + 2m - 3n)^2$, or putting in the actual values $l = 1$, $m = 2$, $n = 3$ is 16. Hence we have $14n'^2 = 16$, $n' = \frac{4}{\sqrt{(14)}}$, and the reduced equation is $7x^2 - 2y^2 = \frac{8z}{\sqrt{(14)}}$.

If we had not availed ourselves of the discriminant we should have proceeded, as in Art. 72, to find the principal planes answering to the roots 0, 7, -2 of the discriminating cubic, and should have found

$$x + 2y - 3z = 0, \quad 4x + y + 2z = 0, \quad x - 2y - z = 0.$$

Since the new coordinates are the perpendiculars on these planes, we are to take

$4x + y + 2z = X\sqrt{(21)}$, $x - 2y - z = Y\sqrt{(6)}$, $x + 2y - 3z = Z\sqrt{(14)}$,
from which we can express x , y , z in terms of the new coordinates, and the transformed equation becomes

$$7x^2 - 2y^2 + \frac{24x}{\sqrt{(21)}} - 2\sqrt{(6)}y - \frac{8}{\sqrt{(14)}}z = 8,$$

which, finally transformed to parallel axes through a new origin, gives the same reduced equation as before.

If in the preceding example the coefficients l , m , n had been so taken as to fulfil the relation $l + 2m - 3n = 0$, the discriminant would then vanish, but the reduction could be effected with even greater facility, as the terms in x , y , z could then be expressed in the form

$$(4x + y + 2z) + \lambda(x - 2y - z).$$

Thus the equation

$$5x^2 - y^2 + z^2 + 6zx + 4xy + 2x + 2y + 2z = 8$$

may be written in the form

$$(4x + y + 2z)^2 - (x - 2y - z)^2 + 2(4x + y + 2z) - 2(x - 2y - z) = 24,$$

which, transformed as before, becomes

$$21x^2 - 6y^2 + 2x\sqrt{(21)} - 2y\sqrt{(6)} = 24,$$

and the remainder of the reduction presents no difficulty.

CHAPTER VI.

PROPERTIES OF QUADRICS DEDUCED FROM SPECIAL
FORMS OF THEIR EQUATIONS.

CENTRAL SURFACES.

89. WE proceed now to give some properties of central quadrics derived from the equation $\frac{x^2}{a^2} + \frac{y^2}{b^2} + \frac{z^2}{c^2} = 1$. This will include properties of the hyperboloids as well as of the ellipsoid if we suppose the signs of b^2 and of c^2 to be indeterminate.

The equation of the polar plane of the point $x'y'z'$ (or of the tangent plane, if that point be on the surface) is (Art. 63)

$$\frac{xx'}{a^2} + \frac{yy'}{b^2} + \frac{zz'}{c^2} = 1.$$

The length of the perpendicular from the origin on the tangent plane is therefore (Art. 33) given by the equation

$$\frac{1}{p^2} = \frac{x'^2}{a^4} + \frac{y'^2}{b^4} + \frac{z'^2}{c^4}.$$

And the angles α, β, γ which the perpendicular makes with the axes are given by the equations

$$\cos \alpha = \frac{px'}{a^2}, \quad \cos \beta = \frac{py'}{b^2}, \quad \cos \gamma = \frac{pz'}{c^2},$$

as is evident by multiplying the equation of the tangent plane by p , and comparing it with the form

$$x \cos \alpha + y \cos \beta + z \cos \gamma = p.$$

From the preceding equations we can also immediately get an expression for the perpendicular in terms of the angles it makes with the axes, viz.

$$p^2 = a^2 \cos^2 \alpha + b^2 \cos^2 \beta + c^2 \cos^2 \gamma.$$

90. *To find the condition that the plane $ax + \beta y + \gamma z + \delta = 0$ should touch the surface.*

Comparing this with the equation $\frac{xx'}{a^2} + \frac{yy'}{b^2} + \frac{zz'}{c^2} = 1$, we have at once

$$\frac{x'}{a} = -\frac{\alpha\alpha}{\delta}, \quad \frac{y'}{b} = -\frac{b\beta}{\delta}, \quad \frac{z'}{c} = -\frac{c\gamma}{\delta},$$

and the required condition is

$$a^2\alpha^2 + b^2\beta^2 + c^2\gamma^2 = \delta^2.$$

In the same way, the condition that the plane $\alpha x + \beta y + \gamma z$ should touch the cone $\frac{x^2}{a^2} + \frac{y^2}{b^2} - \frac{z^2}{c^2} = 0$ is

$$a^2\alpha^2 + b^2\beta^2 - c^2\gamma^2 = 0.$$

These might also be deduced as particular cases of Art. 79.

91. The normal is a perpendicular to the tangent plane erected at the point of contact. Its equations are obviously

$$\frac{x^2}{x'}(x - x') = \frac{b^2}{y'}(y - y') = \frac{c^2}{z'}(z - z').$$

Let the common value of these be R , then we have

$$x - x' = \frac{Rx'}{a^2}, \quad y - y' = \frac{Ry'}{b^2}, \quad z - z' = \frac{Rz'}{c^2}.$$

Squaring, and adding, we find that the length of the normal between $x'y'z'$, and any point on it xyz is $\pm \frac{R}{p}$. But if xyz be taken as the point where the normal meets the plane of xy , we have $z = 0$, and the last of the three preceding equations gives $R = -c^2$. Hence the length of the intercept on the normal between the point of contact and the plane of xy is $\frac{c^2}{p}$.

92. The sum of the squares of the reciprocals of any three rectangular diameters is constant. This follows immediately from adding the equations

$$\begin{aligned} \frac{1}{\rho^2} &= \frac{\cos^2 \alpha}{a^2} + \frac{\cos^2 \beta}{b^2} + \frac{\cos^2 \gamma}{c^2}, \\ \frac{1}{\rho'^2} &= \frac{\cos^2 \alpha'}{a^2} + \frac{\cos^2 \beta'}{b^2} + \frac{\cos^2 \gamma'}{c^2}, \\ \frac{1}{\rho''^2} &= \frac{\cos^2 \alpha''}{a^2} + \frac{\cos^2 \beta''}{b^2} + \frac{\cos^2 \gamma''}{c^2}, \end{aligned}$$

whence, since $\cos^2 \alpha + \cos^2 \alpha' + \cos^2 \alpha'' = 1$, &c., we have

$$\frac{1}{\rho^2} + \frac{1}{\rho'^2} + \frac{1}{\rho''^2} = \frac{1}{a^2} + \frac{1}{b^2} + \frac{1}{c^2}.$$

93. In like manner the sum of the squares of three perpendiculars on tangent planes, mutually at right angles, is constant, as appears from adding the equations

$$\begin{aligned} p^2 &= a^2 \cos^2 \alpha + b^2 \cos^2 \beta + c^2 \cos^2 \gamma, \\ p'^2 &= a^2 \cos^2 \alpha' + b^2 \cos^2 \beta' + c^2 \cos^2 \gamma', \\ p''^2 &= a^2 \cos^2 \alpha'' + b^2 \cos^2 \beta'' + c^2 \cos^2 \gamma''. \end{aligned}$$

Hence the locus of the intersection of three tangent planes which cut at right angles is a sphere; since the square of its distance from the centre of the surface is equal to the sum of the squares of the three perpendiculars, and therefore to $a^2 + b^2 + c^2$.

CONJUGATE DIAMETERS.

94. The equation of the diametral plane conjugate to the diameter drawn to the point $x'y'z'$ on the surface is

$$\frac{xx'}{a^2} + \frac{yy'}{b^2} + \frac{zz'}{c^2} = 0, \text{ (Art. 70).}$$

It is therefore parallel to the tangent plane at that point. Since any diameter in the diametral plane is conjugate to that drawn to the point $x'y'z'$, it is manifest that when two diameters are conjugate to each other, their direction-cosines are connected by the relation

$$\frac{\cos \alpha \cos \alpha'}{a^2} + \frac{\cos \beta \cos \beta'}{b^2} + \frac{\cos \gamma \cos \gamma'}{c^2} = 0.$$

Since the equation of condition here given is not altered if we write ka^2, kb^2, kc^2 for a^2, b^2, c^2 , it is evident that two lines which are conjugate diameters for any surface $\frac{x^2}{a^2} + \frac{y^2}{b^2} + \frac{z^2}{c^2} = 1$, are also conjugate diameters for any similar surface

$$\frac{x^2}{a^2} + \frac{y^2}{b^2} + \frac{z^2}{c^2} = k.$$

And by making $k = 0$ we see in particular that any surface and its asymptotic cone have common systems of conjugate diameters.

Following the analogy of methods employed in the case of conics, we may denote the coordinates of any point on the ellipsoid by $a \cos \lambda$, $b \cos \mu$, $c \cos \nu$, where λ , μ , ν are the direction-angles of some line; that is to say, are such that $\cos^2 \lambda + \cos^2 \mu + \cos^2 \nu = 1$. In this method the two lines answering to two conjugate diameters are at right angles to each other; for writing $\rho \cos \alpha = a \cos \lambda$, $\rho \cos \alpha' = a \cos \lambda'$, &c., the relation above written becomes

$$\cos \lambda \cos \lambda' + \cos \mu \cos \mu' + \cos \nu \cos \nu' = 0.$$

95. *The sum of the squares of a system of three conjugate semi-diameters is constant.*

For the square of the length of any semi-diameter $x'^2 + y'^2 + z'^2$ is, when expressed in terms of λ , μ , ν ,

$$a^2 \cos^2 \lambda + b^2 \cos^2 \mu + c^2 \cos^2 \nu,$$

which, when added to the sum of

$$a^2 \cos^2 \lambda' + b^2 \cos^2 \mu' + c^2 \cos^2 \nu',$$

$$a^2 \cos^2 \lambda'' + b^2 \cos^2 \mu'' + c^2 \cos^2 \nu'',$$

the whole is equal to $a^2 + b^2 + c^2$; since λ , μ , ν , &c. are the direction angles of three lines mutually at right angles.

96. *The parallelepiped whose edges are three conjugate semi-diameters has a constant volume.*

For if $x'y'z'$, $x''y''z''$, &c. be the extremities of the diameters, the volume is (Art. 32)

$$\begin{vmatrix} x' & y' & z' \\ x'' & y'' & z'' \\ x''' & y''' & z''' \end{vmatrix},$$

or
$$abc \begin{vmatrix} \cos \lambda & \cos \mu & \cos \nu \\ \cos \lambda' & \cos \mu' & \cos \nu' \\ \cos \lambda'' & \cos \mu'' & \cos \nu'' \end{vmatrix},$$

but the value of the last determinant is unity (see note Art. 32); hence the volume of the parallelepiped is abc .

If the axes of any central plane section be a' , b' , and p the perpendicular on the parallel tangent plane, then $a'b'p = abc$.

For if c' be the semi-diameter to the point of contact, and θ the angle it makes with p , the volume of the parallelepiped under the conjugate diameters a', b', c' is $a'b'c' \cos \theta$, but $c' \cos \theta = p$.

97. The theorems just given may also with ease be deduced from the corresponding theorems for conics.

For consider any three conjugate diameters a', b', c' , and let the plane of $a'b'$ meet the plane of xy in a diameter A , and let C be the diameter conjugate to A in the section $a'b'$, then we have $A^2 + C^2 = a'^2 + b'^2$; therefore $a'^2 + b'^2 + c'^2 = A^2 + C^2 + c'^2$. Again, since A is in the plane xy , then if B is the diameter conjugate to A in the section by that plane, the plane conjugate to A will be the plane containing B and containing the axis c , and C, c' are therefore conjugate diameters of the same section as B, c . Hence we have $A^2 + C^2 + c'^2 = A^2 + B^2 + c^2$; and since, finally, $A^2 + B^2 = a^2 + b^2$, the theorem is proved. Precisely similar reasoning proves the theorem about the parallelepipeds.

We might further prove these theorems by obtaining, as in the note, Art. 82, the relations which exist when the quantity $\frac{x^2}{a'^2} + \frac{y^2}{b'^2} + \frac{z^2}{c'^2}$ in oblique coordinates is transformed to $\frac{x^2}{a^2} + \frac{y^2}{b^2} + \frac{z^2}{c^2}$ in rectangular coordinates. These relations are found to be

$$a^2 + b^2 + c^2 = a'^2 + b'^2 + c'^2,$$

$$b^2c^2 + c^2a^2 + a^2b^2 = b'^2c'^2 \sin^2 \lambda + c'^2a'^2 \sin^2 \mu + a'^2b'^2 \sin^2 \nu,$$

$$a^2b^2c^2 = a'^2b'^2c'^2(1 - \cos^2 \lambda - \cos^2 \mu - \cos^2 \nu + 2 \cos \lambda \cos \mu \cos \nu).$$

The first and last equations give the properties already obtained. The second expresses that the sum of the squares of the parallelograms formed by three conjugate diameters, taken two by two, is constant, or that the sum of squares of reciprocals of perpendiculars on tangent planes through three conjugate vertices is constant.

98. *The sum of the squares of the projections of three conjugate diameters on any fixed right line is constant.*

Let the line make angles α, β, γ with the axes, then the projection on it of the semi-diameter terminating in the point $x'y'z'$ is $x' \cos \alpha + y' \cos \beta + z' \cos \gamma$, or, by Art. 94, is

$$a \cos \lambda \cos \alpha + b \cos \mu \cos \beta + c \cos \nu \cos \gamma.$$

Similarly, the others are

$$\begin{aligned} a \cos \lambda' \cos \alpha + b \cos \mu' \cos \beta + c \cos \nu' \cos \gamma, \\ a \cos \lambda'' \cos \alpha + b \cos \mu'' \cos \beta + c \cos \nu'' \cos \gamma; \end{aligned}$$

and squaring and adding, we get the sum of the squares

$$a^2 \cos^2 \alpha + b^2 \cos^2 \beta + c^2 \cos^2 \gamma.$$

99. *The sum of the squares of the projections of three conjugate diameters on any fixed plane is constant.*

If d, d', d'' be the three diameters, $\theta, \theta', \theta''$ the angles made by them with the perpendicular on the plane, the sum of the squares of the three projections is $d^2 \sin^2 \theta + d'^2 \sin^2 \theta' + d''^2 \sin^2 \theta''$, which is constant, since $d^2 \cos^2 \theta + d'^2 \cos^2 \theta' + d''^2 \cos^2 \theta''$ is constant by the last article; and $d^2 + d'^2 + d''^2$ by Art. 95.

100. *To find the locus of the intersection of three tangent planes at the extremities of three conjugate diameters.*

The equations of the three tangent planes are

$$\frac{x}{a} \cos \lambda + \frac{y}{b} \cos \mu + \frac{z}{c} \cos \nu = 1,$$

$$\frac{x}{a} \cos \lambda' + \frac{y}{b} \cos \mu' + \frac{z}{c} \cos \nu' = 1,$$

$$\frac{x}{a} \cos \lambda'' + \frac{y}{b} \cos \mu'' + \frac{z}{c} \cos \nu'' = 1.$$

Squaring and adding, we get for the equation of the locus

$$\frac{x^2}{a^2} + \frac{y^2}{b^2} + \frac{z^2}{c^2} = 3.$$

101. *To find the lengths of the axes of the section made by any plane passing through the centre.*

We can readily form the quadratic, whose roots are the reciprocals of the squares of the axes, since we are given the sum and the product of these quantities. Let α, β, γ be the angles which a perpendicular to the given plane makes with the axes, R the intercept by the surface on this perpendicular; then we have (Art. 92)

$$\frac{1}{a^2} + \frac{1}{b^2} + \frac{1}{R^2} = \frac{1}{a^2} + \frac{1}{b^2} + \frac{1}{c^2},$$

whence $\frac{1}{a'^2} + \frac{1}{b'^2} = \left(\frac{1}{a^2} + \frac{1}{b^2} + \frac{1}{c^2} - \frac{\cos^2\alpha}{a^2} - \frac{\cos^2\beta}{b^2} - \frac{\cos^2\gamma}{c^2} \right)$,

while (Art. 96) $\frac{1}{a'^2 b'^2} = \frac{p^2}{a^2 b^2 c^2} = \frac{\cos^2\alpha}{b^2 c^2} + \frac{\cos^2\beta}{c^2 a^2} + \frac{\cos^2\gamma}{a^2 b^2}$.

The quadratic required is therefore

$$\frac{1}{r^4} - \frac{1}{r^2} \left(\frac{\sin^2\alpha}{a^2} + \frac{\sin^2\beta}{b^2} + \frac{\sin^2\gamma}{c^2} \right) + \frac{\cos^2\alpha}{b^2 c^2} + \frac{\cos^2\beta}{c^2 a^2} + \frac{\cos^2\gamma}{a^2 b^2} = 0.$$

This quadratic may also be written in the form

$$\frac{a^2 \cos^2\alpha}{a^2 - r^2} + \frac{b^2 \cos^2\beta}{b^2 - r^2} + \frac{c^2 \cos^2\gamma}{c^2 - r^2} = 0.$$

This equation may be otherwise obtained from the principles explained in the next article.

102. *Through a given radius OR of a central quadric we can in general draw one section of which OR shall be an axis.*

Describe a sphere with *OR* as radius, and let a cone be drawn having the centre as vertex and passing through the intersection of the surface and the sphere, and let a tangent plane to the cone be drawn through the radius *OR*, then *OR* will be an axis of the section by that plane. For in it *OR* is equal to the next consecutive radius (both being radii of the same sphere) and is therefore a maximum or minimum; or, again, the tangent line at *R* to the section is perpendicular to *OR*, since it is also in the tangent plane to the sphere. *OR* is therefore an axis of the section.

The equation of the cone can at once be formed by subtracting one from the other, the equations

$$\frac{x^2}{a^2} + \frac{y^2}{b^2} + \frac{z^2}{c^2} = 1, \quad \frac{x^2}{r^2} + \frac{y^2}{r^2} + \frac{z^2}{r^2} = 1,$$

when we get

$$x^2 \left(\frac{1}{a^2} - \frac{1}{r^2} \right) + y^2 \left(\frac{1}{b^2} - \frac{1}{r^2} \right) + z^2 \left(\frac{1}{c^2} - \frac{1}{r^2} \right) = 0.$$

If then any plane $x \cos\alpha + y \cos\beta + z \cos\gamma$ have an axis in length = *r*, it must touch this cone, and the condition that it should touch it, is (Art. 90)

$$\frac{a^2 \cos^2\alpha}{a^2 - r^2} + \frac{b^2 \cos^2\beta}{b^2 - r^2} + \frac{c^2 \cos^2\gamma}{c^2 - r^2} = 0,$$

which is the equation found in the last article.

In like manner we can find the axes of any section of a quadric given by an equation of the form

$$ax^2 + by^2 + cz^2 + 2fyz + 2gzx + 2hxy = 1.$$

The cone of intersection of this quadric with any sphere

$$\lambda (x^2 + y^2 + z^2) = 1$$

is $(a - \lambda)x^2 + (b - \lambda)y^2 + (c - \lambda)z^2 + 2fyz + 2gzx + 2hxy = 0$, and we see, as before, that if λ be the reciprocal of the square of an axis of the section by the plane $x \cos \alpha + y \cos \beta + z \cos \gamma$, this plane must touch the cone whose equation has just been given. The condition that the plane should touch this cone (Art. 79) may be written

$$\begin{vmatrix} a - \lambda, & h, & g, & \cos \alpha \\ h, & b - \lambda, & f, & \cos \beta \\ g, & f, & c - \lambda, & \cos \gamma \\ \cos \alpha, & \cos \beta, & \cos \gamma, & \end{vmatrix} = 0,$$

which expanded is

$$\begin{aligned} & \lambda^2 - \lambda \{ (b + c) \cos^2 \alpha + (c + a) \cos^2 \beta + (a + b) \cos^2 \gamma \\ & \quad - 2f \cos \beta \cos \gamma - 2g \cos \gamma \cos \alpha - 2h \cos \alpha \cos \beta \} \\ & + (bc - f^2) \cos^2 \alpha + (ca - g^2) \cos^2 \beta + (ab - h^2) \cos^2 \gamma \\ & + 2(gh - af) \cos \beta \cos \gamma + 2(hf - bg) \cos \gamma \cos \alpha \\ & \quad + 2(fg - ch) \cos \alpha \cos \beta = 0. \end{aligned}$$

CIRCULAR SECTIONS.

103. We proceed to investigate whether it is possible to draw a plane which shall cut a given ellipsoid in a circle. As it has been already proved (Art. 73) that all parallel sections are similar curves, it is sufficient to consider sections made by planes through the centre. Imagine that any central section is a circle with radius r , and conceive a concentric sphere described with the same radius. Then we have just seen that

$$x^2 \left(\frac{1}{a^2} - \frac{1}{r^2} \right) + y^2 \left(\frac{1}{b^2} - \frac{1}{r^2} \right) + z^2 \left(\frac{1}{c^2} - \frac{1}{r^2} \right) = 0$$

represents a cone having the centre for its vertex and passing through the intersection of the quadric and the sphere. But if the surfaces have a plane section common, this equation must necessarily represent two planes, which cannot take place unless the coefficient of either x^2 , y^2 , or z^2 vanish. The plane section must therefore pass through one or other of the three axes. Suppose for example we take $r = b$, the coefficient of y vanishes, and there remains

$$x^2 \left(\frac{1}{a^2} - \frac{1}{b^2} \right) + z^2 \left(\frac{1}{c^2} - \frac{1}{b^2} \right) = 0,$$

which represents two planes of circular section passing through the axis of y .

The two planes are easily constructed by drawing in the plane of xz a semi-diameter equal to b . Then the plane containing the axis of y , and either of the semi-diameters which can be so drawn, is a plane of circular section.

In like manner, two planes can be drawn through each of the other axes, but in the case of the ellipsoid these planes will be imaginary; since we evidently cannot draw in the plane of xy a semi-diameter $= c$, the least semi-diameter in that section being $= b$; nor, again, in the plane of yz a semi-diameter $= a$, the greatest in that section being $= b$.

In the case of the hyperboloid of one sheet, c^2 is negative, and the sections through a are those which are real. In the hyperboloid of two sheets, where both b^2 and c^2 are negative, if we take $r^2 = -c^2$ (b^2 being less than c^2), we get the two real sections,

$$x^2 \left(\frac{1}{a^2} + \frac{1}{c^2} \right) + y^2 \left(\frac{1}{c^2} - \frac{1}{b^2} \right) = 0.$$

These two real planes through the centre do not meet the surface, but parallel planes do meet it in circles. In all cases it will be observed that we have only two real central planes of circular section, the series of planes parallel to each of which afford two different systems of circular sections.

104. Any two surfaces whose coefficients of x^2 , y^2 , z^2 , differ only by a constant, have the same planes of circular section. Thus $Ax^2 + By^2 + Cz^2 = 1$, and $(A + H)x^2 + (B + H)y^2 + (C + H)z^2 = 1$

have the same planes of circular section, as easily appears from the formula in the last article.

The same thing appears by throwing the two equations into the form

$$\frac{1}{\rho^2} = A \cos^2\alpha + B \cos^2\beta + C \cos^2\gamma,$$

$$\frac{1}{\rho^2} = A \cos^2\alpha + B \cos^2\beta + C \cos^2\gamma + H,$$

from which it appears that the difference of the squares of the reciprocals of the corresponding radii vectors of the two surfaces is constant. If then in any section the radius vector of the one surface be constant, so must also the radius vector of the other. The same consideration shews that any plane cuts both in sections having the same axes, since the maximum or minimum value of the radius vector will in each correspond to the same values of α , β , γ .

Circular sections of a cone are the same as those of a hyperboloid to which it is asymptotic.

105. *Any two circular sections of opposite systems lie on the same sphere.*

The two planes of section are parallel each to one of the planes represented by

$$x^2 \left(\frac{1}{a^2} - \frac{1}{r^2} \right) + y^2 \left(\frac{1}{b^2} - \frac{1}{r^2} \right) + z^2 \left(\frac{1}{c^2} - \frac{1}{r^2} \right) = 0.$$

Now since the equation of two planes agrees with the equation of two parallel planes as far as terms of the second degree are concerned, the equation of the two planes must be of the form

$$x^2 \left(\frac{1}{a^2} - \frac{1}{r^2} \right) + y^2 \left(\frac{1}{b^2} - \frac{1}{r^2} \right) + z^2 \left(\frac{1}{c^2} - \frac{1}{r^2} \right) + u_1 = 0,$$

where u_1 represents some plane. If then we subtract this from the equation of the surface, which every point on the section must also satisfy, we get

$$\frac{1}{r^2} (x^2 + y^2 + z^2) - u_1 = 1,$$

which represents a sphere.

106. All parallel sections are, as we have seen, similar. If now we draw a series of planes parallel to circular sections, the extreme one will be the parallel tangent plane which must meet the surface in an infinitely small circle. Its point of contact is called an *umbilic*. Some properties of these points will be mentioned afterwards. The coordinates of the real umbilics are easily found. We are to draw in the section, whose axes are a and c , a semi-diameter $= b$, and to find the coordinates of the extremity of its conjugate. Now the formula for conics $b'^2 = a^2 - e^2 x^2$, applied to this case, gives us

$$b^2 = a^2 - \frac{a^2 - c^2}{a^2} x^2,$$

whence $\frac{x^2}{a^2} = \frac{a^2 - b^2}{a^2 - c^2}$; similarly $\frac{z^2}{c^2} = \frac{b^2 - c^2}{a^2 - c^2}$.

There are accordingly in the case of the ellipsoid four real umbilics in the plane of xz , and four imaginary in each of the other principal planes.

RECTILINEAR GENERATORS.

107. We have seen that when the central section is an ellipse all parallel sections are similar ellipses, and the section by a tangent plane is an infinitely small similar ellipse. In like manner when the central section is a hyperbola, the section by any parallel plane is a similar hyperbola, and that by the tangent plane reduces itself to a pair of right lines parallel to the asymptotes of the central hyperbola. Thus if the equation referred to any conjugate diameters be

$$\frac{x^2}{a'^2} + \frac{y^2}{b'^2} - \frac{z^2}{c'^2} = 1,$$

and we consider the section made by any plane parallel to the plane of xz ($y = \beta$), its equation is

$$\frac{x^2}{a'^2} - \frac{z^2}{c'^2} = 1 - \frac{\beta^2}{b'^2}.$$

And it is evident that the value $\beta = b'$ reduces the section to

a pair of right lines. Such right lines can only exist on the hyperboloid of one sheet,* since if we had the equation

$$\frac{x^2}{a^2} - \frac{y^2}{b^2} = 1 + \frac{z^2}{c^2},$$

the right-hand side of the equation could not vanish for any real value of z . It is also geometrically evident that a right line cannot exist either on an ellipsoid, which is a closed surface, or on a hyperboloid of two sheets, no part of which, as we saw, lies in the space included between several systems of two parallel planes, while any right line will of course in general intersect them all.

108. Throwing the equation of the hyperboloid of one sheet into the form

$$\frac{x^2}{a^2} - \frac{z^2}{c^2} = 1 - \frac{y^2}{b^2},$$

it is evident that the intersection of the two planes

$$\frac{x}{a} - \frac{z}{c} = \lambda \left(1 - \frac{y}{b}\right), \quad \lambda \left(\frac{x}{a} + \frac{z}{c}\right) = \left(1 + \frac{y}{b}\right)$$

lies on the surface; and by giving different values to λ we get a system of right lines lying in the surface; while, again, we get another system by considering the intersection of the planes

$$\frac{x}{a} - \frac{z}{c} = \lambda \left(1 + \frac{y}{b}\right), \quad \lambda \left(\frac{x}{a} + \frac{z}{c}\right) = 1 - \frac{y}{b}.$$

What has been just said may be stated more generally as follows: If $\alpha, \beta, \gamma, \delta$ represent four planes, then the equation $\alpha\gamma = \beta\delta$ represents a hyperboloid of one sheet, which may be generated as the locus of the system of right lines $\alpha = \lambda\beta, \lambda\gamma = \delta$, or of the system $\alpha = \lambda\delta, \lambda\gamma = \beta$.

Considering four lines in either system as $\alpha = \lambda\beta, \lambda\gamma = \delta$, we have two pencils of planes which we see by Art. 39 are equianharmonic; hence the hyperboloid of one sheet may be regarded as the locus of lines of intersection of two homographic pencils of planes.

* It will be understood that the remarks in the text apply only to *real* right lines: *every* quadric surface has upon it an infinity of right lines, real or imaginary, and (not being a cone) it is a skew surface. See footnote, Art. 112.

In the case of the equation

$$\frac{x^2}{a^2} + \frac{y^2}{b^2} - \frac{z^2}{c^2} = 1,$$

the lines may be also expressed by the equations

$$\frac{x}{a} = \frac{z}{c} \cos \theta \mp \sin \theta, \quad \frac{y}{b} = \frac{z}{c} \sin \theta \pm \cos \theta.$$

109. *Any two lines belonging to opposite systems lie in the same plane.*

Consider the two lines

$$\begin{aligned} \alpha - \lambda\beta, \quad \lambda\gamma - \delta, \\ \alpha - \lambda'\delta, \quad \lambda'\gamma - \beta. \end{aligned}$$

Then it is evident that the plane $\alpha - \lambda\beta + \lambda\lambda'\gamma - \lambda'\delta$ contains both, since it can be written in either of the forms

$$\alpha - \lambda\beta + \lambda'(\lambda\gamma - \delta), \quad \alpha - \lambda'\delta + \lambda(\lambda'\gamma - \beta).$$

It is evident in like manner that *no two lines belonging to the same system lie in the same plane.* In fact, no plane of the form $(\alpha - \lambda\beta) + k(\lambda\gamma - \delta)$ can ever be identical with $(\alpha - \lambda'\beta) + k'(\lambda'\gamma - \delta)$ if λ and λ' are different. In the same way we see that both the lines

$$\begin{aligned} \frac{x}{a} = \frac{z}{c} \cos \theta - \sin \theta, \quad \frac{y}{b} = \frac{z}{c} \sin \theta + \cos \theta, \\ \frac{x}{a} = \frac{z}{c} \cos \phi + \sin \phi, \quad \frac{y}{b} = \frac{z}{c} \sin \phi - \cos \phi, \end{aligned}$$

which belong to different systems, lie in the plane

$$\frac{x}{a} \cos \frac{1}{2}(\theta + \phi) + \frac{y}{b} \sin \frac{1}{2}(\theta + \phi) = \frac{z}{c} \cos \frac{1}{2}(\theta - \phi) - \sin \frac{1}{2}(\theta - \phi).$$

Now this plane is parallel to the second line of the first system

$$\frac{x}{a} = \frac{z}{c} \cos \phi - \sin \phi, \quad \frac{y}{b} = \frac{z}{c} \sin \phi + \cos \phi,$$

but it does not pass through it, for the equation of a parallel plane through this line will be found to be

$$\frac{x}{a} \cos \frac{1}{2}(\theta + \phi) + \frac{y}{b} \sin \frac{1}{2}(\theta + \phi) = \frac{z}{c} \cos \frac{1}{2}(\theta - \phi) + \sin \frac{1}{2}(\theta - \phi),$$

which differs in the absolute term from the equation of the plane through the first line.

110. We have seen that any tangent plane to the hyperboloid meets the surface in two right lines intersecting in the point of contact, and of course touches the surface in no other point. If through one of these right lines we draw any *other* plane, we have just seen that it will meet the surface in a new right line, and this new plane will touch the surface in the point where these two lines intersect. Conversely, the tangent plane to the surface at any point on a given right line in the surface will contain the right line, but the tangent plane will in general be different for every point of the right line. Thus, take the surface $x\phi = y\psi$, where the line xy lies on the surface, and ϕ and ψ represent planes (though the demonstration would equally hold if they were functions of any higher degree). Then using the equation of the tangent plane

$$(x - x') U'_1 + (y - y') U'_2 + (z - z') U'_3 = 0,$$

and seeking the tangent at the point $x = 0, y = 0, z = z'$, we find $x\phi' = y\psi'$, where ϕ' and ψ' are what ϕ and ψ become on substituting these coordinates. And this plane will vary as z' varies.

It is easy also to deduce from this that the anharmonic ratio of four tangent planes passing through a right line in the surface is equal to that of their four points of contact along the line.

All this is different in the case of the cone. Here every tangent plane meets the surface in two coincident right lines. The tangent plane then at every point of this right line is the same, and the plane touches the surface along the whole length of the line.

And generally, if the equation of a surface be of the form

$$x\phi + y^2\psi = 0,$$

it is seen precisely, as above, that the tangent plane at every point of the line xy is $x = 0$.

111. It was proved (Art. 107) that the two lines in which the tangent plane cuts a hyperboloid are parallel to the asymptotes of the parallel central section; but these asymptotes are evidently edges of the asymptotic cone to the surface. Hence

every right line which can lie on a hyperboloid is parallel to some one of the edges of the asymptotic cone. It follows also that three of these lines (unless two of them are parallel) cannot all be parallel to the same plane; since, if they were, a parallel plane would cut the asymptotic cone in three edges, which is impossible, the cone being only of the second degree.

112. We have seen that any line of the first system meets all the lines of the second system. Conversely, the surface may be conceived as generated by the motion of a right line which always meets a certain number of fixed right lines.*

Let us remark, in the first place, that when we are seeking the surface generated by the motion of a right line, it is necessary that the motion of the right line should be regulated by *three* conditions. In fact, since the equations of a right line include four constants, four conditions would absolutely determine the position of a right line. When we are given one condition less, the position of the line is not determined, but it is so far limited that the line will always lie on a certain surface-locus, whose equation can be found as follows: Write down the general equations of a right line $x = mz + p$, $y = nz + q$; then the conditions of the problem establish three relations between the constants m, n, p, q . And combining these three relations with the two equations of the right line, we have five equations from which we can eliminate the four quantities m, n, p, q ; and the resulting equation in x, y, z will be the equation of the locus required. Or, again, we may write the equations of the line in the form

$$\frac{x - x'}{\cos \alpha} = \frac{y - y'}{\cos \beta} = \frac{z - z'}{\cos \gamma},$$

then the three conditions give three relations between the constants $x', y', z', \alpha, \beta, \gamma$, and if between these we eliminate α, β, γ , the resulting equation in x', y', z' is the equation of the required locus, since $x'y'z'$ may be any point on the line.

* A surface generated by the motion of a right line is called a *ruled* surface. If every generating line is intersected by the next consecutive one, the surface is called a *developable* or *torse*. If not, it is called a *skew* surface or *scroll*. The hyperboloid of one sheet, and indeed every quadric surface (not being a cone or cylinder) belongs to the latter class; the cone and cylinder to the former.

We see then, that it is a determinate problem to find the surface generated by a right line which moves so as always to meet *three* fixed right lines.* For, expressing, by Art. 41, the condition that the moveable right line shall meet each of the fixed lines, we obtain the three necessary relations between m, n, p, q . Geometrically also we can see that the motion of the line is completely regulated by the given conditions. For a line would be completely determined if it were constrained to pass through a given point and to meet two fixed lines, since we need only draw planes through the given point and each of the fixed lines, when the intersection of these planes would determine the line required. If, then, the point through which the line is to pass, itself moves along a third fixed line, we have a determinate series of right lines, the assemblage of which forms a surface-locus.

113. Let us then solve the problem suggested by the last article, viz. to find the surface generated by a right line which always meets three fixed right lines, no two of which are in the same plane. In order that the work may be shortened as much as possible, let us first examine what choice of axes we must make in order to give the equations of the fixed right lines the simplest form.

And it occurs at once that we ought to take the axes, one parallel to each of the three given right lines.† The only question then is, where the origin can most symmetrically be placed. Suppose now, that through each of the three right lines we draw planes parallel to the other two, we get thus three pairs of parallel planes forming a parallelopiped, of which the given lines will be edges. And if through the centre of this parallelopiped we draw lines parallel to these edges, we shall have the most symmetrical axes. Let then the equations of the three pairs of planes be

$$x = \pm a, \quad y = \pm b, \quad z = \pm c,$$

* Or three fixed curves of any kind.

† We could not do this indeed if the three given right lines happened to be all parallel to the same plane. This case will be considered in the next section. It will not occur when the locus is a hyperboloid of one sheet, see Art. 111.

then the equations of the three fixed right lines will be

$$y = b, z = -c; z = c, x = -a; x = a, y = -b.$$

The equations of any line meeting the first two fixed lines are

$$z + c = \lambda (y - b); z - c = \mu (x + a),$$

which will intersect the third if $c + \mu a + \lambda b = 0$; or replacing for λ and μ their values,

$$c(x + a)(y - b) + a(z - c)(y - b) + b(z + c)(x + a),$$

which reduced is

$$ayz + bzx + cxy + abc = 0.$$

On applying the criterion of Art. 86, this is found to represent a hyperboloid of one sheet, as is otherwise evident, since it represents a central quadric, and is known to be a ruled surface. The problem might otherwise be solved thus:

Assuming for the equations of the moveable line

$$\frac{x - x'}{\cos \alpha} = \frac{y - y'}{\cos \beta} = \frac{z - z'}{\cos \gamma},$$

the following three conditions are obtained by expressing that this intersects each of the fixed lines,

$$\frac{y' - b}{\cos \beta} = \frac{z' + c}{\cos \gamma}, \quad \frac{z' - c}{\cos \gamma} = \frac{x' + a}{\cos \alpha}, \quad \frac{x' - a}{\cos \alpha} = \frac{y' + b}{\cos \beta}.$$

We can eliminate α, β, γ by multiplying the equations together, and get for the equation of the locus,

$$(x - a)(y - b)(z - c) = (x + a)(y + b)(z + c),$$

which reduces to $ayz + bzx + cxy + abc = 0$ the same equation as before.

The last written form of the equation expresses that this hyperboloid is the locus of a point, the product of whose distances from three concurrent faces of a parallelepiped is equal to the product of its distances from the three opposite faces.

The following is another general solution of the same problem: Let the first two lines be the intersections of the planes α, β ; γ, δ ; then the equations of the third can be expressed in the form $\alpha = A\gamma + B\delta$, $\beta = C\gamma + D\delta$. The moveable line, since it meets the first two lines, can be expressed by two equations of the form $\alpha = \lambda\beta$, $\gamma = \mu\delta$. Substituting these values in the

equations of the third line, we find the condition that it and the moveable line should intersect, viz.

$$A\mu + B = \lambda (C\mu + D).$$

And eliminating λ and μ between this and the equations of the moveable line, we get for the equation of the locus,

$$\beta (A\gamma + B\delta) = a (C\gamma + D\delta).$$

A third general solution is as follows: taking $(p_1, q_1, r_1, s_1, t_1, u_1), (p_2, \dots), (p_3, \dots)$ as the six coordinates of the given lines respectively, and writing for shortness (pqr) to denote the determinant $p_1^*(q_2r_3 - q_3r_2) + \&c.$, and so in other cases, then it can be shewn that the equation of the hyperboloid passing through the three given lines is

$$\begin{aligned} & (ptu)x^2 + (qus)y^2 + (rst)z^2 + (pqr)w^2 \\ & + [(pqt) - (rpu)]xw + [(qst) + (rus)]yz \\ & + [(qru) - (pqs)]yw + [(rtu) + (pst)]zx \\ & + [(rps) - (qrt)]zw + [(pus) + (qtu)]xy = 0. \end{aligned}$$

114. *Four right lines belonging to one system cut all lines belonging to the other system in a constant anharmonic ratio.*

For through the four lines and through any line which meets them all we can draw four planes; and therefore any other line which meets the four lines will be divided in a constant anharmonic ratio (Art. 39).

Conversely, if two non-intersecting lines are divided *homographically* in a series of points, that is to say, so that the anharmonic ratio of any four points on one line is equal to that of the corresponding points on the other, then the lines joining corresponding points will be generators of a hyperboloid of one sheet.

Let the two given lines be $\alpha, \beta; \gamma, \delta$. Let any fixed line which meets them both be $\alpha = \lambda'\beta, \gamma = \mu'\delta$; then, in order that any other line $\alpha = \lambda\beta, \gamma = \mu\delta$ should divide them homographically, we must have (Conics, Art. 57) $\frac{\lambda}{\lambda'} = \frac{\mu}{\mu'}$, and if we eliminate λ between the equations $\alpha = \lambda\beta, \lambda'\gamma = \mu'\lambda\delta$, the result is $\lambda'\beta\gamma = \mu'\alpha\delta$.

NON-CENTRAL SURFACES.

115. The reader is recommended to work out for himself the properties of paraboloids which are analogous to the results

of the preceding articles of this chapter. In particular he may show* that:—

The sum or difference of the principal parameters of any two conjugate diametral sections of a paraboloid is constant according as it is elliptic or hyperbolic.

The sum or difference of the parameters of any two conjugate diametral sections at a given point of a paraboloid is constant, according as it is elliptic or hyperbolic.

If from the extremity of any diameter of a paraboloid a line of constant length be measured and a conjugate plane drawn cutting the paraboloid, the volume under any two conjugate diameters of the section and this line is constant.

We proceed to determine the circular sections of the paraboloid given by the equation

$$\frac{x^2}{a^2} \pm \frac{y^2}{b^2} = \frac{2z}{c}.$$

Consider a circular section through the origin, and describe a sphere through it having, at the origin, the same tangent plane (z) as the paraboloid; then (Art. 61) the equation of the sphere must be of the form

$$x^2 + y^2 + z^2 = 2nz.$$

And the cone of intersection of this sphere with the paraboloid is

$$x^2 \left(1 - \frac{cn}{a^2}\right) + y^2 \left(1 \mp \frac{cn}{b^2}\right) + z^2 = 0.$$

This will represent two planes if one of the terms vanishes. It will represent two real planes in the case of the elliptic paraboloid, if we take $\frac{cn}{a^2} = 1$, for the equation then becomes $b^2z^2 = (a^2 - b^2)y^2$. But in the case of the hyperbolic paraboloid there is no real circular section, since the same substitution would make the equation of the two planes take the imaginary form $b^2z^2 + (a^2 + b^2)y^2 = 0$.

Indeed, it can be proved in general that no section of the hyperbolic paraboloid can be a closed curve, for if we take its intersection with any plane $z = \alpha x + \beta y + \gamma$, the projection on

* See Professor Allman, On some Properties of the Paraboloids, *Quarterly Journal of Pure and Applied Mathematics*, 1874.

the plane of xy is $\frac{x^2}{a^2} - \frac{y^2}{b^2} = \frac{2(\alpha x + \beta y + \gamma)}{c}$ which is necessarily a hyperbola.

116. From the general theory explained in Art. 108, it is plain that the hyperbolic paraboloid may also have right lines lying altogether in the surface. For the equation $\frac{x^2}{a^2} - \frac{y^2}{b^2} = \frac{z}{c}$ (Art. 87) is included in the general form $\alpha\gamma = \beta\delta$, and the surface contains the two systems of right lines

$$\frac{x}{a} \pm \frac{y}{b} = \lambda, \quad \lambda \left(\frac{x}{a} \mp \frac{y}{b} \right) = \frac{z}{c}.$$

The first equation shews that every line on the surface must be parallel to one or other of the two fixed planes $\frac{x}{a} \pm \frac{y}{b} = 0$; and in this respect is the fundamental difference between right lines on the paraboloid and on the hyperboloid (see Art. 111).

It is proved, as in Art. 109, that any line of one system meets every line of the other system, while no two lines of the same system can intersect.

We give now the investigation of the converse problem, viz. to find the surface generated by a right line which always meets three fixed lines which are all parallel to the same plane. Let the plane to which all are parallel be taken for the plane of xy , any line which meets all three for the axis of z , and let the axes of x and y be taken parallel to two of the fixed lines. Then their equations are

$$x = 0, \quad z = a; \quad y = 0, \quad z = b; \quad x = my, \quad z = c.$$

The equations of any line meeting the first two fixed lines are

$$x = \lambda(z - a), \quad y = \mu(z - b),$$

which will intersect the third if

$$\lambda(c - a) = m\mu(c - b),$$

and the equation of the locus is

$$(\alpha - c)x(z - b) = m(b - c)y(z - a),$$

which represents a hyperbolic paraboloid, since the terms of highest degree break up into two real factors.

In like manner we might investigate the surface generated by a right line which meets *two* fixed lines and is always parallel to a fixed plane. Let it meet the lines

$$x = 0, z = a; y = 0, z = -a,$$

and be parallel to the plane

$$x \cos \alpha + y \cos \beta + z \cos \gamma = p.$$

Then the equations of the line are

$$x = \lambda (z - a), y = \mu (z + a),$$

which will be parallel to the given plane if

$$\cos \gamma + \lambda \cos \alpha + \mu \cos \beta = 0.$$

The equation of the required locus is therefore

$$\cos \gamma (z^2 - a^2) + x \cos \alpha (z + a) + y \cos \beta (z - a) = 0,$$

which is a hyperbolic paraboloid, since the terms of the second degree break up into two real factors.

A hyperbolic paraboloid is the limit of the hyperboloid of one sheet, when the generator in one of its positions may lie altogether at infinity.

We have seen (Art. 107) that a plane is a tangent to a surface of the second degree when it meets it in two real or imaginary lines; and (Art. 87) that a paraboloid is met by the plane at infinity in two real or imaginary lines. Hence a paraboloid is always touched by the plane at infinity.

117. In the case of the hyperbolic paraboloid any three right lines of one system cut all the right lines of the other in a constant ratio. For since the generators are all parallel to the same plane, we can draw, through any three generators, parallels to that plane, and all right lines which meet three parallel planes are cut by them in a constant ratio.

Conversely, if two finite non-intersecting lines be divided, each into the same number of equal parts, the lines joining corresponding points will be generators of a hyperbolic paraboloid. By doing this with threads, the form of this surface can be readily exhibited to the eye.

To prove this directly, let the line which joins two corresponding extremities of the given lines be the axis of z ; let

the axes of x and y be taken parallel to the given lines, and let the plane of xy be half-way between them. Let the lengths of the given lines be a and b , then the coordinates of two corresponding points are

$$\begin{aligned} z = c, \quad x = \mu a, \quad y = 0, \\ z = -c, \quad x = 0, \quad y = \mu b, \end{aligned}$$

and the equations of the line joining these points are

$$\frac{x}{a} + \frac{y}{b} = \mu, \quad 2cx - \mu az = \mu ac,$$

whence, eliminating μ , the equation of the locus is

$$2cx = a(z + c) \left(\frac{x}{a} + \frac{y}{b} \right),$$

which represents a hyperbolic paraboloid.

SURFACES OF REVOLUTION.

118. Let it be required to find the conditions that the general equation should represent a surface of revolution. In this case the equation can be reduced (see Art. 84), if the surface be central, to the form $\frac{x^2}{a^2} + \frac{y^2}{a^2} \pm \frac{z^2}{c^2} = \pm 1$, and if the surface be non-central to the form $\frac{x^2}{a^2} + \frac{y^2}{a^2} = \frac{2z}{c}$. In either case then when the highest terms are transformed so as to become the sum of squares of three rectangular coordinates, the coefficients of two of those squares are equal. It would appear then that the required condition could be at once obtained by forming the condition that the discriminating cubic should have equal roots. Since, however, the roots of the discriminating cubic are always real, its discriminant can be expressed as the sum of squares (see *Higher Algebra*, Art. 44), and will not vanish (the coefficients of the given equation being supposed to be real) unless *two* conditions are fulfilled, which can be obtained more easily by the following process. We want to find whether it is possible so as to transform the equation as to have

$$ax^2 + by^2 + cz^2 + 2fyz + 2gzx + 2hxy = A(X^2 + Y^2) + CZ^2,$$

but we have (Art. 19)

$$x^2 + y^2 + z^2 = X^2 + Y^2 + Z^2.$$

It is manifest then that by taking $\lambda = A$, we should have the following quantity a perfect square :

$$(ax^2 + by^2 + cz^2 + 2fyz + 2gzx + 2hxy) - \lambda (x^2 + y^2 + z^2),$$

and it is required to find the conditions that this should be possible.

Now it is easy to see that when

$$Ax^2 + By^2 + Cz^2 + 2Fyz + 2Gzx + 2Hxy$$

is a perfect square, the six following conditions are fulfilled :*

$$\begin{aligned} BC = F^2, \quad CA = G^2, \quad AB = H^2, \\ AF = GH, \quad BG = HF, \quad CH = FG; \end{aligned}$$

the three former of which are included in the three latter. In the present case then these latter three equations are

$$(a - \lambda)f = gh, \quad (b - \lambda)g = hf, \quad (c - \lambda)h = fg.$$

Solving for λ from each of these equations we see that the reduction is impossible unless the coefficients of the given equation be connected by the two relations

$$a - \frac{gh}{f} = b - \frac{hf}{g} = c - \frac{fg}{h}.$$

If these relations be fulfilled, and if we substitute any of these common values for λ in the function

$$(a - \lambda)x^2 + (b - \lambda)y^2 + (c - \lambda)z^2 + 2fyz + 2gzx + 2hxy,$$

it becomes, as it ought, a perfect square, viz.

$$fgh \left(\frac{x}{f} + \frac{y}{g} + \frac{z}{h} \right)^2 = (C - A) Z^2,$$

and since the plane $Z=0$ represents a plane perpendicular to the axis of revolution of the surface, it follows that $\frac{x}{f} + \frac{y}{g} + \frac{z}{h} = 0$ represents a plane perpendicular to that axis.

In the special case where the common values vanish which have been just found for λ , the highest terms in the given

* That is to say, the reciprocal equation vanishes identically.

equation form a perfect square, and the equation represents either a parabolic cylinder or two parallel planes (see IV. and V., Art. 87). These are limiting cases of surfaces of revolution, the axis of revolution in the latter case being any line perpendicular to both planes. The parabolic cylinder is the limit of the surface generated by the revolution of an ellipse round its minor axis, when that axis passes to infinity.

119. If one of the quantities f , g , h vanish, the surface cannot be of revolution unless a second also vanish. Suppose that we have f and g both $= 0$, the preceding conditions become

$$a - h \frac{g}{f} = b - h \frac{f}{g} = c,$$

from which, eliminating the indeterminate $\frac{f}{g}$, we get

$$(a - c)(b - c) = h^2.$$

This condition might also have been obtained at once by expressing that

$$(a - \lambda)x^2 + (b - \lambda)y^2 + (c - \lambda)z^2 + 2hxy$$

should be a perfect square, and it is plain that we must have

$$\lambda = c; \quad (a - c)(b - c) = h^2.$$

120. The preceding theory might also be obtained from the consideration that in a surface of revolution the problem of finding the principal planes becomes indeterminate. For since every section perpendicular to the axis of revolution is a circle, any system of parallel chords of one of these circles is bisected by the plane passing through the axis of revolution and through the diameter of the circle perpendicular to the chords, a plane which is perpendicular to the chords. It follows that *every* plane through the axis of revolution is a principal plane. Now the chords which are perpendicular to these diametral planes are given (Art. 72) by the equations

$$(a - \lambda)x + hy + gz = 0, \quad hx + (b - \lambda)y + fz = 0, \quad gx + fy + (c - \lambda)z = 0,$$

which, when λ is one of the roots of the discriminating cubic, represent three planes meeting in one of the right lines required. The problem then will not become indeterminate unless these

equations all represent the same plane, for which we have the conditions

$$\frac{a - \lambda}{h} = \frac{h}{b - \lambda} = \frac{g}{f}; \quad \frac{a - \lambda}{g} = \frac{h}{f} = \frac{g}{c - \lambda},$$

which, expanded, are the same as the conditions found already.

LOCI.

121. We shall conclude this chapter by a few examples of the application of Algebraic Geometry to the *investigation of Loci*.

Ex. 1. To find the locus of a point whose shortest distances from two given non-intersecting right lines are equal.

If the equations of the lines are written in their general form, the solution of this is obtained immediately by the formula of Art. 15. We may get the result in a simple form by taking for the axis of z the shortest distance between the two lines, and, choosing for the other axes the lines bisecting the angle between parallels to the given lines through the point of bisection of this shortest distance; then their equations are of the form

$$z = c, \quad y = mx; \quad z = -c, \quad y = -mx,$$

and the conditions of the problem give

$$(z - c)^2 + \frac{(y - mx)^2}{1 + m^2} = (z + c)^2 + \frac{(y + mx)^2}{1 + m^2},$$

or

$$cz(1 + m^2) + mxy = 0.$$

The locus is therefore a hyperbolic paraboloid.

If the shortest distances had been to each other in a given ratio, the locus would have been

$$\{(1 + \lambda)z + (1 - \lambda)c\} \{(1 - \lambda)z + (1 + \lambda)c\}$$

$$+ \frac{1}{1 + m^2} \{(1 + \lambda)y + (1 - \lambda)mx\} \{(1 - \lambda)y + (1 + \lambda)mx\} = 0,$$

which represents a hyperboloid of one sheet.

Ex. 2. To find the locus of the middle points of all lines parallel to a fixed plane and terminated by two non-intersecting lines.

Take the plane $x = 0$ parallel to the fixed plane, and the plane $z = 0$, as in the last example, parallel to the two lines and equidistant from them; then the equations of the lines are

$$z = c, \quad y = mx + n; \quad z = -c, \quad y = m'x + n'.$$

The locus is then evidently the right line which is the intersection of the planes

$$z = 0, \quad 2y = (m + m')x + (n + n').$$

Ex. 3. To find the surface of revolution generated by a right line turning round a fixed axis which it does not intersect.

Let the fixed line be the axis of z , and let any position of the other be $x = mz + n$, $y = m'z + n'$. Then since any point of the revolving line describes a circle in a plane parallel to that of xy , it follows that the value of $x^2 + y^2$ is the same for every point in such a plane section, and it is plain that the constant value expressed in terms of z is $(mz + n)^2 + (m'z + n')^2$. Hence the equation of the required surface is

$$x^2 + y^2 = (mz + n)^2 + (m'z + n')^2,$$

which represents a hyperboloid of revolution of one sheet.

Ex. 4. Two lines passing through the origin move each in a fixed plane, remaining perpendicular to each other, to find the surface (necessarily a cone) generated by a right line, also passing through the origin perpendicular to the other two.

Let the direction-angles of the perpendiculars to the fixed planes be $a, b, c; a', b', c'$, and let those of the variable line be α, β, γ ; then the direction-cosines of the intersections with the fixed planes, of a plane perpendicular to the variable line, will (Art. 15) be proportional to

$$\cos \beta \cos c - \cos \gamma \cos b, \quad \cos \gamma \cos a - \cos \alpha \cos c, \quad \cos \alpha \cos b - \cos \beta \cos a,$$

$$\cos \beta \cos c' - \cos \gamma \cos b', \quad \cos \gamma \cos a' - \cos \alpha \cos c', \quad \cos \alpha \cos b' - \cos \beta \cos a',$$

and the condition that these should be perpendicular to each other is

$$(\cos \beta \cos c - \cos \gamma \cos b)(\cos \beta \cos c' - \cos \gamma \cos b')$$

$$+ (\cos \gamma \cos a - \cos \alpha \cos c)(\cos \gamma \cos a' - \cos \alpha \cos c')$$

$$+ (\cos \alpha \cos b - \cos \beta \cos a)(\cos \alpha \cos b' - \cos \beta \cos a') = 0$$

which represents a cone of the second degree.

Ex. 5. Two planes mutually perpendicular pass each through a fixed line; to find the surface generated by their line of intersection.

Take the axes as in Ex. 1. Then the equations of the planes are

$$\lambda(z - c) + y - mx = 0; \quad \lambda'(z + c) + y + mx = 0,$$

which will be at right angles if $\lambda\lambda' + 1 - m^2 = 0$; and putting in for λ, λ' their values from the pair of equations, we get

$$y^2 - m^2x^2 + (1 - m^2)(z^2 - c^2) = 0,$$

which represents a hyperboloid of one sheet.

Both the hyperboloid of this Example and of Ex. 1 are such that two pairs of generators are perpendicular to the planes of circular sections. Such hyperboloids of one sheet have been called *orthogonal hyperboloids* (Schröter, *Crelle's Jour.* Vol. 85).

In either case, if the lines intersect, making $c = 0$, the locus reduces to a cone.

$$\frac{x^2}{a^2} + \frac{y^2}{b^2} - \frac{z^2}{c^2} = 1 \text{ is orthogonal if } \frac{1}{a^2} - \frac{1}{b^2} + \frac{1}{c^2} = 0.$$

Ex. 6. To find the locus of a point, whence three tangent lines, mutually at right angles, can be drawn to the quadric $\frac{x^2}{a^2} + \frac{y^2}{b^2} + \frac{z^2}{c^2} = 1$.

If the equation were transformed so that these lines should become the axes of coordinates, the equation of the tangent cone would take the form $Ayz + Bzx + Cxy = 0$, since these three lines are edges of the cone. But the untransformed equation of the tangent cone is, see Art. 78,

$$\left(\frac{x'^2}{a^2} + \frac{y'^2}{b^2} + \frac{z'^2}{c^2} - 1\right) \left(\frac{x^2}{a^2} + \frac{y^2}{b^2} + \frac{z^2}{c^2} - 1\right) = \left(\frac{xx'}{a^2} + \frac{yy'}{b^2} + \frac{zz'}{c^2} - 1\right)^2.$$

And we have seen (Art. 82) that if this equation be transformed to any rectangular system of axes, the sum of the coefficients of $x^2, y^2,$ and z^2 will be constant. We have only then to express the condition that this sum should vanish, when we obtain as equation of the required locus,

$$\frac{x^2}{a^2} \left(\frac{1}{b^2} + \frac{1}{c^2}\right) + \frac{y^2}{b^2} \left(\frac{1}{c^2} + \frac{1}{a^2}\right) + \frac{z^2}{c^2} \left(\frac{1}{a^2} + \frac{1}{b^2}\right) = \frac{1}{a^2} + \frac{1}{b^2} + \frac{1}{c^2}.$$

Ex. 7. To find the equation of the cone whose vertex is $x'y'z'$ and which stands on the conic in the plane of $xy, \frac{x^2}{a^2} + \frac{y^2}{b^2} = 1$.

The equations of the line joining any point $\alpha\beta$ of the base to the vertex are

$$\alpha(z' - z) = z'x - x'z, \quad \beta(z' - z) = z'y - y'z.$$

Substituting these values in the equation of the base, we get for the required cone

$$\frac{(z'x - x'z)^2}{a^2} + \frac{(z'y - y'z)^2}{b^2} = (z' - z)^2.$$

The following method may be used in general to find the equation of the cone whose vertex is $x'y'z'w'$, and base the intersection of any two surfaces U, V . Substitute in each equation for $x, x + \lambda x'$; for $y, y + \lambda y'$, &c., and let the results be

$$U + \lambda \delta U + \frac{\lambda^2}{1.2} \delta^2 U + \&c. = 0, \quad V + \lambda \delta V + \frac{\lambda^2}{1.2} \delta^2 V + \&c. = 0,$$

then the result of eliminating λ between these equations will be the equation of the required cone. For the points where the line joining $x'y'z'w'$ to $xyzw$ meets the surface U are got from the first of these two equations; those where the same line meets the surface V are got from the second; and when the eliminant of the two equations vanishes they have a common root, or the point $xyzw$ lies on a line passing through $x'y'z'w'$ and meeting the intersection of the surfaces.

Ex. 8. To find the equation of the cone whose vertex is the centre of an ellipsoid and base the section made by the polar of any point $x'y'z'$.

$$Ans. \frac{x^2}{a^2} + \frac{y^2}{b^2} + \frac{z^2}{c^2} = \left(\frac{xx'}{a^2} + \frac{yy'}{b^2} + \frac{zz'}{c^2} \right)^2.$$

Ex. 9. To find the locus of points on the quadric $\frac{x^2}{a^2} + \frac{y^2}{b^2} + \frac{z^2}{c^2} = 1$, the normals at which intersect the normal at the point $x'y'z'$.

Ans. The points required are the intersection of the surface with the cone.

$$a^2 (y'z - z'y) (x - x') + b^2 (z'x - x'z) (y - y') + c^2 (x'y - y'x) (z - z') = 0.$$

Ex. 10. To find the locus of the poles of the tangent planes of one quadric with respect to another.

We have only to express the condition that the polar of $x'y'z'w'$, with regard to the second quadric, should touch the first, and have therefore only to substitute U_1, U_2, U_3, U_4 , for $\alpha, \beta, \gamma, \delta$ in the condition given Art. 79. The locus is therefore a quadric.

Ex. 11. To find the cone generated by perpendiculars erected at the vertex of a given cone to its several tangent planes.

Let the cone be $Lx^2 + My^2 + Nz^2 = 0$, and any tangent plane is $Lx'x + My'y + Nz'z = 0$ the perpendicular to which through the origin is $\frac{x}{Lx'} = \frac{y}{My'} = \frac{z}{Nz'}$. If then the common value of these fractions be called ρ , we have $x' = \frac{x}{L\rho}, y' = \frac{y}{M\rho}, z' = \frac{z}{N\rho}$, substituting these values in $Lx'^2 + My'^2 + Nz'^2 = 0$, we get $\frac{x^2}{L} + \frac{y^2}{M} + \frac{z^2}{N} = 0$. The form of the equation shews that the relation between the cones is reciprocal, and that the edges of the first are perpendicular to the tangent planes to the second. It can easily be seen that this is a particular case of the last example.

If the equation of the cone be given in the form

$$ax^2 + by^2 + cz^2 + 2fyz + 2gzx + 2hxy = 0,$$

the equation of the reciprocal cone will be the same as that of the reciprocal curve in plane geometry, viz.

$$(bc - f^2) x^2 + (ca - g^2) y^2 + (ab - h^2) z^2 + 2(g'h - af') yz + 2(hf' - bg) zx + 2(fg - ch) xy = 0.$$

Ex. 12. A line moves about so that three fixed points on it move on fixed planes; to find the locus of any other point on it.

Let the coordinates of the locus point P be α, β, γ ; and let the three fixed planes be taken for coordinate planes meeting the line in points A, B, C . Then it is easy to see that the coordinates of A are $0, \frac{AB}{PB} \beta, \frac{AC}{PC} \gamma$, where the ratios $AB : PB, AC : PC$ are known. Expressing then, by Art. 10, that the distance PA is constant, the locus is at once found to be an ellipsoid.

Ex. 13. A and O are two fixed points, the latter being on the surface of a sphere. Let the line joining any other point D on the sphere to A meet the sphere again in D' . Then if on OD a portion OP be taken $= AD'$, find the locus of P . [Sir W. R. Hamilton].

We have $AD^2 = AO^2 + OD^2 - 2AO \cdot OD \cos AOD$. But AD varies inversely as the radius vector of the locus, and OD is given, by the equation of the sphere, in terms of the angles it makes with fixed axes. Thus the locus is easily seen to be a quadric of which O is the centre.

Ex. 14. A plane passes through a fixed line, and the lines in which it meets two fixed planes are joined by planes each to a fixed point; find the surface generated by the line of intersection of the latter two planes.

Ex. 15. The four faces of a tetrahedron pass each through a fixed point. Find the locus of the vertex if the three edges which do not pass through it move each in a fixed plane.

The locus is in general a surface of the third degree having the intersection of the three planes for a double point. It reduces to a cone of the second degree when the four fixed points lie in one plane.

Ex. 16. Find the locus of the vertex of a tetrahedron, if the three edges which pass through that vertex each pass through a fixed point, if the opposite face also pass through a fixed point and the three other vertices move in fixed planes.

Ex. 17. A plane passes through a fixed point, and the points where it meets three fixed lines are joined by planes, each to one of three other fixed lines; find the locus of the intersection of the joining planes.

Ex. 18. The sides of a polygon in space pass through fixed points, and all the vertices but one move in fixed planes; find the curve locus of the remaining vertex.

Ex. 19. All the sides of a polygon but one pass through fixed points, the extremities of the free side move on fixed lines, and all the other vertices on fixed planes, find the surface generated by the free side.

Ex. 20. The plane through the extremities of conjugate diameters of an ellipsoid envelopes the ellipsoid $\frac{x^2}{a^2} + \frac{y^2}{b^2} + \frac{z^2}{c^2} = \frac{1}{3}$ and touches it in the centre of the section.

Ex. 21. The condition that a system of generators of the hyperboloid $\frac{x^2}{a^2} + \frac{y^2}{b^2} - \frac{z^2}{c^2} = 1$ may admit of three such generators mutually at right angles is found to be $\frac{1}{a^2} + \frac{1}{b^2} - \frac{1}{c^2} = 0$.

Such hyperboloids have been called *equilateral hyperboloids*. (Schröter, *Oberflächen zweiter Ordnung*, p. 197, 1880).

CHAPTER VII.

METHODS OF ABRIDGED NOTATION.

THE PRINCIPLE OF DUALITY AND RECIPROCAL POLARS.

122. WE shall in this chapter give examples of the application to quadrics of methods of abridged notation. It is convenient, however, first to shew that every figure we employ admits of a two-fold description, and that every theorem we obtain is accompanied by another reciprocal theorem. In fact, the reader can see without difficulty that the whole theory of Reciprocal Polars explained (*Conics*, Chap. xv.) is applicable to space of three dimensions. Being given a fixed quadric Σ , and any surface S , we can generate a new surface s by taking the pole with regard to Σ of every tangent plane to S . If we have thus a point on s corresponding to a tangent plane of S , reciprocally the tangent plane to s at that point will correspond to the point of contact of the tangent plane to S . For the tangent plane to s contains all the points on s consecutive to the assumed point; and to it must correspond the point through which pass all the tangent planes of S consecutive to the assumed tangent plane; that is to say, the point of contact of that plane. Thus to every point connected with one surface corresponds a plane connected with the other, and *vice versâ*; and to a line (joining two points) corresponds a line (the intersection of two planes). For example the degree of s , being measured by the number of points in which an arbitrary line meets it, is equal to the number of tangent planes which can be drawn to S through an arbitrary right line. Thus the reciprocal of a quadric is a quadric, since two tangent planes can be drawn to a quadric through any arbitrary right line (Art. 80).

123. In order to shew what corresponds to a curve in space we shall anticipate a little of the theory of curves of double

curvature to be explained hereafter. A curve in space may be considered as a series of points in space 1, 2, 3, &c., arranged according to a certain law. If each point be joined to its next consecutive point, we shall have a series of lines 12, 23, 34, &c., each line being a tangent to the given curve. The assemblage of these lines forms a surface, and a *developable* surface (see note, Art. 112), since any line 12 intersects the consecutive line 23. Again, if we consider the planes 123, 234, 345, &c., containing every three consecutive points, we shall have a series of planes which are called the *osculating* planes of the given curve, and which are tangent planes to the developable generated by its tangents. Now when we reciprocate, it is plain that to the series of points, lines, and planes will correspond a series of planes, lines, and points; and thus, that the reciprocal of a series of points forming a curve in space will be a series of planes touching a developable. If the curve in space lies all in one plane, the reciprocal planes will all pass through one point, and will be tangent planes to a *cone*.

Thus the series of points common to two surfaces forms a curve. Reciprocally the series of tangent planes common to two surfaces touches a developable which envelopes both surfaces. To the series of tangent planes (enveloping a *cone*) which can be drawn to the one surface through any point, corresponds the series of points on the other which lie in the corresponding plane: that is to say, *to a plane section of one surface corresponds a tangent cone of the reciprocal*. It easily follows hence, that to a point and its polar plane with respect to a quadric, correspond a plane and its pole with respect to the reciprocal quadric.

124. The reciprocals are frequently taken with regard to a sphere whose centre is called the *origin of reciprocation*, and as at *Conics* (Art. 307) mention of the sphere may be omitted, and the reciprocals spoken of as taken with regard to this origin. To the origin will evidently correspond the plane at infinity; and to the section of one surface by the plane at infinity will correspond the tangent cone which can be drawn to the other through the origin. Thus, then, when the origin is *without* a quadric, that is to say, is such that real tangent planes can be

drawn from it to the surface, the reciprocal surface will have real points at infinity, that is to say, will be a hyperboloid; when the origin is inside, the reciprocal is an ellipsoid; when the origin is *on* the surface, the reciprocal will be touched by the plane at infinity, or what is the same thing (as we shall presently see) the reciprocal is a paraboloid.

The reciprocal of a *ruled* surface (that is to say, of a surface generated by the motion of a right line) is a ruled surface. For to a right line corresponds a right line, and to the surface generated by the motion of one right line will correspond the surface generated by the motion of the reciprocal line.* Hence to a hyperboloid of one sheet always corresponds a hyperboloid of one sheet unless the origin be on the surface when the reciprocal is a hyperbolic paraboloid.

125. When reciprocals are taken with regard to a sphere, any plane is evidently perpendicular to the line joining the corresponding point to the origin. Thus to any cone corresponds a plane curve, and the cone whose base is that curve and vertex the origin has an edge perpendicular to every tangent plane of the first cone, and *vice versa*. In general two cones (which may or may not have a common vertex) are said to be reciprocal when every edge of one is perpendicular to a tangent plane of the other (see Ex. 11, Art. 121). For example, it appears from the last article, that the tangent cone from the origin to any surface is in this sense reciprocal to the asymptotic cone of the reciprocal surface.

The sections by any plane of two reciprocal cones, having a common vertex, are polar reciprocals with regard to the foot of the perpendicular on that plane from the common vertex. For, let the plane meet an edge of one cone in a point P , and the

* Prof. Cayley has remarked, that *the degree of any ruled surface is equal to the degree of its reciprocal.* The degree of the reciprocal is equal to the number of tangent planes which can be drawn through an arbitrary right line. Now it will be formally proved hereafter, but is sufficiently evident in itself, that the tangent plane at any point on a ruled surface contains the generating line which passes through that point. The degree of the reciprocal is therefore equal to the number of generating lines which meet an arbitrary right line. But this is exactly the number of points in which the arbitrary line meets the surface, since every point on a generating line is a point on the surface.

perpendicular tangent plane to the other in the line QR ; let M be the foot of the perpendicular on the plane from the vertex O ; then it is easy to see that the line PM is perpendicular to QR ; and if it meet it in S , then since the triangle POS is right-angled, the rectangle $PM.MS$ is equal to the constant OM^2 . The curve therefore which is the locus of the point P is the same as that got by letting fall from M perpendiculars on the tangents QR , and taking on each perpendicular a portion inversely as its length.

The following illustrates the application of the principle here established: *Through the vertex of any cone of the second degree can be drawn two lines, called focal lines, such that the section of the cone by a plane perpendicular to either line is a conic, having for a focus the point where the plane meets the focal line.* For form a reciprocal cone by drawing through the vertex lines perpendicular to the tangent planes of the given cone; then this cone has two planes of circular section (Art. 104); and, by the present article, the section of the given cone by a plane parallel to either is a conic having for a focus the foot of the perpendicular on that plane from the vertex. What has been just proved may be stated, *the focal lines of a cone are perpendicular to the planes of circular section of the reciprocal cone.*

126. *The reciprocal of a sphere with regard to any point is a surface generated by the revolution of a conic round the transverse axis.* This may be proved as at *Conics*, Art. 308. It is easily proved that if we have any two points A and B , the distances of these two points from the origin are in the same ratio as the perpendiculars from each on the plane corresponding to the other (*Conics*, Art. 101). Now the distance of the centre of a fixed sphere from the origin, and the perpendicular from that centre on any tangent plane to the sphere are both constant. Hence, any point on the reciprocal surface is such that its distance from the origin is in a constant ratio to the perpendicular let fall from it on a fixed plane; namely, the plane corresponding to the centre of the sphere. And this locus is manifestly a surface of revolution, of which the origin is a focus; and the plane in question a directrix plane.

By reciprocating properties of the sphere we thus get properties of surfaces of revolution round the transverse axis. The left-hand column contains properties of the sphere, the right-hand those of the surfaces of revolution.

Ex. 1. Any tangent plane to a sphere is perpendicular to the line joining its point of contact to the centre.

The line joining focus to any point on the surface is perpendicular to the plane through the focus and the intersection with the directrix plane of the tangent plane at the point.

Ex. 2. Every tangent cone to a sphere is a right cone, the tangent planes all making equal angles with the plane of contact.

The cone whose vertex is the focus and base any plane section is a right cone whose axis is the line joining the focus to the pole of the plane of section.

A particular case of Ex. 2 is "Every plane section of a paraboloid of revolution is projected into a circle on the tangent plane at the vertex."

Ex. 3. Any plane is perpendicular to the line joining the centre to its pole.

The line joining any point to the focus is perpendicular to the plane joining the focus to the intersection with the directrix plane of the polar plane of the point.

Ex. 4. Any plane through the centre is perpendicular to the conjugate diameter.

Any plane through the focus is perpendicular to the line joining the focus to its pole.

Ex. 5. The cone whose base is any plane section of a sphere has circular sections parallel to the plane of section.

Any tangent cone has for its focal lines the lines joining the vertex of the cone to the two foci.

Ex. 6. Every cylinder enveloping a sphere is right.

Every section passing through the focus has this focus for a focus.

Ex. 7. Any two conjugate* right lines are mutually perpendicular.

Any two conjugate lines are such that the planes joining them to the focus are at right angles.

Ex. 8. Any quadric enveloping a sphere is a surface of revolution; and its asymptotic cone therefore is a right cone.

If a quadric envelope a surface of revolution, the cone enveloping the former, whose vertex is a focus of the latter, is a cone of revolution.

* The polar planes with respect to a quadric of all the points of a line pass through a right line, which we call the conjugate line, or polar line (Art. 65).

127. The equation of the reciprocal of a central surface with regard to any point is found as at *Conics*, Art. 319. For the length of the perpendicular from any point on the tangent plane is (see Art. 89)

$$p = \frac{k^2}{\rho} = \sqrt{(a^2 \cos^2 \alpha + b^2 \cos^2 \beta + c^2 \cos^2 \gamma) - (x' \cos \alpha + y' \cos \beta + z' \cos \gamma)},$$

and the reciprocal is therefore

$$(xx' + yy' + zz' + k^2)^2 = a^2 x^2 + b^2 y^2 + c^2 z^2.$$

Thus the reciprocal with regard to the centre is

$$a^2 x^2 + b^2 y^2 + c^2 z^2 = k^4,$$

a quadric whose axes are the reciprocals of the axes of the given one.

We have given (Ex. 10, Art. 121) the method in general of finding the equation of the reciprocal of one quadric with regard to another. Thus the reciprocal with regard to the sphere $x^2 + y^2 + z^2 = k^2$, is found by substituting $x, y, z, -k^2$ for $\alpha, \beta, \gamma, \delta$ in the tangential equation, Art. 79; or, more symmetrically, the tangential equation itself may be considered as the equation of the reciprocal with regard to $x^2 + y^2 + z^2 + w^2 = 0$; $\alpha, \beta, \gamma, \delta$ being the coordinates.

The reciprocal of the reciprocal of a quadric is evidently the quadric itself. If we actually form the equation of the reciprocal of the reciprocal $A\alpha^2 + B\beta^2 + \&c.$, the new coefficient of α^2 is $BCD + 2FMN - BN^2 - CM^2 - DF^2$, which, when we substitute for $B, C, \&c.$, their values will be found to be $a\Delta^2$. And Δ^2 will in like manner be a factor in every term, so that the reciprocal of the reciprocal is the given equation multiplied by the square of the discriminant (see *Lessons on Higher Algebra*, Art. 33).

128. The principle of duality may be established independently of the method of reciprocal polars, by shewing in extension of the remarks made above, Art. 38, (see *Conics*, Art. 299) that all the equations we employ admit of a two-fold interpretation; and that when interpreted as equations in tangential coordinates, they yield theorems reciprocal to those which they give according to the mode of interpretation hitherto

adopted. We may call $\alpha, \beta, \gamma, \delta$ the tangential coordinates of the plane $\alpha x + \beta y + \gamma z + \delta w$. Now the condition that this plane may pass through a given point, being

$$\alpha x' + \beta y' + \gamma z' + \delta w' = 0,$$

conversely, any equation of the first degree in $\alpha, \beta, \gamma, \delta$,

$$A\alpha + B\beta + C\gamma + D\delta = 0$$

is the condition that this plane may pass through a point whose coordinates are proportional to A, B, C, D ; and the equation just written may be regarded as the tangential equation of that point. If the tangential coordinates of two planes are $\alpha, \beta, \gamma, \delta$; $\alpha', \beta', \gamma', \delta'$ it follows, from Art. 37, that $\alpha + k\alpha', \beta + k\beta', \&c.$ are the coordinates of a plane passing through the line of intersection of the two given planes. And again, it follows from Art. 8, that if $L=0, M=0$ be the tangential equations of two points, $L + kM=0$ denotes a point on the line joining the two given ones; and similarly (Art. 9), that $L + kM + k'N$ denotes a point in the plane determined by the three points L, M, N .

Again, any equation in $\alpha, \beta, \gamma, \delta$ may be considered as the tangential equation of a surface touched by every plane $\alpha x + \beta y + \gamma z + \delta w$ whose coordinates satisfy the given equation. If the equation be of the n^{th} order, the surface will be of the n^{th} class, or such that n tangent planes (fulfilling the given relation) can be drawn through any line. For if we substitute in the given equation $\alpha' + k\alpha'', \beta' + k\beta'', \&c.$ for $\alpha, \beta, \&c.$, we get an equation of the n^{th} degree in k , determining n planes satisfying the given relation, which can be drawn through the intersection of the planes $\alpha'\beta'\gamma'\delta', \alpha''\beta''\gamma''\delta''$.

129. The general tangential equation of the second degree

$$A\alpha^2 + B\beta^2 + C\gamma^2 + D\delta^2 + 2F\beta\gamma + 2G\gamma\alpha + 2H\alpha\beta \\ + 2L\alpha\delta + 2M\beta\delta + 2N\gamma\delta = 0$$

can be discussed by precisely the same methods as are used above (Arts. 75–80). If we substitute $\alpha' + k\alpha'', \&c.$ for $\alpha, \&c.$, we get a quadratic in k , which may be written $S' + 2kP + k^2S'' = 0$. If the plane $\alpha'\beta'\gamma'\delta'$ touch the surface in question, $S' = 0$, and one of the roots of the quadratic is $k=0$. The second root will be also $k=0$, provided that $P=0$. In other words, the co-

ordinates of any tangent plane consecutive to $\alpha'\beta'\gamma'\delta'$ must satisfy the condition

$$\alpha \frac{dS'}{d\alpha'} + \beta \frac{dS'}{d\beta'} + \gamma \frac{dS'}{d\gamma'} + \delta \frac{dS'}{d\delta'} = 0.$$

But this equation being of the first degree represents a point, viz. the point of contact of $\alpha'\beta'\gamma'\delta'$, through which every consecutive tangent plane must pass.

We may regard the relation just obtained as one connecting the coordinates of a tangent plane with those of any plane passing through its point of contact, and from the symmetry of this relation, we infer (as in Art. 63) that if α' , β' , γ' , δ' be the coordinates of any plane, those of the tangent plane at every point of the surface which lies in that plane, must fulfil the condition

$$\alpha \frac{dS'}{d\alpha'} + \beta \frac{dS'}{d\beta'} + \gamma \frac{dS'}{d\gamma'} + \delta \frac{dS'}{d\delta'} = 0.$$

But this equation represents a point through which all the tangent planes in question must pass; in other words, it represents the pole of the given plane.

We can, by following the process pursued in Art. 79, deduce from the general tangential equation of the second degree the corresponding equation to be satisfied by its points. If the tangential equation of any point on the surface be

$$x'\alpha + y'\beta + z'\gamma + w'\delta = 0,$$

and $\alpha\beta\gamma\delta$ the coordinates of the corresponding tangent plane, we infer from the equations already obtained, that if λ be an indeterminate multiplier, we must have

$$\begin{aligned} \lambda x' &= A\alpha + H\beta + G\gamma + L\delta; & \lambda y' &= H\alpha + B\beta + F\gamma + M\delta, \\ \lambda z' &= G\alpha + F\beta + C\gamma + N\delta; & \lambda w' &= L\alpha + M\beta + N\gamma + D\delta. \end{aligned}$$

Solving these equations for $\alpha\beta\gamma\delta$, we get the coordinates of the polar plane of any assumed point; and expressing that these coordinates satisfy the given tangential equation, we get the relation to be satisfied by the x , y , z , w of any point on the surface, a relation only differing by the substitution of capital for small letters from that found in Art. 79.

It seems unnecessary to give further examples how all the preceding discussions may be adapted to the corresponding

equations in tangential coordinates. In what follows, we have only to suppose that the abbreviations denote equations in tangential coordinates, when we get direct proofs of the reciprocals of the theorems actually obtained.

130. If U and V represent any two quadrics, then $U + \lambda V$ represents a quadric passing through *every* point common to U and V , and if λ be indeterminate it represents a series of quadrics having a common curve of intersection. Since nine points determine a quadric (Art. 58), $U + \lambda V$ is the most general equation of the quadric passing through eight given points (see *Higher Plane Curves*, Art. 29). For if U and V be two quadrics, each passing through the eight points, $U + \lambda V$ represents a quadric also passing through the eight points, and the constant λ can be so determined that the surface shall pass through any ninth point, and can in this way be made to coincide with any given quadric through the eight points. It follows then that all quadrics which pass through eight points have besides a whole series of common points, forming a common curve of intersection; and reciprocally, that all quadrics which touch eight given planes have a whole series of common tangent planes determining a fixed developable which envelopes the whole series of surfaces touching the eight fixed planes.

It is evident also that the problem to describe a quadric through nine points may become indeterminate. For if the ninth point lie anywhere on the curve which, as we have just seen, is determined by the eight fixed points, then *every* quadric passing through the eight fixed points will pass through the ninth point, and it is necessary that we should be given a ninth point, *not* on this curve, in order to be able to determine the surface. Thus if U and V be two quadrics through the eight points, we determine the surface by substituting the coordinates of the ninth point in $U + \lambda V = 0$; but if these coordinates make $U = 0$, $V = 0$, this substitution does not enable us to determine λ .

131. Given seven points [or tangent planes] common to a series of quadrics, then an eighth point [or tangent plane] common to the whole system is determined.

For let U, V, W be three quadrics, each of which passes through the seven points, then $U + \lambda V + \mu W$ may represent *any* quadric which passes through them; for the constants λ, μ may be so determined that the surface shall pass through any two other points, and may in this way be made to coincide with any given quadric through the seven points. But $U + \lambda V + \mu W$ represents a surface passing through *all* points common to U, V, W , and since these intersect in eight points, it follows that there is a point, in addition to the seven given, which is common to the whole system of surfaces.

We see thus, that though it was proved in the last article that eight points *in general* determine a curve of double curvature common to a system of quadrics, it is *possible* that they may not. For we have just seen that there is a particular case in which to be given eight points is only equivalent to being given seven. When we say therefore that a quadric is determined by nine points, and that the intersection of two quadrics is determined by eight points, it is assumed that the nine or eight points are perfectly unrestricted in position.*

132. If a system of quadrics have a common curve of intersection, the polar plane of any fixed point passes through a fixed right line.

If a system of quadrics be inscribed in the same developable, the locus of the pole of a fixed plane is a right line.

For if P and Q be the polar planes of a fixed point with regard to U and V respectively, then $P + \lambda Q$ is the polar of the same point with respect to $U + \lambda V$.

In particular, the locus of the centres of all quadrics inscribed in the same developable is a right line.

133. If a system of quadrics have a common curve of intersection [or be inscribed in a common developable], the polars of a fixed line generate a hyperboloid of one sheet.

* The reader who has studied *Higher Plane Curves*, Arts. 29—34, will have no difficulty in developing the corresponding theory for surfaces of any degree. Thus if we are given one less than the number of points necessary to determine a surface of the n^{th} degree, we are given a series of points forming a curve through which the surface must pass; and if we are given two less than the number of points necessary to determine the surface, then we are given a certain number of other points [namely as many as will make the entire number up to n^3] through which the surface must also pass,

Let the polars of two points in the line be $P + \lambda Q$, $P' + \lambda Q'$, then it is evident that their intersection lies on the hyperboloid $PQ' = QP'$.

134. If a system of quadrics have a common curve, the locus of the pole of a fixed plane is a curve in space of the third degree. For, eliminating λ between $P + \lambda Q$, $P' + \lambda Q'$, $P'' + \lambda Q''$, the polars of any three points, each determinant of the system

$$\begin{vmatrix} P, & P', & P'' \\ Q, & Q', & Q'' \end{vmatrix}$$

vanishes. Now the intersection of the surfaces represented by $PQ' = QP'$, $PQ'' = QP''$, is a curve of the fourth degree, but this includes the right line PQ , which is not part of the intersection of $PQ'' = QP''$, $P'Q'' = Q'P''$. There is therefore only a curve of the third degree common to all three.

Reciprocally, if a system be inscribed in the same developable, the polar of a fixed point envelopes the developable which is the reciprocal of a curve of the third degree, being (as will afterwards be shewn) a developable of the fourth order.

135. Given seven points on a quadric, the polar plane of a fixed point passes through a fixed point. Given seven tangent planes to a quadric, the pole of a fixed plane moves in a fixed plane.

For evidently the polar of a fixed point with regard to $U + \lambda V + \mu W$ will be of the form $P + \lambda Q + \mu R$, and will therefore pass through a fixed point.*

136. Since the discriminant contains the coefficients in the fourth degree, it follows that we have a biquadratic equation to solve to determine λ , in order that $U + \lambda V$ may represent a cone, and therefore *that through the intersection of two quadrics four cones may be described*. The vertex of each of these cones is the common intersection of the four planes,

$$U_1 + \lambda V_1, \quad U_2 + \lambda V_2, \quad U_3 + \lambda V_3, \quad U_4 + \lambda V_4,$$

* Dr. Hesse has derived from this theorem a construction for the quadric passing through nine given points. *Crelle*, Vol. XXIV. p. 36. *Cambridge and Dublin Mathematical Journal*, Vol. IV. p. 41. See also some further developments of the same problem by Mr. Townsend, *ib.* Vol. IV. p. 241.

when λ satisfies the biquadratic just referred to, and the four vertices are got by substituting its four roots in succession in any three of these equations; they are therefore the four points common to the surfaces found by making each of the determinants

$$\left\| \begin{array}{cccc} U_1 & U_2 & U_3 & U_4 \\ V_1 & V_2 & V_3 & V_4 \end{array} \right\| = 0.$$

There are four points whose polars are the same with respect to all quadrics passing through a common curve of intersection, namely the vertices of the four cones just referred to. For to express the conditions that

$$\begin{aligned} xU'_1 + yU'_2 + zU'_3 + wU'_4 &= 0, \\ xV'_1 + yV'_2 + zV'_3 + wV'_4 &= 0, \end{aligned}$$

should represent the same plane, we find the very same set of determinants. In like manner there are four planes whose poles are the same with respect to a set of quadrics inscribed in the same developable.

137. If the surface V break up into two planes, the form $U + \lambda V = 0$, becomes $U + \lambda LM = 0$, a case deserving of separate examination.* In general, the intersection of two quadrics is a curve of double curvature of the fourth degree, which may in some cases (Art. 134) break up into a right line and a cubic, but the intersection with U of any of the surfaces $U + \lambda LM$, evidently reduces to the two conics in which U is cut by the planes L and M . *Any point on the line LM has the same polar plane with regard to all surfaces of the system $U + \lambda LM$.*† For if P be the polar of any point with regard to U , its polar with regard to $U + \lambda LM$ will be $P + \lambda(LM' + ML')$ which reduces to P , when $L' = 0$, $M' = 0$. Thus,

* The case where U also breaks up into two planes has been discussed, Art. 108.

† There are two other points whose polar planes are the same with regard to all the quadrics, and which therefore (Art. 136) will be vertices of cones containing both the curves of section. It is only necessary that P , the polar plane of one of these points with regard to U , should be the same plane as $L'M + LM'$ the polar with regard to LM . Since then the polar plane of the point with regard to U passes through LM , the point itself must lie on the polar line of LM with regard to U , that is to say, on the intersection of the tangent planes where LM meets U . Let this polar line meet U in AA' , and LM in BB' , then the points required will be FF' , the foci of the involution determined by AA' , BB' . For since FF' form a harmonic system either with AA' or with BB' , the polar plane of F either with regard to U or LM passes through F' , and *vice versa*.

in particular, at each of the two points where the line LM meets U , all the surfaces have the same tangent plane. The form, then, $U + \lambda LM$, may be regarded as denoting a system of quadrics having double contact with each other. Conversely, if two quadrics have double contact, their curve of intersection breaks up into simpler curves. For if we draw any plane through the two points of contact and through any point of their intersection, this plane will meet the quadrics in sections having three points common, and having common also the two tangents at the points of contact; these sections must therefore be identical, and the curve of intersection breaks up into two plane curves unless the line joining the points of contact be a generator of each surface in which case the rest of the curve of intersection is a curve of the third degree.

In like manner all surfaces of the system are enveloped by two cones of the second degree. For take the point where the intersection of the two given common tangent planes is cut by any other common tangent plane; then the cones having this point for vertex, and enveloping each surface, have common three tangent planes and two lines of contact, and are therefore identical. The reciprocals of a pair of quadrics having double contact will manifestly be a pair of quadrics having double contact, and the two planes of intersection of the one pair will correspond to the vertices of common tangent cones to the other pair.

138. *If there be a plane curve common to three quadrics, each pair must have also another common plane curve, and the three planes of these last common curves pass through the same line.* Let the quadrics be U , $U + LM$, $U + LN$, then the last two have evidently for their mutual intersection two plane sections made by L , $M - N$.

139. Similar quadrics belong to the class now under discussion. Two quadrics are similar and similarly placed when the terms of the second degree are the same in both (see *Conics*, Art. 234). Their equations then are of the form $U = 0$, $U + cL = 0$. We see then that two such quadrics intersect in general in one plane curve, the other plane of intersection being at infinity. If there be three quadrics, similar and

similarly placed, their three finite planes of intersection pass through the same right line.

Spheres are all similar quadrics, and therefore are to be considered as having a common section at infinity, which section will of course be an imaginary circle.

A plane section of a quadric will be a circle if it passes through the two points in which its plane meets this imaginary circle at infinity. We may see thus immediately of how many solutions the problem of finding the circular sections of a quadric is susceptible. For the section of the quadric by the plane at infinity meets the section of a sphere by the same plane in four points, which can be joined by six right lines, the planes passing through any one of which meet the quadric in a circle. The six right lines may be divided into three pairs, each pair intersecting in one of the three points whose polars are the same with respect to the section of the quadric and of the sphere. And it is easy to see that these three points determine the directions of the axes of the quadric.

An umbilic (Art. 106) is the point of contact of a tangent plane which can be drawn through one of these six right lines. There are in all therefore twelve umbilics, though only four are real. If a tangent plane be drawn to a quadric through any line, the generators in that tangent plane evidently pass, one through each of the points where the line meets the surface. Thus, then, the umbilics must lie each on some one of the eight generators, which can be drawn through the four points at infinity common to the quadric and any sphere. Or, as Sir W. Hamilton has remarked, the *twelve umbilics lie three by three on eight imaginary right lines*.

A surface of revolution is one which has double contact at infinity with a sphere. For an equation of the form $x^2 + y^2 + az^2 = b$ can be written in the form

$$(x^2 + y^2 + z^2 - r^2) + \{(a - 1)z^2 - (b - r^2)\} = 0,$$

and the latter part represents two planes. It is easy to see then why in this case there is but one direction of real circular sections, determined by the line joining the points of contact of the sections at infinity of a sphere and of the quadric.

140. If the two planes L, M coincide, the form $U + \lambda LM$ becomes $U + \lambda L^2$, which denotes a system of surfaces touching U at every point of the section of U by the plane L . Two quadrics cannot touch in three points without their touching all along a plane curve. For the plane of the three points meets the quadrics in sections having common those three points and the tangents at them. The sections are therefore identical. The equation of the tangent cone to a quadric given Art. 78, is a particular case of the form $U = L^2$. Also two concentric and similar quadrics ($U, U - c^2$) are to be regarded as having plane contact with each other, the plane of contact being at infinity. Any plane obviously cuts the surfaces U and $U - L^2$ in two conics having double contact with each other, and if the section of one reduce to a point-circle, that point must plainly be the focus of the other. Hence *when one quadric has plane contact with another, the tangent plane at the umbilic of one cuts the other in a conic of which the umbilic is the focus*; and if one surface be a sphere, *every tangent plane to the sphere meets the other surface in a section of which the point of contact is the focus*.

Or these things may be seen by taking the origin at the umbilic and the tangent plane for the plane of xy , when on making $z = 0$, the quantity $U - L^2$ reduces to $x^2 + y^2 - l^2$, and denotes a conic of which the origin is the focus, and l the directrix.

Two quadrics having plane contact with the same third quadric intersect each other in plane curves. Obviously $U - L^2, U - M^2$, have the planes $L - M, L + M$ for their planes of intersection.

141. The equation $aL^2 + bM^2 + cN^2 + dP^2$, where L, M, N, P represent planes, denotes a quadric such that any one of these four planes is the polar of the intersection of the other three. For $aL^2 + bM^2 + cN^2$ denotes a cone having the point LMN for its vertex; and the equation of the quadric shews that this cone touches the quadric, P being the plane of contact. The four planes form what I shall call a *self-conjugate tetrahedron* with regard to the surface. It has been proved (Art. 136) that given two quadrics there are always four planes whose

poles with regard to both are the same. If these be taken for the planes L, M, N, P , the equations of both can be transformed to the forms

$$aL^2 + bM^2 + cN^2 + dP^2 = 0, \quad a'L^2 + b'M^2 + c'N^2 + d'P^2 = 0.$$

It may also be seen, *à priori*, that this is a form to which it must be possible to bring the system of equations of two quadrics. For L, M, N, P involve implicitly three constants each; and the equations written above involve explicitly three independent constants each. The system therefore includes eighteen constants, and is therefore sufficiently general to express the equations of any two quadrics.

We are misled, however, if we conclude in like manner that the equations of any three quadrics may be written in the form

$$aL^2 + bM^2 + cN^2 + dP^2 + eQ^2 = 0,$$

$$a'L^2 + b'M^2 + c'N^2 + d'P^2 + e'Q^2 = 0,$$

$$a''L^2 + b''M^2 + c''N^2 + d''P^2 + e''Q^2 = 0,$$

where L, M, N, P, Q are five planes whose equations are connected by the relation

$$L + M + N + P + Q = 0.$$

For though, since L, M, N, P, Q involve implicitly three constants each, and the equations written above involve explicitly four independent constants each, the system thus appears to include twenty-seven constants, it has not really so many. For, as we shall show in a subsequent chapter, a relation must subsist among them, and the system is consequently not general enough to express the equations of any three quadrics.

142. *The lines joining the vertices of any tetrahedron to the corresponding vertices of its polar tetrahedron with regard to a quadric belong to the same system of generators of a hyperboloid of one sheet, and the intersections of corresponding faces of the two tetrahedra possess the same property.*

Taking the fundamental tetrahedron and its polar, the vertices of the polar tetrahedron (Art. 79) are proportional

to the horizontal rows in

$$\begin{aligned} &A, H, G, L, \\ &H, B, F, M, \\ &G, F, C, N, \\ &L, M, N, D, \end{aligned}$$

Thus the equations of the four lines we are considering are

$$\begin{aligned} \frac{y}{H} = \frac{z}{G} = \frac{w}{L}, \quad \frac{z}{F} = \frac{w}{M} = \frac{x}{H}, \\ \frac{w}{N} = \frac{x}{G} = \frac{y}{F}, \quad \frac{x}{L} = \frac{y}{M} = \frac{z}{N}. \end{aligned}$$

Now the condition that any line

$$\alpha x + \beta y + \gamma z + \delta w = 0, \quad \alpha' x + \beta' y + \gamma' z + \delta' w = 0,$$

should intersect the first of the four, is, by eliminating x between the last two equations, found to be

$$H(\alpha\beta' - \beta\alpha') + G(\alpha\gamma' - \gamma\alpha') + L(\alpha\delta' - \delta\alpha') = 0,$$

and the conditions that it should intersect each of the other three, are in like manner found to be

$$H(\beta\alpha' - \beta'\alpha) + F(\beta\gamma' - \beta'\gamma) + M(\beta\delta' - \beta'\delta) = 0,$$

$$G(\gamma\alpha' - \gamma'\alpha) + F(\gamma\beta' - \gamma'\beta) + N(\gamma\delta' - \gamma'\delta) = 0,$$

$$L(\delta\alpha' - \delta'\alpha) + M(\delta\beta' - \delta'\beta) + N(\delta\gamma' - \delta'\gamma) = 0.$$

But these four conditions added together vanish identically. Any right line therefore which intersects the first three will intersect the fourth, which is, in other words, the thing to be proved.*

We find the equation of the hyperboloid by any of the methods in Art. 113, for example, by expressing that the line $\frac{wx' - w'x}{s} = \frac{wy' - w'y}{t} = \frac{wz' - w'z}{u}$ meets the first three of these lines. For then

$$\frac{Hw - Ly}{t} = \frac{Gw - Lz}{u}, \quad \frac{Fw - Mz}{u} = \frac{Hw - Mx}{s}, \quad \frac{Gw - Nx}{s} = \frac{Fw - Ny}{t},$$

* This theorem is due to M. Chasles. The proof here given is by Mr. Ferrers, *Quarterly Journal of Mathematics*, (Vol. I., p. 241).

from which by multiplication, s, t, u are eliminated in the form
 $(Fw - Mz)(Gw - Nx)(Hw - Ly) = (Fw - Ny)(Gw - Lz)(Hw - Mx),$
 or $(HN - GM)(Fwx + Lyz) + (FL - HN)(Gwy + Mzx)$
 $+ (GM - FL)(Hwz + Nxy) = 0.$

142a. This hyperboloidal relation between the four joining lines has been established by Mr. M'Cay by the following considerations.

First, considering any solid angle formed by three planes; their poles in regard to any quadric determine a plane, and in it these three poles form a triangle which is conjugate, in regard to the curve of section, to the triangle which the solid angle cuts out in the same plane.

Now conjugate triangles are in perspective, hence the three planes,—each through an edge of the solid angle, and the pole of its opposite face,—all pass through a right line.

If then we have two tetrahedra, polars with regard to a quadric, having the vertices $abcd, a'b'c'd'$, we see that at any one (a) of their eight vertices a right line may be found in the manner described; and since this line is common to the three planes abb', acc', add' it meets the connecting lines bb', cc', dd' ; also, since it passes through (a) it meets aa' . In this way, taking each of the eight vertices, we have eight lines each of which meets aa', bb', cc', dd' . The relation is thus demonstrated.

N.B. It appears from what has been stated that, when three planes are given and two points assumed which are to be poles to two of them in regard to any quadric, the pole of the third is limited to a certain plane locus.

Ex. 1. Given three planes and their poles in regard to a quadric, the locus of the centre is a right line (Mr. M'Cay).

Ex. 2. The four perpendiculars from the vertices on the opposite faces in any tetrahedron are generators of one system, and the four perpendiculars to the faces at their orthocentres are generators of the other system of an equilateral hyperboloid.*

In the tetrahedron, whose vertices are a, b, c, d , let the opposite faces be A, B, C, D , and the perpendicular from a on A, x_0 , from b on B, y_0 , &c. Also let the feet of these perpendiculars be $\alpha, \beta, \gamma, \delta$. Then since in a spherical

* The equilateral hyperboloid is defined as one which admits of three generators mutually at right angles, see Ex. 21 Art. 121. Schröter, as there referred to p. 205, gives these theorems. The first part of the theorem was given by Steiner, *Crelle* 2, p. 98. The second part of the theorem and the determination of the centre Ex. 3 are referred by Baltzer to Joachimsthal, *Grunert Archiv*, 32, p. 109. Ex. 4 is referred to Monge, *Corresp. sur l'Ecole Polytech.* II. p. 266.

triangle the perpendiculars intersect, the planes through each edge of the solid angle (a) perpendicular to the opposite face intersect in a right line. This right line therefore, meets the perpendiculars y_0, z_0, w_0 , and as it passes through (a), also x_0 . In like manner at each other vertex we have a right line meeting those four right lines. They, therefore, belong to the same system of generators of a hyperboloid.

Again, taking through y_0 a parallel plane ϵ to x_0 , this plane is orthogonal both to B and also to A , and, therefore, to their edge of intersection cd . Therefore this plane passes through a perpendicular of the triangle A .

Repeating this we see that the plane ϵ' through z_0 parallel to x_0 passes through the perpendicular from c on bd in the same triangle A . Thus the intersection $\epsilon\epsilon'$, which is parallel to x_0 , is the perpendicular to A at its orthocentre. This line $\epsilon\epsilon'$ is manifestly a generator of the second system of the above hyperboloid, which contains the four perpendiculars of the tetrahedron.

Further, the plane A intersects this hyperboloid in a conic, which passes through bcd and the orthocentre of A , which is, therefore, an equilateral hyperbola; the generators parallel to the asymptotes of this hyperbola and the generator x_0 are an orthogonal system, therefore the hyperboloid is equilateral.

The reader will easily perceive that this example is included in the general theorem.

Ex. 3. If in a tetrahedron a plane be taken through the middle of each edge normal to the opposite edge, these six planes intersect in a point, the centre of the above equilateral hyperboloid.

Ex. 4. In a tetrahedron the line joining the centre of the circumscribed sphere and the centre of the above equilateral hyperboloid is bisected by the centre of gravity of the tetrahedron.

143. The second part of the theorem stated in Article 142 is only the polar reciprocal of the first, but, as an exercise, we give a separate proof of it.

Taking the fundamental tetrahedron and its polar as before, the equations of the four lines are

$$\begin{aligned}x &= 0, & hy + gz + lw &= 0, \\y &= 0, & hx + fz + mw &= 0, \\z &= 0, & gx + fy + nw &= 0, \\w &= 0, & lx + my + nz &= 0.\end{aligned}$$

Now the conditions that any line

$$\alpha x + \beta y + \gamma z + \delta w = 0, \quad \alpha' x + \beta' y + \gamma' z + \delta' w = 0,$$

should intersect each of these are found to be (Art. 57b)

$$\begin{aligned}hv - g\tau + l\pi &= 0, & -hv + f\sigma + m\kappa &= 0, \\g\tau - f\sigma + n\rho &= 0, & -l\pi - m\kappa - n\rho &= 0,\end{aligned}$$

and, as before, the theorem is proved by the fact that these

conditions when added vanish identically. The equation of the hyperboloid is found to be

$$\begin{aligned} & x^2ghl + y^2hfm + z^2fgn + w^2lmn \\ & + (fyz + lxw)(gm + hn) + (gzx + myw)(hn + fl) \\ & + (hxy + nzw)(fl + gm). \end{aligned}$$

As a particular case of these theorems the lines joining each vertex of a circumscribing tetrahedron to the point of contact of the opposite face are generators of the same hyperboloid.

144. Pascal's theorem for conics may be stated as follows: "The sides of any triangle intersect a conic in six points lying in pairs on three lines which intersect each the opposite side of the triangle in three points lying in one right line." M. Chasles has stated the following as an analogous theorem for space of three dimensions: "The edges of a tetrahedron intersect a quadric in twelve points, through which can be drawn four planes, each containing three points lying on edges passing through the same angle of the tetrahedron; then the lines of intersection of each such plane with the opposite face of the tetrahedron are generators of the same system of a certain hyperboloid."

Let the faces of the tetrahedron be x, y, z, w , and the quadric

$$\begin{aligned} x^2 + y^2 + z^2 + w^2 - \left(f + \frac{1}{f}\right)yz - \left(g + \frac{1}{g}\right)zx - \left(h + \frac{1}{h}\right)xy \\ - \left(l + \frac{1}{l}\right)xw - \left(m + \frac{1}{m}\right)yw - \left(n + \frac{1}{n}\right)zw, \end{aligned}$$

then the four planes may be written

$$\begin{aligned} x &= hy + gz + lw, & y &= hx + fz + mw, \\ z &= gx + fy + nw, & w &= lx + my + nz, \end{aligned}$$

whose intersections with the planes x, y, z, w , respectively, are a system of lines proved in the last article to be generators of the same hyperboloid.

144a. The conception of a Brianchon's hexagon may be extended to space, and we may denote by this name any hexagon whose diagonals meet in a point. Now it is evident

that if this be the case, each pair of opposite sides of the hexagon intersect; and, conversely, if in any skew hexagon each pair of opposite sides intersect, the diagonals are concurrent. Thus three alternate sides of such a hexagon are met each by the other three, hence the odd sides belong to one set of generators of a hyperboloid of one sheet and the even to the other. Conversely, any hexagon whose sides lie in a hyperboloid is a Brianchon's hexagon.*

It is further not difficult to see that if any hexagon U in space and a point (a) are given, and through (a) three right lines are drawn cutting the opposite sides of the hexagon in pairs, their intersections on consecutive sides of U are consecutive vertices of a Brianchon's hexagon V , having (a) as its Brianchon point. This hexagon V inscribed in U determines uniquely a hyperboloid on which it lies. But again this hyperboloid is cut by the sides of the given hexagon U in six other points, which in the same order are the vertices of a second Brianchon's hexagon inscribed in the given one and lying on the same hyperboloid, but having a different Brianchon point.

144b. Considering further this conception of a Brianchon's hexagon, there is at each vertex a tangent plane, and this contains the two sides which meet in that vertex. Now, taking an opposite pair of these six planes, viz. the plane containing the lines 1, 2 and the plane containing the lines 4, 5; since 1 meets 4 and 2 meets 5, the line of intersection of these two tangent planes is the same as the line joining the point 1, 4 to 2, 5. In like manner, the axis of 2, 3 with 5, 6 is the same as the ray from 2, 5 to 3, 6; and the axis of 3, 4 with 6, 1 is the same as the ray from 3, 6 to 1, 4. Hence, the three axes of intersection of opposite tangent planes at six points are coplanar. Their plane may be considered a *Pascal plane* to the same hexagon. Thus, in three dimensions both properties meet in the same figure. In fact—

* See a posthumous paper of O. Hesse in the 85th vol. of the Journal founded by Crelle; where, after giving the algebraical treatment of the above geometrically evident statements, Hesse also treats algebraically the question of the two inscribed Brianchon's hexagons derived by aid of an arbitrary point from any skew hexagon.

If the surface and the tangent planes be cut by an arbitrary plane (A), since each tangent plane contains two generators, it will meet (A) in the chord joining two points on the conic of section, and what we have called the Pascal plane will meet (A) in the Pascal line of the inscribed hexagon.

But if the whole figure be looked at from any point (a) to which the contour of the surface affords a real tangent cone, each generator of the surface determines a tangent plane to this cone, and the planes through opposite edges of this circumscribed hexagon have a common line of intersection, the ray to the Brianchon point.

Ex. Analytically we may consider the quadric $yz = wx$, and take the odd sides of the form (1) $x = \lambda_1 y, z = \lambda_1 w$, and the even (2) $x = \lambda_2 z, y = \lambda_2 w$. These two lines meet in the point whose coordinates are proportional to $\lambda_1 \lambda_2, \lambda_2, \lambda_1, 1$, and the equation of the tangent plane at it is $t_{12} = x - \lambda_1 y - \lambda_2 z + \lambda_1 \lambda_2 w = 0$. The Brianchon point will then evidently be the intersection of the planes

$$x - \lambda_1 y - \lambda_4 z + \lambda_1 \lambda_4 w = 0,$$

$$x - \lambda_5 y - \lambda_2 z + \lambda_5 \lambda_2 w = 0,$$

$$x - \lambda_3 y - \lambda_6 z + \lambda_3 \lambda_6 w = 0,$$

its equation therefore is

$$\begin{vmatrix} a, & b, & c, & d \\ 1, & -\lambda_1, & -\lambda_4, & \lambda_1 \lambda_4 \\ 1, & -\lambda_5, & -\lambda_2, & \lambda_5 \lambda_2 \\ 1, & -\lambda_3, & -\lambda_6, & \lambda_3 \lambda_6 \end{vmatrix} = 0,$$

and the equation of what we call the Pascal plane, may be written

$$\begin{vmatrix} x, & y, & z, & w \\ \lambda_1 \lambda_4, & \lambda_4, & \lambda_1, & 1 \\ \lambda_5 \lambda_2, & \lambda_2, & \lambda_5, & 1 \\ \lambda_3 \lambda_6, & \lambda_6, & \lambda_3, & 1 \end{vmatrix} = 0,$$

if we multiply this by

$$\begin{vmatrix} 1, & -\lambda_1, & -\lambda_2, & \lambda_1 \lambda_2 \\ 1, & -\lambda_5, & -\lambda_4, & \lambda_5 \lambda_4 \\ 0, & 0, & 1, & 0 \\ 0, & 0, & 0, & 1 \end{vmatrix},$$

i.e. by $\lambda_1 - \lambda_5$, the result is

$$\begin{vmatrix} t_{12}, & 0, & 0, & (\lambda_3 - \lambda_1) (\lambda_6 - \lambda_2) \\ t_{45}, & 0, & 0, & (\lambda_3 - \lambda_5) (\lambda_6 - \lambda_4) \\ x, & \lambda_1, & \lambda_5, & \lambda_3 \\ w, & 1, & 1, & 1 \end{vmatrix},$$

hence, the value of the determinant is (compare *Conics*, p. 383)

$$(\lambda_3 - \lambda_5) (\lambda_6 - \lambda_4) t_{12} - (\lambda_3 - \lambda_1) (\lambda_6 - \lambda_2) t_{45},$$

with similar forms in t_{23}, t_{56} and in t_{34}, t_{61} : showing that the plane contains the lines $12, t_{45}$, and these other two lines.

Also since for *any* undetermined quantities x, y, z, w

$$\begin{aligned} & \left\| \begin{array}{cccc} x, & y, & z, & w \\ \lambda & \lambda_2, & \lambda_2, & \lambda_1, & 1 \\ \lambda_4 \lambda_5, & \lambda_4, & \lambda_5, & 1 \end{array} \right\| \left\| \begin{array}{cccc} 1, & -\lambda_1, & -\lambda_4, & \lambda_1 \lambda_4 \\ 1, & -\lambda_5, & -\lambda_2, & \lambda_5 \lambda_2 \\ 1, & -\lambda_3, & -\lambda_6, & \lambda_3 \lambda_6 \end{array} \right\| \\ & = \begin{vmatrix} t_{14}, & t_{52}, & t_{36} \\ 0, & 0, & (\lambda_1 - \lambda_3)(\lambda_2 - \lambda_6) \\ 0, & 0, & (\lambda_4 - \lambda_6)(\lambda_5 - \lambda_3) \end{vmatrix} = 0, \end{aligned}$$

every point $xyzw$ is coplanar with the three points 1, 2 ; 4, 5 ; and that whose coordinates are the determinants in the second matrix. Therefore these last three points must be collinear ; which is a verification that the diagonals in our hexagon intersect.

CHAPTER VIII.

FOCI AND CONFOCAL SURFACES.*

145. WHEN U represents a sphere, the equation of a quadric having double contact with it, $U = LM$ expresses, as at *Conics*, Art. 260, that the square of the tangent from any point on the quadric to the sphere is in a constant ratio to the rectangle under the distances of the same point from two fixed planes. The planes L and M are evidently parallel to the planes of circular section of the quadric, since they are planes of its intersection with a sphere; and their intersection is therefore parallel to an axis of the quadric (Arts. 103, 139). We have seen (*Conics*, Art. 261) that the focus of a conic may be considered as an infinitely small circle having double contact with the conic, the chord of contact being the directrix. In like manner we may define a focus of a quadric as an infinitely small sphere having double contact with the quadric, the chord of contact being then the corresponding directrix. That is to say, the point $\alpha\beta\gamma$ is a focus if the equation of the quadric can be expressed in the form

$$(x - \alpha)^2 + (y - \beta)^2 + (z - \gamma)^2 = \phi,$$

where ϕ is the product of the equations of two planes. We must discuss separately, however, the two cases, where these planes are real and where they are imaginary. In the one case the equation is of the form $U = LM$, in the other $U = L^2 + M^2$. In the first case, the directrix (the line LM) is parallel to that axis of the surface through which real planes of circular section can be drawn; for example, to the mean axis if the surface be an ellipsoid. In the second case the line LM is parallel to one of the other axes.

* The properties treated of in this chapter were first studied in detail by M. Chasles and by Professor MacCullagh, who about the same time independently arrived at the principal of them. M. Chasles' results will be found in the notes to his *Aperçu Historique*, published in 1837.

We can shew directly that the line LM is parallel to an axis of the surface. For if the coordinate planes x and y be any two planes mutually at right angles passing through LM ; then since L and M are both of the form $\lambda x + \mu y$, the quantities LM and $L^2 + M^2$ will be both of the form $ax^2 + 2hxy + by^2$. And, as in plane geometry, it is proved that by turning round the coordinate planes x and y , this quantity can be made to take the form $px^2 \pm qy^2$. The equations then, $U = LM$, $U = L^2 + M^2$, written in full, are of the form

$$(x - \alpha)^2 + (y - \beta)^2 + (z - \gamma)^2 = px^2 \pm qy^2,$$

and since the terms yz , zx , xy do not enter into the equation, the axes of coordinates are parallel to the axes of the surface.

146. A focus of a plane curve has been defined (*Higher Plane Curves*, Art. 138) as the point of intersection of two tangents, passing each through one of the circular points at infinity. The definition just given of a focus of a quadric may be stated in an analogous form. When the origin is a focus we have just seen that the equation of the quadric may be written in the form $U = LM$, where U , or $(x - \alpha)^2 + (y - \beta)^2 + (z - \gamma)^2$, denotes a cone whose vertex is the focus, and which passes through the imaginary circle at infinity. The form of the equation shews (Art. 137) that this cone has double contact with the quadric in the points where the line LM meets it. The tangent plane to the surface at either point of contact will then be a tangent plane to the cone, and will therefore pass through a tangent line of the circle at infinity. We may thus define a focus as a point through which can be drawn two lines σ , each touching the surface and meeting the imaginary circle at infinity, and such that the tangent plane to the surface through either also touches the circle at infinity. This definition is not restricted to the case of a quadric, but applies to a surface of any order.

Starting from this definition, if we desire to find the foci of any surface, we should consider the tangent planes to the surface drawn through the tangent lines of the circle at infinity: these form a singly infinite series of planes, and will envelope a developable surface. The intersection of two consecutive such

planes, will be a line σ , and will be a generator of the developable. A focus, being a point through which pass two lines σ , that is to say, two generators of the developable, must be a double point on the developable. Now we shall see hereafter that a developable has in general a series of double points forming a nodal curve or curves; we infer, therefore, that the foci of a surface in general are not detached points, but a series of points forming a curve or curves. We shall shew directly, in the next article, that this is so in the case of a quadric. It is evident from this definition that two surfaces will have the same series of foci, if the developable, just spoken of, passing through the tangent lines of the circle at infinity and enveloping the surface, be common to both.

147. Let us then directly examine whether a given central quadric necessarily has a focus, and whether it has more than one. For greater generality instead of taking the directrix for the axis of z , we take any parallel line, and the equation of the last article becomes

$$(x - \alpha)^2 + (y - \beta)^2 + (z - \gamma)^2 = p(x - \alpha')^2 + q(y - \beta')^2;^*$$

and we are about to enquire whether any values can be assigned to $\alpha, \beta, \gamma, \alpha', \beta', p, q$, which will make this identical with a given equation

$$\frac{x^2}{A} + \frac{y^2}{B} + \frac{z^2}{C} = 1.$$

Now first, in order that the origin may be the centre, we have $\gamma = 0, \alpha = p\alpha', \beta = q\beta'$; by the help of which equations, eliminating α', β' , the form written above becomes

$$(1 - p)x^2 + (1 - q)y^2 + z^2 = \frac{1 - p}{p} \alpha^2 + \frac{1 - q}{q} \beta^2,$$

whence $1 - p = \frac{C}{A}, p = \frac{A - C}{A}; 1 - q = \frac{C}{B}, q = \frac{B - C}{B};$

$$\frac{1 - p}{p} \alpha^2 + \frac{1 - q}{q} \beta^2 = C,$$

or
$$\frac{\alpha^2}{A - C} + \frac{\beta^2}{B - C} = 1.$$

* When p and q have opposite signs the planes of contact of the focus with the quadric are real, while they are imaginary when p and q have the same sign.

Thus it appears that the surface being given, the constants p and q are determined, but that the focus may lie anywhere on the *conic*

$$\frac{\alpha^2}{A-C} + \frac{\beta^2}{B-C} = 1,$$

which accordingly is called a *focal conic* of the surface.

Since we have purposely said nothing as to either the signs or the relative magnitudes of the quantities A, B, C , it follows that there is a focal conic in *each* of the three principal planes, and also that this conic is confocal with the corresponding principal section of the surface; the conics

$$\frac{\alpha^2}{A} + \frac{\beta^2}{B} = 1, \quad \frac{\alpha^2}{A-C} + \frac{\beta^2}{B-C} = 1,$$

being plainly confocal. Any point $\alpha\beta$ on a focal conic being taken for focus, the corresponding directrix is a perpendicular to the plane of the conic drawn through the point

$$\alpha' = \frac{\alpha}{p}, \quad \beta' = \frac{\beta}{q}, \quad \text{or } \alpha' = \frac{A\alpha}{A-C}, \quad \beta' = \frac{B\beta}{B-C}.$$

These values may be interpreted geometrically by saying that the foot of the directrix is the pole, with respect to the principal section of the surface, of the tangent to the focal conic at the point $\alpha\beta$. For this tangent is

$$\frac{\alpha x}{A-C} + \frac{\beta y}{B-C} = 1, \quad \text{or } \frac{\alpha' x}{A} + \frac{\beta' y}{B} = 1,$$

which is manifestly the polar of $\alpha'\beta'$ with regard to $\frac{x^2}{A} + \frac{y^2}{B} = 1$.

Hence, from the theory of plane confocal conics, the line joining any focus to the foot of the corresponding directrix is normal to the focal conic. The feet of the directrices must evidently lie on that conic which is the locus of the poles of the tangents of the focal conic with regard to the corresponding principal section of the quadric. The equation of this conic is

$$x^2 \frac{A-C}{A^2} + y^2 \frac{B-C}{B^2} = 1;$$

for if we eliminate α, β from the equation of the focal conic and the equations connecting $\alpha\beta, \alpha'\beta'$, we obtain this relation

to be satisfied by the latter pair of coordinates. The directrices themselves form a cylinder of which the conic just written is the base.

148. Let us now examine in detail the different classes of central surfaces, in order to investigate the nature of their focal conics and to find to which of the two different kinds of foci the points on each belong. It is plain that the equation

$$\frac{\alpha^2}{A-C} + \frac{\beta^2}{B-C} = 1$$

will represent an ellipse when C is algebraically the least of the three quantities A , B , C ; a hyperbola when C is the middle, and will become imaginary when C is the greatest.

Of the three focal conics therefore of a central quadric, one is always an ellipse, one a hyperbola, and one imaginary. In the case of the ellipsoid, for example, the equations of the focal ellipse and focal hyperbola are respectively

$$\frac{x^2}{a^2 - c^2} + \frac{y^2}{b^2 - c^2} = 1, \quad \frac{x^2}{a^2 - b^2} - \frac{z^2}{b^2 - c^2} = 1.$$

The corresponding equations for the hyperboloid of one sheet are found by changing the sign of c^2 , and those for the hyperboloid of two sheets by changing the sign both of b^2 and c^2 .

Further, we have seen that foci belong to the class whose planes of contact are imaginary, or are real, according as p and q have the same or opposite signs, and that $p = (A - C) : A$, $q = (B - C) : B$. Now if C be the least of the three, in these fractions both numerators are positive, and the denominators are also positive in the case of the ellipsoid and hyperboloid of one sheet, but in the case of the hyperboloid of two sheets one of the denominators is negative. Hence, the points on the focal ellipse are foci of the class whose planes of contact are imaginary in the cases of the ellipsoid and of the hyperboloid of one sheet, but of the opposite class in the case of the hyperboloid of two sheets. Next, let C be the middle of the three quantities; then the two numerators have opposite signs, and the denominators have the same sign in the case of the ellipsoid, but opposite signs in the

case of either hyperboloid. Hence the points of the focal hyperbola belong to the class whose planes of contact are real in the case of the ellipsoid, and to the opposite class in the case of either hyperboloid. It will be observed then that *all* the real foci of the hyperboloid of one sheet belong to the class whose planes of contact are imaginary; but that the focal conics of the other two surfaces contain foci of opposite kinds, the ellipse of the ellipsoid and the hyperbola of the hyperboloid being those whose planes of contact are imaginary. This is equivalent to what appeared (Art. 145) that foci having real planes of contact can only lie in planes perpendicular to that axis of a quadric through which real planes of circular section can be drawn.

149. Focal conics with real planes of contact intersect the surface in real points, while those of the other kind do not. In fact, if the equation of a surface can be thrown into the form $U=L^2+M^2$, and if the coordinates of any point on the surface make $U=0$, they must also make $L=0$, $M=0$; that is to say, the focus must lie on the directrix. But in this case the surface could only be a cone. For taking the origin at the focus, the equation $x^2+y^2+z^2=L^2+M^2$, where L and M each pass through the origin, would contain no terms except those of the highest degree in the variables, and would therefore represent a cone (Art. 66).

The focal conic on the other hand, which consists of foci of the first kind, passes through the umbilics. For if the equation of the surface can be thrown into the form $U=LM$, and the coordinates of a point on the surface make $U=0$, they must also make either L or $M=0$. But since the surface passes through the intersection of U , L ; if the point U lies on L , the plane L intersects the surface in an infinitely small circle; that is to say, is a tangent at an umbilic.

From the fact that focal conics which consist of foci having real planes of contact pass through the umbilics, Professor Mac Cullagh gave them the name *umbilicar* focal conics.

150. The section of the quadric by a plane passing through a focus and the corresponding directrix is a conic having the same point and line for focus and directrix. For, taking the

origin at the focus, the equation is either $x^2 + y^2 + z^2 = LM$, or $x^2 + y^2 + z^2 = L^2 + M^2$. And if we make $z = 0$, the equation of the section is $x^2 + y^2 = lm$ or $= l^2 + m^2$, where l, m are the sections of L, M by the plane z . But if this plane pass through LM , these sections coincide, and the equation reduces to $x^2 + y^2 = l^2$, which represents a conic having the origin for the focus and l for the directrix. Since the plane joining the focus and directrix is normal to the focal conic (Art. 147); we may state the theorem just proved, as follows: Every plane section normal to a focal conic has for a focus the point where it is normal to the focal conic.

151. If the given quadric were a cone $\frac{x^2}{A} + \frac{y^2}{B} + \frac{z^2}{C} = 0$, the reduction of the equation to the form $U = L^2 \pm M^2$ proceeds exactly as before, and it is proved that the coordinates of the focus must fulfil the condition $\frac{\alpha^2}{A-C} + \frac{\beta^2}{B-C} = 0$, which represents either two right lines or an infinitely small ellipse, according as $A - C$ and $B - C$ have opposite or the same signs. In other words, in this case the focal hyperbola becomes two right lines, while the focal ellipse contracts to the vertex of the cone. For the cone $\frac{x^2}{a^2} + \frac{y^2}{b^2} - \frac{z^2}{c^2} = 0$, the equation of the focal

$$\text{lii} \quad \frac{x^2}{a^2 - b^2} - \frac{z^2}{b^2 + c^2} = 0.$$

The focal lines of the cone, asymptotic to any hyperboloid, are plainly the asymptotes to the focal hyperbola of the surface.

The foci on the focal lines are all of the class whose planes of contact are imaginary; but the vertex itself, besides being in two ways a focus of this kind, may also be a focus of the other kind, for the equation of the cone just written takes any of the three forms

$$\begin{aligned} x^2 + y^2 + z^2 &= \frac{a^2 + c^2}{a^2} x^2 + \frac{b^2 + c^2}{b^2} y^2, \\ \text{or} \quad &= \frac{a^2 - b^2}{a^2} x^2 + \frac{b^2 + c^2}{c^2} z^2, \quad \text{or} \quad = \frac{b^2 - a^2}{b^2} y^2 + \frac{a^2 + c^2}{c^2} z^2. \end{aligned}$$

The directrix, which corresponds to the vertex considered as a focus, passes through it.

The line joining any point on a focal line to the foot of the corresponding directrix is perpendicular to that focal line. This follows as a particular case of what has been already proved for the focal conics in general, but may also be proved directly. The coordinates of the foot of the directrix have been proved to be $\alpha' = \frac{A\alpha}{A-C}$, $\beta' = \frac{B\beta}{B-C}$, the equation of the line joining this point to $\alpha\beta$ is

$$\frac{\beta}{B-C}x - \frac{\alpha}{A-C}y = \alpha\beta \left(\frac{1}{B-C} - \frac{1}{A-C} \right),$$

and the condition that this should be perpendicular to the focal line $\beta x = \alpha y$ is $\frac{\alpha^2}{A-C} + \frac{\beta^2}{B-C} = 0$, which we have already seen is satisfied.

In like manner, as a particular case of Art. 150, the section of a cone by a plane perpendicular to either of its focal lines is a conic of which the point in the focal line is a focus. The focal lines of this article are therefore identical with those defined (Art. 125).

152. *The focal lines of a cone are perpendicular to the circular sections of the reciprocal cone (see Art. 125).*

For the circular sections of the cone $Ax^2 + By^2 + Cz^2 = 0$, are (see Art. 103) parallel to the planes

$$(A-C)x^2 + (B-C)y^2 = 0,$$

and the corresponding focal lines of the reciprocal cone $\frac{x^2}{A} + \frac{y^2}{B} + \frac{z^2}{C} = 0$, are, as we have just seen, $\frac{x^2}{A-C} + \frac{y^2}{B-C} = 0$, and the lines represented by the latter equation are evidently perpendicular to the planes represented by the former.

153. The investigation of the foci of the other species of quadrics proceeds in like manner. Thus for the paraboloids included in the equation $\frac{x^2}{A} + \frac{y^2}{B} = 2z$; this equation can be written in either of the forms

$$(x - \alpha)^2 + y^2 + (z - \gamma)^2 = \frac{A-B}{A} \left(x - \frac{A}{A-B} \alpha \right)^2 + (z - \gamma + B)^2,$$

where
$$\frac{\alpha^2}{A-B} = 2\gamma - B,$$

or
$$x^2 + (y - \beta)^2 + (z - \gamma)^2 = \frac{B-A}{B} \left(y - \frac{B}{B-A} \beta \right)^2 + (z - \gamma + A)^2,$$

where
$$\frac{\beta^2}{B-A} = 2\gamma - A.$$

It thus appears that a paraboloid has two focal parabolas, which may easily be seen to be each confocal with the corresponding principal section. The focus belongs to one or other of the two kinds already discussed, according to the sign of the fraction $(A - B) : A$. In the case of the elliptic paraboloid therefore, where both A and B are positive, if A be the greater, then the foci in the plane xz are of the class whose planes of contact are imaginary, while those in the plane yz are of the opposite class. But since if we change the sign either of A or of B , the quantity $(A - B) : A$ remains positive, we see that *all* the foci of the hyperbolic paraboloid belong to the former class, a property we have already seen to be true of the hyperboloid of one sheet.

It remains true that the line joining any focus to the foot of the corresponding directrix is normal to the focal curve, and that the foot of the directrix is the pole with regard to the principal section of the tangent to the focal conic. The feet of the directrices lie on a parabola, and the directrices themselves generate a parabolic cylinder.

To complete the discussion it remains to notice the foci of the different kinds of cylinders, but it is found without the slightest difficulty that when the base of the cylinder is an ellipse or hyperbola there are two focal lines; namely, lines drawn through the foci of the base parallel to the generators of the cylinder; while, if the base of the cylinder is a parabola, there is one focal line passing in like manner through the focus of the base.

154. The geometrical interpretation of the equation $U = LM$ has been already given. We learn from it this property of foci whose planes of contact are real, that *the square of the distance of any point on a quadric from such a focus is in a constant*

ratio to the product of the perpendiculars let fall from the point on the quadric, on two planes drawn through the corresponding directrix, parallel to the planes of circular section. The corresponding property of foci of the other kind, which is less obvious, was discovered by Professor Mac Cullagh. It is, that the distance of any point on the quadric from such a focus is in a constant ratio to its distance from the corresponding directrix, the latter distance being measured parallel to either of the planes of circular section.

Suppose, in fact, we try to express the distance of the point $x'y'z'$ from a directrix parallel to the axis of z and passing through the point whose x and y are α' , β' , the distance being measured parallel to a directive plane $z = mx$. Then a parallel plane through $x'y'z'$, viz. $z - z' = m(x - x')$ meets the directrix in a point whose x and y of course are α' , β' , while its z is given by the equation $z - z' = m(\alpha' - x')$. The square of the distance required is therefore

$$(x' - \alpha')^2 + (y' - \beta')^2 + m^2(x' - \alpha')^2 = (y' - \beta')^2 + (1 + m^2)(x' - \alpha')^2.$$

In the equation then of Art. 147,

$$(x - \alpha)^2 + (y - \beta)^2 + z^2 = p(x - \alpha')^2 + q(y - \beta')^2,$$

where p and q are both positive, and p is supposed greater than q , the right-hand side denotes q times the square of the distance of the point on the quadric from the directrix, the distance being measured parallel to the plane $z = mx$ where $m^2 = (p - q) : q$. By putting in the values of p and q , given in Art. 147, it may be seen that this is a plane of circular section, but it is evident geometrically that this must be the case. For consider the section of the quadric by any plane parallel to the directive plane, and since evidently the distances of every point in such a section are measured from the same point on the directrix, the distance therefore of every point in the section from this fixed point is in a constant ratio to its distance from the focus. But when the distances of a variable point from two fixed points have to each other a constant ratio, the locus is a sphere. The section therefore is the intersection of a plane and a sphere; that is, a circle.

An exception occurs when the distance from the focus is

to be *equal* to the distance from the directrix. Since the locus of a point equidistant from two fixed points is a plane, it appears as before, that in this case the sections parallel to the directive plane are right lines. By referring to the previous articles, it will be seen (see Art. 153) that the ratio we are considering is one of equality ($q = 1$) only in the case of the hyperbolic paraboloid, a surface which the directive plane could not meet in circular sections, seeing that it has not got any. Professor MacCullagh calls the ratio of the focal distance to that from the directrix, the modulus of the surface, and the foci having imaginary planes of contact, he calls modular foci.*

155. It was observed (Art. 137) that all quadrics of the form $U - LM$ are enveloped by two cones, and when U represents a sphere, these are cones of revolution as every cone enveloping a sphere must be. Further, when U reduces to a point-sphere, these cones coincide in a single one, having that point for its vertex; and we may therefore infer that the cone enveloping a quadric and having any focus for its vertex is one of revolution.

This theorem being of importance, we give a direct algebraical proof of it. First, it will be observed, that any equation of the form $x^2 + y^2 + z^2 = (ax + by + cz)^2$ represents a right cone. For if the axes be transformed, remaining rectangular, but so that the plane denoted by $ax + by + cz$ may become one of the coordinate planes, the equation of the cone will become $X^2 + Y^2 + Z^2 = \lambda X^2$, which denotes a cone of revolution, since the coefficients of Y^2 and Z^2 are equal.

* In the year 1836 Professor MacCullagh published this modular method of generation of quadrics. In 1842 I published the supplementary property possessed by the non-modular foci. Not long after, M. Amyot independently noticed the same property, but owing to his not being acquainted with Professor MacCullagh's method of generation, M. Amyot failed to obtain the complete theory of the foci. Professor MacCullagh has published a detailed account of the focal properties of quadrics, which will be found in the *Proceedings of the Royal Irish Academy*, vol. II., p. 446: reprinted at p. 260 of his *Collected Works*, Dublin, 1880. Mr. Townsend also has published a valuable paper (*Cambridge and Dublin Mathematical Journal*, vol. III., pp. 1, 97, 148) in which the properties of foci, considered as the limits of spheres having double contact with a quadric, are very fully investigated.

But now if we form, by the rule of Art. 78, the equation of the cone whose vertex is the origin and circumscribing $x^2 + y^2 + z^2 - L^2 - M^2$, where

$$L = ax + by + cz + d, \quad M = a'x + b'y + c'z + d',$$

it is found to be

$$(d^2 + d'^2)(x^2 + y^2 + z^2 - L^2 - M^2) + (dL + d'M)^2 = 0,$$

or
$$(d^2 + d'^2)(x^2 + y^2 + z^2) - (d'L - dM)^2 = 0,$$

which we have seen represents a right cone.

COR. Since, in reciprocation, the circumscribing cone whose vertex is the origin corresponds to the asymptotic cone of the reciprocal surface, it follows from this article, that *the reciprocal of a quadric with regard to any focus is a surface of revolution.*

A few additional properties of foci easily deduced from the principles laid down are left as an exercise to the reader.

Ex. 1. The polar of any directrix is the tangent to the focal conic at the corresponding focus.

Ex. 2. The polar plane of any point on a directrix is perpendicular to the line joining that point to the corresponding focus.

Ex. 3. If a line be drawn through a fixed point O cutting any directrix of a quadric, and meeting the quadric in the points A, B ; then if F be the corresponding focus, $\tan \frac{1}{2}AFO \cdot \tan \frac{1}{2}BFO$ is constant. This is proved as the corresponding theorem for plane conics. *Conics*, Art. 226, Ex. 8.

Ex. 4. This remains true if the point O move on any other quadric having the same focus, directrix, and planes of circular section.

Ex. 5. If two such quadrics be cut by any line passing through the common directrix, the angles subtended at the focus by the intercepts are equal.

Ex. 6. If a line through a directrix touch one of the quadrics, the chord intercepted on the other subtends a constant angle at the focus.

156. The product of the perpendiculars from the two foci of a surface of revolution round the transverse axis, on any tangent plane, is evidently constant. Now if we reciprocate this property with regard to any point by the method used in Art. 126, we learn that the square of the distance from the origin of any point on the reciprocal surface is in a constant ratio to the product of the distances of the point from two fixed planes.

It appears from Art. 126, Ex. 5, that the two planes are planes of circular section of the asymptotic cone to the new surface, and therefore of the new surface itself. The intersection of the two planes is the reciprocal of the line joining the two foci; that is to say, of the axis of the surface of revolution. The property just proved,* belongs as we know (Art. 154) to every point on the umbilicar focal conic; hence the reciprocal of any quadric with regard to an umbilicar focus, is a surface of revolution round the tranverse axis; but with regard to a modular focus is a surface of revolution round the conjugate axis.

By reciprocating properties of surfaces of revolution, we obtain properties of any quadric with regard to focus and corresponding directrix. It is to be noted, that the axis of the figure of revolution of either kind is the reciprocal of the directrix corresponding to the given focus; and is parallel to the tangent to the focal conic at the given focus (see Art. 147).

The left-hand column contains properties of surfaces of revolution, the right-hand of quadrics in general.

Ex. 1. The tangent cone whose vertex is any point on the axis is a right cone whose tangent planes make a constant angle with the plane of contact, which plane is perpendicular to the axis.

The cone whose vertex is a focus and base any section whose plane passes through the corresponding directrix, is a right cone, whose axis is the line joining the focus to the pole of the plane of section, and this right line is perpendicular to the plane through focus and directrix.

Ex. 2. Any tangent plane is at right angles with the plane through the point of contact and the axis.

The line joining a focus to any point on the surface is at right angles to the line joining the focus to the point where the corresponding tangent plane meets the directrix.

Ex. 3. The polar plane of any point is at right angles to the plane containing that point and the axis.

The line joining a focus to any point is at right angles to the line joining the focus to the point where the polar plane meets the directrix.

* It was in this way I was first led to this property, and to observe the distinction between the two kinds of foci.

Ex. 4. Any two conjugate lines are such that the planes joining them to the focus are at right angles. (Ex. 7, Art. 126).

Ex. 5. If a cone circumscribe a surface of revolution, one principal plane is the plane of vertex and axis.

Ex. 6. The cone whose vertex is a focus and base any plane section is a right cone. (Ex. 2, Art. 126).

Any two conjugate lines pierce a plane through a directrix parallel to circular sections, in two points which subtend a right angle at the corresponding focus.

The cone whose base is *any* plane section of a quadric and vertex any focus has for one axis the line joining focus to the point where the plane meets the directrix.

The cone is a right cone whose vertex is a focus and base the section made by any tangent cone on a plane through the corresponding directrix parallel to those of the circular sections.

FOCAL CONICS AND CONFOCAL SURFACES.

157. In the preceding section an account has been given of the relations which each focus of a quadric considered separately bears to the surface. We shall in this section give an account of the properties of the conics which are the assemblage of foci, and of the properties of confocal surfaces. And we commence by pointing out a method by which we should be led to the consideration of the focal conics of a quadric independently of the method followed in the last section.

Two concentric and coaxial conics are said to be confocal when the difference of the squares of the axes is the same for both. Thus given an ellipse $\frac{x^2}{a^2} + \frac{y^2}{b^2} = 1$, any conic is confocal with it whose equation is of the form

$$\frac{x^2}{a^2 \pm \lambda^2} + \frac{y^2}{b^2 \pm \lambda^2} = 1.$$

If we give the positive sign to λ^2 , the confocal conic will be an ellipse; it will also be an ellipse when λ^2 is negative as long as it is less than b^2 . When λ^2 is between b^2 and a^2 the confocal curve is a hyperbola, and when λ^2 is greater than a^2 the curve is imaginary. If $\lambda^2 = b^2$, the equation reducing itself to $y^2 = 0$, the axis of x itself is the limit which separates con-

focal ellipses from hyperbolas. But the two foci belong to this limit in a special sense. In fact, through a given point $x'y'$ can in general be drawn two conics confocal to a given one, since we have a quadratic to determine λ^2 , viz.

$$\frac{x'^2}{a^2 - \lambda^2} + \frac{y'^2}{b^2 - \lambda^2} = 1,$$

or $\lambda^4 - \lambda^2 (a^2 + b^2 - x'^2 - y'^2) + a^2 b^2 - b^2 x'^2 - a^2 y'^2 = 0.$

When $y' = 0$ this quadratic becomes $(\lambda^2 - b^2)(\lambda^2 - a^2 + x'^2) = 0$, and *one* of its roots is $\lambda^2 = b^2$; but if we have also $x'^2 = a^2 - b^2$, the second root is also $\lambda^2 = b^2$, and therefore the two foci are in a special sense points corresponding to the value $\lambda^2 = b^2$. If in the equation $\frac{x^2}{a^2 - \lambda^2} + \frac{y^2}{b^2 - \lambda^2} = 1$, we make $\lambda^2 = b^2$, $\frac{y^2}{b^2 - \lambda^2} = 0$, we get the equation of the two foci $\frac{x^2}{a^2 - b^2} = 1.$

158. Now in like manner two quadrics are said to be confocal if the differences of the squares of the axes be the same for both. Thus given the ellipsoid $\frac{x^2}{a^2} + \frac{y^2}{b^2} + \frac{z^2}{c^2} = 1$, any surface is confocal whose equation is of the form

$$\frac{x^2}{a^2 \pm \lambda^2} + \frac{y^2}{b^2 \pm \lambda^2} + \frac{z^2}{c^2 \pm \lambda^2} = 1.$$

If we give λ^2 the positive sign, or if we take it negative and less than c^2 , the surface is an ellipsoid. A sphere of infinite radius is the limit of all ellipsoids of the system, being what the equation represents when $\lambda^2 = \infty$. When λ^2 is negative and between c^2 and b^2 the surface is a hyperboloid of one sheet. When it is between b^2 and a^2 it is a hyperboloid of two sheets. When $\lambda^2 = c^2$ the surface reduces itself to the plane $z = 0$, but if we make in the equation $\lambda^2 = c^2$, $\frac{z^2}{\lambda^2 - c^2} = 0$, the points on the conic thus found, viz. $\frac{x^2}{a^2 - c^2} + \frac{y^2}{b^2 - c^2} = 1$, belong in a special sense to the limit separating ellipsoids and hyperboloids. In fact, in general through any point $x'y'z'$ can be drawn three surfaces confocal to a given one; for regarding λ^2 as the unknown

quantity, we have evidently a cubic for the determination of it; namely,

$$\frac{x'^2}{a^2 - \lambda^2} + \frac{y'^2}{b^2 - \lambda^2} + \frac{z'^2}{c^2 - \lambda^2} = 1,$$

$$\text{or } x'^2 (b^2 - \lambda^2) (c^2 - \lambda^2) + y'^2 (c^2 - \lambda^2) (a^2 - \lambda^2) + z'^2 (a^2 - \lambda^2) (b^2 - \lambda^2) \\ = (a^2 - \lambda^2) (b^2 - \lambda^2) (c^2 - \lambda^2).$$

If $z' = 0$, one of the roots of this cubic is $\lambda^2 = c^2$, the other two being given by the equation

$$x'^2 (b^2 - \lambda^2) + y'^2 (a^2 - \lambda^2) = (a^2 - \lambda^2) (b^2 - \lambda^2),$$

and a root of *this* equation will also be $\lambda^2 = c^2$, if

$$\frac{x'^2}{a^2 - c^2} + \frac{y'^2}{b^2 - c^2} = 1.$$

The points on the focal ellipse therefore belong in a special sense to the value $\lambda^2 = c^2$. In like manner the plane $y = 0$ separates hyperboloids of one sheet from those of two, and to this limit belongs in a special sense the hyperbola in that plane $\frac{x^2}{a^2 - b^2} + \frac{z^2}{c^2 - b^2} = 1$. The focal conic in the third principal plane is imaginary.

159. *The three quadrics which can be drawn through a given point confocal to a given one are respectively an ellipsoid, a hyperboloid of one sheet, and one of two.* For if we substitute in the cubic of the last article successively

$$\lambda^2 = a^2, \lambda^2 = b^2, \lambda^2 = c^2, \lambda^2 = -\infty,$$

we get results successively $+ - + -$, which prove that the equation has always three real roots, one of which is less than c^2 , the second between c^2 and b^2 , and the third between b^2 and a^2 ; and it was shown in the last article that the surfaces corresponding to these values of λ^2 are respectively an ellipsoid, a hyperboloid of one sheet, and one of two.

160. Another convenient way of solving the problem to describe through a given point quadrics confocal to a given one, is to take for the unknown quantity the primary axis of the sought confocal surface. Then since we are given

$a'^2 - b'^2$ and $a'^2 - c'^2$ which we shall call h^2 and k^2 , we have the equation

$$\frac{x'^2}{a'^2} + \frac{y'^2}{a'^2 - h^2} + \frac{z'^2}{a'^2 - k^2} = 1,$$

or

$$a'^6 - a'^4 (h^2 + k^2 + x'^2 + y'^2 + z'^2) + a'^2 \{h^2 k^2 + x'^2 (h^2 + k^2) + y'^2 k^2 + z'^2 h^2\} - x'^2 h^2 k^2 = 0.$$

From this equation we can at once express the coordinates of the intersection of three confocal surfaces in terms of their axes. Thus if a'^2 , a''^2 , a'''^2 be the roots of the above equation, the last term of it gives us at once $x'^2 h^2 k^2 = a'^2 a''^2 a'''^2$, or

$$x'^2 = \frac{a'^2 a''^2 a'''^2}{(a^2 - b^2)(a^2 - c^2)}.$$

And by parity of reasoning, since we might have taken b^2 or c^2 for our unknown, we have

$$y'^2 = \frac{b'^2 b''^2 b'''^2}{(b^2 - a^2)(b^2 - c^2)}, \quad z'^2 = \frac{c'^2 c''^2 c'''^2}{(c^2 - a^2)(c^2 - b^2)}. *$$

N.B. In the above we suppose b'^2 , b''^2 , &c., to involve their signs implicitly. Thus c'''^2 belonging to a hyperboloid of one sheet is essentially negative, as are also b'''^2 and c'''^2 .

161. The preceding cubic also enables us to express the radius vector to the point of intersection in terms of the axes. For the second term of it gives us

$$x'^2 + y'^2 + z'^2 + (a^2 - b^2) + (a^2 - c^2) = a'^2 + a''^2 + a'''^2,$$

or

$$x'^2 + y'^2 + z'^2 = a'^2 + b'^2 + c'^2.$$

This expression might also have been worked out directly from the values given for x'^2 , y'^2 , z'^2 in the last article, by a process which may be employed in reducing other symmetrical functions of these coordinates. For on substituting the preceding values and reducing to a common denominator, $x'^2 + y'^2 + z'^2$ becomes

$$\frac{a'^2 a''^2 a'''^2 (b^2 - c^2) + b'^2 b''^2 b'''^2 (c^2 - a^2) + c'^2 c''^2 c'''^2 (a^2 - b^2)}{(b^2 - c^2)(a^2 - c^2)(a^2 - b^2)}.$$

* These expressions enable us easily to remember the coordinates of the umbilics. The umbilics are the points (Art. 149) where *e.g.* an ellipsoid is met by its focal hyperbola. But for the focal hyperbola $a''^2 = a'''^2 = a^2 - b^2$. The coordinates are therefore

$$x^2 = a^2 \frac{a^2 - b^2}{a^2 - c^2}, \quad y = 0, \quad z^2 = c^2 \frac{b^2 - c^2}{a^2 - c^2}.$$

But the numerator obviously vanishes if we suppose either $b^2 = c^2$, $c^2 = a^2$, $a^2 = b^2$. It is therefore divisible by the denominator. The division then is performed as follows: Any term, for example $a'^2 a''^2 a'''^2 c^2$, when divided by $a^2 - b^2$ (or by its equal $a'^2 - b'^2$) gives a quotient $a''^2 a'''^2 c^2$, and a remainder $b'^2 a''^2 a'''^2 c^2$. This remainder divided by $a''^2 - b''^2$ gives a quotient $b'^2 a'''^2 c^2$ and a remainder $b'^2 b''^2 a'''^2 c^2$, which divided in like manner by $a'''^2 - b'''^2$ gives a quotient $b'^2 b''^2 c^2$ and a remainder $b'^2 b''^2 b'''^2 c^2$, which is destroyed by another term in the dividend. Proceeding step by step in this manner we get the result already obtained.

162. *Two confocal surfaces cut each other everywhere at right angles.*

Let $x'y'z'$ be any point common to the two surfaces, p' and p'' the lengths of the perpendiculars from the centre on the tangent plane to each at that point, then (Art. 89) the direction-cosines of these two perpendiculars are

$$\frac{p'x'}{a'^2}, \frac{p'y'}{b'^2}, \frac{p'z'}{c'^2}; \frac{p''x''}{a''^2}, \frac{p''y''}{b''^2}, \frac{p''z''}{c''^2}.$$

And the condition that the two should be at right angles, is, (Art. 13)

$$p'p'' \left\{ \frac{x'^2}{a'^2 a''^2} + \frac{y'^2}{b'^2 b''^2} + \frac{z'^2}{c'^2 c''^2} \right\} = 0.$$

But since the coordinates $x'y'z'$ satisfy the equations of both surfaces we have

$$\frac{x'^2}{a'^2} + \frac{y'^2}{b'^2} + \frac{z'^2}{c'^2} = 1, \quad \frac{x''^2}{a''^2} + \frac{y''^2}{b''^2} + \frac{z''^2}{c''^2} = 1.$$

And if we subtract one of these equations from the other, and remember that $a''^2 - a'^2 = b''^2 - b'^2 = c''^2 - c'^2$, the remainder is

$$(a''^2 - a'^2) \left\{ \frac{x'^2}{a'^2 a''^2} + \frac{y'^2}{b'^2 b''^2} + \frac{z'^2}{c'^2 c''^2} \right\} = 0,$$

which was to be proved.

At the point therefore where three confocals intersect, each tangent plane cuts the other two perpendicularly, and the tangent plane to any one contains the normals to the other two.

163. *If a plane be drawn through the centre parallel to any tangent plane to a quadric, the axes of the section made by that*

plane are parallel to the normals to the two confocals through the point of contact.

It has been proved that the parallels to the normals are at right angles to each other, and it only remains to be proved that they are conjugate diameters in their section. But (Art. 94) the condition that two lines should be conjugate diameters is

$$\frac{\cos \alpha \cos \alpha'}{a'^2} + \frac{\cos \beta \cos \beta'}{b'^2} + \frac{\cos \gamma \cos \gamma'}{c'^2} = 0.$$

The direction-cosines then of the normals being

$$\frac{p''x'}{a''^2}, \frac{p''y'}{b''^2}, \frac{p''z'}{c''^2}; \frac{p'''x'}{a'''^2}, \frac{p'''y'}{b'''^2}, \frac{p'''z'}{c'''^2},$$

we have to prove that

$$p''p''' \left\{ \frac{x'^2}{a''^2 a''^2 a''^2} + \frac{y'^2}{b''^2 b''^2 b''^2} + \frac{z'^2}{c''^2 c''^2 c''^2} \right\} = 0.$$

But the truth of this equation appears at once on subtracting one from the other the equations which have been proved in the last article,

$$\frac{x'^2}{a'^2 a'^2} + \frac{y'^2}{b'^2 b'^2} + \frac{z'^2}{c'^2 c'^2} = 0, \quad \frac{x'^2}{a''^2 a''^2} + \frac{y'^2}{b''^2 b''^2} + \frac{z'^2}{c''^2 c''^2} = 0.$$

164. To find the lengths of the axes of the central section of a quadric by a plane parallel to the tangent plane at the point $x'y'z'$.

From the equation of the surface the length of a central radius vector whose direction-angles are α, β, γ is given by the equation

$$\frac{1}{\rho^2} = \frac{\cos^2 \alpha}{a'^2} + \frac{\cos^2 \beta}{b'^2} + \frac{\cos^2 \gamma}{c'^2}.$$

Put for α, β, γ the values given in the last article, and we find for the length of one of these axes,

$$\frac{1}{\rho^2} = p''^2 \left\{ \frac{x'^2}{a''^2 a''^4} + \frac{y'^2}{b''^2 b''^4} + \frac{z'^2}{c''^2 c''^4} \right\}.$$

Now we have the equations,

$$\frac{x'^2}{a''^2 a''^2} + \frac{y'^2}{b''^2 b''^2} + \frac{z'^2}{c''^2 c''^2} = 0,$$

$$\frac{x'^2}{a''^4} + \frac{y'^2}{b''^4} + \frac{z'^2}{c''^4} = \frac{1}{p''^2}.$$

Subtracting we have

$$\frac{x'^2}{a'^2 a''^4} + \frac{y'^2}{b'^2 b''^4} + \frac{z'^2}{c'^2 c''^4} = \frac{1}{p''^2 (a'^2 - a''^2)}.$$

And substituting this value in the expression already found for ρ^2 we get $\rho^2 = a'^2 - a''^2$. In like manner the square of the other axis is $a'^2 - a''^2$.

Hence, if two confocal quadrics intersect, and a radius of one be drawn parallel to the normal to the other at any point of their curve of intersection, this radius is of constant length.

165. Since the product of the axes of a central section by the perpendicular on a parallel tangent plane is equal to abc (Art. 96), we get immediately expressions for the lengths p', p'', p''' . We have

$$p'^2 = \frac{a'^2 b'^2 c'^2}{(a'^2 - a''^2)(a'^2 - a'''^2)}, \quad p''^2 = \frac{a''^2 b''^2 c''^2}{(a''^2 - a'^2)(a''^2 - a'''^2)},$$

$$p'''^2 = \frac{a'''^2 b'''^2 c'''^2}{(a'''^2 - a'^2)(a'''^2 - a''^2)}.$$

These values might have been also obtained by substituting in the equation

$$\frac{1}{p'^2} = \frac{x'^2}{a'^4} + \frac{y'^2}{b'^4} + \frac{z'^2}{c'^4},$$

the values already found for x'^2, y'^2, z'^2 and reducing the resulting value for p'^2 by the method of Art. 161.

The reader will observe the symmetry which exists between these values for p'^2, p''^2, p'''^2 , and the values already found for x'^2, y'^2, z'^2 . If the three tangent planes had been taken as coordinate planes, p', p'', p''' would be the coordinates of the centre of the surface. The analogy then between the values for p', p'', p''' , and those for x', y', z' , may be stated as follows: With the point $x'y'z'$ as centre three confocals may be described having the three tangent planes for principal planes and intersecting in the centre of the original system of surfaces. The axes of the new system of confocals are a', a'', a''' ; b', b'', b''' ; c', c'', c''' . The three tangent planes to the new system are the three principal planes of the original system.

If a central section through $x'y'z'$ be parallel to one of these principal planes (the plane of yz for instance) in the surface to which this latter is a tangent plane, it appears from Art. 164 that the squares of its axes are $a^2 - b^2$, $a^2 - c^2$. It follows then that the directions and magnitudes of the axes of the section are the same, no matter where the point $x'y'z'$ be situated. The squares of the axes are equal, with signs changed, to the squares of the axes of the corresponding focal conic.

166. If D be the diameter of a quadric parallel to the tangent line at any point of its intersection with a confocal, and p the perpendicular on the tangent plane at that point, then pD is constant for every point on that curve of intersection. For the tangent line at any point of the curve of intersection of two surfaces is the intersection of their tangent planes at that point, which in this case (Art. 162) is normal to the third confocal through the point. Hence (Art. 164) $D^2 = a'^2 - a'''^2$, and therefore (Art. 165) $p^2 D^2 = \frac{a''^2 b''^2 c''^2}{a'^2 - a''^2}$ which is constant if a' , a'' be given.

167. *To find the locus of the pole of a given plane with regard to a system of confocal surfaces.*

Let the given plane be $Ax + By + Cz = 1$, and its pole $\xi\eta\zeta$; then we must identify the given equation with

$$\frac{x\xi}{a^2 - \lambda^2} + \frac{y\eta}{b^2 - \lambda^2} + \frac{z\zeta}{c^2 - \lambda^2} = 1,$$

whence $\frac{\xi}{a^2 - \lambda^2} = A$, $\frac{\eta}{b^2 - \lambda^2} = B$, $\frac{\zeta}{c^2 - \lambda^2} = C$.

Eliminating λ^2 between these equations we find, for the equations of the locus,

$$\frac{x}{A} - a^2 = \frac{y}{B} - b^2 = \frac{z}{C} - c^2.$$

The locus is therefore a right line perpendicular to the given plane.

The theorem just proved implicitly contains the solution of the problem, "to describe a surface confocal to a given one to

touch a given plane." For, since the pole of a tangent plane to a surface is its point of contact, it is evident that but one surface can be described to touch the given plane, its point of contact being the point where the locus line just determined meets the plane. The theorem of this article may also be stated—"The locus of the pole of a tangent plane to any quadric, with regard to any confocal, is the normal to the first surface."

168. *To find an expression for the distance between the point of contact of any tangent plane, and its pole with regard to any confocal surface.*

Let $x'y'z'$ be the point of contact of a tangent plane to the surface whose axes are a, b, c ; $\xi\eta\zeta$ the pole of the same plane with regard to the surface whose axes are a', b', c' . Then, as in the last article, we have

$$\frac{x'}{a^2} = \frac{\xi}{a'^2}, \quad \frac{y'}{b^2} = \frac{\eta}{b'^2}, \quad \frac{z'}{c^2} = \frac{\zeta}{c'^2},$$

whence $\xi - x' = \frac{a'^2 - a^2}{a^2} x', \quad \eta - y' = \frac{b'^2 - b^2}{b^2} y', \quad \zeta - z' = \frac{c'^2 - c^2}{c^2} z',$

squaring and adding

$$D^2 = (a'^2 - a^2)^2 \left\{ \frac{x'^2}{a^4} + \frac{y'^2}{b^4} + \frac{z'^2}{c^4} \right\},$$

whence $D = \frac{a'^2 - a^2}{p}$, where p is the perpendicular from the centre on the plane.

169. *The axes of any tangent cone to a quadric are the normals to the three confocals which can be drawn through the vertex of the cone.*

Consider the tangent plane to one of these three surfaces which pass through the vertex $x'y'z'$; then the pole of that plane with regard to the original surface lies (Art. 65) on the polar plane of $x'y'z'$, and (Art. 167) on the normal to the exterior surface. It is therefore the point where that normal meets the polar plane of $x'y'z'$, that is to say, the plane of contact of the cone.

It follows, then (Art. 64), that the three normals meet

this plane of contact in three points, such that each is the pole of the line joining the other two with respect to the section of the surface by that plane. But since this is also a section of the cone, it follows (Art. 71) that the three normals are a system of conjugate diameters of the cone, and since they are mutually at right angles they are its axes.

170. If at any point on a quadric a line be drawn touching the surface and through that line two tangent planes to any confocal, these two planes will make equal angles with the tangent plane at the given point on the first quadric. For, by the last article, that tangent plane is a principal plane of the cone touching the confocal surface and having the given point for its vertex, and the two tangent planes will be tangent planes of that cone. But two tangent planes to any cone drawn through a line in a principal plane make equal angles with that plane.

The *focal cones* (that is to say, the cones whose vertices are any points and which stand on the focal conics) are limiting cases of cones enveloping confocal surfaces, and it is still true that the two tangent planes to a focal cone drawn through any tangent line on a surface make equal angles with the tangent plane in which that tangent line lies. If the surface be a cone its focal conic reduces to two right lines, and the theorem just stated in this case becomes, that any tangent plane to a cone makes equal angles with the planes containing its edge of contact and each of the focal lines. This theorem, however, will be proved independently in Chap. x.

171. It follows, from Art. 169, that if the three normals be made the axes of coordinates, the equation of the cone must take the form $Ax^2 + By^2 + Cz^2 = 0$. To verify this by actual transformation will give us an independent proof of the theorem of Art. 169, and a knowledge of the actual values of A, B, C will be useful to us afterwards.

The equation of the tangent cone given, Art. 78, is

$$\left(\frac{x'^2}{a^2} + \frac{y'^2}{b^2} + \frac{z'^2}{c^2} - 1\right)\left(\frac{x^2}{a^2} + \frac{y^2}{b^2} + \frac{z^2}{c^2} - 1\right) = \left(\frac{xx'}{a^2} + \frac{yy'}{b^2} + \frac{zz'}{c^2} - 1\right)^2.$$

If the axes be transformed to parallel axes passing through the vertex of the cone, this equation becomes, as is easily seen,

$$\left(\frac{x'^2}{a^2} + \frac{y'^2}{b^2} + \frac{z'^2}{c^2} - 1\right) \left(\frac{x^2}{a^2} + \frac{y^2}{b^2} + \frac{z^2}{c^2}\right) = \left(\frac{xx'}{a^2} + \frac{yy'}{b^2} + \frac{zz'}{c^2}\right)^2.$$

Now to transform to the three normals as axes, we have to substitute the direction-cosines of these lines in the formulæ of Art. 17, and we see that we have to substitute

$$\text{for } x, \frac{p'x'}{a'^2} x + \frac{p''x'}{a''^2} y + \frac{p'''x'}{a'''^2} z,$$

$$\text{for } y, \frac{p'y'}{b'^2} x + \frac{p''y'}{b''^2} y + \frac{p'''y'}{b'''^2} z,$$

$$\text{for } z, \frac{p'z'}{c'^2} x + \frac{p''z'}{c''^2} y + \frac{p'''z'}{c'''^2} z.$$

172. In order more easily to see the result of this substitution the following preliminary formulæ will be useful :

Let
$$\frac{x'^2}{a^2} + \frac{y'^2}{b^2} + \frac{z'^2}{c^2} - 1 = S,*$$

then since
$$\frac{x'^2}{a'^2} + \frac{y'^2}{b'^2} + \frac{z'^2}{c'^2} - 1 = 0,$$

we have
$$\frac{x'^2}{a^2 a'^2} + \frac{y'^2}{b^2 b'^2} + \frac{z'^2}{c^2 c'^2} = \frac{S}{a'^2 - a^2}.$$

In like manner
$$\frac{x'^2}{a^2 a''^2} + \frac{y'^2}{b^2 b''^2} + \frac{z'^2}{c^2 c''^2} = \frac{S}{a''^2 - a^2},$$

and hence
$$\frac{x'^2}{a^2 a'^2 a''^2} + \frac{y'^2}{b^2 b'^2 b''^2} + \frac{z'^2}{c^2 c'^2 c''^2} = \frac{S}{(a'^2 - a^2)(a''^2 - a^2)}.$$

Lastly, since
$$\frac{x'^2}{a'^4} + \frac{y'^2}{b'^4} + \frac{z'^2}{c'^4} = \frac{1}{p'^2},$$

and
$$\frac{x'^2}{a'^2 a^2} + \frac{y'^2}{b'^2 b^2} + \frac{z'^2}{c'^2 c^2} = \frac{S}{a'^2 - a^2},$$

we have
$$\frac{x'^2}{a'^4 a^2} + \frac{y'^2}{b'^4 b^2} + \frac{z'^2}{c'^4 c^2} = \frac{S}{(a'^2 - a^2)^2} - \frac{1}{p'^2 (a'^2 - a^2)}.$$

* It may be observed that this quantity S is equal to

$$\frac{(a'^2 - a^2)(a''^2 - a^2)(a'''^2 - a^2)}{a^2 b^2 c^2},$$

for $a^2 - a'^2$, $a^2 - a''^2$, $a^2 - a'''^2$ are the roots of the cubic of Art. 158, whose absolute term is $a^2 b^2 c^2 S$.

173. When now we make the transformation directed, in the left-hand side of the equation of Art. 171, the coefficient of x^2 is found to be

$$p'^2 S \left\{ \frac{x'^2}{a'^4 a^2} + \frac{y'^2}{b'^4 b^2} + \frac{z'^2}{c'^4 c^2} \right\},$$

and that of xy is

$$2p'p'' S \left\{ \frac{x'^2}{a'^2 a'^2 a''^2} + \frac{y'^2}{b'^2 b'^2 b''^2} + \frac{z'^2}{c'^2 c'^2 c''^2} \right\}.$$

The left-hand side therefore of the transformed equation is

$$S^2 \left(\frac{p'x}{a'^2 - a^2} + \frac{p''y}{a''^2 - a^2} + \frac{p'''z}{a'''^2 - a^2} \right)^2 - S \left\{ \frac{x^2}{a'^2 - a^2} + \frac{y^2}{a''^2 - a^2} + \frac{z^2}{a'''^2 - a^2} \right\}.$$

But the quantity $\frac{xx'}{a^2} + \frac{yy'}{b^2} + \frac{zz'}{c^2}$ treated in like manner becomes

$$S \left(\frac{p'x}{a'^2 - a^2} + \frac{p''y}{a''^2 - a^2} + \frac{p'''z}{a'''^2 - a^2} \right).$$

Its square therefore destroys the first group of terms on the other side of the equation, and the equation of the cone becomes

$$\frac{x^2}{a'^2 - a^2} + \frac{y^2}{a''^2 - a^2} + \frac{z^2}{a'''^2 - a^2} = 0,$$

which is the required transformed equation of the tangent cone.

174. As a particular case of the preceding may be found the equation of either focal cone (Art. 170); that is to say, the cone whose vertex is any point $x'y'z'$ and which stands on the focal ellipse or focal hyperbola. These answer to the values $a^2 - c^2$, $a^2 - b^2$ for the square of the primary axis; the equations therefore are

$$\frac{x^2}{c'^2} + \frac{y^2}{c''^2} + \frac{z^2}{c'''^2} = 0,$$

$$\frac{x^2}{b'^2} + \frac{y^2}{b''^2} + \frac{z^2}{b'''^2} = 0.$$

These equations might also have been found, by forming, as in Ex. 7, Art. 121, the equations of the focal cones, and then transforming them as in the last articles.

It may be seen without difficulty that any normal and the corresponding tangent plane meet any of the principal planes

in a point and line which are pole and polar with regard to the focal conic in that plane. This is a particular case of Art. 169.

The formulæ employed in the articles immediately preceding enable us to transform to the same new axes any other equations.

Ex. 1. To transform the equation of the quadric itself to the three normals through any point $x'y'z'$ as axes. The equation transformed to parallel axes becomes

$$\frac{x^2}{a^2} + \frac{y^2}{b^2} + \frac{z^2}{c^2} + S + 2 \left(\frac{xx'}{a^2} + \frac{yy'}{b^2} + \frac{zz'}{c^2} \right) = 0.$$

And when the axes are turned round, we get

$$S \left(\frac{p'x}{a'^2 - a^2} + \frac{p''y}{a''^2 - a^2} + \frac{p'''z}{a'''^2 - a^2} + 1 \right)^2 = \frac{x^2}{a'^2 - a^2} + \frac{y^2}{a''^2 - a^2} + \frac{z^2}{a'''^2 - a^2}.$$

The quantity under the brackets on the left-hand side of the equation is evidently the transformed equation of the polar plane of the point.

Ex. 2. The preceding equation is somewhat modified if the point $x'y'z'$ is on the surface. The equation transformed to parallel axes is

$$\frac{x^2}{a^2} + \frac{y^2}{b^2} + \frac{z^2}{c^2} + 2 \left(\frac{xx'}{a^2} + \frac{yy'}{b^2} + \frac{zz'}{c^2} \right) = 0.$$

Let now
$$p^2 \left\{ \frac{x'^2}{a'^6} + \frac{y'^2}{b'^6} + \frac{z'^2}{c'^6} \right\} = \frac{1}{\gamma^2};$$

then the equation, transformed to the three normals as axes, is

$$\frac{x^2}{\gamma^2} + \frac{y^2}{a^2 - a'^2} + \frac{z^2}{a^2 - a''^2} - \frac{2p'xy}{p(a^2 - a'^2)} - \frac{2p''xz}{p(a^2 - a''^2)} + \frac{2x}{p} = 0.$$

It is to be observed that γ is the diameter parallel to the normal at the point $x'y'z'$, and that we have

$$\frac{1}{\gamma^2} + \frac{1}{a^2 - a'^2} + \frac{1}{a^2 - a''^2} = \frac{1}{a^2} + \frac{1}{b^2} + \frac{1}{c^2};$$

and the transformed equation may be otherwise written

$$\frac{(p'x - py)^2}{a^2 - a'^2} + \frac{(p''x - pz)^2}{a^2 - a''^2} + (x + p)^2 = p^2.$$

Ex. 3. To transform the equation of the reciprocal surface with regard to any point to the three normals through the point. The equation is (Art. 127)

$$(xx' + yy' + zz' + k^2)^2 = a^2x^2 + b^2y^2 + c^2z^2,$$

and the transformed equation is found to be

$$(a'^2 - a^2)x^2 + (a''^2 - a^2)y^2 + (a'''^2 - a^2)z^2 + 2k^2(p'x + p''y + p'''z) + k^4 = 0.$$

175. To return to the equation of the tangent cone (Art. 173). Its form proves that all cones having a common vertex and circumscribing a series of confocal surfaces are coaxial and confocal. For the three normals through the common vertex are axes to every one of the system of cones; and the form of the equation shows that the differences of the squares of the axes are inde-

pendent of a^2 . The equations of the common focal lines of the cones are (Art. 151)

$$\frac{x^2}{a'^2 - a''^2} = \frac{z^2}{a''^2 - a'''^2}; \quad y^2 = 0.$$

But it was proved (Art. 164) that the central section of the hyperboloid of one sheet which passes through $x'y'z'$ is

$$\frac{x^2}{a'^2 - a'^2} + \frac{z^2}{a''^2 - a'''^2} = 1,$$

and the section of the hyperboloid by the tangent plane itself is similar to this, or is also

$$\frac{x^2}{a'^2 - a''^2} - \frac{z^2}{a''^2 - a'''^2} = 0.$$

Hence the focal lines of the system of cones are the generating lines of the hyperboloid which passes through the point—a theorem due to Chasles, *Liouville*, XI. 121, and also noticed by Jacobi (*Crelle*, Vol. XII. p. 137).

This may also be proved thus: Take any edge of one of the system of cones, and through it draw a tangent plane to that cone and also planes containing the generating lines of the hyperboloid; these latter planes are tangent planes to the hyperboloid, and therefore (Art. 170) make equal angles with the tangent plane to the cone. The two generators are therefore such that the planes drawn through them and through any edge of the cone make equal angles with the tangent plane to the cone; but this is a property of the focal lines (Art. 170).

COR. 1. The reciprocals of a system of confocals, with regard to any point, have the same planes of circular section. For the reciprocals of the tangent cones from that point have the same planes of circular section (Art. 152), and these reciprocals are the asymptotic cones of the reciprocal surfaces.

COR. 2. If a system of confocals be projected orthogonally on any plane, the projections are confocal conics. The projections are the sections by that plane of cylinders perpendicular to it, and enveloping the quadrics. And these cylinders may be considered as a system of enveloping cones whose vertex is the point at infinity on the common direction of their generators.

176. *Two confocal surfaces can be drawn to touch a given line.*

Take on the line any point $x'y'z'$; let the axes of the three surfaces passing through it be a', a'', a''' , and the angles the line makes with the three normals α, β, γ . Then it appears, from Art. 173, that a is determined by the *quadratic*

$$\frac{\cos^2\alpha}{a'^2 - a^2} + \frac{\cos^2\beta}{a''^2 - a^2} + \frac{\cos^2\gamma}{a'''^2 - a^2} = 0.$$

If a and a' be the roots of this quadratic, the two cones

$$\frac{x^2}{a'^2 - a^2} + \frac{y^2}{a''^2 - a^2} + \frac{z^2}{a'''^2 - a^2} = 0, \quad \frac{x^2}{a'^2 - a'^2} + \frac{y^2}{a''^2 - a'^2} + \frac{z^2}{a'''^2 - a'^2} = 0$$

have the given line as a common edge, and it is proved, precisely as at Art. 162, that the tangent planes to the cones through this line are at right angles to each other. And since the tangent planes to a tangent cone to a surface, by definition touch that surface, it follows that *the tangent planes drawn through any right line to the two confocals which it touches are at right angles to each other.*

The property that the tangent cones from any point to two intersecting confocals cut each other at right angles is sometimes expressed as follows: *two confocals seen from any point appear to intersect everywhere at right angles.*

177. *If through a given line tangent planes be drawn to a system of confocals, the corresponding normals generate a hyperbolic paraboloid.*

The normals are evidently parallel to one plane; namely, the plane perpendicular to the given line; and if we consider any one of the confocals, then, by Art. 167, the normal to any plane through the line contains the pole of that plane with regard to the assumed confocal, which pole is a point on the polar line of the given line with regard to that confocal. Hence, every normal meets the polar line of the given line with regard to any confocal. The surface generated by the normals is therefore a hyperbolic paraboloid (Art 116). It is evident that the surface generated by the polar lines, just referred to, is the same paraboloid, of which they form the other system of generators.

The points in which this paraboloid meets the given line are the two points where this line touches confocals.

A special case occurs when the given line is itself a normal to a surface U of the system. The normal corresponding to any plane drawn through that line is found by letting fall a perpendicular on that plane from the pole of the same plane with regard to U (Art. 167), but it is evident that both pole and perpendicular must lie in the tangent plane to U to which the given line is normal. Hence, in this case all the normals lie in the same plane.

From the principle that the anharmonic ratio of four planes passing through a line is the same as that of their four poles with regard to any quadric, it is found at once that any four of the normals divide homographically all the polar lines corresponding to the given line with respect to the system of surfaces. In the special case now under consideration, the normals will therefore envelope a conic, which conic will be a parabola, since the normal in one of its positions may lie at infinity; namely, when the surface is an infinite sphere (Art. 158). The point where the given line meets the surface to which it is normal lies on the directrix of this parabola.

178. If α, β, γ be the direction-angles, referred to the three normals through the vertex, of the perpendicular to a tangent plane of the cone of Arts. 171, &c., since this perpendicular lies on the reciprocal cone, α, β, γ must satisfy the relation

$$(a'^2 - a^2) \cos^2 \alpha + (a''^2 - a^2) \cos^2 \beta + (a'''^2 - a^2) \cos^2 \gamma = 0,$$

or
$$a'^2 \cos^2 \alpha + a''^2 \cos^2 \beta + a'''^2 \cos^2 \gamma = a^2.$$

This relation enables us at once to determine the axis of the surface which touches any plane, for if we take any point on the plane, we know a', a'', a''' for that point, as also the angles which the three normals through the point make with the plane, and therefore a^2 is known.

179. If the relation of the last article were proved independently, we should, by reversing the steps of the demonstration, obtain a proof without transformation of coordinates

of the equation of the tangent cone (Art. 173). The following proof is due to M. Chasles: The quantity

$$a'^2 \cos^2 \alpha + a''^2 \cos^2 \beta + a'''^2 \cos^2 \gamma$$

is the sum of the squares of the projections on a perpendicular to the given plane of the lines a' , a'' , a''' . We have seen (Art. 165) that these are the axes of a surface having $x'y'z'$ for its centre and passing through the original centre. And it was proved in the same article that three other conjugate diameters of the same surface are the radius vector from the centre to $x'y'z'$, together with two lines parallel to two axes of the surface and whose squares are $a^2 - b^2$, $a^2 - c^2$. It was also proved (Art. 98) that the sum of the squares of the projections on any line of three conjugate diameters of a quadric is equal to that of any other three conjugate diameters. It follows then that the quantity

$$a'^2 \cos^2 \alpha + a''^2 \cos^2 \beta + a'''^2 \cos^2 \gamma$$

is equal to the sum of the squares of the projections on the perpendicular from the centre on the given plane, of the radius vector, and of two lines whose magnitude and direction are known. The projections of the last two lines are constant, while the projection of the radius vector is the perpendicular itself which is constant if $x'y'z'$ belong to the given plane. It is proved then that the quantity

$$a'^2 \cos^2 \alpha + a''^2 \cos^2 \beta + a'''^2 \cos^2 \gamma$$

is constant while the point $x'y'z'$ moves in a given plane; and it is evident that the constant value is the a^2 of the surface which touches the given plane, since for it we have

$$\cos \alpha = 1, \cos \beta = 0, \cos \gamma = 0.$$

180. *The locus of the intersection of three planes mutually at right angles, each of which touches one of three confocals is a sphere.*

This is proved as in Art. 93.

Add together

$$p^2 = a^2 \cos^2 \alpha + b^2 \cos^2 \beta + c^2 \cos^2 \gamma,$$

$$p'^2 = a'^2 \cos^2 \alpha' + b'^2 \cos^2 \beta' + c'^2 \cos^2 \gamma',$$

$$p''^2 = a''^2 \cos^2 \alpha'' + b''^2 \cos^2 \beta'' + c''^2 \cos^2 \gamma'',$$

when we get $\rho^2 = a^2 + b^2 + c^2 + (a'^2 - a^2) + (a''^2 - a^2)$,

where ρ is the distance from the centre of the intersection of the planes.

Again, by subtracting one from the other, the two equations $p^2 = a^2 \cos^2 \alpha + b^2 \cos^2 \beta + c^2 \cos^2 \gamma$, $p'^2 = a'^2 \cos^2 \alpha + b'^2 \cos^2 \beta + c'^2 \cos^2 \gamma$, we learn that the difference of the squares of the perpendiculars on two parallel tangent planes to two confocals is constant and equal $a^2 - a'^2$.

It may be remarked that the reciprocal of the theorem of Art. 93 is that if from any point O there be drawn three radii vectores to a quadric, mutually at right angles, the plane joining their extremities envelopes a surface of revolution. If O be on the quadric, the plane passes through a fixed point.

181. *Two cones having a common vertex envelope two confocals; to find the length of the intercept made on one of their common edges by a plane through the centre parallel to the tangent plane to a confocal through the vertex.* The intercepts made on the four common edges are of course all equal, since the edges are equally inclined to the plane of section which is parallel to a common principal plane of both cones.

Let there be any two confocal cones

$$\frac{x^2}{\alpha^2} + \frac{y^2}{\beta^2} + \frac{z^2}{\gamma^2} = 0, \quad \frac{x^2}{\alpha'^2} + \frac{y^2}{\beta'^2} + \frac{z^2}{\gamma'^2} = 0,$$

then for their intersection, we have

$$\frac{x^2}{\alpha^2 \alpha'^2 (\beta^2 - \gamma^2)} = \frac{y^2}{\beta^2 \beta'^2 (\gamma^2 - \alpha^2)} = \frac{z^2}{\gamma^2 \gamma'^2 (\alpha^2 - \beta^2)},$$

and if the common value of these be λ^2 , we have

$$x^2 + y^2 + z^2 = \lambda^2 (\alpha^2 - \beta^2) (\beta^2 - \gamma^2) (\alpha^2 - \gamma^2).$$

Putting in the values of α^2 , β^2 , γ^2 from the equations of the tangent cones (Art. 176), and determining λ^2 by the equation

(see Art. 165) $x^2 = \frac{a'^2 b'^2 c'^2}{(\alpha'^2 - a'^2)(\alpha'^2 - a''^2)}$, we get for the square

of the required intercept

$$\frac{a'^2 b'^2 c'^2}{(\alpha'^2 - a^2)(\alpha'^2 - a'^2)}.$$

If then the confocals be all of different kinds this value shews that the intercept is equal to the perpendicular from the centre on the tangent plane at their intersection.

In the particular case where the two cones considered are the cones standing on the focal ellipse, and on the focal hyperbola, we have $a^2 = a^2 - c^2$, $a'^2 = a^2 - b^2$, and the intercept reduces to a' . Hence, *if through any point on an ellipsoid be drawn a chord meeting both focal conics, the intercept on this chord by a plane through the centre parallel to the tangent plane at the point will be equal to the semi-axis-major of the surface.* This theorem, due to Prof. MacCullagh, is analogous to the theorem for plane curves, that a line through the centre parallel to a tangent to an ellipse cuts off on the focal radii portions equal to the semi-axis-major.

182. M. Chasles has used the principles just established to solve the problem to determine the magnitude and direction of the axes of a central quadric being given a system of three conjugate diameters.

Consider first the plane of any two of the conjugate diameters, and we can by plane geometry determine in magnitude and direction the axes of the section by that plane. The tangent plane at P , the extremity of the remaining diameter, will be parallel to the same plane. Now the centre of the given quadric is the point of intersection of three confocals determined as in Art. 165, having the point P for their centre. If now we could construct the focal conics of this new system of confocals, then the two focal cones, whose common vertex is the centre of the original quadric, determine by their mutual intersection four right lines. The six planes containing these four right lines intersect two by two in the directions of the required axes, while (Art. 181) planes through the point P parallel to the principal planes, cut off on these four lines parts equal in length to the axes.

The focal conics required are immediately constructed. We know the planes in which they lie and the directions of their axes. The squares of their semi-axes are to be $a^2 - a''^2$, $a'^2 - a''^2$; $a^2 - a'^2$, $a'^2 - a''^2$. But now the squares of the semi-axes of the given

section are $a^2 - a'^2$, $a^2 - a''^2$ (Art. 164), and these latter axes being known, the axes of the focal conics are immediately found.

183. If through any point P on a quadric a chord be drawn, as in Art. 181, touching two confocals, we can find an expression for the length of that chord. Draw a parallel semi-diameter through the centre, the length of which we shall call R . Now if through P there be drawn a plane conjugate to this diameter, and a tangent plane, they will intercept (counting from the centre) portions on the diameter whose product = R^2 . But the portion intercepted by the conjugate plane is half the chord required, and the portion intercepted by the tangent plane is the intercept found (Art. 181). Hence

$$C = \frac{2R^2 \sqrt{\{(a'^2 - a^2)(a''^2 - a^2)\}}}{a'b'c'}$$

When the chord is that which meets the two focal conics; $a^2 = a'^2 - c'^2$, $a^2 = a''^2 - b''^2$, and $C = \frac{2R^2}{a'}$.

184. *To find the locus of the vertices of right cones which can envelope a given surface.*

In order that the equation $\frac{x^2}{a'^2 - a^2} + \frac{y^2}{a''^2 - a^2} + \frac{z^2}{a'''^2 - a^2} = 0$ may represent a right cone, two of the coefficients must be equal; that is to say, $a'' = a'$, or $a'' = a'''$, or in other words, for the point $x'y'z'$ the equation of Art. 158 must have two equal roots, but from what was proved as to the limits within which the roots lie, it is evident that we cannot have equal roots except when λ is equal to one of the principal semi-axes, or when $x'y'z'$ is on one of the focal conics. This agrees with what was proved (Art. 155).

It appears, hence, as has been already remarked, that the reciprocal of a surface, with regard to a point on a focal conic, is a surface of revolution; and that the reciprocal, with regard to an umbilic, is a paraboloid of revolution. For an umbilic is a point on a focal conic (Art. 149), and since it is on the surface the reciprocal with regard to it is a paraboloid.

Another particular case of this theorem is, that two right cylinders can be circumscribed to a central quadric, the edges

of the cylinders being parallel to the asymptotes of the focal hyperbola. For a cone whose vertex is at infinity is a cylinder.

As a particular case of the theorem of this article, the cone standing on the focal ellipse will be a right cone only when its vertex is on the focal hyperbola, and *vice versa*. This theorem of course may be stated without any reference to the quadrics of which the two conics are focal conics; that *the locus of the vertices of right cones which stand on a given conic is a conic of opposite species in a perpendicular plane*. If the equation of one conic be $\frac{x^2}{a^2} + \frac{y^2}{b^2} = 1$, that of the other will

$$\text{be } \frac{x^2}{a^2 - b^2} - \frac{z^2}{b^2} = 1.$$

It was proved (Ex. 8, Art. 126) that if a quadric circumscribe a surface of revolution, the cone enveloping the former whose vertex is a focus of the latter is of revolution. From this article then we see that the focal conics of a quadric are the locus of the foci of all possible surfaces of revolution which can circumscribe that quadric.

185. It appears from what has been already said that the focal ellipse and hyperbola are in planes at right angles to each other, and such that the vertices of each coincide with the foci of the other. Two conics so related are each (so to speak) a locus of foci of the other; viz. any pair of fixed points F, G on the one conic may be regarded as foci of the other, the sum or difference of the distances FP, GP to a variable point P on the other, being constant.

Taking the equations of the conics

$$\frac{x^2}{a^2} + \frac{y^2}{b^2} = 1, \quad \frac{x^2}{a^2 - b^2} - \frac{z^2}{b^2} = 1,$$

and introducing the parameters θ, ϕ , as at *Conics*, Arts. 229, 232, the coordinates of a point on each conic may be expressed,

$$a \cos \theta, b \sin \theta, 0; \quad \sec \phi \sqrt{(a^2 - b^2)}, 0, b \tan \phi;$$

and the square of the distance between these points is

$$\begin{aligned} & a^2 \cos^2 \theta - 2a \cos \theta \sec \phi \sqrt{(a^2 - b^2)} + (a^2 - b^2) \sec^2 \phi + b^2 \sin^2 \theta + b^2 \tan^2 \phi, \\ & \text{or } a^2 \sec^2 \phi - 2a \cos \theta \sec \phi \sqrt{(a^2 - b^2)} + (a^2 - b^2) \cos^2 \theta \\ & \qquad \qquad \qquad = \{a \sec \phi - \cos \theta \sqrt{(a^2 - b^2)}\}^2. \end{aligned}$$

And, plainly, the sum or difference of two distances

$$\pm \{a \sec \phi - \cos \theta \sqrt{(a^2 - b^2)}\}, \pm \{a \sec \phi - \cos \theta' \sqrt{(a^2 - b^2)}\}$$

is independent of ϕ ; and of two distances

$$\pm \{a \sec \phi - \cos \theta \sqrt{(a^2 - b^2)}\}, \pm \{a \sec \phi' - \cos \theta \sqrt{(a^2 - b^2)}\}$$

is independent of θ .

Attending to the signs the theorem is this, that if we take two fixed points F, G on the ellipse, the difference $FP - GP$ is constant, being $= +\alpha$ when P is a point on one branch of the hyperbola, and $-\alpha$ when P is on the other. In particular, when F, G are the vertices of the ellipse we have the ordinary focal property of the hyperbola. Again, taking F, G two points on different branches of the hyperbola, the sum $FP + GP$ is constant, and when F, G are the vertices of the hyperbola we have the ordinary focal property of the ellipse. If F, G be taken instead on the same branch of the hyperbola, it is the difference between FP and GP which is constant; and if F and G coincide at a vertex, we have merely the identity $FP - FP = 0$, and not a new property of the ellipse *in plano*.

186. The following examples will serve further to illustrate the principles which have been laid down:

Ex. 1. To find the locus of the intersection of generators to a hyperboloid which cut at right angles.

The section parallel to the tangent plane which contains the generators must be an equilateral hyperbola, so that (Art. 164) $(a''^2 - a'^2) + (a''^2 - a'''^2) = 0$. But (Art. 161) the square of the radius vector to the point is

$$a''^2 + b''^2 + c''^2 - (a''^2 - a'^2) - (a''^2 - a'''^2).$$

We have, therefore, the locus a sphere, the square of whose radius is equal to $a''^2 + b''^2 + c''^2$. Otherwise thus: If two generators are at right angles, their plane together with the plane of each and of the normal at the point, are a system of three tangent planes to the surface, mutually at right angles, whose intersection lies on the sphere $r^2 = a''^2 + b''^2 + c''^2$ (Art. 93).

Ex. 2. To find the locus of the intersection of three tangent lines to a quadric mutually at right angles (see Ex. 6, Art. 121).

Let α, β, γ be the angles made by one of these tangents with the normals through the locus point, and since each of these tangents lies in the tangent cone through that point, we have the conditions

$$\begin{aligned} \frac{\cos^2 \alpha}{a'^2 - a^2} + \frac{\cos^2 \beta}{a''^2 - a^2} + \frac{\cos^2 \gamma}{a'''^2 - a^2} &= 0, \\ \frac{\cos^2 \alpha'}{a'^2 - a^2} + \frac{\cos^2 \beta'}{a''^2 - a^2} + \frac{\cos^2 \gamma'}{a'''^2 - a^2} &= 0, \\ \frac{\cos^2 \alpha''}{a'^2 - a^2} + \frac{\cos^2 \beta''}{a''^2 - a^2} + \frac{\cos^2 \gamma''}{a'''^2 - a^2} &= 0, \end{aligned}$$

Adding, we have $\frac{1}{a'^2 - a^2} + \frac{1}{a''^2 - a^2} + \frac{1}{a'''^2 - a^2} = 0$.

But $a^2 - a'^2$, $a^2 - a''^2$, $a^2 - a'''^2$ are the three roots of the cubic of Art. 158 which arranged in terms of λ^2 is

$$\lambda^6 + \lambda^4 (x^2 + y^2 + z^2 - a^2 - b^2 - c^2) - \lambda^2 \{(b^2 + c^2)x^2 + (c^2 + a^2)y^2 + (a^2 + b^2)z^2 - b^2c^2 - c^2a^2 - a^2b^2\} + b^2c^2x^2 + c^2a^2y^2 + a^2b^2z^2 - a^2b^2c^2 = 0.$$

And the sum of the reciprocals of the roots will vanish when the coefficient of $\lambda^2 = 0$. This, therefore, gives us the equation of the locus required.

Ex. 3. The section of an ellipsoid by the tangent plane to the asymptotic cone of a confocal hyperboloid is of constant area.

The area (Art. 96) is inversely proportional to the perpendicular on a parallel tangent plane, and we have

$$p^2 = a^2 \cos^2 \alpha + b^2 \cos^2 \beta + c^2 \cos^2 \gamma.$$

But since the perpendicular is an edge of the cone reciprocal to the asymptotic cone of the hyperboloid, we have

$$0 = a'^2 \cos^2 \alpha + b'^2 \cos^2 \beta + c'^2 \cos^2 \gamma,$$

whence

$$p^2 = a^2 - a'^2.$$

Ex. 4. To find the length of the perpendicular from the centre on the polar plane of $x'y'z'$ in terms of the axes of the confocals which pass through that point.

Ans. If $a'^2 - a^2 = h^2$, $a''^2 - a^2 = k^2$, $a'''^2 - a^2 = l^2$,

$$\frac{1}{p^2} = \frac{h^2 k^2 l^2}{a^2 b^2 c^2} \left\{ \frac{1}{a^2} + \frac{1}{b^2} + \frac{1}{c^2} + \frac{1}{h^2} + \frac{1}{k^2} + \frac{1}{l^2} \right\}.$$

187. Two points, one on each of two confocal ellipsoids, are said to correspond if

$$\frac{x}{a} = \frac{X}{A}, \quad \frac{y}{b} = \frac{Y}{B}, \quad \frac{z}{c} = \frac{Z}{C}.$$

It is evident that the intersection of two confocal hyperboloids pierces a system of ellipsoids in corresponding points; for from the value (Art. 160) $x^2 = \frac{a^2 a' a''}{(a^2 - b^2)(a^2 - c^2)}$, the quantity $\frac{x^2}{a^2}$ is constant as long as the hyperboloids, having a' , a'' for axes, are constant.

It will be observed that, the principal planes being limits of confocal surfaces, points on the principal planes determined by equations of the form $\frac{x^2}{a^2} = \frac{X^2}{a^2 - c^2}$, $\frac{y^2}{b^2} = \frac{Y^2}{b^2 - c^2}$, $Z = 0$, correspond to any point $x'y'z'$ on a surface, and when $x'y'z'$ is in the principal plane, the corresponding point is on the focal conic.

188. The points on the plane of xy , which correspond to the intersection of an ellipsoid with a series of confocal surfaces, form a series of confocal conics, of which the points corresponding to the umbilics are the common foci.

Eliminating z^2 between the equations

$$\frac{x^2}{a^2} + \frac{y^2}{b^2} + \frac{z^2}{c^2} = 1, \quad \frac{x^2}{a'^2} + \frac{y^2}{b'^2} + \frac{z^2}{c'^2} = 1,$$

we find
$$\frac{(a^2 - c^2)x^2}{a^2 a'^2} + \frac{(b^2 - c^2)y^2}{b^2 b'^2} = 1,$$

whence the corresponding points are connected by the relation

$$\frac{X^2}{a'^2} + \frac{Y^2}{b'^2} = 1,$$

This is evidently an ellipse for the intersections with hyperboloids of one sheet, and a hyperbola for the intersections with hyperboloids of two.

The coordinates of the umbilics are

$$x^2 = a^2 \frac{a^2 - b^2}{a^2 - c^2}, \quad y^2 = 0,$$

the points corresponding to which are

$$X^2 = a^2 - b^2, \quad Y = 0,$$

which are therefore the foci of the system of confocal conics.

Curves on the ellipsoid are sometimes expressed by what are called elliptic coordinates; that is to say, by an equation of the form $\phi(a', a'') = 0$, expressing a relation between the axes of the confocal hyperboloids which can be drawn through the point. Now since it appears from this article that a' is half the sum and a'' half the difference of the distances of the points corresponding to the points of the locus from the points which correspond to the umbilics, we can from the equation $\phi(a', a'') = 0$ obtain an equation $\phi(\rho + \rho', \rho - \rho') = 0$, from which we can form the equation of the curve on the principal plane which corresponds to the given locus.

189. If the intersection of a sphere and a concentric ellipsoid be projected on either plane of circular section by lines parallel to the least (or greatest) axis, the projection will be a circle.

This theorem is only a particular case of the following: "if any two quadrics have common planes of circular section, any quadric through their intersection will have the same;" a theorem which is evident, since if by making $z = 0$ in U and in V , the result in each case represents a circle, making $z = 0$ in $U + kV$, must also represent a circle.

It will be useful, however, to investigate this particular theorem directly. If we take as axes the axis of y which is a line in the plane of circular section and a perpendicular to it in that plane, the y will remain unaltered, and the new $x^2 =$ the old $x^2 + z^2$. But since by the equation of the plane of circular section $z^2 = \frac{c^2}{a^2} \cdot \frac{a^2 - b^2}{b^2 - c^2} x^2$, the new $x^2 = \frac{b^2}{a^2} \cdot \frac{a^2 - c^2}{b^2 - c^2} x^2$.

But for the intersection of

$$\frac{x^2}{a^2} + \frac{y^2}{b^2} + \frac{z^2}{c^2} = 1, \quad x^2 + y^2 + z^2 = r^2,$$

we have
$$\frac{a^2 - c^2}{a^2} x^2 + \frac{b^2 - c^2}{b^2} y^2 = r^2 - c^2,$$

which, on substituting for x^2 ,

$$\frac{b^2 - c^2}{a^2 - c^2} \cdot \frac{a^2}{b^2} x^2 \text{ becomes } \frac{b^2 - c^2}{b^2} (x^2 + y^2) = r^2 - c^2.$$

It will be observed that to obtain the projection on the planes of circular sections we left y unaltered, and substituted for x^2 , $\frac{b^2 - c^2}{a^2 - c^2} \cdot \frac{a^2}{b^2} x^2$. But to obtain the points corresponding to any point, as in Art. 187, we substitute for x^2 , $\frac{a^2}{a^2 - c^2} x^2$, and for y^2 , $\frac{b^2}{b^2 - c^2} y^2$. Now the squares of the former coordinates have to those of the latter the constant ratio $(b^2 - c^2) : b^2$. Hence we may immediately infer from the last article that the projection of the intersection of two confocal quadrics on a plane of circular section of one of them is a conic whose foci are the similar projections of the umbilics; and, again, that given any curve $\phi(a', a'')$ on the ellipsoid we can obtain the algebraic equation of the projection of that curve on the plane of circular section.

190. *The distance between two points, one on each of two confocal ellipsoids is equal to the distance between the two corresponding points.*

We have

$$(x - X)^2 + (y - Y)^2 + (z - Z)^2 \\ = x^2 + y^2 + z^2 + X^2 + Y^2 + Z^2 - 2(xX + yY + zZ).$$

Now (Art. 161)

$$x^2 + y^2 + z^2 = a^2 + b'^2 + c''^2, \quad X^2 + Y^2 + Z^2 = A^2 + B'^2 + C''^2.$$

But for the corresponding points

$$X'^2 + Y'^2 + Z'^2 = A^2 + b'^2 + c''^2, \quad x'^2 + y'^2 + z'^2 = a^2 + B'^2 + C''^2.$$

The sum of the squares therefore of the central radii to the two points is the same as that for the two corresponding points. But the quantities xX, yY, zZ are evidently respectively equal to $x'X', y'Y', z'Z'$, since $aX' = Ax, Ax' = aX$, &c. The theorem of this article, due to Sir J. Ivory, is of use in the theory of attractions.

Ex. Similarly it may be shewn that if P_1, P_2 be points on a generator of $\frac{x^2}{a^2} + \frac{y^2}{b^2} - \frac{z^2}{c^2} = 1$, and P_1', P_2' points on a generator of $\frac{x^2}{a'^2} + \frac{y^2}{b'^2} + \frac{z^2}{c'^2} = 1$, such that $\frac{x_1}{a} = \frac{x_1'}{a'}, \frac{x_2}{a} = \frac{x_2'}{a'}$, &c., the distance P_1P_2 is equal to the distance of the corresponding points $P_1'P_2'$ on the second hyperbola.

191. In order to obtain a property of quadrics analogous to the property of conics that the sum of the focal distances is constant, Jacobi states the latter property as follows: Take the two points C and C' on the ellipse at the extremity of the axis-major, then the same relation $\rho + \rho' = 2a$ which connects the distances from C and C' of any point on the line joining these points, connects also the distances from the foci of any point on the ellipse. Now, in like manner, if we take on the principal section of an ellipsoid the three points (A, B, C) which correspond in the sense explained (Art. 187) to any three points (a, b, c) on the focal ellipse, the same relation which connects the distances from the former points of any point (D) in their plane will also connect the distances from the latter points of any

point (d) on the surface.* In fact, by Art. 190, the distances of the points on the confocal conic from a point on the surface will be equal to the distances of the point on the principal plane which *corresponds* to the point on the surface, from the three points in the principal section.†

192. Conversely, let it be required to find the locus of a point whose distances from three fixed points are connected by the same relation as that which connects the distances from the vertices of a triangle, whose sides are a, b, c , to any point in its plane. Let ρ, ρ', ρ'' be the three distances, then (Art. 52) the relation which connects them is

$$a^2(\rho^2 - \rho'^2)(\rho^2 - \rho''^2) + b^2(\rho'^2 - \rho^2)(\rho'^2 - \rho''^2) + c^2(\rho''^2 - \rho^2)(\rho''^2 - \rho'^2) - a^2(b^2 + c^2 - a^2)\rho^2 - b^2(c^2 + a^2 - b^2)\rho'^2 - c^2(a^2 + b^2 - c^2)\rho''^2 + a^2b^2c^2 = 0.$$

But $\rho^2 - \rho'^2$, &c. being only functions of the coordinates of the first degree, the locus is manifestly only of the second degree.

That any of the points from which the distances are measured is a focus, is proved by shewing that this equation is of the form $U + LM = 0$, where U is the infinitely small sphere whose centre is this point. In other words, it is required to prove that the result of making $\rho^2 = 0$ in the preceding equation is the product of two equations of the first degree. But that result is

$$a^2(\rho'^2 - c^2)(\rho''^2 - b^2) + (b^2\rho'^2 - c^2\rho''^2)(\rho'^2 - \rho''^2 + b^2 - c^2) = 0.$$

* In a note by Joachimsthal, published since his death, Crelle 73, p. 207, it is shown, with a similar analogy to the ellipse, that the normal to the ellipsoid is constructed by measuring from d on da, db, dc lengths da', db', dc' which would represent equilibrating forces if measured from D along DA, DB, DC . The resultant of da', db', dc' is the normal of the ellipsoid.

† Mr Townsend has shewn from geometrical considerations (*Cambridge and Dublin Mathematical Journal*, vol. III. p. 154) that this property only belongs to points on the *modular* focal conics, and in fact the points in the plane y which correspond to any point $x'y'z'$ on an ellipsoid are imaginary, as easily appears from the formula of Art. 189. Mr. Townsend easily derives Jacobi's mode of generation from Mac Cullagh's modular property. For if through any point on the surface we draw a plane parallel to a circular section, it will cut the directrices corresponding to the three fixed foci in a triangle of invariable magnitude and figure, and the distances of the point on the surface from the three foci will be in a constant ratio to its distances from the vertices of this triangle. And a similar triangle can be formed with its sides increased or diminished in a fixed ratio, the distances from the vertices of which to the point $x'y'z'$ shall be equal to its distances from the foci.

Let now the planes represented by $\rho'^2 - \rho^2 - c^2$, $\rho''^2 - \rho^2 - b^2$ be L and M , then the result of making $\rho^2 = 0$ in the equation is

$$a^2 LM + (b^2 L - c^2 M)(L - M) = 0,$$

or

$$b^2 L^2 - 2bcLM \cos A + c^2 M^2 = 0,$$

where A is the angle opposite a in the triangle abc . But this breaks up into two imaginary factors, shewing that the point we are discussing is a focus of the modular kind.

193. *If several parallel tangent planes touch a series of confocals, the locus of their points of contact is an equilateral hyperbola.*

Let α , β , γ be the direction-angles of the perpendicular on the tangent planes. Then the direction-cosines of the radius vector to any point of contact are $\frac{a^2 \cos \alpha}{rp}$, $\frac{b^2 \cos \beta}{rp}$, $\frac{c^2 \cos \gamma}{rp}$; as easily appears by substituting in the formula $a^2 \cos \alpha = px'$ (Art. 89), $r \cos \alpha'$ for x' and solving for $\cos \alpha'$. Forming then, by Art. 15, the direction-cosines of the perpendicular to the plane of the radius vector and the perpendicular on the tangent plane, we find them to be

$$\frac{(b^2 - c^2) \cos \beta \cos \gamma}{rp \sin \phi}, \quad \frac{(c^2 - a^2) \cos \gamma \cos \alpha}{rp \sin \phi}, \quad \frac{(a^2 - b^2) \cos \alpha \cos \beta}{rp \sin \phi},$$

where ϕ is the angle between the radius vector and the perpendicular. Now the denominator is double the area of the triangle of which the radius vector and perpendicular are sides. Double the projections, therefore, of this triangle on the co-ordinate planes are

$$(b^2 - c^2) \cos \beta \cos \gamma, \quad (c^2 - a^2) \cos \gamma \cos \alpha, \quad (a^2 - b^2) \cos \alpha \cos \beta.$$

Now these projections being constant for a system of confocal surfaces, we learn that for such a system, both the plane of the triangle and its magnitude is constant. If then CM be the perpendicular on the series of parallel tangent planes and PM the perpendicular on that line from any point of contact P , we have proved that the plane and the magnitude of the triangle CPM are constant, and therefore the locus of P is an equilateral hyperbola of which CM is an asymptote.

193a. Writing down the equations of the normals to

$$\frac{x^2}{A} + \frac{y^2}{B} + \frac{z^2}{C} = 1,$$

at two points, we find as the condition that they may intersect

$$A(x' - x'')(y'z'' - y''z') + B(y' - y'')(z'x'' - z''x') \\ + C(z' - z'')(x'y'' - x''y') = 0,$$

or, calling α, β, γ the direction angles of the line which joins the points, and $\alpha_1, \beta_1, \gamma_1$ those of the perpendicular to the central plane containing the two points, the condition becomes

$$A \cos \alpha \cos \alpha_1 + B \cos \beta \cos \beta_1 + C \cos \gamma \cos \gamma_1 = 0.$$

This relation obviously still holds if A, B, C be replaced by $kA + l, kB + l, kC + l$. Hence, we see that if the normals at the two points of intersection of any right line with any central quadric intersect, the normals at its two points of intersection with any confocal, or with a similar and similarly placed concentric quadric likewise intersect.*

As a special case of this, we may consider the three confocals u, v, w which meet in any point P . The normal at P to u meets u again in Q , therefore meets the normal at Q . Hence, if normals be drawn to v at the points in which it is met by PQ they must intersect, and, in like manner, the normals at the points where PQ meets w , intersect. But the line PQ is a tangent line both to v and to w . Hence, normals to either surface taken at consecutive points along their common curve intersect. A curve possessing this property is defined to be a *line of curvature* on either surface.

CURVATURE OF QUADRICS.

194. The general theory of the curvature of surfaces will be explained in Chap. XI., but it will be convenient to state here some theorems on the curvature of quadrics which are immediately connected with the subject of this chapter.

If a normal section be made at any point on a quadric, its radius of curvature at that point is equal to $\beta^2 : p$, where β is the

* See a paper by Mr. F. Purser, *Quarterly Journal of Mathematics*, p. 66, vol. VIII.

semi-diameter parallel to the trace of the section on the tangent plane, and p is the perpendicular from the centre on the tangent plane.

We repeat the following proof by the method of infinitesimals from *Conics*, Art. 398, which see.

Let P, Q be any two points on a quadric; let a plane through Q parallel to the tangent plane at P meet the central radius CP in R , and the normal at P in S , then the radius of a circle through the points P, Q having its centre on PS is $PQ^2 : 2PS$. But if the point Q approach indefinitely near to P , QP is in the limit equal to QR ; and if we denote CP and the central radius parallel to QR by α' and β , and if P' be the other extremity of the diameter CP , then (Art. 74)

$$\beta^2 : \alpha'^2 :: QR^2 : PR \cdot RP' (= 2\alpha' \cdot PR);$$

therefore $QR^2 = \frac{2\beta^2 \cdot PR}{\alpha'}$ and the radius of curvature $= \frac{\beta^2}{\alpha'} \cdot \frac{PR}{PS}$.

But if from the centre we let fall a perpendicular CM on the tangent plane, the right-angled triangle CMP is similar to PRS , and $PR : PS :: \alpha' : p$. And the radius of curvature is

therefore $\frac{\beta^2}{\alpha'} \cdot \frac{\alpha'}{p} = \frac{\beta^2}{p}$; which was to be proved.

If the circle through PQ have its centre not on PS , but on any line PS' , making an angle θ with PS , the only change is that the radius of the circle is $\frac{PQ^2}{2PS'}$, S' being still on the plane drawn through Q parallel to the tangent plane at P . But PS evidently $= PS' \cos \theta$. The radius of curvature is therefore $\frac{PQ^2}{2PS} \cos \theta$, or *the value for the radius of curvature of an oblique section is the radius of curvature of the normal section through PQ , multiplied by $\cos \theta$.*

195. These theorems may also easily be proved analytically. It is proved (*Conics*, Art. 241) that if $ax^2 + 2hxy + by^2 + 2gx = 0$ be the equation of any conic, the radius of curvature at the origin is $g \div b$. If then the equation of any quadric, the plane of xy being a tangent plane, be

$$ax^2 + 2hxy + by^2 + 2gzx + 2fyz + cz^2 + 2nz = 0,$$

the radii of curvature by the sections $y=0$, $x=0$ are respectively $n : a$, $n : b$. But if the equation be transformed to parallel axes through the centre, the terms of highest degree remain unaltered, and the equation becomes

$$ax^2 + 2hxy + by^2 + 2gzx + 2fyz + cz^2 = D.$$

The squares of the intercepts on the axes of x and y are $D : a$, $D : b$. This proves that the radii of curvature are proportional to the squares of the parallel semi-diameters of a central section. And since, by the theory of conics, the radius of curvature of that section which contains the perpendicular on the tangent plane is $\beta^2 : p$, the same is the form of the radius of every other section.

The same may be proved by using the equation of the quadric transformed to any normal and the normals to two confocals as axes (see Ex. 2, Art. 174), viz.

$$\frac{x^2}{\gamma^2} + \frac{y^2}{a^2 - a'^2} + \frac{z^2}{a^2 - a''^2} - \frac{2p'xy}{p(a^2 - a'^2)} - \frac{2p''xz}{p(a^2 - a''^2)} + \frac{2x}{p} = 0.$$

The radii of curvature of the sections by the planes $z=0$, $y=0$ are respectively $\frac{a^2 - a'^2}{p}$, $\frac{a^2 - a''^2}{p}$. The numerators are the squares of the semi-axes of the section by a plane parallel to the tangent plane (Art. 164).

The equation of the section made by a plane making an angle θ with the plane of y is found by first turning the axes of coordinates round through an angle θ , by substituting $y \cos \theta - z \sin \theta$, $y \sin \theta + z \cos \theta$ for y and z , and then making the new $z=0$. Then, if the new coefficient of y^2 is $\frac{1}{\beta^2}$, $\frac{\beta^2}{p}$ is the corresponding radius of curvature. But this coefficient is at once found to be

$$\frac{\cos^2 \theta}{a^2 - a'^2} + \frac{\sin^2 \theta}{a^2 - a''^2},$$

and this coefficient of y^2 is evidently the inverse square of that semi-diameter of the central section, which makes an angle θ with the axis y .

196. It follows from the theorem enunciated in Art. 194, that at any point on a central quadric the radius of curvature

of a normal section has a maximum and minimum value, the directions of the sections for these values being parallel to the axis-major and axis-minor of the central section by a plane parallel to the tangent plane.

These maximum and minimum values are called the *principal radii* of curvature for that point, and the sections to which they belong are called the principal sections. It appears (from Art. 163) that the principal sections contain each the normal to one of the confocals through the point. The intersection of a quadric with a confocal is a curve such that at every point of it the tangent to the curve is one of the principal directions of curvature. Such a curve is called a *line of curvature* on the surface, and this definition agrees with that of Art. 193a.

In the case of the hyperboloid of one sheet the central section is a hyperbola, and the sections whose traces on the tangent plane are parallel to the asymptotes of that hyperbola will have their radii of curvature infinite; that is to say, they will be right lines, as we know already. In passing through one of those sections the radius of curvature changes sign; that is to say, the direction of the convexity of sections on one side of one of those lines is opposite to that of those on the other.

197. *The two principal centres of curvature are the two poles of the tangent plane with regard to the two confocal surfaces which pass through the point of contact.* For these poles lie on the normal to that plane (Art. 167), and at distances from it $= \frac{a^2 - a'^2}{p}$ and $\frac{a^2 - a''^2}{p}$ (Art. 168), but these have been just proved to be the lengths of the principal radii of curvature.

We can also hence find, by Art. 168, the coordinates of the centres of the two principal circles of curvature, viz.

$$x = \frac{a'^2 x'}{a^2}, \quad y = \frac{b'^2 y'}{b^2}, \quad z = \frac{c'^2 z'}{c^2}; \quad x = \frac{a''^2 x'}{a^2}, \quad y = \frac{b''^2 y'}{b^2}, \quad z = \frac{c''^2 z'}{c^2}.$$

198. If at each point of a quadric we take the two principal centres of curvature, the locus of all these centres is a surface of two sheets, which is called the *surface of centres*.

We shall shew how to find its equation in the next chapter, but we can see *à priori* the nature of its sections by the principal planes. In fact, one of the principal radii of curvature at any point on a principal section is the radius of curvature of the section itself, and the locus of the centres corresponding is evidently the evolute of that section. The other radius of curvature corresponding to any point in the section by the plane of xy is $c^2 : p$, as appears from the formula of Art. 194, since c is an axis in every section drawn through the axis of z . From the formulæ of Art. 197 the coordinates of the corresponding centre are $\frac{a^2 - c^2}{a^2} x'$, $\frac{b^2 - c^2}{b^2} y'$; that is to say, they are the poles with regard to the focal conic of the tangent at the point $x'y'$ to the principal section. The locus of the centres will be the reciprocal of the principal section, taken with regard to the focal conic, viz.

$$\frac{a^2 x'^2}{(a^2 - c^2)^2} + \frac{b^2 y'^2}{(b^2 - c^2)^2} = 1.$$

The section then by a principal plane of the surface (which is of the twelfth degree) consists of the evolute of a conic, which is of the sixth degree, and of the conic (it will be found) three times over, this conic being a cuspidal line on the surface. The section by the plane at infinity is of a similar nature to those by the principal planes. It may be added, that the conic touches the evolute in four points (real for the principal plane through the greatest and least axes, or umbilicar plane) and besides cuts it in four points.

199. *The reciprocal of the surface of centres is a surface of the fourth degree.*

It will appear from the general theory of the curvature of surfaces, to be explained in Chap. XI., that the tangent plane to either of the confocal surfaces through $x'y'z'$ is also a tangent plane to the surface of centres. The reciprocals of the intercepts which the tangent plane makes on the axes are given by the equations

$$\xi = \frac{x'}{a'^2}, \quad \eta = \frac{y'}{b'^2}, \quad \zeta = \frac{z'}{c'^2}.$$

The relation

$$\frac{x'^2}{a^2 a'^2} + \frac{y'^2}{b^2 b'^2} + \frac{z'^2}{c^2 c'^2} = 0$$

gives between ξ , η , ζ the relation

$$(\xi^2 + \eta^2 + \zeta^2) = (a^2 - a'^2) \left(\frac{\xi^2}{a^2} + \frac{\eta^2}{b^2} + \frac{\zeta^2}{c^2} \right),$$

and the relation

$$\frac{x'^2}{a'^2} + \frac{y'^2}{b'^2} + \frac{z'^2}{c'^2} = 1$$

gives $(a^2 \xi^2 + b^2 \eta^2 + c^2 \zeta^2 - 1) = (a^2 - a'^2) (\xi^2 + \eta^2 + \zeta^2)$.

Eliminating $a^2 - a'^2$, we have

$$(\xi^2 + \eta^2 + \zeta^2)^2 = \left(\frac{\xi^2}{a^2} + \frac{\eta^2}{b^2} + \frac{\zeta^2}{c^2} \right) (a^2 \xi^2 + b^2 \eta^2 + c^2 \zeta^2 - 1).*$$

But it is evident (as at *Higher Plane Curves*, Art. 21) that ξ , η , ζ may be understood to be coordinates of the reciprocal surface; since, if ξ , η , ζ be the coordinates of the pole of the tangent plane with regard to the sphere $x^2 + y^2 + z^2 = 1$, the equation $x\xi + y\eta + z\zeta = 1$ being identical with that of the tangent plane, ξ , η , ζ will be also the reciprocals of the intercepts made by the tangent plane on the axes.

* This equation was first given, as far as I am aware, by Dr. Booth, *Tangential Coordinates*, Dublin, 1840.

CHAPTER IX.

INVARIANTS AND COVARIANTS OF SYSTEMS OF QUADRICS.

200. It was proved (Art. 136) that there are four values of λ for which $\lambda U + V$ represents a cone. The biquadratic which determines λ is obtained by equating to nothing the discriminant of $\lambda U + V$. We shall write it

$$\lambda^4 \Delta + \lambda^3 \Theta + \lambda^2 \Phi + \lambda \Theta' + \Delta' = 0.$$

The values of λ , for which $\lambda U + V$ represents a cone, are evidently independent of the system of coordinates in which U and V are expressed. The coefficients Δ , Θ , &c. are therefore *invariants* whose mutual ratios are unaltered by transformation of coordinates. The following exercises in calculating these invariants include some of the cases of most frequent occurrence.

Ex. 1. Let both quadrics be referred to their common self-conjugate tetrahedron (Art. 141). We may take

$$U = ax^2 + by^2 + cz^2 + dw^2, \quad V = x^2 + y^2 + z^2 + w^2,$$

(see Art. 141, and *Conics*, Ex. 1, Art. 371), then

$$\Delta = abcd, \quad \Theta = bcd + cda + dab + abc, \quad \Phi = bc + ca + ab + ad + bd + cd, \\ \Theta' = a + b + c + d, \quad \Delta' = 1.$$

Ex. 2. Let V , as before, be $x^2 + y^2 + z^2 + w^2$, and let U represent the general equation. The general value of Θ is

$$a'A + b'B + c'C + d'D + 2f'F + 2g'G + 2h'H + 2l'L + 2m'M + 2n'N,$$

where A, B , &c. have the same meaning as in Art. 67. In the present case therefore

$$\Theta = A + B + C + D, \quad \Theta' = a + b + c + d;$$

we have also $\Phi = bc - f^2 + ca - g^2 + ab - h^2 + ad - l^2 + bd - m^2 + cd - n^2$.

Similarly, if U is $ax^2 + by^2 + cz^2 + dw^2$, and V is the general equation,

$$\Theta \text{ is } a'bcd + b'cda + c'dab + d'abc, \quad \Theta' \text{ is } aA' + bB' + cC' + dD'.$$

Ex. 3. Let U and V represent two spheres,

$$x^2 + y^2 + z^2 - \rho^2, \quad (x - \alpha)^2 + (y - \beta)^2 + (z - \gamma)^2 - \rho'^2,$$

and let the distance between the centres be D , ($\alpha^2 + \beta^2 + \gamma^2 = D^2$), then

$$\Delta = -\rho^2, \quad \Delta' = -\rho'^2, \quad \Theta = D^2 - 3\rho^2 - \rho'^2, \quad \Theta' = D^2 - \rho^2 - 3\rho'^2, \quad \Phi = 2D^2 - 3\rho^2 - 3\rho'^2,$$

and the biquadratic which determines λ is

$$(\lambda + 1)^2 \{-\rho^2 \lambda^2 + (D^2 - \rho^2 - \rho'^2) \lambda - \rho'^2\} = 0.$$

Ex. 4. Let U represent $\frac{x^2}{a^2} + \frac{y^2}{b^2} + \frac{z^2}{c^2} - 1$, while V is the sphere

$$(x - \alpha)^2 + (y - \beta)^2 + (z - \gamma)^2 - \rho^2.$$

$$\text{Ans. } \Delta = -\frac{1}{a^2 b^2 c^2}, \quad \Delta' = -\rho^2,$$

$$\Theta = \frac{1}{a^2 b^2 c^2} \{ \alpha^2 + \beta^2 + \gamma^2 - \rho^2 - (\alpha^2 + b^2 + c^2) \}, \quad \Theta' = \frac{\alpha^2}{a^2} + \frac{\beta^2}{b^2} + \frac{\gamma^2}{c^2} - 1 - \rho^2 \left(\frac{1}{a^2} + \frac{1}{b^2} + \frac{1}{c^2} \right),$$

$$\Phi = \frac{1}{b^2 c^2} (\beta^2 + \gamma^2 - \rho^2) + \frac{1}{c^2 a^2} (\gamma^2 + \alpha^2 - \rho^2) + \frac{1}{a^2 b^2} (\alpha^2 + \beta^2 - \rho^2) - \left(\frac{1}{a^2} + \frac{1}{b^2} + \frac{1}{c^2} \right).$$

Since $\lambda U + V$ admits of being written in the form $AX^2 + BY^2 + CZ^2 + DW^2$, it is easily seen that the biquadratic found by equating to nothing the discriminant of $\lambda U + V$ may be written

$$\frac{\alpha^2}{a^2 + \lambda} + \frac{\beta^2}{b^2 + \lambda} + \frac{\gamma^2}{c^2 + \lambda} = 1 + \frac{\rho^2}{\lambda}.$$

Ex. 5. Let U represent the paraboloid $ax^2 + by^2 + 2nz$ and V the sphere as in the last example.

$$\text{Ans. } \Delta = -abn^2, \quad \Delta' = -\rho^2,$$

$$\Theta = -n^2(a + b) + 2abn\gamma, \quad \Theta' = a\alpha^2 + b\beta^2 + 2n\gamma - (a + b)\rho^2,$$

$$\Phi = ab(\alpha^2 + \beta^2 - \rho^2) + 2(a + b)n\gamma - n^2;$$

and the biquadratic may be written by a similar method

$$\frac{\lambda a \alpha^2}{\lambda a + 1} + \frac{\rho b \beta^2}{\lambda b + 1} + 2\lambda n \gamma = \lambda^2 n^2 + \rho^2.$$

Ex. 6. In general the value of Φ is

$$\begin{aligned} & (bc - f^2)(a'd' - l'^2) + (ca - g^2)(b'd' - m'^2) + (ab - h^2)(c'd' - n'^2) \\ & + (ad - l^2)(b'c' - f'^2) + (bd - m^2)(c'a' - g'^2) + (cd - n^2)(a'b' - h'^2) \\ & + 2(gm - hn)(g'm' - h'n') + 2(hn - fl)(h'n' - f'l') + 2(fl - gm)(f'l' - g'm') \\ & + 2(mh - lb)(l'c' - n'g') + 2(nf - mc)(m'a' - l'h') + 2(lg - na)(n'b' - m'f') \\ & + 2(m'h' - l'b')(lc - ng) + 2(n'f' - m'c')(ma - lh) + 2(l'g' - n'a')(nb - m'f) \\ & + 2(fd - mn)(g'h' - a'f') + 2(gd - nl)(h'f' - b'g') + 2(hd - lm)(f'g' - c'h') \\ & + 2(f'd' - m'n')(gh - af) + 2(g'd' - n'l')(hf - bg) + 2(h'd' - l'm')(fg - ch). \end{aligned}$$

Thus Φ is a function of the same quantities which occur in the condition (Art. 80a) that a line should touch a quadric. This condition is a quadratic function of the six coordinates of the line; and if we write the coefficients which affect the squares of the coordinates in that condition $a_{11}, a_{22} \dots a_{66}$, and those which affect the double rectangles a_{12}, a_{13} , &c., writing the corresponding quantities for the second quadric e_{11}, e_{22} , &c., then Φ is $a_{11}e_{44} + a_{22}e_{55} + a_{33}e_{66} + a_{44}e_{11} + a_{55}e_{22} + a_{66}e_{33} + 2a_{14}e_{14} + \&c.$ In like manner, writing the discriminant in any of the three forms,

$$\begin{aligned} \Delta &= a_{11}a_{44} + a_{12}a_{45} + a_{13}a_{46} + a_{14}^2 + a_{15}a_{42} + a_{16}a_{43} \\ &= a_{21}a_{54} + a_{22}a_{55} + a_{23}a_{56} + a_{24}a_{51} + a_{25}^2 + a_{26}a_{53} \\ &= a_{31}a_{64} + a_{32}a_{65} + a_{33}a_{66} + a_{34}a_{61} + a_{35}a_{62} + a_{36}^2 \end{aligned}$$

if by the substitution of $a + \lambda a'$ &c. for a &c., a_{11} become $a_{11} + \lambda b_{11} + \lambda^2 c_{11}$ &c., different methods of writing the invariants are found.

201. To examine the geometrical meaning of the condition $\Theta = 0$ and of the condition $\Phi = 0$. It appears, from Art. 200, Ex. 2, that when U is referred to a self-conjugate tetrahedron,

$$\Theta = bcda' + cdab' + dabc' + abcd',$$

which will vanish when a', b', c', d' all vanish. Hence Θ will vanish whenever it is possible to inscribe in V a tetrahedron which shall be self-conjugate with regard to U . In like manner Θ' will vanish for this form of U whenever A', B', C', D' vanish. But $A' = 0$ is the condition that the plane x shall touch V . Hence Θ' will vanish whenever it is possible to find a tetrahedron self-conjugate with regard to U whose faces touch V . By the first part of this article $\Theta' = 0$ is also the condition that it may be possible to inscribe in U a tetrahedron self-conjugate with regard to V . Hence when one of these things is possible, so is the other also.

$\Phi = 0$ will be fulfilled, if the edges of a self-conjugate tetrahedron, with respect to either, all touch the other.

Ex. 1. The vertices of two self-conjugate tetrahedra, with respect to a quadric form a system of eight points, such that every quadric through seven will pass through the eighth (Hesse, *Crelle*, vol. XX., p. 297).

Let any quadric be described through the four vertices of one tetrahedron, and through three vertices of the second, whose faces we take for x, y, z, w . Then because the quadric circumscribes the first tetrahedron, $\Theta' = 0$, or $a + b + c + d = 0$ (Art. 200, Ex. 2); and because it passes through three vertices of $xyzw$, we have $a = 0, b = 0, c = 0$; therefore $d = 0$, or the quadric goes through the remaining vertex. It is proved, in like manner, that any quadric which touches seven of the faces of the two tetrahedra touches the eighth.

Ex. 2. If a sphere be circumscribed about a self-conjugate tetrahedron, the length of the tangent to it from the centre of the quadric is constant. For (Art. 200, Ex. 4) the condition $\Theta = 0$ gives the square of the tangent $\alpha^2 + \beta^2 + \gamma^2 - \rho^2 = a^2 + b^2 + c^2$. This corresponds to M. Faure's theorem (*Conics*, Art. 375, Ex. 2). It may be otherwise stated: "The sphere which circumscribes a self-conjugate tetrahedron cuts orthogonally the sphere which is the intersection of three tangent planes at right angles" (Art. 93).

Ex. 3. If a hyperboloid $\frac{x^2}{a} + \frac{y^2}{b} + \frac{z^2}{c} = 1$ be such that $\frac{1}{a} + \frac{1}{b} + \frac{1}{c} = 0$, then the centre of a sphere inscribed in a self-conjugate tetrahedron lies on the surface. This follows from the condition $\Theta' = 0$ (Art. 200, Ex. 4).

Ex. 4. The locus of the centre of a sphere circumscribing a tetrahedron, self-conjugate with regard to a paraboloid, is a plane (Art. 200, Ex. 5).

202. To find the condition that two quadrics U, V should touch each other. As in the case of conics (*Conics*, Art. 372) the biquadratic of Art. 200 will have two equal roots when the quadrics touch. This is most easily proved by taking the origin at the point of contact, and the tangent plane for the coordinate plane z . Then, for both the quadrics, we have $d = 0, l = 0, m = 0$; and since, if we substitute these values

in the discriminant (Art. 67), it reduces to $n^2(h^2 - ab)$, the biquadratic becomes

$$(\lambda n + n')^2 \{(\lambda h + h')^2 - (\lambda a + a')(\lambda b + b')\} = 0,$$

which has two equal roots. The required condition is therefore found by equating to zero the discriminant of the biquadratic of Art. 200.

Ex. 1. To find the condition that two spheres may touch. The biquadratic for this case (Art. 200, Ex. 3) has always two equal roots. This is because two spheres having common a plane section at infinity, always have double contact at infinity (Art. 137). The condition that they should besides have finite contact is got by expressing the condition that the other two factors of the biquadratic should be equal and is $(D^2 - r^2 - r'^2)^2 = 4r^2r'^2$, whence $D = r \pm r'$.*

Ex. 2. Find the locus of the centre of a sphere of constant radius touching a central quadric. The equation got by forming the discriminant with respect to λ of the biquadratic of Art. 200, Ex. 4, is of the twelfth degree in α, β, γ . When we make $\rho = 0$, it reduces to the quadric taken twice, together with the equation of the eighth degree considered below (Art. 221). The problem considered in this example is the same as that of finding the equation of the surface *parallel* to the quadric (see *Conics*, Ex. 3, Art. 372); namely, the surface generated by measuring from the surface on each normal a constant length equal to ρ . The equation is of the sixth degree in ρ^2 , and gives the lengths of the *six* normals which can be drawn from any point xyz to the surface (*Conics*, Art. 372, Ex. 3). To find the section of the surface by one of the principal planes, we use the principle that the discriminant with respect to λ of any algebraic expression of the form $(\lambda - a)\phi(\lambda)$ is the square of $\phi(a)$ multiplied by the discriminant of $\phi(\lambda)$. If then we make $z = 0$ in the equation, the discriminant of

$$(\lambda + c) \left\{ \frac{x^2}{a + \lambda} + \frac{y^2}{b + \lambda} - 1 - \frac{\rho^2}{\lambda} \right\}$$

is the conic

$$\frac{x^2}{a - c} + \frac{y^2}{b - c} - 1 + \frac{\rho^2}{c},$$

taken twice, this curve being a double line on the surface, together with the discriminant of the function within the brackets; this latter representing the curve of the eighth order, parallel to the principal section of the ellipsoid.

Ex. 3. The equation of the surface *parallel* to a paraboloid is found in like manner by forming the discriminant of the biquadratic of Ex. 5, Art. 200. The result represents a surface of the tenth degree, and when $\rho = 0$, reduces to the paraboloid taken twice, together with the surface of the sixth degree considered below (Art. 222). The equation is of the fifth degree in ρ^2 , shewing that only five normals can be drawn from any point to the surface. It is seen, as in the last example, that the section by either principal plane is a parabola taken twice, together with the curve parallel to a parabola.

203. It is to be remarked that when two surfaces touch, the point of contact is a double point on their curve of

* Generally the biquadratic (Art. 200) will have *two pairs of equal roots* when the quadrics have a generator common, the conditions for this may be written down as in Art. 214 *Higher Algebra*.

intersection. In general, two surfaces of the m^{th} and n^{th} degrees respectively intersect in a curve of the mn^{th} order. And at each point of the curve of intersection there is a single tangent line, namely the intersection of the tangent planes at that point to the two surfaces. For any plane drawn through this line meets the surfaces in two curves which touch: such a plane therefore passes through two coincident points of the curve of intersection. But if the surfaces touch, then *every* plane through the point of contact meets them in two curves which touch, and *every* such plane therefore passes through two coincident points of the curve of intersection. The point of contact is therefore a double point on this curve.

And we can shew that, as in plane curves, there are two tangents at the double point. For there are two directions in the common tangent plane to the surfaces, any plane through either of which meets the surfaces in curves having three points in common.

Take the tangent plane for the plane of xy , and let the equations of the surfaces be

$$z + ax^2 + 2hxy + by^2 + \&c.,$$

$$z + a'x^2 + 2h'xy + b'y^2 + \&c.,$$

then any plane $y = \mu x$ cuts the surfaces in curves which osculate (see *Conics*, Art. 239), if

$$a + 2h\mu + b\mu^2 = a' + 2h'\mu + b'\mu^2.$$

The two required directions then are given by the equation

$$(a - a')x^2 + 2(h - h')xy + (b - b')y^2 = 0.$$

The same may be otherwise proved thus. It will be shown hereafter precisely as at *Higher Plane Curves*, Arts. 36, 37, that if the equation of a surface be $u_1 + u_2 + u_3 + \&c. = 0$, the origin will be on the surface, and u_1 will include all the right lines which meet the surface in two consecutive points at the origin; while if u_1 is identically 0, the surface has the origin for a double point, and u_2 includes all the right lines which meet the surface at the origin in three consecutive points. Now in the case we are considering, by subtracting one equation from the other, we get a surface through the curve of intersection, viz.

$$(a - a')x^2 + 2(h - h')xy + (b - b')y^2 + \&c.,$$

in which surface the origin is a double point, and the two lines just written are two lines which meet the surface in three consecutive points.

204. When these lines coincide there is a cusp or stationary point (see *Higher Plane Curves*, Art. 38) on the curve of intersection. We shall call the contact in this case *stationary contact*. The condition that this should be the case, the axes being assumed as above, is

$$(a - a')(b - b') = (h - h')^2.$$

Now if we compare the biquadratic for λ , given Art. 202, remembering also that in the form we are now working with, we have $n = n'$, we shall see that when this condition is fulfilled, three roots of the biquadratic become equal to -1 . The conditions then for stationary contact are found by forming the conditions that the biquadratic should have *three equal roots*, viz. these conditions are $S = 0$, $T = 0$, S and T being the two invariants of the biquadratic.

205. Every sphere whose centre is on a normal to a quadric, and which passes through the point where the normal meets the surface, of course touches the surface. But it will have *stationary contact* when the length of the radius of the sphere is equal to one of the *principal radii of curvature* (Art. 196). Let us take the tangent plane for plane of xy , and the two directions of maximum and minimum curvature (Art. 196) for the axes of x and y . Then since these directions are parallel to the axes of parallel sections, the term xy will not appear in the equation, which will be of the form $z + ax^2 + by^2 + \&c. = 0$. By the last article, any sphere $z + \lambda(x^2 + y^2 + z^2)$ will have stationary contact with this if $(\lambda - a)(\lambda - b) = 0$, for we have h and h' each $= 0$. We must therefore have λ equal either to a or b . Now if we make $y = 0$, the circle $z + a(x^2 + z^2)$ is evidently that which osculates the section $z + ax^2 + \&c.$; and, in like manner, the circle $z + b(y^2 + z^2)$ osculates $z + by^2 + \&c.$

206. To find the equation of the surface of centres of a quadric. If we form, for the biquadratic of Ex. 4, Art. 200, the two equations $S = 0$, $T = 0$, we have two equations con-

necting α, β, γ , the coordinates of the centre of curvature of any principal section, and ρ its radius. One of these equations is a quadratic and the other a cubic in ρ^2 ; and if we eliminate ρ^2 between them, we evidently have the equation of the locus of the centres of curvature of all principal sections. The problem may also be stated thus: If U and U' be any two algebraical equations of the same degree and k a variable parameter, it is generally possible to determine k so that the equation $U + kU' = 0$ may have two equal roots. But it is not possible to determine k , so that the same equation may have three equal roots, unless a certain invariant relation subsist between the coefficients of U and U' . Now the present problem is a particular case of the general problem of finding such an invariant relation. It is in fact to find the condition that it may be possible to determine k so that the following biquadratic in λ may have three equal roots:

$$\frac{x^2}{a^2 + \lambda} + \frac{y^2}{b^2 + \lambda} + \frac{z^2}{c^2 + \lambda} = 1 + \frac{k}{\lambda}.$$

The following are the leading terms in the resulting equation: the remaining terms can be added from the symmetry of the letters. We use the abbreviations $b^2 - c^2 = \alpha$, $c^2 - a^2 = \beta$, $a^2 - b^2 = \gamma$; and further we write x, y, z instead of ax, by, cz :

$$\begin{aligned} & \alpha^6 x^{12} + 3(\alpha^2 + \beta^2) \alpha^4 x^{10} y^2 + 3(\alpha^4 + 3\alpha^2 \beta^2 + \beta^4) \alpha^2 x^8 y^4 \\ & + 3(2\alpha^4 + 3\alpha^2 \beta^2 + 3\alpha^2 \gamma^2 - 7\beta^2 \gamma^2) \alpha^2 x^8 y^2 z^2 \\ & + (\alpha^6 + \beta^6 + 9\alpha^4 \beta^2 + 9\alpha^2 \beta^4) x^6 y^6 \\ & + 3(\alpha^6 + 6\alpha^4 \beta^2 + 3\alpha^4 \gamma^2 + 3\alpha^2 \beta^4 + \beta^4 \gamma^2 - 21\alpha^2 \beta^2 \gamma^2) x^6 y^4 z^2 \\ & + 9(\alpha^4 \beta^2 + \beta^4 \alpha^2 + \beta^4 \gamma^2 + \beta^2 \gamma^4 + \gamma^4 \alpha^2 + \gamma^2 \alpha^4 - 14\alpha^2 \beta^2 \gamma^2) x^4 y^4 z^4 \\ & - 3(\beta^2 + \gamma^2) \alpha^6 x^{10} - 3(2\beta^4 + 3\beta^2 \gamma^2 + 3\beta^2 \alpha^2 - 7\gamma^2 \alpha^2) \alpha^4 x^8 y^2 \\ & - 3(\beta^6 + 6\beta^4 \alpha^2 + 3\beta^4 \gamma^2 + 3\beta^2 \alpha^4 + \alpha^4 \gamma^2 - 21\alpha^2 \beta^2 \gamma^2) \alpha^2 x^6 y^4 \\ & + 3\{14(\alpha^4 \beta^2 + \alpha^2 \beta^4 + \beta^4 \gamma^2 + \beta^2 \gamma^4 + \gamma^4 \alpha^2 + \gamma^2 \alpha^4) + 20\alpha^2 \beta^2 \gamma^2\} \alpha^2 x^6 y^2 z^2 \\ & + 3\{4\gamma^8 - 7\gamma^6(\alpha^2 + \beta^2) - 198\gamma^4 \alpha^2 \beta^2 + 68\alpha^2 \beta^2 \gamma^2(\alpha^2 + \beta^2) + 42\alpha^4 \beta^4\} x^4 y^4 z^2 \\ & + 3(\beta^4 + 3\beta^2 \gamma^2 + \gamma^4) \alpha^6 x^8 \\ & + 3(\beta^6 + 6\beta^4 \gamma^2 + 3\beta^4 \alpha^2 + 3\beta^2 \gamma^4 + \alpha^2 \gamma^4 - 21\alpha^2 \beta^2 \gamma^2) \alpha^4 x^6 y^2 \\ & + 9(\alpha^4 \beta^2 + \alpha^2 \beta^4 + \beta^4 \gamma^2 + \beta^2 \gamma^4 + \gamma^4 \alpha^2 + \gamma^2 \alpha^4 - 14\alpha^2 \beta^2 \gamma^2) \alpha^2 \beta^2 x^4 y^4 \end{aligned}$$

$$\begin{aligned}
& -3 \{4\alpha^8 - 7\alpha^6(\beta^2 + \gamma^2) \\
& \quad - 198\alpha^4\beta^2\gamma^2 + 68\alpha^2\beta^2\gamma^2(\beta^2 + \gamma^2) + 42\beta^4\gamma^4\} \alpha^2 x^4 y^2 z^2 \\
& - (\beta^6 + \gamma^6 + 9\beta^4\gamma^2 + 9\beta^2\gamma^4) \alpha^6 x^6 \\
& - 3(\gamma^6 + 6\gamma^4\beta^2 + 3\gamma^4\alpha^2 + 3\gamma^2\beta^4 + \alpha^2\beta^4 - 21\alpha^2\beta^2\gamma^2) \alpha^4\beta^2 x^4 y^2 \\
& + 3 \{14(\alpha^4\beta^2 + \alpha^2\beta^4 + \beta^4\gamma^2 + \beta^2\gamma^4 + \gamma^4\alpha^2 + \gamma^2\alpha^4) \\
& \quad + 20\alpha^2\beta^2\gamma^2\} \alpha^2\beta^2\gamma^2 x^2 y^2 z^2 \\
& + 3(\beta^4 + 3\beta^2\gamma^2 + \gamma^4) \alpha^6\beta^2\gamma^2 x^4 \\
& + 3(2\gamma^4 + 3\gamma^2\alpha^2 + 3\gamma^2\beta^2 - 7\alpha^2\beta^2) \alpha^4\beta^4\gamma^2 x^2 y^2 \\
& - 3(\beta^2 + \gamma^2) \alpha^6\beta^4\gamma^4 x^2 + \alpha^6\beta^6\gamma^6 = 0.
\end{aligned}$$

If we make in this equation $z = 0$, we obtain

$$(\alpha^2 x^2 + \beta^2 y^2 - \alpha^2 \beta^2)^3 \{(x^2 + y^2 - \gamma^2)^3 + 27x^2 y^2 \gamma^2\}, \text{ see Art. 198.}$$

The section by the plane at infinity is of a similar kind to that by the principal planes, the highest terms in the equation being

$$(x^2 + y^2 + z^2)^3 \{(\alpha^2 x^2 + \beta^2 y^2 + \gamma^2 z^2)^3 - 27\alpha^2 \beta^2 \gamma^2 x^2 y^2 z^2\}.$$

In like manner we find the surface of centres of the paraboloid $ax^2 + by^2 + 2nx$. If we write

$a-b=m$, $a+b=p$, $ab=q$, $bx^2+ay^2=V$, $x^2+y^2=\rho^2$, $qz^2+pnz+n^2=W$, the equation is

$$8 \{q^2 z V + qn(b^2 x^2 + a^2 y^2) + 2m^2 n W\}^3 + 27 T = 0,$$

where

$$\begin{aligned}
T = & q^5 n V^4 - 16m^2 q^4 n W x^2 y^2 + 6m^2 q^4 n^2 z V^3 - 56m^2 q^5 n^2 z V x^2 y^2 \\
& + 8m^4 q^3 n^3 x^2 y^2 W + 12m^4 q^3 n^3 z^2 V^2 + 6m^2 q^4 n^3 \rho^2 V^2 - 152m^2 q^5 n^3 x^2 y^2 \rho^2 \\
& + 48m^2 p q^4 n^3 x^2 y^2 V + 8m^6 q^2 n^4 z^3 V + 24m^4 q^3 n^4 z \rho^2 V + 24m^6 q^2 n^5 \rho^2 z^2 \\
& + 12m^4 q^3 n^5 \rho^4 + 43m^6 q^2 n^5 x^2 y^2 + 24m^6 z n^6 q(ax^2 + by^2) + 8m^6(\alpha^2 x^2 + b^2 y^2)n^7.
\end{aligned}$$

The section by either plane x or y , is a parabola, counted three times, and the evolute of a parabola.

207. *To find the condition that two quadrics shall be such that a tetrahedron can be inscribed in one having two pairs of opposite edges on the surface of the other.** The one quadric then can

* This problem and its reciprocal appear to answer to the plane problem of finding the condition that a triangle can be inscribed in one conic and circumscribed about another. Mr. Purser (*Quarterly Journal*, vol. VIII., p. 149) has determined the envelope of the fourth face of a tetrahedron whose other three faces touch a quadric U when two pairs of its opposite edges are generators of another quadric V to be a quadric passing through the curve of intersection of the given quadrics.

have its equation thrown into the form $Fyz + Lxw = 0$, while the coefficients a, b, c, d are wanting in the equation of the other. We have, then,

$$\Delta = F^2L^2, \Theta = 2FL(Fl + Lf), \Phi = (Fl + Lf)^2 + 2FL(fl - gm - hn), \\ \Theta' = 2(fl - gm - hn)(Fl + Lf).$$

And the required condition is

$$4\Delta\Theta\Phi = \Theta^3 + 8\Delta^2\Theta'.$$

Similarly the condition that it may be possible to find a tetrahedron having two pairs of opposite edges on the surface of one, and whose four faces touch the other, is

$$4\Delta'\Theta'\Phi = \Theta'^3 + 8\Delta'^2\Theta.$$

This may be derived from the equation examined in the next article.

208. *To find the general form of the equation of a quadric which touches the four faces x, y, z, w of the tetrahedron of reference.* The reciprocal quadric will pass through the four vertices of the tetrahedron, and its equation will be of the form

$$2fyz + 2gzx + 2hxy + 2lxw + 2myw + 2nzw = 0.$$

The equation of the reciprocal of this is (Arts. 67, 79)

$$2fmn\alpha^2 + 2gnl\beta^2 + 2hlm\gamma^2 + 2fgh\delta^2 \\ + 2(fl - gm - hn)(l\beta\gamma + f\alpha\delta) + 2(gm - hn - fl)(m\gamma\alpha + g\beta\delta) \\ + 2(hn - fl - gm)(n\alpha\beta + h\gamma\delta) = 0.$$

If now we write for $\alpha \sqrt{fmn}$, $\beta \sqrt{gnl}$, $\gamma \sqrt{hlm}$, $\delta \sqrt{fgh}$, x, y, z, w respectively, this equation becomes

$$x^2 + y^2 + z^2 + w^2 + \frac{fl - gm - hn}{\sqrt{ghmn}}(yz + xw) \\ + \frac{gm - hn - fl}{\sqrt{hfnl}}(zx + yw) + \frac{hn - fl - gm}{\sqrt{fglm}}(xy + zw) = 0.$$

Now it is easy to see that these three coefficients are respectively $-2 \cos A$, $-2 \cos B$, $-2 \cos C$, where A, B, C are the angles of a plane triangle whose sides are \sqrt{fl} , \sqrt{gm} , \sqrt{hn} . Hence, the general form of the equation of a quadric touching the four planes of reference is

$$x^2 + y^2 + z^2 + w^2 - 2p(yz + xw) - 2q(zx + yw) - 2r(xy + zw) = 0,$$

where p, q, r are the cosines of the angles of a plane triangle, or, in other words, are subject to the condition $1 - 2pqr = p^2 + q^2 + r^2$. It may be seen otherwise that the surface whose equation has been written is actually touched by the four planes; for the condition just stated is the condition of the vanishing of the discriminant of the conic obtained by writing x, y, z , or $w = 0$, in the equation of the quadric. The section therefore by each of the four planes being two real or imaginary lines, each of these planes is a tangent plane.

209. If V represents a cone we have $\Delta' = 0$, and we proceed to examine the meaning in this case of Θ, Φ, Θ' . For simplicity we may take the origin as the vertex of V , or l', m', n', d' all = 0. We have then $\Theta' = d'(a'b'c' + 2f'g'h' - a'f'^2 - b'g'^2 - c'h'^2)$, or Θ' vanishes either if the cone break up into two planes, or if the vertex of the cone be on the surface U . Let the cone whose vertex is the origin and which circumscribes U , viz.

$$d(ax^2 + by^2 + cz^2 + 2fyz + 2gzx + 2hxy) - (lx + my + nz)^2$$

be written

$$ax^2 + by^2 + cz^2 + 2fyz + 2gzx + 2hxy = 0,$$

then Φ may be written

$$a(b'c' - f'^2) + b(c'a' - g'^2) + c(a'b' - h'^2) \\ + 2f(g'h' - a'f') + 2g(h'f' - b'g') + 2h(f'g' - c'h').$$

Hence, by the theory of the invariants of plane conics (*Conics*, Art 375) $\Phi = 0$ expresses the condition that it shall be possible to draw three tangent lines to U from the vertex of the cone V , which shall form a system self-conjugate with regard to V . In like manner

$$d\Theta = a'(bc - f^2) + b'(ca - g^2) + \&c.,$$

or Θ vanishes whenever three tangent planes to U can be drawn from the vertex of the cone V which shall form a system self-conjugate with regard to V . The discriminant of the cubic in λ will vanish when the cone V touches U .

When V represents two planes, both Δ' and Θ' vanish. Let the two planes be x and y , then V reduces to $2h'xy$, and Φ

reduces to $h'^2(n^2 - cd)$, Φ will vanish therefore in this case when the intersection of the two planes touches U . We have $\Theta = 2h'H$, (see Art. 67) and its vanishing expresses the condition that the two planes should be conjugate with respect to U ; or, in other words, that the pole of either, with regard to U , should lie on the other. For (see Art. 79) the coordinates of the pole of the plane x are proportional to A, H, G, L , and the pole will therefore lie in the plane y when $H=0$. The condition $\Theta^2 = 4\Delta\Phi$ is satisfied if either of the two planes touches U .

210. The plane at infinity cuts any sphere in an imaginary circle the cone standing on which, and whose vertex is the origin, is $x^2 + y^2 + z^2 = 0$. Further, since this cone is also an infinitely small sphere, any diameter is perpendicular to the conjugate plane. If now we form the invariants of $x^2 + y^2 + z^2$, and the quadric given by the general equation, we get $\Theta = 0$, or $A + B + C = 0$, as the condition that the origin shall be a point whence three rectangular tangent planes can be drawn to the surface, and $\Phi = 0$, or

$$ad - l^2 + bd - m^2 + cd - n^2 = 0,$$

as the condition that the origin shall be a point whence three rectangular tangent lines can be drawn to the surface. In particular if the origin be the centre and therefore l, m, n all $= 0$, and (the surface not being a cone) d not $= 0$, the cubic is the same as that worked out (Art. 82). The condition $\Phi = 0$ reduces to $a + b + c = 0$, as the condition that it shall be possible to draw systems of three rectangular asymptotic lines to the surface; and the condition $\Theta = 0$, gives

$$bc + ca + ab - f^2 - g^2 - h^2 = 0,$$

as the condition that it shall be possible to draw systems of three rectangular asymptotic planes to the surface. These two kinds of hyperboloids answer to equilateral hyperbolas in the theory of plane curves (see Ex. 3, Art. 201); the former were called *equilateral* hyperboloids, (Ex. 21, p. 102). But *orthogonal* hyperboloids (Ex. 5, p. 100) are of a distinct kind, answering in a similar manner to circles in the theory of plane

curves, and the relation among the coefficients can be found by investigating when the pole of one of the chords of intersection at infinity of $x^2 + y^2 + z^2$ and the general cone with regard to the former lies on the latter curve.

Ex. Every equilateral hyperbola which passes through three fixed points passes through a fourth; what corresponds in the theory of quadrics? It will be seen that the truth of the plane theorem depends on the fact that the condition that the general equation of a conic shall represent an equilateral hyperbola is linear in the coefficients. Thus, then, every rectangular hyperboloid (viz. hyperboloid fulfilling such a relation as $a + b + c = 0$) which passes through seven points passes through a fixed curve, and which passes through six fixed points passes through two other fixed points. For the conditions that the surface shall pass through seven points together with the given relation enable us to determine all the coefficients of the quadric except one. Its equation therefore containing but one indeterminate is of the form $U + kV$ which passes through a fixed curve. And when six points are given the equation can be brought to the form $U + kV + lW$ which passes through eight fixed points.

211. Since any tangent plane to the cone $x^2 + y^2 + z^2$ is $xx' + yy' + zz' = 0$, where $x'^2 + y'^2 + z'^2 = 0$, and since any parallel plane passes through the same line at infinity, we see that $\alpha^2 + \beta^2 + \gamma^2 = 0$ is the condition that the plane $\alpha x + \beta y + \gamma z + \delta$ shall pass through one of the tangent lines to the imaginary circle at infinity through which all spheres pass. And therefore $\alpha^2 + \beta^2 + \gamma^2 = 0$ may be said to be the tangential equation of this circle. The invariants formed with $\alpha^2 + \beta^2 + \gamma^2$ and the tangential equation of the surface are

$$\Theta = \Delta^2 (a + b + c), \quad \Phi = \Delta (bc - f^2 + ca - g^2 + ab - h^2),$$

the geometrical meaning of which has been stated in the last article.

The condition that two planes should be at right angles viz. $\alpha\alpha' + \beta\beta' + \gamma\gamma' = 0$ (Art. 29), being the same as the condition that two planes should be conjugate with regard to $\alpha^2 + \beta^2 + \gamma^2$, we see that two planes at right angles are conjugate with regard to the imaginary circle at infinity; or, what is the same thing, their intersections with the plane infinity are conjugate in regard to the circle.

212. In general, the tangential equation of a curve in space expresses the condition that any plane should pass through one of the tangents of the curve. For instance, the condition

(Art. 80) that the intersection of the planes $\alpha x + \beta y + \gamma z + \delta w$, $\alpha'x + \beta'y + \gamma'z + \delta'w$ should touch a quadric, may be considered as the tangential equation of the conic in which the quadric is met by the plane $\alpha'x + \beta'y + \gamma'z + \delta'w$.

The reciprocal of a plane curve is a cone (Art. 123), and since an ordinary equation of the second degree whose discriminant vanishes represents a cone, so a tangential equation of the second degree whose discriminant vanishes represents a plane conic. From such a tangential equation $A\alpha^2 + B\beta^2 + \&c.$ we can derive the ordinary equations of the curve, by first forming the reciprocal of the given tangential equation according to the ordinary rules, $(BCD + \&c.)x^2 + \&c.$, when we shall obtain a perfect square, viz. the square of the equation of the plane of the curve. And the conic is determined, by combining with this the equation

$$x^2(BC - F^2) + y^2(CA - G^2) + z^2(AB - H^2) + 2yz(GH - AF) + 2zx(HF - BG) + 2xy(FG - CH) = 0,$$

which represents the cone joining the conic to the origin.

213. To find the equation of the cone which touches a quadric U along the section made in it by any plane $\alpha x + \beta y + \gamma z + \delta w$. The equation of any quadric touching U along this plane section being $kU + (\alpha x + \beta y + \gamma z + \delta w)^2 = 0$, it is required to determine k so that this shall represent a cone. We find in this case Φ, Θ', Δ' all = 0. And if we denote by σ the quantity $A\alpha^2 + B\beta^2 + \&c.$ (Art. 79), the equation to determine k has three roots = 0, the fourth root being given by the equation $k\Delta + \sigma = 0$. The equation of the required cone is therefore $\sigma U = \Delta(\alpha x + \beta y + \gamma z + \delta w)^2$. When the given plane touches U , we have $\sigma = 0$, Art. 79, and the cone reduces to the tangent plane itself, as evidently ought to be the case. Under the problem of this article is included that of finding the equation of the asymptotic cone to a quadric given by the general equation.

214. The condition $\sigma = 0$, that $\alpha x + \beta y + \gamma z + \delta w$ should touch U , is a *contravariant* (see *Conics*, Art. 380) of the third order in the coefficients. If we substitute for each coefficient $a, a + \lambda a', \&c.$, we shall get the condition that $\alpha x + \beta y + \gamma z + \delta w$ shall touch the surface $U + \lambda V$, a condition which will be of

the form $\sigma + \lambda\tau + \lambda^2\tau' + \lambda^3\sigma' = 0$. The functions $\sigma, \sigma', \tau, \tau'$ each contain $\alpha, \beta, \&c.$ in the second degree, and the coefficients of U and V in the third degree. In terms of these functions can be expressed the condition that the plane $\alpha x + \beta y + \gamma z + \delta w$ should have any permanent relation to the surfaces U, V ; as for instance that it should cut them in sections u, v , connected by such permanent relations as can be expressed by relations between the coefficients of the discriminant of $u + \lambda v$. Thus if we form the discriminant with respect to λ of $\sigma + \lambda\tau + \lambda^2\tau' + \lambda^3\sigma'$, we get the condition that $\alpha x + \beta y + \gamma z + \delta w$ should meet the surfaces in sections which touch; or, in other words, the condition that this plane should pass through a tangent line of the curve of intersection of U and V . This condition is of the eighth order in $\alpha, \beta, \gamma, \delta$, and of the sixth order in the coefficients of each of the surfaces. Thus, again, $\tau = 0$ expresses the condition that the plane should cut the surfaces in two sections such that a triangle self-conjugate with respect to one can be inscribed in the other, &c.

The equation $\sigma = 0$ may also be regarded as the tangential equation of the surface U ; and, in like manner, $\tau = 0, \tau' = 0$ are tangential equations of quadrics having fixed relations to U and V . Thus, from what we have just seen, $\tau = 0$ is the envelope of a plane cutting the surface in two sections having to each other the relation just stated. And the discriminant of $\sigma + \lambda\tau + \lambda^2\tau' + \lambda^3\sigma'$ is the tangential equation of the curve of intersection of U and V .

Or, again, $\sigma = 0$ may be regarded as the equation of the surface reciprocal to U with regard to $x^2 + y^2 + z^2 + w^2$ (Art. 127). And, in like manner, $\sigma + \lambda\tau + \lambda^2\tau' + \lambda^3\sigma'$ is the equation of the surface reciprocal to $U + \lambda V$. Since, if λ varies, $U + \lambda V$ denotes a series of quadrics passing through a common curve, the reciprocal system touches a common developable, which is the reciprocal of the curve UV . And the discriminant of $\sigma + \lambda\tau + \lambda^2\tau' + \lambda^3\sigma'$ may be regarded at pleasure as the tangential equation of the curve UV , or as the equation of the reciprocal developable. This equation is, as was remarked above, of the eighth degree in the new variables, and of the sixth in the coefficients of each surface.

When $\Delta=0$, σ is the square of a linear function of $\alpha, \beta, \gamma, \delta$; and when the surface consists of two planes it is easily seen by putting in the values of the coefficients, that each first minor of Δ vanishes, and therefore in this case σ vanishes identically.

215. We can reciprocate the process employed in the last article. If $\sigma=0$, $\sigma'=0$ be the tangential equations of two quadrics, we can form the equation in ordinary coordinates answering to $\sigma + \lambda\sigma'$. This will be of the form

$$\Delta^2 U + \lambda \Delta T + \lambda^2 \Delta' T' + \lambda^3 \Delta'^2 V = 0,$$

and will represent a system of quadrics all touching a common developable, whose equation is found by forming the discriminant of the equation last written. Thus, for example, using the canonical forms, let

$$U = ax^2 + by^2 + cz^2 + dw^2, \quad V = a'x^2 + b'y^2 + c'z^2 + d'w^2;$$

then $\sigma = A\alpha^2 + B\beta^2 + C\gamma^2 + D\delta^2$, $\sigma' = A'\alpha^2 + B'\beta^2 + C'\gamma^2 + D'\delta^2$, where $A = bcd$, $B = cda$, &c., and the reciprocal of $\sigma + \lambda\sigma'$ is $\{BCDx^2 + \&c.\} + \lambda \{(BCD' + CDB' + DBC')x^2 + \&c.\} + \lambda^2 \{(B'C'D + C'D'B + D'B'C)x^2 + \&c.\} + \lambda^3 \{B'C'D'x^2 + \&c.\} = 0$.

Putting in the values for B, C, D , &c., we find

$$BCDx^2 + \&c. = \Delta^2 U,$$

while the coefficient of λ is

$$\Delta \{aa' (b'c'd + c'd'b + d'b'c) x^2 + \&c.\}.$$

Just as all contravariants of the system σ, σ' can be expressed in terms of two fixed contravariants τ, τ' together with σ, σ' , so all *covariants* of the system U, V can be expressed in terms of the two fixed covariants T, T' together with U, V and the invariants (Art. 200). Reciprocating what was stated in the last article we can see that the quadric T is the locus of a point whence cones circumscribing U and V are so related that three edges of one can be found, which form a self-conjugate system with regard to the second, and three tangent planes of the second which form a self-conjugate system with regard to the first.

If we please we may use instead of T and T' the quadric S , which is the locus of the poles with respect to V of all the

tangent planes to U , and S' the locus of the poles with respect to U of all the tangent planes to V (see Ex. 10, Art. 121). By the help of the canonical form we can see what relations connect S and S' with T and T' . Thus we easily find

$$S = bcda'^2x^2 + cdab'^2y^2 + dabc'^2z^2 + abcd'^2w^2.$$

But $T' = aa'(bcd' + cdb' + dbc')x^2 + \&c.$

$$= (bcda' + cdab' + dabc' + abcd') (a'x^2 + \&c.) - (bcda'^2x^2 + \&c.),$$

hence $T' = \Theta V - S$, and in like manner $T = \Theta' U - S'$. It appears thus that U, S', T have a common curve of intersection.

Ex. 1. To find the locus of a point whose polar planes with respect to U touch $U + \lambda V$. We have then in $\sigma + \lambda\tau + \lambda^2\tau' + \lambda^3\sigma'$ to substitute U_1, U_2, U_3, U_4 for $\alpha, \beta, \gamma, \delta$. The result is expressible in terms of the covariants by means of the canonical forms $U = x^2 + y^2 + z^2 + w^2, V = ax^2 + by^2 + cz^2 + dw^2$. For the result is

$$x^2 + \&c. + \lambda \{(b + c + d)x^2 + \&c.\} + \lambda^2 \{(bc + cd + db)x^2 + \&c.\} + \lambda^3 (bcdx^2 + \&c.) = 0,$$

or

$$\Delta U + \lambda (\Theta U - \Delta V) + \lambda^2 (\Phi U - T') + \lambda^3 (\Theta' U - T) = 0.$$

In like manner the locus of points, whose polar planes with respect to V touch $U + \lambda V$, is

$$\bar{S} = \Theta V - T' + \lambda (\Phi V - T) + \lambda^2 (\Theta' V - \Delta' U) + \lambda^3 \Delta' V = 0.$$

Ex. 2. To find the locus of a point whose polar planes with respect to U and V are a conjugate pair with regard to $U + \lambda V$. In the same manner that the condition that two points should be conjugate with respect to V is $ax'x'' + by'y'' + \&c. = 0$, so the condition that two planes should be conjugate is $A\alpha\alpha' + B\beta\beta' + \&c. = 0$. Applying this to the case where α, β are $U_1, U_2, \&c.$, we get for the canonical form

$$ax^2 + \&c. + \lambda \{(b + c + d)ax^2 + \&c.\} + \lambda^2 \{(bc + cd + db)ax^2 + \&c.\} + \lambda^3 abcd(x^2 + \&c.) = 0,$$

or

$$\Delta V + \lambda T' + \lambda^2 T + \lambda^3 \Delta' U = 0.$$

Ex. 3. To find the discriminant of T . Ans. $\Delta\Delta' \{ \Theta'^2 \Phi - \Delta' (\Theta\Theta' - \Delta\Delta') \}$.

216. What has been stated in the last article enables us to write down the equation of the developable circumscribing two given quadrics U, V . We have seen that its equation is the discriminant of the cubic $\Delta^2 U + \lambda \Delta T + \lambda^2 \Delta' T' + \lambda^3 \Delta'^2 V$, where if

$$U = ax^2 + by^2 + cz^2 + dw^2, \quad T = aa'(b'c'd + c'd'b + d'b'c)x^2 + \&c.$$

Clearing the discriminant of the factor $\Delta^2 \Delta'^2$, the result is

$$27\Delta^2 \Delta'^2 U^2 V^2 + 4\Delta' UT'^3 + 4\Delta VT'^3 = T^2 T'^2 + 18\Delta\Delta' TT' UV,$$

an equation of the eighth degree in the variables, and the tenth in the coefficients of each of the quadrics. By making $U = 0$, we see that the developable touches U along the curve UT ,

and that it meets U again in the curve of intersection of U with $T'^2 - 4\Delta VT$. We shall presently see that the latter locus represents eight right lines, real or imaginary generators of the quadric U .

It is otherwise evident what is the curve of contact of the developable with U . For the point of contact with U of a common tangent plane to UV is the pole with regard to U of a tangent plane to V , and therefore is a point on the surface S' ; and we have proved, in the last article, that the curves US' , TU are the same.

The section of the developable by one of the principal planes (w) is most easily obtained by reverting to the process whence the equation was formed. The common tangent developable of $x^2 + y^2 + z^2 + w^2$, $ax^2 + by^2 + cz^2 + dw^2$ is the discriminant of

$$\frac{ax^2}{\lambda + a} + \frac{by^2}{\lambda + b} + \frac{cz^2}{\lambda + c} + \frac{dw^2}{\lambda + d} = 0.$$

Hence, as in Art. 202, Ex. 2, if we make $w = 0$, the discriminant will be

$$\left(\frac{ax^2}{a-d} + \frac{by^2}{b-d} + \frac{cz^2}{c-d} \right)^2,$$

multiplied by the discriminant of

$$\frac{ax^2}{\lambda + a} + \frac{by^2}{\lambda + b} + \frac{cz^2}{\lambda + c}.$$

In order to obtain the latter discriminant, differentiate with regard to λ , when we have

$$\frac{ax^2}{(\lambda + a)^2} + \frac{by^2}{(\lambda + b)^2} + \frac{cz^2}{(\lambda + c)^2} = 0, \quad \frac{a^2x^2}{(\lambda + a)^2} + \frac{b^2y^2}{(\lambda + b)^2} + \frac{c^2z^2}{(\lambda + c)^2} = 0,$$

$$\text{whence } \frac{ax^2}{(\lambda + a)^2} = b - c, \quad \frac{by^2}{(\lambda + b)^2} = c - a, \quad \frac{cz^2}{(\lambda + c)^2} = a - b;$$

and, substituting in the given equation, the result is

$$x \sqrt{a(b-c)} \pm y \sqrt{b(c-a)} \pm z \sqrt{c(a-b)} = 0.$$

The section therefore is a conic counted twice and four right lines.

217. To find the condition that a given line should pass through the curve of intersection of two quadrics U and V .

Suppose that we have found, by Arts. 80, &c., the condition,

$\Psi=0$, that the line should touch U , and that we substitute in it for each coefficient $a, a+\lambda\alpha'$, the condition becomes $\Psi+\lambda\Psi_1+\lambda^2\Psi'=0$; and if the line have any arbitrary position, we can by solving this quadratic for λ , determine two surfaces passing through the curve of intersection UV and touching the given line. But if the line itself pass through UV , then it is easy to see that these two surfaces must coincide, for the line cannot, in general, be touched by a surface of the system anywhere but in the point where it meets UV . The condition therefore which we are seeking is $\Psi_1^2=4\Psi\Psi'$. It is of the second order in the coefficients of each of the surfaces and of the fourth in the coefficients of each of the planes determining the right line: these (see Art. 80) enter through the combinations $\alpha\beta' - \alpha'\beta$, &c., viz. the equation contains, and that in the fourth degree, the six coordinates of the line of intersection of the two planes.

In the case where the two quadrics are $ax^2 + by^2 + cz^2 + dw^2$, $a'x^2 + b'y^2 + c'z^2 + d'w^2$, and the right line is $\alpha x + \beta y + \gamma z + \delta w$, $\alpha'x + \beta'y + \gamma'z + \delta'w$, the quantity Ψ is (see Art. 80) $\Sigma ab(\gamma\delta' - \gamma'\delta)^2$, by which notation we mean to express the sum of the six terms of like form, such as $cd(\alpha\beta' - \alpha'\beta)^2$, &c. When the line is expressed by its ray coordinates (p. 40) the relation which holds for contact is $bcp^2 + caq^2 + abr^2 + ads^2 + bdt^2 + cdu^2 = 0$, which is satisfied by each of the *complex of lines* which touch the quadric U (see Art. 80d). Then Ψ_1 is $\Sigma(bc' + b'c)p^2$, and its vanishing is the relation for the complex of all lines which are cut harmonically by the quadrics U and V , as it is easily seen that $\Psi_1 = U'V'' + U''V' - 2PQ$ in the notation of Art. 75. Also $\Psi_1^2 - 4\Psi\Psi'$ is

$$\Sigma(bc')^2p^4 + 2\Sigma(bc')(ac')p^2q^2 + 2\Sigma\{(ab')(cd') + (ac')(bd')\}p^2s^2,$$

and vanishes for the complex of right lines intersecting the common curve.

218. *To find the equation of the developable generated by the tangent lines of the curve common to U and V .*

If we consider any point on any tangent to this curve, the polar plane of this point with regard to either U or V passes evidently through the point of contact of the tangent on which it lies. The intersection therefore of the two polar planes meets the curve UV . We find thus the equation of the

developable required, by substituting in the condition of the last article, for $\alpha, \beta, \&c., \alpha', \beta', \&c.$, the differential coefficients $U_1, U_2, \&c., V_1, V_2, \&c.$ This developable will be of the eighth degree in the variables and of the sixth in the coefficients of each surface. When we use the canonical form of the quadrics, it then easily appears that the result is

$$\Sigma (ab')^2 (cd')^4 z^4 w^4 + 2\Sigma (ab') (ac') (cd')^2 (bd')^2 y^2 z^2 w^4 + 2x^2 y^2 z^2 w^2 \\ \times \{(ab')(cd') - (ad')(bc')\} \{(ad')(bc') - (bd')(ca')\} \{(bd')(ca') - (ab')(cd')\}.$$

When we make in the above equation $w = 0$ we obtain a perfect square, hence each of the four planes x, y, z, w meets the developable in plane curves of the fourth degree which are double lines on the surface.* This is, *à priori*, evident since it is plain from the symmetry of the figure, that through any point in one of these four planes through which one tangent line of the curve UV passes, a second tangent can also be drawn.

By the help of the canonical form the previous result can be expressed in terms of the covariant quadrics when the developable is found to be

$$4(\Theta UV - T'U - \Delta V^2)(\Theta' UV - TV - \Delta' U^2) = (\Phi UV - TU - T'V)^2.$$

The curve UV is manifestly a double line† on the locus represented by this equation, as we otherwise know it to be, and the locus meets U again in the line of the eighth order determined by the intersection of U with $T'^2 - 4\Delta TV$. This is the same line as that found in Art. 216.

* See *Cambridge and Dublin Mathematical Journal*, vol. III., p. 171, where, though only the geometrical proof is given, I had arrived at the result by actual formation of the equation of the developable. See *Ibid.*, vol. II., p. 68. The equations were also worked out by Mr. Cayley, *Ibid.*, vol. v., pp. 50, 51.

† It is proved, as at *Higher Plane Curves*, Art. 51, (see also Art. 110 of this volume) that when the equation of a surface is $U^2\phi + UV\psi + V^2\chi = 0$, then UV is a double line on the surface, the two tangent planes at any point of it being given by the equation $u^2\phi' + uv\psi' + v^2\chi' = 0$, where u, v are the tangent planes at that point to U and V , and ϕ' is the result of substituting in ϕ the coordinates of this point, &c. Applying this to the above equation it is immediately found that the two tangent planes are given by the equation $(TU - T'V)^2 = 0$, where in T, T' the coordinates of the point are supposed to be substituted. Thus the two tangent planes at every point of the double curve coincide, and the curve is accordingly called a cuspidal curve on the surface.

219. We can shew geometrically (as was stated Art. 216) that a generator of the quadric U at each of the eight points of intersection of the three surfaces U, V, S' , (or U, V, T) is also a generator of the developable, and that therefore these eight lines form the locus of the eighth order, $U, T'^2 - 4\Delta TV$. For the surface S' being the locus of the poles with regard to U of the tangent planes to V , the tangent plane to V at one of the eight points in question is also a tangent plane to U , and therefore passes through one of the generators to U at the same point. This generator is therefore the line of intersection of the tangent planes to U and V , and therefore is a generator of the developable in question.

220. The calculation in Art. 218 may also be made as follows: When we write in the determinant of Art. 80 for $a, a + \lambda a'$ &c., and for α, β &c. U_1, U_2 &c., for α', β' &c. V_1, V_2 &c., we can reduce it by subtracting from the first column the sum of the third multiplied by x , of the fourth, fifth, and sixth multiplied respectively by y, z , and w , and then, removing the terms $-\lambda V_1$ &c. in the first column by means of V_1 &c. in the second; when we deal similarly with the rows, the determinant becomes

$$(U + \lambda V) \bar{S} - V^2 (\Delta + \lambda \Theta + \lambda^2 \Phi + \lambda^3 \Theta' + \lambda^4 \Delta'),$$

where $-\bar{S}$ is the value of the determinant of Art. 79, when a &c. are replaced by $a + \lambda a'$ &c. and α &c. by V_1 &c. But the last result of Ex. 1, Art. 215, determined the value of \bar{S} . Putting in that value we find, as it should be, that λ occurs in no higher power than the second, and the determinant becomes

$$(\Theta UV - T'U - \Delta V^2) + \lambda (\Phi UV - TU - T'V) + \lambda^2 (\Theta' UV - TV - \Delta' U^2) = 0.$$

Thus then we see that $\Theta UV = T'U + \Delta V^2$ is the condition that the intersection of the two polar planes should touch U ; while $\Phi UV = TU + T'V$ is the condition that it should be cut harmonically by the surfaces U, V ; and again the equation of the developable is

$$4 (\Theta UV - T'U - \Delta V^2) (\Theta' UV - TV - \Delta' U^2) = (\Phi UV - TU - T'V)^2.$$

220a. The equation of this developable has been otherwise derived by Mr. W. R. Roberts as follows: When the line whose ray coordinates are p, q, r, s, t, u is a generator of

$$ax^2 + by^2 + cz^2 + dw^2 = 0,$$

we have (Art. 80c)

$$\begin{aligned} 0 &= cq^2 + br^2 + ds^2, \\ 0 &= cp^2 + ar^2 + dt^2, \\ 0 &= bp^2 + aq^2 + du^2, \\ 0 &= as^2 + bt^2 + cu^2, \end{aligned}$$

which are equivalent to the four equations

$$p^2 = s^2 \frac{ad}{bc}, \quad q^2 = t^2 \frac{bd}{ca}, \quad r^2 = u^2 \frac{cd}{ab}, \quad as^2 + bt^2 + cu^2 = 0.$$

Now a generator of any one of the system of quadrics through the curve common to U and V is a line which meets that curve in two points; hence the line whose coordinates are related as follows:

$$\begin{aligned} p^2 &= s^2 \frac{(a + \lambda a')(d + \lambda d')}{(b + \lambda b')(c + \lambda c')}, \quad q^2 = t^2 \frac{(b + \lambda b')(d + \lambda d')}{(c + \lambda c')(a + \lambda a')}, \\ r^2 &= u^2 \frac{(c + \lambda c')(d + \lambda d')}{(a + \lambda a')(b + \lambda b')}, \quad (a + \lambda a')s^2 + (b + \lambda b')t^2 + (c + \lambda c')u^2 = 0, \end{aligned}$$

is a generator of $U + \lambda V$ and a chord of the curve of intersection of

$$\begin{aligned} U &= ax^2 + by^2 + cz^2 + dw^2 = 0, \\ V &= a'x^2 + b'y^2 + c'z^2 + d'w^2 = 0. \end{aligned}$$

220b. Again, when a line touches the curve UV , it touches both U and V , hence, in this case

$$\begin{aligned} bcp^2 + caq^2 + abr^2 + ads^2 + bdt^2 + cdu^2 &= 0, \\ b'c'p^2 + c'a'q^2 + a'b'r^2 + a'd's^2 + b'd't^2 + c'd'u^2 &= 0, \end{aligned}$$

therefore by the fourth relation in last article

$$(bcd' + \lambda b'c'd)p^2 + (cad' + \lambda c'a'd)q^2 + (abd' + \lambda a'b'd)r^2 = 0,$$

or, replacing p^2, q^2, r^2 , by their values in s^2, t^2, u^2 ,

$$\begin{aligned} (bcd' + \lambda b'c'd)(a + \lambda a')^2 s^2 + (cad' + \lambda c'a'd)(b + \lambda b')^2 t^2 \\ + (abd' + \lambda a'b'd)(c + \lambda c')^2 u^2 = 0, \end{aligned}$$

solving between this and

$$(a + \lambda a') s^2 + (b + \lambda b') t^2 + (c + \lambda c') u^2 = 0,$$

we get s^2 , t^2 , u^2 , and accordingly also p^2 , q^2 , r^2 .

Omitting a common factor, the results may be written

$$p^2 = (bc') (ad') (a + \lambda a') (d + \lambda d'),$$

$$q^2 = (ca') (bd') (b + \lambda b') (d + \lambda d'),$$

$$r^2 = (ab') (cd') (c + \lambda c') (d + \lambda d'),$$

$$s^2 = (bc') (ad') (b + \lambda b') (c + \lambda c'),$$

$$t^2 = (ca') (bd') (c + \lambda c') (a + \lambda a'),$$

$$u^2 = (ab') (cd') (a + \lambda a') (b + \lambda b'),$$

and evidently admit of $ps + qt + ru = 0$ being identically satisfied.

220c. From these expressions in the parameter λ , for the coordinates of any generator, the equation of the developable may be found in ordinary coordinates by the usual method. For any point on the line we must have, for instance,

$$px + qy + rz = 0,$$

but we have also $U + \lambda V = 0$, hence the surface is

$$x \{(bc') (ad') (aV - a'U)\}^{\frac{1}{2}} + y \{(ca') (bd') (bV - b'U)\}^{\frac{1}{2}} \\ + z \{(ab') (cd') (cV - c'U)\}^{\frac{1}{2}} = 0,$$

and the section by the plane $z = 0$ is seen at once to be a double curve which is a trinodal quartic; and similarly for the other planes of reference. Again, this equation of the surface evidently, on rationalisation, becomes of the form

$$U^2\phi + UV\psi + V^2\chi,$$

whence UV is a double line on it; also, making $U = 0$, \sqrt{V} becomes a factor, and the eight right lines forming the remaining intersection with U are at once found.

220d. If the line pqr , &c. be contained in the plane $\alpha x + \beta y + \gamma z + \delta w = 0$ its coordinates satisfy $\alpha s + \beta t + \gamma u = 0$ &c. (Art. 57b). If the consecutive line also lie in this plane

$$\alpha \frac{ds}{d\lambda} + \beta \frac{dt}{d\lambda} + \gamma \frac{du}{d\lambda} = 0.$$

By these, determining α, β, γ , it is seen that the following are symmetrical expressions for the coordinates of the plane of two consecutive generators of the developable, or of two consecutive tangents to the common curve UV , omitting a common factor,

$$\alpha^2 (ab') (ac') (ad') = (a + \lambda\alpha')^3,$$

$$\beta^2 (bc') (bd') (ba') = (b + \lambda\beta')^3,$$

$$\gamma^2 (cd') (ca') (cb') = (c + \lambda\gamma')^3,$$

$$\delta^2 (da') (db') (dc') = (d + \lambda\delta')^3,$$

also the expressions

$$x^2 (ab') (ac') (ad') = a + \mu\alpha',$$

$$y^2 (bc') (bd') (ba') = b + \mu\beta',$$

$$z^2 (cd') (ca') (cb') = c + \mu\gamma',$$

$$w^2 (da') (db') (dc') = d + \mu\delta',$$

are easily seen to be those for the coordinates of any point on the curve UV .

221. The equation $ax^2 + by^2 + cz^2 + \lambda(x^2 + y^2 + z^2) = 1$ denotes (Art. 104) a system of concentric quadrics having common planes of circular section. And the form of the equation shews that the system in question has common the imaginary curve in which the point sphere $x^2 + y^2 + z^2$ meets any quadric of the system. Again, since the tangential equation of the system of confocal quadrics

$$\frac{x^2}{a + \lambda} + \frac{y^2}{b + \lambda} + \frac{z^2}{c + \lambda} = 1,$$

is $a\alpha^2 + b\beta^2 + c\gamma^2 + \lambda(\alpha^2 + \beta^2 + \gamma^2) = 1$,

it follows reciprocally that a system of confocal quadrics is touched by a common imaginary developable (see Art. 146); namely, that enveloped by the tangent planes drawn to any surface of the system, through the tangent lines to the imaginary circle at infinity. The equation of this developable is found by forming the discriminant with regard to λ of the

equation of the system of quadrics. If we write $b - c = p$, $c - a = q$, $a - b = r$, the equation is

$$\begin{aligned} (x^2 + y^2 + z^2)^2 & (p^2 x^4 + q^2 y^4 + r^2 z^4 - 2qry^2 z^2 - 2rpx^2 z^2 - 2pqx^2 y^2) \\ & + 2p^2 (q - r) x^6 + 2q^2 (r - p) y^6 + 2r^2 (p - q) z^6 \\ & + 2p (pr - 3q^2) x^4 y^2 - 2q (qr - 3p^2) x^2 y^4 - 2p (pq - 3r^2) x^4 z^2 \\ & + 2r (qr - 3p^2) x^2 z^4 + 2q (qp - 3r^2) y^4 z^2 - 2r (rp - 3q^2) z^4 y^2 \\ & + 2 (p - q) (q - r) (r - p) x^2 y^2 z^2 + (p^4 - 6p^2 qr) x^4 \\ & + (q^4 - 6q^2 pr) y^4 + (r^4 - 6r^2 pq) z^4 + 2pq (pq - 3r^2) x^2 y^2 \\ & + 2qr (qr - 3p^2) y^2 z^2 + 2rp (rp - 3q^2) z^2 x^2 + 2p^2 qr (r - q) x^2 \\ & + 2q^2 rp (p - r) y^2 + 2r^2 pq (q - p) z^2 + p^2 q^2 r^2 = 0. \end{aligned}$$

It may be deduced from this equation, or as in Art. 202, that the focal conics, and the imaginary circle at infinity, are double lines on the surface.

222. In like manner, if $\sigma = 0$ be the tangential equation of a quadric, and if we form the reciprocal of $\sigma + \lambda (\alpha^2 + \beta^2 + \gamma^2)$, we get

$$\begin{aligned} \Delta^2 U + \lambda \Delta & [\{a(b+c) - g^2 - h^2\} x^2 + \{b(c+a) - h^2 - f^2\} y^2 \\ & + \{c(a+b) - f^2 - g^2\} z^2 + \{d(a+b+c) - l^2 - m^2 - n^2\} \\ & + 2yz (af - gh) + 2zx (bg - hf) + 2xy (ch - fg) \\ & + 2x \{(b+c)l - hm - gn\} + 2y \{(c+a)m - fn - hl\} \\ & + 2z \{(a+b)n - gl - fm\}] \\ & + \lambda^2 \{D(x^2 + y^2 + z^2) + A + B + C - 2Lx - 2My - 2Nz\} + \lambda^3 = 0. \end{aligned}$$

This is the equation of a series of confocal surfaces, and its discriminant with respect to λ will represent the developable considered in the last article. If we write the coefficients of λ and λ^2 respectively T and T' , then $T = 0$ denotes the locus of points whence three rectangular lines can be drawn to touch the given quadric, and $T' = 0$ the locus of points whence three rectangular tangent planes can be drawn to the same quadric.

If the paraboloid $\frac{x^2}{a} + \frac{y^2}{b} + 2z$ be treated in the same way, we obtain, as the equation of a system of confocal surfaces,

$$(bx^2 + ay^2 + 2abz) + \lambda \{x^2 + y^2 + 2(a+b)z - ab\} + \lambda^2 \{2z - (a+b)\} - \lambda^3 = 0,$$

and the developable which they all touch is, if we write $a - b = r$,

$$\begin{aligned} & 4(x^2 + y^2)^2(x^2 + y^2 + z^2) + 16rz(x^2 + y^2 + z^2)(x^2 - y^2) \\ & + 4z(x^2 + y^2)(ax^2 + by^2) + 16r^2z^4 + 32r^2z^2(x^2 + y^2) \\ & + 24r(bx^2 + ay^2)z^2 + (ax^2 + by^2)^2 + 8r(bx^2 + ay^2)(x^2 - y^2) + 12r^2x^2y^2 \\ & + 16(a + b)r^2z(x^2 + y^2 + z^2) - 12r^2z(ax^2 + by^2) \\ & + 12rabz(x^2 - y^2) + 4r^2z^2(a^2 + 4ab + b^2) + 4r^2(b^2x^2 + a^2y^2) \\ & + 2abr(ax^2 - by^2) + 4r^2ab(a + b)z + a^2b^2r^2 = 0. \end{aligned}$$

The locus of intersection of three rectangular tangent planes to the paraboloid is the plane $2z = a + b$, and of three rectangular tangent lines is the paraboloid of revolution

$$x^2 + y^2 + 2(a + b)z = ab.$$

223. We shall now shew that several properties of confocal surfaces are particular cases of properties of systems inscribed in a common developable. It will be rather more convenient to state first the reciprocal properties of systems having a common curve.

Since the condition that a quadric should touch a plane (Art. 79) involves the coefficients in the third degree, it follows that of a system of quadrics passing through a common curve, three can be drawn to touch a given plane, and reciprocally, that of a system inscribed in the same developable, three can be described through a given point. It is obvious that in the former case one can be described through a given point, and in the latter, one to touch a given plane. In either case, two can be described to touch a given line; for the condition that a quadric should touch a right line (Art. 80) involves the coefficients of the quadric in the second degree.

It is also evident geometrically, that only three quadrics of a system having a common curve can be drawn to touch a given plane. For this plane meets the common curve in four points, through which the section by that plane of every surface of the system must pass. Now, since a tangent plane meets a quadric in two right lines, real or imaginary, (Art. 107) these right lines in this case can be only some one of the *three* pairs of right lines which can be drawn through the four points.

The points of contact which are the points where the lines of each pair intersect, are (*Conics*, Art. 146, Ex. 1) each the pole of the line joining the other two with regard to any conic passing through the four points. Hence (Art. 71) if the vertices of one of the four cones of the system be joined to the three points, the joining lines are conjugate diameters of this cone.

224. Now let there be a system of quadrics of the form $S + \lambda(x^2 + y^2 + z^2)$, since $x^2 + y^2 + z^2$ is a cone, the origin is one of the four vertices of cones of the system. And since $x^2 + y^2 + z^2$ is an infinitely small sphere, any three conjugate diameters are at right angles, and we conclude that three surfaces of the system can be drawn to touch any plane, and that the lines joining the three points of contact to the origin are at right angles to each other. Moreover as a system of concentric and confocal quadrics is reciprocal to a system of the form $S + \lambda(x^2 + y^2 + z^2)$, we infer that three confocal quadrics can be drawn through any point and that they cut at right angles.

Again (Art. 132) the polar planes of any point with regard to a system of the form $S + \lambda(x^2 + y^2 + z^2)$ pass through a right line, the plane joining which to the origin is perpendicular to the line joining the given point to the origin; as is evident from considering the particular surface of the system $x^2 + y^2 + z^2$. Reciprocally then the locus of the poles of a given plane with regard to a system of confocals is a line perpendicular to that plane.

225. We have seen that $\sigma + \lambda(\alpha^2 + \beta^2 + \gamma^2)$ is the tangential equation of a system of confocals: and when the discriminant of this equation vanishes it represents one of the focal conics. We can therefore find the tangential equation of the focal conics of a given surface by determining λ from the equation

$$D\lambda^3 + (bc + ca + ab - f^2 - g^2 - h^2) \Delta\lambda^2 + (a + b + c) \Delta^2\lambda + \Delta^3 = 0.$$

Thus, let the surface be

$$7x^2 + 6y^2 + 5z^2 - 4yz - 4xy + 10x + 4y + 6z + 4 = 0,$$

we have $\Delta = -972$, and the cubic is

$$162\lambda^3 + 99\lambda^2\Delta + 18\Delta^2\lambda + \Delta^3 = 0,$$

whose factors are $3\lambda + \Delta$, $6\lambda + \Delta$, $9\lambda + \Delta$, whence $\lambda = 108, 162$, or 324 .

The tangential equation of the given surface divided by 6 is $\alpha^2 - 8\beta^2 - 11\gamma^2 + 27\delta^2 + 26\beta\gamma + 46\gamma\alpha + 34\alpha\beta - 54\alpha\delta - 54\beta\delta - 54\gamma\delta = 0$. Thus then the tangential equations of the three focal conics are obtained by altering the first three terms of the equation last written into

$19\alpha^2 + 10\beta^2 + 7\gamma^2$, $28\alpha^2 + 19\beta^2 + 16\gamma^2$, $55\alpha^2 + 46\beta^2 + 43\gamma^2$, respectively. Their ordinary equations are found, as in Art. 212, to be the intersections of

$$\begin{aligned} 2x - 2y + z + w, \quad 11x^2 + 44y^2 + 11z^2 - 32yz + 2zx - 40xy; \\ x + 2y + 2z + 5w, \quad 67x^2 + 68y^2 + 83z^2 - 24yz - 62zx - 32xy; \\ 2x + y - 2z + w, \quad 5x^2 - 3y^2 + 9z^2 + 2yz - 16zx + 2xy. \end{aligned}$$

226. In order to find in *quadriplanar coordinates* the tangential equation of a surface confocal to a given one, it is necessary to find the equivalent in quadriplanar coordinates to the equation $\alpha^2 + \beta^2 + \gamma^2 = 0$.* It is evident that if x, y, z, w represent any four planes, and if their equations referred to any three rectangular axes be $X \cos A + Y \cos B + Z \cos C = p$, &c., then the coefficient of X in $\alpha x + \beta y + \gamma z + \delta w$ is

$$\alpha \cos A + \beta \cos A' + \gamma \cos A'' + \delta \cos A''',$$

and the sum of the squares of the coefficients of X, Y, Z is

$$\begin{aligned} \alpha^2 + \beta^2 + \gamma^2 + \delta^2 - 2\beta\gamma \cos(yz) - 2\gamma\alpha \cos(zx) - 2\alpha\beta \cos(xy) \\ - 2\alpha\delta \cos(xw) - 2\beta\delta \cos(yw) - 2\gamma\delta \cos(zw), \end{aligned}$$

where (yz) denotes the angle between the planes y, z , &c. This quantity, equated to nothing is the tangential equation of the imaginary circle at infinity. The processes of the last articles then can be repeated by substituting the quantity just written for $\alpha^2 + \beta^2 + \gamma^2$. We thus find, without difficulty, the condition that the general equation in quadriplanar coordinates should represent a paraboloid, or either class of rectangular

* This condition evidently expresses that the length is infinite of the perpendicular let fall from any point on any of the planes which satisfy the equation.

hyperboloid; the equations of the loci of points whence systems of three tangent planes or tangent lines are at right angles; the equations of the focal conics, &c.

227. We have seen (Art. 211) that the condition in rectangular coordinates $\alpha\alpha' + \beta\beta' + \gamma\gamma' = 0$, that the planes $\alpha x + \&c.$, $\alpha'x + \&c.$ should be at right angles, expresses that the planes should be conjugate with respect to the imaginary circle at infinity. It follows that the condition of perpendicularity in quadriplanar coordinates is

$$\alpha' \{ \alpha - \beta \cos(xy) - \gamma \cos(xz) - \delta \cos(xw) \} \\ + \beta' \{ -\alpha \cos(xy) + \beta - \gamma \cos(yz) - \delta \cos(yw) \} + \&c. = 0.$$

Any theorems concerning perpendiculars may be generalized projectively by substituting any fixed conic for the imaginary circle at infinity; and thus, instead of a perpendicular line and plane, we get a line and plane which meet the plane of the fixed conic in a point and line which are pole and polar with respect to that conic (see *Conics*, Art. 356). The theorems may be extended further (see *Conics*, Art. 385) by substituting for the fixed conic a fixed quadric, when instead of a line perpendicular to a plane, we should have a line passing through the pole of the plane with regard to the fixed quadric. These latter extensions, however, are theorems suggested, not proved.

Ex. Any tangent plane to a sphere is perpendicular to the corresponding radius.

Any plane section of a quadric is met in a conjugate line and point, by any tangent plane and the line joining its point of contact to the pole of the plane of section.

228. The tangential equation of a sphere, in rectangular coordinates, is written down at once by expressing that the distance of the centre from any tangent plane is constant. The equation is therefore

$$(\alpha x' + \beta y' + \gamma z' + \delta)^2 = r^2 (\alpha^2 + \beta^2 + \gamma^2).$$

If then x' , y' , z' , w' be the coordinates of the centre of a sphere, the tangential equation of the sphere in quadriplanar coordinates must be

$$(\alpha x' + \beta y' + \gamma z' + \delta w')^2 = r^2 \{ \alpha^2 + \beta^2 + \gamma^2 + \delta^2 - 2\alpha\beta \cos(xy) - \&c. \}.$$

If the sphere touch the four planes x, y, z, w , the coefficients of $\alpha^2, \beta^2, \gamma^2, \delta^2$ must vanish, and the tangential equation of such a sphere must therefore be

$$(\alpha \pm \beta \pm \gamma \pm \delta)^2 = \alpha^2 + \beta^2 + \gamma^2 + \delta^2 - 2\alpha\beta \cos(xy) - \&c.$$

There are therefore eight spheres which touch the faces of a tetrahedron. Taking all positive signs, we get the tangential equation of the inscribed sphere

$$\beta\gamma \cos^2 \frac{1}{2}(yz) + \gamma\alpha \cos^2 \frac{1}{2}(zx) + \alpha\beta \cos^2 \frac{1}{2}(xy) \\ + \alpha\delta \cos^2 \frac{1}{2}(xw) + \beta\delta \cos^2 \frac{1}{2}(yw) + \gamma\delta \cos^2 \frac{1}{2}(zw) = 0.$$

The corresponding quadriplanar equation is obtained from this as in Art. 208.

229. The equation of the sphere circumscribing a tetrahedron may be most simply obtained as follows: Let the four perpendiculars on each face from the opposite vertex be x_0, y_0, z_0, w_0 . Now the equation *in plano* of the circle circumscribing any triangle abc may be written in the form

$$\frac{(bc)^2 yz}{y_0 z_0} + \frac{(ca)^2 zx}{z_0 x_0} + \frac{(ab)^2 xy}{x_0 y_0} = 0,$$

where $x, x_0, \&c.$ denote perpendiculars on the sides of a triangle the lengths of which are $(bc), \&c.$ But it is evident that for any point in the face w , the ratio $x : x_0$ is the same whether x and x_0 denote perpendiculars on the plane x or on the line xw . We are thus led to the equation required, viz.

$$\frac{(bc)^2 yz}{y_0 z_0} + \frac{(ca)^2 zx}{z_0 x_0} + \frac{(ab)^2 xy}{x_0 y_0} + \frac{(ad)^2 xw}{x_0 w_0} + \frac{(bd)^2 yw}{y_0 w_0} + \frac{(cd)^2 zw}{z_0 w_0} = 0.$$

For this is a quadric whose intersection with each of the four faces is the circle circumscribing the triangle of which that face consists. If this equation be reduced to rectangular coordinates it will be found that the coefficients of x^2, y^2, z^2 are each $= -1$. Hence if we substitute the coordinates of any point, we get $-$ the square of the tangent from that point to the sphere.

COR. The square of the distance between the centres of the inscribed and circumscribing spheres is

$$D^2 = R^2 - r^2 \left\{ \frac{(bc)^2}{y_0 z_0} + \frac{(ca)^2}{z_0 x_0} + \frac{(ab)^2}{x_0 y_0} + \frac{(ad)^2}{x_0 w_0} + \frac{(bd)^2}{y_0 w_0} + \frac{(cd)^2}{z_0 w_0} \right\}.$$

230. The equation of any other sphere can only differ from the preceding by terms of the first degree, which must be of the form $(\alpha x + \beta y + \gamma z + \delta w) \left(\frac{x}{x_0} + \frac{y}{y_0} + \frac{z}{z_0} + \frac{w}{w_0} \right)$, the second factor denoting the plane at infinity (Art. 57). If then we add to the equation of the last article the product of these two factors, identify with the general equation of the second degree and eliminate the indeterminate constants, we obtain the conditions that the general equation of the second degree in quadriplanar coordinates $ax^2 + by^2 + \&c.$ may represent a sphere, viz.

$$\begin{aligned} \frac{by_0^2 + cz_0^2 - 2fy_0z_0}{(bc)^2} &= \frac{cz_0^2 + ax_0^2 - 2gz_0x_0}{(ca)^2} = \frac{ax_0^2 + by_0^2 - 2hx_0y_0}{(ab)^2} \\ &= \frac{ax_0^2 + dw_0^2 - 2lx_0w_0}{(ad)^2} = \frac{by_0^2 + dw_0^2 - 2my_0w_0}{(bd)^2} = \frac{cz_0^2 + dw_0^2 - 2nz_0w_0}{(cd)^2}. \end{aligned}$$

231. It was shewn (Art. 214) that by forming the condition that $\alpha x + \beta y + \gamma z + \delta w$ should touch $U + \lambda V$, we get an equation in λ whose coefficients are the invariants *in plano* $\Delta, \Delta', \Theta, \Theta'$ of the sections of U and V by the given plane. It was also shewn (*Conics*, Art. 382) that if we form the invariants of any conic and the pair of circular points at infinity, $\Theta = 0$ is the condition that the curve should be a parabola, $\Theta' = 0$ the condition that it should be an equilateral hyperbola, and $\Theta'^2 = 4\Theta$ the condition that the curve should pass through either circular point at infinity. Applying then these principles to any quadric in rectangular coordinates and the tangential equation of the imaginary circle $\alpha^2 + \beta^2 + \gamma^2$, we get for the condition, $\Theta = 0$, that any section should be a parabola,

$$\begin{aligned} (bc - f^2) \alpha^2 + (ca - g^2) \beta^2 + (ab - h^2) \gamma^2 \\ + 2(gh - af) \beta\gamma + 2(hf - bg) \gamma\alpha + 2(fg - ch) \alpha\beta = 0; \end{aligned}$$

for the condition $\Theta' = 0$ that it should represent an equilateral hyperbola

$$(b+c) \alpha^2 + (c+a) \beta^2 + (a+b) \gamma^2 - 2f\beta\gamma - 2g\gamma\alpha - 2h\alpha\beta = 0,$$

while $\Theta'^2 = 4\Theta$ ($\alpha^2 + \beta^2 + \gamma^2$) is the condition that the plane should pass through any of the four points at infinity common to the quadric and any sphere.

232. We know from the theory of conics that if $\sigma = 0$ be the tangential equation of a conic, and $\sigma' = 0$ the tangential equation of the two circular points at infinity in its plane, $\sigma + \lambda\sigma' = 0$ is the tangential equation of any confocal conic. Now the tangential equation of the pair of points where the imaginary circle $\alpha^2 + \beta^2 + \gamma^2$ is met by the plane $\alpha'x + \beta'y + \gamma'z + \delta'w$ is evidently $(\alpha'^2 + \beta'^2 + \gamma'^2)(\alpha^2 + \beta^2 + \gamma^2) - (\alpha\alpha' + \beta\beta' + \gamma\gamma')^2 = 0$. Thus then the tangential equation of all conics confocal to the section by $\alpha'x + \beta'y + \gamma'z + \delta'w$ of $ax^2 + by^2 + cz^2 + dw^2$, is

$$\begin{aligned} & \alpha^2 \{ (cd\beta'^2 + db\gamma'^2 + bc\delta'^2) + \lambda(\beta'^2 + \gamma'^2) \} \\ & + \beta^2 \{ (cd\alpha'^2 + da\gamma'^2 + ac\delta'^2) + \lambda(\alpha'^2 + \gamma'^2) \} \\ & + \gamma^2 \{ (bd\alpha'^2 + da\beta'^2 + ab\delta'^2) + \lambda(\alpha'^2 + \beta'^2) \} \\ & + \delta^2 (bca'^2 + ca\beta'^2 + ab\gamma'^2) - 2(ad + \lambda)\beta'\gamma'\beta\gamma \\ & - 2(bd + \lambda)\gamma'\alpha'\gamma\alpha - 2(cd + \lambda)\alpha'\beta'\alpha\beta \\ & \qquad \qquad \qquad - 2bca'\delta'\alpha\delta - 2ca\beta'\delta'\beta\delta - 2ab\gamma'\delta'\gamma\delta = 0. \end{aligned}$$

If we form the reciprocal of this according to the ordinary rules, we get the square of $\alpha'x + \beta'y + \gamma'z + \delta'w$ multiplied by $\Sigma^2 + \lambda\Sigma\Theta' + \lambda^2(\alpha^2 + \beta^2 + \gamma^2)\Theta$ where Σ is the condition that $\alpha'x + \beta'y + \gamma'z + \delta'w$ should touch the given quadric, and Θ' , Θ have the same signification as in the last article. By equating the second factor to nothing we obtain the values of λ which give the tangential equations of the foci of the plane section in question.

Ex. 1. To find the foci of the section of $4x^2 + y^2 - 4z^2 + 1$ by $x + y + z$. The equation for λ is found to be $3\lambda^2 + 2\lambda = 16$, whence $\lambda = 2$ or $-\frac{8}{3}$. The equation of the last article, for the values $\alpha' = \beta' = \gamma' = 1$, and the given values of a, b, c, d , is $\alpha^2(-3 + 2\lambda) + 2\lambda\beta^2 + (5 + 2\lambda)\gamma^2 - 16\delta^2 - 2(4 + \lambda)\beta\gamma - 2(1 + \lambda)\gamma\alpha + 2(4 - \lambda)\alpha\beta = 0$. Substituting $\lambda = 2$ it becomes $(\alpha + 2\beta - 3\gamma)^2 - 16\delta^2$, whence the coordinates of the foci are $\pm \frac{1}{4}, \pm \frac{1}{4}, \mp \frac{1}{4}$. The other value of λ gives the imaginary foci.

Ex. 2. To find the locus of the foci of all central sections of the quadric $\alpha x^2 + by^2 + cz^2 + 1$. Making $\delta' = 0$, the equation for λ is found to be

$$\frac{\alpha'^2}{a + \lambda} + \frac{\beta'^2}{b + \lambda} + \frac{\gamma'^2}{c + \lambda} = 0.$$

By the help of this relation the tangential equation of the foci is reduced to the form

$$\left(\frac{\alpha\alpha'}{a + \lambda} + \frac{\beta\beta'}{b + \lambda} + \frac{\gamma\gamma'}{c + \lambda} \right)^2 - \frac{bca'^2 + ca\beta'^2 + ab\gamma'^2}{(a + \lambda)(b + \lambda)(c + \lambda)} \delta^2 = 0.$$

Thus then the coordinates of the foci are

$$x = \frac{\alpha'}{a + \lambda}, \quad y = \frac{\beta'}{b + \lambda}, \quad z = \frac{\gamma'}{c + \lambda}, \quad w^2 = \frac{bca'^2 + ca\beta'^2 + ab\gamma'^2}{(a + \lambda)(b + \lambda)(c + \lambda)}.$$

Solving for α', β', γ' from the first three equations and substituting in the equation for λ , we get

$$(ax^2 + by^2 + cz^2) + \lambda (x^2 + y^2 + z^2) = 0;$$

solving for λ and substituting in the value for w^2 , we get the equation of the locus, viz.

$$(x^2 + y^2 + z^2)[bcx^2\{(a-b)y^2 + (a-c)z^2\} + cay^2\{(b-c)z^2 + (b-a)x^2\} + abz^2\{(c-a)x^2 + (c-b)y^2\}] = w^2 \{(a-b)y^2 + (a-c)z^2\} \{(b-c)z^2 + (b-a)x^2\} \{(c-a)x^2 + (c-b)y^2\},$$

a surface of the eighth degree having the centre of the given quadric as a multiple point.

The left-hand side of the equation may be written in the simpler form

$$(x^2 + y^2 + z^2) (ax^2 + by^2 + cz^2) \{a (b - c)^2 y^2 z^2 + b (c - a)^2 z^2 x^2 + c (a - b)^2 x^2 y^2\}.$$

For a discussion of this surface see a paper by M. Painvin, *Nouvelles Annales*, Second Series III. 481.

From the property that if a point be a focus of a plane section of a quadric, the plane is a cyclic plane of the tangent cone from the point; Mr. M'Cay writes down immediately this locus in the coordinate system of Art. 160.

In fact the equation of the tangent cone (173) being

$$\frac{x^2}{a^2 - a'^2} + \frac{y^2}{a^2 - a''^2} + \frac{z^2}{a^2 - a'''^2} = 0,$$

one of its pairs of cyclic planes is

$$\frac{a'^2 - a''^2}{a^2 - a'^2} x^2 = \frac{a''^2 - a'''^2}{a^2 - a'''^2} z^2.$$

But, for central sections, since the coordinates of the centre satisfy this equation, we may replace x by p' and z by p''' , Art. 165. Substituting these values, we get

$$\frac{a'^2 b'^2 c'^2}{a^2 - a'^2} = \frac{a''^2 b''^2 c''^2}{a^2 - a'''^2} \dots\dots\dots(1).$$

It is easily derived from this by the cubic equation of Art. 158, taking $a^2 - a'^2 = \lambda^2$, $a^2 - a'''^2 = \nu^2$, and μ^2 the third root, that $\mu^2 = \frac{\rho^2 S}{S + 1}$, where $\rho^2 = x^2 + y^2 + z^2$, and $S = \frac{x^2}{a^2} + \frac{y^2}{b^2} + \frac{z^2}{c^2} - 1$; and this value of μ^2 substituted in the cubic gives an equation of the eighth degree in x, y, z as above. It is similarly seen that each side of (1), also $= \frac{a''^2 b''^2 c''^2}{a^2 - a''^2}$.

Ex. 3. To find the locus of foci of sections parallel to an axis (say $\alpha' = 0$). The equation which must break up into factors is in this case

$$\alpha^2 \{(c + \lambda) \beta'^2 + (b + \lambda) \gamma'^2 + bc\delta'^2\} + \beta^2 \{(a + \lambda) \gamma'^2 + ac\delta'^2\} + \gamma^2 \{(a + \lambda) \beta'^2 + ab\delta'^2\} + \delta^2 a (c\beta'^2 + b\gamma'^2) - 2 (a + \lambda) \beta' \gamma' \beta \gamma - 2ca\beta' \delta' \beta \delta - 2ab\gamma' \delta' \gamma \delta = 0.$$

The condition that the resolution into factors shall be possible is

$$(a + \lambda) (b\gamma'^2 + c\beta'^2) + abc\delta'^2 = 0.$$

Subject to this condition the equation becomes

$$\frac{\alpha^2}{bc(a + \lambda)} \{(c + \lambda) \beta'^2 + (b + \lambda) \gamma'^2 + bc\delta'^2\} = \left\{ \frac{\beta\beta'}{b} + \frac{\gamma\gamma'}{c} + \frac{a\delta\delta'}{a + \lambda} \right\}^2,$$

whence $\beta' = by, \gamma' = cz, a\delta' = (a + \lambda) w$, substituting which values in the equation of condition we have $(a + \lambda) w^2 + acz^2 + aby^2 = 0$; whence again substituting in

$$bc(a + \lambda) x^2 = (c + \lambda) \beta'^2 + (b + \lambda) \gamma'^2 + bc\delta'^2,$$

we get for the required locus

$$(by^2 + cz^2) \{b^2 (a - c) y^2 + c^2 (a - b) z^2 - abcx^2\} = w^2 \{b^2 (a - c) y^2 + c^2 (a - b) z^2\}.$$

It is obvious that the methods of this and the preceding article can be applied to equations in quadriplanar coordinates.

233. *Given four quadrics the locus of a point whose polar planes with respect to all four meet in a point is a surface of the fourth degree, which we call the Jacobian of the system of quadrics* (see *Conics*, Art. 388). Its equation in fact is evidently got by equating to nothing the determinant formed with the four sets of differential coefficients $U_1, U_2, U_3, U_4; V_1, V_2, \&c.$ It is evident that when the polars of any point with regard to U, V, W, T meet in a point, the polar with respect to $\lambda U + \mu V + \nu W + \pi T$ will pass through the same point. The Jacobian is also the locus of the vertices of all cones which can be represented by $\lambda U + \mu V + \nu W + \pi T$. Thus, then, given six points the locus of the vertices of all cones of the second degree which can pass through them is a surface of the fourth degree. For if T, U, V, W be any quadrics through the six points, every quadric through them can be represented by $\lambda U + \mu V + \nu W + \pi T$, since this last form contains the three independent constants which are necessary to complete the determination of the surface. It is geometrically obvious that this quartic surface passes through each of the fifteen lines joining any two of the given points, and also through each of the ten lines which are the intersections of two planes passing through the given points.

If in any case $\lambda U + \mu V + \nu W + \pi T$ can represent two planes, the intersection of those planes lies on the Jacobian.

If the four surfaces have a common self-conjugate tetrahedron the Jacobian reduces to four planes. For let the surfaces be $ax^2 + by^2 + cz^2 + dw^2, a'x^2 + b'y^2 + \&c., \&c.$, then we have $U_1 = ax, V_1 = a'x, \&c.$, and it is easy to see that the Jacobian is $xyzw$ multiplied by the determinant $(ab'c''d''')$.

If one of the quantities U be a perfect square L^2 , L is a factor in $U_1, U_2, \&c.$, and the Jacobian consists of a plane and a surface of the third order. If the surfaces have common four points in a plane, it is evident geometrically that this plane is part of the Jacobian; and if they have a plane section

common to all, this plane counts doubly in the Jacobian, which is only a surface of the second degree besides. Thus the Jacobian of four spheres is a sphere cutting the others at right angles.

COR. If a surface of the system $\lambda U + \mu V + \nu W$ touch T , the point of contact is evidently a point on the locus considered in this article, and therefore lies somewhere on the curve of intersection of T with the Jacobian. Again, if a surface of the system $\lambda U + \mu V$ touch the curve of intersection of T, W ; that is to say, if at one of the points where $\lambda U + \mu V$ meets T, W , the tangent plane to the first pass through the intersection of the tangent planes to the two others, the point of contact is evidently a point on the Jacobian of the system. It follows that sixteen surfaces of the system $\lambda U + \mu V$ can be drawn to touch T, W ; for since three surfaces of degrees m, n, p meet in mnp points, the Jacobian, which is of the fourth degree, meets the intersection of the two quadrics T, W in sixteen points.

234. To reduce a pair of quadrics U, V to the canonical form $x^2 + y^2 + z^2 + w^2, ax^2 + by^2 + cz^2 + dw^2$. In the first place the constants a, b, c, d are given by the biquadratic

$$\Delta\lambda^4 - \Theta\lambda^3 + \Phi\lambda^2 - \Theta'\lambda + \Delta' = 0.$$

Then solving the equations

$$\begin{aligned} x^2 + y^2 + z^2 + w^2 &= U, & a(bc + cd + db)x^2 + \&c. &= T, \\ a(b + c + d)x^2 + \&c. &= T', & ax^2 + \&c. &= V, \end{aligned}$$

we find x^2, y^2, z^2, w^2 , in terms of the known functions U, V, T, T' . Strictly speaking we ought to commence by dividing U and V by the fourth root of Δ , in order to reduce them to a form in which the discriminant of U shall be 1. But it will come to the same thing if leaving U and V unchanged we divide by Δ, T and T' as calculated from the coefficients of the given equation.

Ex. 1. To reduce to the canonical form

$$\begin{aligned} 5x^2 - 11y^2 - 11z^2 - 6w^2 + 24yz + 22zx - 20xy + 8yw + 4zw &= 0, \\ 25x^2 - 10y^2 - 15z^2 - 5w^2 + 38yz + 46zx - 30xy - 10xw + 10yw + 18zw &= 0. \end{aligned}$$

The reciprocals of these equations are

$$550\alpha^2 + 1036\beta^2 + 850\gamma^2 - 324\delta^2 + 2120\beta\gamma + 500\gamma\alpha - 520\alpha\beta - 180\alpha\delta + 2088\beta\delta + 1980\gamma\delta = 0,$$

$$3950\alpha^2 + 800\beta^2 + 2750\gamma^2 - 9720\delta^2 + 11200\beta\gamma + 4900\gamma\alpha - 4160\alpha\beta + 25920\beta\delta + 16200\gamma\delta = 0.$$

And the biquadratic is

$$8100 \{ \lambda^4 - 10\lambda^3 + 35\lambda^2 - 50\lambda + 24 \} = 0;$$

whence a, b, c, d are 1, 2, 3, 4. We then calculate T and T' by the formula

$$T = x^2 \{ B'(ab - h^2) + C'(ac - g^2) + D'(ad - l^2) + 2F'(af - gh) + 2M'(am - hl) + 2N'(an - gl) \}$$

$$+ 2yz \{ A'(af - gh) + D'(df - mn) + M'(mf - bn) + N'(nf - cm) \\ + G'(fg - ch) + H'(fh - bg) + F'(f^2 - bc) + L'(2lf - mg - nk) \} + \&c.,$$

and dividing T and T' so calculated by $\Delta (= 8100)$, we write

$$X^2 + Y^2 + Z^2 + W^2$$

$$= 5x^2 - 11y^2 - 11z^2 - 6w^2 + 24yz + 22zx - 20xy + 8yw + 4zw,$$

$$X^2 + 2Y^2 + 3Z^2 + 4W^2$$

$$= 25x^2 - 10y^2 - 15z^2 - 5w^2 + 38yz^2 + 46zx - 30xy - 10xw + 10yw + 18zw,$$

$$9X^2 + 16Y^2 + 21Z^2 + 24W^2$$

$$= 161x^2 - 100y^2 - 135z^2 - 55w^2 + 306yz + 342zx - 250xy - 70xw + 70yw + 126zw,$$

$$26X^2 + 38Y^2 + 42Z^2 + 44W^2$$

$$= 280x^2 - 300y^2 - 360z^2 - 170w^2 + 772yz + 776zx - 628xy - 108xw + 180yw + 252zw.$$

Then from $24U - V + T' - T$, we get

$$6X^2 = -6 \{ 2x + 3y - 2z - 2w \}^2.$$

And, in like manner,

$$Y^2 = - (x + 2y - 3z + 2w)^2, \quad Z^2 = (3x - y + z - w)^2, \quad W^2 = (x + y + z + w)^2.$$

Ex. 2. It having been shewn that x^2, y^2, z^2, w^2 can be expressed in terms of U, V, T, T' , it follows that the square of the Jacobian of these four surfaces can also be expressed as a function of them. We find thus

$$J^2 = \Delta T^4 - \Theta T^3 T' + \Phi T^2 T'^2 - \Theta' T T'^3 - \Theta'' T^4$$

$$+ V \{ (\Theta^2 - 2\Delta\Phi) T^3 + (\Theta\Phi - 3\Theta'\Delta) T^2 T' + (\Theta\Theta' - 4\Delta\Delta') T T'^2 - \Delta'\Theta T'^3 \}$$

$$+ U \{ (\Theta^2 - 2\Delta'\Phi) T'^3 + (\Theta'\Phi - 3\Theta\Delta') T'^2 T + (\Theta\Theta' - 4\Delta\Delta') T' T^2 - \Delta\Theta' T^3 \}$$

$$+ \Delta V^2 \{ (\Phi^2 - 2\Theta\Theta' + 2\Delta\Delta') T^2 - (\Theta'\Phi - 3\Theta\Delta') T T' + \Phi\Delta' T'^2 \}$$

$$+ \Delta' U^2 \{ (\Phi^2 - 2\Theta\Theta' + 2\Delta\Delta') T'^2 - (\Theta\Phi - 3\Delta\Theta') T T' + \Delta\Phi T^2 \}$$

$$+ T \{ (\Theta'^2 - 2\Delta'\Phi) V^3 \Delta^2 - (\Theta'\Phi^2 - 2\Theta\Theta'^2 + 5\Theta'\Delta'\Delta - \Theta\Phi\Delta') V^2 U \Delta \\ + (\Theta^2\Phi - 2\Phi^2\Delta - \Theta\Theta'\Delta + 4\Delta'\Delta^2) \Delta' V U^2 - \Delta\Delta'^2 \Theta U^3 \}$$

$$+ T' \{ (\Theta^2 - 2\Delta\Phi) U^3 \Delta'^2 - (\Theta\Phi^2 - 2\Theta'\Theta^2 + 5\Theta\Delta\Delta' - \Theta'\Phi\Delta) U^2 V \Delta' \\ + (\Theta'^2\Phi - 2\Phi^2\Delta' - \Theta\Theta'\Delta' + 4\Delta\Delta'^2) \Delta U V^2 - \Delta^2\Delta'\Theta' V^3 \}$$

$$+ \Delta^3 \Delta'^2 V^4 + \Delta^2 \Delta'^3 U^4 - UV^3 \Delta^2 \{ \Theta^3 - 3\Theta'\Phi\Delta' + 3\Theta\Delta'^2 \} - U^3 V \Delta'^2 \{ \Theta^3 - 3\Theta\Phi\Delta + 3\Theta'\Delta^2 \} \\ + \Delta\Delta' U^2 V^2 \{ \Phi^3 - 3\Phi\Delta\Delta' + 3\Theta^2\Delta' + 3\Theta'^2\Delta - 3\Theta\Theta'\Phi \}.$$

Ex. 3. The formulæ for the coordinates of a point on the curve UV , given Art. 220*d*, evidently result from the determination of this Article. We proceed to treat similarly the tangential equations.

Writing down the four contravariants (214) in the form

$$\begin{aligned} \alpha^2. b'c'd' + \beta^2. c'd'a' &= \sigma', \\ \alpha^2. (bc'd' + cd'b' + db'c') + \beta^2 (\quad) &= \tau', \\ \alpha^2. (c'db' + dbc' + bcd') + \beta^2 (\quad) &= \tau, \\ \alpha^2. bcd + \beta^2. cda &= \sigma, \end{aligned}$$

these give, when solved for $\alpha^2, \beta^2, \gamma^2, \delta^2,$

$$(ab') (ac') (ad') \alpha^2 = a^3\sigma' - a^2a'\tau' + aa'^2\tau - a'^3\sigma, \text{ \&c.}$$

Hence, for any tangent plane common to U and $V,$

$$(ab') (ac') (ad') \alpha^2 = aa' (a'\tau - a\tau'), \text{ \&c.}$$

The coordinates of the line in which this intersects a consecutive common tangent plane, *i.e.* the coordinates of a generator of the circumscribed developable are derived from these by taking the consecutive tangent plane

$$2 \frac{d\alpha}{\alpha} = \frac{a'd\tau - ad\tau'}{a'\tau - a\tau'}, \quad 2 \frac{d\beta}{\beta} = \frac{b'd\tau - bd\tau'}{b'\tau - b\tau'}, \text{ \&c.,}$$

whence, by taking the difference of these two and substituting for $\alpha, \beta,$ we get the value for the coordinate

$$\rho^2 = aa' (ab') (cd') (c'\tau - c\tau') (d'\tau - d\tau'),$$

and for the other coordinates values corresponding, omitting a common factor. From these the tangential equation of the circumscribed developable may be found.

235. If we form the discriminant of $\lambda U + \mu V + \nu W,$ the coefficients of the several powers of λ, μ, ν will evidently be invariants of the system $U, V, W.$ There are three invariants however of this system, (which we shall call Λ^*, I, J) which

* In the former editions it had been supposed that the equations of any three quadrics could be reduced to the form

$$\begin{aligned} U &= a x^2 + b y^2 + c z^2 + d u^2 + e v^2, \\ V &= a' x^2 + b' y^2 + c' z^2 + d' u^2 + e' v^2, \\ W &= a'' x^2 + b'' y^2 + c'' z^2 + d'' u^2 + e'' v^2, \end{aligned}$$

a form containing 12 independent constants expressed and 15 implicitly, or, in all, the right number 27 (see Art. 141). Doubt was cast on the validity of this argument when Clebsch observed that a similar argument does not hold good for plane quartics. The form

$$ax^4 + by^4 + cz^4 + du^4 + ev^4,$$

contains the right number of constants for representing a general quartic; yet for this form it is easily shown that an invariant vanishes which in general is not = 0 (see *Higher Plane Curves*, Art. 294). The same thing is true of the form

$$\frac{a}{x} + \frac{b}{y} + \frac{c}{z} + \frac{d}{u} + \frac{e}{v},$$

which though containing the right number of constants will not represent a quartic in general, but only one for which a certain invariant relation is fulfilled. Frahm

deserve special attention as being also invariants of any three quadrics of the system $\lambda U + \mu V + \nu W$; or, what is the same thing, as being also *combinants*.

The invariant Δ vanishes, when each of the three quadrics U, V, W is the polar quadric of a point with regard to a surface of the third degree. In fact it is easy to see that, taking two points 1, 2 and a cubic surface, the polar plane of 1 with respect to the polar quadric of 2 must be the same as the polar plane of 2 with regard to the polar quadric of 1. Supposing then U, V, W to be the polar quadrics of points 1, 2, 3 respectively, and expressing that the polar plane of 1 in respect of V is identical with that of 2 in respect of U , we get by comparing coefficients of x, y, z, w four equations linear in $x_1, y_1, x_2, \&c.$ Similarly two other sets of four are got by comparing the surfaces $U, W; V, W$. Eliminating then linearly the twelve unknown variables $x_1, y_1, \&c., x_2, \&c.$, the result of elimination can be written at once in the determinant form

$$\begin{vmatrix} \cdot & \cdot & \cdot & \cdot & , & -a'' - k'' - g'' - l'', & a' & h' & g' & l' \\ \cdot & \cdot & \cdot & \cdot & , & -k'' - b'' - f'' - m'', & h' & b' & f' & m' \\ \cdot & \cdot & \cdot & \cdot & , & -g'' - f'' - c'' - n'', & g' & f' & c' & n' \\ \cdot & \cdot & \cdot & \cdot & , & -l'' - m'' - n'' - d'', & l' & m' & n' & d' \\ a'' & h'' & g'' & l'', & \cdot & \cdot & \cdot & \cdot & , & -a - h - g - l \\ h'' & b'' & f'' & m'', & \cdot & \cdot & \cdot & \cdot & , & -h - b - f - m \\ g'' & f'' & c'' & n'', & \cdot & \cdot & \cdot & \cdot & , & -g - f - c - n \\ l'' & m'' & n'' & d'', & \cdot & \cdot & \cdot & \cdot & , & -l - m - n - d \\ -a' - h' - g' - l', & a & h & g & l, & \cdot & \cdot & \cdot & \cdot & \\ -h' - b' - f' - m', & h & b & f & m, & \cdot & \cdot & \cdot & \cdot & \\ -g' - f' - c' - n', & g & f & c & n, & \cdot & \cdot & \cdot & \cdot & \\ -l' - m' - n' - d', & l & m & n & d, & \cdot & \cdot & \cdot & \cdot & \end{vmatrix} = 0,$$

showed (*Math. Annal*, VII.) that there is in fact an intimate relation between the theory of three quadrics and that of a plane quartic. Form the discriminant of $\lambda U + \mu V + \nu W$ and we get a result which is a ternary quartic in λ, μ, ν of the most general kind. Now the discriminant of

$$ax^2 + by^2 + cz^2 + du^2 + ev^2,$$

is easily seen to be

$$\frac{1}{a} + \frac{1}{b} + \frac{1}{c} + \frac{1}{d} + \frac{1}{e} = 0.$$

but as this is a skew symmetrical determinant of even order, it is a perfect square, thus the condition in question is of the second order only, in the coefficients of each of the surfaces. Reducing this determinant by assuming two of the surfaces in the forms

$$\begin{aligned} a' x^2 + b' y^2 + c' z^2 + d' w^2, \\ a'' x^2 + b'' y^2 + c'' z^2 + d'' w^2, \end{aligned}$$

which is always admissible; it is found to be in this case

$$\begin{vmatrix} 0 & , & (b'a'') h, & (c'a'') g, & (d'a'') l \\ (a'b'') h, & 0 & , & (c'b'') f, & (d'b'') m \\ (a'c'') g, & (b'c'') f, & 0 & , & (d'c'') n \\ (a'd'') l, & (b'd'') m, & (c'd'') n, & 0 & \end{vmatrix},$$

which is also skew symmetrical and is the square of

$$(b'c'')(a'd'')fl + (c'a'')(b'd'')gm + (a'b'')(c'd'')hn.$$

In this form it is easily seen that Λ vanishes if U, V, W each admit of being written as sum of five squares. In fact we can in this case eliminate one variable between each pair of equations reducing two to the forms just written, making each of them the sum of four squares; and the third becomes, by replacing the fifth variable from the universal linear relation,

$$ax^2 + by^2 + cz^2 + dw^2 + e(x + y + z + w)^2 = 0,$$

whence $fl = gm = hn = e^2$, and these values substituted in the expression just found for Λ evidently make it vanish.

And, therefore, if U, V, W be three quadrics of this form the discriminant of $\lambda U + \mu V + \nu W$ is got by writing $\lambda a + \mu a' + \nu a''$ for a , &c., in the above. And according to what has been just stated this is only a ternary quartic of a special form. If then we write down the invariant condition that the discriminant of $\lambda U + \mu V + \nu W$ considered as a ternary quartic in λ, μ, ν should be capable of being reduced to the special form just mentioned, we have at the same time the condition that these quadrics should be such that their equations may be written as the sum of squares of the same five linear functions. Toeplitz (*Math. Annal*, XI.) gave the form of Λ definitely as in the text, and also by determining its symbolical expression showed that it can be expressed in terms of the functions of the coefficients which occur in the conditions that a right line should touch U, V, W respectively. The condition that a line should touch a surface may be expressed symbolically (see Arts. 80, 217) as $(12a\beta)^2$. The symbolical function $(12a'\beta')$ expresses that two lines are harmonic conjugates with regard to a surface, and is a function of the same coefficients of the quadric. And, if taking $\alpha, \beta; \alpha', \beta'$ as symbols with respect to two other surfaces we multiply by $(\alpha\beta\alpha'\beta')$ we get the symbol which expresses Λ .

236. The invariant which we call I vanishes, whenever any four of the points of intersection of U, V, W lie in a plane, (a condition which implies that the other four points of intersection lie in a plane), or, in other words, whenever it is possible to find values of λ, μ, ν , which will make $\lambda U + \mu V + \nu W$ represent two planes. Now in this case the tangential equation vanishes (Art. 214), hence, writing for $a, \lambda a + \mu a' + \nu a''$, &c. in σ , let the result be denoted by $\sigma_{000}\lambda^3 + \sigma_{001}\lambda^2\mu + \sigma_{002}\lambda^2\nu + \dots = 0$, the ten coefficients of this quadric in $\alpha, \beta, \gamma, \delta$, therefore vanish, whence we can write down the required condition as the determinant of the tenth order got by eliminating λ, μ, ν ; but each coefficient is of the third order in the original coefficients, hence this invariant, involving symmetrically each surface, must be of the tenth degree in the coefficients of each surface (compare *Conics*, 389a). That I is of the tenth degree in the coefficients of each surface may be otherwise seen as follows: Let U, U', V, W be four quadrics passing each through the same six points; then since through these points twenty planes [ten pairs of planes] can be drawn, it follows that the problem to determine λ, μ, ν so that $U + \lambda U' + \mu V + \nu W$ may represent two planes, admits of ten solutions. But λ might also be determined by forming the invariant I of the system U, V, W , and then substituting for each coefficient a of $U, a + \lambda a'$. And since there are ten values of λ , the result of substitution must contain λ in the tenth degree; and therefore I must contain the coefficients of U in the same degree.

237. The invariant which we call J vanishes, whenever any two of the eight points of intersection of the surfaces U, V, W coincide.* Thus, if at any point common to the three surfaces, their three tangent planes pass through a common line, the consecutive point on this line will also be common to all the surfaces. Such a point will also be the vertex of a cone of the system $\lambda U + \mu V + \nu W$. For take the point as origin, and if the tangent planes be $x, y, ax + by$, the equations of the

* This invariant is called by Professor Cayley the tact-invariant of a system of three quadrics, as that considered Art. 202 is the tact-invariant of a system of two.

surfaces are $x + u_2$, $y + v_2$, $ax + by + w_2$, where u_2 , v_2 , w_2 denote terms of the second degree. And it is evident that $aU + bV - W$ is a cone having the origin for its vertex.

The invariant J is of the sixteenth degree in the coefficients of each of the surfaces. For if in J we substitute for each coefficient a of U , $a + \lambda a'$ where a' is the corresponding coefficient of another surface U' , it is evident that the degree of the result in λ is the same as the number of surfaces of the system $U + \lambda U'$ which can be drawn to touch the curve of intersection of V , W ; that is to say, sixteen (Cor., Art. 233).

238. If $ax^2 + by^2 + cz^2 + du^2 + ev^2$ represent a cone, the coordinates of the vertex satisfy the four equations got by differentiating with respect to x , y , z , u ; that is to say, (remembering that $x + y + z + u + v$ is supposed to = 0) $ax = ev$, $by = ev$, &c. The coordinates of the vertex may then be written $\frac{1}{a}$, $\frac{1}{b}$, $\frac{1}{c}$, $\frac{1}{d}$, $\frac{1}{e}$, substituting which values in the condition connecting x , y , z , u , v , we obtain the discriminant of the surface, viz.

$$\frac{1}{a} + \frac{1}{b} + \frac{1}{c} + \frac{1}{d} + \frac{1}{e} = 0.$$

Thus, then, when the equations of U , V , W admit of being written in the form here used, the discriminant $\lambda U + \mu V + \nu W$ is

$$\frac{1}{\lambda a + \mu a' + \nu a''} + \frac{1}{\lambda b + \mu b' + \nu b''} + \text{\&c.} = 0;$$

and when $\lambda U + \mu V + \nu W$ represents a cone, if we substitute the coordinates of its vertex in the equation of each of the surfaces in succession, we get

$$\frac{a}{(\lambda a + \mu a' + \nu a'')^2} + \frac{b}{(\lambda b + \mu b' + \nu b'')^2} + \text{\&c.} = 0,$$

$$\frac{a'}{(\lambda a + \mu a' + \nu a'')^2} + \frac{b'}{(\lambda b + \mu b' + \nu b'')^2} + \text{\&c.} = 0, \text{\&c.}$$

But these equations are the differentials of the discriminant with respect to λ , μ , ν . Hence we derive the theorem that in the case in question if we form the discriminant of $\lambda U + \mu V + \nu W$,

and then the discriminant of this again with respect to λ, μ, ν ; J will be a factor in the result. It may be shewn easily that I must also be a factor in this result, and the result is in fact $I^2 J$.*

238a. Given three quadrics the locus of a point whose polar planes with respect to all three meet in a line is a curve of the sixth order, which may be called the Jacobian curve of the system. For such a point must evidently satisfy all the equations got by equating to nothing the determinants of the system of differential coefficients U_1 &c., of U, V_1 &c.; of V, W_1 &c.,

$$\left\| \begin{array}{cccc} U_1 & U_2 & U_3 & U_4 \\ V_1 & V_2 & V_3 & V_4 \\ W_1 & W_2 & W_3 & W_4 \end{array} \right\|,$$

but equating to zero any two of these determinants as (123) and (124) we get two surfaces of the third order which have common the cubic curve (Art. 134) whose equations are got by the vanishing of

$$\left\| \begin{array}{ccc} U_1 & V_1 & W_1 \\ U_2 & V_2 & W_2 \end{array} \right\|$$

and this does not belong to the other cubic surfaces. Hence there is only a sextic curve common.

* An analogous theorem, due to Professor Cayley, is that if U and V be homogeneous functions of two variables of the n th degree; and if we form the discriminant of $U + \lambda V$ and then the discriminant of this with respect to λ , the result will be AB^2C^3 where A is the result of elimination between U and V ; B (of the degree $2(n-2)(n-3)$ in both sets of coefficients) vanishes whenever λ can be so determined that $U + \lambda V$ shall have two pairs of equal factors; and C (of the degree $3(n-2)$) vanishes whenever λ can be determined so that $U + \lambda V$ shall have three equal factors. In like manner, if U and V be homogeneous functions of three variables, the discriminant with regard to λ of the discriminant of $U + \lambda V$ is still AB^2C^3 , where A (of the degree $3n(n-1)$ in each set of coefficients) is the condition that U and V should touch, B vanishes whenever it is possible to determine λ so that $U + \lambda V$ may have two double points; and C , so that it may have a cusp. Lastly, when U, V, W are three conics, the discriminant with respect to λ, μ, ν of the discriminant of $\lambda U + \mu V + \nu W$ is AB^2 , where $A = 0$ is the condition that the three curves should intersect and $B = 0$ is the condition that $\lambda U + \mu V + \nu W$ should ever be a perfect square.

238*b*. If we express the relation that the right line joining the points 1 and 2 may be cut in involution by three quadrics U, V, W , writing the quadratic of Art. 75 in the form

$$U_{11}\lambda^2 + 2U_{12}\lambda\mu + U_{22}\mu^2 = 0, \text{ \&c.}$$

that relation is

$$M = \begin{vmatrix} U_{11} & U_{12} & U_{22} \\ V_{11} & V_{12} & V_{22} \\ W_{11} & W_{12} & W_{22} \end{vmatrix} = 0,$$

but this may be written in the form

$$0 = \begin{vmatrix} a, b, c, d, f \dots \\ a', b', c', d', f' \dots \\ a'', b'', c'', d'', f'' \dots \end{vmatrix} \begin{vmatrix} x_1^2, y_1^2, z_1^2, w_1^2, 2y_1z_1 \dots \\ x_1x_2, y_1y_2, z_1z_2, w_1w_2, (y_1z_2 + y_2z_1) \dots \\ x_2^2, y_2^2, z_2^2, w_2^2, 2y_2z_2 \dots \end{vmatrix},$$

and it can be seen without difficulty that each determinant in the second matrix consists of powers and products of the six coordinates of the right line 1, 2. Hence we have the relation in question as a complex of the third order the coefficients of which are linear in the coefficients of each quadric. Employing a usual method of squaring, we find by multiplying

$$\begin{vmatrix} U_{11} & U_{12} & U_{22} \\ V_{11} & V_{12} & V_{22} \\ W_{11} & W_{12} & W_{22} \end{vmatrix} \begin{vmatrix} U_{22} & -2U_{12} & U_{11} \\ V_{22} & -2V_{12} & V_{11} \\ W_{22} & -2W_{12} & W_{11} \end{vmatrix} = \begin{vmatrix} 2\Psi_{00} & \Psi_{10} & \Psi_{20} \\ \Psi_{01} & 2\Psi_{11} & \Psi_{21} \\ \Psi_{02} & \Psi_{12} & 2\Psi_{22} \end{vmatrix},$$

where Ψ_{00} is the condition for the line to touch U , &c. and Ψ_{01} for it to be cut harmonically by U and V , &c. (Art. 217). Hence it is seen that the squares and products of the coefficients in M can be expressed by the combinations of the original coefficients which arise from the second minors of the discriminant Ex. 6, Art. 200. Again, the complex M is the same for any three surfaces of the system $\lambda U + \mu V + \nu W$. Also $M=0$ if for such a surface we have $\lambda U_{11} + \mu V_{11} + \nu W_{11} = 0$, $\lambda U_{12} + \mu V_{12} + \nu W_{12} = 0$, $\lambda U_{22} + \mu V_{22} + \nu W_{22} = 0$, hence (Art. 80*c*) it contains all the right lines which are contained in surfaces of the system. This complex M may be also written in axial coordinates: Toeplitz has noticed that when the products of corresponding coefficients of both forms is summed, the invariant Λ is the result.

CHAPTER X.

CONES AND SPHERO-CONICS.

239. IF a cone of any degree be cut by any sphere, whose centre is the vertex of the cone, the curve of section will evidently be such that the angle between two edges of the cone is measured by the arc joining the two corresponding points on the sphere. When the cone is of the second degree, the curve of section is called a *sphero-conic*. By stating many of the properties of cones of the second degree as properties of sphero-conics, the analogy between them and corresponding properties of conics becomes more striking.*

Strictly speaking, the intersection of a sphere with a cone of the n^{th} degree is a curve of the $2n^{\text{th}}$ degree: but when the cone is concentric with the sphere, the curve of intersection may be divided, in an infinity of ways, into two symmetrical and equal portions, either of which may be regarded as analogous to a plane curve of the n^{th} degree. For if we consider the points of the curve of intersection which lie in any hemisphere, the points diametrically opposite evidently trace out a perfectly symmetrical curve in the opposite hemisphere.†

* See M. Chasles's Memoir on Sphero-conics (published in the Sixth Volume of the *Transactions of the Royal Academy at Brussels*, and translated by Professor Graves, now Bishop of Limerick, Dublin, 1837), from which the enunciations of many of the theorems in this chapter are taken. See also M. Chasles's later papers *Comptes Rendus*, March and June, 1860.

† It has been remarked (*Higher Plane Curves*, Art. 198) that a cone of any order may comprise two forms of sheet, viz. (1) a twin-pair sheet which meets a concentric sphere in a pair of closed curves, such that each point of the one curve is opposite to a point of the other curve (of this kind are cones of the second order); or (2) a single sheet which meets a concentric sphere in a closed curve, such that each point of the curve is opposite to another point of the curve; (the plane affords an example of such a cone) see Möbius, *Abhandlungen der K. Sächs. Gesellschaft*, Vol. I.

Thus, then, a sphero-conic may be regarded as analogous either to an ellipse or to a hyperbola. A cone of the second degree evidently intersects a concentric sphere in two similar closed curves diametrically opposite to each other. One of the principal planes of the cone meets neither curve, and if we look at either of the hemispheres into which this plane divides the sphere, we see a closed curve analogous to an ellipse. The other principal planes divide the sphere into hemispheres containing each hemisphere a half of the two opposite curves, and in particular the principal plane not passing through the focal lines of the cone (*suprà*, Art. 151) divides the sphere into two hemispheres each containing a curve consisting of two opposite branches like the hyperbola.

The curve of intersection of any quadric with a concentric sphere is evidently a sphero-conic.

240. The properties of spherical curves have been studied by means of systems of spherical coordinates formed on the model of Cartesian coordinates. Choose for axes of coordinates any two great circles OX , OY intersecting at right angles, and on them let fall perpendiculars PM , PN from any point P on the sphere. These perpendiculars are not, as in plane coordinates, equal to the opposite sides of the quadrilateral OMP N ; and therefore it would seem that there is a certain latitude admissible in our selection of spherical coordinates, according as we choose for coordinates the perpendiculars PM , PN , or the intercepts OM , ON which they make on the axes.

M. Gudermann of Cleves has chosen for coordinates the tangents of the intercepts OM , ON (see Crelle's *Journal*, vol. VI., p. 240), and the reader will find an elaborate discussion of this system of coordinates in the appendix to Graves's translation of Chasles's *Memoir on Sphero-conics*. It is easy to see, however, that if we draw a tangent plane to the sphere at the point O , and if the lines joining the centre to the points M , N , P , meet that plane in points m , n , p ; then Om , On will be the Cartesian coordinates of the point p . But Om , On

are the tangents of the arcs OM , ON . Hence the equation of a spherical curve in Gudermann's system of coordinates is in reality nothing but the ordinary equation of the plane curve in which the cone joining the spherical curve to the centre of the sphere is met by the tangent plane at the point O .

So, again, if we choose for coordinates the sines of the perpendiculars PM , PN , it is easy to see, in like manner, that the equation of a spherical curve in such coordinates is only the equation of the orthogonal projection of that curve on a plane parallel to the tangent plane at the point O .

It seems, however, to us, that the properties of spherical curves are obtained more simply and directly from the equations of the cones which join them to the centre, than from the equations of any of the plane curves into which they can be projected.

241. Let the coordinates of any point P on the sphere be substituted in the equation of any plane passing through the centre (which we take for origin of coordinates), and meeting the sphere in a great circle AB , the result will be the length of the perpendicular from P on that plane; which varies as the sine of the spherical arc let fall perpendicular from P on the great circle AB . By the help of this principle the equations of cones are interpreted so as to yield properties of spherical curves in a manner precisely corresponding to that used in interpreting the equations of plane curves.

Thus, let α , β be the equations of any two planes through the centre, which may also be regarded as the equations of the great circles in which they meet the sphere, then (as at *Conics*, Art. 54) $\alpha - k\beta$ denotes a great circle, such that the sine of the perpendicular arc from any point of it on α is in a constant ratio to the sine of the perpendicular on β ; that is to say, a great circle dividing the angle between α and β into parts whose sines are in the same ratio.

Thus, again, $\alpha - k\beta$, $\alpha - k'\beta$ denote arcs forming with α and β a pencil whose anharmonic ratio is $\frac{k}{k'}$. And $\alpha - k\beta$, $\alpha + k\beta$ denotes arcs forming with α , β a harmonic pencil.

It may be noted here that if A' be the middle point of an arc AB , then B' , the fourth harmonic to A' , A , and B , is a point distant from A' by 90° . For if we join these points to the centre C , CA' is the internal bisector of the angle ACB , and therefore CB' must be the external bisector. Conversely, if two corresponding points of a harmonic system are distant from each other by 90° , each is equidistant from the other two points of the system.

It is convenient also to mention here that if $x'y'z'$ be the coordinates of any point on the sphere, then $xx' + yy' + zz'$ denotes the great circle having $x'y'z'$ for its pole. It is in fact the equation of the plane perpendicular to the line joining the centre to the point $x'y'z'$.

242. We can now immediately apply to spherical triangles the methods used for plane triangles (*Conics*, Chap. IV., &c.). Thus, if α , β , γ denote the three sides, then $l\alpha = m\beta = n\gamma$ denote three great circles meeting in a point, each of which passes through one of the vertices: while

$$m\beta + n\gamma - l\alpha, \quad n\gamma + l\alpha - m\beta, \quad l\alpha + m\beta - n\gamma$$

are the sides of the triangle formed by connecting the points where each of these joining lines meets the opposite sides of the given triangle; and $l\alpha + m\beta + n\gamma$ passes through the intersections of corresponding sides of this new triangle and of the given triangle.

The equations $\alpha = \beta = \gamma$ evidently represent the three bisectors of the angles of the triangle. And if A , B , C be the angles of the triangle, it is easily proved that, as in plane triangles, $\alpha \cos A = \beta \cos B = \gamma \cos C$ denote the three perpendiculars. It remains true, as at *Conics*, Art. 54, that if the perpendiculars from the vertices of one triangle on the sides of another meet in a point, so will the perpendiculars from the vertices of the second on the sides of the first.

The three bisectors of sides are $\alpha \sin A = \beta \sin B = \gamma \sin C$. The arc $\alpha \sin A + \beta \sin B + \gamma \sin C$ passes through the three points where each side is met by the arc joining the middle points of the other two; or, again, it passes through the

point on each side 90° distant from its middle point, for $\alpha \sin A \pm \beta \sin B$ meet γ in two points which are harmonic conjugates with the points in which α, β meet it, and since one is the middle point the other must be 90° distant from it (Art. 241). It follows from what has been just said, that the point where $\alpha \sin A + \beta \sin B + \gamma \sin C$ meets any side is the pole of the great circle perpendicular to that side at its middle point, and hence, that the intersection of the three perpendiculars of this kind (that is to say, the centre of the circumscribing circle) is the pole of the great circle $\alpha \sin A + \beta \sin B + \gamma \sin C$. The equations of the lines joining the vertices of the triangle to the centre of the circumscribing circle are found to be

$$\frac{\alpha}{\sin \frac{1}{2}(B + C - A)} = \frac{\beta}{\sin \frac{1}{2}(C + A - B)} = \frac{\gamma}{\sin \frac{1}{2}(A + B - C)}.$$

243. The condition that two great circles $ax + by + cz, a'x + b'y + c'z$ should be perpendicular is manifestly

$$aa' + bb' + cc' = 0.$$

The condition that $ax + b\beta + c\gamma, a'\alpha + b'\beta + c'\gamma$ should be perpendicular is easily found from this by substituting for α, β, γ their expressions in terms of x, y, z . The result is exactly the same as for the corresponding case in the plane, viz.

$$aa' + bb' + cc' - (bc' + b'c) \cos A - (ca' + c'a) \cos B - (ab' + ba') \cos C = 0.$$

In like manner the sine of the arc perpendicular to $ax + b\beta + c\gamma$, and passing through a given point is found by substituting the coordinates of that point in $ax + b\beta + c\gamma$ and dividing by the square root of

$$a^2 + b^2 + c^2 - 2bc \cos A - 2ca \cos B - 2ab \cos C.$$

244. Passing now to equations of the second degree, we may consider the equation $\alpha\gamma = m\beta^2$ either as denoting a cone having α and γ for tangent planes, while β passes through the edges of contact, or as denoting a sphero-conic, having α and γ for tangents, and β for their arc of contact. The equation plainly asserts that the product of the sines of perpendiculars from any point of a sphero-conic on two of its

tangents is in a constant ratio to the square of the sine of the perpendicular from the same point on the arc of contact.

In like manner the equation $\alpha\gamma = k\beta\delta$ asserts that the product of the sines of the perpendiculars from any point of a sphero-conic on two opposite sides of an inscribed quadrilateral is in a constant ratio to the product of sines of perpendiculars on the other two sides. And from this property again may be deduced, precisely as at *Conics*, Art. 259, that the anharmonic ratio of the four arcs joining four fixed points on a sphero-conic to any other point on the curve is constant. In like manner almost all the proofs of theorems respecting plane conics (given *Conics*, Chap. XIV.) apply equally to sphero-conics.

245. If α, β represent the planes of circular section (or *cyclic planes*) of a cone, the equation of the cone is of the form $x^2 + y^2 + z^2 = k\alpha\beta$ (Art. 103), which interpreted, as in the last article, shews that the product of the sines of perpendiculars from any point of a sphero-conic on the two cyclic arcs is constant. Or, again, that, "Given the base of a spherical triangle and the product of cosines of sides, the locus of vertex is a sphero-conic, the cyclic arcs of which are the great circles having for their poles the extremities of the given base." The form of the equation shews that the cyclic arcs of sphero-conics are analogous to the asymptotes of plane conics.

Every property of a sphero-conic can be doubled by considering the sphero-conic formed by the cone reciprocal to the given one. Thus (Art. 125) it was proved that the cyclic planes of one cone are perpendicular to the focal lines of the reciprocal cone. If then the points in which the focal lines meet the sphere be called the foci of the sphero-conic, the property established in this article proves that the product of the sines of the perpendiculars let fall from the two foci on any tangent to a sphero-conic is constant.

246. *If any great circle meet a sphero-conic in two points P, Q, and the cyclic arcs in points A, B, then AP = BQ.*

This is deduced from the property of the last article in

the same way as the corresponding property of the plane hyperbola is proved. The ratio of the sines of the perpendiculars from P and Q on α is equal to the ratio of the sines of perpendiculars from Q and P on β . But the sines of the perpendiculars from P and Q on α are in the ratio $\sin AP : \sin AQ$, and therefore we have

$$\sin AP : \sin AQ :: \sin BQ : \sin BP,$$

whence it may easily be inferred that $AP = BQ$.

Reciprocally, the two tangents from any point to a sphero-conic make equal angles with the arcs joining that point to the two foci.

247. As a particular case of the theorem of Art. 246 we learn that *the portion of any tangent to a sphero-conic intercepted between the two cyclic arcs is bisected at the point of contact.* This theorem may also be obtained directly from the equation of a tangent, viz.

$$2(xx' + yy' + zz') = k(\alpha'\beta + \alpha\beta').$$

The form of this equation shews that the tangent at any point is constructed by joining that point to the intersection of its polar ($xx' + yy' + zz'$, see Art. 241) with $\alpha'\beta + \beta'\alpha$ which is the fourth harmonic to the cyclic arcs α , β , and the line joining the given point to their intersection. Since then the given point is 90° distant from its harmonic conjugate in respect of the two points where the tangent at that point meets the cyclic arcs, it is equidistant from these points (Art. 241).

Reciprocally, the lines joining any point on a sphero-conic to the two foci make equal angles with the tangent at that point.

248. From the fact that the intercept by the cyclic arcs on any tangent is bisected at the point of contact, it may at once be inferred by the method of infinitesimals (see *Conics*, Art. 396) that *every tangent to a sphero-conic forms with the cyclic arcs a triangle of constant area*, or a triangle the sum of whose base angles is constant. This may also be inferred trigonometrically from the fact that the product of sines of per-

pendiculars on the cyclic arcs is constant. For if we call the intercept on the tangent c , and the angles it makes with the cyclic arcs A and B , the sines of the perpendiculars on α and β are respectively $\sin \frac{1}{2}c \sin A$, $\sin \frac{1}{2}c \sin B$. But considering the triangle of which c is the base and A and B the base angles, then, by spherical trigonometry,

$$\sin^2 \frac{1}{2}c \sin A \sin B = -\cos S \cos (S - C).$$

But C is given, therefore S , the half sum of the angles, is given.

Reciprocally, *the sum of the arcs joining the two foci to any point on a sphero-conic is constant.* Or the same may be deduced by the method of infinitesimals (see *Conics*, Art. 392) from the theorem that the focal radii make equal angles with the tangent at any point.*

249. Conversely, again, we can find the locus of a point on a sphere, such that the sum of its distances from two fixed points on the sphere may be constant. The equation $\cos(\rho + \rho') = \cos a$ may be written

$$\cos^2 \rho + \cos^2 \rho' - 2 \cos \rho \cos \rho' \cos a = \sin^2 a.$$

If then α and β denote the planes which are the polars of the two given points, since we have $\alpha = \cos \rho$, the equation of the locus is

$$\alpha^2 + \beta^2 - 2\alpha\beta \cos a = \sin^2 a (x^2 + y^2 + z^2).$$

In order to prove that the planes α and β are perpendicular to focal lines of this cone, it is only necessary to shew that sections parallel to either plane have a focus on the line perpendicular to it. Thus let α' , α'' be two planes perpendicular

* Here, again, we can see that a sphero-conic may be regarded either as an ellipse or hyperbola. The focal lines each evidently meet the sphere in two diametrically opposite points. If we choose for foci two points within one of the closed curves in which the cone meets the sphere, then the *sum* of the focal distances is constant. But if we substitute for one of the focal distances FP , the focal distance from the diametrically opposite point, then since $F'P = 180^\circ - FP$, we have the *difference* of the focal distances constant.

In like manner we may say that a variable tangent makes with the cyclic arcs angles whose difference is constant, if we substitute its supplement for one of the angles at the beginning of this article.

to each other and to α , and therefore passing through the line which we want to prove a focal line. Then since

$$x^2 + y^2 + z^2 = \alpha^2 + \alpha'^2 + \alpha''^2,$$

the equation of the locus becomes

$$\sin^2 \alpha (\alpha'^2 + \alpha''^2) = (\beta - \alpha \cos \alpha)^2.$$

If, then, this locus be cut by any plane parallel to α , $\alpha'^2 + \alpha''^2$ is the square of the distance of a point on the section from the intersection of $\alpha'\alpha''$, and we see that this distance is in a constant ratio to the distance from the line in which $\beta - \alpha \cos \alpha$ is cut by the same plane. This line is therefore the directrix of the section, the point $\alpha'\alpha''$ being the focus.

We see thus also that the general equation of a cone having the line xy for a focal line is of the form $x^2 + y^2 = (ax + by + cz)^2$; whence again it follows that *the sine of the distance of any point on a sphero-conic from a focus is in a constant ratio to the sine of the distance of the same point from a certain directrix arc.*

250. *Any two variable tangents meet the cyclic arcs in four points which lie on a circle.* For if L , M be two tangents and R the chord of contact, the equation of the sphero-conic may be written in the form $LM = R^2$; but this must be identical with $\alpha\beta = x^2 + y^2 + z^2$. Hence $\alpha\beta - LM$ is identical with $x^2 + y^2 + z^2 - R^2$. The latter quantity represents a small circle, having the same pole as R , and the form of the other shews that that circle circumscribes the quadrilateral $\alpha L\beta M$.

Reciprocally, the focal radii to any two points on a sphero-conic form a spherical quadrilateral in which a small circle can be inscribed. From this property, again, may be deduced the theorem that the sum or difference of the focal radii is constant, since the difference or sum of two opposite sides of such a quadrilateral is equal to the difference or sum of the remaining two.

251. From the properties just proved for cones can be deduced properties of quadrics in general. Thus *the product of the sines of the angles that any generator of a hyperboloid makes with the planes of circular section is constant.* For the generator is parallel to an edge of the asymptotic cone whose

circular sections are the same as those of the surface. Again, since the focal lines of the asymptotic cone are the asymptotes of the focal hyperbola, it follows from Art. 248 that the sum or difference is constant of the angles which any generator of a hyperboloid makes with the asymptotes to the focal hyperbola. Again, *given one axis of a central section of a quadric, the sum or difference is given of the angles which its plane makes with the planes of circular section.* For (Art. 102) given one axis of a central section its plane touches a cone concyclic with the given quadric, and therefore the present theorem follows at once from Art. 249.

We get an expression for the sum or difference of the angles, in terms of the given axis, by considering the principal section containing the greatest and least axes of the quadric. We obtain the cyclic planes by inflecting in that section, semi-diameters OB, OB' each = b . Then the planes containing these lines and perpendicular to the plane of the figure are the cyclic planes. Now if we draw any semi-diameter a' making an angle α with OC , we have

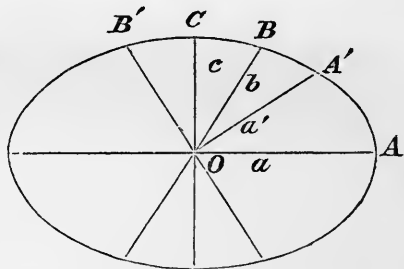

$$\frac{1}{a'^2} = \frac{\cos^2 \alpha}{c^2} + \frac{\sin^2 \alpha}{a^2}.$$

But a' is obviously an axis of the section which passes through it and is perpendicular to the plane of the figure, and (if a' be greater than b) α is evidently half the sum of the angles $BOA', B'OA'$ which the plane of the section makes with the cyclic planes. If a' be less than b , OA' falls between OB, OB' , and α is half the difference of $BOA', B'OA'$. But this sum or difference is the same for all sections having the same axis. Hence, if a', b' be the axes of any central section, making angles, θ, θ' with the cyclic planes, we have

$$\frac{1}{b'^2} = \frac{\cos^2 \frac{1}{2}(\theta - \theta')}{c^2} + \frac{\sin^2 \frac{1}{2}(\theta - \theta')}{a^2},$$

$$\frac{1}{a'^2} = \frac{\cos^2 \frac{1}{2}(\theta + \theta')}{c^2} + \frac{\sin^2 \frac{1}{2}(\theta + \theta')}{a^2}.$$

Subtracting, we have

$$\frac{1}{b'^2} - \frac{1}{a'^2} = \left(\frac{1}{c^2} - \frac{1}{a^2} \right) \sin \theta \sin \theta',$$

or, the difference of the squares of the reciprocals of the axes of a central section is proportional to the product of the sines of the angles it makes with the cyclic planes.

252. We saw (Art. 246) that, given two sphero-conics having the same cyclic arcs, the intercept made by the outer on any tangent to the inner is bisected at the point of contact; and hence, by the method of infinitesimals, that tangent cuts off from the outer a segment of constant area (*Conics*, Art. 396).

Again, if two sphero-conics have the same foci, and if tangents be drawn to the inner from any point on the outer, these tangents are equally inclined to the tangent to the outer at that point. Hence, by infinitesimals (see *Conics*, Art. 399), the excess of the sum of the two tangents over the included arc of the inner conic is constant. This theorem is the reciprocal of the first theorem of this article, and it is so that it was obtained by Dr. Graves (see his Translation of Chasles's Memoir, p. 77).

253. To find the locus of the intersection of two tangents to a sphero-conic which cut at right angles. This is, in other words, to find the cone generated by the intersection of two rectangular tangent planes to a given cone $\frac{x^2}{A} + \frac{y^2}{B} + \frac{z^2}{C} = 0$. Let the direction-angles of the perpendiculars to the two tangent planes be $\alpha'\beta'\gamma'$, $\alpha''\beta''\gamma''$; then they fulfil the relations $A \cos^2\alpha' + B \cos^2\beta' + C \cos^2\gamma' = 0$, $A \cos^2\alpha'' + B \cos^2\beta'' + C \cos^2\gamma'' = 0$.

But if α, β, γ be the direction-cosines of the line perpendicular to both, we have $\cos^2\alpha = 1 - \cos^2\alpha' - \cos^2\alpha''$, &c. Therefore adding the two preceding equations, we have for the equation of the locus,

$$Ax^2 + By^2 + Cz^2 = (A + B + C) (x^2 + y^2 + z^2),$$

a cone conicyclic with the reciprocal of the given cone. Reci-

procally, the envelope of a chord 90° in length is a sphero-conic, confocal with the reciprocal of the given cone.

254. To find the locus of the foot of the perpendicular from the focus of a sphero-conic on the tangent. The work of this question is precisely the same as that of the corresponding problem in plane conics, and the only difference is in the interpretation of the result. Let the equation of the sphero-conic (Art. 249) be $x^2 + y^2 = t^2$ where $t = ax + by + cz$, then the equation of the tangent is

$$xx' + yy' = tt',$$

and of a perpendicular to it through the origin is

$$(x' - at')y - (y' - bt')x = 0.$$

Solving for x' , y' , and t' from these two equations, and substituting in $x'^2 + y'^2 = t'^2$, we get for the locus required,

$$(x^2 + y^2) \{ (a^2 + b^2 - 1)(x^2 + y^2) + 2cz(ax + by) + c^2z^2 \} = 0.$$

The quantity within the brackets denotes a cone whose circular sections are parallel to the plane z .

255. It may be inferred from Art. 242 that the quantity

$$\alpha \sin A + \beta \sin B + \gamma \sin C$$

has not, as *in plano*, a fixed value for the perpendiculars from any point. It remains then to ask how the three perpendiculars from any point on three fixed great circles are connected. But this question we have implicitly answered already, for the three perpendiculars are each the complement of one of the three distances from the three poles of the sides of the triangle of reference. If then a, b, c be the sides; A, B, C the angles of the triangle of reference, then α, β, γ the sines of the perpendiculars on the sides from any point are connected by the following relation, which is only a transformation of that of Art. 54,

$$\begin{aligned} & \alpha^2 \sin^2 A + \beta^2 \sin^2 B + \gamma^2 \sin^2 C \\ & + 2\beta\gamma \sin B \sin C \cos a + 2\gamma\alpha \sin C \sin A \cos b + 2\alpha\beta \sin A \sin B \cos c \\ & = 1 - \cos^2 A - \cos^2 B - \cos^2 C - 2 \cos A \cos B \cos C. \end{aligned}$$

The equation in this form represents a relation between the sines of the arcs represented by α, β, γ . If we want to get a relation between the perpendiculars from any point of the sphere on the planes represented by α, β, γ , we have evidently only to multiply the right-hand side of the preceding equation by r^2 , and that equation in α, β, γ will be the transformation of the equation $x^2 + y^2 + z^2 = r^2$.

Hence, it appears that if we equate the left-hand side of the preceding equation to zero, the equation will be the same as $x^2 + y^2 + z^2 = 0$, and therefore denotes the imaginary circle which is the intersection of two concentric spheres; that is to say, the imaginary circle at infinity (see Art. 139).

256. This equation may be used to find the equation of the sphere inscribed in a given tetrahedron, whose faces are $\alpha, \beta, \gamma, \delta$. If through the centre three planes be drawn parallel to α, β, γ , the perpendiculars on them from any point will be $\alpha - r, \beta - r, \gamma - r$. The equation of the sphere is therefore

$$(\alpha - r)^2 \sin^2 A + (\beta - r)^2 \sin^2 B + \&c. \\ = r^2 (1 - \cos^2 A - \cos^2 B - \cos^2 C - 2 \cos A \cos B \cos C).$$

But if L, M, N, P denote the areas of the four faces, we have

$$L\alpha + M\beta + N\gamma + P\delta = (L + M + N + P) r.$$

Hence, by eliminating r , we arrive at a result reducible to the form of Art. 228.

257. The equation of a small circle (or right cone) is easily expressed. The sine of the distance of any point of the circle from the polar of the centre is constant. Hence, if α be that polar, the equation of the circle is $\alpha^2 = \cos^2 \rho (x^2 + y^2 + z^2)$.

All small circles then being given by equations of the form $S = \alpha^2$, their properties are all cases of those of conics having double contact with the same conic.

The theory of invariants may be applied to small circles. Let two circles S, S' be

$$x^2 + y^2 + z^2 - \alpha^2 \sec^2 \rho, \quad x^2 + y^2 + z^2 - \beta^2 \sec^2 \rho',$$

and let us form the condition that $\lambda S + S'$ should break up into factors. This cubic being

$$\lambda^3 \Delta + \lambda^2 \Theta + \lambda \Theta' + \Delta' = 0,$$

we have

$$\Delta = -\tan^2 \rho, \quad \Delta' = -\tan^2 \rho',$$

$$\Theta = \sec^2 \rho \sec^2 \rho' \sin^2 D - 2 \tan^2 \rho - \tan^2 \rho',$$

$$\Theta' = \sec^2 \rho \sec^2 \rho' \sin^2 D - 2 \tan^2 \rho' - \tan^2 \rho,$$

where D is the distance between the centres.

Now the corresponding values for two circles in a plane are

$$\Delta = -r^2, \quad \Delta' = -r'^2, \quad \Theta = D^2 - 2r^2 - r'^2, \quad \Theta' = D^2 - 2r'^2 - r^2.$$

Hence, if any invariant relation between two circles in a plane is expressed as a function of the radii and of the distance between their centres, the corresponding relation for circles on a sphere is obtained by substituting for $r, r', D; \tan \rho, \tan \rho',$ and $\sec \rho \sec \rho' \sin D$.

Thus the condition that two circles in a plane should touch is obtained by forming the discriminant of the cubic equation, and is either $D=0$ or $D=r \pm r'$. The corresponding equation therefore for two circles on a sphere is

$$\tan \rho \pm \tan \rho' = \sec \rho \sec \rho' \sin D, \quad \text{or} \quad \sin D = \sin(\rho \pm \rho').$$

Again, if two circles in a plane be the one inscribed in, the other circumscribed about, the same triangle, the invariant relation is fulfilled $\Theta^2 = 4\Delta\Theta'$, which gives for the distance between their centres the expression $D^2 = R^2 - 2Rr$.

The distance therefore between the centres of the inscribed and circumscribed circles of a spherical triangle is given by the formula

$$\sec^2 P \sec^2 \rho \sin^2 D = \tan^2 P - 2 \tan P \tan \rho.$$

So, in like manner, we can get the relation between two circles inscribed in, and circumscribed about, the same spherical polygon.

258. The equation of any small circle (or right cone) in trilinear coordinates must (Art. 255) be of the form

$$\begin{aligned} & \alpha^2 \sin^2 A + \beta^2 \sin^2 B + \gamma^2 \sin^2 C \\ & + 2\beta\gamma \sin B \sin C \cos a + 2\gamma\alpha \sin C \sin A \cos b + 2\alpha\beta \sin A \sin B \cos c \\ & = (l\alpha + m\beta + n\gamma)^2. \end{aligned}$$

If now the small circle circumscribe the triangle $\alpha\beta\gamma$, the coefficients of α^2 , β^2 , and γ^2 must vanish, and we must therefore have $l\alpha + m\beta + n\gamma = \alpha \sin A + \beta \sin B + \gamma \sin C$. Hence, as was proved before, this represents the polar of the centre of the circumscribing circle. Substituting the values $\sin A$, $\sin B$, $\sin C$ for l , m , n , the equation of the small circle becomes

$$\beta\gamma \tan \frac{1}{2}a + \gamma\alpha \tan \frac{1}{2}b + \alpha\beta \tan \frac{1}{2}c = 0.$$

The equation of the inscribed circle turns out to be of exactly the same form as in the case of plane triangles, viz.

$$\cos \frac{1}{2}A \sqrt{(\alpha)} \pm \cos \frac{1}{2}B \sqrt{(\beta)} \pm \cos \frac{1}{2}C \sqrt{(\gamma)} = 0.$$

The tangential equation of a small circle may either be derived by forming the reciprocal of that given at the commencement of this article, or directly from Art. 243, by expressing that the perpendicular from the centre on $\lambda\alpha + \mu\beta + \nu\gamma$ is constant. We find thus for the tangential equation of the circle whose centre is $\alpha'\beta'\gamma'$ and radius ρ

$$\begin{aligned} \sin^2 \rho (\lambda^2 + \mu^2 + \nu^2 - 2\mu\nu \cos A - 2\nu\lambda \cos B - 2\lambda\mu \cos C) \\ = (\alpha'\lambda + \beta'\mu + \gamma'\nu)^2; \end{aligned}$$

a form also shewing (see Art. 257) that every circle has double contact with the imaginary circle at infinity.

259. As a concluding exercise on the formulæ of this chapter, we investigate Dr. Hart's extension of Feuerbach's theorem for plane triangles, viz. that the four circles which touch the sides are all touched by the same circle.

It is easier to work with the tangential equations. The tangential equations of circles which touch the sides of the triangle of reference must want the terms λ^2 , μ^2 , ν^2 , and therefore evidently are

$$\lambda^2 + \mu^2 + \nu^2 - 2\mu\nu \cos A - 2\nu\lambda \cos B - 2\lambda\mu \cos C = (\lambda \pm \mu \pm \nu)^2;$$

or
$$\mu\nu \cos^2 \frac{1}{2}A + \nu\lambda \cos^2 \frac{1}{2}B + \lambda\mu \cos^2 \frac{1}{2}C = 0 \dots\dots (1),$$

$$\mu\nu \cos^2 \frac{1}{2}A - \nu\lambda \sin^2 \frac{1}{2}B - \lambda\mu \sin^2 \frac{1}{2}C = 0 \dots\dots (2),$$

$$- \mu\nu \sin^2 \frac{1}{2}A + \nu\lambda \cos^2 \frac{1}{2}B - \lambda\mu \sin^2 \frac{1}{2}C = 0 \dots\dots (3),$$

$$- \mu\nu \sin^2 \frac{1}{2}A - \nu\lambda \sin^2 \frac{1}{2}B + \lambda\mu \cos^2 \frac{1}{2}C = 0 \dots\dots (4),$$

all which four are touched by the circle (5)

$$\lambda^2 + \mu^2 + \nu^2 - 2\mu\nu \cos A - 2\nu\lambda \cos B - 2\lambda\mu \cos C \\ = \{\lambda \cos(B - C) + \mu \cos(C - A) + \nu \cos(A - B)\}^2.$$

For the centres of similitude of the circles (1) and (5) are given by the tangential equations

$$(\lambda + \mu + \nu) \pm \{\lambda \cos(B - C) + \mu \cos(C - A) + \nu \cos(A - B)\} = 0,$$

one of them therefore is

$$\lambda \sin^2 \frac{1}{2}(B - C) + \mu \sin^2 \frac{1}{2}(C - A) + \nu \sin^2 \frac{1}{2}(A - B).$$

And (*Conics*, Art. 127) the condition that this point should be on the circle (1) is

$$\cos \frac{1}{2}A \sin \frac{1}{2}(B - C) + \cos \frac{1}{2}B \sin \frac{1}{2}(C - A) + \cos \frac{1}{2}C \sin \frac{1}{2}(A - B) = 0,$$

which is satisfied. The coordinates of the point of contact are accordingly

$$\sin^2 \frac{1}{2}(B - C), \quad \sin^2 \frac{1}{2}(C - A), \quad \sin^2 \frac{1}{2}(A - B).$$

It is proved, in like manner, that the circle (5) touches the three other circles.

260. The coordinates of the centre of Dr. Hart's circle have been proved to be $\cos(B - C)$, $\cos(C - A)$, $\cos(A - B)$. This point therefore lies on the line joining the point whose coordinates are $\cos B \cos C$, $\cos C \cos A$, $\cos A \cos B$ to the point whose coordinates are $\sin B \sin C$, $\sin C \sin A$, $\sin A \sin B$; that is to say, (Art. 242) on the line joining the intersection of perpendiculars to the intersection of bisectors of sides. Since

$$\cos A - \cos(B - C) = 2 \sin \frac{1}{2}(A + B - C) \sin \frac{1}{2}(C + A - B);$$

the centre lies also on the line joining the point $\cos A$, $\cos B$, $\cos C$ to the point

$$\sin(S - B) \sin(S - C), \quad \sin(S - C) \sin(S - A), \quad \sin(S - A) \sin(S - B).$$

The first point is the intersection of lines drawn through each vertex making the same angle with one side that the perpendicular makes with the other; the second point is the intersection of perpendiculars let fall from each vertex on the line joining the middle points of the adjacent sides. The centre of Dr. Hart's circle is thus constructed as the intersection of two known lines.

261. The problem might also have been investigated by the direct equation. We write $\alpha \sin A = x$, &c., so that the equation of the imaginary circle at infinity is $U = 0$, where

$$U = x^2 + y^2 + z^2 + 2yz \cos a + 2zx \cos b + 2xy \cos c.$$

Then the equation of the inscribed circle is

$$U = \{x \cos (s - a) + y \cos (s - b) + z \cos (s - c)\}^2,$$

where $2s = a + b + c$. For this equation expanded is

$$x^2 \sin^2 (s - a) + y^2 \sin^2 (s - b) + z^2 \sin^2 (s - c) - 2yz \sin (s - b) \sin (s - c) - 2zx \sin (s - c) \sin (s - a) - 2xy \sin (s - a) \sin (s - b) = 0.$$

U is not altered if we change the sign of either a , b , or c . Consequently we get three other circles also touching x , y , z if we change the signs of either a , b , or c in the equation of the inscribed circle. All four circles will be touched by

$$U = \left\{ \frac{x \cos \frac{1}{2}b \cos \frac{1}{2}c}{\cos \frac{1}{2}a} + \frac{y \cos \frac{1}{2}c \cos \frac{1}{2}a}{\cos \frac{1}{2}b} + \frac{z \cos \frac{1}{2}a \cos \frac{1}{2}b}{\cos \frac{1}{2}c} \right\}^2.$$

This last equation not being altered by changing the sign of a , b , or c , it is evident that if it touches one it touches all. Now one of its common chords with the inscribed circle is

$$x \left\{ \cos (s - a) - \frac{\cos \frac{1}{2}b \cos \frac{1}{2}c}{\cos \frac{1}{2}a} \right\} + y \left\{ \cos (s - b) - \frac{\cos \frac{1}{2}c \cos \frac{1}{2}a}{\cos \frac{1}{2}b} \right\} + z \left\{ \cos (s - c) - \frac{\cos \frac{1}{2}a \cos \frac{1}{2}b}{\cos \frac{1}{2}c} \right\},$$

which reduced is

$$\frac{x}{\sin (s - b) - \sin (s - c)} + \frac{y}{\sin (s - c) - \sin (s - a)} + \frac{z}{\sin (s - a) - \sin (s - b)} = 0.$$

But the condition that the line $Ax + By + Cz$ shall touch $\sqrt{(ax)} + \sqrt{(by)} + \sqrt{(cz)}$ is $\frac{a}{A} + \frac{b}{B} + \frac{c}{C}$. Applying this condition,

the line we are considering will touch the inscribed circle if

$$\sin (s - a) \{ \sin (s - b) - \sin (s - c) \} + \sin (s - b) \{ \sin (s - c) - \sin (s - a) \} + \sin (s - c) \{ \sin (s - a) - \sin (s - b) \} = 0;$$

a condition which is evidently fulfilled. It will be seen that the condition is also fulfilled that the common tangent in question should touch $\sqrt{(x)} + \sqrt{(y)} + \sqrt{(z)}$; that is to say, the sphero-conic

which touches at the middle points of the sides; a fact remarked by Sir Wm. Hamilton, and which leads at once to a construction for that tangent as the fourth common tangent to two conics which have three known tangents common.

The polar of the centre of Dr. Hart's circle has been thus proved to be

$$\alpha \sin A \frac{\cos \frac{1}{2}b \cos \frac{1}{2}c}{\cos \frac{1}{2}a} + \beta \sin B \frac{\cos \frac{1}{2}c \cos \frac{1}{2}a}{\cos \frac{1}{2}b} + \gamma \sin C \frac{\cos \frac{1}{2}a \cos \frac{1}{2}b}{\cos \frac{1}{2}c} = 0,$$

or
$$\alpha \tan \frac{1}{2}a + \beta \tan \frac{1}{2}b + \gamma \tan \frac{1}{2}c = 0,$$

which may be also written

$$\alpha \cos (S - A) + \beta \cos (S - B) + \gamma \cos (S - C) = 0,$$

forms which lead to other constructions for the centre of this circle.

The radius of the circle touching three others whose centres are known, and whose radii are r, r', r'' may be determined by substituting $r + R, r' + R, r'' + R$ for d, e, f in the formulæ of Arts. 52, 54, and solving for R . Applying this method to the three escribed circles I have found that the tangent of the radius of Dr. Hart's circle is half the tangent of the radius of the circumscribing circle of the triangle.

CHAPTER XI.

GENERAL THEORY OF SURFACES.

INTRODUCTORY CHAPTER.

262. RESERVING for a future chapter a more detailed examination of the properties of surfaces in general, we shall in this chapter give an account of such parts of the general theory as can be obtained with least trouble.

Let the general equation of a surface be written in the form

$$\begin{aligned} & A \\ & + Bx + Cy + Dz \\ & + Ex^2 + Fy^2 + Gz^2 + 2Hyz + 2Kzx + 2Lxy \\ & + \&c. = 0, \end{aligned}$$

or, as we shall write it often for shortness,

$$u_0 + u_1 + u_2 + u_3 + \&c. = 0,$$

where u_2 means the aggregate of terms of the second degree, &c. Then it is evident that u_0 consists of one term, u_1 of three, u_2 of six, &c. The total number of terms in the equation is therefore the sum of $n + 1$ terms of the series 1, 3, 6, 10, &c., that is to say, $\frac{(n+1)(n+2)(n+3)}{1.2.3}$.

The number of conditions necessary to determine a surface of the n^{th} degree is one less than this, or $= \frac{n(n^2 + 6n + 11)}{6}$.

The equation above written can be thrown into the form of a polar equation by writing $\rho \cos \alpha$, $\rho \cos \beta$, $\rho \cos \gamma$ for x , y , z , when we obviously obtain an equation of the n^{th} degree, which will determine n values of the radius vector answering to any assigned values of the direction-angles α , β , γ .

263. If now the origin be on the surface, we have $u_0 = 0$, and one of the roots of the equation is always $\rho = 0$. But a second root of the equation will be $\rho = 0$ if α, β, γ be connected by the relation

$$B \cos \alpha + C \cos \beta + D \cos \gamma = 0.$$

Now multiplying this equation by ρ it becomes $Bx + Cy + Dz = 0$, and we see that it expresses merely that the radius vector must lie in the plane $u_1 = 0$. No other condition is necessary in order that the radius should meet the surface in two coincident points. Thus we see that in general *through an assumed point on a surface we can draw an infinity of radii vectores which will there meet the surface in two coincident points; that is to say, an infinity of tangent lines to the surface; and these lines lie all in one plane, called the tangent plane, determined by the equation $u_1 = 0$.*

264. *The section of any surface made by a tangent plane is a curve having the point of contact for a double point.**

Every radius vector to the surface, which lies in the tangent plane, is of course also a radius vector to the section made by that plane; and since every such radius vector (Art. 263) meets the section at the origin in two coincident points, the origin is, by definition, a double point (see *Higher Plane Curves*, Art. 37).

We have already had an illustration of this in the case of hyperboloids of one sheet, which are met by any tangent plane in a conic having a double point, that is to say, in two right lines. And the point of contact of the tangent plane to a quadric of any other species is equally to be considered as the intersection of two imaginary right lines.

From this article it follows conversely, that any plane

* I had supposed that this remark was first made by Cayley: Gregory's *Solid Geometry*, p. 132. I am informed, however, by Professor Cremona that the point had been previously noticed by the Italian geometer, Bedetti, in a memoir read before the Academy of Bologna, 1811. The theorem is a particular case of that of Art. 203. Observe that the tangents at the double point are the inflexional tangents of Art. 265, and that these may be considered as identical with the asymptotes of the indicatrix Art. 266. There is thus an anticipation of the theorem by Dupin (1813).

meeting a surface in a curve having a double point touches the surface, the double point being the point of contact. If the section have two double points, the plane will be a double tangent plane; and if it have three double points, the plane will be a triple tangent plane. Since the equation of a plane contains three constants, it is possible to determine a plane which will satisfy any three conditions, and therefore a finite number of planes can in general be determined which will meet a given surface in a curve having three double points: that is to say, *a surface has in general a determinate number of triple tangent planes.* It will also have an infinity of double tangent planes, the points of contact lying on a certain curve locus on the surface. The degree of this curve, and the number of triple tangent planes will be subjects of investigation hereafter.

265. *Through an assumed point on a surface it is generally possible to draw two lines which shall there meet the surface in three coincident points.*

In order that the radius vector may meet the surface in three coincident points, we must not only, as in Art. 263, have the condition fulfilled

$$B \cos \alpha + C \cos \beta + D \cos \gamma = 0,$$

but also $E \cos^2 \alpha + F \cos^2 \beta + G \cos^2 \gamma$

$$+ 2H \cos \beta \cos \gamma + 2K \cos \gamma \cos \alpha + 2L \cos \alpha \cos \beta = 0.$$

For if these conditions were fulfilled, A being already supposed to vanish, the equation of the n^{th} degree which determines ρ , becomes divisible by ρ^3 , and has therefore three roots $= 0$. The first condition expresses that the radius vector must lie in the tangent plane u_1 . The second expresses that the radius vector must lie in the surface $u_2 = 0$, or

$$Ex^2 + Fy^2 + Gz^2 + 2Hyz + 2Kzx + 2Lxy = 0.$$

This surface is a cone of the second degree (Art. 66) and since every such cone is met by a plane passing through its vertex in two right lines, two right lines can be found to fulfil the required conditions.

Every plane (besides the tangent plane) drawn through

either of these lines meets the surface in a section having the point of contact for a point of inflexion. For a point of inflexion is a point, the tangent at which meets the curve in three coincident points (*Higher Plane Curves*, Art. 46). On this account we shall call the two lines which meet the surface in three coincident points, the *inflexional* tangents at the point.*

The existence of these two lines may be otherwise perceived thus. We have proved that the point of contact is a double point in the section made by the tangent plane. And it has been proved (*Higher Plane Curves*, Art. 37) that at a double point can always be drawn two lines meeting the section (and therefore the surface) in three coincident points.

266. A double point may be one of three different kinds, according as the tangents at it are real, coincident, or imaginary. Accordingly the contact of a plane with a surface may be of three kinds according as the tangent plane meets it in a section having a node, a cusp, or a conjugate point; or, in other words, according as the inflexional tangents are real, coincident, or imaginary.

If instead of the tangent plane we consider with Dupin, a parallel plane indefinitely near thereto, the section of the surface by this plane may be regarded as a curve of the second order, which (as the theorem is usually but inaccurately stated) may be an ellipse, hyperbola, or *parabola*; this curve of the second order is called the *Indicatrix*.† Analytically, if taking the given point of the surface for origin, we take the normal for the axis of z , and the axes of x, y in the tangent plane; then considering x, y as infinitesimals of the first order, and consequently z as an infinitesimal of the second order, the equation of the surface, regarding z as a given constant, gives the equation of the section, and if herein we neglect infinitesimals of an order superior to the second, this reduces itself to an equation

* They are called by German writers the "Haupt-tangenten."

† Dupin, see the *Développements de Géométrie* (1813), p. 49, is quite correct, he says: "En général, une courbe du second degré, dont le centre P nous est donné, ne peut être qu'une ellipse ou une hyperbole. Elle peut cependant être une parabole: alors elle se présente sous la forme de deux lignes droites parallèles *équidistantes* de leur centre."

of the form $z + ax^2 + 2hxy + by^2 = 0$, an equation of the second order representing the indicatrix; viz. according as $ab - h^2$ is positive, negative, or zero, this is an ellipse, hyperbola or pair of parallel lines.* Geometrically, the section of the surface is either a closed curve, such as the ellipse; or, attending only to the curve in the neighbourhood of the given point, it consists of two arcs having their convexities turned towards each other, and which may be considered as portions of the two branches of a hyperbola; or the convexity vanishes, and the arcs are infinitesimal portions of two parallel right lines.

If points on a surface be called elliptic, hyperbolic, or parabolic, according to the nature of the indicatrix, we shall presently shew that in general the parabolic points form a curve locus on the surface, this curve separating the elliptic from the hyperbolic points.

In the case of a surface of the second order, taking the axes as above, the equation of the surface is

$$z + ax^2 + 2hxy + by^2 + 2gxz + 2fyz + cz^2 = 0,$$

which equation, if we regard therein x and y as infinitesimals of the first order, and therefore z as infinitesimal of the second order, reduces itself to $z + ax^2 + 2hxy + by^2 = 0$, viz. z being regarded as a constant, this is an equation of the form already mentioned as that of the indicatrix for a surface of any order whatever. The original equation, regarding therein z as a given constant, is the equation of the section of the surface by a plane parallel to the tangent plane, but it is not the proper equation of the indicatrix. To further explain this, suppose that the surface were of the third or any higher order, then besides the terms written down, there would have been in the equation terms $(x, y)^3$, &c.; to obtain the indicatrix as a curve of the second order, we must of necessity neglect these terms of the third order, and there is therefore no meaning in taking into

* This is sometimes expressed as follows: When the plane of xy is the tangent plane, and the equation of the surface is expressed in the form $z = \phi(x, y)$, we have an elliptic, hyperbolic, or parabolic point, according as $\left(\frac{d^2z}{dx dy}\right)^2$ is less, greater than, or equal to $\left(\frac{d^2z}{dx^2}\right)\left(\frac{d^2z}{dy^2}\right)$. It will be easily seen that this is equivalent to the statement in the text.

account the terms $2gxz + 2fyz$ also of the third order, or the term cz^2 which is of the fourth order.*

In the case where the indicatrix is a hyperbola, then supposing the parallel plane to coincide with the tangent plane, this hyperbola becomes a pair of real lines; viz. these are the inflexional tangents of Art. 265. And generally the two inflexional tangents may be regarded as the asymptotes (real or imaginary) of the indicatrix considered as lying in the tangent plane; they have been on this account termed the asymptotic lines of the point of the surface. If from any point of the surface we pass along one of these lines to a consecutive point, and thence along the consecutive line to a second point on the surface, and so on, we obtain a curve; and we have thus on the surface two series of curves, which are the asymptotic curves. In the case of a quadric surface, these are the two series of right lines on the surface.

267. Knowing the equation of the tangent plane when the origin is on the surface, we can, by transformation of coordinates, find the equation of the tangent plane at any point. It is proved, precisely as at Art. 62, that this equation may be written in either of the forms

$$(x - x') \frac{dU'}{dx'} + (y - y') \frac{dU'}{dy'} + (z - z') \frac{dU'}{dz'} = 0,$$

or

$$x \frac{dU'}{dx'} + y \frac{dU'}{dy'} + z \frac{dU'}{dz'} + w \frac{dU'}{dw'} = 0.$$

268. Let it be required now to find the tangent plane at a point, indefinitely near the origin, on the surface

$$z + ax^2 + 2hxy + by^2 + 2gxz + 2fyz + cz^2 + \&c. = 0.$$

We have to suppose x' , y' so small that their squares may be neglected; while, since the consecutive point is on the tangent plane, we have $z' = 0$; or, more accurately, the equation of the surface shews that z' is a quantity of the same order as the squares of x' and y' . Then, either by the formula of the last article, or else directly by putting $x + x'$, $y + y'$ for x

* See *Messenger of Mathematics*, Vol. v. (1870), p. 187.

and y , and taking the linear part of the transformed equation, the equation of a consecutive tangent plane is found to be

$$z + 2(ax' + hy')x + 2(hx' + by')y = 0.$$

Now (see *Conics*, Art. 141) $(ax' + hy')x + (hx' + by')y$ denotes the diameter of the conic $ax^2 + 2hxy + by^2 = 1$, which is conjugate to that to the point $x'y'$. Hence *any tangent plane is intersected by a consecutive tangent plane in the diameter of the indicatrix conjugate to the direction in which the consecutive point is taken.*

This, in fact, is geometrically evident from Dupin's point of view. For if we admit that the points consecutive to the given one lie on an infinitely small conic, we see that the tangent plane at any of them will pass through the tangent line to that conic; and this tangent line ultimately coincides with the diameter conjugate to that drawn to the point of contact; for the tangent line is parallel to this conjugate diameter and infinitely close to it.

Thus, then, all the tangent lines which can be drawn at a point on a surface may be distributed into pairs, such that the tangent plane at a consecutive point on either will pass through the other. Two tangent lines so related are called *conjugate tangents*.

In the case where the two inflexional tangents are real, the relation between two conjugate tangents may be otherwise stated. Take the inflexional tangents for the axes of x and y , which is equivalent to making a and $b = 0$ in the preceding equation; then the equation of a consecutive tangent plane is $z + 2h(x'y + y'x) = 0$. And since the lines x , y , $x'y + y'x$, $x'y - y'x$ form a harmonic pencil, we learn that *a pair of conjugate tangents form, with the inflexional tangents, a harmonic pencil.* This is in fact the theorem that a pair of conjugate diameters of a conic are harmonics in regard to the asymptotes.

269. In the case where the origin is a parabolic point, the equation of the surface can be thrown into the form $z + ay^2 + \&c. = 0$, and the equation of a consecutive tangent plane will be $z + 2ay'y = 0$. Hence the tangent plane at *every* point consecutive to a parabolic point passes through the in-

flexional tangent; and if the consecutive point be taken in this direction, so as to have $y' = 0$, then the consecutive tangent plane coincides with the given one. Hence *the tangent plane at a parabolic point is to be considered as a double tangent plane*, since it touches the surface in two consecutive points.* In this way parabolic points on surfaces may be considered as analogous to points of inflexion on plane curves: for we have proved (*Higher Plane Curves*, Art. 46) that the tangent line at a point of inflexion is in like manner to be regarded as a double tangent. A further analogy between parabolic points and points of inflexion will be afterwards stated.

It is necessary to have a name to distinguish double tangent planes which touch in two distinct points, from those now under consideration, where the two points of contact coincide. We shall therefore call the latter *stationary* tangent planes, the word expressing that the tangent plane being supposed to move round as we pass from one point of the surface to another, in this case it remains for an instant in the same position. For the same reason we have called the tangent lines at points of inflexion in plane curves, *stationary tangents*.

270. If on transforming the equation to any point on a surface as origin we have not only $u_0 = 0$, but also all the terms in $u_1 = 0$, so that the equation takes the form

$$ax^2 + by^2 + cz^2 + 2fyz + 2gzx + 2hxy + u_3 + \&c. = 0,$$

then it is easy to see, in like manner, that *every* line through the origin meets the curve in two coincident points; and the origin is then called a double or *conical* point. It is easy to see also that a line through the origin there meets the surface in *three* coincident points, provided that its direction-cosines satisfy the equation

$$a \cos^2 \alpha + b \cos^2 \beta + c \cos^2 \gamma \\ + 2f \cos \beta \cos \gamma + 2g \cos \gamma \cos \alpha + 2h \cos \alpha \cos \beta = 0.$$

* I believe this was first pointed out in a paper of mine, *Cambridge and Dublin Mathematical Journal*, vol. III., p. 45.

In other words, *through a conical point on a surface can be drawn an infinity of lines which will meet the surface in three coincident points, and these will all lie on a cone of the second degree* whose equation is $u_2 = 0$. Further, of these lines six will meet the surface in four coincident points; namely, the lines of intersection of the cone u_2 with the cone of the third degree $u_3 = 0$.

Double points on surfaces might be classified according to the number of these lines which are real, or according as two or more of them coincide, but we shall not enter into these details. The only special case which it is important to mention is when the cone u_2 resolves itself into two planes; and this again includes the still more special case when these two planes coincide; that is to say, when u_2 is a perfect square.

271. Every plane drawn through a conical point may, in one sense, be regarded as a tangent plane to the surface, since it meets the surface in a section having a double point, but in a special sense the tangent planes to the cone u_2 are to be regarded as tangent planes to the surface, and the sections of the surface by these planes will each have the origin as a cusp. To a conical point, then, on a surface (which is a point through which can be drawn an infinity of tangent planes), will in general correspond on the reciprocal surface a plane touching the surface in an infinity of points, which will in general lie on a conic. If, however, the cone u_2 resolves itself into two planes, the point is in the strict sense a double point, and there corresponds to it on the reciprocal surface a double tangent plane having two points of contact.

272. The results obtained in the preceding articles, by taking as our origin the point we are discussing, we shall now extend to the case where the point has any position whatever. Let us first remind the reader (see p. 29) that since the equations of a right line contain four constants, a finite number of right lines can be determined to fulfil four conditions (as, for instance, to touch a surface four times), while an infinity of lines can be found to satisfy three conditions (as, for instance, to touch

a surface three times), these right lines generating a certain surface, and their points of contact lying on a certain locus. In a subsequent chapter we shall return to the problem to determine in general the number of solutions when four conditions are given, and to determine the degree of the surface generated, and of the locus of points of contact, when three conditions are given. In this chapter we confine ourselves to the case when the right line is required to pass through a given point, whether on the surface or not. This is equivalent to two conditions; and an infinity of right lines (forming a cone) can be drawn to satisfy one other condition, while a finite number of right lines can be drawn to satisfy two other conditions.

We use Joachimsthal's method employed, *Conics*, Art. 290, *Higher Plane Curves*, Art. 59, and Art. 75 of this volume. If the quadriplanar coordinates of two points be $x'y'z'w'$, $x''y''z''w''$, then the points in which the line joining them is cut by the surface are found by substituting in the equation of the surface, for x , $\lambda x' + \mu x''$, for y , $\lambda y' + \mu y''$, &c. The result will give an equation of the n^{th} degree in $\lambda : \mu$, whose roots will be the ratios of the segments in which the line joining the two given points is cut by the surface at any of the points where it meets it. And the coordinates of any of the points of meeting are $\lambda'x' + \mu'x''$, $\lambda'y' + \mu'y''$, $\lambda'z' + \mu'z''$, $\lambda'w' + \mu'w''$, where $\lambda' : \mu'$ is one of the roots of the equation of the n^{th} degree. All this will present no difficulty to any reader who has mastered the corresponding theory for plane curves. And, as in plane curves, the result of the substitution in question may be written

$$\lambda^n U' + \lambda^{n-1} \mu \Delta U' + \frac{1}{2} \lambda^{n-2} \mu^2 \Delta^2 U' + \&c. = 0,$$

where Δ represents the operation

$$x \frac{d}{dx'} + y \frac{d}{dy'} + z \frac{d}{dz'} + w \frac{d}{dw'}.$$

Following the analogy of plane curves we shall call the surface represented by

$$x' U_1 + y' U_2 + z' U_3 + w' U_4 = 0,*$$

* As at Art. 59, U_1, U_2, U_3, U_4 denote the differential coefficients of U with regard to x, y, z, w .

the first polar of the point $x'y'z'w'$. We shall call

$$\left(x' \frac{d}{dx} + y' \frac{d}{dy} + z' \frac{d}{dz} + w' \frac{d}{dw}\right)^2 U = 0$$

the second polar, and so on; the polar plane of the same point being

$$xU'_1 + yU'_2 + zU'_3 + wU'_4 = 0.$$

Each polar surface is manifestly also a polar of the point $x'y'z'w'$ with regard to all the other polars of higher degree.

If a point be on a surface all its polars touch the tangent plane at that point; for the polar plane with regard to the surface is the tangent plane; and this must also be the polar plane with regard to the several polar surfaces. This may also be seen by taking the polar of the origin with regard to

$$u_0 w^n + u_1 w^{n-1} + u_2 w^{n-2} + \&c.,$$

where we have made the equation homogeneous by the introduction of a new variable w . The polar surfaces of the origin are got by differentiating with regard to this new variable. Thus the first polar is

$$nu_0 w^{n-1} + (n-1)u_1 w^{n-2} + (n-2)u_2 w^{n-3} + \&c.,$$

and if $u_0 = 0$, the terms of the first degree, both in the surface and in the polar, will be u_1 .

273. If now the point $x'y'z'w'$ be on the surface, U' vanishes, and one of the roots of the equation in $\lambda : \mu$ will be $\mu = 0$. A second root of that equation will be $\mu = 0$, and the line will meet the surface in two coincident points at the point $x'y'z'w'$, provided that the coefficient of $\lambda^{n-1}\mu$ vanish in the equation referred to. And in order that this should be the case, it is manifestly sufficient that $x''y''z''w''$ should satisfy the equation of the plane

$$xU'_1 + yU'_2 + zU'_3 + wU'_4 = 0.$$

It is proved, then, that all the tangent lines to a surface which can be drawn at a given point lie in a plane whose equation is that just written. By subtracting from this equation, the identity

$$x'U'_1 + y'U'_2 + zU'_3 + w'U'_4 = 0,$$

we get the ordinary Cartesian equation of the tangent plane, viz.

$$(x - x') U'_1 + (y - y') U'_2 + (z - z') U'_3 = 0.$$

Hence, again, by Art. 43, can immediately be deduced the equations of the normal, viz.

$$\frac{x - x'}{U'_1} = \frac{y - y'}{U'_2} = \frac{z - z'}{U'_3}.$$

274. The right line will meet the surface in three consecutive points, or the equation we are considering will have for three of its roots $\mu = 0$, if not only the coefficients of λ^n and $\lambda^{n-1}\mu$ vanish, but also that of $\lambda^{n-2}\mu^2$; that is to say, if the line we are considering not only lies in the tangent plane, but also in the polar quadric,

$$\left(x \frac{d}{dx'} + y \frac{d}{dy'} + z \frac{d}{dz'} + w \frac{d}{dw'}\right)^2 U' = 0.$$

Now (Art. 272) when a point is on a surface all its polars touch the surface. The tangent plane therefore, touching the polar quadric, meets it in two right lines, real or imaginary, which are the two inflexional tangents to the surface. (Art. 265).

275. *Through a point on a surface can be drawn $(n + 2)(n - 3)$ tangents which will also touch the surface elsewhere.*

In order that the line should touch at the point $x'y'z'w'$, we must, as before, have the coefficients of λ^n and $\lambda^{n-1}\mu = 0$; in consequence of which the equation we are considering becomes one of the $(n - 2)^{\text{th}}$ degree, and if the line touch the surface a second time, this reduced equation must have equal roots. The condition that this should be the case involves the coefficients of that equation in the degree $n - 3$; one term, for instance, being $(\Delta^2 U' \cdot U)^{n-3}$. By considering that term we see that this discriminant involves the coordinates $x'y'z'w'$ in the degree $(n - 2)(n - 3)$, and $xyzw$ in the degree $(n + 2)(n - 3)$. When therefore $x'y'z'w'$ is fixed, it denotes a surface which is met by the tangent plane in $(n + 2)(n - 3)$ right lines.

Thus, then, we have proved that at any point on a surface an infinity of tangent lines can be drawn: that these in general

275. More simply.

The tangent-plane cuts the surface in a curve with one double point - (not being supposed a double tangent-plane) of class is then $n(n-1) - 2$, by Plücker's formula. But the number of tangents from a pt. on a curve to the curve is less by two since two tangents are obtained in the tangent-at-that-pt. Similarly ~~that~~ to a double pt. about four, so that the no. of tangents ~~from a curve with one double point~~ which may be drawn from a double point to a curve of degree n with only one double pt. is $n(n-1) - 2 - 4$ or $(n+2)(n-3)$.



lie in a plane; that two of them pass through three consecutive points, and $(n+2)(n-3)$ of them touch the surface again.

276. Let us proceed next to consider the case of tangents drawn through a point not on the surface. Since we have in the preceding articles established relations which connect the coordinates of any point on a tangent with those of the point of contact, we can, by an interchange of accented and unaccented letters, express that it is the former point which is now supposed to be known, and the latter sought.

Thus, for example, making this interchange in the equation of Art. 273, we see that the points of contact of all tangent lines (or of all tangent planes) which can be drawn through $x'y'z'w'$ lie on the first polar, which is of the degree $(n-1)$: viz.

$$x'U_1 + y'U_2 + z'U_3 + w'U_4 = 0,$$

And since the points of contact lie also on the given surface, their locus is the curve of the degree $n(n-1)$, which is the intersection of the surface with the polar.

277. The assemblage of the tangent lines which can be drawn through $x'y'z'w'$ form a cone, the tangent planes to which are also tangent planes to the surface. The equation of this cone is found by forming the discriminant of the equation of the n^{th} degree in λ (Art. 272). For this discriminant expresses that the line joining the fixed point to $xyzw$ meets the surface in two coincident points; and therefore $xyzw$ may be a point on any tangent line through $x'y'z'w'$. The discriminant is easily seen to be of the degree $n(n-1)$, and it is otherwise evident that this must be the degree of the tangent cone. For its degree is the same as the number of lines in which it is met by any plane through the vertex. But such a plane meets the surface in a curve to which $n(n-1)$ tangents can be drawn through the fixed point, and these tangents are also the tangent lines which can be drawn to the surface through the given point.

278. *Through a point not on the surface can in general be drawn $n(n-1)(n-2)$ inflexional tangents.* We have seen (Art. 274) that the coordinates of any point on an inflexional

tangent are connected with those of its point of contact by the relations $U' = 0$, $\Delta U' = 0$, $\Delta^2 U' = 0$. If, then, we consider the $xyzw$ of any point on the tangent as known, its point of contact is determined as one of the intersections of the given surface U , which is of the n^{th} degree, with its first polar ΔU , which is of the $(n-1)^{\text{th}}$, and with the second polar $\Delta^2 U$, which is of the $(n-2)^{\text{th}}$. There are therefore $n(n-1)(n-2)$ such intersections. If the point be on the surface, this number is diminished by six.

279. *Through a point not on the surface can in general be drawn $\frac{1}{2}n(n-1)(n-2)(n-3)$ double tangents to it.* The points of contact of such lines are proved by Art. 275 to be the intersections of the given surface, of the first polar, and of the surface represented by the discriminant discussed in Art. 275, and which we there saw contained the coordinates of the point of contact in the degree $(n-2)(n-3)$. There are therefore $n(n-1)(n-2)(n-3)$ points of contact; and since there are two points of contact on each double tangent, there are half this number of double tangents. If the point be on the surface, the double tangents at the point (Art. 275) count each for two, and the number of lines through the point which touch the surface in two other points is

$$\frac{1}{2}n(n-1)(n-2)(n-3) - 2(n+2)(n-3) = \frac{1}{2}(n^2+n+2)(n-3)(n-4).$$

Thus, then, we have completed the discussion of tangent lines which pass through a given point. We have shewn that their points of contact lie on the intersection of the surface with one of the degree $n-1$, that their assemblage forms a cone of the degree $n(n-1)$, that $n(n-1)(n-2)$ of them are inflexional, and $\frac{1}{2}n(n-1)(n-2)(n-3)$ of them are double.

These latter double tangents are also plainly double edges of the tangent cone, since they belong to the cone in virtue of each contact. Along such an edge can be drawn two tangent planes to the cone, namely, the tangent planes to the surface at the two contacts.

The inflexional tangents, however, are also to be regarded as double tangents to the surface: since the line passing through

three consecutive points is a double tangent in virtue of joining the first and second, and also of joining the second and third. The inflexional tangents are therefore double tangents whose points of contact coincide. They are therefore double edges of the tangent cone; but the two tangent planes along any such edge coincide. They are therefore cuspidal edges of the cone. We have proved, then, that *the tangent cone which is of the degree $n(n-1)$ has $n(n-1)(n-2)$ cuspidal edges, and $\frac{1}{2}n(n-1)(n-2)(n-3)$ double edges*; that is to say, any plane meets the cone in a section having such a number of cusps and such a number of double points.

280. It is proved precisely as for plane curves (*Higher Plane Curves*, Art. 132), that if we take on each radius vector a length whose reciprocal is the n^{th} part of the sum of the reciprocals of the n radii vectores to the surface, then the locus of the extremity will be the polar plane of the point; that if the point be on the surface, the locus of the extremity of the mean between the reciprocals of the $n-1$ radii vectores will be the polar quadric, &c.

By interchanging accented and unaccented letters in the equation of the polar plane, it is seen that the locus of the poles of all planes which pass through a given point is the first polar of that point. The locus of the pole of a plane which passes through two fixed points is hence seen to be a curve of the $(n-1)^2$ degree, namely, the intersection of the two first polars of these points. We see also that the first polar of every point on the line joining these two points must pass through the same curve. And in like manner the first polars of any three points on a plane determine by their intersection $(n-1)^3$ points, any one of which is a pole of the plane, and through these points the first polar of every other point on the plane must pass.

281. From the theory of tangent lines drawn through a point we can in two ways derive the degree of the reciprocal surface. First, the number of points in which an arbitrary line meets the reciprocal is equal to the number of tangent

planes which can be drawn to the given surface through a given line. Consider now any two points A and B on that line, and let C be the point of contact of any tangent plane passing through AB . Then, since the line AC touches the surface, C lies on the first polar of A ; and for the like reason it lies on the first polar of B . The points of contact, therefore, are the intersection of the given surface, which is of the n^{th} degree, with the two polar surfaces, which are each of the degree $(n-1)$. The number of points of contact, and therefore *the degree of the reciprocal*, is $n(n-1)^2$.

282. Otherwise thus: let a tangent cone be drawn to the surface having the point A for its vertex; then since every tangent plane to the surface drawn through A touches this cone, the problem is, to find how many tangent planes to the cone can be drawn through any line AB ; or if we cut the cone by any plane through B , the problem is to find how many tangent lines can be drawn through B to the section of the cone. But the class of a curve whose degree is $n(n-1)$, which has $n(n-1)(n-2)$ cusps, and $\frac{1}{2}n(n-1)(n-2)(n-3)$ double points, is

$$n(n-1)\{n(n-1)-1\}-3n(n-1)(n-2) \\ -n(n-1)(n-2)(n-3)=n(n-1)^2.$$

Generally the section of the reciprocal surface by any plane corresponds to the tangent cone to the original surface through any point. And it is easy to see that the degree of the tangent cone to the reciprocal surface (as well as to the original surface) through any point is $n(n-1)$.

283. Returning to the condition that a line should touch a surface

$$xU_1' + yU_2' + zU_3' + wU_4' = 0,$$

we see that if all four differentials be made to vanish by the coordinates of any point, then every line through the point meets the surface in two coincident points, and the point is therefore a double point. The condition that a given surface may have a double point is obtained by eliminating the vari-

ables between the four equations $U_1 = 0$, &c., and the function equated to zero is called the discriminant of the given surface (*Lessons on Higher Algebra*, Art. 105). The discriminant being the result of elimination between four equations, each of the degree $n-1$, contains the coefficients of each in the degree $(n-1)^3$, and is therefore of the degree $4(n-1)^3$ in the coefficients of the original equation.

It is obvious from what has been said, that when a surface has a double point, the first polar of every point passes through the double point.

The surfaces represented by U_1 , U_2 , &c. may happen not merely to have points in common, but to have a whole curve common to all four surfaces. This curve will then be a double curve on the surface U , and every point of it will be a double point, such that the tangent cone resolves itself into a pair of planes. Now we saw (Art. 264) that the surface represented by the general Cartesian equation of the n^{th} degree will, in general, have an infinity of double tangent planes; the reciprocal surface therefore will, in general, have an infinity of double points, which will be ranged on a certain curve. The existence then of these double curves is to be regarded among the "ordinary singularities" of surfaces.

When the point $x'y'z'w'$ is a double point, U' and $\Delta U'$ vanish identically; and any line through the double point meets the surface in three consecutive points if it satisfies the equation $\Delta^2 U' = 0$, which represents a cone of the second degree.

284. *The polar quadric of a parabolic point on a surface is a cone.*

The polar quadric of the origin with regard to any surface

$$u_0 w^n + u_1 w^{n-1} + u_2 w^{n-2} + \&c. = 0,$$

(where, as in Art. 272, we have introduced w so as to make the equation homogeneous) is found by differentiating $n-2$ times with respect to w . Dividing out by $(n-2)(n-3)\dots 3$, and making $w=1$, the polar quadric is

$$n(n-1)u_0 + 2(n-1)u_1 + 2u_2 = 0.$$

Now the origin being a parabolic point, we have seen, Art. 266, that the equation is of the form

$$z + Cy^2 + 2Dzx + 2Ezy + Fz^2 + \&c.,$$

or, in other words, $u_0 = 0$, and u_2 is of the form $u_1v_1 + w_1^2$. The polar quadric then is

$$z(n - 1 + 2Dx + 2Ey + Fz) + Cy^2 = 0.$$

But any equation represents a cone when it is a homogeneous function of three quantities, each of the first degree. The equation just written therefore represents a cone whose vertex is the intersection of the three planes, z , $n - 1 + 2Dx + 2Ey + Fz$, and y . The two former planes are tangent planes to this cone, and y the plane of contact.

285. It follows from the last article, that *the locus of points whose polar quadrics are cones meets the given surface in its parabolic points*. This locus is found by writing down the discriminant of $\Delta^2 U' = 0$. If a , b , &c., denote the second differential coefficients $\frac{d^2 U'}{dx'^2}$, $\frac{d^2 U'}{dy'^2}$, &c., this discriminant will be a determinant formed with these coefficients, the developed result being (Art. 67)

$$abcd + 2afmn + 2bgnl + 2chlm + 2dfgh - bcl^2 - cam^2 - abn^2 - adf^2 \\ - bdg^2 - cdh^2 + l^2f^2 + m^2g^2 + n^2h^2 - 2mng h - 2nlhf - 2lmfg = 0.$$

This denotes a surface of the degree $4(n - 2)$, which we shall call the Hessian of the given surface. In the same manner then, as the intersection of a plane curve with its Hessian determines the points of inflexion, so the intersection of a surface with its Hessian determines a curve of the degree $4n(n - 2)$, which is the locus of parabolic points (see Art. 269).

286. It follows from what has been just proved that *through a given point can be drawn $4n(n - 1)(n - 2)$ stationary tangent planes* (see Art. 269). For since the tangent plane passes through a fixed point, its point of contact lies on the polar surface, whose degree is $n - 1$; and the intersection of this surface with the surface U , and the surface determined in the

last article as the locus of points of contact of stationary tangent planes, determine $4n(n-1)(n-2)$ points.

Otherwise thus: the stationary tangent planes to the surface through any point are also stationary tangent planes to the tangent cone through that point, and if the cone be cut by any plane, these planes meet it in the tangents at the points of inflexion of the section. But the number of points of inflexion on a plane curve is determined by the formula (*Higher Plane Curves*, Art. 82)

$$\iota - \kappa = 3(\nu - \mu).$$

But in this case, Art. 282, we have $\nu = n(n-1)^2$, $\mu = n(n-1)$; therefore $\nu - \mu = n(n-1)(n-2)$, $\kappa = n(n-1)(n-2)$. Hence, as before, $\iota = 4n(n-1)(n-2)$.

The number of double tangent planes to the cone is determined by the formula

$$2(\tau - \delta) = (\nu - \mu)(\nu + \mu - 9),$$

where (Art. 282)

$$2\delta = n(n-1)(n-2)(n-3); \quad (\nu + \mu - 9) = n^3 - n^2 - 9.$$

Hence $2\tau = n(n-1)(n-2)(n^3 - n^2 + n - 12)$.

It follows then, that through any point can be drawn τ double tangent planes to the surface, where τ is the number just determined. It will be proved hereafter, that the points of contact of double tangent planes lie on the intersection of the surface with one whose degree is $(n-2)(n^3 - n^2 + n - 12)$.

287. *If a right line lie altogether in a surface it will touch the Hessian and therefore the parabolic curve (Cambridge and Dublin Mathematical Journal, vol. IV., p. 255).*

Let the equation of the surface be $x\phi + y\psi = 0$, and let us seek the result of making x and $y = 0$ in the equation of the Hessian, so as thus to find the points where the line meets that surface. Now, evidently, $\frac{d^2 U}{dz^2}$, $\frac{d^2 U}{dw^2}$, $\frac{d^2 U}{dzdw}$, all contain x or y as a factor, and therefore vanish on this supposition. And if we make $c = 0$, $d = 0$, $n = 0$ in the equation of the Hessian, it becomes a perfect square $(fl - gm)^2$, shewing that the right line touches the Hessian at every point where it meets it. If we make $x = 0$, $y = 0$ in $fl - gm$, it reduces to

$\frac{d\phi}{dz} \frac{d\psi}{dw} - \frac{d\phi}{dw} \frac{d\psi}{dz}$. It is evident that when the tangent plane touches all along any line, straight or curved, this line lies altogether in the Hessian, and not only so, but in the case of a straight line, it can be shewn that the surface and the Hessian touch along this line.* The reader can verify this without difficulty, with regard to the surface $x\phi + y^2\psi$.

CURVATURE OF SURFACES.

288. We proceed next to investigate the curvature at any point on a surface of the various sections which can be made by planes passing through that point.

In the first place let it be premised that if the equation of a curve be $u_1 + u_2 + u_3 + \&c. = 0$, the radius of curvature at the origin is the same as for the conic $u_1 + u_2$. For it will be remembered that the ordinary expression for the radius of curvature includes only the coordinates of the point and the values of the first and second differential coefficients for that point. But if we differentiate the equation not more than twice, the terms got from differentiating $u_3, u_4, \&c.$ contain powers of x and y , and will therefore vanish for $x=0, y=0$. The values therefore of the differential coefficients for the origin are the same as if they were obtained from the equation $u_1 + u_2 = 0$.

It follows hence that the radius of curvature at the origin (the axes being rectangular) of $y + ax^2 + 2bxy + cy^2 + \&c. = 0$ is $\frac{1}{2a}$ (see *Conics*, Art. 241); or this value can easily be found directly from the ordinary expression for the radius of curvature (*Higher Plane Curves*, Art. 100).

289. Let now the equation of a surface referred to any tangent plane as plane of xy , and the corresponding normal as axis of z , be

$$z + Ax^2 + 2Bxy + Cy^2 + 2Dxz + 2Eyz + Fz^2 + \&c. = 0,$$

and let us investigate the curvature of any normal section, that

* Cayley, "On Reciprocal Surfaces," *Phil. Trans.*, vol. 159, 1869, see p. 208.

is, of the section by any plane passing through the axis of z . Thus, to find the radius of curvature of the section by the plane xz , we have only to make $y = 0$ in the equation, and we get a curve whose radius of curvature is half the reciprocal of A . In like manner the section by the plane yz has its radius of curvature = half the reciprocal of C . And in order to find the radius of curvature of any section whose plane makes an angle θ with the plane xz , we have only to turn the axes of x and y through an angle θ (by substituting $x \cos \theta - y \sin \theta$ for x , and $x \sin \theta + y \cos \theta$ for y , *Conics*, Art. 9); and by then putting $y = 0$ it appears, as before, that the radius of curvature is half the reciprocal of the new coefficient of x^2 ; that is to say,

$$\frac{1}{2R} = A \cos^2 \theta + 2B \cos \theta \sin \theta + C \sin^2 \theta.$$

290. The reader will not fail to observe that this expression for the radius of curvature of a normal section is identical in form with the expression for the square of the diameter of a central conic in terms of the angles which it makes with the axes of coordinates. Thus if ρ be the semi-diameter answering to an angle θ of the conic $Ax^2 + 2Bxy + Cy^2 = \frac{1}{2}$, we have $R = \rho^2$.

It may be seen, otherwise, that the radii of curvature are connected with their directions in the same manner as the squares of the diameters of a central conic. For we have seen that the radii of curvature depend only on the terms in u_1 and u_2 . The radii of curvature therefore of all the sections of $u_1 + u_2 + u_3 + \&c.$ are the same as those of the sections of the quadric $u_1 + u_2$; and it was proved (Art. 194) that these are all proportional to the squares of the diameters of the central section parallel to the tangent plane.

It is plain that the conic, the squares of whose radii are proportional to the radii of curvature, is similar to the indicatrix.

291. We can now at once apply to the theory of these radii of curvature all the results that we have obtained for the diameters of central conics. Thus we know that the quantity $A \cos^2 \theta + 2B \cos \theta \sin \theta + C \sin^2 \theta$ admits of a maximum and minimum value; that the values of θ which corre-

spond to the maximum and minimum are always real, and belong to directions at right angles to each other; and that those values of θ are given by the equation (see *Conics*, Art. 155)

$$B \cos^2 \theta - (A - C) \cos \theta \sin \theta - B \sin^2 \theta = 0.$$

Hence, at any point on a surface there are among the normal sections, one for which the value of the radius of curvature is a maximum and one for which it is a minimum; the directions of these sections are at right angles to each other; and they are the directions of the axes of the indicatrix. They plainly bisect the angles between the two inflexional tangents. We shall call these the *principal sections*, and the corresponding radii of curvature the *principal radii*.

If we turn round the axes of x and y so as to coincide with the directions of maximum and minimum curvature just determined, it is known that the quantity $Ax^2 + 2Bxy + Cy^2$ will take the form $A'x^2 + B'y^2$. Now the formula of Art. 289, when the coefficient of xy vanishes, gives the following expression for the half reciprocal of any radius of curvature

$$\frac{1}{2R} = A' \cos^2 \theta + B' \sin^2 \theta. \quad \text{But evidently } A' \text{ and } B' \text{ are the}$$

values of this half reciprocal corresponding to $\theta = 0$, and $\theta = 90^\circ$. Hence any radius of curvature is expressed in terms of the two principal radii ρ and ρ' , and of the angle which the direction of its plane makes with the principal planes, by the formula

$$\frac{1}{R} = \frac{\cos^2 \theta}{\rho} + \frac{\sin^2 \theta}{\rho'}.*$$

It is plain (as in *Conics*, Art. 157) that A' and B' , or $\frac{1}{2\rho}$, $\frac{1}{2\rho'}$ are given by a quadratic equation, the sum of these quantities being $A + C$ and their product $AC - B^2$.

When $\rho = \rho'$, all the other radii of curvature are also $= \rho$. The form of the equation then is $z + A(x^2 + y^2) + \&c. = 0$, or the indicatrix is a circle. The origin is then an *umbilic*.

From the expressions in this article we deduce at once, as in the theory of central conics, that the *sum of the reciprocals of the radii of curvature of two normal sections at right angles*

* This formula (with the inferences drawn from it) is due to Euler.

to each other is constant; and again, if normal sections be made through a pair of conjugate tangents (see Art. 268) the sum of their radii of curvature is constant.

292. It will be observed that the radius of curvature, being proportional to the square of the diameter of a central conic, does not become imaginary, but only changes sign, if the quantity $A \cos^2 \theta + 2B \cos \theta \sin \theta + C \sin^2 \theta$ becomes negative. Now if radii of curvature directed on one side of the tangent plane are considered as positive, those turned the other way must be considered as negative; and the sign changes when the direction is changed in which the concavity of the curve is turned.

At an elliptic point on a surface; that is to say, when B^2 is less than AC , the sign of $A \cos^2 \theta + 2B \cos \theta \sin \theta + C \sin^2 \theta$ remains the same for all values of θ ; and therefore at such a point the concavity of every section through it is turned in the same direction.

At a hyperbolic point, that is to say, when B^2 is greater than AC , the radius of curvature twice changes sign, and the concavity of some sections is turned in an opposite direction to that of others. The surface, in fact, cuts the tangent plane in the neighbourhood of the point, and the inflexional tangents mark the directions in which the surface crosses the tangent plane and divide the sections whose concavity is turned one way from those in which it is turned the other way.* And when we have chosen a hyperbola, the squares of whose diameters are proportional to one set of radii, then the other set of radii are proportional to the squares of the diameters of the conjugate hyperbola.

293. Having shewn how to find the radius of curvature of any normal section, we shall next shew how to express, in terms of this, the radius of curvature of any oblique section, inclined at an angle ϕ to the normal section, but meeting the

* The illustration of the summit of a mountain pass, or of a saddle, will enable the reader to conceive how a surface may in two directions sink below the tangent plane, and on the other sides rise above it; a mountain summit is an instance of an elliptic point.

tangent plane in the same line. Thus we have seen that the radius of curvature of the normal section made by the plane $y=0$ is half the reciprocal of A . Now let us turn the axes of y and z round in their plane through an angle ϕ (which is done by substituting $z \cos \phi - y \sin \phi$ for z , and $z \sin \phi + y \cos \phi$ for y). If we now make the new $y=0$, we shall get the equation (still to rectangular axes) of the section by a plane making an angle ϕ with the old plane $y=0$, but still passing through the old axis of x ; and this equation will plainly be

$$0 = z \cos \phi + Ax^2 + 2(B \sin \phi + D \cos \phi)xz \\ + (C \sin^2 \phi + 2E \sin \phi \cos \phi + F \cos^2 \phi)z^2 + \&c.$$

and by the same method as before the radius of curvature is found to be $\frac{\cos \phi}{2A}$, or is $= R \cos \phi$, where R is the radius of curvature of the corresponding normal section. This is MEUNIER'S THEOREM, that *the radius of curvature of an oblique section is equal to the projection on the plane of this section of the radius of curvature of a normal section passing through the same tangent line*. Thus we see that of all sections which can be made through any line drawn in the tangent plane, the normal section is that whose radius of curvature is greatest; that is to say, the normal section is that which is least curved and which approaches most nearly to a straight line.

Meunier's theorem has been already proved in the case of a quadric (Art. 194), and we might therefore, if we had chosen, have dispensed with giving a new proof now; for we have seen that the radius of curvature of any section of $u_1 + u_2 + u_3 + \&c.$ is the same as that of the corresponding section of the quadric $u_1 + u_2$.

294. It was proved (Art. 203) that if two surfaces $u_1 + u_2 + \&c.$, $u_1 + v_2 + \&c.$ touch, their curve of intersection has a double point, the two tangents at which are the intersections of the plane u_1 with the cone $u_2 - v_2$. When the plane touches the cone, the surfaces have what we have called stationary contact. It is also proved, as at Art. 205, that a sphere has stationary contact with a surface when the centre is on the normal and the radius

equal to one of the principal radii of curvature. In fact, the condition for stationary contact between

$$z + ax^2 + 2hxy + by^2 + \&c., \quad z + a'x^2 + 2h'xy + b'y^2 + \&c.$$

is $(a - a')(b - b') = (h - h')^2,$

which, when h and h' both vanish, implies either $a = a'$ or $b = b'$. The surface therefore $z + Ax^2 + By^2 + \&c.$ will have stationary contact with the sphere $2rz + x^2 + y^2 + z^2$ if $r = \frac{1}{2A}$ or $\frac{1}{2B}$; but these are the values of the principal radii.

295. The principles laid down in the last article enable us to find an expression for the values of the principal radii at any point; the axes of coordinates having any position.

If we transform the equation to any point $x'y'z'$ on the surface as origin, it becomes

$$x \frac{dU'}{dx'} + y \frac{dU'}{dy'} + z \frac{dU'}{dz'} + \frac{1}{1.2} \left(x \frac{d}{dx'} + y \frac{d}{dy'} + z \frac{d}{dz'} \right)^2 U' + \&c.,$$

or, denoting the first differential coefficients by $L, M, N,$ and the second by $a, b, c, \&c.,$

$$2(Lx + My + Nz) + ax^2 + by^2 + cz^2 + 2fyz + 2gzx + 2hxy + \&c. = 0.$$

The equation then of any sphere having the same tangent plane is, assuming the axes to be rectangular,

$$2(Lx + My + Nz) + \lambda(x^2 + y^2 + z^2) = 0,$$

and this sphere will have stationary contact with the quadric if λ be determined so as to satisfy the condition that $Lx + My + Nz$ shall touch the cone

$$(a - \lambda)x^2 + (b - \lambda)y^2 + (c - \lambda)z^2 + 2fyz + 2gzx + 2hxy = 0.$$

This condition is

$$\begin{vmatrix} a - \lambda, & h, & g, & L \\ h, & b - \lambda, & f, & M \\ g, & f, & c - \lambda, & N \\ L, & M, & N, & \end{vmatrix} = 0,$$

which expanded is

$$\{(b - \lambda)(c - \lambda) - f^2\}L^2 + \{(c - \lambda)(a - \lambda) - g^2\}M^2 + \{(a - \lambda)(b - \lambda) - h^2\}N^2 + 2\{gh - (a - \lambda)f\}MN + 2\{hf - (b - \lambda)g\}NL + 2\{fg - (c - \lambda)h\}LM = 0,$$

or λ is given by the quadratic

$$\begin{aligned} (L^2 + M^2 + N^2) \lambda^2 - \{ (b+c)L^2 + (c+a)M^2 + (a+b)N^2 \\ - 2fMN - 2gNL - 2hLM \} \lambda \\ + (bc - f^2)L^2 + (ca - g^2)M^2 + (ab - h^2)N^2 \\ + 2(gh - af)MN + 2(hf - bg)NL + 2(fg - ch)LM = 0. \end{aligned}$$

Now if r be the radius of the sphere

$$\lambda(x^2 + y^2 + z^2) + 2(Lx + My + Nz) = 0,$$

we have $r^2 = \frac{L^2 + M^2 + N^2}{\lambda^2}$. We therefore find the principal radii by substituting $\frac{\sqrt{(L^2 + M^2 + N^2)}}{r}$ for λ in the preceding quadratic.

The absolute term in the equation for λ may be simplified by writing for L, M, N their values from the equations

$$(n-1)L = ax + hy + gz + lw, \text{ \&c.},$$

when the absolute term reduces to $-\frac{Hw^2}{(n-1)^2}$ where H is the

Hessian, written at full length, Art. 285. We might have seen *a priori* that, for any point on the Hessian, the absolute term must vanish. For since the directions of the principal sections bisect the angles between the inflexional tangents; when the inflexional tangents coincide, one of the principal sections coincides with their common direction, and the radius of curvature of this section is infinite, since three consecutive points are on a right line. Hence one of the values of λ (which is the reciprocal of r) must vanish. By equating to zero the coefficient of λ in the preceding quadratic, we obtain the equation of a surface of the degree $3n-4$, which intersects the given surface in all the points where the principal radii are equal and opposite: that is to say, where the indicatrix is an equilateral hyperbola.

The quadratic of this article might also have been found at once by Art 102, which gives the axes of a section of the quadric

$$ax^2 + by^2 + cz^2 + 2fyz + 2gzx + 2hxy = 1$$

made parallel to the plane $Lx + My + Nz = 0$.

296. From the equations of the last article we can find the *radius of curvature of any normal section meeting the tangent plane in a line whose direction-angles are given.*

For the centre of curvature lies on the normal, and if we describe a sphere with this centre, and radius equal to the radius of curvature, it must touch the surface, and its equation is of the form

$$2(Lx + My + Nz) + \lambda(x^2 + y^2 + z^2) = 0.$$

The consecutive point on that section of the surface which we are considering satisfies this equation, and also the equation $u_1 + u_2 = 0$, that is

$$2(Lx + My + Nz) + ax^2 + by^2 + cz^2 + 2fyz + 2gzx + 2hxy = 0.$$

Subtracting, we find

$$\lambda = \frac{ax^2 + by^2 + cz^2 + 2fyz + 2gzx + 2hxy}{x^2 + y^2 + z^2}.$$

And since this equation is homogeneous, we may write for x, y, z the direction-cosines of the line joining the consecutive point to the origin. As in the last article $\lambda = \frac{\sqrt{(L^2 + M^2 + N^2)}}{r}$.

Hence

$$r = \frac{\sqrt{(L^2 + M^2 + N^2)}}{a \cos^2 \alpha + b \cos^2 \beta + c \cos^2 \gamma + 2f \cos \beta \cos \gamma + 2g \cos \gamma \cos \alpha + 2h \cos \alpha \cos \beta}.$$

The problem to find the maximum and minimum radius of curvature is, therefore, to make the quantity

$$ax^2 + by^2 + cz^2 + 2fyz + 2gzx + 2hxy$$

a maximum or minimum, subject to the relations

$$Lx + My + Nz = 0, \quad x^2 + y^2 + z^2 = 1.$$

And thus we see, again, that this is exactly the same problem as that of finding the axes of the central section of a quadric by a plane $Lx + My + Nz$.

297. In like manner the problem to find the *directions of the principal sections at any point* is the same as to find the directions of the axes of the section by the plane $Lx + My + Nz$ of the quadric $ax^2 + by^2 + cz^2 + 2fyz + 2gzx + 2hxy = 1$.

Now given any diameter of a quadric, one section can be drawn through it having that diameter for an axis; the other axis being obviously the intersection of the plane perpendicular to the given diameter with the plane conjugate to it. Thus, if the central quadric be $U=1$, and the given diameter pass through $x'y'z'$, the diameter perpendicular and conjugate is the intersection of the planes

$$xx' + yy' + zz' = 0, \quad x'U_1 + y'U_2 + z'U_3 = 0.$$

If the former diameter lie in a plane $Lx' + My' + Nz'$, the latter diameter traces out the cone which is represented by the determinant obtained on eliminating $x'y'z'$ from the three preceding equations: viz.

$$(Mz - Ny) U_1 + (Nx - Lz) U_2 + (Ly - Mx) U_3 = 0.$$

And this cone must evidently meet the plane $Lx + My + Nz$ in the axes of the section by that plane. Thus, then, the directions of the principal sections are determined as the intersection of the tangent plane $Lx + My + Nz$ with the cone

$$(Mz - Ny)(ax + hy + gz) + (Nx - Lz)(hx + by + fz) \\ + (Ly - Mx)(gx + fy + cz) = 0,$$

$$\text{or } (Mg - Nh)x^2 + (Nh - Lf)y^2 + (Lf - Mg)z^2 \\ + \{L(b - c) - Mh + Ng\}yz + \{Lh + M(c - a) - Nf\}zx \\ + \{-Lg + Mf + N(a - b)\}xy = 0.$$

298. The methods used in Art. 295 enable us also easily to find the conditions for an umbilic.* If the plane of xy be

* It might be imagined that we could obtain a single condition for an umbilic by expressing that the quadratic (Art. 295) for the determination of the principal radii of curvature shall have equal roots. But, as at Art. 83, this quadratic, having its roots always real, is one of the class discussed *Higher Algebra*, Art. 44, the discriminant of which can be expressed as a sum of squares. If we make these squares separately vanish, we obtain two conditions, which are more easily found as in the text.

In plane geometry, the problem of finding when $ax^2 + 2hxy + by^2 = 1$ represents a circle may be solved by taking the quadratic which gives the maximum or minimum values of $x^2 + y^2 = \rho$, viz. $(a\rho - 1)(b\rho - 1) - h^2\rho^2 = 0$, and forming the condition that the quadratic shall have equal roots, viz. $(a - b)^2 + 4h^2 = 0$. Now this single condition is not the condition that the curve shall be a circle, for either of the factors $a - b \pm 2hi$ separately equated to zero only expresses that the curve passes through one of the circular points at infinity. But if we have both factors simultaneously = 0, that is to say, if we have $a - b = 0$, $h = 0$, the curve passes through both circular points and is a circle. And the theory in regard to the umbilics is

the tangent plane at an umbilic, the equation of the surface is of the form

$$z + A(x^2 + y^2) + 2Dxz + 2Eyz + Fz^2 + \&c. = 0;$$

and if we subtract from it the equation of any touching sphere, viz.

$$z + \lambda(x^2 + y^2 + z^2) = 0,$$

it is evidently possible so to choose λ (namely, by taking it = A) that all the terms in the remainder shall be divisible by z . We see, thus, that if $u_1 + u_2 + \&c.$ represent the surface, and $u_1 + \lambda v_2$ any touching sphere, it is possible, when the origin is an umbilic, so to choose λ that $u_2 - \lambda v_2$ may contain u_1 as a factor. We see, then, by transformation of coordinates as in Art. 295, that any point $x'y'z'$ will be an umbilic if it is possible so to choose λ that

$$(a - \lambda)x^2 + (b - \lambda)y^2 + (c - \lambda)z^2 + 2fyz + 2gzx + 2hxy$$

may contain as a factor $Lx + My + Nz$. If so, the other factor must be

$$\frac{a - \lambda}{L}x + \frac{b - \lambda}{M}y + \frac{c - \lambda}{N}z.$$

Multiplying out and comparing the coefficients of yz , zx , xy , we get the conditions

$$(b - \lambda)\frac{N}{M} + (c - \lambda)\frac{M}{N} = 2f, \quad (c - \lambda)\frac{L}{N} + (a - \lambda)\frac{N}{L} = 2g,$$

$$(a - \lambda)\frac{M}{L} + (b - \lambda)\frac{L}{M} = 2h.$$

Eliminating λ between these equations, we obtain for an umbilic the two conditions

$$\frac{bN^2 + cM^2 - 2fMN}{N^2 + M^2} = \frac{cL^2 + aN^2 - 2gLN}{L^2 + N^2} = \frac{aM^2 + bL^2 - 2hLM}{M^2 + L^2}.$$

almost identical: the points on the surface for which the two radii of curvature are equal are points such that for each of them *one* of the inflexional tangents meets the imaginary circle at infinity; an umbilic is a point such that *both* the inflexional tangents meet the circle at infinity. The first-mentioned points form on the surface an imaginary locus having the umbilics for double points.

Since there are only two conditions to be satisfied, a surface of the n^{th} degree has in general a determinate number of umbilics; for the two conditions, each of which represents a surface, combined with the equation of the given surface, determine a certain number of points. It may happen, however, that the surfaces represented by the two conditions intersect in a curve which lies (either wholly or in part) on the given surface. In such a case there will be on the given surface a line, every point of which will be an umbilic. Such a line is called *a line of spherical curvature*.

299. Before applying the conditions of the last article, the form in which we have written them requires that the following considerations should be attended to.

These equations appear to be satisfied by making $L=0$,
$$\alpha = \frac{bN^2 + cM^2 - 2fMN}{N^2 + M^2};$$
 whence we might conclude that the surface $L=0$ must always pass through umbilics on the given surface. Now it is easy to see geometrically that this is not the case, for L (or U_1) is the polar of the point yzw with respect to the surface, so that if L necessarily passed through umbilics it would follow by transformation of coordinates that the first polar of *every* point passes through umbilics. On referring to the last article, however, it will be seen that the investigation tacitly assumes that none of the quantities L , M , N vanish; for if any of them did vanish, some of the equations which we have used would contain infinite terms. Supposing then L to vanish, we must examine directly the condition that $My + Nz$ may be a factor in

$$(a - \lambda)x^2 + (b - \lambda)y^2 + (c - \lambda)z^2 + 2fyz + 2gzx + 2hxy.$$

We must evidently have $\lambda = a$, and it is then easily seen that we must, as before, have
$$\alpha = \frac{bN^2 + cM^2 - 2fMN}{N^2 + M^2},$$
 while in addition, since the terms $2gzx + 2hxy$ must be divisible by $My + Nz$, we must have $Mg = Nh$. Combining then with the two conditions here found, $L=0$, and the equation of the surface, there are four conditions which, except in special cases, cannot be satisfied by the coordinates of any points.

If we clear of fractions the conditions given in the last article, it will be found that they each contain either L , M , or N as a factor. And what we have proved in this article is that these factors may be suppressed as irrelevant to the question of umbilics.

Again, it can be shown that, introducing homogeneous coordinates as in Art. 295, the numerators of the above fractions multiplied by $(n - 1)^2$, are respectively

$$n(n - 1)(bc - f^2) U - (Dx^2 + Aw^2 - 2Lxw),$$

$$n(n - 1)(ca - g^2) U - (Dy^2 + Bw^2 - 2Myw),$$

$$n(n - 1)(ab - h^2) U - (Dz^2 + Cw^2 - 2Nzw),$$

where A, B, C, D, L, M, N are the functions of a, b, c , &c. defined in Art. 67. Hence our equations are satisfied for $U = 0$ by $w = 0, D = 0$, but these are the points of inflexion of the intersection of U with the plane at infinity, which are also irrelevant to the question of umbilics.*

We now proceed to draw some other inferences from what was proved (Art. 294); namely, that the two principal spheres have stationary contact with the surface.

300. *When two surfaces have stationary contact, they touch in two consecutive points.*

* From what has been said we can infer the number of umbilics which a surface of the n^{th} degree will in general possess. We have seen that the umbilics are determined as the intersection of the given surface with a curve whose equations are of the form $\frac{A}{A'} = \frac{B}{B'} = \frac{C}{C'}$. Now if A, B, C be of the degree l , and A', B', C' of the degree m , then $AB' - BA', AC' - CA'$ are each of the degree $l + m$, and intersect in a curve of the degree $(l + m)^2$. But the intersection of these two surfaces includes the curve AA' of the degree lm which does not lie on the surface $BC' - CB'$. The degree therefore of the curve common to the three surfaces is $l^2 + lm + m^2$. In the present case $l = 3n - 4, m = 2n - 2$, and the degree of the curve would seem to be $19n^2 - 46n + 28$. But we have seen that the system we are discussing includes three curves such as

$$L, a(M^2 + N^2) - (bN^2 + cM^2 - 2fMN)$$

which do not pass through umbilics. Subtracting therefore from the number just found $3(n - 1)(3n - 4)$, we see that the umbilics are determined as the intersection of the given surface with a curve of the degree $(10n^2 - 25n + 16)$, but from the number of points thus found we must subtract $3n(n - 2)$ for the inflexions on the intersection of the given surface with the plane at infinity. Thus the number of umbilics is $n(10n^2 - 28n + 22)$. (*Voss, Math. Annalen IX. 1876*). In particular, when $n = 2$, then the number is twelve, viz. there are four umbilics in each of the principal planes.

The equations of the two surfaces being

$$z + ax^2 + 2hxy + by^2 + \&c. = 0, \quad z + a'x^2 + 2h'xy + b'y^2 + \&c.,$$

the tangent planes at a consecutive point are (Art. 262)

$$z + 2(ax' + hy')x + 2(hx' + by')y = 0,$$

$$z + 2(a'x' + h'y')x + 2(h'x' + b'y')y = 0.$$

That these may be identical, we must have

$$ax' + hy' = a'x' + h'y', \quad hx' + by' = h'x' + b'y',$$

and eliminating $x' : y'$ between these equations, we have

$$(a - a')(b - b') = (h - h')^2,$$

which is the condition for stationary contact.

The sphere, therefore, whose radius is equal to one of the principal radii, touches the surface in two consecutive points; or two consecutive normals to the surface are also normals to the sphere, and consequently intersect in its centre. Now we know that in plane curves the centre of the circle of curvature may be regarded as the intersection of two consecutive normals to the curve. In surfaces the normal at any point will not meet the normal at a consecutive point taken arbitrarily. But we see here that if the consecutive point be taken in the direction of either of the principal sections, the two consecutive normals will intersect, and their common length will be the corresponding principal radius. On account of the importance of this theorem we give a direct investigation of it.

301. *To find in what cases the normal at any point on a surface is intersected by a consecutive normal.* Take the tangent plane for the plane of xy , and let the equation of the surface be

$$z + Ax^2 + 2Bxy + Cy^2 + 2Dxz + 2Eyz + Fz^2 + \&c. = 0.$$

Then we have seen (Art. 268) that the equation of a consecutive tangent plane is

$$z + 2(Ax' + By')x + 2(Bx' + Cy')y = 0,$$

and a perpendicular to this through the point $x'y'$ will be

$$\frac{x - x'}{Ax' + By'} = \frac{y - y'}{Bx' + Cy'} = 2z.$$

This will meet the axis of z (which was the original normal) if

$$\frac{x'}{Ax' + By'} = \frac{y'}{Bx' + Cy'}$$

The direction therefore of a consecutive point whose normal meets the given normal is determined by the equation

$$Bx'^2 + (C - A)x'y' - By'^2 = 0.$$

But this is the same equation (Art. 291) which determines the directions of maximum and minimum curvature. At any point on a surface therefore there are two directions, at right angles to each other, such that the normal at a consecutive point taken on either intersects the original normal. And these directions are those of the two principal sections at the point. Taking for greater simplicity the directions of the principal sections as axes of coordinates; that is to say, making $B = 0$ in the preceding equations, the equations of a consecutive normal become $\frac{x - x'}{Ax'} = \frac{y - y'}{Cy'} = 2z$, whence it is easy to see that the normals corresponding to the points $y' = 0, x' = 0$ intersect the axis of z at distances determined respectively by $2Az + 1 = 0, 2Cz + 1 = 0$. The intercepts therefore on a normal by the two consecutive ones which intersect it are equal to the principal radii.*

We may also arrive at the same conclusions by seeking the locus of points on a surface, the normals at which meet a fixed normal which we take for axis of z . Making $x = 0, y = 0$ in the equation of any other normal, we see that the

* M. Bertrand, in his theory of the curvature of surfaces, calculates the angle made by the consecutive normal with the plane containing the original normal and the consecutive point $x'y'$. Supposing still the directions of the principal sections to be axes of coordinates, the direction-cosines of the consecutive normal are proportional to $2Ax', 2Cy'$, while those of a tangent line perpendicular to the radius vector are proportional to $-y', x', 0$. Hence the cosine of the angle between these two lines, or the sine of the angle which the consecutive normal makes with the normal section, is proportional to $2(C - A)x'y'$; or, if α be the angle which the direction of the consecutive point makes with one of the principal tangents, is proportional to $(C - A)\sin 2\alpha$. When $\alpha = 0, \text{ or } = 90^\circ$, this angle vanishes, and the consecutive normal is in the plane of the original normal.

point where it meets the surface must satisfy the condition $U_2x = U_1y$. The curve where this surface meets the given surface has the extremity of the given normal for a double point, the two tangents at which are the two principal tangents to the surface at that point. (See Ex. 9, p. 101).

The special case where the fixed normal is one at an umbilic deserves notice. The equation of the surface being of the form $z + A(x^2 + y^2) + \&c. = 0$, the lowest terms in the equation $xU_2 = yU_1$, when we make $z = 0$, will be of the third degree, and the umbilic is a triple point on the curve locus. Thus while every normal immediately consecutive to the normal at the umbilic meets the latter normal, there are three directions along any of which the next following normal will also meet the normal at the umbilic.*

302. A *line of curvature*† on a surface is a line traced on it, such that the normals at any two consecutive points of it intersect. Thus, starting with any point M on a surface, we may go on to either of the two consecutive points N, N' , whose normals were proved to intersect the normal at M . The normal at N , again, is intersected by the consecutive normals at two points, P, P' , the element NP being a continuation of the element MN while the element NP' is approximately perpendicular to it. In like manner we might pass from the point P to another consecutive point Q , and so have a line of curvature $MNPQ$. But we might evidently have pursued the same

* Sir W. R. Hamilton has pointed out (*Elements of Quaternions*, Art. 411) how this is verified in the case of a quadric. He has proved that the two imaginary generators (see Art. 139) through any umbilic are lines of curvature, the third line of curvature through the umbilic being the principal section in which it lies. In fact, for a point on a principal section, the cone (Ex. 9, p. 101) breaks up into two planes. The normal therefore at such a point only meets the normals at the points of the principal section, and at the points of another plane section. For the umbilic the latter plane is a tangent plane and the section reduces to the imaginary generators. The normals along either lie in the same imaginary plane. At every point on either generator, distinct from the umbilic, the two directions of curvature coincide with the line, which is perpendicular to itself (*Conics*, p. 351). There is, however, some speciality as regards the theory of the umbilics of a quadric.

† The whole theory of lines of curvature, umbilics, &c. is due to Monge. See his "Application de l'Analyse à la Géométrie," p. 124, Liouville's edition.

process had we started in the direction MN' . Hence, at any point M on a surface can be drawn two lines of curvature; these cut at right angles and are touched by the two "principal tangents" at M . A line of curvature will ordinarily not be a plane curve, and even in the special case where it is plane it need not coincide with a principal normal section at M , though it must touch such a section. For the principal section must be normal to the surface, and the line of curvature may be oblique.

A very good illustration of lines of curvature is afforded by the case of the surfaces generated by the revolution of any plane curve round an axis in its plane. At any point P of such a surface one line of curvature is the plane section passing through P and through the axis, or, in other words, is the generating curve which passes through P . For, all the normals to this curve are also normals to the surface, and, being in one plane, they intersect. The corresponding principal radius at P is evidently the radius of curvature of the plane section at the same point. The other line of curvature at P is the circle which is the section made by a plane drawn through P perpendicular to the axis of the surface; for the normals at all the points of this section evidently intersect the axis of the surface at the same point, and therefore intersect each other. The intercept on the normal between P and the axis is plainly the second principal radius of the surface.

The generating curve which passes through P is a principal section of the surface, since it contains the normal and touches a line of curvature; but the section perpendicular to the axis is, in general, not a principal section because it does not contain the normal at P . The second principal section at that point would be the plane section drawn through the normal at P and through the tangent to the circle described by P . The example chosen serves also to illustrate Meunier's theorem; for the radius of the circle described by P (which, as we have seen, is an oblique section of the surface) is the projection on that plane of the intercept on the normal between P and the axis, and we have just proved that this intercept is the radius of curvature of the corresponding normal section.

303. It was proved (Art. 297) that the direction-cosines of the tangent line to a principal section fulfil the relation

$$\begin{aligned} & (M \cos \gamma - N \cos \beta)(a \cos \alpha + h \cos \beta + g \cos \gamma) \\ & + (N \cos \alpha - L \cos \gamma)(h \cos \alpha + b \cos \beta + f \cos \gamma) \\ & + (L \cos \beta - M \cos \alpha)(g \cos \alpha + f \cos \beta + c \cos \gamma) = 0. \end{aligned}$$

Now the tangent line to a principal section is also the tangent to the line of curvature; while, if ds be the element of the arc of any curve, the projections of that element upon the three axes being dx, dy, dz , it is evident that the cosines of the angles which ds makes with the axes are $\frac{dx}{ds}, \frac{dy}{ds}, \frac{dz}{ds}$.

The differential equation of the lines of curvature is therefore got by writing dx, dy, dz for $\cos \alpha, \cos \beta, \cos \gamma$ in the preceding formula.

This equation may also be found directly as follows (see Gregory's *Solid Geometry*, p. 256): Let α, β, γ be the coordinates of a point common to two consecutive normals. Then, if xyz be the point where the first normal meets the surface, by the equations of the normal we have $\frac{\alpha - x}{L} = \frac{\beta - y}{M} = \frac{\gamma - z}{N}$; or, if we call the common value of these fractions θ , we have

$$\alpha = x + L\theta, \quad \beta = y + M\theta, \quad \gamma = z + N\theta.$$

But if the second normal meet the surface in a point $x + dx, y + dy, z + dz$, then, expressing that $\alpha\beta\gamma$ satisfies the equations of the second normal, we get the same results as if we differentiate the preceding equations, considering $\alpha\beta\gamma$ as constant, or $dx + Ld\theta + \theta dL = 0, dy + Md\theta + \theta dM = 0, dz + Nd\theta + \theta dN = 0$, from which equations eliminating $\theta, d\theta$, we have the same determinant as in Art. 297, viz.

$$\begin{vmatrix} dx, & dy, & dz \\ L, & M, & N \\ dL, & dM, & dN \end{vmatrix} = 0.$$

Of course

$$dL = adx + hdy + gdz, \quad dM = hdx + bdy + fdz, \quad dN = gdx + fdy + cdz.$$

Ex. To find the differential equation of the lines of curvature of the ellipsoid

$$\frac{x^2}{a^2} + \frac{y^2}{b^2} + \frac{z^2}{c^2} = 1.$$

Here we have

$$L = \frac{x}{a^2}, \quad M = \frac{y}{b^2}, \quad N = \frac{z}{c^2}, \quad dL = \frac{dx}{a^2}, \quad dM = \frac{dy}{b^2}, \quad dN = \frac{dz}{c^2}.$$

Substituting these values in the preceding equation it becomes, when expanded,

$$(b^2 - c^2) x \, dy \, dz + (c^2 - a^2) y \, dz \, dx + (a^2 - b^2) z \, dx \, dy = 0.$$

Knowing, as we do, that the lines of curvature are the intersections of the ellipsoid with a system of concentric quadrics (Art. 196), it would be easy to assume for the integral of this equation $Ax^2 + By^2 + Cz^2 = 0$, and to determine the constants by actual substitution. If we assume nothing as to the form of the integral we can eliminate z and dz by the help of the equation of the surface, and so get a differential equation in two variables which is the equation of the projection of the lines of curvature on the plane of xy . Thus, in the present case, multiplying by $\frac{z}{c^2}$ and reducing by the equation of the ellipsoid and its differential, we have

$$\{(b^2 - c^2) x \, dy + (c^2 - a^2) y \, dx\} \left\{ \frac{x \, dx}{a^2} + \frac{y \, dy}{b^2} \right\} = (a^2 - b^2) \left\{ 1 - \frac{x^2}{a^2} - \frac{y^2}{b^2} \right\} dx \, dy,$$

or writing

$$\frac{a^2 (b^2 - c^2)}{b^2 (a^2 - c^2)} = A, \quad \frac{a^2 (a^2 - b^2)}{a^2 - c^2} = B,$$

$$Axy \left(\frac{dy}{dx} \right)^2 + (x^2 - Ay^2 - B) \frac{dy}{dx} - xy = 0,$$

the integral of which (see Boole's *Differential Equations*, Ex. 3, p. 135) is, with C an arbitrary constant,

$$\frac{x^2}{B} - \frac{y^2}{BC} = \frac{1}{AC + 1},$$

or the lines of curvature are projected on the principal plane into a series of conics whose axes a' , b' are connected by the relation

$$\frac{a'^2 (a^2 - c^2)}{a^2 (a^2 - b^2)} + \frac{b'^2 (b^2 - c^2)}{b^2 (b^2 - a^2)} = 1.$$

It is not difficult to see that this coincides with the account given of the lines of curvature in Art. 196.

304. The theorem that confocal quadrics intersect in lines of curvature is a particular case of a theorem due to Dupin, which we shall state as follows: *If three surfaces intersect at right angles, and if each pair also intersect at right angles at their next consecutive common point, then the directions of the intersections are the directions of the lines of curvature on each.*

Take the point common to all three surfaces as origin, and the three rectangular tangent planes as coordinate planes; then the equations of the surfaces are of the form

$$x + ay^2 + 2byz + cz^2 + 2dzx + \&c. = 0,$$

$$y + a'z^2 + 2b'zx + c'x^2 + 2d'xy + \&c. = 0,$$

$$z + a''x^2 + 2b''xy + c''y^2 + \&c. = 0.$$

At a consecutive point common to the first and second surfaces, we must have $x = 0, y = 0, z = z'$, where z' is very small. The consecutive tangent planes are

$$\begin{aligned}(1 + 2dz')x + 2bz'y + 2cz'z &= 0, \\ 2b'z'x + (1 + 2d'z')y + 2a'z'z &= 0.\end{aligned}$$

Forming the condition that these should be at right angles and only attending to the terms where z' is of the first degree, we have $b + b' = 0$.

In like manner, in order that the other pairs of surfaces may cut at right angles at a consecutive point, we must have $b' + b'' = 0, b'' + b = 0$, and the three equations cannot be fulfilled unless we have b, b', b'' each separately $= 0$; in which case the form of the equations shows (Art. 301) that the axes are the directions of the lines of curvature on each. Hence follows the theorem in the form given by Dupin;* namely, that *if there be three systems of surfaces, such that every surface of one system is cut at right angles by all the surfaces of the other two systems, then the intersection of two surfaces belonging to different systems is a line of curvature on each.* For, at each point of it, it is, by hypothesis, possible to draw a third surface cutting both at right angles.

305. A line of curvature is, by definition, such that the normals to the surface at two consecutive points of it intersect each other. If, then, we consider the surface generated by all the normals along a line of curvature, this will be a developable surface (Note, p. 89) since two consecutive generating lines intersect. The developable generated by the normals along a line of curvature manifestly cuts the given surface at right angles.

* *Développements de Géométrie*, 1813, p. 330. The demonstration here given is by Professor W. Thomson: see Gregory's *Solid Geometry*, p. 263. *Cambridge Mathematical Journal*, Vol. IV., p. 62. See also the proof by R. L. Ellis, Gregory's *Examples*, p. 215. A closely connected theorem is the following:

If two surfaces cut at right angles, and if their intersection is a line of curvature on one, it is also a line of curvature on the other.

This may be proved as in the text; viz. taking the origin at any point on the intersection of the two surfaces, then if they cut at right angles $b + b' = 0$. Hence if $b = 0$, then also $b' = 0$, which proves the theorem. The theorem is also true if the surfaces cut at any constant angle.

The locus of points where two consecutive generators of a developable intersect is a curve whose properties will be more fully explained in the next chapter, it is called the *cuspidal edge* of that developable. Each generator is a tangent to this curve, for it joins two consecutive points of the curve; namely, the points where the generator in question is met by the preceding and by the succeeding generator (see Art. 123).

Consider now the normal at any point M of a surface; through that point can be drawn two lines of curvature $MNPQ$, &c., $MN'P'Q'$, &c.: let the normals at the points M, N, P, Q , &c., intersect in C, D, E , &c., and those at M, N', P', Q' in C', D', E' ; then it is evident that the curve CDE , &c., is the cuspidal edge of the developable generated by the normals along the first line of curvature, while $C'D'E'$ is the cuspidal edge of the developable generated by the normals along the second. The normal at M , as has just been explained, touches these curves at the points C, C' , which are the two centres of curvature corresponding to the point M .

What has been proved may be stated as follows.—The cuspidal edge of the developable generated by the normals along a line of curvature is the locus of one of the systems of centres of curvature corresponding to all the points of that line.

306. The assemblage of the centres of curvature C, C' answering to all the points of a surface is a surface of two sheets, called the *surface of centres* (see Art. 198). The curve CDE lies on one sheet while $C'D'E'$ lies on the other sheet. Every normal to the given surface touches both sheets of the surface of centres: for it has been proved that the normal at M touches the two curves $CDE, C'D'E'$, and every tangent line to a curve traced on a surface is also a tangent to the surface.

Now if from a point, not on a surface, be drawn two consecutive tangent lines to the surface, the plane of those lines is manifestly a tangent plane to the surface; for it is a tangent plane to the cone which is drawn from the point touching the surface. But if two consecutive tangent lines intersect on the

surface, it cannot be inferred that their plane touches the surface. For if we cut the surface by any plane whatever, any two consecutive tangents to the curve of section (which, of course, are also tangent lines to the surface) intersect on the curve, and yet the plane of these lines is supposed not to touch the surface.

Consider now the two consecutive normals at the points M, N , these are both tangents to both sheets of the surface of centres. And since the point C in which they intersect is on the first sheet but not necessarily on the second, the plane of the two normals is the tangent plane to the second sheet of the surface of centres.

The plane of the normals at the points M, N' is the tangent plane to the other sheet of the surface of centres. But because the two lines of curvature through M are at right angles to each other, it follows that these two planes are at right angles to each other. Hence, *the tangent planes to the surface of centres at the two points C, C' , where any normal meets it, cut each other at right angles.*

307. It is manifest that for every umbilic on the given surface the two sheets of the surface of centres have a point common; or, in other words, the surface of centres has a double point; and if the original surface have a line of spherical curvature, the surface of centres will have a double line. The two sheets will cut at right angles everywhere along this double line.

This, however, is not the only case where the surface of centres has a double line. A double point on that surface arises not only when the two centres which belong to the same normal coincide, but also when two different normals intersect, and the point of intersection is a centre of curvature for each. It was shewn, Arts. 298–9, that a surface of the n^{th} degree possesses ordinarily a definite number of umbilics, and, therefore, in general not a line of spherical curvature. Hence a double line of the first kind is not among the ordinary singularities of the surface of centres. But that surface will in general have a double line of the second kind. Through any point several normals can be drawn to a surface: *every point on the surface*

of centres is a centre of curvature for one of these normals, each point of a certain locus on the surface will be a centre of curvature for two normals, and there will even be a definite number of points each a centre of curvature for three normals.*

308. It is convenient to define here a *geodesic line* on a surface, and to establish the fundamental property of such a line; namely, that its osculating plane (see Art. 123) at any point is normal to the surface. A geodesic line is the form assumed by a strained thread lying on a surface and joining any two points on the surface. It is plain that the geodesic is ordinarily the shortest line on the surface by which the two points can be joined, since, by pulling at the ends of the thread, we must shorten it as much as the interposition of the surface will permit. Now the resultant of the tensions along two consecutive elements of the curve, formed by the thread, lies in the plane of those elements, and since it must be destroyed by the resistance of the surface, it is normal to the surface; hence, *the plane of two consecutive elements of the geodesic contains the normals to the surface.*†

* The possibility of double lines of the second kind was overlooked by Monge and by succeeding geometers; and, oddly enough, first came to be recognized in consequence of Prof. Kummer's having had a model made of the surface of centres of an ellipsoid (see *Monatsberichte* of the Berlin Academy, 1862). Instead of finding the sheets, as he expected, to meet only in the points corresponding to the umbilics, he found that they intersected in a curve, and that they did not cut at right angles along this line. Of course when the existence of the double line was known to be a fact its mathematical theory was evident. Clebsch had, on purely mathematical grounds, independently arrived at the same conclusion in an elaborate paper on the normals to an ellipsoid, of equal date with Kummer's paper, though of later publication. A discussion of the surface of centres of an ellipsoid, founded on Clebsch's paper, will be given in Chapter XIV.

† I have followed Monge in giving this proof, the mechanical principles which it involves being so elementary that it seems pedantic to object to the introduction them. For the benefit of those who prefer a purely geometrical proof, one or two are added in the text. For readers familiar with the theory of maxima and minima it is scarcely necessary to add that a geodesic need not be the absolutely shortest line by which two points on the surface may be joined. Thus, if we consider two points on a sphere joined by a great circle, the remaining portion of that great circle, exceeding 180° , is a geodesic, though not the shortest line connecting the points. The geodesic, however, will always be the shortest line if the two points considered be taken sufficiently near.

The same thing may also be proved geometrically. In the first place, if two points A , C in different planes be connected by joining each to a point B in the intersection of the two planes, the sum of AB and BC will be less than the sum of any other joining lines AB' , $B'C$, if AB and BC make equal angles with TT' , the intersection of the planes. For if one plane be made to revolve about TT' until it coincide with the other, AB and BC become one right line, since the angle TBA is supposed to be equal to $T'BC$; and the right line AC is the shortest by which the points A and C can be joined.

It follows, that if AB and BC be consecutive elements of a curve traced on a surface, that curve will be the shortest line connecting A and C when AB and BC make equal angles with BT , the intersection of the tangent planes at A and C .

We see, then, that AB (or its production) and BC are consecutive edges of a right cone having BT' for its axis. Now the plane containing two consecutive edges is a tangent plane to the cone; and since every tangent plane to a right cone is perpendicular to the plane containing the axis and the line of contact, it follows that the plane ABC (the osculating plane to the geodesic) is perpendicular to the plane AB , BT , which is the tangent plane at A . The theorem of this article is thus established.

M. Bertrand has remarked (*Liouville*, t. XIII., p. 73, cited by Cayley, *Quarterly Journal*, vol. I., p. 186) that this fundamental property of geodesics follows at once from Meunier's theorem (see Art. 293). For it is evident, that for an indefinitely small arc, the chord of which is given, the excess in length over the chord is so much the less as the radius of curvature is greater. The shortest arc, therefore, joining two indefinitely near points A , B , on a surface is that which has the greatest radius of curvature, and we have seen that this is the normal section.

309. Returning now to the surface of centres, I say that the curve CDE (Art. 306), which is the locus of points of intersection of consecutive normals along a line of curvature, is

a geodesic on the sheet of the surface of centres on which it lies. For we saw (Art. 306) that the plane of two consecutive normals to the surface (that is to say, the plane of two consecutive tangents to this curve) is the tangent plane to the second sheet of the surface of centres and is perpendicular to the tangent plane at C to that sheet of the surface of centres on which C lies. Since, then, the osculating plane of the curve CDE is always normal to the surface of centres, the curve is a geodesic on that surface.

310. We have given the equations connected with lines of curvature on the supposition that the equation of the surface is presented, as it ordinarily is, in the form $\phi(x, y, z) = 0$. As it is convenient, however, that the reader should be able to find here the formulæ which have been commonly employed, we conclude this chapter by deriving the principal equations in the form given by Monge and by most subsequent writers, viz. when the equation of the surface is in the form $z = \phi(x, y)$. We use the ordinary notations

$$dz = p dx + q dy, \quad dp = r dx + s dy, \quad dq = s dx + t dy.$$

We might derive the results in this form from those found already; for since $U = \phi(x, y) - z = 0$, we have

$$\frac{dU}{dx} = p, \quad \frac{dU}{dy} = q, \quad \frac{dU}{dz} = -1,$$

with corresponding expressions for their second differential coefficients. We shall, however, repeat the investigations for this form as they are usually given.

The equation of a tangent plane is

$$z - z' = p(x - x') + q(y - y'),$$

and the equations of the normal are

$$(x - x') + p(z - z') = 0, \quad y - y' + q(z - z') = 0.$$

If then $\alpha\beta\gamma$ be any point on the normal, and xyz the point where it meets the surface, we have

$$(\alpha - x) + p(\gamma - z) = 0, \quad (\beta - y) + q(\gamma - z) = 0.$$

And if $\alpha\beta\gamma$ also satisfy the equations of a second normal, the differentials of these equations must vanish, or

$$dx + pdz = (\gamma - z) dp, \quad dy + qdz = (\gamma - z) dq;$$

whence, eliminating $(\gamma - z)$, we have the equation of condition

$$(dx + pdz) dq = (dy + qdz) dp.$$

Putting in for dz , dp , dq their values already given, and arranging, we have

$$\frac{dy^2}{dx^2} \{(1 + q^2)s - pqt\} + \frac{dy}{dx} \{(1 + q^2)r - (1 + p^2)t\} - \{(1 + p^2)s - pqr\} = 0.$$

This equation determines the projections on the plane of xy of the two directions in which consecutive normals can be drawn so as to intersect the given normal.

311. From the equations of the preceding article we can also find the lengths of the principal radii. The equations

$$dx + pdz = (\gamma - z) dp, \quad dy + qdz = (\gamma - z) dq,$$

when transformed as above become

$$\{1 + p^2 - (\gamma - z)r\} dx + \{pq - (\gamma - z)s\} dy = 0,$$

$$\{1 + q^2 - (\gamma - z)t\} dy + \{pq - (\gamma - z)s\} dx = 0,$$

whence eliminating $dx : dy$, we have

$$(\gamma - z)^2(rt - s^2) - (\gamma - z)\{(1 + q^2)r - 2pqs + (1 + p^2)t\} + (1 + p^2 + q^2) = 0.$$

Now $\gamma - z$ is the projection of the radius of curvature on the axis of z ; and the cosine of the angle the normal makes with

that radius being $\frac{1}{\sqrt{1 + p^2 + q^2}}$ we have,

$$R = (\gamma - z) \sqrt{1 + p^2 + q^2}.$$

Eliminating then $\gamma - z$ by the help of the last equation, R is given by the equation

$$R^2(rt - s^2) - R\{(1 + q^2)r - 2pqs + (1 + p^2)t\} \sqrt{1 + p^2 + q^2} + (1 + p^2 + q^2)^2 = 0.$$

312. From the preceding results can be deduced Joachimsthal's theorem (see *Crelle*, vol. xxx., p. 347) that if a line of curvature be a plane curve, its plane makes a constant

angle with the tangent plane to the surface at any of the points where it meets it. Let the plane be $z = 0$, then the equation of Art. 310

$$(dx + pdz) dq = (dy + qdz) dp$$

becomes $dx dq = dy dp$. But we have also $pdx + qdy = 0$, consequently $pdp + qdq = 0$; $p^2 + q^2 = \text{constant}$. But $p^2 + q^2$ is the square of the tangent of the angle which the tangent plane makes with the plane xy , since $\cos \gamma = \frac{1}{\sqrt{1 + p^2 + q^2}}$.

Otherwise thus (see *Liquille*, vol. XI., p. 87): Let MM' , $M'M''$ be two consecutive and equal elements of a line of curvature, then the two consecutive normals are two perpendiculars to these lines passing through their middle points I, I' , and C the point of meeting of the normals is equidistant from the lines MM' , $M'M''$. But if from C we let fall a perpendicular CO on the plane $MM'M''$, O will be also equidistant from the same elements; and therefore the angle $CIO = CI'O$. It is proved then that the inclination of the normal to the plane of the line of curvature remains unchanged as we pass from point to point of that line.

More generally let the line of curvature not be plane. Then as before, the tangent planes through MM' and through $M'M''$ make equal angles with the plane $MM'M''$. And evidently the angle which the second tangent plane makes with a second osculating plane $M'M''M'''$ differs from the angle which it makes with the first by the angle between the two osculating planes. Thus we have Lancret's theorem, that *along a line of curvature the variation in the angle between the tangent plane to the surface and the osculating plane to the curve is equal to the angle between the two osculating planes.*

For example, if a line of curvature be a geodesic it must be plane. For then the angle between the tangent plane and osculating plane does not vary, being always right; therefore the osculating plane itself does not vary.

313. Finally, to obtain the radius of curvature of any normal section. Since the centre of curvature $\alpha\beta\gamma$ lies on the normal, we have

$$(\alpha - x) + p(\gamma - z) = 0, \quad (\beta - y) + q(\gamma - z) = 0.$$

Further, we have

$$(\alpha - x)^2 + (\beta - y)^2 + (\gamma - z)^2 = R^2.$$

And since this relation holds for three consecutive points of the section which is osculated by the circle we are considering, we have

$$(\alpha - x) dx + (\beta - y) dy + (\gamma - z) dz = 0,$$

$$(\alpha - x) d^2x + (\beta - y) d^2y + (\gamma - z) d^2z = dx^2 + dy^2 + dz^2.$$

Combining this last with the preceding equations, we have

$$\frac{\alpha - x}{p} = \frac{\beta - y}{q} = -\frac{\gamma - z}{1} = \frac{R}{\sqrt{(1 + p^2 + q^2)}} = \frac{dx^2 + dy^2 + dz^2}{pd^2x + qd^2y - d^2z}.$$

But differentiating the equation $dz = pdx + qdy$, we have

$$d^2z - pd^2x - qd^2y = rdx^2 + 2sdx dy + tdy^2,$$

$$\text{whence } R = \pm \sqrt{(1 + p^2 + q^2)} \frac{dx^2 + dy^2 + (pdx + qdy)^2}{rdx^2 + 2sdx dy + tdy^2}.$$

The radius of curvature, therefore, of a normal section whose projection on the plane of xy is parallel to $y = mx$ is

$$\pm \sqrt{(1 + p^2 + q^2)} \frac{(1 + p^2) + 2pqm + (1 + q^2) m^2}{r + 2sm + tm^2}.$$

The conditions for an umbilic are got by expressing that this value is independent of m , and are

$$\frac{1 + p^2}{r} = \frac{pq}{s} = \frac{1 + q^2}{t}.$$

CHAPTER XII.

CURVES AND DEVELOPABLES.

SECTION I. PROJECTIVE PROPERTIES.

314. It was proved (p. 13) that two equations represent a curve in space. Thus the equations $U=0$, $V=0$ represent the curve of intersection of the surfaces U , V .

The degree of a curve in space is measured by the number of points in which it is met by any plane. Thus, if U , V be of the m^{th} and n^{th} degrees respectively, the surfaces which they represent are met by any plane in curves of the same degrees, which intersect in mn points. The curve UV is therefore of the mn^{th} degree.

By eliminating the variables alternately between the two given equations, we obtain three equations

$$\phi(y, z) = 0, \quad \psi(z, x) = 0, \quad \chi(x, y) = 0,$$

which are the equations of the projections of the curve on the three coordinate planes. Any one of the equations taken separately represents the cylinder whose edges are parallel to one of the axes, and which passes through the curve (Art. 25). The theory of elimination shows that the equation $\phi(y, z) = 0$ obtained by eliminating x between the given equations is of the mn^{th} degree. And it is also geometrically evident that any cone or cylinder* standing on a curve of the r^{th} degree is of the r^{th} degree. For if we draw any plane through the vertex of the cone [or parallel to the generators of the cylinder] this plane meets the cone in r lines; namely, the lines joining the vertex to the r points where the plane meets the curve.

* A cylinder is plainly the limiting case of a cone, whose vertex is at infinity.

315. Now, conversely, if we are given any curve in space and desire to represent it by equations, we need only take the three plane curves which are the projections of the curve on the three coordinate planes; then any two of the equations $\phi(y, z) = 0$, $\psi(z, x) = 0$, $\chi(x, y) = 0$ will represent the given curve. But ordinarily these will not form the simplest system of equations by which the curve can be represented. For if r be the degree of the curve, these cylinders being each of the r^{th} degree, any two intersect in a curve of r^2 degree; that is to say, not merely in the curve we are considering but in an extraneous curve of the degree $r^2 - r$. And if we wish not only to obtain a system of equations satisfied by the points of the given curve, but also to exclude all extraneous points, we must preserve the system of three projections; for the projection on the third plane of the extraneous curve in which the first two cylinders intersect will be different from the projection of the given curve.

It may be possible by combining the equations of the three projections to arrive at two equations $U = 0$, $V = 0$, which shall be satisfied for the points of the given curve, and for no other. But it is not generally true that every curve in space is the complete intersection of two surfaces. To take the simplest example, consider two quadrics having a right line common, as, for example, two cones having a common edge. The intersection of these surfaces, which is in general of the fourth degree, must consist of the common right line, and of a curve of the third degree. Now since the only factors of 3 are 1 and 3, a curve of the third degree cannot be the complete intersection of two surfaces unless it be a plane curve; but the curve we are considering cannot be a plane curve,* for if so any arbitrary line in its plane would meet it in three points, but such a line could not meet either quadric in more points than two, and therefore could not pass through three points of their curve of intersection.

* Curves in space which are not plane curves have commonly been called "curves of double curvature." In what follows, I use the word "curve" to denote a curve in space, which ordinarily is not a plane curve, and I add the adjective "twisted" when I want to state expressly that the curve is not a plane curve.

316. The question thus arises how to represent in general a curve in space, by equations. Several answers may be given.

(A). Generalizing the method at the beginning of the last article, we may consider a set of surfaces $U=0$, $V=0$, $W=0$, &c. (where U , V , W , ... are rational and integral functions of the coordinates), all passing through the given curve. This being so, if M , N , P , &c. are also rational and integral functions of the coordinates, then $MU+NV+PW+\dots=0$ is a surface passing through the curve. If any one of the original equations can be thus represented by means of the other equations, *e.g.* if we have identically $U=NV+PW+\dots$, we reject this equation; and if we have through the curve any surface whatever $T=0$ which is not thus representable (*viz.* if T is not of the form $T=MU+NV+PW+\dots$), then we join on the equation $T=0$ to the original system; and so on: if, as may happen, the adjunction of any new equation renders a former equation superfluous, such former equation is to be rejected. We thus arrive at a *complete* system of surfaces passing through the given curve, *viz.* such a system is $U=0$, $V=0$, $W=0$, ... where these functions are not connected by any such equation as $U=NV+PW+\dots$, and where every other surface which passes through the curve is expressible in the form $MU+NV+PW+\dots=0$. It is not easy to prove, but it may safely be assumed, that for a curve of any given order whatever, the number of equations in such a complete system is finite. And we have thus the representation of a curve in space by means of a complete system of surfaces passing through it.

(B). Taking as vertex an arbitrary point, the cone passing through a given curve of the order m is, as we have seen, of the order m ; and it is such that each generating line meets the curve once only. Hence we can on each generating line of a cone of the order m determine a single point in such-wise that the locus of these points is a curve of the order m . It would at first sight appear that we might thus determine the curve as the intersection of the cone by a surface of the order n , having at the vertex of the cone an $(n-1)$ -ple point; for then each generating line of the cone meets the surface in the vertex counting $(n-1)$ times, and in one other

point. But the curve of intersection is not then in general a curve of the order m , but is a curve of the order mn having a singular point at the vertex. To cause this curve to be of the order m , the surface of the order n with the $(n-1)$ -ple point must be particularised; such a surface has through the multiple point $n(n-1)$ right lines; and if any one or more of these lines are on the cone, the complete intersection of the cone and surface will include as part of itself such line or lines, and there will be a residual curve of an order less than mn , and which may reduce itself to m ; viz. the complete intersection of the cone and surface will then consist of $m(n-1)$ lines through the vertex (or rather of lines counting this number of times), and of a residual curve of the order m . The analytical representation of the curve (using quadriplanar coordinates) is by means of two equations the cone $(x, y, z)^m = 0$, and the monoid $(x, y, z)^n + w(x, y, z)^{n-1} = 0$ particularised as above.*

(C). The coordinates of any point of a curve in space may be given as functions of a single parameter θ . They cannot in general be thus expressed as *rational* functions of θ , for this would be a restriction on the generality of the curve in space (the curve would in fact be *unicursal*); but if we imagine two parameters θ, ϕ connected by an algebraic equation, then the coordinates of the point of the curve in space may be taken to be rational functions of θ, ϕ . Or, what is the same thing, writing $\frac{\xi}{\zeta}$ and $\frac{\eta}{\zeta}$ instead of θ, ϕ , we have between ξ, η, ζ an equation $(\xi, \eta, \zeta)^m = 0$, and then (using for the curve in space quadriplanar coordinates) x, y, z, w proportional to rational and integral functions $(\xi, \eta, \zeta)^n$; we thus determine the curve in space, by expressing the coordinates of any point thereof rationally in terms of the coordinates of a point of the plane curve $(\xi, \eta, \zeta)^m = 0$.

(D). A curve in space will be determined if we determine all the right lines which meet it; viz. if we establish between the six coordinates of a right line the relation which expresses that the line meets the curve. Such relation is expressed by

* See Cayley, *Comptes Rendus*, t. LIV. (1862), pp. 55, 396, 672.

a single equation $(p, q, r, s, t, u)^m = 0$ between the coordinates of a right line. But the difficulty is that, not every such equation, but only an equation of the proper form, expresses that the right line meets a determinate curve in space. Thus the general linear relation $(p, q, r, s, t, u)^1 = 0$ is not the equation of any line in space; the particular form

$$ps' + qt' + ru' + sp' + tq' + ur' = 0,$$

where (p', q', r', s', t', u') are constants such that $p's' + q't' + r'u' = 0$ is the equation of a right line, viz. of the line the six coordinates of which are (p', q', r', s', t', u') ; in fact, the equation obviously expresses that the line (p, q, r, s, t, u) meets this line.

317. If a curve be either the complete or partial intersection of two surfaces U, V , the tangent to the curve at any point is evidently the intersection of the tangent planes to the two surfaces, and is represented by the equations

$$xU'_1 + yU'_2 + zU'_3 + wU'_4 = 0,$$

$$xV'_1 + yV'_2 + zV'_3 + wV'_4 = 0.$$

When we use rectangular axes, the direction-cosines of the tangent are plainly proportional to $MN' - M'N, NL' - N'L, LM' - L'M$, where L, M , &c. are the first differential coefficients.

An exceptional case arises when the two surfaces touch, in which case the point of contact is a double point on their curve of intersection. All this has been explained before (see Art. 203). As a particular case of the above, the projection of the tangent line to any curve is the tangent to its projection; and when the curve is given as the intersection of the two cylinders $y = \phi(z), x = \psi(z)$, the equations of the tangent are

$$y - y' = \frac{d\phi}{dz}(z - z'), \quad x - x' = \frac{d\psi}{dz}(z - z').$$

This may be otherwise expressed as follows: Consider any element of the curve ds ; it is projected on the axes of coordinates into dx, dy, dz . The direction-cosines of this element are therefore $\frac{dx}{ds}, \frac{dy}{ds}, \frac{dz}{ds}$, and the equations of the tangent are

$$\frac{x - x'}{\frac{dx}{ds}} = \frac{y - y'}{\frac{dy}{ds}} = \frac{z - z'}{\frac{dz}{ds}}.$$

Since the sum of the squares of the three cosines is equal to unity, we have $ds^2 = dx^2 + dy^2 + dz^2$.

We shall postpone to another section the theory of normals, radii of curvature, and in short everything which involves the consideration of angles, and in this section we shall only consider what may be called the projective properties of curves.

318. The theory of curves is in a great measure identical with that of developables, on which account it is necessary to enter more fully into the latter theory. In fact it was proved (Art. 123) that the reciprocal of a series of points forming a curve is a series of planes enveloping a developable. We there showed that the points of a curve regarded as a system of points 1, 2, 3, &c. give rise to a system of lines; namely, the lines 12, 23, 34, &c. joining each point to that next consecutive, these lines being the tangents to the curve; and that they also give rise to a system of planes, viz. the planes 123, 234, &c. containing every three consecutive points of the system, these planes being the osculating planes of the curve. The assemblage of the lines of the system forms a surface whose equation can be found when the equation of the curve is given. For, the two equations of the tangent line to the curve involve the three coordinates x', y', z' , which being connected by two relations are reducible to a single parameter; and by the elimination of this parameter from the two equations, we obtain the equation of the surface. Or, in other words, we must eliminate $x'y'z'$ between the two equations of the tangent and the two equations of the curve. We have said (Art. 123) that the surface generated by the tangents is a developable, since every two consecutive positions of the generating line intersect each other. The name given to this kind of surface is derived from the property that it can be unfolded into a plane without crumpling or tearing. Thus, imagine any series of lines Aa, Bb, Cc, Dd , &c. (which for the moment we take at finite distances from each other) and such that each intersects the consecutive in the points a, b, c , &c.; and suppose a surface to be made up of the faces AaB, BbC, CcD , &c.,

then it is evident that such a surface could be developed into a plane by turning the face AaB round aB as a hinge until it formed a continuation of BbC ; by turning the two, which we had thus made into one face, round cC until they formed a continuation of the next face, and so on. In the limit when the lines Aa , Bb , &c. are indefinitely near, the assemblage of plane elements forms a developable which, as just explained, can be unfolded into one plane.

The reader will find no difficulty in conceiving this from the examples of developables with which he is most familiar, viz. a cone or a cylinder. There is no difficulty in folding a sheet of paper into the form of either surface and in unfolding it again into a plane. But it will easily be seen to be impossible to fold a sheet of paper into the form of a sphere (which is not a developable surface); or, conversely, if we cut a sphere in two it is impossible to make the portions of the surface lie smooth in one plane.

But in order to exhibit better the form of a developable surface, as also its cuspidal curve afterwards referred to, take two sheets of paper, and cutting out from these two equal circular annuli (*e.g.* let the radii of the two circles be 3 inches and $4\frac{1}{2}$ inches), and placing these one upon the other, gum them together along the inside edge by means of short strips of muslin or thin paper; we have thus a double annulus, which, so long as it remains complete, can only be bent in the same way as if it were single; but cutting through the double annulus along a radius, and taking hold of the two extremities, the whole can be opened out into two sheets of a developable surface, of which the inner circle, bending into a curve of double curvature, is the cuspidal curve or edge of regression.*

It is to be added, that if we draw on each of the two sheets the tangents to the inner circle, and consider each tangent as formed of two halves separated by the point of contact, then when the paper is bent into a developable surface as above, a set of half-tangents on the one sheet will unite with a set

* Thomson and Tait (1867), p. 97. Prof. Cayley mentions that he believes the construction is due to Prof. Blackburn.

of half-tangents on the other sheet to form the generating lines on the developable surface; while the remaining two sets of half-tangents will unite to form on the developable surface a set of curves of double curvature, each touching a generating line at a point of the cuspidal curve, in the manner that a plane curve touches its tangent at a point of inflexion.

319. The plane AaB containing two consecutive generating lines is evidently, in the limit, a tangent plane to the developable. It is obvious that we might consider the surface as generated by the motion of the plane AaB according to some assigned law, the envelope of this plane in all its positions being the developable. Now if we consider the developable generated by the tangent lines of a curve in space, the equations of the tangent at any point $x'y'x'$ are plainly functions of those coordinates, and the equation of the plane containing any tangent and the next consecutive (in other words, the equation of the osculating plane at any point $x'y'z'$) is also a function of these coordinates. But since $x'y'z'$ are connected by two relations, namely, the equations of the curve, we can eliminate any two of them, and so arrive at this result, that *a developable is the envelope of a plane whose equation contains a single variable parameter.* To make this statement better understood we shall point out an important difference between the cases when a plane curve is considered as the envelope of a moveable line, and when a surface in general is considered as the envelope of a moveable plane.

320. The equation of the tangent to a plane curve is a function of the coordinates of the point of contact; and these two coordinates being connected by the equation of the curve, we can either eliminate one of them, or else express both in terms of a third variable so as to obtain the equation of the tangent as a function of a single variable parameter. The converse problem, to obtain the envelope of a right line whose equation includes a variable parameter has been discussed, *Higher Plane Curves*, Art. 86. Let the equation of any tangent line be $u = 0$, where u is of the first degree in x and y ,

and the constants are functions of a parameter t . Then the line answering to the value of the parameter $t + h$ is $u + \frac{du}{dt} h + \frac{d^2u}{dt^2} \frac{h^2}{1.2} + \&c.$; and the point of intersection of these

two lines is given by the equations $u = 0, \frac{du}{dt} + \frac{h}{1.2} \frac{d^2u}{dt^2} + \&c. = 0$.

And, in the limit, the point of intersection of a line with the next consecutive (or, in other words, the point of contact of any line with its envelope) is given by the equations $u = 0, \frac{du}{dt} = 0$. If from these two equations we eliminate t we obtain

the locus of the points of intersection of each line of the system with the next consecutive; that is to say, the equation of the envelope of all these lines. It is easy to prove that the result of this elimination represents a curve to which u is a tangent. We get that result, if in u we replace t by its value, in terms of x and y , derived from the equation $\frac{du}{dt} = 0$. Now, if we differen-

tiate, we have $\frac{du}{dx} = \left(\frac{du}{dx}\right) + \frac{du}{dt} \frac{dt}{dx}$ and $\frac{du}{dy} = \left(\frac{du}{dy}\right) + \frac{du}{dt} \frac{dt}{dy}$,

where $\left(\frac{du}{dx}\right), \left(\frac{du}{dy}\right)$ are the differentials of u on the supposition

that t is constant. And since $\frac{du}{dt} = 0$ it is evident that $\frac{du}{dx}, \frac{du}{dy}$ are the same as on the supposition that t is constant. It follows that the eliminant in question denotes a curve touched by u .

If it be required to draw a tangent to this curve through any point, we have only to substitute the coordinates of that point in the equation $u = 0$, and determine t so as to satisfy that equation. This problem will have a definite number of solutions, and the number will plainly be the number of tangents which can be drawn to the curve from an arbitrary point; that is to say, the class of the curve. For example, the envelope of the line

$$at^3 + 3bt^2 + 3ct + d = 0,$$

where a, b, c, d , are linear functions of the coordinates, is plainly a curve of the third class.

321. Now let us proceed in like manner with a surface. The equation of the tangent plane to a surface is a function of the three coordinates, which being connected by only one relation (viz. the equation of the surface), the equation of the tangent plane, when most simplified, contains two variable parameters. The converse problem is to find the envelope of a plane whose equation $u=0$ contains two variable parameters s, t . The equation of any other plane answering to the values $s+h, t+k$ will be

$$u + \left(h \frac{du}{ds} + k \frac{du}{dt} \right) + \frac{1}{1.2} \left(h^2 \frac{d^2u}{ds^2} + \&c. \right) + \&c. = 0.$$

Now, in the limit, when h and k are taken indefinitely small, they may preserve any finite ratio to each other $k=\lambda h$. We see thus that the intersection of any plane by a consecutive one is not a definite line, but may be any line represented by the equations $u=0, \frac{du}{ds} + \lambda \frac{du}{dt} = 0$, where λ is indeterminate.

But we see also that all planes consecutive to u pass through the *point* given by the equations $u=0, \frac{du}{ds} = 0, \frac{du}{dt} = 0$.

From these three equations we can eliminate the parameters s, t , and so find the locus of all those points where a plane of the system is met by the series of consecutive planes. It is proved, as in the last article, that the surface represented by this eliminant is touched by u . If it be required to draw a tangent plane to this surface through any point, we have only to substitute the coordinates of that point in the equation $u=0$. The equation then containing two indeterminates s and t can be satisfied in an infinity of ways; or, as we know, through a given point an infinity of tangent planes can be drawn to the surface, these planes enveloping a cone.

Suppose, however, that we either consider t as constant, or as any definite function of s , the equation of the tangent plane is reduced to contain a single parameter, and the envelope of those particular tangent planes which satisfy the assumed condition is a developable. Thus, again, we may see the analogy between a developable and a curve. When a surface is con-

sidered as the locus of a number of points connected by a given relation, if we add another relation connecting the points we obtain a curve traced on the given surface. So when we consider a surface as the envelope of a series of planes connected by a single relation, if we add another relation connecting the planes we obtain a developable enveloping the given surface.

322. Let us now see what properties of developables are to be deduced from considering the developable as the envelope of a plane whose equation contains a single variable parameter. In the first place it appears that through any assumed point can be drawn, not, as before, an infinity of planes of the system forming a cone, but a definite number of planes. Thus, if it be required to find the envelope of $at^3 + 3bt^2 + 3ct + d$, where a, b, c, d represent planes, it is obvious that only three planes of the system can be drawn through a given point, since on substituting the coordinates of any point we get a cubic for t . Again, any plane of the system is cut by a consecutive plane in a definite line; namely, the line $u = 0, \frac{du}{dt} = 0$; and if we eliminate t between these two equations, we obtain the surface generated by all those lines, which is the required developable.

It is proved, as at Art. 320, that the plane u touches the developable at every point which satisfies the equations $u = 0, \frac{du}{dt} = 0$; or, in other words, touches along the whole of the line of the system corresponding to u . It was proved (Art. 110) that in general when a surface contains a right line the tangent plane at each point of the right line is different. But in the case of the developable the tangent plane at every point is the same. If x be the plane which touches all along the line xy , the equation of the surface can be thrown into the form $x\phi + y^2\psi = 0$ (see Art. 110).*

* It seems unnecessary to enter more fully into the subject of envelopes in general, since what is said in the text applies equally if u , instead of representing a plane, denote any surface whose equation includes a variable parameter. Monge calls the

323. Let us now consider three consecutive planes of the system, and it is evident, as before, that their intersection satisfies the equations $u = 0$, $\frac{du}{dt} = 0$, $\frac{d^2u}{dt^2} = 0$. For any value of t , the point is thus determined where any line of the system is met by the next consecutive. The locus of these points is got by eliminating t between these equations. We thus obtain two equations in x, y, z , one of them being the equation of the developable. These two equations represent a curve traced on the developable. Thus it is evident that, starting with the definition of a developable as the envelope of a moveable plane, we are led back to its generation as the locus of tangents to a curve. For the consecutive intersections of the planes form a series of lines, and the consecutive intersections of the lines are a series of points forming a curve to which the lines are tangents. We shall presently show that the curve is a cuspidal edge* on the developable.

324. Four consecutive planes of the system will not meet in a point unless the four conditions be fulfilled $u = 0$, $\frac{du}{dt} = 0$, $\frac{d^2u}{dt^2} = 0$, $\frac{d^3u}{dt^3} = 0$. It is in general possible to find certain

curve $u = 0$, $\frac{du}{dt} = 0$, in which any surface of the system is intersected by the consecutive, the *characteristic* of the envelope. For the nature of this curve depends only on the manner in which the variables x, y, z enter into the function u , and not on the manner in which the constants depend on the parameter. Thus, when u represents a plane, the characteristic is always a right line, and the envelope is the locus of a system of right lines. When u represents a sphere, the characteristic being the intersection of two consecutive spheres is a circle, and the envelope is the locus of a system of circles. And so envelopes in general may be divided into families according to the nature of the characteristic.

* Monge has called this the "arête de rebroussement," or "edge of regression" of the developable. There is a similar curve on every envelope, namely, the locus of points in which each "characteristic" is met by the next consecutive. The part of the characteristic on one side of this curve generates one sheet of the envelope, and that on the other side generates another sheet. The two sheets touch along this curve which is their common limit, and is a cuspidal edge of the envelope. Thus, in the case of a cone, the parts of the generating lines on opposite sides of the vertex generate opposite sheets of the cone, and the cuspidal edge in this case reduces itself to a single point, namely, the vertex.

values of t , for which these equations will be satisfied. For if we eliminate x, y, z , we get the condition that the four planes, whose equations have been just written, shall meet in a point. Since this condition expresses that a function of t is equal to nothing, we shall in general get a determinate number of values of t for which it is satisfied. There are therefore in general a certain number of points of the system through which four planes of the system pass; or, in other words, a certain number of points in which three consecutive lines of the system intersect. We shall call these, as at *Higher Plane Curves*, p. 25, the *stationary points* of the system; since in this case the point determined as the intersection of two consecutive lines coincides with that determined as the intersection of the next consecutive pair.

Reciprocally, there will be in general a certain number of planes of the system which may be called *stationary planes*. These are the planes which contain four consecutive points of the system; for, in such a case, the planes 123, 234 evidently coincide.

325. We proceed to show how, from Plücker's equations connecting the ordinary singularities of plane curves,* Prof. Cayley† has deduced equations connecting the ordinary singularities of developables. We shall first make an enumeration of these singularities. We speak of the "points of the system," the "lines of the system," and the "planes of the system" as explained (Art. 123).

Let m be the number of points of the system which lie in any plane; or, in other words, the *degree* of the curve which generates the developable.

* These equations are as follow: see *Higher Plane Curves*, p. 65. Let μ be the degree of a curve, ν its class, δ the number of its double points, τ that of its double tangents, κ the number of its cusps, ι that of its points of inflexion; then

$$\nu = \mu(\mu - 1) - 2\delta - 3\kappa; \quad \mu = \nu(\nu - 1) - 2\tau - 3\iota,$$

$$\iota = 3\mu(\mu - 2) - 6\delta - 8\kappa; \quad \kappa = 3\nu(\nu - 2) - 6\tau - 8\iota.$$

Whence also $\iota - \kappa = 3(\nu - \mu); \quad 2(\tau - \delta) = (\nu - \mu)(\nu + \mu - 9).$

† See Liouville's *Journal*, vol. X. p. 245; *Cambridge and Dublin Mathematical Journal*, vol. V. p. 18.

Let n be the number of planes of the system which can be drawn through an arbitrary point. We have proved (Art. 322) that the number of such planes is definite. We shall call this number the *class* of the system.

Let r be the number of lines of the system which intersect an arbitrary right line. It is plain that if we form the condition that u , $\frac{du}{dt}$, and any assumed right line may intersect, the result will be an equation in t , which gives a definite number of values of t . Let r be the number of solutions of this equation. We shall call this number the *rank* of the system, and we shall show that all other singularities of the system can be expressed in terms of the three just enumerated.

Let α be the number of stationary planes, and β the number of stationary points (Art. 324).

Two non-consecutive lines of the system may intersect. When this happens we call the point of meeting a "point on two lines," and their plane a "plane through two lines." Let x be the number of "points on two lines" which lie in a given plane, and y the number of "planes through two lines" which pass through a given point.

In like manner we shall call the line joining any two points of the system a "line through two points," and the intersection of any two planes a "line in two planes." Let g be the number of "lines in two planes" which lie in a given plane, and h the number of "lines through two points" which pass through a given point. The number h may also be called the number of *apparent* double points of the curve; for to an eye placed at any point, two branches of the curve appear to intersect if any line drawn through the eye meet both branches.

The developable has other singularities which will be determined in a subsequent chapter, but these are the singularities which Plücker's equations (note, p. 291) enable us to determine.

326. Consider now *the section of the developable by any plane*. It is obvious that the points of this curve are the traces on its plane of the "lines of the system," while the tangent

lines of the section are the traces on its plane of the "planes of the system." The degree of the section is therefore r , since it is equal to the number of points in which an arbitrary line drawn in its plane meets the section, and we have such a point whenever the line meets a "line of the system."

The class of the section is plainly n . For the number of tangent lines to the section drawn through an arbitrary point is evidently the same as the number of "planes of the system" drawn through the same point.

A double point on the section will arise whenever two "lines of the system" meet the plane of section in the same point. The number of such points by definition is x . The tangent lines at such a double point are usually distinct, because the two planes of the system corresponding to the lines of the system intersecting in any of the points x are commonly different.

The number of double tangents to the section is in like manner g ; since a double tangent arises whenever two planes of the system meet the plane of section in the same line.

The m points of the system which lie in the plane of section are cusps of the section. For each is a double point as being the intersection of two lines of the system; and the tangent planes at these points coincide, since the two consecutive lines, intersecting in one of the points m , lie in the same plane of the system. This proves, what we have already stated, that the curve whose tangents generate the developable is a cuspidal edge on the developable; for it is such that every plane meets that surface in a section which has as cusps the points where the same plane meets the curve.

Lastly, we get a point of inflexion (or a stationary tangent) wherever two consecutive planes of the system coincide. The number of the points of inflexion is therefore α .

We are to substitute, then, in Plücker's formulæ,

$$\mu = r, \quad \nu = n, \quad \delta = x, \quad \tau = g, \quad \kappa = m, \quad \iota = \alpha.$$

And we have

$$n = r(r-1) - 2x - 3m; \quad r = n(n-1) - 2g - 3\alpha,$$

$$\alpha = 3r(r-2) - 6x - 8m; \quad m = 3n(n-2) - 6g - 8\alpha,$$

whence also

$$m - \alpha = 3(r - n); \quad 2(x - g) = (r - n)(r + n - 9).$$

327. Another system of equations is found by considering *the cone whose vertex is any point and which stands on the given curve*. It appears at once by considering the section of a cone by any plane that the same equations connect the double edges, double tangent planes, &c. of cones, which connect the double points, double tangents, &c. of plane curves.

The edges of the cone which we are now considering are the lines joining the vertex to all the points of the system; and the tangent planes to the cone are the planes connecting the vertex with the lines of the system, for evidently the plane containing two consecutive edges of the cone must contain the line joining two consecutive points of the system.

The degree of the cone is plainly the same as the degree of the curve, and is therefore m .

The class of the cone is the same as the number of tangent planes to the cone which pass through an arbitrary line drawn through the vertex. Now since each tangent plane contains a line of the system, it follows that we have as many tangent planes passing through the arbitrary line as there are lines of the system which meet that line. The number sought is therefore r .*

A double edge of the cone arises when the same edge of the cone passes through two points of the system, or $\delta = h$. The tangent planes along that edge are the planes joining the vertex to the lines of the system which correspond to each of these points.

A double tangent plane will arise when the same plane through the vertex contains two lines of the system, or $\tau = y$.

A stationary or cuspidal edge of the cone will only exist when there is a stationary point in the system, or $\kappa = \beta$.

* It is easy to see that the class of this cone is the same as the degree of the developable which is the reciprocal of the points of the given system. Hence, *the degree of the developable generated by the tangents to any curve is the same as the degree of the developable which is the reciprocal of the points of that curve*, see note p. 105.

$$\begin{aligned}
 m &= 3 \\
 n &= 3 \\
 r &= 4 \\
 \alpha &= 0 \\
 \beta &= 0 \\
 \gamma &= 1 \\
 \delta &= 1 \\
 \epsilon &= 0 \\
 \zeta &= 0
 \end{aligned}$$

Lastly, a stationary tangent plane will exist when a plane containing two consecutive lines of the system passes through the vertex, or $\iota = n$.

Thus we have $\mu = m$, $\nu = r$, $\delta = h$, $\tau = y$, $\kappa = \beta$, $\iota = n$. Hence, by the formulæ (note, p. 291),

$$r = m(m-1) - 2h - 3\beta; \quad m = r(r-1) - 2y - 3n,$$

$$n = 3m(m-2) - 6h - 8\beta; \quad \beta = 3r(r-2) - 6y - 8n.$$

Whence also

$$(n - \beta) = 3(r - m); \quad 2(y - h) = (r - m)(r + m - 9).$$

And combining these equations with those found in the last article, we have also

$$\alpha - \beta = 2(n - m); \quad x - y = n - m; \quad 2(g - h) = (n - m)(n + m - 7).$$

Plücker's equations enable us, when three of the singularities of a plane curve are given, to determine all the rest. Now three quantities r , m , n are common to the equations of this and of the last article. Hence, *when any three of the singularities which we have enumerated, of a curve in space, are given, all the rest can be found.*

328. It is to be observed that, besides the singularities which we have enumerated, a curve may have others which may claim to be counted as ordinary singularities. It may, for example, besides its apparent double points, have H actual double points or nodes; viz., considering the curve as generated by the motion of a variable point, we have a node if ever the point comes twice into the same position. Reciprocally, the system may have G double planes; viz., considering the developable as the envelope of a plane, if in the course of its motion the plane comes twice into the same position, we have a double plane. These singularities will be taken into account if, in the formulæ of Art. 326, we write $\tau = g + G$ instead of $\tau = g$, and in the formulæ of Art. 327, write $\delta = h + H$. In like manner, the system may have ν stationary lines, or lines containing three consecutive points of the system. Such a

line meets in a cusp the section of the developable by any plane, and accordingly, in Art. 326, instead of having $\kappa = m$, we have $\kappa = m + \nu$; and, in like manner, in Art. 327, instead of $\iota = n$, we have $\iota = n + \nu$. Once more, the system may have ω double lines, or lines containing each two pairs of consecutive points of the system. Taking these into account we have, in Art. 326, $\delta = x + \omega$, and in Art. 327, $\tau = y + \omega$.

329. To illustrate this theory, let us take the developable which is the envelope of the plane

$$at^k + kbt^{k-1} + \frac{1}{2}k(k-1)ct^{k-2} + \&c. = 0,$$

where t is a variable parameter, $a, b, c, \&c.$ represent planes, and k is any integer.

The class of this system is obviously k , and the equation of the developable being the discriminant of the preceding equation, its degree is $2(k-1)$; hence $r = 2(k-1)$.

Also it is easy to see that this developable can have no stationary planes. For, in general, if we compare coefficients in the equations of two planes, three conditions must be satisfied in order that the two planes may be identical. If then we attempt to determine t so that any plane may be identical with the consecutive one, we find that we have three conditions to satisfy, and only one constant t at our disposal.

Having then $n = k, r = 2(k-1), \alpha = 0$, the equations of the last two articles enable us to determine the remaining singularities. The result is

$$m = 3(k-2); \quad \beta = 4(k-3); \quad x = 2(k-2)(k-3);$$

$$y = 2(k-1)(k-3); \quad g = \frac{1}{2}(k-1)(k-2); \quad h = \frac{1}{2}(9k^2 - 53k + 80).$$

The greater part of these values can be obtained independently, see *Higher Plane Curves*, p. 71. But in order to economize space we do not enter into details.

330. The case considered in the last article, which is that when the variable parameter enters only rationally into the equation, enables us to verify easily many properties of de-

velopables. Since the system $u = 0$, $\frac{du}{dt} = 0$ is obviously reducible to

$$at^{k-1} + (k-1)bt^{k-2} + \&c. = 0, \quad bt^{k-1} + (k-1)ct^{k-2} + \&c. = 0,$$

and the system $u = 0$, $\frac{du}{dt} = 0$, $\frac{d^2u}{dt^2} = 0$ is reducible to

$$at^{k-2} + (k-2)bt^{k-3} + \&c. = 0, \quad bt^{k-2} + (k-2)ct^{k-3} + \&c. = 0, \\ ct^{k-2} + (k-2)dt^{k-3} + \&c. = 0;$$

it follows that a is itself a plane of the system (namely, that corresponding to the value $t = \infty$), ab is the corresponding line, and abc the corresponding point. Now we know from the theory of discriminants (see *Higher Algebra*, Art. 111) that the equation of the developable is of the form $a\phi + b^2\psi = 0$, where ψ is the discriminant of u when in it a is made $= 0$. Thus we verify what was stated (Art. 322) that a touches the developable along the whole length of the line ab . Further, ψ is itself of the form $b\phi' + c^2\psi'$. If now we consider the section of the developable by one of the planes of the system (or, in other words, if we make $a = 0$ in the equation of the developable), the section consists of the line ab twice and of a curve of the degree $r - 2$; and this curve (as the form of the equation shows) touches the line ab at the point abc , and consequently meets it in $r - 4$ other points. These are all "points on two lines," being the points where the line ab meets other lines of the system. And it is generally true that if r be the rank of a developable *each line of the system meets $r - 4$ other lines of the system*. The locus of these points forms a double curve on the developable, the degree of this curve is x , and other properties of it will be given in a subsequent chapter, where we shall also determine certain other singularities of the developable.

We add here a table of the singularities of some special sections of the developable. The reader, who may care to examine the subject, will find no great difficulty in establishing them. I have given the proof of the greater part of them, *Cambridge and Dublin Mathematical Journal*, vol. v., p. 24.

See also Prof. Cayley's Paper, *Quarterly Journal*, vol. XI., p. 295.

Section by a plane of the system

$$\mu = r - 2, \nu = n - 1, \iota = \alpha, \kappa = m - 3, \tau = g - n + 2, \delta = x - 2r + 8.$$

Cone whose vertex is a point of the system

$$\mu = m - 1, \nu = r - 2, \iota = n - 3, \kappa = \beta, \tau = y - 2r + 8, \delta = h - m + 2.$$

Section by plane passing through a line of the system

$$\mu = r - 1, \nu = n, \iota = \alpha + 1, \kappa = m - 2, \tau = g - 1, \delta = x - r + 4.$$

Cone whose vertex is on a line of the system

$$\mu = m, \nu = r - 1, \iota = n - 2, \kappa = \beta + 1, \tau = y - r + 4, \delta = h - 1.$$

Section by plane through two lines

$$\mu = r - 2, \nu = n, \iota = \alpha + 2, \kappa = m - 4, \tau = g - 2, \delta = x - 2r + 9.$$

Cone whose vertex is a point on two lines

$$\mu = m, \nu = r - 2, \iota = n - 4, \kappa = \beta + 2, \tau = y - 2r + 9, \delta = h - 2.$$

Section by a stationary plane

$$\mu = r - 3, \nu = n - 2, \iota = \alpha - 1, \kappa = m - 4, \tau = g - 2n + 6, \delta = x - 3r + 13.$$

Cone whose vertex is a stationary point

$$\mu = m - 2, \nu = r - 3, \iota = n - 4, \kappa = \beta - 1, \tau = y - 3r + 13, \delta = h - 2m + 6.$$

In the preceding we have not taken account of the singularities G, H, ν, ω , having shewn in Art. 328 how to modify the formulæ so as to include them. The following formulæ of Prof. Cayley's relate to these singularities:

Section by a plane G

$$\mu = r - 4, \nu = n - 2, \iota = \alpha, \kappa = m - 6 + \nu, \tau = g - 2n + 6 + G - 1, \delta = x - 4r + 20 + \omega.$$

Cone whose vertex is a point H

$$\mu = m - 2, \nu = r - 4, \iota = n - 6 + \nu, \kappa = \beta, \tau = y - 4r + 20 + \omega, \delta = h - 2m + 6 + H - 1.$$

Section by plane through stationary line ν

$$\mu = r - 2, \nu = n, \iota = \alpha + 2, \kappa = m - 3 + \nu - 1, \tau = g - 2 + G, \delta = x - 2r + 9 + \omega.$$

Cone whose vertex is on stationary line ν

$$\mu = m, \nu = r - 2, \iota = n - 3 + \nu - 1, \kappa = \beta + 2, \tau = y - 2r + 9 + \omega, \delta = h - 2 + H.$$

Section by tangent plane at contact of line ν

$$\mu = r - 3, \nu = n - 1, \iota = \alpha + 1, \kappa = m - 4 + \nu - 1, \tau = g - n + 1 + G, \delta = x - 3r + 14 + \omega.$$

Cone whose vertex is contact of line ν

$$\mu = m - 1, \nu = r - 3, \iota = n - 4 + \nu - 1, \kappa = \beta + 1, \tau = y - 3r + 14 + \omega, \delta = h - m + 1 + H.$$

Section by plane through double tangent ω

$$\mu = r - 2, \nu = n, \iota = \alpha + 2, \kappa = m - 4 + \nu, \tau = g - 2 + G, \delta = x - 2r - 10 + \omega - 1.$$

Cone whose vertex is on double tangent ω

$$\mu = m, \nu = r - 2, \iota = n - 4 + \nu, \kappa = \beta + 2, \tau = y - 2r + 10 + \omega - 1, \delta = h - 2 + H.$$

Section by tangent plane at one of the contacts of line ω

$$\mu = r - 3, \nu = n - 1, \iota = \alpha + 1, \kappa = m - 5 + \nu, \tau = g - n + 1 + G, \delta = x - 3r + 15 + \omega - 1.$$

Cone whose vertex is a contact of line ω

$$\mu = m - 1, \nu = r - 3, \iota = n - 5 + \nu, \kappa = \beta + 1, \tau = y - 3r + 15 + \omega - 1, \delta = h - m + 1 + H.$$

SECTION II. CLASSIFICATION OF CURVES.

331. The following enumeration rests on the principle that a curve of the degree r meets a surface of the degree p in pr points. This is evident when the curve is the complete intersection of two surfaces whose degrees are m and n . For then we have $r = mn$ and the three surfaces intersect in mnp points. It is true also by definition when the surface breaks up into p planes.* We shall assume that, in virtue of the law of continuity, the principle is generally true.

The use we make of the principle is this. Suppose that we take on a curve of the degree r as many points as are sufficient to determine a surface of the degree p ; then if the number of points so assumed be greater than pr , the surface described through the points must altogether contain the curve; for otherwise the principle would be violated.

We assume in this that the curve is a *proper* curve of the degree r , for if we took two curves of the degrees m and n (where $m + n = r$), the two together might be regarded as a complex curve of the degree r , and if *either* lay altogether on any surface of the degree p , of course we could take on that curve any number of points common to the curve and surface. All this will be sufficiently illustrated by the examples which follow.

332. *There is no line of the first degree but the right line.* For through any two points of a line of the first degree and any assumed point we can describe a plane which must alto-

* Dr. Hart remarks that since every twisted curve of degree r is a partial intersection of two cones of $r - 1$ degree, the complete intersection being the twisted curve together with the line joining vertices of cones and a curve of degree $r (r - 3)$: this principle is proved for twisted cubics. For, the two quadric cones intersect any surface of degree n in $4n$ points of which n lie on the line joining vertices so that $3n$ lie on the twisted cubic.

gether contain the line, since otherwise we should have a line of the first degree meeting the plane in more points than one. In like manner we can draw a second plane containing the line, which must therefore be the intersection of two planes; that is to say, a right line,

There is no proper line of the second degree but a conic. Through any three points of the line we can draw a plane, which the preceding reasoning shows must altogether contain the line. The line must therefore be a plane curve of the second degree.

The exception noted at the end of the last article would occur if the line of the second degree consisted of two right lines not in the same plane; for then the plane through three points of the system would only contain *one* of the right lines. In what follows we shall not think it necessary to notice this again, but shall speak only of proper curves of their respective orders.

333. *A curve of the third degree must either be a plane cubic or the partial intersection of two quadrics, as explained, Art. 315.**

For through seven points of the curve and any two other points describe a quadric; and, as before, it must altogether contain the curve. If the quadric break up into two planes, the curve may be a plane curve lying in one of the planes. As we may evidently have plane curves of any degree we shall not think it necessary to notice these in subsequent cases. If then the quadric do not break up into planes, we can draw a second quadric through the seven points, and the intersection of the two quadrics includes the given cubic. The complete intersection being of the fourth degree, it must be the cubic together with a right line; it is proved therefore that the only non-plane cubic is that explained, Art. 315.

* Non-plane curves of the third degree appear to have been first noticed by Möbius in his *Barycentric Calculus*, 1827. Some of their most important properties are given by M. Chasles in Note XXXIII. to his *Aperçu Historique*, 1837, and in a paper in Liouville's *Journal* for 1857, p. 397. More recently the properties of these curves have been treated by M. Schröter, *Crelle*, vol. LVI., and by Professor Cremona, of Milan, *Crelle*, vol. LVIII., p. 138. Considerable use has been made of the latter paper in the articles which immediately follow.

334. The cone containing a curve of the m^{th} degree and whose vertex is a point on the curve, is of the degree $m - 1$; hence the cone containing a cubic, and whose vertex is on the curve, is of the second degree. *We can thus describe a twisted cubic through six given points.* For we can describe a cone of the second degree of which the vertex and five edges are given, since evidently we are thus given five points in the section of the cone by any plane, and can thus determine that section. If then we are given six points a, b, c, d, e, f , we can describe a cone having the point a for vertex, and the lines ab, ac, ad, ae, af for edges; and in like manner a cone having b for vertex and the lines ba, bc, bd, be, bf for edges. The intersection of these cones consists of the common edge ab and of a cubic which is the required curve passing through the six points.

The theorem that the lines joining six points of a cubic to any seventh are edges of a quadric cone, leads at once to the following by Pascal's theorem: "The lines of intersection of the planes 712, 745; 723, 756; 734, 761 lie in one plane." Or, in other words, "the points where the planes of three consecutive angles 567, 671, 712 meet the opposite sides lie in one plane passing through the vertex 7."* Conversely if this be true for two vertices of a heptagon it is true for all the rest; for then these two vertices are vertices of cones of the second degree containing the other points, which must therefore lie on the cubic which is the intersection of the cones.

335. *A cubic traced on a hyperboloid of one sheet meets all its generators of one system once, and those of the other system twice.*

Any generator of a quadric meets in two points its curve of intersection with any other quadric, namely, in the two points where the generator meets the other quadric. Now when the intersection consists of a right line and a cubic, it is evident that the generators of the same system as the line, since they do not meet the line, must meet the cubic in the two points;

* M. Cremona adds, that when the six points are fixed and the seventh variable, this plane passes through a fixed chord of the cubic.

while the generators of the opposite system, since they meet the line in one point, only meet the cubic in one other point.

Conversely we can describe a system of hyperboloids through a cubic and any chord which meets it twice. For, take seven points on the curve, and an eighth on the chord joining any two of them; then through these eight points an infinity of quadrics can be described. But since three of these points are on a right line, that line must be common to all the quadrics, as must also the cubic on which the seven points lie.

336. The question to find the envelope of $at^3 - 3bt^2 + 3ct - d$ (where a, b, c, d represent planes and t is a variable parameter) is a particular case of that discussed, Art. 329. We have

$$r = 4, \quad m = n = 3, \quad \alpha = \beta = 0, \quad x = y = 0, \quad g = h = 1.$$

Thus the *system is of the same nature as the reciprocal system*, and all theorems respecting it are consequently two-fold. The system being of the third degree must be of the kind we are considering; and this also appears from the equation of the envelope

$$(ad - bc)^2 = 4(b^2 - ac)(c^2 - bd),$$

for it is easy to see that any pair of the surfaces $ad - bc, b^2 - ac, c^2 - bd$, have a right line common, while there is a cubic common to all three, which is a double line on the envelope.

It appears from the table just given that every plane contains one "line in two planes," or that the section of the developable by any plane has one double tangent; while, reciprocally through any point can be drawn one line to meet the cubic twice; the cone therefore, whose vertex is that point, and which stands on the curve, has one double edge; or, in other words, *the cubic is projected on any plane into a cubic having a double point.*

The three points of inflexion of a plane cubic are in one right line. Now it was proved (Art. 327) that the points of inflexion correspond to the three planes of the system which can be drawn through the vertex of the cone. Hence the three points of the system, which correspond to the three planes which

can be drawn through any point O , lie in one plane passing through that point.*

Further, it is known that when a plane cubic has a conjugate point, its three points of inflexion are real; but that when the cubic has a double point, the tangents at which are real, then two of the points of inflexion are imaginary. Hence, if the chord which can be drawn through any point O meet the cubic in two real points, then two of the planes of the system which can be drawn through O are imaginary. Reciprocally, if through any line two real planes of the system can be drawn, then any plane through that line meets the curve in two imaginary points, and only one real one.†

337. These theorems can also be easily established algebraically; for the point of contact of the plane $at^3 - 3bt^2 + 3ct - d$, being given by the equations $at = b$, $bt = c$, $ct = d$, may be denoted by the coordinates $a = 1$, $b = t$, $c = t^2$, $d = t^3$. Now the three values of t answering to planes passing through any point are given by the cubic $a't^3 - 3b't^2 + 3c't - d' = 0$, whence it is evident, from the values just found, that the points of contact lie in the plane $a'd - 3b'c + 3c'b - d'a = 0$. But this plane passes through the given point. Hence *the intersection of three planes of the system lies in the plane of the corresponding points*. The equation just written is unaltered if we interchange accented and unaccented letters. Hence, *if a point A be in the plane of points of contact, corresponding to any point B , B will be in the plane in like manner corresponding to A* . And again, the planes which thus correspond to all the points of a line AB pass through a fixed right line, namely, the intersection of the planes corresponding to A and B . The relation between the lines is evidently reciprocal. To any plane of the system will correspond in this sense the corresponding point of the system; and to a line in two planes corresponds a chord joining two points.

The three points where any plane $Aa + Bb + Cc + Dd$ meets the curve have their t 's given by the equation $Dt^3 + Ct^2 + Bt + A = 0$, and when this is a perfect cube, the

* Chasles, *Liouville*, 1857. Schröter, *Crelle*, vol. LVI.

† Joachimsthal, *Crelle*, vol. LVI. p. 45. Cremona, *Crelle*, vol. LVIII. p. 146.

plane is a plane of the system. From this it follows at once, as Joachimsthal has remarked, that any plane drawn through the intersection of two real planes of the system meets the curve in but one real point. For, in such a case, the cubic just written is the sum of two cubics and has but one real factor.

338. We have seen (Art. 134) that a twisted cubic is the locus of the poles of a fixed plane with regard to a system of quadrics having a common curve. More generally, such a curve is expressed by the result of the elimination of λ between the system of equations $\lambda a = a'$, $\lambda b = b'$, $\lambda c = c'$. Now since the anharmonic ratio of four planes, whose equations are of the form $\lambda a = a'$, $\lambda' a = a'$, &c., depends only on the coefficients λ , λ' , &c. (see *Conics*, Art. 59), this mode of obtaining the equation of the cubic may be interpreted as follows: *Let there be a system of planes through any line aa' , a homographic system through any other line bb' , and a third through cc' , then the locus of the intersection of three corresponding planes of the systems is a twisted cubic.* The lines aa' , bb' , cc' are evidently lines through two points, or chords of the cubic. Reciprocally, *if three right lines be homographically divided, the plane of three corresponding points envelopes the developable generated by a twisted cubic, and the three right lines are "lines in two planes" of the system.*

The line joining two corresponding points of two homographically divided lines touches a conic when the lines are in one plane, and generates a hyperboloid when they are not. Hence, given a series of points on a right line and a homographic series either of tangents to a conic or of generators of a hyperboloid, the planes joining each point to the corresponding line envelope a developable, as above stated.

Ex. If the four faces of a tetrahedron pass through fixed lines, and three vertices move in fixed lines, the locus of the remaining vertex is a twisted cubic. Any number of positions of the base form a system of planes which divide homographically the three lines on which the corners of the base move, whence it follows that the three planes which intersect in the vertex are corresponding planes of three homographic systems.

339. From the theorems of the last article it follows, conversely, that "the planes joining four fixed points of the system

to any variable 'line through two points' form a constant anharmonic system," and that "four fixed planes of the system divide any 'line in two planes' in a constant anharmonic ratio." It is very easy to prove these theorems independently. Thus we know that the section of the developable by any plane A of the system,* consists of the corresponding line a of the system twice, together with a conic to which all other planes of the system are tangents. Thus, then, the anharmonic property of the tangents to a conic shows that four of these planes cut any two lines in two planes, AB , AC in the same anharmonic ratio; and, in like manner, AC is cut in the same ratio as CD .

As a particular case of these theorems, since the lines of the system are both lines in two planes and lines through two points; *four fixed planes of the system cut all the lines of the system in the same anharmonic ratio; and the planes joining four fixed points of the system to all the lines of the system are a constant anharmonic system.*

Many particular inferences may be drawn from these theorems, as at *Conics*, p. 296, which see.

Thus consider four points α , β , γ , δ ; and let us express that the planes joining them to the lines a , b , and $a\beta$, cut the line $\gamma\delta$ homographically. Let the planes A , B meet $\gamma\delta$ in points t , t' . Let the planes joining the line a to β , and the line b to α meet $\gamma\delta$ in k , k' . Then we have

$$\{tk\gamma\delta\} = \{k't'\gamma\delta\} = \{kk'\gamma\delta\}.$$

If the points t , k' coincide, it follows from the first equation that the points k , t' coincide, and from the second that the points t , t' , γ , δ are a harmonic system. Thus we obtain Prof. Cremona's theorem, that if a series of chords meet the line of intersection of any plane A with the plane joining the corresponding point α to any line b of the system, then they will also meet the line of intersection of the plane B with the plane joining β to a ; and will be cut harmonically where they meet these two lines and where they meet the curve.

* It is often convenient to denote the planes of the system by capital letters, the corresponding lines by italics, and the corresponding points by Greek letters.

The reader will have no difficulty in seeing when it will happen that one of these lines passes to infinity, in which case the other line becomes a diameter.

340. We have seen that the sections of the developable by the planes of the system are conics. The line of intersection of two planes of the system is a common tangent to the two corresponding conics. Thus the planes touching two conics, themselves having the line in which their planes intersect as a common tangent, are osculating planes of a twisted cubic. We may investigate the locus of the centres of these conics, or more generally the locus of the poles with respect to these conics of the intersections of their planes with a fixed plane. Since in every plane we can draw a "line in two planes" we may suppose that the fixed plane passes through the intersection of two planes of the system A, B .

Now consider the section by any other plane C ; the traces on that plane of A and B are tangents to that section, and the pole of any line through their intersection lies on their chord of contact, that is to say, lies on the line joining the points where the lines of the system a, b meet C . But since all planes of the system cut the lines a, b homographically, the joining lines generate a hyperboloid of one sheet, of which a and b are generators. However then the plane be drawn through the line AB , the locus of poles is on this hyperboloid. But further, it is evident that the pole of any plane through the intersection of A, B lies in the plane which is the harmonic conjugate of that plane with respect to those tangent planes. The locus therefore which we seek is a plane conic. It appears also from the construction that since the poles when any plane $A + \lambda B$ is taken for the fixed plane, lie on a conic in the plane $A - \lambda B$; conversely, the locus when the latter is taken for fixed plane is a conic in the former plane.*

341. In conclusion, it is obvious enough that cubics may be divided into *four species* according to the different sections

* The theorems of this article are taken from Prof. Cremona's paper. >

of the curve by the plane at infinity. Thus that plane may either meet the curve in three real points; in one real and two imaginary points; in one real and two coincident points, that is to say, a line of the system may be at infinity; or lastly, in three coincident points, that is to say a plane of the system may be altogether at infinity. These species have been called the cubical hyperbola, cubical ellipse, cubical hyperbolic parabola, and cubical parabola. It is plain that when the curve has real points at infinity, it has branches proceeding to infinity, the lines of the system corresponding to the points at infinity being asymptotes to the curve. But when the line of the system is itself at infinity, as in the third and fourth cases, the branches of the curve are of a parabolic form proceeding to infinity without tending to approach to any finite asymptote. Since the quadric cones which contain the curve become cylinders when their vertices pass to infinity, it is plain that three quadric cylinders can be described containing the curve, the edges of the cylinders being parallel to the asymptotes. Of course in the case of the cubical ellipse two of these cylinders are imaginary: in the case of the hyperbolic parabola there are only two cylinders, one of which is parabolic, and in the case of the cubical parabola there is but one cylinder which is parabolic. The cubical ellipse may be conceived as lying on an elliptic cylinder, one generating line of which is the asymptote; the curve is a continuous line winding once round the cylinder, and approaching the asymptote on opposite sides at its two extremities.

It follows, from Art. 336, that in the case of the cubical ellipse the plane at infinity contains a real line in two planes, which is imaginary in the case of the cubical hyperbola. That is to say, in the former case, but not in the latter, two planes of the system can be parallel. From the anharmonic property we infer that in the case of the cubical parabola three planes of the system divide in a constant ratio all the lines of the system. In this case all the planes of the system cut the developable in parabolas. The system may be regarded as the envelope of $xt^3 - 3yt^2 + 3zt - d$ where d is constant. For further details we refer to Prof. Cremona's Memoir.

342. We proceed now to the *classification of curves of higher orders*. We have proved (Art. 331) that through any curve can be described two surfaces, the lowest values of whose degrees in each case there is no difficulty in determining. It is evident then, on the other hand, that if commencing with the simplest values of μ and ν we discuss all the different cases of the intersection of two surfaces whose degrees are μ and ν , we shall include all possible curves up to the r^{th} order, the value of this limit r being in each case easy to find when μ and ν are given. With a view to such a discussion we commence by investigating the characteristics of the curve of intersection of two surfaces.* We have obviously $m = \mu\nu$, and if the surfaces are without multiple lines and do not touch, as we shall suppose they do not, their curve of intersection has no multiple points (Art. 203), and therefore $\beta = 0$. In order to determine completely the character of the system, it is necessary to know one more of its singularities, and we choose to seek for r , the degree of the developable generated by the tangents. Now this developable is got by eliminating $x'y'z'$ between the four equations

$$U'=0, V'=0, U_1'x+U_2'y+U_3'z+U_4'w=0, V_1'x+V_2'y+V_3'z+V_4'w=0.$$

These equations are respectively of the degrees $\mu, \nu, \mu - 1, \nu - 1$: and since only the last two contain xyz , these variables enter into the result in the degree

$$\mu\nu(\nu - 1) + \mu\nu(\mu - 1) = \mu\nu(\mu + \nu - 2).$$

Otherwise thus: the condition that a line of the system should intersect the arbitrary line

$$\alpha x + \beta y + \gamma z + \delta w, \quad \alpha' x + \beta' y + \gamma' z + \delta' w$$

is

$$\begin{vmatrix} \alpha, & \beta, & \gamma, & \delta \\ \alpha', & \beta', & \gamma', & \delta' \\ U_1, & U_2, & U_3, & U_4 \\ V_1, & V_2, & V_3, & V_4 \end{vmatrix} = 0,$$

* The theory explained in the remainder of this section is taken from my paper dated July, 1849, *Cambridge and Dublin Mathematical Journal*, vol. v. p. 23.

which is evidently of the degree $\mu + \nu - 2$. This denotes a surface which is the locus of the points, the intersections of whose polar planes with respect to U and V meet the arbitrary line. And the points where this locus meets the curve UV are the points for which the tangents to that curve meet the arbitrary line.

Having then $m = \mu\nu$, $\beta = 0$, $r = \mu\nu(\mu + \nu - 2)$, we find, by Art. 327,

$$\begin{aligned} n &= 3\mu\nu(\mu + \nu - 3), \quad \alpha = 2\mu\nu(3\mu + 3\nu - 10), \quad 2h = \mu\nu(\mu - 1)(\nu - 1) \\ &\quad 2g = \mu\nu\{\mu\nu(3\mu + 3\nu - 9)^2 - 22(\mu + \nu) + 71\}, \\ 2x &= \mu\nu\{\mu\nu(\mu + \nu - 2)^2 - 4(\mu + \nu) + 8\}, \\ 2y &= \mu\nu\{\mu\nu(\mu + \nu - 2)^2 - 10(\mu + \nu) + 28\}. \end{aligned}$$

343. We verify this result by determining independently h the number of "lines through two points" which can pass through a given point, that is to say, the number of lines which can be drawn through a given point so as to pass through two points of the intersection of U and V . For this purpose it is necessary to remind the reader of the method employed, p. 101, in order to find the equation of the cone whose vertex is any point and which passes through the intersection of U and V . Let us suppose that the vertex of the cone is taken on the curve, so as to have both U and $V = 0$ for the coordinates of the vertex. Then it appears, from p. 101, that the equation of the cone is the result of eliminating λ between

$$\delta U + \frac{\lambda}{1.2} \delta^2 U + \frac{\lambda^2}{1.2.3} \delta^3 U + \&c. = 0, \quad \mu - 1$$

$$\delta V + \frac{\lambda}{1.2} \delta^2 V + \frac{\lambda^2}{1.2.3} \delta^3 V + \&c. = 0. \quad \nu - 1$$

These equations in λ are of the degrees $\mu - 1$, $\nu - 1$; δU , $\delta^2 U$, $\&c.$, contain the coordinates $x'y'z'$, xyz in the degrees $\mu - 1$, 1 ; $\mu - 2$, 2 , $\&c.$ A specimen term of the result is $(\delta U)^{\nu-1} V^{\mu-1}$. Thus it appears that the result contains the variables xyz in the degree $\nu - 1 + \nu(\mu - 1) = \mu\nu - 1$; while it contains $x'y'z'$ in the degree $(\mu - 1)(\nu - 1)$. Every edge of this cone of the degree $\mu\nu - 1$, whose vertex is a point on the curve, is of

course a "line through two points." If now in this result we consider the coordinates of any point xyz on the cone as known and $x'y'z'$ as sought, this equation of the degree $(\mu - 1)(\nu - 1)$ combined with the equations U and V determines the "points" belonging to all the "lines through two points" which can pass through the assumed point. The total number of such points is therefore $\mu\nu(\mu - 1)(\nu - 1)$, and the number of lines through two points is of course half this. The number of points thus determined has been called (Art. 325) the number of apparent double points on the intersection of the two surfaces.

344. Let us now consider the case when the curve UV has also *actual* double points; that is to say, when the two surfaces touch in one or more points. Now, in this case, the number of *apparent* double points remains precisely the same as in the last article, and the cone, standing on the curve of intersection and whose vertex is any point, has as double edges the lines joining the vertex to the points of contact in *addition* to the number determined in the last article. It is easy to see that the investigation of the last article does not include the lines joining an arbitrary point to the points of contact. That investigation determines the number of cases when the radius vector from any point has two values the same for both surfaces, but the radius vector to a point of contact has only one value the same for both, since the point of contact is not a double point on either surface. Every point of contact then adds one to the number of double edges on the cone, and therefore diminishes the degree of the developable by two. This might also be deduced from Art. 342, since the surface generated by the tangents to the curve of intersection must include as a factor the tangent plane at a point of contact, since every tangent line in that plane touches the curve of intersection.

If the surfaces have stationary contact at any point (Art. 204) the line joining this point to the vertex of the cone is a cuspidal edge of that cone. If, then, the surfaces touch in t points of ordinary contact and in β of stationary contact, we have

$$m = \mu\nu, \quad \beta = \beta, \quad 2h = \mu\nu(\mu - 1)(\nu - 1) + 2t,$$

$$r = \mu\nu(\mu + \nu - 2) - 2t - 3\beta,$$

and the reader can calculate without difficulty how the other numbers in Art. 342 are to be modified.

We can hence obtain a limit to the number of points at which two surfaces can touch if their intersection do not break up into curves of lower order; for we have only to subtract the number of apparent double points from the maximum number of double points which a plane curve of the degree $\mu\nu$ can have (*Higher Plane Curves*, Art. 42).

345. We shall now show that when the curve of intersection of two surfaces breaks up into two simpler curves, the characteristics of these curves are so connected that, when those of the one are known, those of the other can be found. It was proved (Art. 343) that the points belonging to the "lines through two points" which pass through a given point are the intersection of the curve UV with a surface whose degree is $(\mu - 1)(\nu - 1)$. Suppose now that the curve of intersection breaks up into two whose degrees are m and m' , where $m + m' = \mu\nu$, then evidently the "two points" on any of these lines must either lie both on the curve m , both on the curve m' , or one on one curve and the other on the other. Let the number of lines through two points of the first curve be h , those for the second curve h' , and let H be the number of lines which pass through a point on each curve, or, in other words, the number of *apparent intersections* of the curves. Considering then the points where each of the curves meets the surface of the degree $(\mu - 1)(\nu - 1)$, we have obviously the equations

$$m(\mu - 1)(\nu - 1) = 2h + H, \quad m'(\mu - 1)(\nu - 1) = 2h' + H,$$

whence $2(h - h') = (m - m')(\mu - 1)(\nu - 1)$.

Thus when m and h are known m' and h' can be found. To take an example which we have already discussed, let the intersection of two quadrics consist in part of a right line (for which $m' = 1, h' = 0$), then the remaining intersection must be of the third degree $m = 3$, and the equation above written determines $h = 1$.

346. In like manner it was proved (Art. 342) that the locus of points, the intersection of whose polar planes with

regard to U and V meets an arbitrary line, is a surface of the degree $\mu + \nu - 2$. The first curve meets this surface in the t points where the curves m and m' intersect (since U and V touch at these points) and in the r points for which the tangent to the curve meets the arbitrary line. Thus, then,

$$m(\mu + \nu - 2) = r + t, \quad m'(\mu + \nu - 2) = r' + t,$$

$$(m - m')(\mu + \nu - 2) = r - r',$$

an equation which can easily be proved to follow from that in the last article.

The intersection of the cones which stand on the curves m , m' consists of the t lines to the points of actual meeting of the curves and of the H lines of apparent intersection; and the equation $H + t = mm'$ is easily verified by using the values just found for H and t , remembering also that $m' = \mu\nu - m$, $r = m(m - 1) - 2h$.

347. Having now established the principles which we shall have occasion to employ, we resume our enumeration of the different species of curves of the fourth order. *Every quartic curve lies on a quadric.* For the quadric determined by nine points on the curve must altogether contain the curve (Art. 331). It is not generally true that a second quadric can be described through the curve; there are therefore *two principal families of quartics, viz. those which are the intersection of two quadrics, and those through which only one quadric can pass.** We commence with the curves of the first family. The characteristics of the intersection of two quadrics which *do not touch* are (Art. 342)

$$m = 4, \quad n = 12, \quad r = 8, \quad \alpha = 16, \quad \beta = 0, \quad x = 16, \quad y = 8, \quad g = 38, \quad h = 2.$$

Several of these results can be established independently. Thus we have given (Art. 218) the equation of the developable generated by the tangents to the curve, which is of the eighth degree. It is there proved also that the developable has in each of its four principal planes a double line of the fourth

* The existence of this second family of quartics was first pointed out in the Memoir already referred to.

order, whence $x = 16$. It has been mentioned (p. 189) that the developable circumscribing two quadrics has, as double lines, a conic in each of the principal planes. The number $y = 8$ is thus accounted for. Again, it is shown, p. 191, that the equation of the osculating plane is $Tu = T'v$ (u and v being the tangent planes to U and V at the point), which contains the coordinates of the point of contact in the third degree. If, then, it be required to draw an osculating plane through any assumed point, the points of contact are determined as the intersections of the curve UV with a surface of the third degree, the problem therefore admits of twelve solutions; thus $n = 12$. Lastly, every generator of a quadric containing the curve is evidently a "line through two points" (Art. 345). Since, then, we can describe through any assumed point a quadric of the form $U + \lambda V$, the two generators of that quadric which pass through the point are two "lines through two points"; or $h = 2$. The lines through two points may be otherwise found by the following construction, the truth of which it is easy to see: Draw a plane through the assumed point O , and through the intersection of its polar planes with respect to the two quadrics, this plane meets the quartic in four points which lie on two right lines intersecting in O .

A quartic of this species is determined by eight points (Art. 130).

348. Secondly, let the two quadrics *touch*, then (Art. 344) the cone standing on the curve has a double edge more than in the former case, and the developable is of a degree less by two. Hence

$$m = 4, n = 6, r = 6; g = 6, h = 3; \alpha = 4, \beta = 0; x = 6, y = 4.$$

Thirdly, the quadrics may have *stationary contact* at a point, when we have

$$m = 4, n = 4, r = 5; g = 2, h = 2; \alpha = 1, \beta = 1; x = 2, y = 2.$$

This system, as noticed by Prof. Cayley, may be expressed as the envelope of

$$at^4 + 6ct^2 + 4dt + e,$$

where t is a variable parameter. The envelope is

$$(ae + 3c^2)^3 = 27(ace - ad^2 - c^3)^2,$$

which expanded contains a as a factor and so reduces to the fifth degree. The cuspidal edge is the intersection of $ae + 3c^2$, $4ce - 3a^2$.

Since a cone of the fourth degree cannot have more than three double edges, two quadrics cannot touch in more points than one, unless their curve of intersection break up into simpler curves. If two quadrics *touch* at *two points* on the same generator, this right line is common to the surfaces, and the intersection breaks up into a right line and a cubic. If they touch at two points not on the same generator, the intersection breaks up into two plane conics whose planes intersect in the line joining the points (see Art. 137).

349. If a quartic curve be *not the intersection of two quadrics* it must be the partial intersection of a quadric and a cubic. We have already seen that the curve must lie on a quadric, and if through thirteen points on it, and six others which are not in the same plane,* we describe a cubic surface, it must contain the given curve. The intersection of this cubic with the quadric already found must be the given quartic together with a line of the second degree, and the apparent double points of the two curves are connected by the relation $h - h' = 2$, as appears on substituting in the formula of Art. 345 the values $m = 4$, $m' = 2$, $\mu = 3$, $\nu = 2$. When the line of the second degree is a plane curve (whether conic or two right lines), we have $h' = 0$; therefore $h = 2$, or the quartic is one of the species already examined having two apparent double points. It is easy to see otherwise, that if a cubic and quadric have a plane curve common, through their remaining intersection a second quadric can be drawn; for the equations of the quadric and cubic are of the form $zw = u_2$, $zv_2 = u_2x$, which intersect on $v_2 = xw$. If, however, the cubic and quadric have common two right lines not in the same plane, this is a system having one apparent double point, since through any point can be

* This limitation is necessary, otherwise the cubic might consist of the quadric and of a plane. Thus, if a curve of the fifth order lie in a quadric it cannot be proved that a cubic distinct from the quadric can contain the given curve; see *Cambridge and Dublin Mathematical Journal*, vol. v. p. 27.

drawn a transversal meeting both lines. Since then $h' = 1$, $h = 3$; or these quartics have three apparent double points, and are therefore essentially distinct from those already discussed, which cannot have more than two. The numerical characteristics of these curves are precisely the same as those of the first species in Art. 348, the cone standing on either curve having three double edges, the difference being that one of the double edges in one case proceeds from an actual double point, while in the other they all proceed from apparent double points.

This system of quartics is the reciprocal of that given by the envelope of $at^4 + 4bt^3 + 6ct^2 + 4dt + e$. Moreover, this latter system has, in addition to its cuspidal curve of the sixth order, a nodal curve of the fourth, which is of the kind now treated of.

It is proved, as in Art. 335, that these quartics are met in three points by all the generators of the quadric on which they lie, which are of the same system as the lines common to the cubic and quadric; and are met once by the generators of the opposite system. The cone standing on the curve, whose vertex is any point of it, is then a cubic having a double edge, that double edge being one of the generators, passing through the vertex, of the quadric which contains the curve. Thus, while any cubic may be the projection of the intersection of two quadrics, quartics of this second family can only be projected into cubics having a double point. The quadric may be considered as the surface generated by all the "lines through three points" of the curve. It is plain, from what has been stated, that *every quartic, having three apparent double points, may be considered as the intersection of a quadric with a cone of the third order having one of the generators of the quadric as a double edge.*

350. Prof. Cayley has remarked that it is possible to describe through eight points a quartic of this second family. We want to describe through the eight points a cone of the third degree having its vertex at one of them, and having a double edge, which edge shall be a generator of a quadric

through the eight points. Now it follows, from Art. 347, that if a system of quadrics be described through eight points, all the generators at any one of them lie on a cone of the third degree, which passes through the quartic curve of the first family determined by the eight points. Further, if S, S', S'' be three cubical cones having a common vertex and passing through seven other points, $\lambda S + \mu S' + \nu S''$ is the general equation of a cone fulfilling the same conditions; and if it have a double edge, $\lambda S_1 + \mu S_1' + \nu S_1''$, passes through that edge. Eliminating then λ, μ, ν between the three differentials, the locus of double edges is the cone of the sixth order

$$S_1(S_2'S_3'' - S_2''S_3') + S_2(S_3'S_1'' - S_3''S_1') + S_3(S_1'S_2'' - S_1''S_2') = 0.$$

The intersection then of this cone of the sixth degree with the other of the third determines right lines, through any of which can be described a quadric and a cubic cone fulfilling the given conditions. It is to be observed, however, that the lines connecting the assumed vertex with the seven other points are simple edges on one of these cones and double edges on the other, and these (equivalent to fourteen intersections) are irrelevant to the solution of the problem. *Four quartics, therefore, can be described through the points.*

351. Prof. Cayley has directed my attention to a special case of this second family of quartics which I had omitted to notice. It is, when the curve has a linear inflexion of the kind noticed, Art. 328; that is to say, when three consecutive points of the curve are on a right line. Such a point obviously cannot exist on a quartic of the first family; for the line joining the three points must then be a generator of both quadrics, whose intersection would therefore break up into a line and a cubic, and would no longer be a quartic. Let us examine then in what case three consecutive planes of the system $at^4 + 4bt^3 + 6ct^2 + 4dt + e$ can pass through the same line. If such a case occurs, we may suppose that we have so transformed the equation that the singular point in question may answer to $t = \infty$; the three planes a, b, c , must therefore pass through the same line; or c must be of the form $\lambda a + \mu b$. But we may then transform the equation further by writing for $t, t + \theta$, and determining θ so that the

quantity multiplying b in the coefficient of t^2 shall vanish. The system then is the envelope of a plane $at^4 + 4bt^3 + 6\lambda at^2 + 4dt + e$. A still more special case is when λ vanishes, or when the plane reduces to $at^4 + 4bt^3 + 4dt + e$; it is obvious then, that we have two points of linear inflexion; one answering to $t = \infty$, the other to $t = 0$. The developable in this latter case is

$$(ae - 4bd)^3 = 27(ad^2 + eb^2)^2;$$

which has for its edge of regression the intersection of $ae - 4bd$ with $ad^2 + eb^2$; but this consists of a curve of the fourth degree with the lines ab, de . This system then is one whose reciprocal is of the same nature; for we have $m = n = 4, h = k = 3, x = y = 4$. And the section of the developable by any plane has six cusps, viz. the four points where the plane meets the cuspidal edge, and the two where it meets the double generators ab, de . In the case previously noticed where c does not vanish but is equal to λa , there is but one point of linear inflexion; the envelope in question is, then, the reciprocal of a system for which $m = 4, n = 5, r = 6, h = 3, k = 4, x = 5, y = 4$. Another special case to be considered is when a curve has a double tangent; such a line being doubly a line of the system is a double line on the developable. But this does not occur in quartic* curves.

* For other properties of curves of the fourth order, see papers by M. Chasles, *Comptes Rendus*, vols. LIV. and LV.; and by M. Cremona, *Memoirs of the Bologna Academy*, 1861.

To complete the enumeration of curves up to the fourth order, it would be necessary to classify, according to their apparent double points, improper systems made up of simpler curves of lower orders. Thus we have, for $m = 2, h = 1$, two lines not in the same plane; $m = 3, h = 1$, a conic and a line once meeting it; $h = 2$, a conic and line not meeting it; $h = 3$, three lines, no two of which are in the same plane; $m = 4, h = 2$, a plane cubic and line once meeting it, or a twisted cubic and line twice meeting it, or two conics having two points common; $m = 4, h = 3$, a plane cubic and line not meeting it, or a twisted cubic and line once meeting it, or two conics having one point common; $m = 4, h = 4$, a twisted cubic and non-intersecting line, or two non-intersecting conics; $h = 5$, a conic and two lines meeting neither the conic nor each other; $h = 6$, four lines, no two of which are in the same plane.

An interesting quartic curve, Sylvester's "Twisted Cartesian" (see *Phil. Mag.*, 1866, pp. 287, 380), may here be mentioned specially: viz. the locus of a point whose distances from three fixed foci are connected by the relations

$$lp + m\rho' + n\rho'' = a, \quad l\rho + m'\rho' + n'\rho'' = b.$$

This curve has an infinity of foci lying in a plane cubic which is the locus of foci of conics which pass through four points lying on a circle; and may be represented as the intersection of a sphere and a parabolic cylinder.

352. The enumeration in regard to curves of the fifth order is effected in the memoir already cited. It is easy to see that besides plane quintics we have, I., quintics which are the partial intersection of a quadric and a cubic, the remaining intersection being a right line. These quintics have four apparent double points, and may besides have two actual nodal or cuspidal points. We may have, II., quintics with five apparent double points, and which may, besides, have one actual nodal or cuspidal point; these curves being the partial intersection of two cubics, and the remaining intersection a quartic of the second class. We may have, III., quintics with six apparent double points being the partial intersection of two cubics, the remaining intersection being an improper quartic with four apparent double points. To these may be added, IV., quintics with six apparent double points which are the partial intersection of a quadric and a quartic surface; the remaining intersection being three lines not in the same plane.

353. Instead of proceeding, as we have done, to enumerate the species of curves arranged according to their respective orders, we might have arranged our discussion according to the order of the developables generated, and have enumerated the different species of the developables of the fourth, fifth, &c., orders. This is the method followed by Chasles, who has enumerated the species of developables up to the sixth order (*Comptes Rendus*, vol. LIV.), and by Schwarz (*Crelle*, vol. LXIV., p. 1) who has carried on his enumeration to the seventh order. Schwarz's discussion contains the answer to the following question started by Prof. Cayley: the equation considered, Art. 329, where the parameter enters rationally, denotes a single plane whose envelope is a class of developables which Prof. Cayley calls *planar* developables; on the other hand, if the parameter entered by radicals, the equation rationalized would denote a system of planes whose envelope would therefore be called a *multiplanar* developable: now it is proposed to ascertain concerning each developable, what is, in this sense, the degree of its planarity. M. Schwarz has answered this question by shewing that the developables of the first seven orders are all planar.

In fact when a developable is planar, the planes, lines and points of the system are expressible rationally by means of a parameter; and therefore every section of the developable is unicursal (*Higher Plane Curves*, Art. 44), as is also the cuspidal edge and every cone standing on it. It may be verified by the equations of Arts. 326-7, that

$$\frac{1}{2}(r-1)(r-2) - (m+x) = \frac{1}{2}(r-1)(r-2) - (n+y) =$$

$$\frac{1}{2}(m-1)(m-2) - (h+\beta) = \frac{1}{2}(n-1)(n-2) - (g+\alpha) = \frac{1}{2}(m+n) - (r-1),$$

any of these expressions denoting the deficiency either of the section (Art. 326) or of the cone (Art. 327). When this deficiency vanishes, the developable is planar; when it = 1 it is biplanar, &c. And this number is the same for any curve in space, and for any other derived from it by linear transformation.

354. The discussion of the possible characteristics of a developable of given order, depends on the principle (p. 298) that the section by a plane of the system is a curve of degree $r-2$ having $m-3$ cusps. Thus, if the developable be of the fifth order the section by a plane of the system is a cubic; and as this can have no more than one cusp, the edge of regression is at most of the fourth degree. And it cannot be of lower degree, since we have already seen that twisted cubics generate developables only of the fourth order. Hence the only developables* of the fifth order are those, considered Art. 348, generated by a curve of the fourth order.

In the same manner the section of a developable of the sixth order by a plane of the system is a quartic, which may have one, two, or three cusps. We have therefore $m=4, 5,$ or 6 ; and, in like manner, n is confined within the same limits; and therefore, p. 298, the section by the plane of the system is at most of the fifth class. Now a curve of the fourth degree with one cusp must have two other double points if it is only of the fifth class: and, if it have two cusps, it must have one other double point. In any case, therefore, this quartic is

* The properties of these developables are treated of by Professor Cremona, *Comptes Rendus*, vol. LIV., p. 604.

unicursal and the developable is planar. The case when the quartic has only one cusp (or $m=4$) has been already considered. The edge of regression has a nodal point; and the system is the reciprocal of the system which envelopes

$$at^4 + 4bt^3 + 6ct^2 + 4dt + \lambda a = 0,$$

where there is a double plane of the system answering to $t=0$ and also to $t=\infty$.

If, again, the quartic section have three cusps, it is of the third class, and therefore for the developable $n=4$. This then is also a case already discussed, Art. 349, the developable being the envelope of

$$at^4 + 4bt^3 + 6ct^2 + 4dt + e = 0.$$

Lastly, when the quartic has two cusps, it must, as we have seen, also have a double point, and therefore be of the fourth class. Hence $n=5$. From the preceding formulæ the characteristics of a system for which $m=n=5$, $r=6$, are $g=h=4$, $x=y=5$, $\alpha=\beta=2$; and, if we take the two stationary planes answering to $t=\infty$, $t=0$, the system is the envelope of

$$at^5 + 5\lambda at^4 + 10ct^3 + 10dt^2 + 5\mu ft + f = 0.$$

M. Schwarz has noticed that the stationary tangent planes may be replaced by a triple tangent plane; that is to say, the system may be the envelope of

$$at^5 + 5\lambda at^4 + 10\mu at^3 + 10dt^2 + 5et + f = 0.$$

I have not examined with any care the theory of the effects of triple points of the curve of intersection of two surfaces on the number of its apparent double points. But (considering the case where λ and μ vanish in the equation last written) if we make b and $e=0$ in the equations which I have given (*Cambridge and Dublin Mathematical Journal*, v. 158) for the edge of regression of the developable which results as the envelope of a quintic, the edge of regression is found to be the intersection of $2e^2 - 3df$, with $af^2 - 12d^2e$. And this intersection is the right line ef with a curve of the fifth order, having the point def for a triple point. For this being a double point on each surface is a quadruple point on their curve of intersection; and since the right line passes through the point def , the remaining curve has a triple point at that point.

355. We shall conclude this section by applying some of the results already obtained in it, to the solution of a problem which occasionally presents itself: "Three surfaces whose degrees are μ , ν , ρ , have a certain curve common to all three; how many of their $\mu\nu\rho$ points of intersection are absorbed by the curve? In other words, in how many points do the surfaces intersect in addition to this common curve?" Now let the first two surfaces intersect in the given curve, whose degree is m , and in a complementary curve $\mu\nu - m$, then the points of intersection not on the first curve must be included in the $(\mu\nu - m)\rho$ intersections of the latter curve with the third surface. But some of these intersections are on the curve m , since it was proved (Art. 346) that the latter curve intersects the complementary curve in $m(\mu + \nu - 2) - r$ points. Deducting this number from $(\mu\nu - m)\rho$ we find that the surfaces intersect in $\mu\nu\rho - m(\mu + \nu + \rho - 2) + r$ points which are not on the curve m ; or that the common curve absorbs $m(\mu + \nu + \rho - 2) - r$ points of intersection.

Ex. Applying this formula to the intersections of three cubics having a common curve of degree m , the number of residual points not on the curve m is $27 - 7m + r$. Now supposing the surfaces have four right lines common, this at first seems to give $m = 4$, $h = 6$, hence $r = 0$ and the number of residual points = 1. But it is easily seen that the cubic surfaces in this case have also common the two transversals of the four right lines, and these have also an apparent double point; hence, the values should have been taken $m = 6$, $h = 7$, and these give the number of remaining points of intersection = 1.

If the common curve be two conics, the line in which their planes intersect is also contained in the surfaces and thus $m = 5$, $h = 4$ give 4 remaining intersections.

In precisely the same way we solve the corresponding question if the common curve be a double curve on the surface ρ . We have then to subtract from the number $(\mu\nu - m)\rho$, $2\{m(\mu + \nu - 2) - r\}$ points, and we find that the common curve diminishes the intersections by $m(\rho + 2\mu + 2\nu - 4) - 2r$ points.

These numbers, expressed in terms of the apparent double points of the curve m , are

$$m(\mu + \nu + \rho - m - 1) + 2h \quad \text{and} \quad m(\rho + 2\mu + 2\nu - 2m - 2) + 4h.$$

356. The last article enables us to answer the question: "If the intersection of two surfaces is in part a curve of degree m , which is a double curve on one of the surfaces, in how

many points does it meet the complementary curve of intersection?" Thus, in the question last considered, the surfaces μ, ρ intersect in a double curve m and a complementary curve $\mu\rho - 2m$; and the points of intersection of the three surfaces are got by subtracting from $(\mu\rho - 2m)\nu$ the number of intersections of the double curve with the complementary. Hence

$$(\mu\rho - 2m)\nu - \iota = \mu\nu\rho - m(\rho + 2\mu + 2\nu - 4) + 2r,$$

whence

$$\iota = m(\rho + 2\mu - 4) - 2r.$$

We can verify this formula when the curve m is the complete intersection of two surfaces U, V , whose degrees are k and l . Then ρ is of the form $AU^2 + BUV + CV^2$ where A is of the degree $\rho - 2k$, &c., and μ is of the form $DU + EV$ where D is of the degree $\mu - k$. The intersections of the double curve with the complementary are the points for which one of the tangent planes to one surface at a point on the double curve coincides with the tangent plane to the other surface. They are therefore the intersections of the curve UV with the surface $AE^2 - BDE + CD^2$ which is of the degree $\rho + 2\mu - 2(k + l)$. The number of intersections is $kl\{\rho + 2\mu - 2(k + l)\}$ which coincides with the formula already obtained on putting $kl = m$, $kl(k + l - 2) = r$.

357. From the preceding article we can shew how, when two surfaces partially intersect in a curve which is a double curve on one of them, the singularities of this curve and its complementary are connected. The first equation of Art. 346 ceases to be applicable because the surface $\mu + \nu - 2$ altogether contains the double curve, but the second equation gives us

$$m'(\mu + \nu - 2) = 2\iota + r' = r' + 2m(\mu + 2\nu - 4) - 4r,$$

whence $4r - r' = (2m - m')(\mu + \nu - 2) + 2m(\nu - 2)$.

In like manner we find that the apparent double points of the two curves are connected by the relation

$$8h - 2h' = (2m - m')(\mu - 1)(\nu - 1) - 2m(\nu - 1).$$

Thus, when a quadric passes through a double line on a cubic the remaining intersection is of the fourth degree, of the sixth rank, and has three apparent double points.

SECTION III. NON-PROJECTIVE PROPERTIES OF CURVES.

358. As we shall more than once in this section have occasion to consider lines indefinitely close to each other, it is convenient to commence by shewing how some of the formulæ obtained in the first chapter are modified when the lines considered are indefinitely near. We proved (Art. 14) that the angle of inclination of two lines is given by the formula

$$\sin^2 \theta = (\cos \beta \cos \gamma' - \cos \beta' \cos \gamma)^2 + (\cos \gamma \cos \alpha' - \cos \gamma' \cos \alpha)^2 \\ + (\cos \alpha \cos \beta' - \cos \alpha' \cos \beta)^2.$$

When the lines are indefinitely near we may substitute for $\cos \alpha'$, $\cos \alpha + \delta \cos \alpha$, &c., and put $\sin \theta = \delta \theta$, when we have

$$\delta \theta^2 = (\cos \beta \delta \cos \gamma - \cos \gamma \delta \cos \beta)^2 + (\cos \gamma \delta \cos \alpha - \cos \alpha \delta \cos \gamma)^2 \\ + (\cos \alpha \delta \cos \beta - \cos \beta \delta \cos \alpha)^2.$$

If the direction-cosines of any line be $\frac{l}{r}$, $\frac{m}{r}$, $\frac{n}{r}$, where $l^2 + m^2 + n^2 = r^2$, the preceding formula gives

$$r^4 \delta \theta^2 = (m \delta n - n \delta m)^2 + (n \delta l - l \delta n)^2 + (l \delta m - m \delta l)^2.$$

Since we have

$$\cos^2 \alpha + \cos^2 \beta + \cos^2 \gamma = 1,$$

$$\cos \alpha \delta \cos \alpha + \cos \beta \delta \cos \beta + \cos \gamma \delta \cos \gamma = 0;$$

if we square the latter equation and add it to the expression for $\delta \theta^2$, we get another useful form

$$\delta \theta^2 = (\delta \cos \alpha)^2 + (\delta \cos \beta)^2 + (\delta \cos \gamma)^2.$$

It was proved (Art. 15) that $\cos \beta \cos \gamma' - \cos \beta' \cos \gamma$, &c. are proportional to the direction-cosines of the perpendicular to the plane of the two lines. It follows then, that the direction-cosines of the perpendicular to the plane of the consecutive lines just considered are proportional to $m \delta n - n \delta m$, $n \delta l - l \delta n$, $l \delta m - m \delta l$, the common divisor being $r^2 \delta \theta$.

Again, it was proved (Art. 44) that the direction-cosines of the line bisecting the external angle made with each other by two lines are proportional to

$$\cos \alpha - \cos \alpha', \cos \beta - \cos \beta', \cos \gamma - \cos \gamma', \text{ \&c.}$$

Hence, when two lines are indefinitely near, the direction-cosines of a line drawn in their plane, and perpendicular to their common direction, are proportional to $\delta \cos \alpha$, $\delta \cos \beta$, $\delta \cos \gamma$, the common divisor being $\delta \theta$.

359. We proved (Art. 317) that the direction-cosines of a tangent to a curve are $\frac{dx}{ds}$, $\frac{dy}{ds}$, $\frac{dz}{ds}$, while, if the curve be given as the intersection of two surfaces, these cosines are proportional to $MN' - M'N$, $NL' - N'L$, $LM' - L'M$, where L , M , &c. denote the first differential coefficients.

An infinity of normal lines can evidently be drawn at any point of the curve. Of these, two have been distinguished by special names; the normal which lies in the osculating plane is commonly called the *principal normal*; and the normal perpendicular to that plane, which being normal to two consecutive elements of the curve, has been called by M. Saint-Venant the *binormal*. At any point of the curve, the tangent, the principal normal, and the binormal form a system of three rectangular axes.

All the normals lie in the plane perpendicular to the tangent line, viz.

$$(x - x') dx + (y - y') dy + (z - z') dz = 0$$

in the one notation; or in the other

$$(MN' - M'N)(x - x') + (NL' - N'L)(y - y') + (LM' - L'M)(z - z') = 0.$$

360. Let us consider now the equation of the osculating plane. Since it contains two consecutive tangents of the curve, its direction-cosines (Art. 358) are proportional to

$$dyd^2z - dzd^2y, \quad dzd^2x - dxd^2z, \quad dxd^2y - dyd^2x,$$

quantities which, for brevity, we shall call X , Y , Z . The equation of the osculating plane is therefore

$$X(x - x') + Y(y - y') + Z(z - z') = 0.$$

The same equation might have been obtained (by Art. 31)

by forming the equation of the plane joining the three consecutive points

$$x'y'z'; \quad x' + dx', \quad y' + dy', \quad z' + dz';$$

$$x' + 2dx' + d^2x', \quad y' + 2dy' + d^2y', \quad z' + 2dz' + d^2z'.$$

In applying this formula, we may simplify it by taking one of the coordinates at pleasure as the independent variable, and so making d^2x , d^2y or $d^2z = 0$.

361. In order to be able to illustrate by an example the application of the formulæ of this section, it is convenient here to form the equations and state some of the properties of the *helix* or curve formed by the thread of a screw. The helix may be defined as the form assumed by a right line traced in any plane when that plane is wrapped round the surface of a right cylinder.* From this definition the equations of the helix are easily obtained. The equation of any right line $y = mx$ expresses that the ordinate is proportional to the intercept which that ordinate makes on the axis of x . If now the plane of the right line be wrapped round a right cylinder, so that the axis of x may coincide with the circular base, the right line will become a helix, and the ordinate of any point of the curve will be proportional to the intercept measured along the circle, which that ordinate makes on the circular base, counting from the point where the helix cuts the base. Thus the coordinates of the projection on the plane of the base of any point of the helix are of the form $x = a \cos \theta$, $y = a \sin \theta$, where a is the radius of the circular base. But the height z has been just proved to be proportional to the arc θ . Hence, the equations of the helix are

$$x = a \cos \frac{z}{h}, \quad y = a \sin \frac{z}{h}, \quad \text{whence also } x^2 + y^2 = a^2.$$

We plainly get the same values for x and y when the arc increases by 2π , or when z increases by $2\pi h$; hence the interval between the threads of the screw is $2\pi h$.

* Conversely, a helix becomes a right line when the cylinder on which it is traced is developed into a plane; and is, therefore, a geodesic on the cylinder (Art. 308).

Since we have

$$dx = -\frac{a}{h} \sin \frac{z}{h} dz = -\frac{y}{h} dz, \quad dy = \frac{a}{h} \cos \frac{z}{h} dz = \frac{x}{h} dz,$$

we have $ds^2 = \frac{a^2 + h^2}{h^2} dz^2$. It follows that $\frac{dz}{ds}$ is constant, or the angle made by the tangent to the helix with the axis of z (which is the direction of the generators of the cylinder) is constant. It is easy to see that this is the same as the angle made with the generators by the line into which the helix is developed when the cylinder is developed into a plane.

The length of the arc of the curve is evidently in a constant ratio to the height ascended.

The equations of the tangent are (Art. 317)

$$\frac{x - x'}{y'} = -\frac{y - y'}{x'} = -\frac{z - z'}{h}.$$

If then x and y be the coordinates of the point where the tangent pierces the plane of the base, we have from the preceding equations

$$(x - x')^2 + (y - y')^2 = (x'^2 + y'^2) \frac{z'^2}{h^2} = a^2 \frac{z'^2}{h^2},$$

or the distance between the foot of the tangent and the projection of the point of contact is equal to the arc which measures the distance along the circle of that projection from the initial point. This also can be proved geometrically, for if we imagine the cylinder developed out on the tangent plane, the helix will coincide with the tangent line, and the line joining the foot of the tangent to the projection of the point of contact will be the arc of the circle developed into a right line. Thus, then, the locus of the points where the tangent meets the base is the involute of the circle.

The equation of the normal plane is

$$y'x - x'y = h(z - z').$$

To find the equation of the osculating plane we have

$$d^2x = -\frac{1}{h^2} x dz^2, \quad d^2y = -\frac{1}{h^2} y dz^2, \quad d^2z = 0,$$

whence the equation of the osculating plane is

$$h(y'x - x'y) + a^2(z - z') = 0.$$

The form of the equation shows that the osculating plane makes a constant angle with the plane of the base.

We leave it as an exercise to the reader to find the tangent, normal plane, and osculating plane of the intersection of two central quadrics.

362. We can give the equation of the osculating plane a form more convenient in practice when the curve is defined as the intersection of two surfaces U, V . Since the osculating plane passes through the tangent line, its equation must be of the form

$$\lambda(Lx + My + Nz + Pw) = \mu(L'x + M'y + N'z + P'w),$$

where $Lx + \&c.$ is the tangent plane to the first surface, $L'x + \&c.$ to the second. This equation is identically satisfied by the coordinates of a point common to the two surfaces, and by those of a consecutive point; and, on substituting the coordinates of a second consecutive point, we get

$$\mu = Ld^2x + Md^2y + Nd^2z + Pd^2w, \quad \lambda = L'd^2x + M'd^2y + N'd^2z + P'd^2w.$$

But differentiating the equation

$$Ldx + Mdy + Ndz + Pdw = 0,$$

we get $Ld^2x + Md^2y + Nd^2z + Pd^2w = -U'$,

where $U' = adx^2 + bdy^2 + cdz^2 + ddw^2$

$$+ 2fdydz + 2gdzdx + 2hdx dy + 2ldxdw + 2mdydw + 2ndzdw,$$

where $a, b, \&c.$ are the second differential coefficients. Now $dx, \&c.$ satisfy the equations

$$Ldx + Mdy + Ndz + Pdw = 0, \quad L'dx + M'dy + N'dz + P'dw = 0;$$

and since we may either, as in ordinary Cartesian equations, take w as constant; or else x , or y , or z ; or, more generally, must take some linear function of these coordinates as constant; we may therefore combine with the two preceding equations the arbitrary equation

$$\alpha dx + \beta dy + \gamma dz + \delta dw = 0.$$

Now it can easily be verified that if we substitute in the equation of any quadric, the coordinates of the intersection of three planes

$Lx + My + Nz + Pw$, $L'x + M'y + N'z + P'w$, $\alpha x + \beta y + \gamma z + \delta w$,
the result U' will be proportional to the determinant (cf. p. 59)

$$\begin{vmatrix} a, & h, & g, & l, & L, & L', & \alpha \\ h, & b, & f, & m, & M, & M', & \beta \\ g, & f, & c, & n, & N, & N', & \gamma \\ l, & m, & n, & d, & P, & P', & \delta \\ L, & M, & N, & P & & & \\ L', & M', & N', & P' & & & \\ \alpha, & \beta, & \gamma, & \delta & & & \end{vmatrix}.$$

This determinant may be reduced by subtracting from the fifth column multiplied by $(m-1)$ the sum of the first four columns, multiplied respectively by x, y, z, w ; when the whole of the fifth column vanishes, except the last row, which becomes $-(\alpha x + \beta y + \gamma z + \delta w)$. In like manner we may then subtract from the fifth row, multiplied by $(m-1)$, the sum of the first four rows multiplied respectively by x, y, z, w , when, in like manner, the whole of the fifth row vanishes, except the last column, which is $-(\alpha x + \beta y + \gamma z + \delta w)$. Thus the determinant

reduces to $\frac{(\alpha x + \beta y + \gamma z + \delta w)^2}{(m-1)^2}$

$$\begin{vmatrix} a, & h, & g, & l, & L' \\ h, & b, & f, & m, & M' \\ g, & f, & c, & n, & N' \\ l, & m, & n, & d, & P' \\ L', & M', & N', & P' & \end{vmatrix}.$$

If we call the determinant last written S , and the corresponding determinant for the other equation S' , the equation of the osculating plane is

$$\frac{S'}{(n-1)^2} (Lx + My + Nz + Pw) = \frac{S}{(m-1)^2} (L'x + M'y + N'z + P'w).*$$

* This equation is due to Dr. Hesse, see Crelle's *Journal*, vol. XLI.

This equation has been verified in the case of two quadrics, see note, p. 191.

Ex. 1. To find the osculating plane of

$$ax^2 + by^2 + cz^2 + dw^2, \quad a'x^2 + b'y^2 + c'z^2 + d'w^2.$$

Ans. $(ab' - ba')(ac' - ca')(ad' - da')x^3x + (ba' - b'a)(bc' - b'c)(bd' - b'd)y^3y$
 $+ (ca' - c'a)(cb' - c'b)(cd' - c'd)z^3z + (da' - d'a)(db' - d'b)(dc' - d'c)w^3w = 0.$

Ex. 2. To find the osculating plane of the line of curvature

$$\frac{x^2}{a^2} + \frac{y^2}{b^2} + \frac{z^2}{c^2} = 1, \quad \frac{x^2}{a'^2} + \frac{y^2}{b'^2} + \frac{z^2}{c'^2} = 1.$$

Ans. $\frac{a''^2xx'}{a^2a'^2} + \frac{b''^2yy'}{b^2b'^2} + \frac{c''^2zz'}{c^2c'^2} = 1.$

363. The condition that four points should lie in one plane, or, in other words, that a point on the curve should be the point of contact of a stationary plane, is got by substituting in the equation of the plane through three consecutive points, the coordinates of a fourth consecutive point. Thus, from the equation of Art. 31, the condition required is the determinant

$$d^3x(dydz^2 - dzd^2y) + d^3y(dzd^2x - dx d^2z) + d^3z(dxd^2y - dyd^2x) = 0.$$

If a curve in space be a plane curve, this condition must be fulfilled by the coordinates of every point of it.

For a curve given as the intersection of two surfaces U, V , Clebsch determined as follows (see *Crelle*, LXIII. 1) the condition for a point of osculation. Writing for brevity $S = (m - 1)^2 T, S' = (n - 1)^2 T'$, the equation given in the last article for the osculating plane is

$$(T'L - TL')x + (T'M - TM')y + (T'N - TN')z + (T'P - TP')w = 0,$$

and the equation of a consecutive osculating plane differs from this by terms

$$(T'dL + LdT' - TdL' - L'dT)x + \&c. = 0.$$

Thus, in order that the two planes may coincide, introducing an arbitrary differential dt , we must have the four equations

$$T'dL + LdT' - TdL' - L'dT = (T'L - TL')dt, \&c.$$

If, now, we write

$$T = AL' + BM' + CN' + DP', \quad T' = A'L + B'M + C'N + D'P,$$

where $A, B, \&c.$ are proportional to minors of the determinant S , and where in fact

$$A = \frac{1}{2} \frac{dT}{dL'}, \quad B = \frac{1}{2} \frac{dT}{dM'}, \quad \&c.,$$

we must have

$$AL + BM + CN + DP = 0, \quad AdL + BdM + CdN + DdP = 0, \\ A'L' + \&c. = 0, \quad A'dL' + \&c. = 0;$$

for, if in the determinant S we substitute for the last column either L, M, N, P , or dL, dM, dN, dP , it is easy to see that the determinant vanishes. Multiply then the four equations last considered by A, B, C, D respectively, and add, and we have, after dividing by T ,

$$dT + \frac{1}{2} \left(\frac{dT}{dL'} dL' + \frac{dT}{dM'} dM' + \frac{dT}{dN'} dN' + \frac{dT}{dP'} dP' \right) = Tdt,$$

which we may write

$$dT + \frac{1}{2} d(T) = Tdt,$$

where by $d(T)$ we mean the differential of T considered merely as a function of L', M', N', P' ; $\alpha, \beta, \&c.$ being regarded as constants. Similarly we have $dT' + \frac{1}{2} d(T') = T'dt$. Let us now write at full length for $dT, T_1 dx + T_2 dy + \&c.$; and eliminating dx, dy, dz, dw, dt between the two equations just obtained, and the three conditions which connect dx, dy, dz, dw , we obtain the required condition in the form of a determinant

$$\begin{vmatrix} T_1 + \frac{1}{2}(T_1), & T_2 + \frac{1}{2}(T_2), & T_3 + \frac{1}{2}(T_3), & T_4 + \frac{1}{2}(T_4), & T \\ T'_1 + \frac{1}{2}(T'_1), & T'_2 + \frac{1}{2}(T'_2), & T'_3 + \frac{1}{2}(T'_3), & T'_4 + \frac{1}{2}(T'_4), & T' \\ L, & M, & N, & P, & 0 \\ L', & M', & N', & P', & 0 \\ \alpha, & \beta, & \gamma, & \delta, & 0 \end{vmatrix} = 0.$$

Now T is a function of x, y, z, w of the degree $3m + 2n - 8$, but when regard is paid only to the $xyzw$, which enter into $L', M', \&c.$, (T) is of the degree $2(n - 1)$; if, therefore, we multiply the first four columns by x, y, z, w respectively, and subtract them from $3(m + n - 3)$ times the last column, the first four terms of the last column vanish, and the equation just

written may be reduced by cancelling the fifth row and column of the determinant. The condition that we have just obtained is of the degree $6m + 6n - 20$ in the variables as might be inferred from the value of α , Art. 342. If the surfaces U and V are quadrics, and therefore the coefficients $a, b, \&c.$ really constant, $(T_1), (T_2), \&c.$ are identical with $T_1, T_2, \&c.$, and the condition that we have obtained is the result of equating to zero the Jacobian of the four surfaces T, T', U, V .

364. We shall next consider the circle determined by three consecutive points of the curve, which, as in plane curves, is called the circle of curvature. It obviously lies in the osculating plane: its centre is the intersection of the traces on that plane, by two consecutive normal planes; and its radius is commonly called the radius of *absolute* curvature, to distinguish it from the radius of *spherical* curvature, which is the radius of the sphere determined by four consecutive points on the curve, and which will be investigated presently. If through the centre of a circle a line be drawn perpendicular to its plane, any point on this line is equidistant from all the points of the circle, and may be called a pole of the circle. Now the intersection of two consecutive normal planes evidently passes through the centre of the circle of curvature, and is perpendicular to its plane. Monge has therefore called the lines of intersection of pairs of consecutive normal planes the *polar* lines of the curve. It is evident that all the normal planes envelope a developable of which these polar lines are the generators, and which accordingly has been called the *polar developable* surface. We shall presently state some properties of this surface. The polar line is evidently parallel to the line called the Binormal (Art. 359).

365. In order to obtain the radius of curvature, we shall first calculate the *angle of contact*, that is to say, the angle made with each other by two consecutive tangents to the curve. The direction-cosines of the tangent being $\frac{dx}{ds}, \frac{dy}{ds}, \frac{dz}{ds}$,

it follows, from Art. 358, that $d\theta$, the angle between two consecutive tangents, is given by either of the formulæ

$$d\theta^2 = \left(d \frac{dx}{ds}\right)^2 + \left(d \frac{dy}{ds}\right)^2 + \left(d \frac{dz}{ds}\right)^2,*$$

or

$$ds^4 d\theta^2 = X^2 + Y^2 + Z^2,$$

where

$$X = dyd^2z - dzd^2y, \text{ \&c.}$$

The truth of the latter formula may be seen geometrically; for the right-hand side of the equation denotes the square of double the triangle formed by three consecutive points (Art. 32); but two sides of this triangle are each ds , and the angle between them is $d\theta$, hence double the area is $ds^2 d\theta$.

If now ds be the element of the arc, the tangents at the extremities of which make with each other the angle $d\theta$, then since the angle made with each other by two tangents to a circle is equal to the angle that their points of contact subtend at its centre, we have $\rho d\theta = ds$. And the element of the arc and the two tangents being common to the curve and the circle of curvature, the radius of curvature is given by the formula

$$\rho = \frac{ds}{d\theta}; \text{ whence } \rho^2 = \frac{ds^2}{\left(d \frac{dx}{ds}\right)^2 + \left(d \frac{dy}{ds}\right)^2 + \left(d \frac{dz}{ds}\right)^2};$$

or

$$\rho^2 = \frac{ds^6}{X^2 + Y^2 + Z^2}.$$

Ex. To find the radius of curvature of the helix. Using the formulæ of Art. 361, we find $\rho = \frac{a^2 + h^2}{a}$; or the radius of curvature is constant.

* By performing the differentiations indicated, another value for $d\theta^2$ is found without difficulty,

$$ds^2 d\theta^2 = (d^2x)^2 + (d^2y)^2 + (d^2z)^2 - (d^2s)^2.$$

This formula may also be proved geometrically. Let AB, BC be two consecutive elements of the curve; AD a line parallel and equal to BC ; then since the projections of BC on the axes are $dx + d^2x, dy + d^2y, dz + d^2z$, it is plain that the projections on the axes of the diagonal BD are d^2x, d^2y, d^2z , whence $BD^2 = (d^2x)^2 + (d^2y)^2 + (d^2z)^2$. But BD projected on the element of the arc is d^2s , and on a line perpendicular to it is $ds d\theta$; whence

$$(d^2s)^2 + (ds d\theta)^2 = (d^2x)^2 + (d^2y)^2 + (d^2z)^2.$$

366. Having thus determined the magnitude of the radius of curvature, we are enabled by the formulæ of Art. 358 also to determine its position. For the direction-cosines of a line drawn in the plane of two consecutive tangents, and perpendicular to their common direction, are, by that article,

$$\frac{1}{d\theta} d \frac{dx}{ds}, \frac{1}{d\theta} d \frac{dy}{ds}, \frac{1}{d\theta} d \frac{dz}{ds}; \text{ or } \rho \frac{d \frac{dx}{ds}}{ds}, \rho \frac{d \frac{dy}{ds}}{ds}, \rho \frac{d \frac{dz}{ds}}{ds}.$$

If x', y', z' be the coordinates of a point on the curve, and x, y, z those of the centre of curvature, then the projections of the radius of curvature on the axes are $x' - x, y' - y, z' - z$; but they are also $\rho \cos \alpha, \rho \cos \beta, \rho \cos \gamma$. Putting in then for $\cos \alpha, \cos \beta, \cos \gamma$ their values just found, the coordinates of the centre of curvature are determined by the equations

$$x' - x = \rho^2 \frac{d \frac{dx}{ds}}{ds}, \quad y' - y = \rho^2 \frac{d \frac{dy}{ds}}{ds}, \quad z' - z = \rho^2 \frac{d \frac{dz}{ds}}{ds}.$$

367. When a curve is given as the intersection of two surfaces which cut at right angles, an expression for the radius of curvature can be easily obtained. Let r and r' be the radii of curvature of the normal sections of the two surfaces, the sections being made along the tangent to the curve; and let ϕ be the angle which the osculating plane makes with the first normal plane: then, by Meunier's theorem, we have

$$\rho = r \cos \phi, \text{ and also } \rho = r' \sin \phi, \text{ whence } \frac{1}{\rho^2} = \frac{1}{r^2} + \frac{1}{r'^2}.$$

The same equations determine the osculating plane by the formula $\tan \phi = \frac{r}{r'}$.

If the angle which the surfaces make with each other be ω , the corresponding formula is

$$\frac{\sin^2 \omega}{\rho^2} = \frac{1}{r^2} + \frac{1}{r'^2} - \frac{2 \cos \omega}{rr'}.$$

We can hence obtain an expression for the radius of curvature of a curve given as the intersection of two surfaces.

We may write $L^2 + M^2 + N^2 = R^2$, $L'^2 + M'^2 + N'^2 = R'^2$; and we have

$$\cos \omega = \frac{LL' + MM' + NN'}{RR'}$$

$$\sin^2 \omega = \frac{(MN' - M'N)^2 + (NL' - N'L)^2 + (LM' - L'M)^2}{R^2 R'^2}$$

We must then substitute in the formula of Art. 296,

$$\cos \alpha = \frac{MN' - M'N}{RR' \sin \omega}, \quad \cos \beta = \frac{NL' - N'L}{RR' \sin \omega}, \quad \cos \gamma = \frac{LM' - L'M}{RR' \sin \omega}$$

The denominator of that formula becomes

$$\begin{vmatrix} a, & h, & g, & L, & L' \\ h, & b, & f, & M, & M' \\ g, & f, & c, & N, & N' \\ L, & M, & N, & & \\ L', & M', & N' & & \end{vmatrix}$$

which reduced, as in Art. 362, becomes $\frac{1}{(m-1)^2} S$: giving

$$r = \frac{(m-1)^2 R^3 R'^2 \sin^2 \omega}{S}, \quad \text{similarly } r' = \frac{(n-1)^2 R^2 R'^3 \sin^2 \omega}{S'}$$

Whence $\frac{1}{\rho^2} = \frac{S^2}{(m-1)^4 R^6 R'^4 \sin^6 \omega}$

$$+ \frac{S'^2}{(n-1)^4 R^4 R'^6 \sin^6 \omega} - \frac{2SS' \cos \omega}{(m-1)^2 (n-1)^2 R^5 R'^5 \sin^6 \omega}$$

In the notation of Art. 363 this may be written

$$\frac{R^4 R'^4 \sin^6 \omega}{\rho^2} = \frac{T^2}{R^2} + \frac{T'^2}{R'^2} - \frac{2TT' \cos \omega}{RR'}$$

368. Let us now consider the angle made with each other by two consecutive osculating planes, which we shall call the *angle of torsion*, and denote by $d\eta$. The direction-cosines of the osculating plane being proportional to X, Y, Z , the second formula of Art. 358 gives

$$(X^2 + Y^2 + Z^2)^2 d\eta^2 = (YdZ - ZdY)^2 + (ZdX - XdZ)^2 + (XdY - YdX)^2$$

Now $Y = dzd^2x - dx d^2z, \quad Z = dxd^2y - dy d^2x,$
 $dY = dzd^3x - dx d^3z, \quad dZ = dxd^3y - dy d^3x.$

Therefore (*Lessons on Higher Algebra*, Art. 31)

$$YdZ - ZdY = Mdx,$$

where M is the determinant

$$Xd^3x + Yd^3y + Zd^3z.$$

Hence $(X^2 + Y^2 + Z^2)^2 d\eta^2 = M^2 ds^2$,

$$d\eta = \frac{Mds}{X^2 + Y^2 + Z^2}.$$

This formula may be also proved geometrically. For M denotes six times the volume of the pyramid made by four consecutive points, while $X^2 + Y^2 + Z^2$ denotes four times the square of the area of the triangle formed by three consecutive points. Now if A be the triangular base of a pyramid, A' an adjacent face making an angle η with the base, s the side common to the two faces, and p the perpendicular from the vertex on s , so that $2A' = sp$, then for the volume of the pyramid we have $3V = Ap \sin \eta$ and $6Vs = 2Aps \sin \eta = 4AA' \sin \eta$. Now, in the case considered, the common side is ds , and in the limit $A = A'$; hence $6Vds = 4A^2 d\eta$. Q.E.D.

Following the analogy of the radius of curvature which is $\frac{ds}{d\theta}$, the later French writers denote the quantity* $\frac{ds}{d\eta}$ by the letter r , and call it the *radius of torsion*; but the reader will observe that this is not, like the radius of curvature, the radius of a real circle intimately connected with the curve.

369. In the same manner, however, as we have considered an osculating circle determined by three consecutive points of the system, we may consider an osculating right cone determined by three consecutive planes of the system, and we proceed to determine its vertical angle. Imagine that a sphere is described having as centre the point of the system in which the three planes intersect; let the lines of the system passing through that point meet the sphere in A and B ; and let the corresponding planes meet the same sphere in AT , BT ; then, if we describe a small circle of the same sphere

* The quantity $\frac{d\eta}{ds}$ is also sometimes called the "second curvature" of the curve.

touching AT , BT , and escribed to AB , the cone whose vertex is the centre, and which stands on that small circle, will evidently osculate the given curve. The problem then is, being given $d\eta$ the angle between two consecutive tangents to a small circle of a sphere, and $d\theta$ the corresponding arc of the circle to find H its radius.

Let ϕ be the external angle between two tangents to a circle, s the length of the two tangents, then H the radius of the circle is given by the formula $\tan \frac{1}{2}\phi \tan H = \sin \frac{1}{2}s$. Now, taking C the centre of the small circle and t the foot of the perpendicular from it on AB , we have $\tan \frac{1}{2}\phi \tan H = \sin At$, and $\tan \frac{1}{2}\phi' \tan H = \sin Bt$, where in the limit ϕ' differs by an infinitely small quantity from ϕ .

Now, since also in the limit AB measures the angle between consecutive lines of the system and ϕ measures that between consecutive planes of the system, we have then

$$\tan H = \frac{d\theta}{d\eta} = \frac{r}{\rho}.*$$

370. Imagine that through every line of the system there is drawn a plane perpendicular to the corresponding osculating plane, this is called a *rectifying plane*, and the assemblage of these planes generates a developable which is called the *rectifying developable*. The reason of the name is, that the given curve is obviously a geodesic on this developable, since its osculating plane is, by construction, everywhere normal to the surface. If, therefore, the developable be developed into a plane, the given curve will become a right line.

The intersection of two consecutive planes of the rectifying developable is the *rectifying line*. Now, since the plane passing through the edge of a right cone perpendicular to its tangent plane passes through its axis, it follows that the rectifying plane passes through the axis of the osculating cone considered in the last article; and, therefore, that *the rectifying line is the axis of that osculating cone*. The rectifying line may be

* It has been proved by M. Bertrand that when the ratio $r : \rho$ is constant, the curve must be a helix traced on a cylinder; and by Puiseux, that when r and ρ are both constant, the cylinder has a circular base, Liouville's *Monge*, p. 554.

therefore constructed by drawing in the rectifying plane a line making with the tangent line an angle H , where H has the value determined in the last article.

The rectifying surface is the surface of centres of the original developable formed by the lines of the system. In fact it was proved (Art. 306) that the normal planes to a surface along the two principal tangents touch the surface of centres; but the generating line itself is in every point of it one of the principal tangents; the rectifying plane, therefore, touches the surface of centres which is the envelope of all these rectifying planes. The centre of curvature at any point on a developable of the other principal section, namely, that perpendicular to the generating line, is the point where its plane meets the corresponding rectifying line; for evidently the traces on this plane of two consecutive rectifying planes are two consecutive normals to the section. Hence if l be the distance of any point on the developable from the cuspidal edge measured along the generator, the radius of curvature of the transverse section is $l \tan H$. When l vanishes, this radius of curvature vanishes, as it ought, the point being a cusp.

In the case of the helix the rectifying surface is obviously the cylinder on which the curve is traced.

371. *To find the angle between two successive radii of curvature.**

Let AB, BC be traces on any sphere with radius unity, of planes parallel to the osculating and normal planes, then the central radius to B is the direction of the radius of curvature. If $AB', B'C$ be consecutive positions of the osculating and normal planes, B' is in the direction of the consecutive radius of curvature, and BB' measures the angle between them. Now the triangle BOB' being a very small right-angled triangle, we have $BB'^2 = BO^2 + OB'^2$.

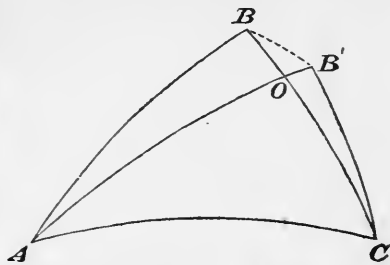

* The reader will find simple geometrical investigations of this and other formulæ connected with curves of double curvature in a paper by Mr. Routh, *Quarterly Journal of Mathematics*, vol. VII. p. 37.

But since the angle ABC is right, BO measures BAB' , which is $d\eta$, the angle between two consecutive osculating planes, and OB' measures OCB' , which is $d\theta$, the angle between two consecutive normal planes. The required angle is therefore given by the formula $BB'' = d\eta^2 + d\theta^2$, where $d\eta$ and $d\theta$ have the values already found. The series of radii of curvature at all the points of a curve generate a surface on the properties of which we have not space to dwell. It is evidently a skew surface (see note, p. 89), since two consecutive radii do not in general intersect (see Art. 374, *infra*).

Ex. 1. To find the equation of the surface of the radii of curvature in the case of the helix.

The radius of curvature being the intersection of the osculating and normal planes has for its equations (Art. 361) $x'y = y'x$, $z = z'$, from which we are to eliminate $x'y/z'$ by the help of the equations of the curve. And writing the equations of the helix $x = a \cos nz$, $y = a \sin nz$, the required surface is $y \cos nz = x \sin nz$.

Ex. 2. To find the equation of the developable generated by the tangents of a helix. The equations of the tangent being

$$x - a \cos nz' = -na \sin nz' (z - z'), \quad y - a \sin nz' = na \cos nz' (z - z'),$$

the result of eliminating z' is found to be

$$x \cos \left\{ nz \pm \frac{(x^2 + y^2 - a^2)^{\frac{1}{2}}}{a} \right\} + y \sin \left\{ nz \pm \frac{(x^2 + y^2 - a^2)^{\frac{1}{2}}}{a} \right\} = a.$$

Since this equation becomes impossible when $x^2 + y^2 < a^2$, it is plain that no part of the surface lies within the cylinder on which the helix is traced.

372. We shall now speak of the *polar developable* generated by the normal planes to the given curve. Fourier has remarked, that the "angle of torsion" of the one system is equal to the "angle of contact" of the other, as is sufficiently obvious since the planes of this new system are perpendicular to the lines of the original system, and *vice versâ*. The reader will bear in mind, however, that it does not follow from this that the $\frac{d\theta}{ds}$ of one system is equal to the $\frac{d\eta}{ds}$ of the other, because the ds is not the same for both.

Since the intersection of the normal planes at two consecutive points K , K' of the curve is the axis of a circle of which K and K' are points (Art. 364), it follows that if any point D on that line be joined to K and K' , the joining lines are equal and make equal angles with that axis.

It is plain that three consecutive normal planes intersect in the centre of the osculating sphere; hence *the cuspidal edge of the polar developable is the locus of centres of spherical curvature.*

In the case of a plane curve this polar developable reduces to a cylinder standing on the evolute of the curve.

373. *Every curve has an infinity of evolutes lying on the polar developable;** that is to say, the given curve may be generated in an infinity of ways by the unrolling of a string wound round a curve traced on that developable. Let MM' , $M'M''$, &c. denote the successive elements of the curve, K , K' , &c. the middle points of these elements, then the planes drawn through the points K perpendicular to the elements are the normal planes. The lines AB , $A'B'$, &c. being the lines in which each normal plane is intersected by the consecutive, these lines are the generators of the polar developable, and

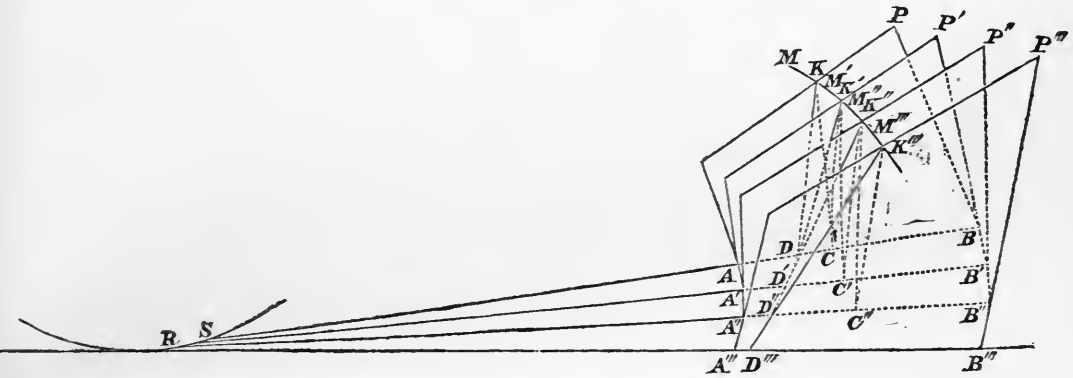

hence tangents to the cuspidal edge RS of that surface. Draw now at pleasure† any line KD in the first normal plane, meeting the first generator in D ; join DK' which being in the second normal plane will meet the second generator $A'B'$, say in D' . In like manner, let $K''D'$ meet $A''B''$ in D'' . We get thus a curve $DD'D''$ traced on the polar developable which is an evolute of the given curve. For the lines DK , $D'K'$, &c. the tangents to the curve $DD'D''$, are normals to the curve

* See Monge, p. 396.

† This figure is taken from Leroy's *Geometry of Three Dimensions*.

$KK'K''$, and the lengths $DK = DK'$, $D'K' = D'K''$, &c. (see Art. 372). If therefore DK be a part of a thread wound round $DD'D''$, it is plain that as the thread is unwound the point K will move along the given curve.

Since the first line DK was arbitrary, the curve has an infinity of evolutes. A plane curve has thus an infinity of evolutes lying on the cylinder whose base is the evolute in the plane of the curve. For example, in the special case where this evolute reduces to a point; that is, when the curve is a circle, the circle can be described by moving round a thread of constant length fastened to any point on the axis passing through the centre of the circle

In the general case, *all the evolute curves $DD'D''$, &c. are geodesics on the polar developable.*

For we have seen (Art. 308) that a curve is a geodesic when two successive tangents to it make equal angles with the intersection of the corresponding tangent planes of the surface; and it has just been proved (Art. 372), that DK, DK' , which are two successive tangents to the evolute, make equal angles with AB which is the intersection of two consecutive tangent planes of the developable. An evolute may then be found by drawing a thread as tangent from K to the polar developable, and winding the continuation of that tangent freely round the developable.

374. The locus of centres of curvature is a curve on the polar developable, but generally is *not* one of the system of evolutes. Let the first osculating plane $MM'M''$ meet the first two normal planes in $KC, K'C$, then C is the first centre of curvature; and, in like manner, the second centre is C' , the point of intersection of $K'C', K''C'$, the lines in which the second osculating plane $M'M''M'''$ is met by the second and third normal planes. Now the radii $K'C, K'C'$ are distinct, since they are the intersections of the same normal plane by two different osculating planes, $K'C'$ will therefore meet the line AB in a point I which is distinct from C . Consequently, the two radii of curvature $KC, K'C'$ situated in the planes P, P' have no common point in AB the intersection of these planes; two

consecutive radii therefore do not intersect, unless in the case where two consecutive osculating planes coincide.

The centres of curvature then not being given by the successive intersections of consecutive radii, these radii are not tangents to the locus of centres. Any radius therefore KC would not be the continuation of a thread wound round $CC'C''$, and the unwinding of such a thread would not give the curve $KK'K''$, except in the case where the latter is a plane curve.*

375. *To find the radius of the sphere through four consecutive points.* Let R be the radius of any sphere, ρ the radius of a section by a plane making an angle η with the normal plane at any point; then, by Meunier's theorem, $R \cos \eta = \rho$; and for a consecutive plane making an angle $\eta + \delta\eta$, we have $\delta\rho = -R \sin \eta \delta\eta$. Hence $R^2 = \rho^2 + \left(\frac{d\rho}{d\eta}\right)^2$.

We have then only to give in this expression to ρ and $d\eta$ the values already found.

$\frac{d\rho}{d\eta}$ is obviously the length of the perpendicular distance from the centre of the sphere to the plane of the circle of curvature.

376. *To find the coordinates of the centre of the osculating sphere.*

Let the equation of any normal plane be

$$(\alpha - x) dx + (\beta - y) dy + (\gamma - z) dz = 0,$$

where xyz is the point on the curve, and $\alpha\beta\gamma$ any point on

* The characteristics of the polar developable may be investigated by arguments similar to those used *Higher Plane Curves*, Arts. 111, &c. They are $n' = m + r$, $\alpha' = 0$, $r' = 3m + n$, $m' = 5m + \alpha$, where m , n , &c., having the same meaning as in Art. 325, are the characteristics of the given curve, and m' , n' , &c. the corresponding characteristics of the polar developable. When, as is here supposed, there is nothing special in the character of the points at infinity of the given curve, the normal planes corresponding to these points are altogether at infinity; and the corresponding generators of the polar developable are common to three consecutive planes. The plane at infinity meets the polar developables in m lines, each reckoned three times, and a curve of the n^{th} order.

the plane; then the equation of a consecutive normal plane combined with the preceding gives

$$(\alpha - x) d^2x + (\beta - y) d^2y + (\gamma - z) d^2z = ds^2.$$

And the equation of the third plane gives

$$(\alpha - x) d^3x + (\beta - y) d^3y + (\gamma - z) d^3z = 3dsd^2s.$$

Let us denote, as before, $dyd^2z - dzd^2y$, &c. by X, Y, Z ; $dyd^3z - dzd^3y$, &c. by X', Y', Z' , and the determinant $Xd^3x + Yd^3y + Zd^3z$ by M . Then, solving the preceding equations, we have

$$M(\alpha - x) = -X'ds^2 + 3Xd^2s, \quad M(\beta - y) = -Y'ds^2 + 3Yd^2s, \\ M(\gamma - z) = -Z'ds^2 + 3Zd^2s.$$

By squaring and adding these equations, we obtain another expression for R^2 , which is what the value in the last article becomes when for ρ and $\frac{d\rho}{d\eta}$ we substitute their values.

We add a few other expressions, the greater part of which admit of simple geometrical proofs, the details of which want of space obliges us to omit.

Ex. 1. If σ be the arc of the curve which is the locus of centres of absolute curvature,

$$d\sigma^2 = d\rho^2 + \rho^2 d\eta^2; \text{ or } d\sigma = R d\eta.$$

Ex. 2. If Σ be the length of the arc of the locus of centres of spherical curvature $d\Sigma = \frac{RdR}{\delta}$; where $\delta = \frac{d\rho}{d\eta}$ is the distance between the centres of the osculating circle and osculating sphere. From this expression we immediately get values for the radii of curvature and of torsion of this locus, remembering that the angle of torsion is the angle of contact of the original, and vice versâ.

Ex. 3. The angle between two consecutive rectifying lines is dH .

Ex. 4. The angle ψ between two consecutive R 's is given by the formula

$$R^2\psi^2 = ds^2 + d\Sigma^2 - dR^2.*$$

* The reader will find further details on the subjects treated of in this section in a Memoir by M. de Saint-Venant, *Journal de l'Ecole Polytechnique*, Cahier xxx., who has also collected into a table about a hundred formulæ for the transformation and reduction of calculations relative to the theory of non-plane curves; and in a paper by M. Frenet, *Liouville*, vol. xvii., p. 437. I abridge the following historical sketch from M. de Saint-Venant's Memoir: "Curve lines not contained in the same plane have been successively studied by Clairaut (*Recherches sur les courbes à double courbure*, 1731), who has brought into use the title by which they have been commonly known (previously, however, employed by Pitot) and who has given expressions for the projections of these curves, for their tangents, normals, arc, &c.; by Monge (*Mémoire sur les développées*, &c. presented in 1771, and inserted in vol. x., 1785, of the '*Savants étrangers*,' as well as in his '*Application de l'Analyse à la Géométrie*)

SECTION IV. CURVES TRACED ON SURFACES.

377. The coordinates x, y, z of a point on a surface may be expressed as functions of two parameters p, q ; and conversely if the coordinates x, y, z are thus expressed as functions of two parameters, these expressions determine the surface, for by the elimination of the parameters we obtain between the coordinates x, y, z the equation $U=0$ of the surface; and when a definite value is assigned to either p or q , the point xyz is restricted to a definite curve on the surface. This mode of representation of a surface is, peculiarly appropriate for the discussion of the theory of curvature, and it has been used for that purpose by Gauss.* We proceed to give an account of his investigations, but before doing so must explain his notation and establish the connexion of this method with that by which curvature was treated in Chapter XI. We have x, y, z given functions of p, q ; and the partial differential coefficients of x, y, z in regard to these variables are expressed as follows:

$$\begin{aligned} dx &= adp + a'dq, & dy &= bdp + b'dq, & dz &= cdp + c'dq, \\ d^2x &= \alpha dp^2 + 2\alpha' dpdq + \alpha'' dq^2, \\ d^2y &= \beta dp^2 + 2\beta' dpdq + \beta'' dq^2, \\ d^2z &= \gamma dp^2 + 2\gamma' dpdq + \gamma'' dq^2. \end{aligned}$$

who gave expressions for the normal plane, centre and radius of curvature, evolutes, polar lines and polar developable, centre of osculating sphere, for the criterion for 'points of simple inflexion' where four consecutive points are in a plane, and for 'points of double inflexion' where three consecutive points are in a right line; by Tinseau (*Solution de quelques problèmes, &c.* presented in 1774, *Savants étrangers*, vol. IX., 1780) who was the first to consider the osculating plane and the developable generated by the tangents; by Lacroix (*Calcul Différentiel*) who was the first to render the formulæ symmetrical by introducing the differentials of the three coordinates; and by Lancret (*Mémoire sur les courbes à double courbure*, read 1802, and inserted vol. I., 1805, of *Savants étrangers de l'Institut*) who calculated the angle of torsion, and introduced the consideration of the rectifying lines and rectifying surface." The reader will find some interesting and novel researches respecting curves of double curvature in Sir Wm. Hamilton's *Elements of Quaternions*; as, for instance, the theory of the osculating twisted cubic which passes through six consecutive points of the curve.

* See his Memoir "Disquisitiones circa superficies curvas," *Comm. Gott. recent.*, t. VI. (1827), reprinted in the appendix to Liouville's Edition of Monge, and in his Works, IV. p. 219.

Gauss also writes

$$bc' - cb' = A, \quad ca' - ac' = B, \quad ab' - ba' = C,$$

$$a^2 + b^2 + c^2 = E, \quad aa' + bb' + cc' = F, \quad a'^2 + b'^2 + c'^2 = G,$$

which obviously lead to the relation $A^2 + B^2 + C^2 = EG - F^2$; and to these notations it is convenient to join $V^2 = EG - F^2$, $A\alpha + B\beta + C\gamma = E'$, $A\alpha' + B\beta' + C\gamma' = F'$, $A\alpha'' + B\beta'' + C\gamma'' = G'$, E' , F' , G' denoting respectively the determinants

$$\begin{vmatrix} a, & b, & c \\ a', & b', & c' \\ \alpha, & \beta, & \gamma \end{vmatrix}, \quad \begin{vmatrix} a, & b, & c \\ a', & b', & c' \\ \alpha', & \beta', & \gamma' \end{vmatrix}, \quad \begin{vmatrix} a, & b, & c \\ a', & b', & c' \\ a'', & \beta'', & \gamma'' \end{vmatrix}.$$

The identity $A dx + B dy + C dz = 0$,

replaces the differential equation of the surface, or what is the same thing, if $U = f(x, y, z) = 0$ is the equation of the surface, then A, B, C are proportional to $\frac{dU}{dx}, \frac{dU}{dy}, \frac{dU}{dz}$.

Again, since the coordinates are rectangular, if ds be an element of length on the surface, that is, if it be the distance between the points (p, q) and $(p + dp, q + dq)$, then

$$ds^2 = E dp^2 + 2F dp dq + G dq^2.$$

378. The differential equation Art. 303 of the lines of curvature may be written

$$\begin{vmatrix} dx, & dy, & dz \\ A, & B, & C \\ dA, & dB, & dC \end{vmatrix} = 0.$$

Repeating the investigation which led to this equation, we have for the coordinates of an indeterminate point on the normal

$$\xi = x + A\lambda, \quad \eta = y + B\lambda, \quad \zeta = z + C\lambda,$$

and if this meets the consecutive normal, then taking ξ, η, ζ to be the coordinates of the point of intersection, we have

$0 = dx + A d\lambda + \lambda dA$, $0 = dy + B d\lambda + \lambda dB$, $0 = dz + C d\lambda + \lambda dC$, which equations, by eliminating λ and $d\lambda$, give the equation in question.

Now this equation may be written (*Higher Algebra*, Art. 24)

$$\begin{vmatrix} adx + bdy + cdz, & a'dx + b'dy + c'dz \\ adA + bdB + cdC, & a'dA + b'dB + c'dC \end{vmatrix} = 0,$$

since it is what is denoted by

$$\left\| \begin{matrix} a, & b, & c \\ a', & b', & c' \end{matrix} \right\| \cdot \left\| \begin{matrix} dx, & dy, & dz \\ dA, & dB, & dC \end{matrix} \right\| = 0.$$

Calculating the quantity $adx + bdy + cdz$, by substituting for dx , $adp + a'dq$, &c., it is found to be $Edp + Fdq$. Similarly

$$a'dx + b'dy + c'dz = Fdp + Gdq.$$

Again, differentiating the identities

$$aA + bB + cC = 0,$$

$$a'A + b'B + c'C = 0,$$

we find $a dA + b dB + c dC = -(Ada + Bdb + Cdc)$,

$$a'dA + b'dB + c'dC = -(Ada' + Bdb' + Cdc'),$$

which, substituting for $da = \alpha dp + \alpha' dq$, &c., become respectively $-(E'dp + F'dq)$ and $-(F'dp + G'dq)$. Whence, finally, the equation of the lines of curvature is

$$\begin{vmatrix} Edp + Fdq, & Fdp + Gdq \\ E'dp + F'dq, & F'dp + G'dq \end{vmatrix} = 0,$$

or, as this may also be written,

$$\begin{vmatrix} dq^2, & -dpdq, & dp^2 \\ E, & F, & G \\ E', & F', & G' \end{vmatrix} = 0.$$

379. The equations $0 = dx + Ad\lambda + \lambda dA$, &c., of the last article may be written, putting $dA = A_1 dp + A_2 dq$, &c.,

$$0 = (a + \lambda A_1) dp + (a' + \lambda A_2) dq + Ad\lambda,$$

$$0 = (b + \lambda B_1) dp + (b' + \lambda B_2) dq + Bd\lambda,$$

$$0 = (c + \lambda C_1) dp + (c' + \lambda C_2) dq + Cd\lambda,$$

which equations, by the elimination of dp , dq , $d\lambda$, give for the determination of λ a quadratic equation corresponding to that of Art. 295. Taking ρ for the radius of curvature, we have $\rho^2 = (\xi - x)^2 + (\eta - y)^2 + (\zeta - z)^2 = V^2 \lambda^2$, or say $\lambda = \rho : V$; and writing down the equation in question with this value

substituted for λ , the equation is

$$\begin{vmatrix} aV + A_1\rho, & bV + B_1\rho, & cV + C_1\rho \\ a'V + A_2\rho, & b'V + B_2\rho, & c'V + C_2\rho \\ A & B & C \end{vmatrix} = 0,$$

a quadratic equation for determining the radius of curvature. This equation may be treated as before. It becomes

$$\begin{vmatrix} EV + \rho(A_1a + B_1b + C_1c), & FV + \rho(A_1a' + B_1b' + C_1c') \\ FV + \rho(A_2a + B_2b + C_2c), & GV + \rho(A_2a' + B_2b' + C_2c') \end{vmatrix} = 0.$$

In which, by the last article, the coefficients of ρ are $-E'$, $-F'$, $-G'$, whence the equation for the radii of curvature is

$$\begin{vmatrix} E'\rho - EV, & F'\rho - FV \\ F'\rho - FV, & G'\rho - GV \end{vmatrix} = 0.$$

380. By what precedes we have a quadratic equation for the direction of the lines of curvature, and a quadratic equation for the value of ρ ; but it is obvious that, selecting at pleasure either of the two lines of curvature, the corresponding value of ρ should be linearly determined. The required formula is at once obtained from the equations $0 = dx + Ad\lambda + \lambda dA$, &c., of Art. 378, by multiplying them by dx , dy , dz respectively and adding; then substituting for λ its foregoing value $\rho : V$, we have

$$V(dx^2 + dy^2 + dz^2) + \rho(dx dA + dy dB + dz dC) = 0,$$

where, by what precedes, $dx^2 + dy^2 + dz^2 = Edp^2 + 2Fdpdq + Gdq^2$. But, by the equation of the surface $A dx + B dy + C dz = 0$, we have

$$dA dx + dB dy + dC dz = -(Ad^2x + Bd^2y + Cd^2z),$$

which, substituting from Art. 377,

$$= -(E'dp^2 + 2F'dpdq + G'dq^2),$$

whence the equation is

$$\rho(E'dp^2 + 2F'dpdq + G'dq^2) - V(Edp^2 + 2Fdpdq + Gdq^2) = 0.$$

In this, considering $dp \div dq$ as having at pleasure one or other of the values given by the differential equation of the lines of curvature, the equation gives linearly the corresponding value of the radius of curvature.

But writing the equation in the form

$$(\rho E' - VE) dp^2 + 2(\rho F' - VF) dp dq + (\rho G' - VG) dq^2 = 0,$$

and attending to the equation for the determination of ρ , it appears that the equation may be expressed in either of the forms

$$\begin{aligned} (\rho E' - VE) dp + (\rho F' - VF) dq &= 0, \\ (\rho F' - VF) dp + (\rho G' - VG) dq &= 0; \end{aligned}$$

or, which is the same thing, the equations of Arts. 378 and 379 may be expressed in the more complete forms

$$\begin{aligned} \left\| \begin{array}{l} \rho, \quad E dp + F dq, \quad F dp + G dq \\ V, \quad E' dp + F' dq, \quad F' dp + G' dq \end{array} \right\| &= 0, \\ \left\| \begin{array}{l} dq, \quad \rho E' - VE, \quad \rho F' - VF \\ -dq, \quad \rho F' - VF, \quad \rho G' - VG \end{array} \right\| &= 0. \end{aligned}$$

The first of these gives the quadratic equation for the curves of curvature, and (linearly) the value of ρ for each curve; the second gives the quadratic equation for the radius of curvature, and (linearly) the direction of the curvature for each value of the radius. It also appears that the quadratic equations for ρ and for $dp \div dq$ are linear transformations the one of the other.

381. Returning to the equation

$$\rho (E' dp^2 + 2F' dp dq + G' dq^2) = V (Edp^2 + 2Fdp dq + Gdp^2)$$

of the preceding article, it is to be observed that (the ratio $dp \div dq$ being arbitrary) this is the equation which determines the radius of curvature of the normal section through the consecutive point $(p + dp, q + dq)$. The centre of curvature of this section is, in fact, given as the intersection of the normal at (p, q) by the plane drawn through the middle point of the line joining the two points $(p, q), (p + dp, q + dq)$ at right angles to this line. Taking ξ, η, ζ for current coordinates, the equations of the normal are, as before,

$$\xi = x + \lambda A, \quad \eta = y + \lambda B, \quad \zeta = z + \lambda C,$$

whence
$$(\xi - x)^2 + (\eta - y)^2 + (\zeta - z)^2 = \lambda^2 V^2 = \rho^2,$$

ρ being a distance measured along the normal; the equation of the plane in question is

$$(\xi - x - \frac{1}{2} dx - \frac{1}{4} d^2 x - \&c.) (dx + \frac{1}{2} d^2 x + \&c.) + \dots = 0,$$

or, substituting for $\xi - x, \eta - y, \zeta - z$ the values $\frac{\rho A}{V}, \frac{\rho B}{V}, \frac{\rho C}{V},$

the equation, omitting higher infinitesimals, becomes

$$\frac{\rho}{V} \{A(dx + \frac{1}{2}d^2x) + B(dy + \frac{1}{2}d^2y) + C(dz + \frac{1}{2}d^2z)\} = \frac{1}{2}(dx^2 + dy^2 + dz^2);$$

which, observing that $Adx + Bdy + Cdz = 0$, is

$$\rho(Ad^2x + Bd^2y + Cd^2z) - V(dx^2 + dy^2 + dz^2) = 0,$$

or, substituting for dx, \dots, d^2x, \dots their values, it is

$$\rho(E'dp^2 + 2F'dpdq + G'dq^2) - V(Edp^2 + 2Fdpdq + Gdq^2) = 0,$$

the above-mentioned equation.*

The formula explains the meaning of the coefficients E', F', G' ; it shews that the equation

$$E'dp^2 + 2F'dpdq + G'dq^2 = 0$$

determines the directions of the inflexional tangents at the point (p, q) . It may be observed that if $E' = 0, G' = 0$, this equation becomes $dpdq = 0$, we then have $p = \text{const.}, q = \text{const.}$, as the equations of the "inflexion curves," or curves which at each point thereof coincide in direction with an inflexional tangent.

382. We may imagine the parameters p, q so determined that the equations of the two sets of lines of curvature shall be $p = \text{const.}$ and $q = \text{const.}$ respectively. When this is so the differential equation of the lines of curvature will be $dpdq = 0$; and this will be the case if $F = 0, F' = 0$; we thus obtain $F = 0, F' = 0$ as the conditions in order that the equations of the lines of curvature may be $p = \text{const.}$ and $q = \text{const.}$ Or, writing the conditions at full length, they are

$$\frac{dx}{dp} \frac{dx}{dq} + \frac{dy}{dp} \frac{dy}{dq} + \frac{dz}{dp} \frac{dz}{dq} = 0,$$

$$\begin{vmatrix} \frac{dx}{dp} & \frac{dy}{dp} & \frac{dz}{dp} \\ \frac{dx}{dq} & \frac{dy}{dq} & \frac{dz}{dq} \\ \frac{d^2x}{dpdq} & \frac{d^2y}{dpdq} & \frac{d^2z}{dpdq} \end{vmatrix} = 0,$$

* This equation is obtained geometrically by Mr. Williamson, *Quarterly Journal*, vol. XI., p. 364 (1871).

where it may be noticed that the first equation merely expresses that the curves $p = \text{const.}$ and $q = \text{const.}$ intersect at right angles.

383. If, as above, $F = 0$, $F' = 0$, then the quadratic equation for ρ is

$$(\rho E' - VE)(\rho G' - VG) = 0,$$

and from the equations of Art. 380, putting successively $dp = 0$, $dq = 0$, it appears that the value $\rho = \frac{VG}{G'}$ belongs to the line of curvature $p = \text{const.}$, and the value $\rho = \frac{VE}{E'}$ to the line of curvature $q = \text{const.}$

384. The above determinant-equation $F' = 0$ may be replaced by three equations

$$\frac{d^2x}{dpdq} + \lambda \frac{dx}{dp} + \mu \frac{dx}{dq} = 0, \text{ \&c.,}$$

where λ , μ , are indeterminate coefficients; multiplying first by $\frac{dx}{dp}$, $\frac{dy}{dp}$, $\frac{dz}{dp}$, and adding, we have an equation containing only λ , and which is

$$\frac{1}{2} \frac{dE}{dq} + \lambda E = 0,$$

and similarly multiplying by $\frac{dx}{dq}$, $\frac{dy}{dq}$, $\frac{dz}{dq}$, and adding, we obtain

$$\frac{1}{2} \frac{dG}{dp} + \mu G = 0.$$

It thus appears, that $p = \text{const.}$, $q = \text{const.}$, being the equations of the curves of curvature, the coordinates x , y , z considered as functions of p , q satisfy each the partial differential equation

$$\frac{d^2u}{dpdq} - \frac{1}{2} \frac{1}{E} \frac{dE}{dq} \frac{du}{dp} - \frac{1}{2} \frac{1}{G} \frac{dG}{dp} \frac{du}{dq} = 0,*$$

385. Entering now upon Gauss's theory of the curvature of surfaces,† it is to be remembered that in plane curves

* See Lamé *Leçons sur les coordonnées curvilignes.* Paris, 1859, p. 89.

† See his Memoir referred to in Note to Art. 377.

we measure the curvature of an arc of given length by the angle between the tangents, or between the normals, at its extremities; in other words, if we take a circle whose radius is unity, and draw radii parallel to the normals at the extremities of the arc, the ratio of the intercepted arc of the circle to the arc of the curve affords a measure of the curvature of the arc. In like manner, if we have a portion of a surface bounded by any closed curve, and if we draw radii of a unit sphere parallel to the normals at every point of the bounding curve, the area of the corresponding portion of the sphere is called by Gauss the *total curvature* of the portion of the surface under consideration. And if at any point of a surface we divide the total curvature of the superficial element adjacent to the point by the area of the element itself, the quotient is called the *measure of curvature* for that point.

386. We proceed to express the measure of curvature by a formula. Since the tangent planes at any point on the surface, and at the corresponding point on the unit sphere, are by hypothesis parallel, the areas of any elementary portions of each are proportional to their projections on any of the coordinate planes. Let us consider, then, their projections on the plane of xy , and let us suppose the equation of the surface to be given in the form $z = \phi(x, y)$.

If then x, y, z be the coordinates of any point on the surface, X, Y, Z those of the corresponding point on the unit sphere, $x + dx, x + \delta x, X + dX, X + \delta X$, &c., the coordinates of two adjacent points on each, then the areas of the two elementary triangles formed by the points considered are evidently in the ratio

$$dX\delta Y - dY\delta X : dx\delta y - dy\delta x.$$

But $dX, dY, \delta X, \delta Y$ are connected with dx, dy , &c., by the same linear transformations, viz.

$$dX = \frac{dX}{dx} dx + \frac{dX}{dy} dy, \quad dY = \frac{dY}{dx} dx + \frac{dY}{dy} dy;$$

$$\delta X = \frac{dX}{dx} \delta x + \frac{dX}{dy} \delta y, \quad \delta Y = \frac{dY}{dx} \delta x + \frac{dY}{dy} \delta y;$$

whence, by the theory of linear transformations, or by actual multiplication,

$$dX\delta Y - dY\delta X = (dx\delta y - dy\delta x) \left(\frac{dX}{dx} \frac{dY}{dy} - \frac{dX}{dy} \frac{dY}{dx} \right),$$

thus the quantity $\frac{dX}{dx} \frac{dY}{dy} - \frac{dX}{dy} \frac{dY}{dx}$ is the measure of curvature.

Now X, Y, Z , being the projections on the axes of a unit line parallel to the normal, are proportional to the cosines of the angles which the normal makes with the axes. We have, therefore,

$$X = \frac{p}{\sqrt{(1+p^2+q^2)}}, \quad Y = \frac{q}{\sqrt{(1+p^2+q^2)}},$$

$$\frac{dX}{dx} = \frac{(1+q^2)r - pqs}{(1+p^2+q^2)^{\frac{3}{2}}}, \quad \frac{dX}{dy} = \frac{(1+q^2)s - pqt}{(1+p^2+q^2)^{\frac{3}{2}}},$$

$$\frac{dY}{dx} = \frac{(1+p^2)s - pqr}{(1+p^2+q^2)^{\frac{3}{2}}}, \quad \frac{dY}{dy} = \frac{(1+p^2)t - pqs}{(1+p^2+q^2)^{\frac{3}{2}}},$$

whence

$$\frac{dX}{dx} \frac{dY}{dy} - \frac{dX}{dy} \frac{dY}{dx} = \frac{(rt - s^2)}{(1+p^2+q^2)^2}.$$

But from the equation of Art. 311, it appears that the value just found for *the measure of curvature* is $\frac{1}{RR'}$, where R and R' are the two principal radii of curvature at the point.

387. It is easy to verify geometrically the value thus found. For consider the elementary rectangle whose sides are in the directions of the principal tangents. Let the lengths of the sides be λ, λ' , and consequently its area $\lambda\lambda'$. Now the normals at the extremities of λ intersect, and if they make with each other an angle θ , we have $\theta = \lambda : R$ where R is the corresponding radius of curvature. But the corresponding normals of the sphere make with each other, by hypothesis, the same angle, and their length is unity. Denoting, therefore, by μ the length of the element on the sphere corresponding to λ , we have

$\frac{\lambda}{R} = \mu$. In like manner we have $\frac{\lambda'}{R'} = \mu$, and $\frac{\mu\mu'}{\lambda\lambda'} = \frac{1}{RR'}$, which was to be proved.

388. From the formula of Art. 379, it appears that the value of the measure of curvature is

$$= \frac{1}{(EG - F'^2)^2} (E'G' - F''^2),$$

but Gauss obtains this expression in a very different form, as a function of only E, F, G , and their differential coefficients in regard to p, q . To obtain this result we have to express in this form the function $E'G' - F''^2$; that is, the function

$$\begin{vmatrix} \alpha, \beta, \gamma \\ a, b, c \\ a', b', c' \end{vmatrix} \times \begin{vmatrix} \alpha'', \beta'', \gamma'' \\ a, b, c \\ a', b', c' \end{vmatrix} - \begin{vmatrix} \alpha', \beta', \gamma' \\ a, b, c \\ a', b', c' \end{vmatrix}^2$$

Now if these products be expanded according to the ordinary rule for multiplication of determinants, they give the difference between the two determinants*

$$\begin{vmatrix} \alpha\alpha'' + \beta\beta'' + \gamma\gamma'', \alpha\alpha' + b\beta' + c\gamma', \alpha'\alpha' + b'\beta' + c'\gamma' \\ \alpha\alpha + b\beta + c\gamma, \alpha^2 + b^2 + c^2, \alpha\alpha' + b\beta' + c\gamma' \\ \alpha'\alpha + b'\beta + c'\gamma, \alpha\alpha' + b\beta' + c\gamma', \alpha'^2 + b'^2 + c'^2 \end{vmatrix} \\ \begin{vmatrix} \alpha'^2 + \beta'^2 + \gamma'^2, \alpha\alpha' + b\beta' + c\gamma', \alpha'\alpha' + b'\beta' + c'\gamma' \\ \alpha\alpha' + b\beta' + c\gamma', \alpha^2 + b^2 + c^2, \alpha\alpha' + b\beta' + c\gamma' \\ \alpha'\alpha' + b'\beta' + c'\gamma', \alpha\alpha' + b\beta' + c\gamma', \alpha'^2 + b'^2 + c'^2 \end{vmatrix}.$$

389. Now it is easy to show that the terms in these determinants are functions of E, F, G and their differentials. Referring to the definitions of $a, b, c, \alpha, \alpha', \alpha'', \&c.$ (Art. 377) it is obvious that

$$\alpha = \frac{da}{dp}, \quad \alpha' = \frac{da}{dq} = \frac{da'}{dp}, \quad \alpha'' = \frac{da'}{dq}, \quad \&c.,$$

* I owe to Mr. Williamson the remark, that the application of this rule exhibits the result in a form which manifests the truth of Gauss's theorem.

whence, since

$$E = a^2 + b^2 + c^2, \quad F = aa' + bb' + cc', \quad G = a'^2 + b'^2 + c'^2,$$

$$a\alpha + b\beta + c\gamma = \frac{1}{2} \frac{dE}{dp}, \quad a\alpha' + b\beta' + c\gamma' = \frac{1}{2} \frac{dE}{dq},$$

$$a'\alpha' + b'\beta' + c'\gamma' = \frac{1}{2} \frac{dG}{dp}, \quad a'\alpha'' + b'\beta'' + c'\gamma'' = \frac{1}{2} \frac{dG}{dq},$$

$$a\alpha'' + b\beta'' + c\gamma'' = \frac{dF}{dq} - (a'\alpha' + b'\beta' + c'\gamma') = \frac{dF}{dq} - \frac{1}{2} \frac{dG}{dp},$$

$$a'\alpha + b'\beta + c'\gamma = \frac{dF}{dp} - (a\alpha' + b\beta' + c\gamma') = \frac{dF}{dp} - \frac{1}{2} \frac{dE}{dq}.$$

It will be seen that these equations express in terms of E, F, G every term in the preceding determinants except the leading one in each. To express these, differentiate, with regard to q , the equation last written, and we have

$$a\alpha'' + b\beta'' + c\gamma'' = \frac{d^2F}{dpdq} - \frac{1}{2} \frac{d^2E}{dq^2} - \left(a' \frac{d\alpha}{dq} + b' \frac{d\beta}{dq} + c' \frac{d\gamma}{dq} \right).$$

Again, differentiate, with regard to p , the equation

$$a'\alpha' + b'\beta' + c'\gamma' = \frac{1}{2} \frac{dG}{dp},$$

and we have

$$a''\alpha + \beta''\alpha + \gamma''\alpha = \frac{1}{2} \frac{d^2G}{dp^2} - \left(a' \frac{d\alpha'}{dp} + b' \frac{d\beta'}{dp} + c' \frac{d\gamma'}{dp} \right).$$

Now because $\frac{d\alpha}{dq} = \frac{d\alpha'}{dp}$, &c., the quantities within the brackets in the last two equations are equal. And since the leading term in each determinant is multiplied by the same factor, in subtracting the determinants we are only concerned with the difference of these terms, and the quantity within the brackets disappears from the result. The function in question is thus equal to the difference of the determinants

$$\begin{vmatrix} \frac{d^2F}{dpdq} - \frac{1}{2} \frac{d^2E}{dq^2}, & \frac{dF}{dq} - \frac{1}{2} \frac{dG}{dp}, & \frac{1}{2} \frac{dG}{dq} \\ \frac{1}{2} \frac{dE}{dp}, & E, & F \\ \frac{dF}{dp} - \frac{1}{2} \frac{dE}{dq}, & F, & G \end{vmatrix},$$

and

$$\begin{vmatrix} \frac{1}{2} \frac{d^2 G}{dp^2}, & \frac{1}{2} \frac{dE}{dq}, & \frac{1}{2} \frac{dG}{dp} \\ \frac{1}{2} \frac{dE}{dq}, & E, & F \\ \frac{1}{2} \frac{dG}{dp}, & F, & G \end{vmatrix}.$$

We get the measure of curvature by dividing the quantity now found by $(EG - F^2)^2$, and the result is thus a function of E, F, G and their differentials. Gauss's theorem is therefore proved. It may be remarked that the expression involves only second differential coefficients of E, F, G , that is third differential coefficients of the coordinates; these, however, really disappear, since the original expression $E'G' - F'^2$ involves only second differential coefficients of the coordinates.

We add the actual expansion of the determinants, though not necessary to the proof. Writing the measure of curvature k , we have

$$\begin{aligned} 4(EG - F^2)^2 k &= E \left\{ \frac{dE}{dq} \frac{dG}{dq} - 2 \frac{dF}{dp} \frac{dG}{dq} + \left(\frac{dG}{dp} \right)^2 \right\} \\ &+ F \left\{ \frac{dE}{dp} \frac{dG}{dq} - \frac{dE}{dq} \frac{dG}{dp} - 2 \frac{dE}{dq} \frac{dF}{dq} + 4 \frac{dF}{dp} \frac{dF}{dq} - 2 \frac{dF}{dp} \frac{dG}{dp} \right\} \\ &+ G \left\{ \frac{dE}{dp} \frac{dG}{dp} - 2 \frac{dE}{dp} \frac{dF}{dq} + \left(\frac{dE}{dq} \right)^2 \right\} \\ &- 2(EG - F^2) \left(\frac{d^2 E}{dq^2} - 2 \frac{d^2 F}{dp dq} + \frac{d^2 G}{dp^2} \right), \end{aligned}$$

(Liouville's Monge, p. 523).*

390. The foregoing theorem, that the measure of curvature is a function of E, F, G and their differentials, shews that if a surface supposed to be flexible, but not extensible, be trans-

* MM. Bertrand, Diguët, and Puiseux (see *Liouville*, vol. XIII. p. 80; Appendix to Monge, p. 583) have established Gauss's theorem by calculating the perimeter and area of a geodesic circle on any surface, whose radius, supposed to be very small, is s . They find for the perimeter $2\pi s - \frac{\pi s^3}{3RR'}$, and for the area $\pi s^2 - \frac{\pi s^4}{12RR'}$. And of course the supposition that these are unaltered by deformation implies that RR' is constant.

formed in any manner; that is to say, if the shape of the surface be changed, yet so that the distance between any two points measured along the surface remains the same, then the measure of curvature at every point remains unaltered. We have an example of this change in the case of a developable surface which is such a deformation of a plane; and the measure of curvature vanishes for the developable, as well as for the plane, one of the principal radii being infinite. To see that the general theorem is true, observe that the expression of an element of length on the surface is

$$ds^2 = E dp^2 + 2F dpdq + G dq^2.$$

Let x', y', z' denote the point of the deformed surface corresponding to any point x, y, z of the original surface. Then x', y', z' are given functions of x, y, z , and can therefore also be expressed in terms of p, q ; and the element of any arc of the deformed surface can be expressed in the form

$$ds'^2 = E_1 dp^2 + 2F_1 dpdq + G_1 dq^2.$$

But the condition that the length of the arc shall be unaltered by transformation, manifestly requires that $E = E_1, F = F_1, G = G_1$; hence, any function of E, F, G , and, in particular the value of the measure of curvature, is unaltered by the deformation in question.

391. We may consider two systems of curves traced on the surface, for one of which p is constant, and for the other q ; so that any point on the surface is the intersection of a pair of curves, one belonging to each system. The expression then $ds^2 = E dp^2 + 2F dpdq + G dq^2$ shews that $\sqrt{E} dp$ is the element of the curve, passing through the point, for which q is constant; and $\sqrt{G} dq$ is the element of the curve for which p is constant. If these two curves intersect at an angle ω , then since ds is the diagonal of a parallelogram of which $\sqrt{E} dp, \sqrt{G} dq$ are the sides, we have $\sqrt{EG} \cos \omega = F$, while the area of the parallelogram is $d\sigma d\sigma' \sin \omega = \sqrt{EG - F^2} dpdq$. If the curves of the system p cut at right angles those of the system q , we must have $F = 0$.

A particular case of these formulæ is when we use geodesic

polar coordinates, in which case, as we shall subsequently shew, we always have an expression of the form $ds^2 = d\rho^2 + P^2 d\omega^2$. Now if in the formula of article 389 we put $F=0$, $E = \text{constant}$, it becomes

$$4E^2 G^2 k = E \left(\frac{dG}{dp} \right)^2 - 2EG \frac{d^2 G}{dp^2},$$

and if we put

$$E=1, \quad G=P^2, \quad p=\rho, \quad k=\frac{1}{RR'}, \quad \text{we have } \frac{d^2 P}{d\rho^2} + \frac{P}{RR'} = 0,$$

an equation which must be satisfied by the function P on any surface, if $Pd\omega$ expresses the element of the arc of a geodesic circle. Mr. Roberts verifies (*Cambridge and Dublin Mathematical Journal*, vol. III., p. 161) that this equation is satisfied by the function $y \operatorname{cosec} \omega$ on a quadric.

392. Gauss applies these formulæ to find the total curvature, in his sense of the word, of a geodesic triangle on any surface. The element of the area being $Pd\omega d\rho$, and the measure of curvature being $-\frac{1}{P} \frac{d^2 P}{d\rho^2}$, by twice integrating $-\frac{d^2 P}{d\rho^2} d\rho d\omega$ the total curvature is found. Integrating first with respect to ρ , we get $\left(C - \frac{dP}{d\rho} \right) d\omega$. Now if the radii are measured from one vertex of the given triangle, the integral is plainly to vanish for $\rho=0$; and it is plain also that for $\rho=0$ we must have $\frac{dP}{d\rho} = 1$; for as ρ tends to vanish, the length of an element perpendicular to the radius tends to become $\rho d\omega$. Hence the first integral is $d\omega \left(1 - \frac{dP}{d\rho} \right)$.

This may be written in a more convenient form as follows: Let θ be the angle which any radius vector makes with the element of a geodesic arc ab . Now since $aa' = Pd\omega$, $bb' = (P + dP) d\omega$; and if $cb = aa'$, we have $cb' = dPd\omega$, and the angle $cab' = \frac{dP}{d\rho} d\omega$. But cab' is evidently the diminution of the angle θ

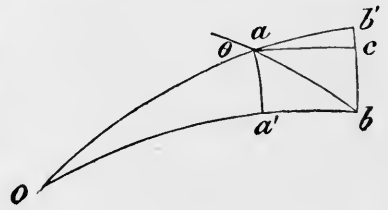

θ in passing to a consecutive point; hence $d\theta = -\frac{dP}{d\rho}d\omega$. The integral just found is therefore $d\omega + d\theta$, which integrated a second time is $\omega + \theta' - \theta''$, where ω is the angle between the two extreme radii vectores which we consider, and θ', θ'' are the corresponding values of θ . If we call A, B, C the internal angles of the triangle formed by the two extreme radii and by the base, we have $\omega = A, \theta' = B, \theta'' = \pi - C$, and the total curvature is $A + B + C - \pi$. Hence the excess over 180° of the sum of the angles of a geodesic triangle is measured by the area of that portion of the unit sphere which corresponds to the directions of the normals along the sides of the given triangle.

The portion on the unit sphere corresponding to the area enclosed by a geodesic returning upon itself is half the sphere. For if the radius vector travel round so as to return to the point whence it set out, the extreme values of θ' and θ'' are equal, while ω has increased by 2π . The measure of curvature is therefore 2π , or half the surface of the sphere.*

Gauss elsewhere applies the formulæ to the representation of one surface on another, and in particular to the representation of a surface on a plane, in such manner that the infinitesimal elements of the one surface are similar to those of the other; a condition satisfied in the stereographic projection and in other representations of the sphere.

393. It remains to say something of the properties of curves considered as belonging to a particular surface. Thus the sphere we know has a geometry of its own, where great circles take the place of lines in a plane; and, in like manner, each surface has a geometry of its own, the geodesics on that surface answering to right lines.†

* For some other interesting theorems, relative to the deformation of surfaces, see Mr. Jellett's paper "On the Properties of Inextensible Surfaces," *Transactions of the Royal Irish Academy*, vol. XXII. Memoirs have also appeared by MM. Bour and Bonnet, on the Theory of Surfaces applicable to one another, to one of which was awarded the Prize of the French Academy in 1860.

† The geometry of curves traced upon the hyperboloid of one sheet has been

We have already by anticipation given the fundamental property of a geodesic (Art. 308). The differential equation is immediately obtained from the property there proved, that the normal lies in the plane of two successive elements of the curve and bisects the angle between them; hence L , M , N , which are proportional to the direction-cosines of the normal, must be proportional to $d \frac{dx}{ds}$, $d \frac{dy}{ds}$, $d \frac{dz}{ds}$, which are the direction-cosines of the bisector (Art. 358). Thus "if the tangents to a geodesic make a constant angle with a fixed plane, the normals along it will be parallel to that plane, and *vice versa* (Dickson, *Cambridge and Dublin Mathematical Journal*, vol. v., p. 168). For from the equation

$$a \frac{dx}{ds} + b \frac{dy}{ds} + c \frac{dz}{ds} = \text{constant},$$

which denotes that the tangents make a constant angle with a fixed plane, we can deduce

$$aL + bM + cN = 0,$$

which denotes that the normals are parallel to the same plane.

394. *If through any point on a surface there be drawn two indefinitely near and equal geodesics, the line joining their extremities is at right angles to both.**

studied nearly in the same manner by Plücker, *Crelle*, vol. XLIII. (1847), and by Chasles (*Comptes Rendus*, vol. LIII. 1861, p. 985), the coordinates made use of being the intercepts made by the two generators through any point on two fixed generators taken for axes. It is easy to shew that in this method the most general equation of a plane section is of the form

$$Axy + Bx + Cy + D = 0,$$

and generally that the order of any curve is equal to the sum of the highest powers of x and y in its equation, whether these highest powers occur in the same term or not. The curves are distinguished into families according to the number of intersections of the curve by the generating lines of the two kinds respectively. Thus, for a quartic curve of the first kind, or quadriquadric, each generating line of either kind meets the curve in 2 points; but for a quartic curve of the second kind, or excubo-quartic, each generating line of the one kind meets the curve in 3 points, and each generating line of the other kind in 1 point.

* This theorem is due to Gauss, who also proves it by the Calculus of Variations; see the Appendix to Liouville's Edition of Monge, p. 528.

Let $AB = AC$, and let us suppose the angle at B not to be right, but to be $= \theta$. Take $BD = BC \sec \theta$, and then, because all the sides of the triangle BCD are infinitely small, it may be treated as a plane triangle and the angle DCB is a right angle. We have therefore $DC < DB$, $AD + DC < AB$, and therefore $< AC$. It follows that AC is not the

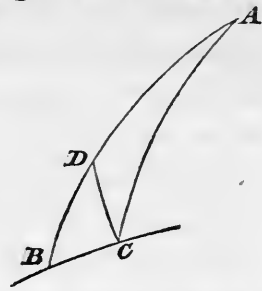

shortest path from A to C , contrary to hypothesis. Or the proof may be stated thus: The shortest line from a point A to any curve on a surface meets that curve perpendicularly. For if not, take a point D on the radius vector from A and indefinitely near to the curve; and from this point let fall a perpendicular on the curve, which we can do by taking along BC a portion $= BD \cos \theta$ and joining the point so found to D . We can pass then from D to the curve more shortly by going along the perpendicular than by travelling along the assumed radius vector, which is therefore not the shortest path.

Hence, if every geodesic through A meet the curve perpendicularly, the length of that geodesic is constant. It is also evident, mechanically, that the curve described on any surface by a strained cord from a fixed point is everywhere perpendicular to the direction of the cord.

395. The theorem just proved is the fundamental theorem of the method of infinitesimals, applied to right lines (*Conics*, pp. 369, &c.). All the theorems therefore which are there proved by means of this principle will be true if instead of right lines we consider geodesics traced on any surface. For example, "if we construct on any surface the curve answering to an ellipse or hyperbola; that is to say, the locus of a point the sum or difference of whose geodesic distances from two fixed points on the surface is constant; then the tangent at any point of the locus bisects the angle between the geodesics joining the point of contact to the fixed points." The converse of this theorem is also true. Again, "if two geodesic tangents to a curve, through any point P , make equal angles with the

tangent to a curve along which P moves, then the difference between the sum of these tangents and the intercepted arc of the curve which they touch is constant" (see *Conics*, Art. 399). Again, "if equal portions be taken on the geodesic normals to a curve, the line joining their extremities cuts all at right angles," or, "if two different curves both cut at right angles a system of geodesics they intercept a constant length on each vector of the series." We shall presently apply these principles to the case of geodesics traced on quadrics.

396. As the curvature of a plane curve is measured by the ratio which the angle between two consecutive tangents bears to the element of the arc, so the *geodesic curvature* of a curve on a surface is measured by the ratio borne to the element of the arc by the angle between two consecutive geodesic tangents. The following calculation of the radius of geodesic curvature, due to M. Liouville,* gives at the same time a proof of Meunier's theorem.

Let mn , np be two consecutive and equal elements of the curve. Produce $nt = mn$, and let fall tq perpendicular to the surface; join nq and qp . Then, since nt makes an infinitely small angle with the surface, its projection nq is equal to it. nq is the second element of the normal section, and is also the second element of the geodesic production of mn . If now θ be the angle of contact tnp , and θ' be tnq the angle of contact of the normal section, we have $tp = \theta ds$, $tq = \theta' ds$. Now the angle qtp ($= \phi$) is the angle between the osculating plane of the curve and the plane of normal section, and since $tq = tp \cos \phi$, we have $\theta' = \theta \cos \phi$ and $\frac{1}{R} = \frac{\cos \phi}{\rho}$, which is Meunier's theorem; R being the radius of curvature of the normal section and ρ that of the given curve.

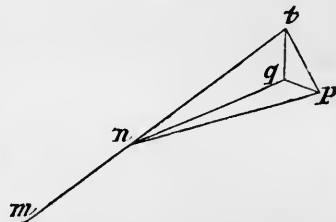

Now, in like manner, pnq being θ'' the geodesic angle of

* Appendix to Monge, p. 576.

contact, we have $pq = \theta'' ds$ and $pq = tp \sin \phi$, or $\frac{1}{r} = \frac{\sin \phi}{\rho}$.

The geodesic* radius of curvature is therefore $\rho \operatorname{cosec} \phi$. It is easy to see that this geodesic radius is the absolute radius of curvature of the plane curve into which the given curve would be transformed, by circumscribing a developable to the given surface along the given curve, and unfolding that developable into a plane.

397. The theory of geodesics traced on quadrics depends on Jacobi's first integral of the differential equation of these lines; intimately connected herewith we have Joachimsthal's fundamental theorem, that at every point on such a curve pD is constant, where, as at Art. 166, p is the perpendicular from the centre on the tangent plane at the point, and D is the diameter of the quadric parallel to the tangent to the curve at the same point. This may be proved by the help of the two following principles: (1) If from any point two tangent lines be drawn to a quadric, their lengths are proportional to the parallel diameters. This is evident from Art. 74; and (2) If from each of two points A, B on the quadric perpendiculars be let fall on the tangent plane at the other, these perpendiculars will be proportional to the perpendiculars from the centre on the same planes. For the length of the perpendicular from $x''y''z''$ on the tangent plane at $x'y'z'$ is $p \left(\frac{x'x''}{a^2} + \frac{y'y''}{b^2} + \frac{z'z''}{c^2} - 1 \right)$, and the perpendicular from $x'y'z'$ on the tangent plane at $x''y''z''$ is $p' \left(\frac{x'x''}{a^2} + \frac{y'y''}{b^2} + \frac{z'z''}{c^2} - 1 \right)$.

If now from the points A, B there be drawn lines AT, BT to any point T on the intersection of the tangent planes at A and B , and if AT make an angle i with the intersection of the planes, the angle between the planes being ω , then the perpendicular from A to the intersection of the planes is $AT \sin i$, and from A on the other plane is $AT \sin i \sin \omega$. In

* I have not adopted the name "second geodesic curvature" introduced by M. Bonnet. It is intended to express the ratio borne to the element of the arc by the angle which the normal at one extremity makes with the plane containing the element and the normal at the other extremity.

like manner the perpendicular from B on the tangent plane at A is $BT \sin i' \sin \omega$. If, therefore, the lines AT, BT make equal angles with the intersection of the planes, the lines AT, BT are proportional to the perpendiculars from A and B on the two planes. But AT and BT are proportional to D and D' , and the perpendiculars are as the perpendiculars from the centre p' and p . Hence $Dp = D'p'$. But it was proved (Art. 308) that if AT, TB be successive elements of a geodesic, they make equal angles with the intersection of the tangent planes at A and B . Hence, the quantity pD remains unchanged as we pass from point to point of the geodesic. Q. E. D.*

398. On account of the importance of the preceding theorem we wish also to shew how it may be deduced from the differential equations of a geodesic.† Differentiating the equation

$$\frac{L^2}{R^2} + \frac{M^2}{R^2} + \frac{N^2}{R^2} = 1$$

(where L, M, N are the differential coefficients and $R^2 = L^2 + M^2 + N^2$), and then substituting for $L, \&c., d\frac{dx}{ds}, \&c.$ (Art. 393), we get

$$d\left(\frac{dx}{ds}\right) d\left(\frac{L}{R}\right) + d\left(\frac{dy}{ds}\right) d\left(\frac{M}{R}\right) + d\left(\frac{dz}{ds}\right) d\left(\frac{N}{R}\right) = 0.$$

It is to be remarked, that this equation is also true for a line of curvature; for since $L : R, \&c.$ are the direction-cosines of the normal, the direction-cosines of a line in the same plane with two consecutive normals, and perpendicular to them, are (Art. 358) proportional to $d\left(\frac{L}{R}\right), \&c.$ Hence the $\frac{dx}{ds}, \&c.$ of a line of curvature are proportional to $d\left(\frac{L}{R}\right), \&c.$ But if now we differentiate

$$\frac{dx^2}{ds^2} + \frac{dy^2}{ds^2} + \frac{dz^2}{ds^2} = 1,$$

* This proof is by Graves, *Crelle*, vol. XLII. p. 279.

† See Jacobi, *Crelle*, vol. XIX. (1839), p. 309; Joachimsthal, *Crelle*, vol. XXVI. p. 155; Bonnet, *Journal de l'Ecole Polytechnique*, vol. XIX. p. 138; Dickson, *Cambridge and Dublin Mathematical Journal*, vol. v. p. 168; Jacobi, *Vorlesungen über Dynamik*, p. 212. The theory of geodesic lines on a spheroid of revolution, in particular an oblate spheroid, was considered by Legendre.

and substitute for $\frac{dx}{ds}$, &c. the values just given, we have again the equation

$$d\left(\frac{dx}{ds}\right) d\left(\frac{L}{R}\right) + d\left(\frac{dy}{ds}\right) d\left(\frac{M}{R}\right) + d\left(\frac{dz}{ds}\right) d\left(\frac{N}{R}\right) = 0.$$

If we actually perform the differentiations, and reduce the result by the differential equation of the surface $Ldx + Mdy + Ndz = 0$, and its consequence

$$dLdx + dMdy + dNdz = -(Ll^2x + Md^2y + Nd^2z),$$

we get

$$(dLdx + dMdy + dNdz)(dRds - Rd^2s) + (dLd^2x + dMd^2y + dNd^2z)Rds = 0,*$$

or
$$\frac{dLd^2x + dMd^2y + dNd^2z}{dLdx + dMdy + dNdz} + \frac{dR}{R} - \frac{d^2s}{ds} = 0.$$

399. The preceding equation is true for a geodesic or for a line of curvature on any surface, but when the surface is only of the second degree, a first integral of the equation can be found. In fact, we have

$$dLd^2x + dMd^2y + dNd^2z = \frac{1}{2}d(dLdx + dMdy + dNdz).$$

This may be easily verified by using the general equation of a quadric, or, more simply, by using the equation

$$\frac{x^2}{a^2} + \frac{y^2}{b^2} + \frac{z^2}{c^2} = 1,$$

when $L = \frac{x}{a^2}$, $M = \frac{y}{b^2}$, $N = \frac{z}{c^2}$; $dL = \frac{dx}{a^2}$, $dM = \frac{dy}{b^2}$, $dN = \frac{dz}{c^2}$;

by substituting which values the equation is at once established.

* Dr. Gehring has remarked (see Hesse, *Vorlesungen*, p. 325) that this equation multiplied by Rds , subject as before to the condition $Ldx + Mdy + Ndz = 0$, may be resolved into the product of the two determinants $\begin{vmatrix} dx & dy & dz \\ L & M & N \\ dL & dM & dN \end{vmatrix} \cdot \begin{vmatrix} dx & dy & dz \\ d^2x & d^2y & d^2z \\ L & M & N \end{vmatrix}$. So that for quadrics the determinant of the lines of curvature is the integrating factor of the geodesics. Dr. Hesse shews that the integral so arrived at belongs exclusively to the latter.

The equation of the last article then consists of terms, each separately integrable. Integrating, we have

$$R^2 (dLdx + dMdy + dNdz) = Cds^2.$$

Now, from the preceding values,

$$R^2 = \frac{x^2}{a^4} + \frac{y^2}{b^4} + \frac{z^2}{c^4} = \frac{1}{p^2},$$

and
$$\frac{dL}{ds} \frac{dx}{ds} + \frac{dM}{ds} \frac{dy}{ds} + \frac{dN}{ds} \frac{dz}{ds} = \frac{1}{a^2} \frac{dx^2}{ds^2} + \frac{1}{b^2} \frac{dy^2}{ds^2} + \frac{1}{c^2} \frac{dz^2}{ds^2}.$$

But the right-hand side of the equation denotes the reciprocal of the square of a central radius whose direction-cosines are $\frac{dx}{ds}$, $\frac{dy}{ds}$, $\frac{dz}{ds}$.

The geometric meaning therefore of the integral we have found is $pD = \text{constant}$.*

400. *The constant pD has the same value for all geodesics which pass through an umbilic.*

For at the umbilic the p is of course common to all, being $= ac : b$; and, since the central section parallel to the tangent plane at the umbilic is a circle, the diameter parallel to the tangent line to the geodesic is constant, being always equal to the mean axis b . Hence, for a geodesic passing through an umbilic we have $pD = ac$.

Let now any point on a quadric be joined by geodesics to two umbilics, since we have just proved that pD is the same for both geodesics, and, since at the point of meeting the p is the same for both, the D for that point must also have the same value for both; that is to say, the diameters are equal

* Dr. Hart proves the same theorem as follows: Consider any plane section of an ellipsoid, let ω be the perpendicular from the centre of the section on the tangent line, d the diameter of the section parallel to that tangent, i the angle the plane of the section makes with the tangent plane at any point. Then along the section ωd is constant, and it is evident that pD is in a fixed ratio to $\omega d \sin i$. Hence along the section pD varies as $\sin i$ and will be a maximum where the plane meets the surface perpendicularly. But a geodesic osculates a series of normal sections; therefore, for such a line pD is constant, its differential always vanishing. *Cambridge and Dublin Mathematical Journal*, vol. IV. p. 84.

which are drawn parallel to the tangents to the geodesics at their point of meeting. But two equal diameters of a conic make equal angles with its axes; and we know that the axes of the central section of a quadric parallel to the tangent plane at any point are parallel to the directions of the lines of curvature at that point. Hence, *the geodesics joining any point on a quadric to two umbilics make equal angles with the lines of curvature through that point.**

It follows that the geodesics joining any point to the two opposite umbilics, which lie on the same diameter, are continuations of each other, since the vertically opposite angles are equal which these geodesics make with either line of curvature through the point.

It follows also (see Art. 395) that *the sum or difference is constant of the geodesic distances of all the points on the same line of curvature from two umbilics.* The sum is constant when the two umbilics chosen are interior with respect to the line of curvature; the difference, when for one of these umbilics we substitute that diametrically opposite, so that one of the umbilics is interior, the other exterior to the line of curvature.

If A, A' be two opposite umbilics, and B another umbilic, since the sum $PA + PB$ is constant, and also the difference $PA' - PB$, it follows that $PA + PA'$ is constant; that is to say, *all the geodesics which connect two opposite umbilics are of equal length.* In fact, it is evident that two indefinitely near geodesics connecting the same two points on any surface must be equal to each other.

401. *The constant pD has the same value for all geodesics which touch the same line of curvature.*

It was proved (Art. 166) that pD has a constant value all along a line of curvature; but at the points where either geodesic touches the line of curvature both p and D have the same value for the geodesic and the line of curvature.

Hence, then, a system of lines of curvature has properties completely analogous to those of a system of confocal conics

* This theorem and its consequences developed in the following articles are due to Mr. Michael Roberts, *Liouville*, vol. XI. p. 1.

in a plane; the umbilics answering to the foci. For example, two geodesic tangents drawn to one from any point on another make equal angles with the tangent at that point. Graves's theorem for plane conics holds also for lines of curvature, viz. that the excess of the sum of two tangents to a line of curvature over the intercepted arc is constant, while the intersection moves along another line of curvature of the same species (see *Conics*, Art. 399).

402. The equation $pD = \text{constant}$ has been written in another convenient form.* Let a' , a'' be the primary semi-axes of two confocal surfaces through any point on the curve, and let i be the angle which the tangent to the geodesic makes with one of the principal tangents. Then, since $a^2 - a'^2$, $a^2 - a''^2$ (Art. 164) are the semi-axes of the central section parallel to the tangent plane, any other semi-diameter of that section is given by the equation

$$\frac{1}{D^2} = \frac{\cos^2 i}{a^2 - a'^2} + \frac{\sin^2 i}{a^2 - a''^2},$$

while, again,
$$\frac{1}{p^2} = \frac{(a^2 - a'^2)(a^2 - a''^2)}{a^2 b^2 c^2} \quad (\text{Art. 165}).$$

The equation, therefore, $pD = \text{constant}$ is equivalent to

$$(a^2 - a'^2) \cos^2 i + (a^2 - a''^2) \sin^2 i = \text{constant},$$

or to
$$a'^2 \cos^2 i + a''^2 \sin^2 i = \text{constant}.$$

403. *The locus of the intersection of two geodesic tangents to a line of curvature, which cut at right angles, is a sphero-conic.*

This is proved as the corresponding theorem for plane conics. If a' , a'' belong to the point of intersection, we have

$$a'^2 \cos^2 i + a''^2 \sin^2 i = \text{constant}, \quad a'^2 \sin^2 i + a''^2 \cos^2 i = \text{constant},$$

hence
$$a'^2 + a''^2 = \text{constant};$$

and therefore (Art. 161) the distance of the point of intersection from the centre of the quadric is constant. The locus of intersection is therefore the intersection of the given quadric with a concentric sphere. The demonstration holds if the geodesics

* By *Liouville*, vol. IX. p. 401.

are tangents to different lines of curvature; and, as a particular case, the locus of the foot of the geodesic perpendicular from an umbilic on the tangent to a line of curvature is a sphero-conic.

404. To find the locus of intersection of geodesic tangents to a line of curvature which cut at a given angle (Besge, *Liouville*, vol. XIV. p. 247).

The tangents from any point whose a' , a'' are given, to a given line of curvature, are determined by the equation $a''^2 \cos^2 i + a'''^2 \sin^2 i = \beta$; and since they make equal angles with either of the principal tangents through that point, i the angle they make with one of these tangents is half the angle they make with each other. We have therefore

$$\tan \frac{1}{2} \theta = \frac{\sqrt{(\beta - a'''^2)}}{\sqrt{(a'^2 - \beta)}}; \quad \tan \theta = \frac{2 \sqrt{(\beta - a'''^2)} \sqrt{(a'^2 - \beta)}}{a'^2 + a'''^2 - 2\beta},$$

$$(a'^2 + a'''^2 - 2\beta)^2 \tan^2 \theta = 4\beta (a'^2 + a'''^2) - 4a'^2 a'''^2 - 4\beta^2.$$

This is reduced to ordinary coordinates by the equations (Arts. 160, 161)

$$a'^2 + a'''^2 = x^2 + y^2 + z^2 + b^2 + c^2 - a^2; \quad a'^2 a'''^2 = \frac{x^2 (a^2 - b^2) (a^2 - c^2)}{a^2},$$

whence it appears that the locus required is the intersection of the quadric with a surface of the fourth degree.*

405. It was proved (Art. 176) that two confocals can be drawn to touch a given line; that if the axes of the three surfaces passing through any point on the line be a , a' , a'' , and the angles the line makes with the three normals at the point be α , β , γ , then the axis-major of the touched confocal is determined by the quadratic

$$\frac{\cos^2 \alpha}{a^2 - a'^2} + \frac{\cos^2 \beta}{a'^2 - a''^2} + \frac{\cos^2 \gamma}{a''^2 - a^2} = 0.$$

Let us suppose now that the given line is a tangent to the

* Mr. Michael Roberts has proved (*Liouville*, vol. xv. p. 291) by the method of Art. 188, that the projection of this curve on the plane of circular sections is the locus of the intersection of tangents, cutting at a constant angle, to the conic into which the line of curvature is projected.

quadric whose axis is a , we have then $\cos \alpha = 0$, since the line is of course at right angles to the normal to the first surface; and we have $\cos \beta = \sin \gamma$, since the tangent plane to the surface a contains both the line and the other two normals. The angle γ is what we have called i in the articles immediately preceding. The axis then of the second confocal touched by the given line is determined by the equation

$$\frac{\sin^2 i}{a'^2 - a^2} + \frac{\cos^2 i}{a''^2 - a^2} = 0, \text{ or } a'^2 \cos^2 i + a''^2 \sin^2 i = a^2.$$

If, then, we write the equation of a geodesic (Art. 402) $a'^2 \cos^2 i + a''^2 \sin^2 i = a^2$, we see from this article that that equation expresses that *all the tangent lines along the same geodesic touch the confocal surface whose primary axis is a .**

The geodesic itself will touch the line of curvature in which this confocal intersects the original surface; for the tangent to the geodesic at the point where the geodesic meets the confocal is, as we have just proved, also the tangent to the confocal at that point. The geodesic, therefore, and the intersection of the confocal with the given surface have a common tangent.

The osculating planes of the geodesic are obviously tangent planes to the same confocal, since they are the planes of two consecutive tangent lines to that confocal.

The value of pD for a geodesic passing through an umbilic is ac (Art. 400); and the corresponding equation is, therefore, $a'^2 \cos^2 i + a''^2 \sin^2 i = a^2 - b^2$. Now the confocal, whose primary axis is $\sqrt{a^2 - b^2}$, reduces to the umbilicar focal conic. Hence, as a particular case of the theorems just proved, *all tangent lines to a geodesic which passes through an umbilic intersect the umbilicar focal conic.*

Conversely, if from any point O on that focal conic rectilinear tangents be drawn to a quadric, and those tangents produced geodetically on the surface, the lines so produced will pass through the opposite umbilic; the whole lengths from O to the umbilic being equal.

* The theorems of this article are taken from M. Chasles's Memoir, *Liouville*, vol. XI. p. 5.

406. From the fact (proved Art. 176) that tangent planes drawn through any line to the two confocals which touch it are at right angles to each other, we might have inferred directly, precisely as at Art. 309, that tangent lines to a geodesic touch a confocal. For the plane of two consecutive tangents to a geodesic being normal to the surface is tangent to the confocal touched by the first tangent. The second tangent to the geodesic, therefore, touches the same confocal; as, in like manner, do all the succeeding tangents. Having thus established the theorem of the last article, we could, by reversing the steps of the proof, obtain an independent demonstration of the theorem $pD = \text{constant}$.

407. *The developable circumscribed to a quadric along a geodesic has its cuspidal edge on another quadric, which is the same for all the geodesics touching the same line of curvature.*

For any point on the cuspidal edge is the intersection of three consecutive tangent planes to the given quadric, and the three points of contact, by hypothesis, determine an osculating plane of a geodesic which (Art. 405) touches a fixed confocal. The point on the cuspidal edge is the pole of this plane with respect to the given quadric; but the pole with respect to one quadric of a tangent plane to another lies on a third fixed quadric.

408. M. Chasles has given the following generalization of Mr. Roberts' theorem, Art. 400. *If a thread fastened at two fixed points on one quadric A be strained by a pencil moving along a confocal B (so that the thread of course lies in geodesics where it is in contact with the quadrics and in right lines in the space between them), then the pencil will trace a line of curvature on the quadric B .* For the two geodesics on the surface B , which meet in the locus point P , evidently make equal angles with the locus of P ; but these geodesics have, as tangents, the rectilinear parts of the thread which both touch the same confocal; therefore (Art. 405) the pD is the same for both geodesics, and hence the line bisecting the angle between them is a line of curvature.

A particular case of this theorem is, that the focal ellipse of a quadric can be described by means of a thread fastened to two fixed points on opposite branches of the focal hyperbola.

409. *Elliptic Coordinates.* The method used (Arts. 403-4) in which the position of a point on the ellipsoid is defined by the primary axes of the two hyperboloids intersecting in that point, is called the method of Elliptic Coordinates (see Art. 188). As it is more convenient to work with unaccented letters, I follow M. Liouville* in denoting the quantities which we have hitherto called α' , α'' by the letters μ , ν ; and in this notation the equations of the lines of curvature of one system are of the form $\mu = \text{constant}$, and those of the other $\nu = \text{constant}$. The equation of a geodesic (Art. 402) becomes

$$\mu^2 \cos^2 i + \nu^2 \sin^2 i = \mu'^2;$$

and when the geodesic passes through an umbilic, we have $\mu'^2 = a^2 - b^2 = h^2$. It will be remembered (Arts. 159, 160) that μ lies between the limits k and h , and ν between the limits h and 0.

Throwing the equation of a geodesic into the form

$$\mu^2 + \nu^2 \tan^2 i = \mu'^2 (1 + \tan^2 i),$$

we see that it is satisfied (whatever be μ') by the values $\mu^2 = \nu^2$, $\tan^2 i = -1$. Hence it follows, that the same pair of imaginary tangents, drawn from an umbilic, touch all the lines of curvature,† a further analogy to the foci of plane conics.

* This method is evidently a particular case of that explained Art. 377. In Prof. Cayley's Memoir on Geodesics (*Proceedings of London Mathematical Society*, 1872, p. 199) he uses the coordinates in a slightly different form; viz. if any point on the quadric $\frac{x^2}{a} + \frac{y^2}{b} + \frac{z^2}{c} = 1$ is the intersection with it of the two confocals

$$\frac{x^2}{a+p} + \frac{y^2}{b+p} + \frac{z^2}{c+p} = 1, \quad \frac{x^2}{a+q} + \frac{y^2}{b+q} + \frac{z^2}{c+q} = 1;$$

then p and q are the two coordinates: $p = \text{const.}$, $q = \text{const.}$ denote lines of curvature; and we have, by Art. 160, expressions for x, y, z in terms of p and q . The differential equation of the right lines of the surface is

$$\frac{dp}{\sqrt{\{(a+p)(b+p)(c+p)\}}} \pm \frac{dq}{\sqrt{\{(a+q)(b+q)(c+q)\}}} = 0.$$

In the ordinary case where the surface is an ellipsoid and $a > b > c$, the coordinates p and q may be distinguished by supposing p to range between the limits $-a$, $-b$, and q between $-b$, $-c$.

† Mr. Roberts, *Liouville*, vol. xv. p. 289.

410. To express in elliptic coordinates the element of the arc of any curve on the surface. Let us consider, first, the element of any line of curvature, $\mu = \text{constant}$. Let that line be met by the two consecutive hyperboloids, whose axes are ν and $\nu + d\nu$; then, since it cuts them perpendicularly, the intercept between them is equal to the difference between the central perpendiculars on parallel tangent planes to the two hyperboloids. But (Art. 180) $(p'' + dp'')^2 - p''^2 = (\nu + d\nu)^2 - \nu^2$ or $p'' dp'' = \nu d\nu$. Now we have proved that $dp'' = d\sigma$, the element of the arc we are seeking, and

$$p''^2 = \frac{a''^2 b''^2 c''^2}{(a^2 - a''^2)(a'^2 - a''^2)} = \frac{\nu^2 (h^2 - \nu^2)(k^2 - \nu^2)}{(a^2 - \nu^2)(\mu^2 - \nu^2)}.$$

Hence
$$d\sigma^2 = \frac{(a^2 - \nu^2)(\mu^2 - \nu^2)}{(h^2 - \nu^2)(k^2 - \nu^2)} d\nu^2.$$

In like manner, the element of the arc of the line of curvature $\nu = \text{constant}$ is given by the formula

$$d\sigma'^2 = \frac{(a^2 - \mu^2)(\mu^2 - \nu^2)}{(\mu^2 - h^2)(k^2 - \mu^2)} d\mu^2.$$

Now, if through the extremities of the element of the arc ds of any curve we draw lines of curvature of both systems, we form an elementary rectangle of which $d\sigma$, $d\sigma'$ are the sides and ds the diagonal. Hence

$$ds^2 = \frac{(a^2 - \mu^2)(\mu^2 - \nu^2)}{(\mu^2 - h^2)(k^2 - \mu^2)} d\mu^2 + \frac{(a^2 - \nu^2)(\mu^2 - \nu^2)}{(h^2 - \nu^2)(k^2 - \nu^2)} d\nu^2.$$

411. In like manner we can express the area of any portion of the surface bounded by four lines of curvature; two lines μ_1, μ_2 , and two ν_1, ν_2 . For the element of the area is

$$d\sigma_1 d\sigma_2 = \frac{(\mu^2 - \nu^2) \sqrt{\{(a^2 - \mu^2)(a^2 - \nu^2)\}}}{\sqrt{\{(\mu^2 - h^2)(k^2 - \mu^2)(h^2 - \nu^2)(k^2 - \nu^2)\}}} d\mu d\nu,$$

the integral of which is

$$\int_{\mu_2}^{\mu_1} \frac{\mu^2 \sqrt{(a^2 - \mu^2)} d\mu}{\sqrt{\{(\mu^2 - h^2)(k^2 - \mu^2)\}}} \int_{\nu_2}^{\nu_1} \frac{\sqrt{(a^2 - \nu^2)} d\nu}{\sqrt{\{(h^2 - \nu^2)(k^2 - \nu^2)\}}} - \int_{\mu_2}^{\mu_1} \frac{\sqrt{(a^2 - \mu^2)} d\mu}{\sqrt{\{(\mu^2 - h^2)(k^2 - \mu^2)\}}} \int_{\nu_2}^{\nu_1} \frac{\nu^2 \sqrt{(a^2 - \nu^2)} d\nu}{\sqrt{\{(h^2 - \nu^2)(k^2 - \nu^2)\}}}.*$$

* The area of the surface of the ellipsoid was thus first expressed by Legendre *Traité des Fonctions Elliptiques*, vol. I. p. 352.

So, in like manner, we can find the *differential equation of the orthogonal trajectory of a curve* whose differential equation is $Md\mu + Ndv = 0$. For the orthogonal trajectory to $Pd\sigma + Qd\sigma'$ is plainly $\frac{d\sigma}{P} = \frac{d\sigma'}{Q}$; since $d\sigma, d\sigma'$ are a system of rectangular coordinates. But $Md\mu + Ndv$ can be thrown without difficulty into the form $Pd\sigma + Qd\sigma'$ by the equations of the last article. The equation of the orthogonal trajectory is thus found to be

$$\frac{a^2 - \mu^2}{(\mu^2 - h^2)(h^2 - \mu^2)} \frac{d\mu}{M} - \frac{a^2 - v^2}{(h^2 - v^2)(h^2 - v^2)} \frac{dv}{N} = 0.$$

412. The first integral of a geodesic $\mu^2 \cos^2 i + v^2 \sin^2 i = \mu'^2$ can be thrown into a form in which the variables are separated, and the *second integral can be obtained*. That equation gives

$$\tan i = \sqrt{\frac{(\mu^2 - \mu'^2)}{(\mu'^2 - v^2)}}.$$

But
$$\tan i = \frac{d\sigma'}{d\sigma} = \frac{\sqrt{\{(a^2 - \mu^2)(h^2 - v^2)(h^2 - v^2)\}}}{\sqrt{\{(a^2 - v^2)(\mu^2 - h^2)(h^2 - \mu^2)\}}} \frac{d\mu}{dv},$$

whence, equating, we have

$$\frac{\sqrt{(a^2 - \mu^2)} d\mu}{\sqrt{(\mu^2 - \mu'^2)(\mu^2 - h^2)(h^2 - \mu^2)}} \pm \frac{\sqrt{(a^2 - v^2)} dv}{\sqrt{\{(\mu'^2 - v^2)(h^2 - v^2)(h^2 - v^2)\}}} = 0,$$

the terms of which can be integrated separately.*

If the geodesic passes through the umbilics, we have $\mu'^2 = h^2$ (Art. 409), and the equation of the geodesic is

$$\frac{\sqrt{(a^2 - \mu^2)}}{(\mu^2 - h^2) \sqrt{(h^2 - \mu^2)}} d\mu \pm \frac{\sqrt{(a^2 - v^2)}}{(h^2 - v^2) \sqrt{(h^2 - v^2)}} dv = 0.$$

413. *To find an expression for the length of any portion of a geodesic.* The element of the geodesic is the hypotenuse of a right-angled triangle, of which $d\sigma, d\sigma'$ are the sides, and whose

* This is equivalent to Jacobi's first integral of the differential equation of the geodesic lines, see Art. 397; see also Hesse, *Vorlesungen*, p. 328. The reader is recommended also to refer to the method of integration employed by Weierstrass, *Monatsberichte der Berliner Akademie*, 1861, p. 986. The above equation in the notation used by Prof. Cayley is

$$dp \sqrt{\left\{ \frac{p}{(a+p)(b+p)(c+p)(\theta+p)} \right\}} \pm dq \sqrt{\left\{ \frac{q}{(a+q)(b+q)(c+q)(\theta+q)} \right\}} = 0,$$

where θ is the constant of integration. This is nearly the form given by Jacobi in the *Vorlesungen über Dynamik*, referred to in note to Art. 398.

base angle is i . Hence we have $ds = \sin i d\sigma' \pm \cos i d\sigma$; and putting in $\sin i = \frac{\sqrt{(\mu^2 - \mu'^2)}}{\sqrt{(\mu^2 - \nu^2)}}$, $\cos i = \frac{\sqrt{(\mu'^2 - \nu^2)}}{\sqrt{(\mu^2 - \nu^2)}}$, and giving $d\sigma, d\sigma'$ the values of Art. 410, we have

$$ds = d\mu \sqrt{\left\{ \frac{(\mu^2 - \mu'^2)(a^2 - \mu^2)}{(\mu^2 - h^2)(h^2 - \mu^2)} \right\}} \pm d\nu \sqrt{\left\{ \frac{(\mu'^2 - \nu^2)(a^2 - \nu^2)}{(h^2 - \nu^2)(k^2 - \nu^2)} \right\}}.$$

If ρ be the element of a line through the umbilics, we have

$$d\rho = d\mu \sqrt{\left(\frac{a^2 - \mu^2}{h^2 - \mu^2} \right)} \pm d\nu \sqrt{\left(\frac{a^2 - \nu^2}{k^2 - \nu^2} \right)}.$$

It is to be noted, that when we give to the radical in the last article the sign +, we must give that in this article the sign -. This appears by forming (Art. 411) the differential equation of the orthogonal trajectory to a geodesic through an umbilic, an equation which must be equivalent to $d\rho = 0$ (Art. 394).

414. In place of denoting the position of any point on an ellipsoid by the elliptic coordinates μ, ν , we might use *geodesic polar coordinates having the pole at an umbilic*, and denote a point by ρ its geodesic distance from an umbilic, and by ω the angle which that radius vector makes with the line joining the umbilics. Now the equation (Art. 413) of a geodesic passing through an umbilic gives the sum of two integrals equal to a constant. This constant cannot be a function of ρ , since it remains the same as we go along the same geodesic: it must therefore be a function of ω only; and if we pass from any point to an indefinitely near one, *not* on the same geodesic radius vector, we shall have

$$\frac{\sqrt{(a^2 - \mu^2)} d\mu}{(\mu^2 - h^2) \sqrt{(h^2 - \mu^2)}} \pm \frac{\sqrt{(a^2 - \nu^2)} d\nu}{(h^2 - \nu^2) \sqrt{(k^2 - \nu^2)}} = \phi'(\omega) d\omega.$$

We shall determine the form of the function by calculating its value for a point indefinitely near the umbilic, for which $\mu = \nu = h$. The limit of the left-hand side of the equation then becomes $\sqrt{\left(\frac{a^2 - h^2}{h^2 - h^2} \right)} \times \text{limit of } \left(\frac{d\mu}{\mu^2 - h^2} + \frac{d\nu}{h^2 - \nu^2} \right)$. Now, if we put $\mu = h + \eta, \nu = h - \varepsilon$, the quantity whose limit we want to find

is $\frac{d\eta}{2h\eta + \eta^2} - \frac{d\varepsilon}{2h\varepsilon - \varepsilon^2}$, which, as η and ε tend to vanish, becomes the limit of $\frac{1}{2h} \left(\frac{d\eta}{\eta} - \frac{d\varepsilon}{\varepsilon} \right)$ or of $\frac{1}{2h} d \log \frac{\eta}{\varepsilon}$.

Now since the angle external to the vertical angle of the triangle formed by the lines joining any point to two umbilics is bisected by the direction of the line of curvature, that external angle is double the angle i in the formula $\mu^2 \cos^2 i + \nu^2 \sin^2 i = h^2$. In the limit when the vertex of the triangle approaches the umbilic, the external angle of the triangle becomes ω , and we have at the umbilic

$$(h + \eta)^2 \cos^2 \frac{1}{2} \omega + (h - \varepsilon)^2 \sin^2 \frac{1}{2} \omega = h^2,$$

and in the limit $\tan^2 \frac{1}{2} \omega = \frac{\eta}{\varepsilon}$.

Using this value, the limit of the left-hand side of the equation is

$$\frac{1}{2h} \sqrt{\left(\frac{a^2 - h^2}{k^2 - h^2} \right)} d \left(\log \tan^2 \frac{1}{2} \omega \right).$$

We have therefore

$$\frac{\sqrt{(a^2 - \mu^2)} d\mu}{(\mu^2 - h^2) \sqrt{(k^2 - \mu^2)}} + \frac{\sqrt{(a^2 - \nu^2)} d\nu}{(h^2 - \nu^2) \sqrt{(k^2 - \nu^2)}} = \frac{1}{h} \sqrt{\left(\frac{a^2 - h^2}{k^2 - h^2} \right)} \frac{d\omega}{\sin \omega}.$$

And the constant which occurs in the integrated equation of a geodesic through an umbilic is of the form

$$\frac{1}{2h} \sqrt{\left(\frac{a^2 - h^2}{k^2 - h^2} \right)} \log \tan^2 \frac{1}{2} \omega + C.$$

415. If P, Q be two consecutive points on a curve, and if PP' be drawn perpendicular to the geodesic radius vector OQ , it is evident that $PQ^2 = PP'^2 + P'Q^2$. Now since (Art. 394) $OP = OP'$, we have $P'Q = d\rho$, while PP' being the element of an arc of a geodesic circle, for which ρ is constant (or $d\rho = 0$), must be of the form $Pd\omega$. Hence the element of the arc of a curve on any surface can be expressed by a formula $ds^2 = d\rho^2 + P^2 d\omega^2$. We propose now to examine the form of the function P for the case of radii vectores drawn through an umbilic of an ellipsoid. Let us consider the line of curvature $\mu = \mu'$. We have then (Art. 413)

$$ds^2 = d\nu^2 \frac{(\mu'^2 - \nu^2)(a^2 - \nu^2)}{(h^2 - \nu^2)(k^2 - \nu^2)}.$$

And by the same article

$$d\rho^2 = d\nu^2 \frac{a^2 - \nu^2}{k^2 - \nu^2},$$

whence

$$P^2 d\omega^2 = \frac{(\mu'^2 - h^2)(a^2 - \nu^2)}{(h^2 - \nu^2)(k^2 - \nu^2)} d\nu^2.$$

But (Art. 414), when μ is constant,

$$\frac{\sqrt{(a^2 - \nu^2)} d\nu}{(h^2 - \nu^2) \sqrt{(k^2 - \nu^2)}} = \frac{1}{h} \sqrt{\frac{(a^2 - h^2)}{(k^2 - h^2)}} \frac{d\omega}{\sin \omega}.$$

Putting in this value for $d\nu$, we have

$$P^2 = \frac{(a^2 - h^2)(h^2 - \nu^2)(\mu'^2 - h^2)}{h^2(k^2 - h^2)\sin^2 \omega} = \frac{b^2 b'^2 b''^2}{(b^2 - a^2)(b^2 - c^2)\sin^2 \omega} = \frac{y^2}{\sin^2 \omega}$$

(Art. 160); therefore $P = y \operatorname{cosec} \omega$.

In this investigation it is not necessary to assume the result of the last article. If we substitute for the right-hand side of the equation in the last article an undetermined function of ω , it is proved in like manner that $P = y\phi(\omega)$. We determine then the form of the function by remembering that in the neighbourhood of the umbilic the surface approaches to the form of a sphere. Now on a sphere the formula of rectification is $ds^2 = d\rho^2 + \sin^2 \rho d\omega^2$. Hence $P = \sin \rho$. But in the sphere $y = \sin \rho \sin \omega$. The function therefore which multiplies y is $\operatorname{cosec} \omega$.

416. Consider now the triangle formed by joining any point P to the two umbilics O, O' . Then for the arc OP we have the function $P = y \operatorname{cosec} \omega$, and for the arc $O'P$, connecting P with the other umbilic, we have the function $P' = y \operatorname{cosec} \omega'$; and $P : P' :: \sin \omega' : \sin \omega$, an equation analogous to that which expresses that the sines of the sides of a spherical triangle are proportional to the sines of the opposite angles, since P and P' in the rectification of arcs on the ellipsoid answer to $\sin \rho, \sin \rho'$ on the sphere.

417. Again, if P be any point on a line of curvature we know (Art. 400) $d\rho \pm d\rho' = 0$, where ρ and ρ' are the distances from the two umbilics. Now if θ be the angle which the radius vector OP makes with the tangent, the perpendicular

element $Pd\omega$ is evidently $d\rho \tan \theta$. But the radius vector $O'P$ makes also the angle θ with the tangent. Hence, we have

$$Pd\omega \pm P'd\omega' = 0, \text{ or } \frac{d\omega}{\sin \omega} \pm \frac{d\omega'}{\sin \omega'} = 0,$$

whence $\tan \frac{1}{2}\omega \tan \frac{1}{2}\omega'$ is constant when the sum of sides of the triangle is given; and $\tan \frac{1}{2}\omega$ is to $\tan \frac{1}{2}\omega'$ in a given ratio when the difference of sides of the triangle is given. Thus, then, the distance between two umbilics being taken as the base of a triangle, when either the product or the ratio of the tangents of the halves of the base angles is given, the locus of vertex is a line of curvature.*

From this theorem follow many corollaries: for instance, "if a geodesic through an umbilic O meet a line of curvature in points P, P' then (according to the species of the line of curvature) either the product or the ratio of $\tan \frac{1}{2}PO'O, \tan \frac{1}{2}P'O'O$ is constant." Again, "if the geodesics joining to the umbilics any point P on a line of curvature meet the curve again in P', P'' , the locus of the intersection of the transverse geodesics $O'P', OP''$ will be a line of curvature of the same species."

418. Mr. Roberts's expression for the element of an arc perpendicular to an umbilical geodesic has been extended as follows by Dr. Hart: Let OT, OT' be two consecutive geodesics touching the line of curvature formed by the intersection of the surface with a confocal B , $d\omega$ the angle at which they intersect; then the tangent at any point T of either

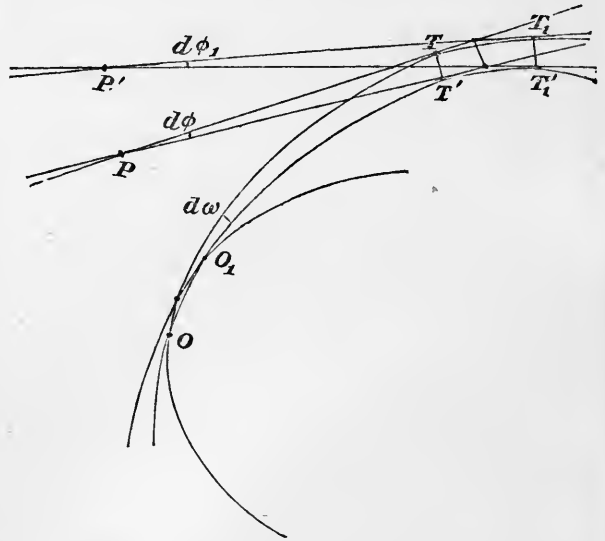

* This theorem, as well as those on which its proof depends (Art. 414, &c.), is due to Mr. M. Roberts, to whom this department of Geometry owes so much (*Liouville*, vols. XIII. p. 1, and xv. p. 275).

geodesic touches B in a point P (Art. 405); and if TT' be taken conjugate to TP , the tangent plane at T' passes through TP (Art. 268), and the tangent line to the geodesic at T' touches the confocal B in the same point P . We want now to express in the form $Pd\omega$ the perpendicular distance from T' to TP . Let the tangents at consecutive points, one on each geodesic, intersect in P' and make with each other an angle $d\phi'$. Let normals to the surface on which the geodesics are drawn at the points T_1, T_1' , meet the tangents PT, PT' at the points T_2, T_2' , then since the difference between T_1T_1', T_2T_2' is infinitely small of the third order, $PT_2d\phi$ and $P'T_2'd\phi'$ are equal, to the same degree of approximation. But $PT_2, P'T_2'$ are proportional to D and D' , the diameters of the surface B drawn parallel to the two successive tangents to the geodesic. Hence $Dd\phi = D'd\phi'$. This quantity therefore remains invariable as we proceed along the geodesic; but at the point O , $d\phi = d\omega$; if therefore D_0 be the diameter of B parallel to the tangent at O to the geodesic, $Dd\phi = D_0d\omega$; and therefore the distance we want to express $PTd\phi = \frac{D_0}{D}td\omega$, where $t (=PT)$ is the length of the tangent from T to the confocal B ; or $\frac{D_0}{D}t$ is a mean between the segments of a chord of B drawn through T parallel to the tangent at O . When the geodesic passes through an umbilic, the surface B reduces to the plane of the umbilics, and $\frac{D_0}{D}t$ becomes the line drawn through T to meet the plane of the umbilics parallel to the tangent at O , which is Mr. Roberts's expression.

Hence, *If a geodesic polygon circumscribe a line of curvature, and if all the angles but one move on lines of curvature, this also will move on a line of curvature, and the perimeter of the polygon will be constant when the lines of curvature are of the same species.* The proof is identical with that given for the corresponding property of plane conics (Conics, Art. 401).*

* See *Cambridge and Dublin Mathematical Journal*, vol. IV. p. 192.

419. If a geodesic joining any umbilic to that diametrically opposite, and making an angle ω with the plane of the umbilics, be continued so as to return to the first umbilic, it will not, as in the case of the sphere, then proceed on its former path, but after its return will make with the plane of the umbilics an angle different from ω . In order to prove this we shall investigate an expression for θ , the angle made with the plane of the umbilics by the osculating plane at any point of that geodesic.

It is convenient to prefix the following lemma: In a spherical triangle let one side and the adjacent angle remain finite while the base diminishes indefinitely, it is required to find the limit of the ratio of the base to the difference of the base angles measured in the same direction. The formula of spherical

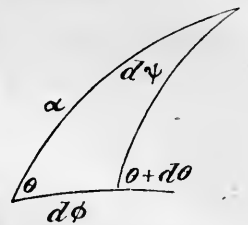

trigonometry $\cos \frac{1}{2}(A + B) = \sin \frac{1}{2}C \frac{\cos \frac{1}{2}(a + b)}{\cos \frac{1}{2}c}$ gives us in the limit $d\theta = \cos \alpha d\psi$. But evidently $\sin \alpha d\psi = \sin \theta d\phi$. Hence

$$\frac{d\theta}{\sin \theta} = \frac{d\phi}{\tan \alpha} .$$

Now we know (Art. 405) that the tangent line at any point of a geodesic passing through an umbilic, if produced, goes to meet the plane of the umbilics in a point on the focal hyperbola; and the osculating plane of the geodesic at that point will be the plane joining the point to the corresponding tangent of the focal hyperbola. We know also (Art. 184) that the cone circumscribing an ellipsoid, and whose vertex is any point on the focal hyperbola, is a right cone.

Let now PP' be an element of an umbilical geodesic produced to meet the focal hyperbola in H . Let $P'P''$ be the consecutive element meeting the focal hyperbola in H' ; then if Hh , $H'h'$ be two consecutive tangents to the focal hyperbola, PHh ,

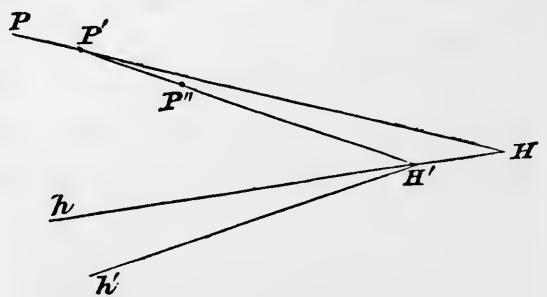

$P'H'h'$ will be two consecutive osculating planes. Imagine now a sphere round H' , and consider the spherical triangle formed by radii to the points h, h', P' . Then if $d\phi$ be the angle $hH'h'$, the angle of contact of the focal hyperbola; if θ be the angle between the osculating plane and $hH'h'$ the plane of the umbilics, while $hH'P'$ is α the semi-angle of the cone; the spherical triangle becomes that considered in our lemma, and we have $\frac{d\theta}{\sin \theta} = \frac{d\phi}{\tan \alpha}$.

In order to integrate this equation we must express $d\phi$ in terms of α ; and this we may regard as a problem in plane geometry, for α is half the angle included between the tangents from H to the principal section in the plane of the umbilics, while $d\phi$ is the angle of contact of the focal hyperbola at the same point. Now if $a', b'; a'', b''$ be the axes of an ellipse and hyperbola passing through H , confocal to an ellipse whose axes are a, b ; and if 2α be the angle included between the tangents from H to the latter ellipse, we have (see *Conics*, p. 189) $\tan^2 \alpha = \frac{a^2 - a''^2}{a'^2 - a^2}$. Differentiating, regarding a'' as constant (since we proceed to a consecutive point along the same confocal hyperbola), we have $d\alpha = -\tan \alpha \frac{a'da'}{a'^2 - a''^2}$. But

if, p, p' be the central perpendiculars on the tangents at H to the ellipse and hyperbola, we have $a'da' = pd\sigma$ (Art 410), where $d\sigma$ is the element of the arc of the focal hyperbola, and if ρ be the radius of curvature at the same point, $d\sigma = \rho d\phi$.

But $\rho = \frac{a'^2 - a''^2}{p'}$. Hence, $d\alpha = -\tan \alpha \frac{pd\phi}{p'}$ or $d\alpha = \tan \alpha \frac{a'b'd\phi}{a''b''}$.

But $a'^2 = a^2 + (a^2 - a''^2) \cot^2 \alpha$, $b'^2 = b^2 + (a^2 - a''^2) \cot^2 \alpha$.

Hence $\frac{d\phi}{\tan \alpha} = \frac{a''b''d\alpha}{\sqrt{(a^2 - a''^2 + a^2 \tan^2 \alpha)} \sqrt{(a^2 - a''^2 + b^2 \tan^2 \alpha)}}$.

In the case under consideration the axes of the touched ellipse are a, c ; while the squares of the axes of the confocal hyperbola are $a^2 - b^2, b^2 - c^2$. Hence we have the equation

$$\frac{d\theta}{\sin \theta} = \frac{\sqrt{(a^2 - b^2)} \sqrt{(b^2 - c^2)} d\alpha}{\sqrt{(b^2 + a^2 \tan^2 \alpha)} \sqrt{(b^2 + c^2 \tan^2 \alpha)}}.$$

Integrating this, and taking one limit of the integral at the umbilic where we have $\theta = \omega$, and $\alpha = \frac{1}{2}\pi$, we have

$$\log \frac{\tan \frac{1}{2}\theta}{\tan \frac{1}{2}\omega} = \int_{\frac{1}{2}\pi}^{\alpha} \frac{\sqrt{(\alpha^2 - b^2)} \sqrt{(b^2 - c^2)} d\alpha}{\sqrt{(b^2 + \alpha^2 \tan^2 \alpha)} \sqrt{(b^2 + c^2 \tan^2 \alpha)}}.$$

If, then, I be the value of this integral, we have $\tan \frac{1}{2}\theta = k \tan \frac{1}{2}\omega$, where $k = e^I$.

Now this integral obviously does not change sign between the limits $\pm \frac{1}{2}\pi$, that is to say, in passing from one umbilic to the other. If, then, ω' be the value of θ for the umbilic opposite to that from which we set out, at this limit I has a value different from zero, and k a value different from unity; and we have $\tan \frac{1}{2}\omega' = k \tan \frac{1}{2}\omega$; ω' is therefore always different from ω . And in like manner the geodesic returns to the original umbilic, making an angle ω'' such that $\tan \frac{1}{2}\omega'' = k^2 \tan \frac{1}{2}\omega$, and so it will pass and re-pass for ever, making a series of angles the tangents of whose halves are in continued proportion.*

420. If we consider edges belonging to the same tangent cone, whose vertex is any point H on the focal hyperbola, α (and therefore k) is constant; and the equation $\tan \frac{1}{2}\theta = k \tan \frac{1}{2}\omega$ gives $\frac{d\theta}{\sin \theta} = \frac{d\omega}{\sin \omega}$. Now since the osculating plane of the geodesic is normal to the surface, and therefore also normal to the tangent cone, it passes through the axis of that cone. If, then, we cut the cone by a plane perpendicular to the axis, the section is evidently a circle whose radius is $\frac{y}{\sin \theta}$, and the element of the arc is $\frac{y d\theta}{\sin \theta}$, or $\frac{y d\omega}{\sin \omega}$. Now this element, being the distance at their point of contact of two consecutive sides of the circumscribing cone, is what we have called (Art. 415) $Pd\omega$, and we have thus, from the investigation of the last article, an independent proof of the value found for P (Art. 415).

421. *Lines of level.* The inequalities of level of a country can be represented on a map by a series of curves marking

* The theorems of this article are Dr. Hart's, *Cambridge and Dublin Mathematical Journal*, vol. IV. p. 82; but in the mode of proof I have followed Mr. William Roberts, *Liouville*, 1857, p. 213.

the points which are on the same level. If a series of such curves be drawn, corresponding to equi-different heights, the places where the curves lie closest together evidently indicate the places where the level of the country changes most rapidly; the curve through the summit of a pass, or at the point of out-flow of a lake, has this point for a node, &c., &c.* Generally, the curves of level of any surface are the sections of that surface by a series of horizontal planes, which we may suppose all parallel to the plane of xy . The equations of the horizontal projections of such a series are got by putting $z = c$ in the equation of the surface; and a differential equation common to all these projections is got by putting $dz = 0$ in the differential equation of the surface, when we have

$$U_1 dx + U_2 dy = 0.$$

We can make this a function of x and y only, by eliminating the z , which may enter into the differential coefficients, by the help of the equation of the surface.

Lines of greatest slope. The line of greatest slope through any point is the line which cuts all the lines of level perpendicularly; and the differential equation of its projection therefore is

$$U_1 dy - U_2 dx = 0.$$

The line of greatest slope is often defined as such that the tangent at every point of it makes the greatest angle with the horizon. Now it is evident that the line in any tangent plane which makes the greatest angle with the horizon is that which is perpendicular to the horizontal trace of that plane. And we get the same equation as before by expressing that the projection of the element of the curve (whose direction-cosines are proportional to dx, dy) is perpendicular to the trace whose equation is $U_1(x - x') + U_2(y - y') - U_3 z' = 0$.†

* See Reech, sur les surfaces fermées, *Jour. de l'Ec. Polyt.* t. XXI. (1858), p. 169. Cayley on Contour and Slope Lines, *Phil. Mag.*, vol. XVIII., 1859, p. 264.

† It is evident that the differential equation of the curve, which is always perpendicular to the intersection of the tangent plane, [whose direction-cosines are as L, M, N] by a fixed plane whose direction-cosines are a, b, c , is

$$\begin{vmatrix} dx, & dy, & dz \\ L, & M, & N \\ a, & b, & c \end{vmatrix} = 0.$$

Ex. 1. To find the line of greatest slope on the quadric $Ax^2 + By^2 + Cz^2 = D$.

The differential equation is $Ax \, dy = By \, dx$, which, integrated, gives $\left(\frac{x}{x'}\right)^B = \left(\frac{y}{y'}\right)^A$, where the constant has been determined by the condition that the line shall pass through the point $x = x'$, $y = y'$. The line of greatest slope is the intersection of the quadric by the cylinder whose equation has just been written, and will be a curve of double curvature, except when $x'y'$ lies in one of the principal planes when the equation just found reduces to $x = 0$ or $y = 0$.

Ex. 2. The coordinates of any point on the hyperboloid of one sheet may be written $\frac{x}{a} = \frac{1 + \lambda\mu}{\lambda + \mu}$, $\frac{y}{b} = \frac{\lambda - \mu}{\lambda + \mu}$, $\frac{z}{c} = \frac{1 - \lambda\mu}{\lambda + \mu}$; show that if $p = \frac{a^2 - 2b^2 - c^2}{a^2 + c^2}$, the lines of curvature are determined by the equations (cf. note p. 370)

$$\frac{d\lambda}{\sqrt{(1 - 2p\lambda^2 + \lambda^4)}} \pm \frac{d\mu}{\sqrt{(1 - 2p\mu^2 + \mu^4)}} = 0.$$

Ex. 3. Express in the same system of coordinates the differential equation of geodesics on the surface.

CHAPTER XIII.

FAMILIES OF SURFACES.

SECTION I. PARTIAL DIFFERENTIAL EQUATIONS.

422. Let the equations of a curve

$$\phi(x, y, z, c_1, c_2 \dots c_n) = 0, \quad \psi(x, y, z, c_1, c_2 \dots c_n) = 0,$$

include n parameters, or undetermined constants; then it is evident that if n equations connecting these parameters be given, the curve is completely determined. If, however, only $n - 1$ relations between the parameters be given, the equations above written may denote an infinity of curves; and the assemblage of all these curves constitutes a surface whose equation is obtained by eliminating the n parameters from the given $n + 1$ equations; viz. the $n - 1$ relations, and the two equations of the curve. Thus, for example, if the two equations above written denote a variable curve, the motion of which is regulated by the conditions that it shall intersect $n - 1$ fixed directing curves, the problem is of the kind now under consideration. For, by eliminating x, y, z between the two equations of the variable curve, and the two equations of any one of the directing curves, we express the condition that these two curves should intersect, and thus have one relation between the n parameters. And having $n - 1$ such relations we find the equation of the surface generated in the manner just stated. We had (Art. 112) a particular case of this problem.

Those surfaces for which the form of the functions ϕ and ψ is the same are said to be *of the same family*, though the equations connecting the parameters may be different. Thus, if the motion of the same variable curve were regulated by several different sets of directing curves, all the surfaces generated would be said to belong to the same family. In several important cases, the equations of all surfaces belonging

to the same family can be included in one equation involving one or more arbitrary functions, the equation of any individual surface of the family being then got by particularizing the form of the functions. If we eliminate the arbitrary functions by differentiation, we get a partial differential equation, common to all surfaces of the family, which ordinarily is the expression of some geometrical property common to all surfaces of the family, and which leads more directly than the functional equation to the solution of some classes of problems.

423. The simplest case is when the equations of the variable curve include but two constants.* Solving in turn for each of these constants, we can throw the two given equations into the form $u = c_1$, $v = c_2$; where u and v are known functions of x , y , z . In order that this curve may generate a surface, we must be given one relation connecting c_1 , c_2 , which will be of the form $c_1 = \phi(c_2)$; whence putting for c_1 and c_2 their values, we see that, whatever be the equation of connection, the equation of the surface generated must be of the form $u = \phi(v)$.

We can also, in this case, readily obtain the partial differential equation, which must be satisfied by all surfaces of the family. For if $U=0$ represents any such surface, U can only differ by a constant multiplier from $u - \phi(v)$. Hence, we have $\lambda U = u - \phi(v)$, and differentiating

$$\lambda U_1 = u_1 - \phi'(v) v_1,$$

with two similar equations for the differentials with respect to y and z . Eliminating then λ and $\phi'(v)$, we get the required partial differential equation in the form of a determinant

$$\begin{vmatrix} U_1 & U_2 & U_3 \\ u_1 & u_2 & u_3 \\ v_1 & v_2 & v_3 \end{vmatrix} = 0.$$

In this case u and v are supposed to be known functions of the coordinates; and the equation just written establishes a relation of the first degree between U_1 , U_2 , U_3 .

If the equation of the surface were written in the form

* If there were but one constant, the elimination of it would give the equation of a definite surface, not of a family of surfaces.

$z - \phi(x, y) = 0$; we should have $U_3 = 1$, $U_1 = -p$, $U_2 = -q$, where p and q have the usual signification, and the partial differential equation of the family is of the form $Pp + Qq = R$, where P, Q, R are known functions of the coordinates. And, conversely, the integral of such a partial differential equation, which (see Boole's *Differential Equations*, p. 323) is of the form $u = \phi(v)$, geometrically represents a surface which can be generated by the motion of a curve whose equations are of the form $u = c_1$, $v = c_2$.

The partial differential equation affords the readiest test whether a given surface belongs to any assigned family. We have only to give to U_1, U_2, U_3 , their values derived from the equation of the given surface, which values must identically satisfy the partial differential equation of the family if the surface belong to that family.

424. If it be required to determine a particular surface of a given family $u = \phi(v)$, by the condition that the surface shall pass through a given curve, the form of the function in this case can be found by writing down the equations $u = c_1$, $v = c_2$, and eliminating x, y, z between these equations and those of the fixed curve, we thus find a relation between c_1 and c_2 , or between u and v , which is the equation of the required surface. The geometrical interpretation of this process is, that we direct the motion of a variable curve $u = c_1$, $v = c_2$ by the condition that it shall move so as always to intersect the given fixed curve. All the points of the latter are therefore points on the surface generated.

If it be required to find a surface of the family $u = \phi(v)$ which shall envelope a given surface, we know that at every point of the curve of contact U_1, U_2, U_3 have the same value for the fixed surface, and for that which envelopes it. If then, in the partial differential equation of the given family, we substitute for U_1, U_2, U_3 their values derived from the equation of the fixed surface, we get an equation which will be satisfied for every point of the curve of contact, and which therefore, combined with the equation of the fixed surface, determines that curve. The problem is, therefore, reduced to that

considered in the first part of this article; namely, to describe a surface of the given family through a given curve. All this theory will be better understood from the following examples of important families of surfaces belonging to the class here considered; viz. whose equations can be expressed in the form $u = \phi(v)$.

425. *Cylindrical Surfaces.* A cylindrical surface is generated by the motion of a right line, which remains always parallel to itself. Now the equations of a right line include four independent constants; if then the direction of the right line be given, this determines two of the constants, and there remain but two undetermined. The family of cylindrical surfaces belongs to the class considered in the last two articles.

Thus, if the equations of a right line be given in the form $x = lz + p$, $y = mz + q$; l and m which determine the direction of the right line are supposed to be given; and if the motion of the right line be regulated by any condition (such as that it shall move along a certain fixed curve, or envelope a certain fixed surface) this establishes a relation between p and q , and the equation of the surface comes out in the form

$$x - lz = \phi(y - mz).$$

More generally, if the right line is to be parallel to the intersection of the two planes $ax + by + cz$, $a'x + b'y + c'z$, its equations must be of the form

$$ax + by + cz = \alpha, \quad a'x + b'y + c'z = \beta,$$

and the equation of the surface generated must be of the form

$$ax + by + cz = \phi(a'x + b'y + c'z).$$

Writing $ax + by + cz$ for u , and $a'x + b'y + c'z$ for v in the equation of Art. 423, we see that the partial differential equation of cylindrical surfaces is

$$(bc' - cb') U_1 + (ca' - ac') U_2 + (ab' - ba') U_3 = 0,$$

or (Ex. 3, p. 26) $U_1 \cos \alpha + U_2 \cos \beta + U_3 \cos \gamma = 0$, where α , β , γ are the direction-angles of the generating line. Remembering that U_1 , U_2 , U_3 are proportional to the direction-cosines of the normal to the surface, it is obvious that the geometrical meaning

of this equation is, that the tangent plane to the surface is always parallel to the direction of the generating line.

Ex. 1. To find the equation of the cylinder whose edges are parallel to $x = lz$, $y = mz$, and which passes through the plane curve $z = 0$, $\phi(x, y) = 0$.

Ans. $\phi(x - lz, y - mz) = 0$.

Ex. 2. To find the equation of the cylinder whose sides are parallel to the intersection of $ax + by + cz = \delta$, $a'x + b'y + c'z$, and which passes through the intersection of $ax + \beta y + \gamma z = \delta$, $F(x, y, z) = 0$. Solve for x, y, z between the equations $ax + by + cz = u$, $a'x + b'y + c'z = v$, $ax + \beta y + \gamma z = \delta$, and substitute the resulting values in $F(x, y, z) = 0$.

Ex. 3. To find the equation of a cylinder, the direction-cosines of whose edges are l, m, n , and which passes through the curve $U = 0, V = 0$. The elimination may be conveniently performed as follows: If x', y', z' be the coordinates of the point where any edge meets the directing curve, x, y, z those of any point on the edge, we have $\frac{x - x'}{l} = \frac{y - y'}{m} = \frac{z - z'}{n}$. Calling the common value of these functions θ , we have

$$x' = x - l\theta, \quad y' = y - m\theta, \quad z' = z - n\theta.$$

Substitute these values in the equations $U = 0, V = 0$, which $x'y'z'$ must satisfy, and between the two resulting equations eliminate the unknown θ , the result will be the equation of the cylinder.

Ex. 4. To find the cylinder, the direction-cosines of whose edges are l, m, n , and which envelopes the quadric $Ax^2 + By^2 + Cz^2 = 1$. From the partial differential equation, the curve of contact is the intersection of the quadric with

$$Alx + Bmy + Cnz = 0.$$

Proceeding then, as in the last example, the equation of the cylinder is found to be

$$(Al^2 + Bm^2 + Cn^2)(Ax^2 + By^2 + Cz^2 - 1) = (Alx + Bmy + Cnz)^2.$$

426. *Conical Surfaces.* These are generated by the motion of a right line which constantly passes through a fixed point. Expressing that the coordinates of this point satisfy the equations of the right line, we have two relations connecting the four constants in the general equations of a right line. In this case, therefore, the equations of the generating curve contain but two undetermined constants, and the problem is of the kind discussed, Art. 423.

Let the equations of the generating line be

$$\frac{x - \alpha}{l} = \frac{y - \beta}{m} = \frac{z - \gamma}{n},$$

where α, β, γ are the known coordinates of the vertex of the cone, and l, m, n are proportional to the direction-cosines of the generating line; and where the equations, though apparently

containing three undetermined constants, actually contain only two, since we are only concerned with the ratios of the quantities l, m, n .

Writing the equations then in the form

$$\frac{x - \alpha}{z - \gamma} = \frac{l}{n}, \quad \frac{y - \beta}{z - \gamma} = \frac{m}{n},$$

we see that the conditions of the problem must establish a relation between $l : n$ and $m : n$, and that the equation of the cone must be of the form $\frac{x - \alpha}{z - \gamma} = \phi \left(\frac{y - \beta}{z - \gamma} \right)$.

It is easy to see that this is equivalent to saying that the equation of the cone must be a homogeneous function of the three quantities $x - \alpha, y - \beta, z - \gamma$; as may also be seen directly from the consideration that the conditions of the problem must establish a relation between the direction-cosines of the generator; that these cosines being: $l : \sqrt{\{(l^2 + m^2 + n^2)\}}$, &c., any equation expressing such a relation is a homogeneous function of l, m, n , and therefore of $x - \alpha, y - \beta, z - \gamma$, which are proportional to l, m, n .

When the vertex of the cone is the origin, its equation is of the form $\frac{x}{z} = \phi \left(\frac{y}{z} \right)$; or, in other words, is a homogeneous function of x, y, z .

The partial differential equation is found by putting $u = \frac{x - \alpha}{z - \gamma}, v = \frac{y - \beta}{z - \gamma}$, in the equation of Art. 423, and when cleared of fractions is

$$\begin{vmatrix} U_1 & U_2 & U_3 \\ z - \gamma & 0 & -(x - \alpha) \\ 0 & z - \gamma & -(y - \beta) \end{vmatrix} = 0,$$

$$\text{or} \quad (x - \alpha) U_1 + (y - \beta) U_2 + (z - \gamma) U_3 = 0.$$

This equation evidently expresses that the tangent plane at any point of the surface must always pass through the fixed point $\alpha\beta\gamma$.

We have already given in Ex. 7, p. 101, the method of forming the equation of the cone standing on a given curve;

and (Art. 277) the method of forming the equation of the cone which envelopes a given surface.

427. *Conoidal Surfaces.* These are generated by the motion of a line which always intersects a fixed axis and remains parallel to a fixed plane. These two conditions leave two of the constants in the equations of the line undetermined, so that these surfaces are of the class considered (Art. 423). If the axis is the intersection of the planes α, β , and the generator is to be parallel to the plane γ , the equations of the generator are $\alpha = c_1\beta, \gamma = c_2$, and the general equation of conoidal surfaces is obviously $\frac{\alpha}{\beta} = \phi(\gamma)$.*

The partial differential equation is (Art. 423)

$$\begin{vmatrix} U_1 & U_2 & U_3 \\ \beta\alpha_1 - \alpha\beta_1 & \beta\alpha_2 - \alpha\beta_2 & \beta\alpha_3 - \alpha\beta_3 \\ \gamma_1 & \gamma_2 & \gamma_3 \end{vmatrix} = 0,$$

where $\alpha = \alpha_1x + \alpha_2y + \alpha_3z + \alpha_4$, &c. The left-hand side of the equation may be expressed as the difference of two determinants $\beta(U_1\alpha_2\gamma_3) - \alpha(U_1\beta_2\gamma_3) = 0$.

This equation may be derived directly by expressing that the tangent plane at any point on the surface contains the generator; the tangent plane, therefore, the plane drawn through the point on the surface, parallel to the directing plane, and the plane $\alpha'\beta - \alpha\beta'$ joining the same point to the axis, have a common line of intersection. The terms of the determinant just written are the coefficients of x, y, z in the equations of these three planes.

In practice we are almost exclusively concerned with right conoids; that is, where the fixed axis is perpendicular to the directing plane. If that axis be taken as the axis of z , and the plane for plane of xy , the functional equation is $y = x\phi(z)$, and the partial differential equation is $xU_1 + yU_2 = 0$.

The lines of greatest slope (Art. 421) are in this case always

* In like manner the equation of any surface generated by the motion of a line meeting two fixed lines $\alpha\beta, \gamma\delta$ must be of the form $\frac{\alpha}{\beta} = \phi\left(\frac{\gamma}{\delta}\right)$.

projected into circles. For in virtue of the partial differential equation just written, the equation of Art. 421,

$$U_2 dx - U_1 dy = 0,$$

transforms itself into $x dx + y dy = 0$, which represents a series of concentric circles. The same thing is evident geometrically; for the lines of level are the generators of the system; and these being projected into a series of radii all passing through the origin, are cut orthogonally by a series of concentric circles.

Ex. 1. To find the equation of the right conoid passing through the axis of z and through a plane curve, whose equations are $x = a$, $F(y, z) = 0$. Eliminating then x, y, z between these equations and $y = c_1 x$, $z = c_2$, we get $F(c_1 a, c_2) = 0$; or the required equation is $F\left(\frac{ay}{x}, z\right) = 0$.

Wallis's cono-cuneus is when the fixed curve is a circle [$x = a$, $y^2 + z^2 = r^2$]. Its equation is therefore $a^2 y^2 + x^2 z^2 = r^2 x^2$.

Ex. 2. Let the directing curve be a helix, the fixed line being the axis of the cylinder on which the helix is traced. The equation is that given Ex. 1, Art. 371. This surface is often presented to the eye, being that formed by the under surface of a spiral staircase.

428. *Surfaces of Revolution.* The fundamental property of a surface of revolution is that its section perpendicular to its axis must always consist of one or more circles whose centres are on the axis. Such a surface may therefore be conceived as generated by a circle of variable radius whose centre moves along a fixed right line or axis, and whose plane is perpendicular to that axis. If the equations of the axis be $\frac{x - \alpha}{l} = \frac{y - \beta}{m} = \frac{z - \gamma}{n}$, then the generating circle in any position may be represented as the intersection of the plane perpendicular to the axis $lx + my + nz = c_1$, with the sphere whose centre is any fixed point on the axis,

$$(x - \alpha)^2 + (y - \beta)^2 + (z - \gamma)^2 = c_2.$$

These equations contain but two undetermined constants; the problem, therefore, is of the class considered (Art. 423), and the equation of the surface must be of the form

$$(x - \alpha)^2 + (y - \beta)^2 + (z - \gamma)^2 = \phi(lx + my + nz).$$

When the axis of z is the axis of revolution, we may take the origin as the point $\alpha\beta\gamma$, and the equation becomes

$$x^2 + y^2 + z^2 = \phi(z), \text{ or } z = \psi(x^2 + y^2).$$

The partial differential equation is found by the formula of Art. 423 to be

$$\begin{vmatrix} U_1 & U_2 & U_3 \\ l & m & n \\ x - \alpha & y - \beta & z - \gamma \end{vmatrix} = 0,$$

or $\{m(z - \gamma) - n(y - \beta)\} U_1$
 $+ \{n(x - \alpha) - l(z - \gamma)\} U_2 + \{l(y - \beta) - m(x - \alpha)\} U_3 = 0.$

When the axis of z is the axis of revolution, this reduces to

$$yU_1 - xU_2 = 0.$$

The partial differential equation expresses that the normal always meets the axis of revolution. For, if we wish to express the condition that the two lines

$$\frac{x - \alpha}{l} = \frac{y - \beta}{m} = \frac{z - \gamma}{n}, \quad \frac{x - x'}{U_1} = \frac{y - y'}{U_2} = \frac{z - z'}{U_3},$$

should intersect, we may write the common value of the equal fractions in each case, θ and θ' . Solving then for x, y, z , and equating the values derived from the equations of each line, we have

$$\alpha + l\theta = x' + U_1\theta', \quad \beta + m\theta = y' + U_2\theta', \quad \gamma + n\theta = z' + U_3\theta';$$

whence, eliminating θ, θ' , the result is the determinant already found

$$\begin{vmatrix} U_1 & U_2 & U_3 \\ l & m & n \\ x' - \alpha & y' - \beta & z' - \gamma \end{vmatrix} = 0.$$

429. The equation of the surface generated by the revolution of a given curve round a given axis is found (Art. 424) by eliminating x, y, z between

$$lx + my + nz = u, \quad (x - \alpha)^2 + (y - \beta)^2 + (z - \gamma)^2 = v,$$

and the two equations of the curve; replacing then u and v by their values. We have already had an example of this (Ex. 3, p. 99), and we take, as a further example, "to find the surface

generated by the revolution of a circle [$y = 0, (x - a)^2 + z^2 = r^2$] round an axis in its plane [the axis of z]."

Putting $z = u, x^2 + y^2 = v$, and eliminating between these equations and those of the circle, we get

$$\{\sqrt{(v) - a}\}^2 + u^2 = r^2, \text{ or } \{\sqrt{(x^2 + y^2) - a}\}^2 + z^2 = r^2,$$

which, cleared of radicals, is

$$(x^2 + y^2 + z^2 + a^2 - r^2)^2 = 4a^2 (x^2 + y^2).$$

It is obvious that when a is greater than r , that is to say, when the revolving circle does not meet the axis, neither can the surface, which will be the form of an anchor ring, the space about the axis being empty. On the other hand, when the revolving circle meets the axis, the segments into which the axis divides the circle generate distinct sheets of the surface, intersecting in points on the axis $z = \sqrt{(r^2 - a^2)}$, which are nodal points on the surface.

The sections of the anchor ring by planes parallel to the axis are found by putting $y = \text{constant}$ in the preceding equation. The equation of the section may immediately be thrown into the form $SS' = \text{constant}$, where S and S' represent circles. The sections are Cassinians of various kinds (see fig. *Higher Plane Curves*, p. 44). It is geometrically evident, that as the plane of section moves away from the axis, it continues to cut in two distinct ovals, until it touches the surface [$y = a - r$] when it cuts in a curve having a double point [Bernoulli's Lemniscate]; after which it meets in a continuous curve.

Ex. Verify that $x^3 + y^3 + z^3 - 3xyz = r^3$ is a surface of revolution.

Ans. The axis of revolution is $x = y = z$.

430. The families of surfaces which have been considered are the most interesting of those whose equations can be expressed in the form $u = \phi(v)$. We now proceed to the case when the equations of the generating curve include more than two parameters. By the help of the equations connecting these parameters, we can, in terms of any one of them, express all the rest, and thus put the equations of the generating curve into the form

$$F\{x, y, z, c, \phi(c), \psi(c), \&c.\} = 0, f\{x, y, z, c, \phi(c), \psi(c), \&c.\} = 0.$$

The equation of the surface generated is obtained by eliminating c between these equations; and, as has been already stated, all surfaces are said to be of the same family for which the form of the functions F and f is the same, whatever be the forms of the functions ϕ , ψ , &c. But since evidently the elimination cannot be effected until some definite form has been assigned to the functions ϕ , ψ , &c., it is not generally possible to form a single functional equation including all surfaces of the same family; and we can only represent them, as above written, by a pair of equations from which there remains a constant to be eliminated. We can, however, eliminate the arbitrary functions by differentiation, and obtain a partial differential equation, common to all surfaces of the same family; the order of that equation being, as we shall presently prove, equal to the number of arbitrary functions ϕ , ψ , &c.

It is to be remarked, however, that in general the order of the partial differential equation obtained by the elimination of a number of arbitrary functions from an equation is higher than the number of functions eliminated. Thus, if an equation include two arbitrary functions ϕ , ψ , and if we differentiate with respect to x and y , which we take as independent variables, the differential equations combined with the original one form a system of three equations containing four unknown functions ϕ , ψ , ϕ' , ψ' . The second differentiation (twice with regard to x , twice with regard to y , and with regard to x and y) gives us three additional equations; but, then, from the system of six equations it is not generally possible to eliminate the six quantities ϕ , ψ , ϕ' , ψ' , ϕ'' , ψ'' . We must, therefore, proceed to a third differentiation before the elimination can be effected. It is easy to see, in like manner, that to eliminate n arbitrary functions we must differentiate $2n - 1$ times. The reason why, in the present case, the order of the differential equation is less, is that the functions eliminated are all functions of the same quantity.

431. In order to show this, it is convenient to consider first the special case, where a family of surfaces can be expressed by a single functional equation. This will happen when it is

possible by combining the equations of the generating curve to separate one of the constants so as to throw the equations into the form $u = c_1$; $F(x, y, z, c_1, c_2 \dots c_n) = 0$. Then expressing, by means of the equations of condition, the other constants in terms of c_1 , the result of elimination is plainly of the form

$$F\{x, y, z, u, \phi(u), \psi(u), \&c.\} = 0.$$

Now, if we denote by F_1 , the differential with respect to x of the equation of the surface, on the supposition that u is constant, and similar differentials in y, z by F_2, F_3 , we have

$$U_1 = F_1 + \frac{dF}{du} u_1, \quad U_2 = F_2 + \frac{dF}{du} u_2, \quad U_3 = F_3 + \frac{dF}{du} u_3.$$

But, in these equations, the derived functions $\phi', \psi', \&c.$, only enter in the term $\frac{dF}{du}$; they can, therefore, be all eliminated together, and we can form the equation, homogeneous in U_1, U_2, U_3 ,

$$\begin{vmatrix} U_1 & U_2 & U_3 \\ F_1 & F_2 & F_3 \\ u_1 & u_2 & u_3 \end{vmatrix} = 0,$$

which contains only the original functions $\phi, \psi, \&c.$ If we write this equation $V = 0$, we can form from it, in like manner, the equation

$$\begin{vmatrix} U_1 & U_2 & U_3 \\ V_1 & V_2 & V_3 \\ u_1 & u_2 & u_3 \end{vmatrix} = 0,$$

which still contains no arbitrary functions but the original $\phi, \psi, \&c.$, but which contains the second differential coefficients of U , these entering into V_1, V_2, V_3 . From the equation last found we can in like manner form another, and so on; and from the series of equations thus obtained (the last being of the n^{th} order of differentiation) we can eliminate the n functions $\phi, \psi, \&c.$

If we omit the last of these equations we can eliminate all but one of the arbitrary functions, and according to our choice of the function to be retained, can obtain n different equations of the order $n - 1$, each containing one arbitrary function.

These are the first integrals of the final differential equation of the n^{th} order. In like manner we can form $\frac{1}{2}n(n-1)$ equations of the second order, each containing two arbitrary functions, and so on.

432. If we take x and y as the independent variables, and as usual write $dz = p dx + q dy$, $dp = r dx + s dy$, &c., the process of forming these equations may be more conveniently stated as follows: "Take the total differential of the given equation on the supposition that u is constant,

$$F_1 dx + F_2 dy + F_3 (p dx + q dy) = 0;$$

put $dy = m dx$, and substitute for m its value derived from the differential of $u = 0$, viz.

$$u_1 dx + u_2 dy + u_3 (p dx + q dy) = 0."$$

For, if we differentiate the given equation with respect to x and y , we get

$$F_1 + p F_3 + \frac{dF}{du} (u_1 + p u_3) = 0,$$

$$F_2 + q F_3 + \frac{dF}{du} (u_2 + q u_3) = 0,$$

and the result of eliminating $\frac{dF}{du}$ from these two equations is the same as the result of eliminating m between the equations

$$F_1 + p F_3 + m (F_2 + q F_3) = 0, \quad u_1 + p u_3 + m (u_2 + q u_3) = 0.$$

It is convenient in practice to choose for one of the equations representing the generating curve its projection on the plane of xy ; then, since this equation does not contain z , the value of m derived from it will not contain p or q , and the first differential equation will be of the form

$$p + qm = R,$$

R being also a function not containing p or q . The only terms then containing r , s , or t in the second differential equation are those derived from differentiating $p + qm$, and that equation will be of the form

$$r + 2sm + tm^2 = S,$$

where S may contain x , y , z , p , q , but not r , s , or t . If now

we had only two functions to eliminate, we should solve for these constants from the original functional equation of the surface, and from $p + qm = R$; and then substituting these values in m and in S , the *form* of the final second differential equation would still remain

$$r + 2sm' + tm'^2 = S',$$

where m' and S' might contain x, y, z, p, q . In like manner if we had three functions to eliminate, and if we denote the partial differentials of z of the third order by $\alpha, \beta, \gamma, \delta$, the partial differential equation would be of the form

$$\alpha + 3m\beta + 3m^2\gamma + m^3\delta = T.$$

And so on for higher orders. This theory will be illustrated by the examples which follow.

433. *Surfaces generated by lines parallel to a fixed plane.* This is a family of surfaces which includes conoids as a particular case. Let us, in the first place, take the fixed plane for the plane of xy . Then the equations of the generating line are of the form $z = c_1, y = c_2x + c_3$. The functional equation of the surface is got by substituting in the latter equation for $c_2, \phi(z)$, and for $c_3, \psi(z)$. Since in forming the partial differential equation we are to regard z as constant, we may as well leave the equations in the form $z = c_1, y = c_2x + c_3$. These give us

$$p + qm = 0, \quad m = c_2.$$

According as we eliminate c_3 or c_2 , these equations give us $p + qc_2 = 0, px + qy = qc_3$. There are, therefore, two equations of the first order, each containing one arbitrary function, viz.

$$p + q\phi(z) = 0, \quad px + qy = q\psi(z).$$

To eliminate arbitrary functions completely, differentiate $p + qm = 0$, remembering that since $m = c_2$, it is to be regarded as constant, when we get

$$r + 2sm + tm^2 = 0,$$

and eliminating m by means of $p + qm = 0$, the required equation is

$$q^2r - 2pqs + p^2t = 0,$$

Next let the generating line be parallel to $ax + by + cz$; its equations are

$$ax + by + cz = c_1, \quad y = c_2x + c_3;$$

and the functional equation of the family of surfaces is got by writing for c_2 and c_3 , functions of $ax + by + cz$. Differentiating, we have

$$a + cp + m(b + cq) = 0, \quad m = c_2.$$

The equations got by eliminating one arbitrary function are therefore

$$\begin{aligned} a + cp + (b + cq) \phi(ax + by + cz) &= 0, \\ (a + cp)x + (b + cq)y &= (b + cq) \psi(ax + by + cz). \end{aligned}$$

Differentiating $a + bm + c(p + mq) = 0$, and remembering that m is to be regarded as constant, we have

$$r + 2sm + tm^2 = 0,$$

and introducing the value of m already found,

$$(b + cq)^2 r - 2(a + cp)(b + cq)s + (a + cp)^2 t = 0.$$

434. This equation may also be arrived at by expressing that the tangent planes at two points on the same generator intersect, as they evidently must, on that generator. Let α, β, γ be the running coordinates, x, y, z those of the point of contact; then any generator is the intersection of the tangent plane

$$\gamma - z = p(\alpha - x) + q(\beta - y),$$

with a plane through the point of contact parallel to the fixed plane

$$a(\alpha - x) + b(\beta - y) + c(\gamma - z) = 0,$$

whence $(a + cp)(\alpha - x) + (b + cq)(\beta - y) = 0$.

Now if we pass to the line of intersection of this tangent plane with a consecutive plane, α, β, γ remain the same, while x, y, z, p, q vary. Differentiating the equation of the tangent plane, we have

$$(r dx + s dy)(\alpha - x) + (s dx + t dy)(\beta - y) = 0.$$

And eliminating $\alpha - x, \beta - y$,

$$(b + cq)(r dx + s dy) = (a + cp)(s dx + t dy).$$

But since the point of contact moves along the generator which is parallel to the fixed plane, we have

$$adx + bdy + cdz = 0, \text{ or } (a + cp) dx + (b + cq) dy = 0.$$

Eliminating then dx, dy from the last equation, we have, as before,

$$(b + cq)^2 r - 2(a + cp)(b + cq)s + (a + cp)^2 t = 0.$$

435. *Surfaces generated by lines which meet a fixed axis.* This class also includes the family of conoids. In the first place let the fixed axis be the axis of z ; then the equations of the generating line are of the form $y = c_1 x, z = c_2 x + c_3$; and the equation of the family of surfaces is got by writing in the latter equation for c_2 and c_3 , arbitrary functions of $y : x$. Differentiating, we have $m = c_1, p + mq = c_2$, whence

$$px + qy = x\phi\left(\frac{y}{x}\right), \text{ and } z - px - qy = \psi\left(\frac{y}{x}\right).$$

Differentiating again, we have $r + 2sm + tm^2 = 0$, and putting

for m its value $= c_1 = \frac{y}{x}$, the required differential equation is

$$rx^2 + 2sxy + ty^2 = 0.$$

This equation may also be obtained by expressing that two consecutive tangent planes intersect in a generator. As, in the last article, we have for the intersection of two consecutive tangent planes

$$(rdx + sdy)(\alpha - x) + (sdx + tdy)(\beta - y) = 0.$$

But any generator lies in the plane $\alpha y = \beta x$, or $(\alpha - x)y = (\beta - y)x$. Eliminating therefore,

$$x(rdx + sdy) + y(sdx + tdy) = 0.$$

But $\frac{dy}{dx} = \frac{\beta}{\alpha} = \frac{y}{x}$. Therefore, as before, $rx^2 + 2sxy + ty^2 = 0$.

More generally, let the line pass through a fixed axis $\alpha\beta$, where $\alpha = ax + by + cz + d, \beta = a'x + b'y + c'z + d'$. Then the equations of the generating line are $\alpha = c_1\beta, y = c_2x + c_3$, and the equation of the family of surfaces is $y = x\phi\frac{\alpha}{\beta} + \psi\frac{\alpha}{\beta}$. Differentiating, we have

$$m = c_2, a + cp + m(b + cq) = c_1 \{a' + c'p + m(b' + c'q)\}.$$

Differentiating again, we have $r + 2sm + tn^2 = 0$, and putting in for m from the last equation, the required partial differential equation is

$$\{(a + cp) \beta - (a' + c'p) \alpha\}^2 t + \{(b + cq) \beta - (b' + c'q) \alpha\}^2 r - 2 \{(a + cp) \beta - (a' + c'p) \alpha\} \{(b + cq) \beta - (b' + c'q) \alpha\} s = 0.$$

436. If the equation of a family of surfaces contain n arbitrary functions of the same quantity, and if it be required to determine a surface of the family which shall pass through n fixed curves, we write down the equations of the generating curve $u = c_1, F(x, y, z, c_1, c_2, \&c.) = 0$, and expressing that the generating curve meets each of the fixed curves, we have a sufficient number of equations to eliminate $c_1, c_2, \&c.$ Thus, to find a surface of the family $x + y\phi(z) + \psi(z) = 0$ which shall pass through the fixed curves $y = a, F(x, z) = 0; y = -a, F_1(x, z) = 0$. The equations of the generating line being $z = c_1, x = yc_2 + c_3$, we have, by substitution,

$$F(ac_2 + c_3, c_1) = 0, F_1(c_3 - ac_2, c_1) = 0,$$

or, replacing for c_1, c_3 , their values,

$$F\{x + c_2(a - y), z\} = 0, F_1\{x - c_2(a + y), z\} = 0,$$

and by eliminating c_2 between these the required surface is found.

Ex. Let the directing curves be

$$y = a, \frac{x^2}{b^2} + \frac{z^2}{c^2} = 1, y = -a, x^2 + z^2 = c^2,$$

we eliminate c_2 between

$$\frac{\{x + c_2(a - y)\}^2}{b^2} + \frac{z^2}{c^2} = 1, \{x - c_2(a + y)\}^2 + z^2 = c^2.$$

Solving for c_2 from each, we have

$$\frac{\frac{b}{c} \sqrt{(c^2 - z^2)} - x}{a - y} = \frac{x - \sqrt{(c^2 - z^2)}}{a + y}.$$

The result is apparently of the eighth degree, but is resolvable into two conoids distinguished by giving the radicals the same or opposite signs in the last equation.

437. We have now seen, that when the equation of a family of surfaces contains a number of arbitrary functions of the same quantity, it is convenient, in forming the partial differential

equation, to substitute for the equation of the surface, the two equations of the generating curve. It is easy to see, then, that this process is equally applicable when the family of surfaces cannot be expressed by a single functional equation. The arbitrary functions which enter into the equations (Art. 430) are all functions of the same quantity, though the expression of that quantity in terms of the coordinates is unknown. If then differentiating that quantity gives $dy = m dx$, we can eliminate the unknown quantity m , between the total differentials of the two equations of the generating curve, and so obtain the partial differential equation required. In practice it is convenient to choose for one of the equations of the generating curve, its projection on the plane xy .

For example, let it be required to find the *general equation of ruled surfaces*: that is to say, of surfaces generated by the motion of a right line. The equations of the generating line are $z = c_1 x + c_3$, $y = c_2 x + c_4$, and the family of surfaces is expressed by substituting for c_2 , c_3 , c_4 arbitrary functions of c_1 . Differentiating, we have $p + mq = c_1$, $m = c_2$. Differentiating the first of these equations, m being proved to be constant by the second, we have $r + 2sm + tm^2 = 0$. As this equation still includes m or c_2 , the expression for which, in terms of the coordinates is unknown, we must differentiate again, when we have $\alpha + 3\beta m + 3\gamma m^2 + \delta m^3 = 0$, where α , β , γ , δ are the third differential coefficients. Eliminating m between the cubic and quadratic just found, we have the required partial differential equation. It evidently resolves itself into the two linear equations of the third order got by substituting in turn for m in the cubic the two roots of the quadratic.

This equation might be got geometrically by expressing that the tangent planes at three consecutive points on a generator pass through that generator. The equation $p dx + q dy = dz$ is a relation between p , q , -1 , which are proportional to the direction-cosines of a tangent plane, while dx , dy , dz are proportional to the direction-cosines of any line in that plane passing through the point of contact. If, then, we pass to a second tangent plane, through a consecutive point on the same line, we are to make p , q vary while the mutual ratios of dx , dy , dz remain constant.

This gives $rdx^2 + 2sdxdy + tdy^2 = 0$. To pass to a third tangent plane, we differentiate again, regarding $dx : dy$ constant; and thus have $adx^3 + 3\beta dx^2dy + 3\gamma dxdy^2 + \delta dy^3 = 0$. Eliminating $dx : dy$ between the last two equations, we have the same equation as before.

The first integrals of this equation are found, as explained (Art. 431), by omitting the last equation and eliminating all but one of the constants. Thus we have the equation $p + mq = c_1$, from which it appears that one of the integrals is $p + mq = \phi(m)$, where m is one of the roots of $r + 2sm + tm^2 = 0$. The other two first integrals are

$$y - mx = \psi(m), \text{ and } z - px - mqy = \chi(m).$$

The three second integrals are got by eliminating m from any pair of these equations.

438. *Envelopes.* If the equation of a surface include n parameters connected by $n - 1$ relations, we can in terms of any one express all the rest, and throw the equation into the form

$$z = F\{x, y, c, \phi(c), \psi(c), \&c.\}.$$

Eliminating c between this equation and $\frac{dF}{dc} = 0$, which we shall write $F' = 0$, we find the envelope of all the surfaces obtained by giving different values to c . The envelopes so found are said to be of the same family as long as the form of the function F remains the same, no matter how the forms of the functions $\phi, \psi, \&c.$ vary. The curve of intersection of the given surface with F' is the *characteristic* (see p. 290) or line of intersection of two consecutive surfaces of the system. Considering the characteristic as a moveable curve from the two equations of which c is to be eliminated, it is evident that the problem of envelopes is included in that discussed Art. 430, &c. If the function F contain n arbitrary functions $\phi, \psi, \&c.$, then since F' contains $\phi', \psi', \&c.$, it would seem, according to the theory previously explained, that the partial differential equation of the family ought to be of the $2n^{\text{th}}$ order. But on examining the manner in which these functions enter, it is easy to see that

the order reduces to the n^{th} . In fact, differentiating the equation $z = F$, we get

$$p = F_1 + \frac{dF}{dc} c_1, \quad q = F_2 + \frac{dF}{dc} c_2, \quad \text{that is, } p = F_1 + c_1 F', \quad q = F_2 + c_2 F',$$

but since $F' = 0$, we have $p = F_1, q = F_2$, where, since F_1 and F_2 are the differentials on the supposition that c is constant, these quantities only contain the original functions ϕ, ψ and not the derived ϕ', ψ' . From this pair of equations we can form another, as in the last article, and so on, until we come to the n^{th} order, when, as easily appears from what follows, we have equations enough to eliminate all the parameters.

439. We need not consider the case when the given equation contains but one parameter, since the elimination of this between the equation and its differential gives rise to the equation of a definite surface and not of a family of surfaces. Let the equation then contain two parameters a, b , connected by an equation giving b as a function of a , then between the three equations $z = F, p = F_1, q = F_2$, we can eliminate a, b , and the form of the result is evidently $f(x, y, z, p, q) = 0$.

For example, let us examine the envelope of a sphere of fixed radius, whose centre moves along any plane curve in the plane of xy . This is a particular case of the general class of tubular surfaces which we shall consider presently.

Now the equation of such a sphere being

$$(x - \alpha)^2 + (y - \beta)^2 + z^2 = r^2,$$

and the conditions of the problem assigning a locus along which the point $\alpha\beta$ is to move, and therefore determining β in terms of α , the equation of the envelope is got by eliminating α between

$$(x - \alpha)^2 + \{y - \phi(\alpha)\}^2 + z^2 = r^2, \quad (x - \alpha) + \{y - \phi(\alpha)\} \phi'(\alpha) = 0.$$

Since the elimination cannot be effected until the form of the function ϕ is assigned, the family of surfaces can only be expressed by the combination of two equations just written. We might also obtain these equations by expressing that the surface is generated by a fixed circle, which moves so that its plane shall be always perpendicular to the path along which

its centre moves. For the equation of the tangent to the locus of $\alpha\beta$ is

$$y - \beta = \frac{d\beta}{d\alpha}(x - \alpha) \text{ or } y - \phi(\alpha) = \phi'(\alpha)(x - \alpha).$$

And the plane perpendicular to this is

$$(x - \alpha) + \{y - \phi(\alpha)\} \phi'(\alpha) = 0,$$

as already obtained. To obtain the partial differential equation, differentiate the equation of the sphere, regarding α, β as constant, when we have $x - \alpha + pz = 0, y - \beta + qz = 0$. Solving for $x - \alpha, y - \beta$ and substituting in the equation of the sphere, the required equation is

$$z^2(1 + p^2 + q^2) = r^2.$$

We might have at once obtained this equation as the geometrical expression of the fact that the length of the normal is constant and equal to r , as it obviously is.

440. Before proceeding further we wish to show how the arbitrary functions which occur in the equation of a family of envelopes can be determined by the conditions that the surface in question passes through given curves. The tangent line to one of the given curves at any point of course lies in the tangent plane to the required surface; but since the enveloping surface has at any point the same tangent plane as the enveloped surface which passes through that point, it follows that each of the given curves at every point of it touches the enveloped surface which passes through that point. If, then, the equation of the enveloped surface be

$$z = F(x, y, c_1, c_2 \dots c_n),$$

the envelope of this surface can be made to pass through $n - 1$ given curves; for by expressing that the surface, whose equation has been just written, touches each of the given curves, we obtain $n - 1$ relations between the constants $c_1, c_2, \&c.$, which, combined with the two equations of the characteristic, enable us to eliminate these constants. For example, the family of surfaces discussed in the last article contains but two constants and one arbitrary function, and can therefore

be made to pass through one given curve. Let it then be required to find an envelope of the sphere

$$(x - \alpha)^2 + (y - \beta)^2 + z^2 = r^2,$$

which shall pass through the right line $x = mz, y = 0$. The points of intersection of this line with the sphere being given by the quadratic

$$(mz - \alpha)^2 + \beta^2 + z^2 = r^2, \text{ or } (1 + m^2)z^2 - 2mz\alpha + \alpha^2 + \beta^2 - r^2 = 0,$$

the condition that the line should touch the sphere is

$$(1 + m^2)(\alpha^2 + \beta^2 - r^2) = m^2\alpha^2.$$

We see thus, that the locus of the centres of spheres touching the given line is an ellipse. The envelope required, then, is a kind of elliptical anchor ring, whose equation is got by eliminating α, β between

$$(x - \alpha)^2 + (y - \beta)^2 + z^2 = r^2, \quad (1 + m^2)(\alpha^2 + \beta^2 - r^2) = m^2\alpha^2,$$

$$(x - \alpha)d\alpha + (y - \beta)d\beta = 0, \quad \alpha d\alpha + (1 + m^2)\beta d\beta = 0,$$

from which last two equations we have

$$(1 + m^2)\beta(x - \alpha) = \alpha(y - \beta).$$

The result is a surface of the eighth degree.

441. Again, let it be required to determine the arbitrary function so that the envelope surface may also envelope a given surface. At any point of contact of the required surface with the fixed surface $z = f(x, y)$, the moveable surface $z = F(x, y, c_1, c_2, \&c.)$ which passes through that point, has also the same tangent plane as the fixed surface. The values then of p and q derived from the equations of the fixed surface and of the moveable surface must be the same. Thus we have $f_1 = F_1, f_2 = F_2$, and if between these equations and the two equations $z = F, z = f$, which are satisfied for the point of contact, we eliminate x, y, z , the result will give a relation between the parameters. The envelope may thus be made to envelope as many fixed surfaces as there are arbitrary functions in the equation. Thus, for example, let it be required to determine a tubular surface of the kind discussed in last article, which shall touch the sphere $x^2 + y^2 + z^2 = R^2$. This

surface must then touch $(x - \alpha)^2 + (y - \beta)^2 + z^2 = r^2$. We have therefore $x : y : z = x - \alpha : y - \beta : z$; conditions which imply $z = 0$, $\beta x = \alpha y$. Eliminating x and y by the help of these equations, between the equation of the fixed and moveable sphere, we get $4(\alpha^2 + \beta^2)R^2 = (R^2 - r^2 + \alpha^2 + \beta^2)^2$. This gives a quadratic for $\alpha^2 + \beta^2$, whose roots are $(R \pm r)^2$; showing that the centre of the moveable sphere moves on one or other of two circles, the radius being either $R \pm r$. The surface required is therefore one or other of two anchor rings, the opening of the rings corresponding to the values just assigned.

442. We add one or two more examples of families of envelopes whose equations include but one arbitrary function. To find the envelope of a right cone whose axis is parallel to the axis of z , and whose vertex moves along any assigned curve in the plane of xy . Let the equation of the cone in its original position be $z^2 = m^2(x^2 + y^2)$; then if the vertex be moved to the point α, β , the equation of the cone becomes $z^2 = m^2\{(x - \alpha)^2 + (y - \beta)^2\}$, and if we are given a curve along which the vertex moves, β is given in terms of α . Differentiating, we have $pz = m^2(x - \alpha)$, $qz = m^2(y - \beta)$; and eliminating, we have $p^2 + q^2 = m^2$. This equation expresses that the tangent plane to the surface makes a constant angle with the plane of xy , as is evident from the mode of generation. It can easily be deduced hence, that the area of any portion of the surface is in a constant ratio to its projection on the plane of xy .

443. The families of surfaces, considered (Arts. 439, 442), are both included in the following: "To find the envelope of a surface of any form which moves without rotation, its motion being directed by a curve along which any given point of the surface moves." Let the equation of the surface in its original position be $z = F(x, y)$, then if it be moved without turning so that the point originally at the origin shall pass to the position $\alpha\beta\gamma$, the equation of the surface will evidently be $z - \gamma = F(x - \alpha, y - \beta)$. If we are given a curve along which the point $\alpha\beta\gamma$ is to move, we can express α, β in terms of γ ,

and the problem is one of the class to be considered in the next article, where the equation of the envelope includes two arbitrary functions. Let it be given, however, that the directing curve is drawn on a certain known surface, then, of the two equations of the directing curve, one is known and only one arbitrary, so that the equation of the envelope includes but one arbitrary function. Thus, if we assume β an arbitrary function of α , the equation of the fixed surface gives γ as a known function of α, β . It is easy to see how to find the partial differential equation in this case. Between the three equations $z - \gamma = F(x - \alpha, y - \beta), p = F_1(x - \alpha, y - \beta), q = F_2(x - \alpha, y - \beta)$, solve for $x - \alpha, y - \beta, z - \gamma$, when we find

$$x - \alpha = f(p, q), \quad y - \beta = 'f(p, q), \quad z - \gamma = ``f(p, q).$$

If, then, the equation of the surface along which $\alpha\beta\gamma$ is to move be $\Gamma(\alpha, \beta, \gamma) = 0$, the required partial differential equation is

$$\Gamma\{x - f(p, q), y - 'f(p, q), z - ``f(p, q)\} = 0.$$

The three functions $f, 'f, ``f$, are evidently connected by the relation $d``f = pdf + qd'f$.

It is easy to see that the partial differential equation just found is the expression of the fact, that the tangent plane at any point on the envelope is parallel to that at the corresponding point on the original surface.

Ex. To find the partial differential equation of the envelope of a sphere of constant radius whose centre moves along any curve traced on a fixed equal sphere

$$x^2 + y^2 + z^2 = r^2.$$

The equation of the moveable sphere is $(x - \alpha)^2 + (y - \beta)^2 + (z - \gamma)^2 = r^2$, whence

$$x - \alpha + p(z - \gamma) = 0, \quad y - \beta + q(z - \gamma) = 0,$$

and we have

$$x - \alpha = \frac{-pr}{(1 + p^2 + q^2)^{\frac{1}{2}}}, \quad y - \beta = \frac{-qr}{(1 + p^2 + q^2)^{\frac{1}{2}}}, \quad z - \gamma = \frac{r}{(1 + p^2 + q^2)^{\frac{1}{2}}}.$$

If we write $1 + p^2 + q^2 = \rho^2$ it is easy to see, by actual differentiation, that the relation is fulfilled

$$d\frac{1}{\rho} = -pd\left(\frac{p}{\rho}\right) - qd\left(\frac{q}{\rho}\right).$$

The partial differential equation is

$$(x\rho + pr)^2 + (y\rho + qr)^2 + (z\rho - r)^2 = \rho^2 r^2,$$

or
$$(z^2 + y^2 + z^2)(1 + p^2 + q^2)^{\frac{3}{2}} + 2(px + qy - z)r = 0.$$

444. We now proceed to investigate the form of the partial differential equation of the envelope, when the equation of the moveable surface contains three constants connected by two relations. If the equation of the surface be $z = F(x, y, a, b, c)$, then we have $p = F_1, q = F_2$. Differentiating again, as in Art. 432, we have

$$r + sm = F_{11} + mF_{12}, \quad s + tm = F_{12} + mF_{22};$$

and eliminating m , the required equation* is

$$(r - F_{11})(t - F_{22}) = (s - F_{12})^2.$$

The functions F_{11}, F_{12}, F_{22} contain a, b, c , for which we are to substitute their values in terms of p, q, x, y, z derived from solving the preceding three equations, when we obtain an equation of the form

$$Rr + 2Ss + Tt + U(rt - s^2) = V,$$

where R, S, T, U, V are connected by the relation

$$RT + UV = S^2.$$

445. The following examples are among the most important of the cases where the equation includes three parameters.

Developable Surfaces. These are the envelope of the plane $z = ax + by + c$, where for b and c we may write $\phi(a)$ and $\psi(a)$. Differentiating, we have $p = a, q = b$, whence $q = \phi(p)$. Any surface therefore is a developable surface if p and q are connected by a relation independent of x, y, z . Thus the family (Art. 442) for which $p^2 + q^2 = m^2$, is a family of developable surfaces. We have also $z - px - qy = \psi(p)$, which is the other first integral of the final differential equation. This last is got by differentiating again the equations $p = a, q = b$, when we have $r + sm = 0, s + tm = 0$, and eliminating $m, rt - s^2 = 0$, which is the required equation.

By comparing Arts. 295, 311, it appears that the condition $rt = s^2$ is satisfied at every parabolic point on a surface. The

* I owe to Professor Boole my knowledge of the fact, that when the equation of the moveable surface contains three parameters, the partial differential equation is of the form stated above. See his Memoir, *Phil. Trans.*, 1862, p. 437.

same thing may be shewn directly by transforming the equation $rt - s^2 = 0$ into a function of the differential coefficients of U , by the help of the relations

$$\begin{aligned} U_1 + pU_3 &= 0, & U_2 + qU_3 &= 0, \\ U_{11} + 2U_{13}p + U_{33}p^2 &= -rU_3; & U_{12} + pU_{23} + qU_{13} + pqU_{33} &= -sU_3; \\ U_{22} + 2U_{23}q + U_{33}q^2 &= -tU_3; \end{aligned}$$

when the equation $rt - s^2 = 0$ is found to be identical with the equation of the Hessian. We see, accordingly, that every point on a developable is a parabolic point, as is otherwise evident, for since (Art. 330) the tangent plane at any point meets the surface in two coincident right lines, the two inflexional tangents at that point coincide. The Hessian of a developable must therefore always contain the equation of the surface itself as a factor. The Hessian of a surface of any degree n being of the degree $4n - 8$, that of a developable consists of the surface itself, and a surface of $3n - 8$ degree which we shall call the Pro-Hessian.

In order to find in what points the developable is met by the Pro-Hessian, I form the Hessian of the developable surface of the r^{th} degree, see Arts. (329, 330) $xu + y^2v = 0$, and find that we get the developable itself multiplied by a series of terms in which the part independent of x and y is $v \left\{ \frac{d^2u}{dz^2} \frac{d^2u}{dw^2} - \left(\frac{d^2u}{dzdw} \right)^2 \right\}$. This proves that any generator xy meets the Pro-Hessian in the first place, where xy meets v ; that is to say, twice in the point on the cuspidal curve (m), and in $r - 4$ points on the nodal curve (x) Art. 330; and in the second place, where the generator meets the Hessian of u considered as a binary quantic; that is to say, in the Hessian of the system formed by these $r - 4$ points combined with the point on (m) taken three times; in which Hessian the latter point will be included four times. The intersection of any generator with the Pro-Hessian consists of the point on (m) taken six times, of the $r - 4$ points on (x), and of $2(r - 5)$ other points, in all $3r - 8$ points.*

* Prof. Cayley has calculated the equation of the Pro-Hessian (*Quarterly Journal*, vol. VI, p. 108) in the case of the developables of the fourth and fifth orders, and of

446. *Tubular Surfaces.* Let it be required to find the differential equation of the envelope of a sphere of constant radius, whose centre moves on any curve. We have, as in Art. 443,

$$(x - \alpha)^2 + (y - \beta)^2 + (z - \gamma)^2 = R^2,$$

$$x - \alpha + p(z - \gamma) = 0, \quad y - \beta + q(z - \gamma) = 0,$$

whence $1 + p^2 + (z - \gamma)r + m\{pq + (z - \gamma)s\} = 0,$

$$pq + (z - \gamma)s + m\{1 + q^2 + (z - \gamma)t\} = 0.$$

And therefore

$$\{1 + p^2 + (z - \gamma)r\} \{1 + q^2 + (z - \gamma)t\} = \{pq + (z - \gamma)s\}^2.$$

Substituting for $z - \gamma$ its value $\frac{R}{(1 + p^2 + q^2)^{\frac{1}{2}}}$ from the first three equations, this becomes

$$R^2(rt - s^2) - R\{(1 + q^2)r - 2pqs + (1 + p^2)t\} \sqrt{(1 + p^2 + q^2) + (1 + p^2 + q^2)^2} = 0,$$

which denotes, Art. 311, that at any point on the required envelope one of the two principal radii of curvature is equal to R , as is geometrically evident.

447. We shall briefly show what the form of the differential equation is when the equation of the surface whose envelope is sought contains four constants. We have, as before, in addition to the equation of the surface, the three equations $p = F_1, q = F_2, (r - F_{11})(t - F_{22}) = (s - F_{12})^2$. Let us, for shortness, write the last equation $\rho\tau = \sigma^2$, and let us write $\alpha - F_{11} = A, \beta - F_{12} = B, \gamma - F_{122} = C, \delta - F_{222} = D$; then, differentiating $\rho\tau = \sigma^2$, we have

$$(A + Bm)\tau + (C + Dm)\rho - 2(B + Cm)\sigma = 0.$$

Substituting for m from the equation $\sigma + \tau m = 0$, and remembering that $\rho\tau = \sigma^2$, we have

$$A\tau^3 - 3B\sigma\tau^2 + 3C\sigma^2\tau - D\sigma^3 = 0,$$

that of the sixth order considered, Art. 348. The Pro-Hessian of the developable of the fourth order is identical with the developable itself. In the other two cases the cuspidal curve is a cuspidal curve also on the Pro-Hessian, and is counted six times in the intersection of the two surfaces. I suppose it may be assumed that this is generally true. The nodal curve is but a simple curve on the Pro-Hessian, and therefore is only counted twice in the intersection.

in which equation we are to substitute for the parameters implicitly involved in it, their values derived from the preceding equations. The equation is, therefore, of the form

$$\alpha + 3\beta m + 3\gamma m^2 + \delta m^3 = U,$$

where m and U are functions of x, y, z, p, q, r, s, t . In like manner we can form the differential equation when the equation of the moveable surface includes a greater number of parameters.

448. Having in the preceding articles explained how partial differential equations are formed, we shall next show how from a given partial differential equation can be derived another differential equation satisfied by every characteristic of the family of surfaces to which the given equation belongs (see Monge, p. 53). In the first place, let the given equation be of the first order; that is to say, of the form $f(x, y, z, p, q) = 0$. Now if this equation belong to the envelope of a moveable surface, it will be satisfied, not only by the envelope, but also by the moveable surface in any of its positions. This follows from the fact, that the envelope touches the moveable surface, and therefore that at the point of contact x, y, z, p, q are the same for both. Now if x, y, z be the coordinates of any point on the characteristic, since such a point is the intersection of two consecutive positions of the moveable surface, the equation $f(x, y, z, p, q) = 0$ will be satisfied by these values of x, y, z , whether p and q have the values derived from one position of the moveable surface or from the next consecutive. Consequently, if we differentiate the given equation, regarding p and q as alone variable, then the points of the characteristic must satisfy the equation

$$Pdp + Qdq = 0.$$

Or we might have stated the matter as follows: Let the equation of the moveable surface be $z = F(x, y, \alpha)$, where the constants have all been expressed as functions of a single parameter α . Then (Art. 438) we have $p = F_1(x, y, \alpha)$, $q = F_2(x, y, \alpha)$, which values of p and q may be substituted in the given equation. Now the characteristic is expressed by

combining with the given equation its differential with respect to α ; and α only enters into the given equation in consequence of its entering into the values for p and q . Hence we have, as before, $P \frac{dp}{d\alpha} + Q \frac{dq}{d\alpha} = 0$.

Now since the tangent line to the characteristic at any point of it lies in the tangent plane to either of the surfaces which intersect in that point, the equation $dz = p dx + q dy$ is satisfied, whether p and q have the values derived from one position of the moveable surface or from the next consecutive. We have therefore $\frac{dp}{d\alpha} dx + \frac{dq}{d\alpha} dy = 0$. And combining this equation with that previously found, we obtain the differential equation of the characteristic $P dy - Q dx = 0$.

Thus, if the given equation be of the form $Pp + Qq = R$, the characteristic satisfies the equation $P dy - Q dx = 0$, from which equation, combined with the given equation and with $dz = p dx + q dy$, can be deduced $P dz = R dx$, $Q dz = R dy$. The reader is aware (see Boole's *Differential Equations*, p. 323) of the use made of those equations in integrating this class of equations. In fact, if the above system of simultaneous equations integrated give $u = c_1$, $v = c_2$, these are the equations of the characteristic or generating curve in any of its positions, while in order that v may be constant whenever u is constant we must have $u = \phi(v)$.

Ex. Let the equation be that considered (Art. 439), viz. $z^2(1 + p^2 + q^2) = r^2$, then any characteristic satisfies the equation $p dy = q dx$, which indicates (Art. 421) that the characteristic is always a line of greatest slope on the surface, as is geometrically evident.

449. The equation just found for the characteristic generally includes p and q , but we can eliminate these quantities by combining with the equation just found the given partial differential equation and the equation $dz = p dx + q dy$. Thus, in the last example, from the equations $z^2(1 + p^2 + q^2) = r^2$, $q dx = p dy$, we derive

$$z^2(dx^2 + dy^2 + dz^2) = r^2(dx^2 + dy^2).$$

The reader is aware that there are two classes of differential equations of the first order, one derived from the equation of

a single surface, as, for instance, by the elimination of any constant from an equation $U=0$, and its differential

$$U_1 dx + U_2 dy + U_3 dz = 0.$$

An equation of this class expresses a relation between the direction-cosines of every tangent line drawn at any point on the surface. The other class is obtained by combining the equations of two surfaces, as, for instance, by eliminating three constants between the equations $U=0$, $V=0$, and their differentials. An equation of this second class expresses a relation satisfied by the direction-cosines of the tangent to any of the curves which the system U, V represents for any value of the constants. The equations now under consideration belong to the latter class. Thus the geometrical meaning of the equation chosen for the example is, that the tangent to any of the curves denoted by it makes with the plane of xy an angle whose cosine is $z : r$. This property is true of every circle in a vertical plane whose radius is r ; and the equation might be obtained by eliminating by differentiation the constants α, β, m , between the equations

$$(x - \alpha)^2 + (y - \beta)^2 + z^2 = r^2, \quad x - \alpha + m(y - \beta) = 0.$$

450. The differential equation found, as in the last article, is not only true for every characteristic of a family of surfaces, but since each characteristic touches the cuspidal edge of the surface generated, the ratios $dx : dy : dz$ are the same for any characteristic and the corresponding cuspidal edge; and consequently the equation now found is satisfied by the cuspidal edge of every surface of the family under consideration. Thus, in the example chosen, the geometrical property expressed by the differential equation not only is true for a circle in a vertical plane, but remains true if the circle be wrapped on any vertical cylinder; and the cuspidal edge of the given family of surfaces always belongs to the family of curves thus generated.

Precisely as a partial differential equation in p, q (expressing as it does a relation between the direction-cosines of the tangent plane) is true as well for the envelope as for the particular surfaces enveloped, so the total differential equations here

considered are true both for the cuspidal edge and the series of characteristics which that edge touches. The same thing may be stated otherwise as follows: the system of equations $U=0, \frac{dU}{d\alpha}=0$, which represents the characteristic when α is regarded as constant, represents the cuspidal edge when α is an unknown function of the variables to be eliminated by means of the equation $\frac{d^2U}{d\alpha^2}=0$. But the equations $U=0, \frac{dU}{d\alpha}=0$ evidently have the same differentials as if α were constant, when α is considered to vary, subject to this condition.

Thus, in the example of the last article, if in the equations $(x-\alpha)^2 + (y-\beta)^2 + z^2 = r^2, (x-\alpha) + m(y-\beta) = 0$, we write $\beta = \phi(\alpha), m = \phi'(\alpha)$, and combine with these the equation $1 + \phi'(\alpha)^2 = (y-\beta)\phi''(\alpha)$, the differentials of the first and second equations are the same when α is variable in virtue of the third equation, as if it were constant; and therefore the differential equation obtained by eliminating α, β, m between the first two equations and their differentials, on the supposition that these quantities are constant, holds equally when they vary according to the rules here laid down. And we shall obtain the equations of a curve satisfying this differential equation by giving any form we please to $\phi(\alpha)$, and then eliminating α between the equations

$$(x-\alpha)^2 + \{y-\phi(\alpha)\}^2 + z^2 = r^2, \quad (x-\alpha) + \phi'(\alpha)\{y-\phi(\alpha)\} = 0, \\ 1 + \{\phi'(\alpha)\}^2 = \{y-\phi(\alpha)\}\phi''(\alpha).*$$

* It is convenient to insert here a remark made by Mr. M. Roberts, viz. that if in the equation of any surface we substitute for $x, x + \lambda dx$, for $y, y + \lambda dy$, for $z, z + \lambda dz$, and then form the discriminant with respect to λ , the result will be the differential equation of the cuspidal edge of any developable enveloping the given surface. In fact it is evident (see Art. 277) that the discriminant expresses the condition that the tangent to the curve represented by it touch the given surface. Thus the general equation of the cuspidal edge of developables circumscribing a sphere is

$$(x^2 + y^2 + z^2 - a^2)(dx^2 + dy^2 + dz^2) = (xdx + ydy + zdz)^2, \\ \text{or } (ydz - zdy)^2 + (zdx - xdz)^2 + (xdy - ydx)^2 = a^2(dx^2 + dy^2 + dz^2).$$

In the latter form it is evident that the same equation is satisfied by a geodesic traced on any cone whose vertex is the origin. For if the cone be developed into a plane, the geodesic will become a right line; and if the distance of that line from the origin be a , then the area of the triangle formed by joining any element ds to the origin is half ads , but this is evidently the property expressed by the preceding equation.

451. In like manner can be found the differential equation of the characteristic, the given partial differential equation being of the second order (see Monge, p. 74). In this case we can have two consecutive surfaces, satisfying the given differential equation, and touching each other all along their line of intersection. For instance, if we had a surface generated by a curve moving so as to meet two fixed directing curves, we might conceive a new surface generated by the same curve meeting two new directing curves, and if these latter directing curves touch the former at the points where the generating curve meets them, it is evident that the two surfaces touch along this line. In the case supposed, then, the two surfaces have x, y, z, p, q common along their line of intersection and can differ only with regard to r, s, t . Differentiate then the given differential equation, considering these quantities alone variable, and let the result be $Rdr + Sds + Tdt = 0$. But, since p and q are constant along this line, we have $drdx + dsdy = 0, dsdx + dt dy = 0$. Eliminating then dr, ds, dt , the required equation for the characteristic is

$$Rdy^2 - Sdx dy + Tdx^2 = 0.$$

In the case of all the equations of the second order, which we have already considered, this equation turns out a perfect square. When it does not so turn out, it breaks up into two factors, which, if rational, belong to two independent characteristics represented by separate equations; and if not, denote two branches of the same curve intersecting on the point of the surface which we are considering.

452. In fact, when the motion of a surface is regulated by a single parameter (see Art. 321), the equation of its envelope, as we have seen, contains only functions of a single quantity, and the differential equation belongs to the simpler species just referred to. But if the motion of the surface be regulated by two parameters, its contact with its envelope being not a curve, but a point, then the equation of the envelope will in general contain functions of two quantities, and the differential equation will be of the more general form. As an illustration of the occurrence of the latter class of equations in

geometrical investigations, we take the equation of the family of surfaces which has one set of its lines of curvature parallel to a fixed plane, $y = mx$. Putting $dy = m dx$ in the equation of Art. 310, the differential equation of the family is

$$m^2 \{(1 + q^2)s - pqt\} + m \{(1 + q^2)r - (1 + p^2)t\} - \{(1 + p^2)s - pqr\} = 0.$$

As it does not enter into the plan of this work to treat of the integration of such equations, we refer to Monge, p. 161, for a very interesting discussion of this equation. Our object being only to show how such differential equations present themselves in geometry, we shall show that the preceding equation arises from the elimination of α, β between the following equation and its differentials with respect to α and β :

$$(x - \alpha)^2 + (y - \beta)^2 + \{z - \phi(\alpha + m\beta)\}^2 = \psi(\beta - m\alpha)^2.$$

Differentiating with respect to α and β , we have

$$(x - \alpha) + (z - \phi) \phi' = m \psi' \psi,$$

$$(y - \beta) + m(z - \phi) \phi' = -\psi' \psi,$$

whence $(x - \alpha) + m(y - \beta) + (1 + m^2)(z - \phi) \phi' = 0$.

But we have also

$$(x - \alpha) + p(z - \phi) = 0, \quad (y - \beta) + q(z - \phi) = 0,$$

whence $(x - \alpha) + m(y - \beta) + (p + mq)(z - \phi) = 0$.

And, by comparison with the preceding equation, we have $p + mq = (1 + m^2) \phi'(\alpha + m\beta)$. If, then, we call $\alpha + m\beta, \gamma$, the problem is reduced to eliminate γ between the equations

$$x + my - \gamma + (p + mq)\{z - \phi(\gamma)\} = 0, \quad p + mq = (1 + m^2) \phi'(\gamma).$$

Differentiating with regard to x and y , we have

$$(1 + p^2 + mpq) + (r + ms)\{z - \phi(\gamma)\} = \{1 + (p + mq) \phi'\} \gamma_1,$$

$$\{m(1 + q^2) + pq\} + (s + mt)\{z - \phi(\gamma)\} = \{1 + (p + mq) \phi'\} \gamma_2,$$

but from the second equation

$$r + ms : s + mt :: \gamma_1 : \gamma_2.$$

Hence, the result is

$$(1 + p^2 + mpq)(s + mt) = \{m(1 + q^2) + pq\}(r + ms),$$

as was to be proved.

SECTION II. COMPLEXES, CONGRUENCIES, RULED SURFACES.*

453. The preceding families of cylindrical surfaces, conical surfaces and conoidal surfaces, are all included in the more general family of ruled surfaces; but it is natural to consider these from a somewhat different point of view. We start with the right line, as a curve containing four parameters. Considering these as arbitrary, we have the whole system of lines in space; but we may imagine the parameters connected by a single equation, or by two, three, or four equations (more accurately, by a one-fold, two-fold, three-fold or four-fold relation). In the last case we have merely a system consisting of a finite number of right lines, and this may be excluded from consideration; the remaining cases are those of a one-fold, two-fold, and three-fold relation, or may be called those of a triple, double, or single system of right lines.

A. The parameters have a one-fold relation. We have here what Plücker has termed a "complex" of lines. As examples, we have the system of lines which touch any given surface whatever, or which meet any given curve whatever, but it is important to notice, as has been already remarked in Art. 80*d* and in Art. 316 (*D*), that these are particular cases only; the lines belonging to a complex do not in general touch one and the same surface, or meet one and the same curve.

We may, in regard to a complex, ask how many of the lines thereof meet each of three given lines, and the number in question may be regarded as the "order" of the complex.

B. The parameters have a two-fold relation. We have here a "congruency" of lines. A well-known example is that

* In Sir W. R. Hamilton's second supplement on Systems of Rays. *Transactions of the Royal Irish Academy*, vol. XVI., were first investigated the properties of a congruency other than that formed by the normals to a surface. As to the theory of complexes and congruences see Plücker's posthumous work, *Neue Geometrie des Raumes gegründet auf die Betrachtung der geraden Linie als Raumelement*, Leipzig, 1868, edited by Dr. Klein; also Kummer's Memoirs, *Crelle* LVII. p. 189; and "Ueber die algebraischen Strahlensysteme, in's Besondere über die der ersten und zweiten Ordnung," *Berl. Abh.* 1866, pp. 1—120; and various Memoirs by Klein and others. As regards ruled surfaces see M. Chasles's Memoir, Quetelet's *Correspondance*, t. XI. p. 50, and Prof. Cayley's paper, *Cambridge and Dublin Mathematical Journal*, vol. VII. p. 171; also his Memoir, "On Scrolls otherwise Skew Surfaces," *Philosophical Transactions*, 1863, p. 453, and later Memoirs.

of the normals of a given surface. Each of these touches at two points (the centres of curvature) a certain surface, the centro-surface or locus of the centres of curvature of the given surface, and the normals are thus bitangents of the centro-surface. And so, in general, we have as a congruency of lines the system of the bitangents of a given surface. But more than this, every congruency of lines may be regarded as the system of the bitangents of a certain surface, for each line of the congruency is in general met by two consecutive lines, and the locus of the points of intersection is the surface in question. The surface may, however, break up into two separate surfaces, and the original surface, or each or either of the component surfaces may degenerate into a curve; we have thus as congruencies the systems of lines,

- (1) the bitangents of a surface,
- (2) lines "through two points" of a curve,
- (3) common tangents of two surfaces,
- (4) tangents to a surface from the points of a curve,
- (5) common transversals of two curves,

the last four cases being, as it were, degenerate cases of the first, which is the general one.

We may, in regard to a congruency, ask how many of the lines thereof meet each of two given lines? the number in question is the "order-class" of the congruency. But imagine the two given lines to intersect; the lines of the congruency are either the lines which pass through the point of intersection of the two given lines, or else the lines which lie in the common plane of the two given lines, and the questions thus arise: (1) How many of the lines of the congruency pass through a given point? the number is the "order" of the congruency. (2) How many of the lines of the congruency lie in a given plane? the number is the "class" of the congruency. The sum of these numbers is the order-class, as above defined.

C. Relation between the parameters three-fold. We have here a "regulus" of lines or ruled-surface, that generated by a series of lines depending on a single variable parameter. The "order" of the system is the number of lines of the system which meet a given right line.

454. In accordance with Plücker's work on the right line considered as an element of space, we must therefore first consider the properties of a complex; that is to say, of a system of lines which satisfy a single relation between the six coordinates. If this relation be of the n^{th} degree, the complex is of the n^{th} degree; all the lines of it which pass through a given point form a cone of the n^{th} order, and those which lie in a given plane, envelope a curve of the n^{th} class (see Art. 80*d*). If, for instance, the complex be of the first order, all the lines which pass through a given point lie in a given plane; and, reciprocally, those which lie in a given plane pass through a given point. To each line in space corresponds a conjugate line, the points of the one line corresponding to the planes which pass through the other. Any line which meets two conjugate lines will be a line of the complex. When five lines of such a complex are given, it is evident, by counting the number of constants, that the complex is determined; and what has just been said enables us to construct geometrically the plane answering to any point. For, taking any four lines of the complex, the two lines which meet these four are conjugate lines, and the line passing through the assumed point and meeting the conjugate lines is a line of the complex. A second line is determined in like manner, and the two together determine the plane.

If we consider a series of parallel planes, to each corresponds a single point, and the locus of these points is therefore a line of the first order, which right line may be called the diameter of the system of planes. To the plane infinity corresponds a point at infinity, and through this point all the diameters pass; that is to say, they are parallel. One of the diameters is perpendicular to the corresponding plane, and this diameter may be called the axis of the complex. If the axis and a line of the complex be given, the complex is determined; and the complex in fact consists of the different positions which this line can assume whether by rotation round the axis or by translation in a direction parallel to the axis. When the line meets the axis we have the limiting case of a complex consisting of all lines which meet a given one. It will be remembered (Art. 57*c*) that the condition that a complex shall be of this nature is that its coefficients shall satisfy the equation $AF+BG+CH=0$.

455. We have a congruency of the first order when we have two equations each of the first degree between the six coordinates; or, in other words, the congruency consists of the lines common to two given complexes. We may evidently for either of the two given equations $Ap + Bq + \&c. = 0$, $A'p + \&c. = 0$, substitute any equation of the form $(A + kA')p + \&c. = 0$; and then determine k , so that this equation shall express that every line of the congruency meets a given line. We have thus a quadratic equation for k , and it appears that the congruency consists of the system of lines which meet two fixed directing lines. Any four lines then determine a congruency of this kind; for (see Art. 57*d*) we have two transversals which meet all four lines,* and the congruency consists of all the lines which meet the two transversals. An exception occurs when these two transversals unite in a single one; or, what is the same thing, when the quadratic equation just mentioned has two equal roots. The lines of the congruency, then, all meet the single transversal; but, of course, another condition is required; and by considering the transversal as the limit of two distinct lines we arrive at the condition in question, in fact the congruency consists of lines each meeting a given line, and such that considering the common point of the given line and a line of the congruency, and the common plane of

* The hyperboloid determined by any three of the lines (see Art. 113) meets the fourth in two points through which the transversals pass. If the hyperboloid touches the fourth line, the two transversals reduce to a single one, and it is evident that the hyperboloid determined by any three others of the four lines also touches the remaining one. This remark, I believe, is Prof. Cayley's. If we denote the condition that two lines should intersect by (12), then the above condition that four lines should be met by only one transversal is expressed by equating to nothing the determinant

$$\begin{vmatrix} - & (12), & (13), & (14) \\ (21), & - & (23), & (24) \\ (31), & (32), & - & (34) \\ (41), & (42), & (43), & - \end{vmatrix}.$$

The vanishing of the determinant formed in the same manner from five lines is the condition that they may all meet a common transversal. The vanishing of the similar determinant for six lines expresses that they all belong to a linear complex, which has been called the "involution of six lines;" and occurs when the lines can be the directions of six forces in equilibrium. The reader will find several interesting communications on this subject by Messrs. Sylvester and Cayley, and by M. Chasles, in the *Comptes Rendus* for 1861, *Premier Semestre*.

the same two lines, the range of points corresponds homographically with the pencil of planes.

Let us pass now to a complex of the second order; that is to say, the system of lines whose six coordinates are connected by a relation of the second degree. Then, from what has been said, all the lines of the complex which lie in a given plane envelope a conic, and those which pass through a given point form a cone of the second order. We may consider the assemblage of conics corresponding to a system of parallel planes, and obtain thus, what Plücker calls, an *equatorial surface* of the complex; or, more generally, the assemblage of conics corresponding to planes which all pass through a given line, obtaining thus, Plücker's *complex surface*. It is easy to see that the given line will be a double line on the surface, and that the surface will be of the fourth order, its section by one of the planes consisting of the line twice, and of the conic corresponding to the plane. The surface will be of the fourth class, and Plücker shows also that it has eight double points.

456. We here briefly indicate the method by which it is established, that the lines of a congruency are in general bitangents of a surface. Let the equations of a right line be $\frac{x-x'}{\lambda'} = \frac{y-y'}{\mu'} = \frac{z-z'}{\nu'}$, then $x', y', z', \lambda', \mu', \nu'$ may each be regarded as functions of two parameters p, q , as in Gauss's method (Art. 377). If we take a second line and consider the line joining a point $x' + \lambda'\rho', y' + \mu'\rho', z' + \nu'\rho'$ to a point $x'' + \lambda''\rho'', y'' + \mu''\rho'', z'' + \nu''\rho''$ on the second line, then the conditions, that the joining line may be perpendicular to both lines, give

$$\lambda' (x' - x'') + \mu' (y' - y'') + \nu' (z' - z'') + \rho' - \rho'' \cos \theta = 0,$$

$$\lambda'' (x' - x'') + \mu'' (y' - y'') + \nu'' (z' - z'') - \rho'' + \rho' \cos \theta = 0,$$

where θ is the angle between the lines. And if we take the lines indefinitely near, we can derive from these equations

$$\rho = \frac{\delta x' \delta \lambda' + \delta y' \delta \mu' + \delta z' \delta \nu'}{\delta \lambda'^2 + \delta \mu'^2 + \delta \nu'^2},$$

which determines the point where one line is met by the shortest distance from a consecutive line. If we substitute in the above for $\delta x'$, $a\delta p + a'\delta q$, &c., we get for ρ a value of the form

$$\frac{e\delta p^2 + 2f\delta p\delta q + g\delta q^2}{E\delta p^2 + 2F\delta p\delta q + G\delta q^2}, = \frac{et^2 + 2ft + g}{Et^2 + 2Ft + G};$$

writing t for the ratio $\delta p : \delta q$. Since the denominator of this function represents the sum of three squares it cannot change sign, and ρ therefore cannot become infinite, but will lie between a certain maximum and minimum value; that is to say, the points on any line of a congruency where it is met by the shortest distance to an adjacent line of the congruency range on a certain determinate portion of the line, the extreme points being called by Sir W. Hamilton the virtual foci.* He has proved also that the planes containing the shortest distances corresponding to the two extreme values lie at right angles to each other; and that if ρ_1, ρ_2 be the extreme values, that corresponding to another whose shortest distance makes an angle θ with one of these is given by the formula

$$\rho = \rho_1 \cos^2\theta + \rho_2 \sin^2\theta.$$

The value of the shortest distance itself between two adjacent lines is given by an expression similar in form to that already given for ρ . It is plain, then, that there are two values of t for which the shortest distance will vanish, or that each line of the congruency is in general intersected by two of those adjacent to it. The locus of the points of intersection will be the surface to which the lines are bitangent, and is called the "focal surface" of the congruency; but this surface may degenerate into a curve, or it may break up into two surfaces, either or each of which may degenerate into a curve as already mentioned. Besides these focal surfaces there are also connected with the congruency and completely determined by it the surfaces on which the extreme points of the shortest distances lie and the surface described by the common centre of both portions of the ray.

* First "Supplement" Trans. R. I. A. vol. XVI. part I. p. 52.

457. For instance, the degeneration which has been just mentioned of necessity takes place when the congruency is of the first order. In this case, since through each point only one line of the congruency can in general be drawn, a point cannot be the intersection of two of the lines unless it be a point through which an infinity of the lines can be drawn; and if the locus of points of intersection were a surface, every point of the surface would be a singular point, which is absurd. The locus is therefore a curve. If it be a proper curve, it must by definition be such that the cone standing on it, whose vertex is an arbitrary point, shall have one and but one apparent double line. This is the case when the curve is a twisted cubic, and there is no higher curve which has only one apparent double point. The only congruency then, of the first order, consisting of a system of lines meeting a proper curve twice, is when the curve is a twisted cubic. We might, however, have a congruency of lines meeting two directing curves, and if these curves be of the orders m , m' , and have α common points, the order of the congruency will be $mm' - \alpha$. The only congruency of the first order of this kind is when the directing lines are a curve of the n^{th} order, and a right line meeting it $n - 1$ times.

458. On account of the importance of ruled surfaces, we add some further details as to this family of surfaces.

The tangent plane at any point on a generator evidently contains that generator, which is one of the inflexional tangents (Art. 265) at that point. Each different point on the generator has a different tangent plane (Art. 110), which may be constructed as follows: We know that through a given point can be drawn a line intersecting two given lines; namely, the intersection of the planes joining the given point to the given lines. Now consider three consecutive generators, and through any point A on one draw a line meeting the other two. This line, passing through three consecutive points on the surface, will be the second inflexional tangent at A , and therefore the plane of this line and the generator at A is the tangent plane at A . In this construction it is supposed that two consecutive generators do not intersect, which ordinarily they will not do.

There may be on the surface, however, singular generators which are intersected by a consecutive generator, and in this case the plane containing the two consecutive generators is a tangent plane at every point on the generator. In special cases also two consecutive generators may coincide, in which case the generator is a double line on the surface.

459. *The anharmonic ratio of four tangent planes passing through a generator is equal to that of their four points of contact.* Let three fixed lines A, B, C be intersected by four transversals in points $aa'a''a'''$, $bb'b''b'''$, $cc'c''c'''$. Then the anharmonic ratio $\{bb'b''b'''\} = \{cc'c''c'''\}$, since either measures the ratio of the four planes drawn through A and the four transversals. In like manner $\{cc'c''c'''\} = \{aa'a''a'''\}$ either measuring the ratio of the four planes through B (see Art. 114). Now let the three fixed lines be three consecutive generators of the ruled surface, then, by the last article, the transversals meet any of these generators A in four points, the tangent planes at which are the planes containing A and the transversals. And by this article it has been proved that the anharmonic ratio of the four planes is equal to that of the points where the transversals meet A .

460. It is well known that a series of planes through any line and a series through it at right angles to the former constitute a system in involution, since the anharmonic ratio of any four is equal to that of their four conjugates. It follows then, from the last article that the system formed by the points of contact of any plane, and of a plane at right angles to it, form a system in involution; or, in other words, the system of points where planes through any generator touch the surface, and where they are normal to the surface form a system in involution. The centre of the system is the point where the plane which touches the surface at infinity is normal to the surface; and, by the known properties of involution, the rectangle under the distances from this point of the points where any other plane touches and is normal, is constant.

461. *The normals to any ruled surface along any generator generate a hyperbolic paraboloid.* It is evident that they are

all parallel to the same plane, namely, the plane perpendicular to the generator. We may speak of the anharmonic ratio of four lines parallel to the same plane, meaning thereby that of four parallels to them through any point. Now in this sense the anharmonic ratio of four normals is equal to that of the four corresponding tangent planes, which (Art. 459) is equal to that of their points of contact, which again (Art. 460) is equal to that of the points where the normals meet the generator. But a system of lines parallel to a given plane and meeting a given line generates a hyperbolic paraboloid, if the anharmonic ratio of any four is equal to that of the four points where they meet the line. This proposition follows immediately from its converse, which we can easily establish.

The points where four generators of a hyperbolic paraboloid intersect a generator of the opposite kind are the points of contact of the four tangent planes which contain these generators, and therefore the anharmonic ratio of the four points is equal to that of the four planes. But the latter ratio is measured by the four lines in which these planes are intersected by a plane parallel to the four generators, and these intersections are lines parallel to these generators.

462. The central points of the involution (Art. 460) are, it is easy to see, the points where each generator is nearest the next consecutive; that is to say, the point where each generator is intersected by the shortest distance between it and its next consecutive. The locus of the points on the generators of a ruled surface, where each is closest to the next consecutive, is called the *line of striction* of the surface. It may be remarked, in order to correct a not unnatural mistake (see *Lacroix*, vol. III. p. 668), that the shortest distance between two consecutive generators is *not* an element of the line of striction. In fact, if Aa , Bb , Cc be three consecutive generators, ab the shortest distance between the two former, then $b'c$ the shortest distance between the second and third will in general meet Bb in a point b' distinct from b , and the element of the line of striction will be ab' and not ab .

Ex. 1. To find the line of striction of the hyperbolic paraboloid

$$\frac{x^2}{a^2} - \frac{y^2}{b^2} = z.$$

Any pair of generators may be expressed by the equations

$$\begin{aligned} \frac{x}{a} + \frac{y}{b} &= \lambda z, & \frac{x}{a} - \frac{y}{b} &= \frac{1}{\lambda}, \\ \frac{x}{a} + \frac{y}{b} &= \mu z, & \frac{x}{a} - \frac{y}{b} &= \frac{1}{\mu}. \end{aligned}$$

Both being parallel to the plane $\frac{x}{a} - \frac{y}{b}$, their shortest distance is perpendicular to this plane, and therefore lies in the plane

$$(a^2 + b^2) \left\{ \frac{x}{a} + \frac{y}{b} - \mu z \right\} + (a^2 - b^2) \left\{ \frac{x}{a} - \frac{y}{b} - \frac{1}{\mu} \right\},$$

which intersects the first generator in the point $z = \frac{a^2 - b^2}{a^2 + b^2} \frac{1}{\lambda \mu}$.

When the two generators approach to coincidence, we have for the coordinates of the point where either is intersected by their shortest distance

$$z = \frac{a^2 - b^2}{a^2 + b^2} \frac{1}{\lambda^2}, \quad \frac{x}{a} + \frac{y}{b} = \frac{a^2 - b^2}{a^2 + b^2} \frac{1}{\lambda},$$

and hence $(a^2 + b^2) \left(\frac{x}{a} + \frac{y}{b} \right) = (a^2 - b^2) \left(\frac{x}{a} - \frac{y}{b} \right)$, or $\frac{x}{a^3} + \frac{y}{b^3} = 0$.

The line of striction is therefore the parabola in which this plane cuts the surface, The same surface considered as generated by the lines of the other system has another line of striction lying in the plane

$$\frac{x}{a^3} - \frac{y}{b^3} = 0.$$

Ex. 2. To find the line of striction of the hyperboloid

$$\frac{x^2}{a^2} + \frac{y^2}{b^2} - \frac{z^2}{c^2} = 1.$$

Ans. It is the intersection of the surface with

$$\frac{a^2 A^2}{x^2} + \frac{b^2 B^2}{y^2} \equiv \frac{c^2 C^2}{z^2},$$

where $A = \frac{1}{b^2} + \frac{1}{c^2}$, $B = \frac{1}{a^2} + \frac{1}{c^2}$, $C = \frac{1}{b^2} - \frac{1}{a^2}$.

463. Given any generator of a ruled surface, we can describe a hyperboloid of one sheet, which shall have this generator in common with the ruled surface, and which shall also have the same tangent plane with that surface at every point of their common generator. For it is evident from the construction of Art. 458 that the tangent plane at every point on a generator is fixed, when the two next consecutive generators are given, and consequently that if two ruled surfaces have three consecutive generators in common, they will touch

all along the first of these generators. Now any three non-intersecting right lines determine a hyperboloid of one sheet (Art. 112); the hyperboloid then determined by any generator and the two next consecutive will touch the given surface as required.

In order to see the full bearing of the theorem here enunciated, let us suppose that the axis of z lies altogether in any surface of the n^{th} degree, then every term in its equation must contain either x or y ; and that equation arranged according to the powers of x and y will be of the form

$$u_{n-1}x + v_{n-1}y + u_{n-2}x^2 + v_{n-2}xy + w_{n-2}y^2 + \&c. = 0,$$

where u_{n-1} , v_{n-1} denote functions of z of the $(n-1)^{\text{th}}$ degree, &c. Then (see Art. 110) the tangent plane at any point on the axis will be $u'_{n-1}x + v'_{n-1}y = 0$, where u'_{n-1} denotes the result of substituting in u_{n-1} the coordinates of that point. Conversely, it follows that any plane $y = mx$ touches the surface in $n-1$ points, which are determined by the equation $u_{n-1} + mv_{n-1} = 0$. If however u_{n-1} , v_{n-1} have a common factor u_p , so that the terms of the first degree in x and y may be written $u_p(u_{n-p-1}x + v_{n-p-1}y) = 0$, then the equation of the tangent plane will be $u'_{n-p-1}x + v'_{n-p-1}y = 0$, and evidently in this case any plane $y = mx$ will touch the surface only in $n-p-1$ points. It is easy to see that the points on the axis for which $u_p = 0$ are double points on the surface. Now what is asserted in the theorem of this article is, that when the axis of z is not an isolated right line on a surface, but one of a system of right lines by which the surface is generated, then the form of the equation will be

$$u_{n-2}(ux + vy) + \&c. = 0,$$

so that the tangent plane at any point on the axis will be the same as that of the hyperboloid $ux + vy$, viz. $u'x + v'y = 0$. And any plane $y = mx$ will touch the surface in but one point. The factor u_{n-2} indicates that there are on each generator $n-2$ points which are double points on the surface.

464. We can verify the theorem just stated, for an important class of ruled surfaces, viz., those of which any

generator can be expressed by two equations of the form

$$at^m + bt^{m-1} + ct^{m-2} + \&c. = 0, \quad a't^n + b't^{n-1} + c't^{n-2} + \&c. = 0,$$

where $a, a', b, b', \&c.$ are linear functions of the coordinates, and t a variable parameter. Then the equation of the surface obtained by eliminating t between the equations of the generator (see *Higher Algebra*, Arts. 85, 86), may be written in the form of a determinant, of which when $m = n$ the first row and first column are identical, being (ab') , (ac') , (ad') , &c., or when $m > n$, the first row is as before and the first column consists of n such constituents, a' and zeros. Now the line aa' is a generator, namely, that answering to $t = \infty$; and we have just proved that either a or a' will appear in every term, both of the first row and of the first column. Since, then, every term in the expanded determinant contains a factor from the first row and a factor from the first column, the expanded determinant will be a function of, at least, the second degree in a and a' , except that part of it which is multiplied by (ab') , the term common to the first row and first column. But that part of the equation which is only of the first degree in a and a' determines the tangent at any point of aa' ; the ruled surface is therefore touched along that generator by the hyperboloid $ab' - ba' = 0$.

If a and b (or a' and b') represent the same plane, then the generator aa' intersects the next consecutive, and the plane a touches along its whole length. If we had $b = ka, b' = ka'$, the terms of the first degree in a and a' would vanish, and aa' would be a double line on the surface.

465. Returning to the theory of ruled surfaces in general, it is evident that any plane through a generator meets the surface in that generator and in a curve of the $(n - 1)^{\text{th}}$ degree meeting the generator in $n - 1$ points. Each of these points being a double point in the curve of section is (Art. 264) in a certain sense a point of contact of the plane with the surface. But we have seen (Art. 463) that only one of them is properly a point of contact of the plane; the other $n - 2$ are fixed points on the generator, not varying as the plane through it is changed. They are the points where this generator meets

other non-consecutive generators, and are points of a double curve on the surface. Thus, then, *a skew ruled surface in general has a double curve which is met by every generator in $n - 2$ points.* It may of course happen, that two or more of these $n - 2$ points coincide, and the multiple curve on the surface may be of higher order than the second. In the case, considered in the last article, it can be proved (see *Higher Algebra*, Lesson XVIII., on the Order of Restricted Systems of Equations) that the multiple curve is of the order $\frac{1}{2}(m+n-1)(m+n-2)$, and that there are on it $\frac{1}{6}(m+n-2)(m+n-3)(m+n-4)$ triple points.

A ruled surface having a double line will in general not have any cuspidal line unless the surface be a developable, and the section by any plane will therefore be a curve having double points but not cusps.

466. Consider now the cone whose vertex is any point, and which envelopes the surface. Since every plane through a generator touches the surface in some point, the tangent planes to the cone are the planes joining the series of generators to the vertex of the cone. The cone will in general, not have any stationary tangent planes; for such a plane would arise when two consecutive generators lie in the same plane passing through the vertex of the cone. But it is only in special cases that a generator will be intersected by one consecutive; the number of planes through two consecutive generators is therefore finite; and hence, one will, in general, not pass through an assumed point. The class of the cone, being equal to the number of tangent planes which can be drawn through any line through the vertex, is equal to the number of generators which can meet that line, that is to say, to the degree of the surface (see note p. 105). We have proved now that the *class* of the cone is equal to the *degree* of a section of the surface; and that the former has no stationary tangent planes as the latter has no stationary or cuspidal points. The equations then which connect any three of the singularities of a curve prove that the number of double tangent planes to the cone must be equal to the number of double points of a section of the surface; or, in other words, that the number

of planes containing two generators which can be drawn through an assumed point, is equal to the number of points of intersection of two generators which lie in an assumed plane.*

467. We shall illustrate the preceding theory by an enumeration of some of the singularities of the ruled surface generated by a line meeting three fixed directing curves, the degrees of which are m_1, m_2, m_3 .†

The degree of the surface generated is equal to the number of generators which meet an assumed right line; it is therefore equal to the number of intersections of the curve m_1 with the ruled surface having for directing curves the curves m_2, m_3 and the assumed line; that is to say, it is m_1 times the degree of the latter surface. The degree of this again is, in like manner, m_2 times the degree of the ruled surface whose directing curves are two right lines and the curve m_3 , while by a repetition of the same argument, the degree of this last is $2m_3$. It follows that the degree of the ruled surface when the generators are curves m_1, m_2, m_3 , is $2m_1m_2m_3$.

The three directing curves are multiple lines on the surface, whose orders are respectively m_2m_3, m_3m_1, m_1m_2 . For through any point on the first curve pass m_2m_3 generators, the intersections, namely, of the cones having this point for a common vertex, and resting on the curves m_2, m_3 .

468. The degree of the ruled surface, as calculated by the last article, will admit of reduction if any pair of the directing curves have points in common. Thus, if the curves m_2, m_3 have a point in common, it is evident that the cone whose vertex is this point, and base the curve m_1 will be included in the system, and that the order of the ruled surface proper will be reduced by m_1 , while the curve m_1 will be a multiple line of degree only $m_2m_3 - 1$. And generally if the three pairs made out of the three directing curves have common respectively α, β, γ points, the order of the ruled surface will be reduced

* These theorems are Prof. Cayley's. *Cambridge and Dublin Mathematical Journal*, vol. VII., p. 171.

† I published a discussion of this surface, *Cambridge and Dublin Mathematical Journal*, vol. VIII., p. 45.

by $m_1\alpha + m_2\beta + m_3\gamma$,* while the order of multiplicity of the directing curves will be reduced respectively by α, β, γ . Thus, if the directing lines be two right lines and a twisted cubic, the surface is in general of the sixth order, but if each of the lines intersect the cubic, the order is only the fourth. If each intersect it twice, the surface is a quadric. If one intersect it twice and the other once, the surface is a skew surface of the third degree on which the former line is a double line.

Again, let the directing curves be any three plane sections of a hyperboloid of one sheet. According to the general theory the surface ought to be of the sixteenth order, and let us see how a reduction takes place. Each pair of directing curves have two points common; namely, the points in which the line of intersection of their planes meets the surface. And the complex surface of the sixteenth order consists of six cones of the second order, together with the original quadric reckoned twice. That it must be reckoned twice, appears from the fact that the four generators which can be drawn through any point on one of the directing curves are two lines belonging to the cones and *two* generators of the given hyperboloid.

In general, if we take as directing curves three plane sections of any ruled surface, the equation of the ruled surface generated will have, in addition to the cones and to the original surface, a factor denoting another ruled surface which passes through the given curves. For it will generally be possible to draw lines, meeting all three curves which are not generators of the original surface.

469. The order of the ruled surface being $2m_1m_2m_3$, it follows, from Art. 465, that any generator is intersected by $2m_1m_2m_3 - 2$ other generators. But we have seen that at the points where it meets the directing curves, it meets $(m_2m_3 - 1) + (m_3m_1 - 1) + (m_1m_2 - 1)$ other generators. Consequently it must meet $2m_1m_2m_3 - (m_2m_3 + m_3m_1 + m_1m_2) + 1$ generators, in points not on the directing curves. We shall establish this result independently by seeking the number of generators

* My attention was called by Prof. Cayley to this reduction, which takes place when the directing curves have points in common.

which can meet a given generator. By the last article, the degree of the ruled surface whose directing curves are the curves m_1, m_2 , and the given generator, which is a line resting on both, is $2m_1m_2 - m_1 - m_2$. Multiplying this number by m_3 , we get the number of points where this new ruled surface is met by the curve m_3 . But amongst these will be reckoned $(m_1m_2 - 1)$ times the point where the given generator meets the curve m_3 . Subtracting this number, then, there remain

$$2m_1m_2m_3 - m_2m_3 - m_1m_3 - m_1m_2 + 1$$

points of the curve m_3 , through which can be drawn a line to meet the curves m_1, m_2 , and the assumed generator. But this is in other words the thing to be proved.

470. We can examine in the same way the order of the surface generated by a line meeting a curve m_1 twice, and another curve m_2 once. It is proved, as in Art. 467, that the order is m_2 times the order of the surface generated by a line meeting m_1 twice, and meeting any assumed right line. Now if h_1 be the number of apparent double points of the curve m_1 , that is to say, the number of lines which can be drawn through an assumed point to meet that curve twice, it is evident that the assumed right line will on this ruled surface be a multiple line of the order h_1 , and the section of the ruled surface by a plane through that line will be that line h_1 times, together with the $\frac{1}{2}m_1(m_1 - 1)$ lines joining any pair of the points where the plane cuts the curve m_1 . The degree of this ruled surface will then be $h_1 + \frac{1}{2}m_1(m_1 - 1)$, and, as has been said, the degree will be m_2 times this number, if the second director be a curve m_2 instead of a right line.

The result of this article may be verified as follows: Consider a complex curve made up of two simple curves m_1, m_2 ; then a line which meets this system twice must either meet both the simple curves, or else must meet one of them twice. The number of apparent double points of the system is $h_1 + h_2 + m_1m_2$;^{*} and the order of the surface generated by a

* Where I use h in these formulæ Prof. Cayley uses r , the rank of the system, substituting for h from the formula $r = m(m - 1) - 2h$. And when the system is a complex one, we have simply $R = r_1 + r_2$.

line meeting a right line, and meeting the complex curve twice, is

$$\frac{1}{2}(m_1 + m_2)(m_1 + m_2 - 1) + h_1 + h_2 + m_1 m_2 \\ = \left\{ \frac{1}{2} m_1 (m_1 - 1) + h_1 \right\} + \left\{ \frac{1}{2} m_2 (m_2 - 1) + h_2 \right\} + 2 m_1 m_2.$$

471. The order of the surface generated by a line which meets a curve three times may be calculated as follows, when the curve is given as the intersection of two surfaces U, V : Let $x'y'z'w'$ be any point on the curve, $xyzw$ any point on a generator through $x'y'z'w'$; and let us, as in Art. 343, form the two equations $\delta U' + \frac{1}{2}\lambda\delta^2 U' + \&c. = 0$, $\delta V' + \frac{1}{2}\delta^2 V' + \&c. = 0$.

Now if the generator meet the curve twice again, these equations must have two common roots. If then we form the conditions that the equations shall have two common roots, and between these and $U' = 0, V' = 0$, eliminate $x'y'z'w'$, we shall have the equation of the surface; or, rather that equation three times over, since each generator corresponds to three different points on the curve UV . But since U' and V' do not contain $xyzw$, the order of the result of elimination will be the product of pq the order of U', V' by the *weight* of the other two equations; (see *Higher Algebra*, Lesson XVIII.). If, then, we apply the formulæ given in that Lesson for finding the weight of the system of conditions that two equations shall have two common roots, putting $m = p - 1, n = q - 1, \lambda = 0, \lambda' = p, \mu = 0, \mu' = q$, the result is $\frac{1}{2}(pq - 2)\{2pq - 3(p + q) + 4\}$, and the order of the required surface is this number multiplied by $\frac{1}{3}pq$. But the intersection of U, V is a curve (see Art. 343), for which $m = pq, 2h = pq(p - 1)(q - 1)$, whence $pq(p + q) = m^2 + m - 2h$. Substituting these values, the order of the surface expressed in terms of m and h is

$$\frac{1}{6}(m - 2)(6h + m - m^2), \text{ or } (m - 2)h - \frac{1}{6}m(m - 1)(m - 2),$$

a number which may be verified, as in the last article.

472. The ruled surfaces considered in the preceding articles have all a certain number of double generators. Thus, if a line meets the curve m_1 twice, and also the curves m_2 and m_3 , it belongs doubly to the system of lines which meet the curves

m_1, m_2, m_3 and is a double generator on the corresponding surface. But the number of such lines is evidently equal to the number of intersections of the curve m_3 with the surface generated by the lines which meet m_1 twice, and also m_2 , that is to say, is $m_2 m_3 \{ \frac{1}{2} m_1 (m_1 - 1) + h_1 \}$; the total number of double generators is therefore

$$\frac{1}{2} m_1 m_2 m_3 (m_1 + m_2 + m_3 - 3) + h_1 m_2 m_3 + h_2 m_3 m_1 + h_3 m_1 m_2.$$

In like manner the lines which meet m_1 three times, and also m_2 belong triply to the system of lines which meet m_1 twice, and also m_2 ; and the number of such triple generators is seen by the last article to be $m_2 (m_1 - 2) h_1 - \frac{1}{6} m_1 m_2 (m_1 - 1) (m_1 - 2)$. The surface has also double generators whose number we shall determine presently, being the lines which meet both m_1 and m_2 twice.

Lastly, the lines which meet a curve four times are multiple lines of the fourth order on the surface generated by the lines which meet the curve three times. We can determine the number of such lines when the curve is given as the intersection of two surfaces, but will first establish a principle which admits of many applications.

473. Let the equations of three surfaces U, V, W contain $xyzw$ in the degrees respectively $\lambda, \lambda', \lambda''$, and $x'y'z'w'$ in degrees μ, μ', μ'' , and let the $\lambda\lambda'\lambda''$ points of intersection of these surfaces all coincide with $x'y'z'w'$; then it is required to find the order of the further condition which must be fulfilled in order that they may have a line in common. When this is the case, any arbitrary plane $\alpha x + \beta y + \gamma z + \delta w$ must be certain to have a point in common with the three surfaces (namely, the point where it is met by the common line), and therefore the result of elimination between U, V, W and the arbitrary plane must vanish. This result is of the degree $\lambda\lambda'\lambda''$ in $\alpha\beta\gamma\delta$, and $\mu\lambda'\lambda'' + \mu'\lambda''\lambda + \mu''\lambda\lambda'$ in $x'y'z'w'$. The first of these numbers (see *Higher Algebra*, Lesson XVIII.) we call the *order*, and the second the *weight* of the resultant. Now, since the resultant is obtained by multiplying together the results of substituting in $\alpha x + \beta y + \gamma z + \delta w$, the coordinates of each of the points of intersection of U, V, W , this resultant must be of the form $\Pi (\alpha x' + \beta y' + \gamma z' + \delta w')^{\lambda\lambda'\lambda''}$. The

condition $\alpha x' + \beta y' + \gamma z' + \delta w' = 0$, merely indicates that the arbitrary plane passes through $x'y'z'w'$, in which case it passes through a point common to the three surfaces, whether they have a common line or not. The condition, therefore, that they shall have a common line is $\Pi = 0$; and this must be of the degree

$$\mu\lambda'\lambda'' + \mu'\lambda''\lambda + \mu''\lambda\lambda' - \lambda\lambda'\lambda'';$$

that is to say, *the degree of the condition is got by subtracting the order from the weight of the equations U, V, W .*

474. Now let $x'y'z'w'$ be any point on the curve of intersection of two surfaces U, V , $xyzw$ any other point; and, as in Art. 471, let us form the equations $\delta U + \frac{1}{2}\lambda\delta^2 U + \&c. = 0$, $\delta V + \frac{1}{2}\lambda\delta^2 V + \&c. = 0$. If $x'y'z'w'$ be a point through which a line can be drawn to meet the curve in four points, and $xyzw$ any point whatever on that line, these two equations in λ will have three roots common. And, therefore, if we form the three conditions that the equations should have three roots common, these conditions considered as functions of $xyzw$, denote surfaces having common the line which meets the curve in four points. But if $x'y'z'w'$ had not been such a point, it would not have been possible to find any point $xyzw$ distinct from $x'y'z'w'$, for which the three conditions would be fulfilled; and, therefore, in general the conditions denote surfaces having no point common but $x'y'z'w'$. The order, then, of the condition which $x'y'z'w'$ must fulfil, if it be a point through which a line can be drawn to meet the curve in four points, is, by the last article, the difference between the weight and the order of the system of conditions, that the equations should have three common roots. But (see *Higher Algebra*, Lesson XVIII.) the weight of this system of conditions is found by making $m = p - 1$, $n = q - 1$, $\lambda = p$, $\mu = q$, $\lambda' = \mu' = 0$, to be

$$\frac{1}{6} \{ 3p^3q^3 - 9p^2q^2(p+q) + 2p^2q^2 + 5pq(p+q)^2 \\ + 15pq(p+q) - 13pq - 66(p+q) + 108 \};$$

while the order of the same system is

$$\frac{1}{6} \{ p^3q^3 - 3p^2q^2(p+q) + 2p^2q^2 + 2pq(p+q)^2 - 3pq(p+q) + 13pq - 36 \}.$$

The order, then, of the condition $\Pi = 0$ to be fulfilled by $x'y'z'w'$, being the difference of these numbers, is

$$\frac{1}{6}\{2p^3q^3 - 6p^2q^2(p+q) + 3pq(p+q)^2 + 18pq(p+q) - 26pq - 66(p+q) + 144\}.$$

The intersection of the surface Π with the given curve determines the points through which can be drawn lines to meet in four points; and the number of such lines is therefore $\frac{1}{4}$ of the number just found multiplied by pq . As before, putting $pq = m$, $pq(p+q) = m^2 + m - 2h$, the number of lines meeting in four points is found to be

$$\frac{1}{24}\{-m^4 + 18m^3 - 71m^2 + 78m - 48mh + 132h + 12h^2\}.*$$

From this number can be derived the number of lines which meet both of two curves twice. For, substitute in the formula just written $m_1 + m_2$ for m , and $h_1 + h_2 + m_1m_2$ for h , and we have the number of lines which meet the complex curve four times. But from this take away the number of lines which meet each four times, and the number given (Art. 472) of those which meet one three times and the other once; and the remainder is the number of lines which meet both curves twice, viz.

$$h_1h_2 + \frac{1}{4}m_1m_2(m_1 - 1)(m_2 - 1).$$

475. Besides the multiple generators, the ruled surfaces we have been considering have also nodal curves, being the locus of points of intersection of two different generators. I do not know any direct method of obtaining the order of these nodal curves; but Prof. Cayley has succeeded in arriving at a solution of the problem by the following method. Let m be one of the curves used in generating one of the surfaces we have been considering, M the degree of that surface, $\phi(m)$ the degree of the aggregate of all the double lines on that surface; then if we suppose m to be a complex curve made up of two simple curves m_1 and m_2 , the surface will consist of two surfaces M_1, M_2 having as a double line the intersection of M_1 and M_2 ,

* It may happen, as Prof. Cayley has remarked, that the surface Π may altogether contain the given curve, in which case an infinity of lines can be drawn to meet in four points. Thus the curve of intersection of a ruled surface by a surface of the p^{th} order is evidently such that every generator of the ruled surface meets the curve in p points.

in addition to the double lines on each surface. Thus, then, $\phi(m)$ must be such as to satisfy the condition

$$\phi(m_1 + m_2) = \phi(m_1) + \phi(m_2) + M_1 M_2.$$

Using, then, the value already found for M_1 in terms of m_1 , solving this functional equation, and determining the constants involved in it by the help of particular cases in which the problem can be solved directly, Prof. Cayley arrives at the conclusion, that the order of the nodal curve, distinct from the multiple generators, is in the case of the surface generated by a line meeting three curves m_1, m_2, m_3 ,

$$\frac{1}{2}m_1 m_2 m_3 \{4m_1 m_2 m_3 - (m_2 m_3 + m_3 m_1 + m_1 m_2) - 2(m_1 + m_2 + m_3) + 5\},$$

in the case of the surface generated by a line meeting m_1 twice and m_2 once, is

$$m_2 \left\{ \frac{1}{2}h_1 (m_1 - 2)(m_1 - 3) + \frac{1}{8}m_1 (m_1 - 1)(m_1 - 2)(m_1 - 3) \right\} \\ + m_2 (m_2 - 1) \left\{ \frac{1}{2}h_1^2 + \frac{1}{2}h_1 (m_1^2 - m_1 - 1) + \frac{1}{8}m_1 (m_1 - 1)(m_1^2 - 5m_1 + 10) \right\},$$

and in the case of the surface generated by a line meeting m_1 three times, is

$$\frac{1}{2}h_1^2 m_1 (m_1 - 5) - \frac{1}{6}h_1 (m_1^4 - 5m_1^3 + 5m_1^2 - 49m_1 + 120) \\ + \frac{1}{7} (m_1^6 - 6m_1^5 + 31m_1^4 - 270m_1^3 + 868m_1^2 - 408m_1).$$

SECTION III. ORTHOGONAL SURFACES.

476. We have already given a proof of Dupin's theorem regarding orthogonal surfaces in Art. 304; as this theorem has led to investigations on systems of orthogonal surfaces, we proceed to present the proof under a different and somewhat more geometrical form as follows. Imagine a given surface, and on each normal measure off from the surface an infinitesimal distance l (varying at pleasure from point to point of the surface, or say an arbitrary function of the position of the point on the surface): the extremities of these distances form a new surface, which may be called the consecutive surface; and to each point of the given surface corresponds a point on the consecutive surface, viz. the point on the normal at the distance l ; hence, to any curve or series of curves on the given surface corresponds a curve or series of curves on

the consecutive surface. Suppose that we have on the given surface two series of curves cutting at right angles, then we have on the consecutive surface the corresponding two series of curves, but these will not in general intersect at right angles.

Take A a point on the given surface; AB, AC elements of the two curves through A ; AA', BB', CC' the infinitesimal distances on the three normals; then we have on the consecutive surface the point A' , and the elements $A'B', A'C'$ of the two corresponding curves; the angles at

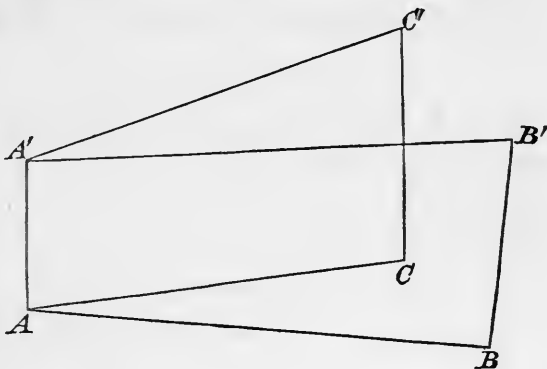

A are by hypothesis each of them a right angle; the angle $B'A'C'$ is not in general a right angle, and it may be shown that the condition of its being so, is that the normals BB', AA' shall intersect, or that the normals CC', AA' shall intersect, for it can be shown that if one pair intersect, the other pair also intersect. But the normals intersecting, AB, AC , will be elements of the lines of curvature, and the two series of curves on the given surface will be the lines of curvature of this surface.

477. Take x, y, z for the coordinates of the point A ; α, β, γ for the direction-cosines of AA' ; $\alpha_1, \beta_1, \gamma_1$ for those of AB , and $\alpha_2, \beta_2, \gamma_2$ for those of AC . Write also

$$\delta = \alpha d_x + \beta d_y + \gamma d_z,$$

$$\delta_1 = \alpha_1 d_x + \beta_1 d_y + \gamma_1 d_z,$$

$$\delta_2 = \alpha_2 d_x + \beta_2 d_y + \gamma_2 d_z.$$

Then it will be shown that the condition for the intersection of the normals AA', BB' is

$$\alpha_2 \delta_1 \alpha + \beta_2 \delta_1 \beta + \gamma_2 \delta_1 \gamma = 0,$$

the condition for the intersection of the normals AA', CC' is

$$\alpha_1 \delta_2 \alpha + \beta_1 \delta_2 \beta + \gamma_1 \delta_2 \gamma = 0,$$

and that these are equivalent to each other, and to the condition for the angle $B'A'C'$ being a right angle.

Taking l, l_1, l_2 for the lengths AA', AB, AC , the coordinates of A', B, C measured from the point A , are respectively

$$(l\alpha, l\beta, l\gamma), (l_1\alpha_1, l_1\beta_1, l_1\gamma_1), (l_2\alpha_2, l_2\beta_2, l_2\gamma_2).$$

The equations of the normal at A may be written

$$X = x + \theta\alpha, \quad Y = y + \theta\beta, \quad Z = z + \theta\gamma,$$

where X, Y, Z are current coordinates, and θ is a variable parameter. Hence for the normal at B passing from the coordinates x, y, z to $x + l_1\alpha_1, y + l_1\beta_1, z + l_1\gamma_1$, the equations are

$$\begin{aligned} X &= x + \theta\alpha + l_1\alpha_1 + l_1\delta_1(\theta\alpha), \\ Y &= y + \theta\beta + l_1\beta_1 + l_1\delta_1(\theta\beta), \\ Z &= z + \theta\gamma + l_1\gamma_1 + l_1\delta_1(\theta\gamma), \end{aligned}$$

and if the two normals intersect in the point (X, Y, Z) , then

$$\begin{aligned} \alpha_1 + \alpha\delta_1\theta + \theta\delta_1\alpha &= 0, \\ \beta_1 + \beta\delta_1\theta + \theta\delta_1\beta &= 0, \\ \gamma_1 + \gamma\delta_1\theta + \theta\delta_1\gamma &= 0. \end{aligned}$$

Eliminating θ and $\delta_1\theta$, the condition is

$$\begin{vmatrix} \alpha_1 & \alpha & \delta_1\alpha \\ \beta_1 & \beta & \delta_1\beta \\ \gamma_1 & \gamma & \delta_1\gamma \end{vmatrix} = 0;$$

or since $\alpha_2, \beta_2, \gamma_2 = \beta\gamma_1 - \beta_1\gamma, \gamma\alpha_1 - \gamma_1\alpha, \alpha\beta_1 - \alpha_1\beta$,

this is $\alpha_2\delta_1\alpha + \beta_2\delta_1\beta + \gamma_2\delta_1\gamma = 0$.

Similarly the condition for the intersection of the normals AA', CC' is

$$\alpha_1\delta_2\alpha + \beta_1\delta_2\beta + \gamma_1\delta_2\gamma = 0.$$

We have next to show that

$$\alpha_2\delta_1\alpha + \beta_2\delta_1\beta + \gamma_2\delta_1\gamma = \alpha_1\delta_2\alpha + \beta_1\delta_2\beta + \gamma_1\delta_2\gamma.$$

In fact, this equation is

$$(\alpha_2\delta_1 - \alpha_1\delta_2)\alpha + (\beta_2\delta_1 - \beta_1\delta_2)\beta + (\gamma_2\delta_1 - \gamma_1\delta_2)\gamma = 0,$$

which we proceed to verify.

In the first term the symbol $\alpha_2\delta_1 - \alpha_1\delta_2$ is

$$\alpha_2(\alpha_1d_x + \beta_1d_y + \gamma_1d_z) - \alpha_1(\alpha_2d_x + \beta_2d_y + \gamma_2d_z),$$

this is $(\alpha_2\beta_1 - \alpha_1\beta_2)d_y + (\gamma_1\alpha_2 - \gamma_2\alpha_1)d_z$;

or, what is the same thing, it is

$$\beta d_x - \gamma d_y,$$

and the equation to be verified is

$$(\beta d_x - \gamma d_y)\alpha + (\gamma d_x - \alpha d_z)\beta + (\alpha d_y - \beta d_x)\gamma = 0.$$

Writing $\alpha, \beta, \gamma = \frac{X}{R}, \frac{Y}{R}, \frac{Z}{R},$

where if $l = f(x, y, z)$ is the equation of the surface, X, Y, Z are the derived functions $\frac{df}{dx}, \frac{df}{dy}, \frac{df}{dz}$, and $R = \sqrt{(X^2 + Y^2 + Z^2)}$, the function on the left-hand consists of two parts; the first is

$$\frac{1}{R} \{(\beta d_x - \gamma d_y)X + (\gamma d_x - \alpha d_z)Y + (\alpha d_y - \beta d_x)Z\},$$

that is $\frac{1}{R} \{\alpha(d_yZ - d_zY) + \beta(d_xX - d_xZ) + \gamma(d_xY - d_yX)\},$

which vanishes; and the second is

$$- \frac{1}{R} \{\alpha(\beta d_x - \gamma d_y) + \beta(\gamma d_x - \alpha d_z) + \gamma(\alpha d_y - \beta d_x)\} R,$$

which also vanishes; that is, we have identically

$$\alpha_2\delta_1\alpha + \beta_2\delta_1\beta + \gamma_2\delta_1\gamma = \alpha_1\delta_2\alpha + \beta_1\delta_2\beta + \gamma_1\delta_2\gamma,$$

and the vanishing of the one function implies the vanishing of the other.

Proceeding now to the condition that the angle $B'A'C'$ shall be a right angle, the coordinates of B' are what those of A' become on substituting in them $x + l_1\alpha_1, y + l_1\beta_1, z + l_1\gamma_1$ in place of x, y, z ; that is, these coordinates are

$$x + l\alpha + l_1\alpha_1 + l_1\delta_1(l\alpha), \text{ \&c.},$$

or, what is the same thing, measuring them from A' as origin, the coordinates of B' are

$$l_1(\alpha_1 + l\delta_1\alpha + \alpha\delta_1l),$$

$$l_1(\beta_1 + l\delta_1\beta + \beta\delta_1l),$$

$$l_1(\gamma_1 + l\delta_1\gamma + \gamma\delta_1l),$$

and similarly those of C' measured from the same origin A' are

$$l_2 (\alpha_2 + l\delta_2\alpha + \alpha\delta_2l),$$

$$l_2 (\beta_2 + l\delta_2\beta + \beta\delta_2l),$$

$$l_2 (\gamma_2 + l\delta_2\gamma + \gamma\delta_2l).$$

Hence the condition for the angle to be right is

$$\begin{aligned} & (\alpha_1 + l\delta_1\alpha + \alpha\delta_1l) (\alpha_2 + l\delta_2\alpha + \alpha\delta_2l) \\ & + (\beta_1 + l\delta_1\beta + \beta\delta_1l) (\beta_2 + l\delta_2\beta + \beta\delta_2l) \\ & + (\gamma_1 + l\delta_1\gamma + \gamma\delta_1l) (\gamma_2 + l\delta_2\gamma + \gamma\delta_2l) = 0. \end{aligned}$$

Here the terms independent of l , δ_1l , δ_2l vanish; and writing down only the terms which are of the first order in these quantities, the condition is

$$\begin{aligned} & \alpha_1 (l\delta_2\alpha + \alpha\delta_2l) + \alpha_2 (l\delta_1\alpha + \alpha\delta_1l) \\ & + \beta_1 (l\delta_2\beta + \beta\delta_2l) + \beta_2 (l\delta_1\beta + \beta\delta_1l) \\ & + \gamma_1 (l\delta_2\gamma + \gamma\delta_2l) + \gamma_2 (l\delta_1\gamma + \gamma\delta_1l) = 0, \end{aligned}$$

where the terms in δ_1l , δ_2l vanish; the remaining terms divide by l , and throwing out this factor, the condition is

$$(\alpha_1\delta_2\alpha + \beta_1\delta_2\beta + \gamma_1\delta_2\gamma) + (\alpha_2\delta_1\alpha + \beta_2\delta_1\beta + \gamma_2\delta_1\gamma) = 0.$$

By what precedes, this may be written under either of the forms

$$\alpha_1\delta_2\alpha + \beta_1\delta_2\beta + \gamma_1\delta_2\gamma = 0,$$

$$\alpha_2\delta_1\alpha + \beta_2\delta_1\beta + \gamma_2\delta_1\gamma = 0,$$

and the theorem is thus proved.

Now in any system of orthogonal surfaces taking for the given surface of the foregoing demonstration any surface of one family, we have not only on the given surface, but also on the consecutive surface of the family, two series of curves cutting at right angles; and the demonstrated property is that the two series of curves on the given surface (that is on any surface of the family) are the lines of curvature of the surface. And the same being of course the case as to the surfaces of the other two families respectively, we have Dupin's theorem.

478. In regard to the foregoing proof, it is important to remark that there is nothing to show, and it is not in fact in general the case, that $A'B'$, $A'C'$ are elements of the lines

of curvature on the consecutive surface. The consecutive surface (as constructed with an arbitrarily varying value of l) is in fact *any* surface everywhere indefinitely near to the given surface; and since by hypothesis AA' and BB' intersect and also AA' , CC' intersect, then AB and $A'B'$ intersect, and also AC and $A'C'$; the theorem, if it were true, would be, that taking on the given surface any point A , and drawing the normal to meet the consecutive surface in A' , then the tangents AB , AC of the lines of curvature at A meet respectively the tangents $A'B'$, $A'C'$ of the lines of curvature through A' ; and it is obvious that this is not in general the case; that it shall be so, implies a restriction on the arbitrary value of the function l .

Prof. Cayley has shown that when the position of the point A on the given surface is determined by the parameters p, q , which are such that the equations of the curves of curvature are $p = \text{const.}$, $q = \text{const.}$ respectively, then the condition is that l shall satisfy the same partial differential equation as is satisfied by the coordinates x, y, z considered as functions of p, q , viz. the equation (Art. 384)

$$\frac{d^2u}{dpdq} - \frac{1}{2} \frac{1}{E} \frac{dE}{dq} \frac{du}{dp} - \frac{1}{2} \frac{1}{G} \frac{dG}{dp} \frac{du}{dq} = 0.$$

The above conclusion may be differently stated: taking $r = f(x, y, z)$ a perfectly arbitrary function of (x, y, z) , the family of surfaces $r = f(x, y, z)$, does not belong to a system of orthogonal surfaces; in order that it may do so the foregoing property must hold good; viz. it is necessary that taking a point A on the surface r , and passing along the normal to the point A' on the consecutive surface $r + dr$, the tangents to the lines of curvature at A shall respectively meet the tangents to the lines of curvature at A' . And this implies that r , considered as a function of x, y, z , satisfies a certain partial differential equation of the third order, Prof. Cayley's investigation of which will be given presently.*

* The remark that r is not a perfectly arbitrary function of (x, y, z) was first made by Bouquet, *Liouv. t. XI. p. 446* (1846), and he also showed that in the particular case where r is of the form $r = f(x) + \phi(y) + \psi(z)$, the necessary condition was that r should satisfy a certain partial differential equation of the third order; this equation was found by him, and in a different manner by Serret, *Liouv. t. XII.*

479. Dupin's theorem, and the notion of orthogonal surfaces are the foundation of Lamé's theory of curvilinear coordinates.* Representing the three families of orthogonal surfaces by $p = \phi(x, y, z)$, $q = \psi(x, y, z)$, $r = f(x, y, z)$, then conversely x, y, z are functions of p, q, r which are said to be the curvilinear coordinates of the point. It will be observed that regarding one of the coordinates, say r , as an absolute constant, then p, q are parameters determining the position of the point on the surface $r = f(x, y, z)$, such as are used in Gauss' theory of the curvature of surfaces; and by Dupin's theorem it appears that on this surface the equations of the lines of curvature are $p = \text{const.}$ $q = \text{const.}$ respectively; whence also (Art. 384) x, y, z each satisfy the differential equation

$$\frac{d^2u}{dp dq} - \frac{1}{2} \frac{1}{E} \frac{dE}{dq} \frac{du}{dp} - \frac{1}{2} \frac{1}{G} \frac{dG}{dp} \frac{du}{dq} = 0,$$

(and the like equations with q, r and r, p in place of p, q respectively) a result obtained by Lamé, but without the geometrical interpretation.

Conversely we may derive another proof of Dupin's theorem from these considerations; taking x, y, z as given functions of p, q, r , and writing

$$\frac{dx}{dp} \frac{dx}{dq} + \frac{dy}{dp} \frac{dy}{dq} + \frac{dz}{dp} \frac{dz}{dq} = [p, q],$$

$$\frac{dx}{dp} \frac{d^2x}{dq dr} + \frac{dy}{dp} \frac{d^2y}{dq dr} + \frac{dz}{dp} \frac{d^2z}{dq dr} = [p, qr], \text{ \&c.},$$

p. 241 (1847). That the same is the case generally was shown by Bonnet (*Comptes rendus*, LIV. 556, 1862), and a mode of obtaining this equation is indicated by Darboux, *Ann. de l'école normale*, t. III. p. 110 (1866), his form of the theorem is that in the surface $r = f(x, y, z)$, if α, β, γ are the direction-cosines of a line of curvature at a given point of the surface, then the function must be such that the differential equation $\alpha dx + \beta dy + \gamma dz = 0$ shall be integrable by a factor. The condition as given in the text is in the form given by Levy, *Jour. de l'école polyt.*, XLIII. (1870); he does not obtain the partial differential equation, though he finds what it becomes on writing therein $\frac{dr}{dx} = 0, \frac{dr}{dy} = 0$; the actual equation (which of course includes as well this result, as the particular case obtained by MM. Bouquet and Serret) was obtained by Prof. Cayley, *Comptes rendus*, t. LXXV. (1872); but in a form which (as he afterwards discovered) was affected with an extraneous factor.

* Lamé, *Comptes rendus*, t. VI. (1838), and *Liouv.*, t. V. (1840), and various later Memoirs; also *Leçons sur les coordonnées curvilignes*, Paris, 1859.

the conditions for the intersections at right angles may be written

$$[q, r] = 0, [r, p] = 0, [p, q] = 0,$$

and the first two equations give

$$\frac{dx}{dr} \cdot \frac{dy}{dr} \cdot \frac{dz}{dr} = \frac{dy}{dp} \frac{dz}{dq} - \frac{dz}{dp} \frac{dy}{dq} \cdot \frac{dz}{dp} \frac{dx}{dq} - \frac{dx}{dp} \frac{dz}{dq} \cdot \frac{dx}{dp} \frac{dy}{dq} - \frac{dy}{dp} \frac{dx}{dq}.$$

Moreover, by differentiating the three equations with respect to p, q, r respectively, we find

$$[rp \cdot q] + [pq \cdot r] = 0, [pq \cdot r] + [qr \cdot p] = 0, [qr \cdot p] + [rp \cdot q] = 0,$$

that is $[qr \cdot p] = 0, [rp \cdot q] = 0, [pq \cdot r] = 0$. The last of these equations, substituting in it for $\frac{dx}{dr}, \frac{dy}{dr}, \frac{dz}{dr}$ the foregoing values, becomes

$$\begin{vmatrix} \frac{dx}{dp} & \frac{dy}{dp} & \frac{dz}{dp} \\ \frac{dx}{dq} & \frac{dy}{dq} & \frac{dz}{dq} \\ \frac{d^2x}{dpdq} & \frac{d^2y}{dpdq} & \frac{d^2z}{dpdq} \end{vmatrix} = 0,$$

and the equation $[p, q] = 0$ is

$$\frac{dx}{dp} \frac{dx}{dq} + \frac{dy}{dp} \frac{dy}{dq} + \frac{dz}{dp} \frac{dz}{dq} = 0.$$

These equations are therefore satisfied by the values of x, y, z in terms of p, q, r ; and regarding in them r as a given constant but p, q as variable parameters, the values in question represent a determinate surface of the family $r = f(x, y, z)$; and it thus appears that this surface is met in its lines of curvature by the surfaces of the other two families.

480. We proceed now to the investigation of Prof. Cayley's differential equation already referred to. Let P be a point on a surface belonging to an orthogonal system, PN the normal, PT_1, PT_2 the principal tangents or directions of curvature, then, by Dupin's theorem, the tangent planes to the two orthotomic surfaces are NPT_1, NPT_2 . Take now a surface passing through a consecutive point P' on the normal, and if the surface be a consecutive one of the same orthogonal family, the planes NPT_1, NPT_2 must also meet its tangent plane at P'

in the two principal tangents $P'T_1'$, $P'T_2'$. This is the condition which we are about to express analytically.

Take $r - f(x, y, z) = 0$ for the equation of the family of the orthogonal system, the given surface being that corresponding to a given value of the parameter r ; and let the differential coefficients of f (or what is the same thing, of r considered as a function of x, y, z) be L, M, N of the first order, and a, b, c, f, g, h of the second order; and then the point P being taken as origin, the equation of the tangent plane at that point is $Lx + My + Nz = 0$, which we shall call for shortness $T = 0$; while the inflexional tangents are determined as the intersections of T with the cone

$$(a, b, c, f, g, h)(x, y, z)^2 = 0,$$

which we shall call $U = 0$. The two principal tangents are determined as being harmonic conjugates with the inflexional tangents, and also as being at right angles, that is to say, harmonic conjugates with the intersection of the plane T with $x^2 + y^2 + z^2 = 0$, or $V = 0$. Suppose now that we had formed the equation of the pair of planes through the normal, and through the inflexional tangents at P' , and that this was

$$(a'', b'', c'', f'', g'', h'')(x, y, z)^2 = 0, \text{ or } W = 0,$$

then the planes NPT_1 , NPT_2 must be harmonic conjugates with these also, so that the resulting condition is obtained by expressing that the three cones U, V, W intersect the plane T in three pairs of lines which form a system in involution.

Now we have here evidently to deal with the same analytical problem as that considered, *Conics*, Art. 388c, viz. to find the conditions that three conics shall be met by a line in three pairs of points forming an involution. The general condition there given is applied to the present case by writing $a' = b' = c' = 1, f' = g' = h' = 0$, and in the determinant form is

$$\begin{vmatrix} a'' & b'' & c'' & 2f'' & 2g'' & 2h'' \\ a & b & c & 2f & 2g & 2h \\ 1 & 1 & 1 & 0 & 0 & 0 \\ L & 0 & 0 & 0 & N & M \\ 0 & M & 0 & N & 0 & L \\ 0 & 0 & N & M & L & 0 \end{vmatrix} = 0.$$

We see then that the form of the required condition is

$$\mathfrak{A}a'' + \mathfrak{B}b'' + \mathfrak{C}c'' + 2\mathfrak{F}f'' + 2\mathfrak{G}g'' + 2\mathfrak{H}h'' = 0, *$$

where \mathfrak{A} , \mathfrak{B} , &c. are the minors of the above written determinant, and it still remains to determine a'' , b'' , &c.

481. It may be observed, in the first instance, that the equation of the pair of planes passing through the normal, and the first pair of inflexional tangents is got by eliminating θ between $T + \theta T' = 0$, $U + 2\Pi\theta + \theta^2 U' = 0$, where T' is $L^2 + M^2 + N^2$, Π is

$$x(aL + hM + gN) + y(hL + bM + fN) + z(gL + fM + cN),$$

and U' is $aL^2 + bM^2 + cN^2 + 2fMN + 2gNL + 2hLM$.

The equation of the pair of planes is therefore

$$T'^2 U - 2\Pi T T' + T^2 U' = 0.$$

Now the consecutive point P' is a point on the normal whose coordinates may be taken as λL , λM , λN , λ being an infinitesimal whose square may be neglected, and the corresponding differential coefficients for the new point are $L + \lambda\delta L$, $M + \lambda\delta M$, $N + \lambda\delta N$, $a + \lambda\delta a$, &c., where δ denotes the operation

$$L \frac{d}{dx} + M \frac{d}{dy} + N \frac{d}{dz}.$$

Hence the equation of the tangent plane at P' , referred to that point as origin, is $L'x + M'y + N'z = 0$, or $T + \lambda\delta T = 0$, where δT means $x\delta L + y\delta M + z\delta N$, and it is to be observed, that δT is the same as what we have just called Π . And the equation of the cone which determines the inflexional tangents is $U + \lambda\delta U = 0$. The equations of this plane and cone referred to the original axes are $T + \lambda(\delta T - T') = 0$, $U + \lambda(\delta U - 2\Pi) = 0$,

* Professor Cayley has also shown, that if from any surface a new surface be derived by taking on each normal an infinitesimal distance $= \rho$, where ρ is a given function of x , y , z , the condition that the new surface shall belong to the same orthogonal system is

$$(\mathfrak{A}, \mathfrak{B}, \mathfrak{C}, \mathfrak{F}, \mathfrak{G}, \mathfrak{H}) \left(\frac{d}{dx}, \frac{d}{dy}, \frac{d}{dz} \right)^2 \rho = 0,$$

and that this condition is equivalent to that given in the text.

but it will be seen presently that the terms added on account of a change of origin do not affect the result. In order to form the equation of the pair of planes through the normal and through these inflexional tangents, we have to eliminate θ between

$$T + \lambda (\Pi - T') + \theta (T' + \&c.) = 0,$$

$$U + \lambda (\delta U - 2\Pi) + 2\theta (\Pi + \&c.) + \theta^2 (U' + \&c.) = 0.$$

Now since we are about to express the condition that the resulting equation shall denote a surface intersecting T in a pair of lines belonging to an involution, to which the intersection of U by T also belongs, we need not attend to any terms in the result which contain either T or U ; nor need we attend to any terms which contain more than the first power of λ . The terms then, of which alone we need take account, are

$$-2\Pi T' (\Pi - T') + T'^2 (\delta U - \Pi) = 0,$$

or dividing by T' , $T' \delta U - 2\Pi^2 = 0$.

We have thus $a'' = (L^2 + M^2 + N^2) \delta a - 2(\delta L)^2$, &c., and the required condition is

$$\begin{aligned} (L^2 + M^2 + N^2) (\mathfrak{A} \delta a + \mathfrak{B} \delta b + \mathfrak{C} \delta c + 2\mathfrak{F} \delta f + 2\mathfrak{G} \delta g + 2\mathfrak{H} \delta h) \\ = 2 (\mathfrak{A}, \mathfrak{B}, \mathfrak{C}, \mathfrak{F}, \mathfrak{G}, \mathfrak{H}) (\delta L, \delta M, \delta N)^2. \end{aligned}$$

Prof. Cayley has shewn that the condition originally obtained by him in a form equivalent to that just written, contains an irrelevant factor, the right-hand side of the equation being divisible by $L^2 + M^2 + N^2$. This we proceed to show.

482. We may in the first place remark, that since the united points or foci of an involution given by the two equations $u = (a, h, b \chi x, y)^2$, $v = (a', h', b' \chi x, y)^2$, are determined by the equation $\begin{vmatrix} u_1 & u_2 \\ v_1 & v_2 \end{vmatrix} = 0$, *Conics*, Art. 342; if u and v be given as functions of x, y, z , where $Lx + My + Nz = 0$, and therefore $u, = \frac{du}{dx} - \frac{L}{N} \frac{du}{dz}$, &c., we find immediately that the

foci of the involution are given by the equation

$$\begin{vmatrix} u_1 & u_2 & u_3 \\ v_1 & v_2 & v_3 \\ L & M & N \end{vmatrix} = 0.$$

Thus then, or as in Art 297, the two principal tangents are determined as the intersections of the tangent plane with the cone

$$\begin{vmatrix} ax + hy + gz & hx + by + fz & gx + fy + cz \\ x & y & z \\ L & M & N \end{vmatrix} = 0.$$

We shall write this equation

$$\frac{1}{2} (a, b, c, f, g, h)(x, y, z)^2 = 0,$$

that is to say,

$$a = 2 (Mg - Nh), \quad b = 2 (Nh - Lf), \quad c = 2 (Lf - Mg),$$

$$f = L(b - c) + Ng - Mh, \quad g = M(c - a) + Lh - Nf, \quad h = N(a - b) + Mf - Lg.$$

It is useful to remark that the conic derived from two others, according to the rule just stated, viz. which is the Jacobian of two conics and of an arbitrary line, is connected with each of the two conics by the invariant relation $\Theta = 0$; that is to say, the two relations are

$$Aa + Bb + Cc + 2Ff + 2Gg + 2Hh = 0,$$

where $A, B, \&c.$ are the reciprocal coefficients $bc - f^2, \&c.$; and $A'a + \&c. = 0$, which, in the particular case under consideration, reduces to $a + b + c = 0$, which is manifestly true.

Again, referring to the condition, Art. 480, that three conics U, V, W should be met by a line in three pairs of points forming an involution, it is geometrically evident that if W be a perfect square $(\lambda x + \mu y + \nu z)^2$, this condition can only be satisfied if $\lambda x + \mu y + \nu z$ passes through one of the foci of the involution, and hence we are led to write down the following identical equation which can easily be verified:

$$(A, B, C, F, G, H)(\lambda, \mu, \nu)^2 = -2 \begin{vmatrix} L, M, N \\ u_1, u_2, u_3 \\ v_1, v_2, v_3 \end{vmatrix},$$

where in $u_1, \&c.$ we are to write for $x, y, z, \mu N - \nu M, \nu L - \lambda N,$

$\lambda M - \mu L$; that is to say, in the case we are at present considering, the determinant is

$$\begin{array}{ccc} L, & M, & N, \\ \mu N - \nu M, & \nu L - \lambda N, & \lambda M - \mu L, \\ aL' + hM' + gN', & hL' + bM' + fN', & gL' + fM' + cN', \end{array}$$

where we have written L' , &c. for $\mu N - \nu M$, &c. This determinant may be otherwise written

$$\left| \begin{array}{ccc} L, & M, & N \\ L', & M', & N' \\ \lambda, & L, & a, & h, & g \\ \mu, & M, & h, & b, & f \\ \nu, & N, & g, & f, & c \end{array} \right|.$$

But in the particular case where $\lambda = \delta L = aL + hM + gN$, &c., this determinant may be reduced by subtracting the last three columns multiplied respectively by L, M, N from the first; then observing that $LL' + MM' + NN' = 0$, we see that, as we undertook to shew, the determinant is divisible by $L^2 + M^2 + N^2$, the quotient being

$$\left| \begin{array}{ccc} L', & M', & N' \\ L, & a, & h, & g \\ M, & h, & b, & f \\ N, & g, & f, & c \end{array} \right|.$$

483. The quotient is obtained in a different and more convenient form by the following process given by Professor Cayley. The following identities may be verified, \mathfrak{A} , &c., a , &c. having the meaning already explained:

$$\mathfrak{A} = a(L^2 + M^2 + N^2) + 2L(N\delta M - M\delta N),$$

$$\mathfrak{B} = b(L^2 + M^2 + N^2) + 2M(L\delta N - N\delta L),$$

$$\mathfrak{C} = c(L^2 + M^2 + N^2) + 2N(M\delta L - L\delta M),$$

$$\mathfrak{F} = f(L^2 + M^2 + N^2) + M(M\delta L - L\delta M) + N(L\delta N - N\delta L),$$

$$\mathfrak{G} = g(L^2 + M^2 + N^2) + N(N\delta M - M\delta N) + L(M\delta L - L\delta M),$$

$$\mathfrak{H} = h(L^2 + M^2 + N^2) + L(L\delta N - N\delta L) + M(N\delta M - M\delta N).$$

Hence we have

$$(\mathfrak{A}\delta L + \mathfrak{H}\delta M + \mathfrak{G}\delta N) = (a\delta L + h\delta M + g\delta N) (L^2 + M^2 + N^2) \\ + (L\delta L + M\delta M + N\delta N) (N\delta M - M\delta N),$$

with corresponding values for

$$\mathfrak{H}\delta L + \mathfrak{B}\delta M + \mathfrak{F}\delta N, \quad \mathfrak{G}\delta L + \mathfrak{F}\delta M + \mathfrak{C}\delta N,$$

and hence immediately

$$(\mathfrak{A}, \mathfrak{B}, \mathfrak{C}, \mathfrak{F}, \mathfrak{G}, \mathfrak{H}) (\delta L, \delta M, \delta N)^2 \\ = (L^2 + M^2 + N^2) (a, b, c, f, g, h) (\delta L, \delta M, \delta N)^2.$$

Hence the equation, Art. 481, omitting the factor $L^2 + M^2 + N^2$, becomes

$$\mathfrak{A}\delta a + \mathfrak{B}\delta b + \mathfrak{C}\delta c + 2\mathfrak{F}\delta f + 2\mathfrak{G}\delta g + 2\mathfrak{H}\delta h \\ = 2 (a, b, c, f, g, h) (\delta L, \delta M, \delta N)^2.$$

484. There is still another form in which the result may be expressed. Writing, as usual, in the theory of conics, $bc - f^2 = A$, &c., the determinant at which we arrived at the end of Art. 482 is, when expanded,

$$- \{ ALL' + BMM' + CNN' + F(MN' + M'N) \\ + G(NL' + N'L) + H(LM' + L'M) \}.$$

Now, from last article

$$2LL' = \mathfrak{A} - (L^2 + M^2 + N^2) a, \text{ \&c.}, \\ MN' + M'N = \mathfrak{F} - (L^2 + M^2 + N^2) f, \text{ \&c.},$$

and remembering that $Aa + \text{\&c.} = 0$, the expanded determinant last written is seen to be

$$\mathfrak{A}A + \mathfrak{B}B + \mathfrak{C}C + 2\mathfrak{F}F + 2\mathfrak{G}G + 2\mathfrak{H}H,$$

and thus eventually the differential equation is given in the form

$$\mathfrak{A}\delta a + \mathfrak{B}\delta b + \mathfrak{C}\delta c + 2\mathfrak{F}\delta f + 2\mathfrak{G}\delta g + 2\mathfrak{H}\delta h \\ = 2 \{ \mathfrak{A}A + \mathfrak{B}B + \mathfrak{C}C + 2\mathfrak{F}F + 2\mathfrak{G}G + 2\mathfrak{H}H \}.$$

485. As a particular case of this equation of Prof. Cayley's may be deduced that which Bouquet had given (*Liouville*, XI., 446) for the special case where the equation of the system of surfaces is $r = X + Y + Z$, where X, Y, Z are each functions of x, y, z respectively only. In this case then we have

$$L = X', \quad M = Y', \quad N = Z', \quad a = X'', \quad b = Y'', \quad c = Z'', \quad f = g = h = 0;$$

$$A = Y''Z'', B = Z''X'', C = X''Y'', F = G = H = 0;$$

$$\mathfrak{A} = (Y'' - Z'')X'Y'Z', \quad \mathfrak{B} = (Z'' - X'')X'Y'Z',$$

$$\mathfrak{C} = (X'' - Y'')X'Y'Z';$$

$$\delta a = X'X''', \quad \delta b = Y'Y''', \quad \delta c = Z'Z''',$$

and the differential equation being divisible by $X'Y'Z'$ is reduced to

$$X'X'''(Y'' - Z'') + Y'Y'''(Z'' - X'') + Z'Z'''(X'' - Y'') \\ + 2(Y'' - Z'')(Z'' - X'')(X'' - Y'') = 0.$$

486. Even when the equation of condition is satisfied by an assumed equation it does not seem easy to determine the two conjugate systems. Thus M. Bouquet observed that the condition just found is satisfied when the given system is of the form $x^m y^n z^p = r$, but he gave no clue to the discovery of the conjugate systems. This lacuna was completely supplied by M. Serret, who has shewn much ingenuity and analytical power in deducing the equations of the conjugate systems, when the equation of condition is satisfied. The actual results are, however, of a rather complicated character. We must content ourselves with referring the reader to his memoir, only mentioning the two simplest cases obtained by him, and which there is no difficulty in verifying *à posteriori*. He has shewn that the three equations,

$$\frac{yz}{x} = r,$$

$$\sqrt{(x^2 + y^2)} + \sqrt{(x^2 + z^2)} = p,$$

$$\sqrt{(x^2 + y^2)} - \sqrt{(x^2 + z^2)} = q,$$

represent a triple system of conjugate orthogonal surfaces. The surfaces (r) are hyperbolic paraboloids. The system (p) is composed of the closed portions, and the system (q) of the infinite sheets, of the surfaces of the fourth order,

$$(z^2 - y^2)^2 - 2p^2(z^2 + y^2 + 2x^2) + p^4 = 0.$$

M. Serret has observed that it follows at once from what has been stated above, that in a hyperbolic paraboloid, of which the principal parabolae are equal, the sum or difference of the distances of every point of the same line of curvature from two fixed generatrices is constant.

He finds also (in a somewhat less simple form) the following equations for another system of orthogonal surfaces,

$$\begin{aligned} p &= xyz, \\ q &= (x^2 + \omega y^2 + \omega^2 z^2)^{\frac{1}{2}} + (x^2 + \omega^2 y^2 + \omega z^2)^{\frac{1}{2}}, \\ r &= (x^2 + \omega y^2 + \omega^2 z^2)^{\frac{1}{2}} - (x^2 + \omega^2 y^2 + \omega z^2)^{\frac{1}{2}}, \end{aligned}$$

where ω is a cube root of unity.

An interesting system of orthogonal surfaces, and very analogous to the system of confocal quadric surfaces, is given by M. Darboux in his Memoir above referred to, namely, the system of bicircular quartics

$$(x^2 + y^2 + z^2)^2 + \frac{4d^2 + a\lambda}{a + \lambda} x^2 + \frac{4d^2 + b\lambda}{b + \lambda} y^2 + \frac{4d^2 + c\lambda}{c + \lambda} z^2 + d^2 = 0,$$

where a, b, c, d are given constants, and in place of λ we are to write successively the three parameters p, q, r . The formulæ for x, y, z in terms of p, q, r , are

$$\begin{aligned} (a^2 - 4d^2) x^2 &= \frac{M(a+p)(a+q)(a+r)}{(a-b)(a-c)}, \\ (b^2 - 4d^2) y^2 &= \frac{M(b+p)(b+q)(b+r)}{(b-c)(b-a)}, \\ (c^2 - 4d^2) z^2 &= \frac{M(c+p)(c+q)(c+r)}{(c-a)(c-b)}, \end{aligned}$$

where, writing for shortness,

$$m = \frac{(2d+p)(2d+q)(2d+r)}{4d(2d-a)(2d-b)(2d-c)}, \quad n = \frac{(2d-p)(2d-q)(2d-r)}{4d(2d+a)(2d+b)(2d+c)},$$

we put
$$M = \frac{4d^2}{\{\sqrt{(4dm)} \pm \sqrt{(4dn)}\}^2}.$$

If $d = \infty$, the system of surfaces is

$$\frac{x^2}{a + \lambda} + \frac{y^2}{b + \lambda} + \frac{z^2}{c + \lambda} + \frac{1}{4} = 0,$$

which is in effect the system of confocal quadrics: a slight change of notation would make the constant term become -1 .

Mr. W. Roberts, expressing in elliptic coordinates the condition that two surfaces should cut orthogonally, has sought for systems orthogonal to $L + M + N = r$, where L, M, N are

functions of the three elliptic coordinates respectively. He has thus added some systems of orthogonal surfaces to those previously known (*Comptes rendus*, September 23, 1861). Of these perhaps the most interesting, geometrically, is that whose equation in elliptic coordinates is $\mu\nu = \alpha\lambda$, and for it he has given the following construction:—Let a fixed point in the line of one of the axes of a system of confocal ellipsoids be made the vertex of a series of cones circumscribed to them. The locus of the curves of contact will be a determinate surface, and if we suppose the vertex of the cones to move along the axis, we obtain a family of surfaces involving a parameter. Two other systems are obtained by taking points situated on the other axes as vertices of circumscribing cones. The surfaces belonging to these three systems will intersect, two by two, at right angles.

It may be readily shewn that the lines of curvature of the above-mentioned surfaces (which are of the third order) are circles, whose planes are perpendicular to the principal planes of the ellipsoids. Let A, B be two fixed points, taken respectively upon two of the axes of the confocal system. To these points two surfaces intersecting at right angles will correspond, and the curve of their intersection will be the locus of points M on the confocal ellipsoids, the tangent planes at which pass through the line AB . Let P be the point where the normal to one of the ellipsoids at M meets the principal plane containing the line AB , and because P is the pole of AB in reference to the focal conic in this plane, P is a given point. Hence the locus of M , or a line of curvature, is a circle in a plane perpendicular to the principal plane containing AB .

CHAPTER XIV.

SURFACES DERIVED FROM QUADRICS.

487. BEFORE proceeding to surfaces of the third degree we think it more simple to treat of surfaces derived from quadrics, the theory of which is more closely connected with that explained in preceding chapters. We begin by defining and forming the equation of Fresnel's *Wave Surface*.*

If a perpendicular through the centre be erected to the plane of any central section of a quadric, and on it lengths be taken equal to the axes of the section, the locus of their extremities will be a surface of two sheets, which is called the *Wave Surface*. Its equation is at once derived from Arts. 101, 102, where the lengths of the axes of any section are expressed in terms of the angles which a perpendicular to its plane makes with the axes of the surface. The same equation then expresses the relation which the length of a radius vector to the wave surface bears to the angles which it makes with the axes. The equation of the wave surface is therefore

$$\frac{a^2 x^2}{a^2 - r^2} + \frac{b^2 y^2}{b^2 - r^2} + \frac{c^2 z^2}{c^2 - r^2} = 0,$$

where $r^2 = x^2 + y^2 + z^2$. Or, multiplying out,

$$(x^2 + y^2 + z^2) (a^2 x^2 + b^2 y^2 + c^2 z^2)$$

$$- \{a^2 x^2 (b^2 + c^2) + b^2 y^2 (c^2 + a^2) + c^2 z^2 (a^2 + b^2)\} + a^2 b^2 c^2 = 0.$$

* See Fresnel, *Mémoires de l'Institut*, vol. VII., p. 136, published 1827.

From the first form we see that the intersection of the wave surface by a concentric sphere is a sphero-conic.

488. The section by one of the principal planes (*e.g.* the plane z) breaks up into a circle and ellipse

$$(x^2 + y^2 - c^2)(a^2x^2 + b^2y^2 - a^2b^2).$$

This is also geometrically evident, since if we consider any section of the generating quadric, through the axis of z , one of the axes of that section is equal to c , while the other axis lies in the plane xy . If, then, we erect a perpendicular to the plane of section, and on it take portions equal to each of these axes, the extremities of one portion will trace out a circle whose radius is c , while the locus of the extremities of the other portion will plainly be the principal section of the generating quadric, only turned round through 90° . In each of the principal planes the surface has four double points; namely, the intersection of the circle and ellipse just mentioned. If x' , y' be the coordinates of one of these intersections, the tangent cone (Art. 270) at this double point has for its equation

$$4(xx' + yy' - c^2)(a^2xx' + b^2yy' - a^2b^2) + z^2(a^2 - c^2)(b^2 - c^2) = 0.$$

The generating quadric being supposed to be an ellipsoid, it is evident that in the case of the section by the plane z , the circle whose radius is c , lies altogether within the ellipse whose axes are a , b ; and in the case of the section by the plane x , the circle whose radius is a , lies altogether without the ellipse whose axes are b , c . Real double points occur only in the section by the plane y ; they are evidently the points corresponding to the circular sections of the generating ellipsoid.

The section by the plane at infinity also breaks up into factors $x^2 + y^2 + z^2$, $a^2x^2 + b^2y^2 + c^2z^2$, and may therefore also be considered as an imaginary circle and ellipse, which in like manner give rise to four imaginary double points of the surface situated at infinity. Thus the surface has in all sixteen nodal points, only four of which are real.

489. The wave surface is one of a class of surfaces which may be called *apsidal surfaces*. Any surface being given, if we assume any point as pole, draw any section through that pole, and on the perpendicular through the pole to the plane of section take lengths equal to the *apsidal* (that is to say, to the maximum or minimum) radii of that section; then the locus of the extremities of these perpendiculars is the apsidal surface derived from the given one. The equation of the apsidal surface may always be calculated, as in Art. 101. First form the equation of the cone whose vertex is the pole, and which passes through the intersection with the given surface of a sphere of radius r . Each edge of this cone is proved (as at Art 102) to be an apsidal radius of the section of the surface by the tangent plane to the cone. If, then, we form the equation of the reciprocal cone, whose edges are perpendicular to the tangent planes to the first cone, we shall obtain all the points of intersection of the sphere with the apsidal surface. And by eliminating r between the equation of this latter cone and that of the sphere, we have the equation of the apsidal surface.

490. If OQ be any radius vector to the generating surface, and OP the perpendicular to the tangent plane at the point Q , then OQ will be an apsidal radius of the section passing through OQ and through OR which is supposed to be perpendicular to the plane of the paper POQ . For the tangent plane at Q passes through PQ and is perpendicular to the plane of the paper; the tangent line to the section QOR lies in the tangent plane, and is therefore also perpendicular to the plane of the paper. Since then OQ is perpendicular to the tangent line in the section QOR , it is an apsidal radius of that section.

It follows that OT , the radius of the apsidal surface corresponding to the point Q , lies in the plane POQ , and is perpendicular and equal to OQ .

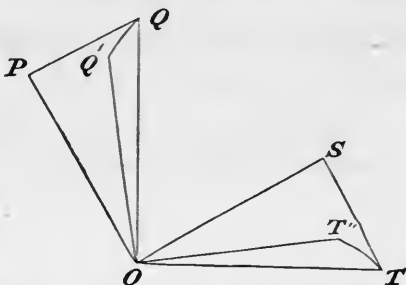

491. *The perpendicular to the tangent plane to the apsidal surface at T lies also in the plane POQ , and is perpendicular and equal to OP .**

Consider first a radius OT' of the apsidal surface, indefinitely near to OT , and lying in the plane TOR , perpendicular to the plane of the paper. Now OT' is by definition equal to an apsidal radius of the section of the original surface by a plane perpendicular to OT' , and this plane must pass through OQ . Again, an apsidal radius of a section is equal to the next consecutive radius. The apsidal radius therefore of a section passing through OQ , and indefinitely near the plane QOR , will be equal to OQ . It follows, then, that $OT = OT'$, and therefore that the tangent at T to the section TOR is perpendicular to OT , and therefore perpendicular to the plane of the paper. The perpendicular to the tangent plane at T must therefore lie in the plane of the paper, but this is the first part of the theorem which was to be proved.

Secondly, consider an indefinitely near radius OT'' in the plane of the paper; this will be equal to an apsidal radius of the section ROQ' , where OQ' is indefinitely near to OQ . But, as before, this apsidal radius being indefinitely near to OQ' will be equal to it, and therefore OT'' will be equal as well as perpendicular to OQ' . The angle then $T''TO$ is equal to $Q'QO$, and therefore the perpendicular OS is equal and perpendicular to OP .

It follows from the symmetry of the construction, that if a surface A is the apsidal of B , then conversely B is the apsidal of A .

492. *The polar reciprocal of an apsidal surface, with respect to the origin O , is the same as the apsidal of the reciprocal, with respect to O , of the given surface.*

For if we take on OP , OQ portions inversely proportional to them, we shall have Op , Oq , a radius vector and corresponding perpendicular on tangent plane of the reciprocal of

* These theorems are due to Prof. MacCullagh, *Transactions of the Royal Irish Academy*, vol. XVI, in his collected works, p. 4, &c.

the given surface. And if we take portions equal to these on the lines OS , OT which lie in their plane, and are respectively perpendicular to them, then, by the last article, we shall have a radius vector and corresponding perpendicular on tangent plane of the apsidal of the reciprocal. But these lengths being inversely as OS , OT are also a radius vector, and perpendicular on tangent plane of the reciprocal of the apsidal. The apsidal of the reciprocal is therefore the same as the reciprocal of the apsidal.

In particular, the reciprocal of the wave surface generated from any ellipsoid is the wave surface generated from the reciprocal ellipsoid.

We might have otherwise seen that the reciprocal of a wave surface is a surface also of the fourth degree, for the reciprocal of a surface of the fourth degree is in general of the thirty-sixth degree (Art. 281); but it is proved, as for plane curves, that each double point on a surface reduces the degree of its reciprocal by two; and we have proved (Art. 488) that the wave surface has sixteen double points.

To a nodal point on any surface (which is a point through which can be drawn an infinity of tangent planes, touching a cone of the second degree) answers on the reciprocal surface a tangent plane, having an infinity of points of contact, lying in a conic. From knowing then, that a wave surface has four real double points, and that the reciprocal of a wave surface is a wave surface, we infer that the wave surface has four tangent planes which touch all along a conic. We shall now show geometrically that this conic is a circle.*

493. It is convenient to premise the following lemmas :

LEMMA I. "If two lines intersecting in a fixed point, and at right angles to each other, move each in a fixed plane, the

* Sir W. R. Hamilton first showed that the wave surface has four nodes, the tangent planes at which envelope cones, and that it has four tangent planes which touch along circles. *Transactions of the Royal Irish Academy*, vol. XVI. (1837), p. 132. Dr. Lloyd experimentally verified the optical theorems thence derived, *Ibid.* p. 145. The geometrical investigations which follow are due to Professor MacCullagh, *Ibid.* p. 248. See also Plücker, "Discussion de la forme générale des ondes lumineuses," *Crelle*, t. XIX. (1839), pp. 1-44 and 91, 92.

plane containing the two lines envelopes a cone whose sections parallel to the fixed planes are parabolas." The plane of the paper is supposed to be parallel to one of the fixed planes, and the other fixed plane is supposed to pass through the line MN . The fixed point O in which the two lines intersect is supposed to be above the paper, P being the foot of the perpendicular from it on the plane of the paper. Now let OB be one position of the line which moves in the plane OMN , then the other line OA , which is parallel to the plane of the paper being perpendicular to OB and to OP , is perpendicular to the plane OBP . But the plane OAB intersects the plane of the paper in a line BT parallel to OA , and therefore perpendicular to BP . And the envelope of BT is evidently a parabola of which P is the focus and MN the tangent at the vertex.

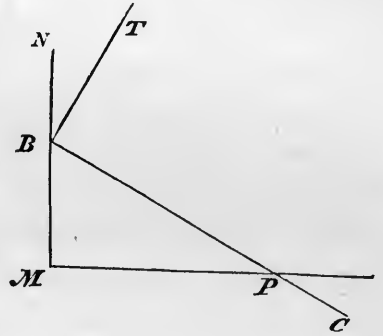

LEMMA II. "If a line OC be drawn perpendicular to OAB , it will generate a cone whose circular sections are parallel to the fixed planes" (Ex. 4, p. 100). It is proved, as in Art. 125, that the locus of C is the polar reciprocal, with respect to P , of the envelope of BT . The locus is therefore a circle passing through P .

LEMMA III. "If a central radius of a quadric moves in a fixed plane, the corresponding perpendicular on a tangent plane also moves in a fixed plane." Namely, the plane perpendicular to the diameter conjugate to the first plane, to which the tangent plane must be parallel.

494. Suppose now (see figure, Art. 490) that the plane OQR (where OR is perpendicular to the plane of the paper) is a circular section of a quadric, then OT is the nodal radius of the wave surface, which remains the same while OQ moves in the plane of the circular section; and we wish to find the cone generated by OS . But OS is perpendicular to OR which moves in the plane of the circular section and to OP

which moves in a fixed plane by Lemma III., therefore OS generates a cone whose circular sections are parallel to the planes POR , QOR . Now T is a fixed point, and TS is parallel to the plane POR , therefore the locus of the point S is a circle.

The tangent cone at the node is evidently the reciprocal of the cone generated by OS , and is therefore a cone whose sections parallel to the same planes are parabolas.

Secondly, suppose the line OP to be of constant length, which will happen when the plane POR is a section perpendicular to the axis of one of the two right cylinders which circumscribe the ellipsoid, then the point S is fixed, and it is proved precisely, as in the first part of this article, that the locus of T is a circle.

495. The equations of Art. 251 give immediately another form of the equation of the wave surface. It is evident thence, that if θ , θ' be the angles which any radius vector makes with the lines to the nodes, then the lengths of the radius vector are, for one sheet,

$$\frac{1}{\rho^2} = \frac{\cos^2 \frac{1}{2}(\theta - \theta')}{c^2} + \frac{\sin^2 \frac{1}{2}(\theta - \theta')}{a^2},$$

and for the other

$$\frac{1}{\rho'^2} = \frac{\cos^2 \frac{1}{2}(\theta + \theta')}{c^2} + \frac{\sin^2 \frac{1}{2}(\theta + \theta')}{a^2},$$

while
$$\frac{1}{\rho^2} - \frac{1}{\rho'^2} = \left(\frac{1}{c^2} - \frac{1}{a^2}\right) \sin \theta \sin \theta'.$$

It follows hence also that the intersections of a wave surface with a series of concentric spheres are a series of confocal sphero-conics. For, in the preceding equations, if ρ or ρ' be constant, we have $\theta \pm \theta'$ constant.

496. The equation of the wave surface has also been expressed as follows by Mr. W. Roberts in elliptic coordinates. The form of the equation

$$\frac{a^2 x^2}{a^2 - r^2} + \frac{b^2 y^2}{b^2 - r^2} + \frac{c^2 z^2}{c^2 - r^2} = 0,$$

shows that the equation may be got by eliminating r^2 between the equations

$$\frac{x^2}{r^2 - a^2} + \frac{y^2}{r^2 - b^2} + \frac{z^2}{r^2 - c^2} = 1, \text{ and } x^2 + y^2 + z^2 = r^2.$$

Giving r^2 any series of constant values, the first equation denotes a series of confocal quadrics, the axis of z being the primary axis, and the axis of x the least; and for this system $h^2 = b^2 - c^2$, $k^2 = a^2 - c^2$. Since r^2 is always less than a^2 and greater than c^2 , the equation always denotes a hyperboloid, which will be of one or of two sheets according as r^2 is greater or less than b^2 . The intersections of the hyperboloids of one sheet with corresponding spheres generate one sheet of the wave surface, and those of two sheets the other.

Now if the surface denote a hyperboloid of one sheet, and if λ , μ , ν denote the primary axes of three confocal surfaces of the system now under consideration which pass through any point, then the equation gives us $r^2 - c^2 = \mu^2$, but (Art. 161)

$$r^2 = \lambda^2 + \mu^2 + \nu^2 - h^2 - k^2,$$

whence the equation in elliptic coordinates is

$$\lambda^2 + \nu^2 = c^2 + h^2 + k^2 = a^2 + b^2 - c^2.$$

In like manner the equation of the other sheet is

$$\lambda^2 + \mu^2 = a^2 + b^2 - c^2.$$

The general equation of the wave surface also implies $\mu^2 + \nu^2 = a^2 + b^2 - c^2$, but this denotes an imaginary locus.

Since, if λ is constant, μ is constant for one sheet and ν for the other, it follows that if through any point on the surface be drawn an ellipsoid of the same system, it will meet one sheet in a line of curvature of one system, and the other sheet in a line of curvature of the other system.

If the equations of two surfaces expressed in terms of λ , μ , ν , when differentiated give

$$P d\lambda + Q d\mu + R d\nu = 0, \quad P' d\lambda + Q' d\mu + R' d\nu = 0,$$

the condition that they should cut at right angles is (cf. Art. 411)

$$\frac{PP'(\lambda^2 - h^2)(\lambda^2 - k^2)}{(\lambda^2 - \mu^2)(\lambda^2 - \nu^2)} + \frac{QQ'(\mu^2 - h^2)(k^2 - \mu^2)}{(\lambda^2 - \mu^2)(\mu^2 - \nu^2)} + \frac{RR'(h^2 - \nu^2)(k^2 - \nu^2)}{(\lambda^2 - \nu^2)(\mu^2 - \nu^2)} = 0,$$

which is satisfied if $P = 0$, $Q = 0$, $R' = 0$. Hence any surface

$\nu = \text{constant}$ cuts at right angles any surface whose equation is of the form $\phi(\lambda, \mu) = 0$. The hyperboloid therefore, $\nu = \text{constant}$, cuts at right angles one sheet of the wave surface, while it meets the other in a line of curvature on the hyperboloid.

497. *The plane of any radius vector of the wave surface and the corresponding perpendicular on the tangent plane, makes equal angles with the planes through the radius vector and the nodal lines.* For the first plane is perpendicular to OR (Art. 490) which is an axis of the section QOR of the generating ellipsoid and the other two planes are perpendicular to the radii of that section whose lengths are b , the mean axis of the ellipsoid, and these two equal lines make equal angles with the axis. The planes are evidently at right angles to each other, which are drawn through any radius vector, and the perpendiculars on the tangent planes at the points where it meets the two sheets of the surface.

Reciprocating the theorem of this article, we see that the plane determined by any line through the centre and by one of the points where planes perpendicular to that line touch the surface, makes equal angles with the planes through the same line and through perpendiculars from the centre on the planes of circular contact (Art. 494).

498. If the coordinates of any point on the generating ellipsoid be $x'y'z'$, and the primary axes of confocals through that point a', a'' ; then the squares of the axes of the section parallel to the tangent plane are $a^2 - a'^2, a^2 - a''^2$, which we shall call ρ^2, ρ'^2 . These, then, give the two values of the radius vector of the wave surface, whose direction-cosines are $\frac{px'}{a^2}, \frac{py'}{b^2}, \frac{pz'}{c^2}$. We shall now calculate the length and the direction-cosines of the perpendicular on the tangent plane at either of the points where this radius vector meets the surface. It was proved (Art. 491) that the required perpendicular is equal and perpendicular to the perpendicular on the tangent plane at the point where the ellipsoid is met by one of the axes of the section; and the direction-cosines of this axis are

$\frac{p'x'}{a'^2}, \frac{p'y'}{b'^2}, \frac{p'z'}{c'^2}$. The coordinates of its extremity are then these several cosines multiplied by ρ , and the direction-cosines of the corresponding perpendicular of the ellipsoid are

$$P\rho \frac{p'x'}{a'^2}, \quad P\rho \frac{p'y'}{b'^2}, \quad P\rho \frac{p'z'}{c'^2},$$

where
$$\frac{1}{P^2} = \rho^2 p'^2 \left\{ \frac{x'^2}{a'^4} + \frac{y'^2}{b'^4} + \frac{z'^2}{c'^4} \right\}.$$

Now if the quantity within the brackets be multiplied by $(a^2 - a'^2)^2$, we see at once that it will become $\frac{1}{p^2} + \frac{1}{p'^2}$. Hence

$$\frac{1}{P^2} = \frac{p^2 + p'^2}{p^2 p'^2}; \quad \text{and} \quad P^2 = \frac{p^2 p'^2}{p^2 + p'^2}.$$

This then gives the length of the perpendicular on the tangent plane at the point on the wave surface which we are considering. Its direction-cosines are obtained from the consideration that it is perpendicular to the two lines whose direction-cosines are respectively

$$\frac{p''x'}{a''^2}, \frac{p''y'}{b''^2}, \frac{p''z'}{c''^2}; \quad P\rho \frac{p'x'}{a'^2}, \quad P\rho \frac{p'y'}{b'^2}, \quad P\rho \frac{p'z'}{c'^2}.$$

Forming, by Art. 15, the direction-cosines of a line perpendicular to these two, we find, after a few reductions,

$$\frac{Px'}{p\rho} \left(1 - \frac{p''^2}{a''^2}\right), \quad \frac{Py'}{p\rho} \left(1 - \frac{p''^2}{b''^2}\right), \quad \frac{Pz'}{p\rho} \left(1 - \frac{p''^2}{c''^2}\right).$$

In fact, it is verified without difficulty, that the line whose direction-cosines have been just written is perpendicular to the two preceding.

It follows hence also, that the equation of the tangent plane at the same point is

$$xx' \left(1 - \frac{p''^2}{a''^2}\right) + yy' \left(1 - \frac{p''^2}{b''^2}\right) + zz' \left(1 - \frac{p''^2}{c''^2}\right) = p\rho.$$

In like manner the tangent plane at the other point where the same radius vector meets the surface is

$$xx' \left(1 - \frac{p'^2}{a'^2}\right) + yy' \left(1 - \frac{p'^2}{b'^2}\right) + zz' \left(1 - \frac{p'^2}{c'^2}\right) = p\rho'.$$

499. If θ be the angle which the perpendicular on the tangent plane makes with the radius vector, we have $P = \rho \cos \theta$; but we have, in the last article, proved $P^2 = \frac{p^2 \rho^2}{p^2 + p'^2}$. Hence, $\cos^2 \theta = \frac{p^2}{p^2 + p'^2}$, $\tan^2 \theta = \frac{p'^2}{p^2}$. This expression may be transformed by means of the values given for p and p' (Art. 165). We have therefore

$$p^2 = \frac{a^2 b^2 c^2}{\rho^2 \rho'^2}, \quad p'^2 = \frac{(a^2 - \rho^2)(b^2 - \rho^2)(c^2 - \rho^2)}{\rho^2(\rho^2 - \rho'^2)}.$$

Whence
$$\tan^2 \theta = - \frac{\left(1 - \frac{\rho^2}{a^2}\right) \left(1 - \frac{\rho^2}{b^2}\right) \left(1 - \frac{\rho^2}{c^2}\right)}{1 - \frac{\rho^2}{\rho'^2}}.$$

In this form the equation states a property of the ellipsoid, and the expression is analogous to that for the angle between the normal and central radius vector of a plane ellipse, viz.

$$\tan^2 \theta = - \left(1 - \frac{\rho^2}{a^2}\right) \left(1 - \frac{\rho^2}{b^2}\right).$$

In the case of the wave surface it is manifest that $\tan \theta$ vanishes only when $\rho = a$, b , or c , and becomes indeterminate when $\rho = \rho' = b$.

500. The expression $\tan \theta = \frac{p'}{p}$ leads to a construction for the perpendiculars on the tangent planes at the points where a given radius vector meets the two sheets of the surface. The perpendiculars must lie in one or other of two fixed planes (Arts. 497, 498), and if a plane be drawn perpendicular to the radius vector of the wave surface at a distance p , it is evident from the expression for $\tan \theta$, that p' is the distance to the radius vector from the point where the perpendicular on the tangent plane meets this plane. Thus we have the construction, "Draw a tangent plane to the generating ellipsoid perpendicular to the given radius vector, from its point of contact let fall perpendiculars on the two planes of Art. 497, then the lines joining to the centre the feet of these perpendiculars are the perpendiculars required."

We obtain by reciprocation a similar construction, to determine the points where planes parallel to a given one touch the two sheets of the surface.

Ex. 1. To transform the equation of the surface, as at p. 151, so as to make the radius vector to any point on the surface the axis of z , and the axes of the corresponding section of the generating ellipsoid the axes of x and y .

$$\begin{aligned} \text{Ans. } (x^2 + y^2 + z^2) \{ p^2 z^2 + (p'^2 + \rho^2) x^2 + (p''^2 + \rho'^2) y^2 + 2pp'xz + 2pp''yz + 2p'p''xy \} \\ - p^2 z^2 (\rho^2 + \rho'^2) - x^2 (p^2 \rho^2 + p'^2 \rho'^2 + p''^2 \rho^2 + \rho^2 \rho'^2) \\ - y^2 (p^2 \rho'^2 + p'^2 \rho'^2 + p''^2 \rho^2 + \rho^2 \rho'^2) - 2pp'\rho^2 xz - 2pp''\rho^2 yz + p^2 \rho^2 \rho'^2 = 0. \end{aligned}$$

It is easy to see that if we make x and $y = 0$ in the equation thus transformed, we get for x^2 the values ρ^2 and ρ'^2 as we ought. If we transform the equation to parallel axes through the point $z = \rho$, the linear part of the equation becomes

$$2p\rho (\rho^2 - \rho'^2) (pz + p'x),$$

from which the results already obtained as to the position of the tangent plane may be independently established.

Ex. 2. To transform similarly the equation of the reciprocal of the wave surface obtained by writing $\frac{\lambda^2}{a}$ for a , &c., in the equation of the wave surface.

$$\begin{aligned} \text{Ans. } (x^2 + y^2 + z^2) \{ p^2 \rho'^2 x^2 + p^2 \rho^2 y^2 - 2pp'\rho'^2 xz - 2pp''\rho^2 yz + z^2 (p'^2 \rho'^2 + p''^2 \rho^2 + \rho^2 \rho'^2) \} \\ - \lambda^4 (p^2 + p''^2 + \rho'^2) x^2 - \lambda^4 (p^2 + p'^2 + \rho^2) y^2 - \lambda^4 (p'^2 + p''^2 + \rho^2 + \rho'^2) z^2 \\ + 2\lambda^4 p'p''xy + 2\lambda^4 pp'xz + 2\lambda^4 pp''yz + \lambda^8 = 0. \end{aligned}$$

We know that the surface is touched by the plane $\rho z = \lambda^2$, and if we put in this value for z , we find, as we ought, a curve having for a double point the point $y = 0$, $p\rho x = p'\lambda^2$. If in the equation of the curve we make $y = 0$, we get

$$\left(px - \frac{p'\lambda^2}{\rho} \right)^2 \left\{ \rho'^2 x^2 + \frac{\lambda^4}{\rho^2} (\rho'^2 - \rho^2) \right\},$$

from which we learn that that chord of the outer sheet of the wave surface which joins any point on the inner sheet to the foot of the perpendicular from the centre on the tangent plane is bisected at the foot of the perpendicular. The inflexional tangents are parallel to

$$\{ p^2 \rho'^2 + p^2 (\rho'^2 - \rho^2) \} x^2 - 2p'p''\rho^2 xy + \{ p'^2 \rho^2 + \rho^2 (\rho'^2 - \rho^2) \} y^2,$$

a result of which I do not see any geometrical interpretation.*

* I have no space for a discussion what the lines of curvature on the wave surface are *not*, though a hasty assertion on this subject in Crelle's Journal has led to interesting investigations by M. Bertrand, *Comptes Rendus*, Nov. 1858; Combescure and Brioschi, Tortolini's *Annali di Matematica*, vol. II., pp. 135, 278. It is worth while to cite an observation of Brioschi, that if in the plane $lx + my + nz = \phi$; l, m, n, ϕ be functions of two variables p, q , as in Art. 377, then the plane will envelope a surface in which curves of the families $p = \text{constant}$, $q = \text{constant}$, will,

501. *The Surface of Centres.* We have already shown (Art. 206) how to obtain the equation of the surface of centres of a quadric. We consider the problem under a somewhat more general form, as it has been discussed by Clebsch (*Crelle*, vol. LXII., p. 64), some of whose results we give, working with the canonical form; and we refer to his paper for fuller details and for his method of dealing with the general equation. By the method of Art. 227, we may consider the normal to a surface as a particular case of the line joining the point of contact of any tangent plane to the pole of that plane with respect to a certain fixed quadric. The problem then of drawing a normal to a quadric from a given point may be generalized as follows: Let it be required to find a point $xyzw$ on a quadric U , $(ax^2 + by^2 + cz^2 + dw^2)$, such that the pole, with respect to another quadric V , $(x^2 + y^2 + z^2 + w^2)$, of the tangent plane to U at $xyzw$, shall lie on the line joining $xyzw$ to a given point $x'y'z'w'$. The coordinates of any point on this latter line may be written in the form $x' - \lambda x$, $y' - \lambda y$, $z' - \lambda z$, $w' - \lambda w$, and expressing that the polar plane of this point, with regard to V , shall be identical with the polar plane of $xyzw$, with respect to U , we get the equations

$$x' = (a + \lambda)x, \quad y' = (b + \lambda)y, \quad z' = (c + \lambda)z, \quad w' = (d + \lambda)w.$$

And since $xyzw$ is a point on U , λ is determined by the equation

$$\frac{ax'^2}{(a + \lambda)^2} + \frac{by'^2}{(b + \lambda)^2} + \frac{cz'^2}{(c + \lambda)^2} + \frac{dw'^2}{(d + \lambda)^2} = 0.$$

When λ is known, x , y , z , w are determined from the preceding system of equations, and since the equation in λ is of the sixth degree, the problem admits of six solutions. If we form the

at their intersection, be touched by conjugate tangents of the surface, if the condition be fulfilled,

$$\begin{vmatrix} l, & m, & n, & \phi \\ l_1, & m_1, & n_1, & \phi_1 \\ l_2, & m_2, & n_2, & \phi_2 \\ l_{12}, & m_{12}, & n_{12}, & \phi_{12} \end{vmatrix} = 0,$$

where the suffixes 1, 2, denote differentiation with respect to u and v respectively; while the curves will cut at right angles if

$$(l^2 + m^2 + n^2)(l_1 l_2 + m_1 m_2 + n_1 n_2) = (ll_1 + mm_1 + nn_1)(ll_2 + mm_2 + nn_2).$$

discriminant, with regard to λ , of this equation, we get the locus of points $x'y'z'w'$ for which two values of λ coincide, and rejecting a factor $x'^2y'^2z'^2w'^2$ (which indicates that two values coincide for all points on the principal planes), we shall have a surface of the twelfth degree answering to the surface of centres.

502. The problem of finding the surface of centres itself is easily made to depend on an equation of like form; for (Art. 197) the coordinates of a centre of curvature answering to any point $x'y'z'$ on an ellipsoid are

$$x = \frac{a'^2x'}{a^2}, \quad y = \frac{b'^2y'}{b^2}, \quad z = \frac{c'^2z'}{c^2}.$$

Solve for x', y', z' from these equations, and substitute in the equations satisfied by $x'y'z'$, viz.

$$\frac{x'^2}{a^2} + \frac{y'^2}{b^2} + \frac{z'^2}{c^2} = 1, \quad \frac{x'^2}{a^2a'^2} + \frac{y'^2}{b^2b'^2} + \frac{z'^2}{c^2c'^2} = 0,$$

now write for $a', a^2 - h^2$, &c., and we get

$$\frac{a^2x^2}{(a^2 - h^2)^2} + \frac{b^2y^2}{(b^2 - h^2)^2} + \frac{c^2z^2}{(c^2 - h^2)^2} = 1,$$

$$\frac{a^2x^2}{(a^2 - h^2)^3} + \frac{b^2y^2}{(b^2 - h^2)^3} + \frac{c^2z^2}{(c^2 - h^2)^3} = 0.$$

These two equations represent a curve of the fourth degree, which is the locus of the centres of curvature answering to points on the intersection of the given quadric with a given confocal. The surface of centres is got by eliminating h^2 between the equations; or (since the second equation is the differential of the first with respect to h^2) by forming the discriminant of the first equation.

503. I first showed, in 1857 (*Quarterly Journal*, vol. II., p. 218), that the problem of finding the surface of centres was reducible to elimination between a cubic and a quadratic, and Clebsch has proved that the same reduction is applicable to the problem considered in its most general form. In fact, let Δ denote the discriminant of $\mu U + \lambda V$; which for the canonical

form (Art. 141), is $(a\mu + \lambda)(b\mu + \lambda)(c\mu + \lambda)(d\mu + \lambda)$, and let Ω denote the reciprocal of $\mu U + \lambda V$, viz.

$$(b\mu + \lambda)(c\mu + \lambda)(d\mu + \lambda)x^2 + (c\mu + \lambda)(d\mu + \lambda)(a\mu + \lambda)y^2 + \&c.$$

then we have
$$\frac{\Omega}{\Delta} = \frac{x^2}{a\mu + \lambda} + \frac{y^2}{b\mu + \lambda} + \&c.$$

Now, if we differentiate the right-hand side of this equation with respect to μ , and then make $\mu = 1$, we obtain the equation (Art. 501) which determines λ , which therefore may be written

$$\Omega \frac{d\Delta}{d\mu} = \Delta \frac{d\Omega}{d\mu}.$$

This last equation, which is the Jacobian of Ω and Δ , being the result of eliminating m between $\Delta + m\lambda\Omega$ and its differential,* will be verified when $\Delta + m\lambda\Omega$ has two equal roots. Its differential again $\Omega \frac{d^2\Delta}{d\mu^2} = \Delta \frac{d^2\Omega}{d\mu^2}$ being the result of elimination between $\Delta + m\lambda\Omega$ and its second differential, will be verified when $\Delta + m\lambda\Omega$ has three equal factors. But both Jacobian and its differential vanish when both Δ and Ω vanish. Thus then, as was stated (Note p. 213), the discriminant of the Jacobian of two algebraic functions Δ, Ω , contains as a factor the result of elimination between Δ and Ω ; and as another factor, the condition that it shall be possible to determine m , so that $\Delta + m\lambda\Omega$ may have three equal factors. In the present case the eliminant of Δ, Ω , gives the factor $x^2y^2z^2w^2$, and it is the other condition which gives the surface answering to the surface of centres. And this condition is formed, as in Art. 206, by eliminating m between the S and T of the biquadratic $\Delta + m\lambda\Omega$.

504. The discriminant of any algebraic function

$$a\psi(\lambda) + (\lambda - a)^2\phi(\lambda),$$

must evidently be divisible by a ; and if after the division we make $a = 0$, it can be proved that the remaining factor is $\psi(a)\phi(a)^3$ multiplied by the discriminant of $\phi(\lambda)$. Thus, then, the section of Clebsch's surface by the principal plane w is the conic

* The factor λ is introduced to make Ω as well as Δ a biquadratic function in $\mu : \lambda$.

$\frac{ax^2}{(a-d)^2} + \frac{by^2}{(b-d)^2} + \frac{cz^2}{(c-d)^2}$ taken three times, together with the curve of the sixth degree, which is the reduced discriminant of

$$\frac{ax^2}{(a+\lambda)^2} + \frac{by^2}{(b+\lambda)^2} + \frac{cz^2}{(c+\lambda)^2}.$$

Clebsch has remarked that this conic and curve touch each other, and the method we have adopted leads to a simple proof of this. For evidently the discriminant of

$$\frac{ax^2}{(a+\lambda)^2} + \frac{by^2}{(b+\lambda)^2} + \frac{cz^2}{(c+\lambda)^2} = 0,$$

may be regarded as the envelope of all conics which can be represented by this equation, and therefore touches every particular conic of the system in the four points where it meets the conic represented by the differential of the equation with regard to λ , viz.

$$\frac{ax^2}{(a+\lambda)^3} + \frac{by^2}{(b+\lambda)^3} + \frac{cz^2}{(c+\lambda)^3} = 0.$$

The coordinates of these points are $ax^2 = (a+\lambda)^3(b-c)$, $by^2 = (b+\lambda)^3(c-a)$, $cz^2 = (c+\lambda)^3(a-b)$; and the equations of the common tangents at them to the conic and its envelope are

$$x \sqrt{\left\{ \frac{(b-c)a}{a+\lambda} \right\}} \pm y \sqrt{\left\{ \frac{(c-a)b}{b+\lambda} \right\}} \pm z \sqrt{\left\{ \frac{(a-b)c}{c+\lambda} \right\}} = 0.$$

In the case under consideration $\lambda = -d$. If, then, we use the abbreviations

$$(a-b)(a-c)(a-d) = -A^2, \quad (b-a)(b-c)(b-d) = -B^2,$$

$$(c-a)(c-b)(c-d) = -C^2, \quad (d-a)(d-b)(d-c) = -D^2,$$

the equations of the common tangents to the conic, and the envelope curve, are

$$\frac{xa^{\frac{1}{2}}}{A} \pm \frac{yb^{\frac{1}{2}}}{B} \pm \frac{zc^{\frac{1}{2}}}{C} = 0.$$

The reasoning used in this article can evidently be applied to other similar cases. Thus, the surface parallel to a quadric (p. 176, Ex. 2) is met by a principal plane in a curve of the eighth order and a conic, taken twice, which touches that curve in four points; and again, the four right lines (Art. 216, p. 189) touch the conic in their plane.

505. Besides the cuspidal conics in the principal planes, there are other cuspidal conics on the surface, which are found by investigating the locus of points for which the equation of the sixth degree (Art. 501) has three equal roots. Differentiating that equation twice with regard to λ , we arrive at a system of equations reducible to the form

$$\frac{ax^2}{(a+\lambda)^4} + \frac{by^2}{(b+\lambda)^4} + \frac{cz^2}{(c+\lambda)^4} + \frac{dw^2}{(d+\lambda)^4} = 0,$$

$$\frac{a^2x^2}{(a+\lambda)^4} + \frac{b^2y^2}{(b+\lambda)^4} + \frac{c^2z^2}{(c+\lambda)^4} + \frac{d^2w^2}{(d+\lambda)^4} = 0,$$

$$\frac{a^3x^2}{(a+\lambda)^4} + \frac{b^3y^2}{(b+\lambda)^4} + \frac{c^3z^2}{(c+\lambda)^4} + \frac{d^3w^2}{(d+\lambda)^4} = 0.$$

The result of eliminating λ between these three equations will be a pair of equations denoting a curve locus. Now, solving these equations, we get

$$\frac{ax^2}{(a+\lambda)^4} = (b-c)(c-d)(d-b), \quad \frac{by^2}{(b+\lambda)^4} = (c-a)(a-d)(c-d), \quad \&c.$$

whence $a+\lambda$, $b+\lambda$, &c. are proportional to $a^{\frac{1}{2}}x^{\frac{1}{2}}A^{\frac{1}{2}}$, &c. Substituting from these in the equation (Art. 501)

$$\frac{ax^2}{(a+\lambda)^2} + \frac{by^2}{(b+\lambda)^2} + \frac{cz^2}{(c+\lambda)^2} + \frac{dw^2}{(d+\lambda)^2} = 0,$$

we get

$$\frac{a^{\frac{1}{2}}x}{A} \pm \frac{b^{\frac{1}{2}}y}{B} \pm \frac{c^{\frac{1}{2}}z}{C} \pm \frac{d^{\frac{1}{2}}w}{D} = 0;$$

whence we learn that the locus which we are investigating consists of curves situated in one or other of eight planes; and that these planes meet the principal planes in the common tangents to the conic and envelope curve considered in the last article.*

* The existence of these eight planes may be also inferred from the consideration that the reciprocal of the surface of centres has an equation of the form (Art. 199) $U^2 = VW$, and has therefore as double points the eight points of intersection of U , V , W . The surface of centres then has eight imaginary double tangent planes, which touch the surface in conics (see Art. 271). The origin of these planes is accounted for geometrically, as M. Darboux has shown, by considering the eight generators of the quadric which meet the circle at infinity (Art. 139). The normals along any of these all lie in the plane containing the generator and the tangent to the circle at infinity at the point where it meets it, and they envelope a conic in that plane. In like manner a cuspidal plane curve on the centro-surface will arise every time that a surface contains a right line which meets the circle at infinity.

But if we eliminate λ between the three equations

$$a + \lambda = a^{\frac{1}{2}}x^{\frac{1}{2}}A^{\frac{1}{2}}, \quad b + \lambda = b^{\frac{1}{2}}y^{\frac{1}{2}}B^{\frac{1}{2}}, \quad c + \lambda = c^{\frac{1}{2}}z^{\frac{1}{2}}C^{\frac{1}{2}},$$

so as to form a homogeneous equation in x, y, z , we get

$$a^{\frac{1}{2}}A^{\frac{1}{2}}(b - c)x^{\frac{1}{2}} + b^{\frac{1}{2}}B^{\frac{1}{2}}(c - a)y^{\frac{1}{2}} + c^{\frac{1}{2}}C^{\frac{1}{2}}(a - b)z^{\frac{1}{2}} = 0,$$

which denotes a cone of the second degree touched by the planes x, y, z . Hence, the cuspidal curves in the eight planes are conics which touch the cuspidal conics in the principal planes.

506. There will be a nodal curve on the surface answering to the points for which the equation of Art. 501 has two pairs of equal roots. Now we saw (Art. 503) that the condition for a single pair of equal roots is got by eliminating m between a quadratic and a cubic equation, namely, the S and T of the biquadratic $\Delta + m\lambda\Omega$. If we write these equations

$$a + bm + cm^2 = 0, \quad A + Bm + Cm^2 + Dm^3 = 0,$$

it will be found that the degrees in x, y, z, w of these coefficients are respectively 0, 2, 4; 0, 2, 4, 6; and the result of elimination is, as we know, of the twelfth degree. Now the condition that the equation of Art. 501 may have two pairs of equal roots, is simply that this cubic and quadratic may have two common values of m . Generally, if the result of eliminating an indeterminate m between two equations denotes a surface, the system of conditions that the equations shall have two common roots will represent a double curve on that surface. Thus the result of eliminating m between two quadratics

$$a + bm + cm^2, \quad a' + b'm + c'm^2 \text{ is } (ac' - ca')^2 + (ba' - ab')(bc' - cb') = 0.$$

But if we remember that $a(bc' - cb') = b(ac' - ca') + c(ba' - ab')$, this result may be written

$$a(ac' - ca')^2 - b(ac' - ca')(ba' - ab') + c(ba' - ab')^2 = 0,$$

showing that the intersection of $ac' - ca'$, $ba' - ab'$ (which must separately vanish if the equations have both roots common), is a double curve on the surface.

And to come to the case immediately under consideration, if we have to eliminate between

$$a + bm + cm^2 = 0, \quad A + Bm + Cm^2 + Dm^3 = 0,$$

we may substitute for the second equation that derived by multiplying the first by A , the second by a , and subtracting, viz.

$$(Ba - bA) + (Ca - cA)m + Dam^2 = 0,$$

and thus, as has been just shown, the result of elimination may be written $aP^2 - bPQ + cQ^2 = 0$, where

$$P = bcA - acB + a^2D, \quad Q = (ac - b^2)A + abB - a^2C.$$

We thus see that the curve PQ is a double curve on the surface of centres; but since P is of the sixth degree and Q of the fourth, the podal curve PQ is of the twenty-fourth. Further details will be found in Clebsch's paper already referred to.*

507. It is convenient to give here an investigation of some of the characteristics of the centro-surface of a surface of the m^{th} order.† We denote by n the class of the surface, or the degree of its reciprocal, which, when the surface has no multiple points, is $m(m-1)^2$ (see Art. 281); and we denote by a the number of tangent lines to the surface which both pass through a given point and lie in a given plane, which is in the same case $m(m-1)$, Art. 282, this characteristic being the same for a surface and for its reciprocal.

Let us first examine the number of normals to a given surface (bitangents to the centro-surface, see Art. 306) which can be drawn through a given point. This is solved as the corresponding problem for plane curves. (See *Higher Plane Curves*, p. 94, and *Cambridge and Dublin Mathematical Journal*, vol. II.). Taking the point at infinity, the number of finite normals which can be drawn through it is the same as the number of tangent planes which can be drawn parallel to a given one; that is to say, is n . To this number must be added the number of normals which lie altogether at infinity. Now it is easy to see that

* See also a Memoir by Prof. Cayley (*Cambridge Philosophical Transactions*, vol. XII.) in which this surface is elaborately discussed. He uses the notation explained, note, Art. 409, when the equations of Art. 197 become

$$-\beta\gamma a^2x^2(a^2+p)^2(a^2+q), \quad -\gamma ab^2y^2=(b^2+p)^2(b^2+q), \quad -\alpha\beta c^2z^2=(c^2+p)^2(c^2+q),$$

α, β, γ having the same meaning as in Art. 206.

† This investigation is derived from a communication by M. Darboux to the French Academy, *Comptes Rendus*, t. LXX. (1870), p. 1328.

the normal corresponding to any point of the surface at infinity lies altogether at infinity, and is the normal to the section by the plane infinity, in the extended sense of the word normal, *Higher Plane Curves*, Art. 109. The number of such normals that can be drawn through a point in the plane is $m + a$ (*Higher Plane Curves*, Art. 111), since a is the order of the reciprocal of a plane section. The total number of normals therefore that can be drawn through any point is $m + n + a$; or, when the surface has no multiple points, is $m^3 - m^2 + m$.

Next let us examine the number of normals which lie in a given plane. The corresponding tangent planes evidently pass through the same point at infinity, viz. the point at infinity on a perpendicular to the given plane. And the corresponding points of contact are evidently the intersections by the given plane of the curve of contact of tangents from that point, and are therefore in number a or $m(m - 1)$.

The normals to a surface constitute a congruency of lines (see Art. 453), and the two numbers just determined are the order and class of that congruency.

508. To find the locus of points on a surface, the normals at which meet a given line,

$$ax + by + cz + d = 0, \quad a'x + b'y + c'z + d' = 0.$$

Substituting in these equations the values for the coordinates of a point on the normal (Art. 273), $x = x' + \theta U_1$, $y = y' + \theta U_2$, $z = z' + \theta U_3$, and eliminating the indeterminate θ , we see that the point of contact lies on the curve of intersection of the given surface with

$$(ax + by + cz + d)(a'U_1 + b'U_2 + c'U_3) \\ = (a'x + b'y + c'z + d')(aU_1 + bU_2 + cU_3),$$

a surface also of the m^{th} order, and containing the given line. The section of this curve by any plane through that line consists of the a points whose normals lie in the plane, and the m points where the line meets the surface.

509. We can hence determine the class of the centro-surface. A tangent plane to that surface contains two infinitely near

normals to the given surface (Art. 306); and therefore the tangent planes to the centro-surface which pass through a given line will touch the locus determined in the last article. Now the number of planes which can be drawn to touch the curve of intersection of two surfaces of the m^{th} order, being equal to the rank of the corresponding developable, is (Arts. 325, 342) $m^2(2m-2)$; but, since in this case the line through which the tangent planes are drawn meets the curve in m points, this number must be diminished by $2m$. The class of the centro-surface therefore is $2m(m^2 - m - 1)$.

510. Darboux* investigates as follows the order of the centro-surface. Let μ and ν be the two numbers determined in Art. 507, viz. the order and class of the congruency formed by the normals; let M and N be the order and class of the centro-surface.

Now take any line and consider the correspondence between two planes drawn through it such that a normal in one plane intersects a normal in the other. Drawing the first plane arbitrarily, any of the ν normals in that plane may be taken for the first normal, and at the point where it meets the arbitrary line, $\mu - 1$ other normals may be drawn; we see then that to any position of one plane correspond $\nu(\mu - 1)$ positions of the other. It follows then, from the general theory of correspondence, that there will be $2\nu(\mu - 1)$ cases of coincidence of the two planes. Now let us denote by x the number of points on the line such that the line is coplanar with two of the normals at the point; then the cases of coincidence obviously answer either to points x or to points on the centro-surface, since for each of the latter points two of the normals drawn from it coincide. We have then

$$2\nu(\mu - 1) = x + M,$$

But in like manner consider the correspondence between points on the line such that a normal from one is coplanar with

* Similar investigations were also made independently by Lothar Marcks. (See *Math. Annalen*, vol. v.). The investigation may be regarded as establishing a general relation (which seems to be due to Klein) between the order and class of a congruency, and the order and class of its "focal surface" (see Art. 456).

a normal from the other, and we have

$$2\mu(\nu - 1) = x + N,$$

whence

$$M - N = 2(\mu - \nu)$$

and putting in the values already obtained for μ , ν , N , we have

$$M = 2m(m - 1)(2m - 1).$$

511. The number thus found for the order of the centro-surface may be verified by considering the section of that surface by the plane infinity. Consider first the section of the surface itself by the plane infinity; the corresponding normals lie at infinity, and their envelope will (*Higher Plane Curves*, Art. 112) be a curve of the order $3a + \kappa$. And besides (as in Art. 198) the centro-surface will include the polar reciprocal of the section with regard to the circle at infinity. The order of this will be a , and it will be counted three times. Consider now the finite points of the surface. In order that one of these should have an infinitely distant centre of curvature, two consecutive normals must be parallel, and therefore the point must be on the parabolic curve. It is easy to see that the normals along the intersection of the surface by another whose order is m' , generate a surface of the order m^2m' ; therefore the normals along the parabolic curve generate a surface whose order is $4m^2(m - 2)$. But the section of this surface by the plane infinity includes the $4m(m - 2)$ normals at the points where the parabolic curve itself meets the plane infinity. The curve locus therefore at infinity answering to finite points on the parabolic curve is of the order $4m(m - 1)(m - 2)$. The total order then of the section of the centro-surface by the plane infinity, is

$$3m(m - 1) + 3m(m - 1) + 4m(m - 1)(m - 2),$$

or $2m(m - 1)(2m - 1)$ as before.

511a. In general 28 bitangents can be drawn to the centro-surface of a quadric from any point. In fact the reciprocals are bitangents in a plane section of the reciprocal surface which is of the fourth degree. Mr. F. Purser* has shown

* *Quarterly Journal of Mathematics*, vol. XIII., p. 338.

that these 28 lines resolve into three groups, the six normals which can be drawn from the point to the surface, the six pairs of generators of the six quadrics of the system

$$\frac{a^2x^2}{(a^2 - k^2)^2} + \frac{b^2y^2}{(b^2 - k^2)^2} + \frac{c^2z^2}{(c^2 - k^2)^2} = 1,$$

which pass through the point, and the ten *synnormals* through the point. To explain what these last are; the six feet of normals from any point to a quadric may be distributed in ten ways into pairs of threes, each three determining a plane. The two planes of a pair are simply related and besides each plane touches a surface of the fourth class, or, in other words, the pole of such a plane with regard to the quadric moves on a surface of the fourth degree, to which the name *normopolar* surface has been given. The analysis which establishes this, easily shows that three intersecting normals to the quadric at points of such a plane section meet in a point which describes a definite right line when the plane section remains unaltered, which locus line corresponding to any two correlated planes satisfying the condition of the fourth order, is called a *synnormal*. There are therefore ten *synnormals* through a point.*

512. *Parallel Surfaces.* We have discussed, p. 176, the problem of finding the equation of a surface parallel to a quadric, and we investigate now the characteristics of the parallel to a surface of the n^{th} order. We confine ourselves to the case when the surface has no special relation to the plane or circle at infinity. The same principles are used as in the corresponding investigation for plane curves, which see *Higher Plane Curves*, p. 101. The order of the parallel is found by making k the modulus = 0 in its equation, which will not affect the terms of

* In 1862 M. Desboves published his "Théorie nouvelle des normales aux surfaces du second ordre," in which the locus line and the related surface are discussed under the names *synnormal* and *normopolar surface*. Mr. Purser independently arrived at the same results (*Quarterly Journal*, vol. VIII., p. 66) and showed the equivalence of the relation of the fourth order with the invariant relation *in plano* that three feet of normals from a point to a quadric form a triangle inscribed in one and circumscribed to another given conic; and gave a construction for any *synnormal* through a point.

highest degree in the equation. The result will represent the original surface counted twice, together with the developable enveloped by the tangent planes* to the surface drawn through the tangent lines of the circle at infinity, this developable answering to the tangents from the foci of a plane curve (Art. 146). Now it will be seen (Chap. XVII. *post.*) that the rank of a developable enveloping a surface and a curve is $nm' + ar'$, where a, n , are characteristics of the surface and m', r' of the curve. In the present case $m' = r' = 2$, and the rank of the developable is $2(n + a)$. The order of the parallel surface is therefore $2(m + n + a)$ or $2(m^3 - m^2 + m)$; in other words it is double the number of normals that can be drawn from a point to the surface (Art. 507).

513. If the equation of the tangent plane to a surface be $\alpha x + \beta y + \gamma z + \delta = 0$, and if the surface be given by a tangential equation between $\alpha, \beta, \gamma, \delta$, then the corresponding equation of a parallel surface is got by writing in this equation for $\delta, \delta + k\rho$, where $\rho^2 = \alpha^2 + \beta^2 + \gamma^2$. This equation cleared of radicals will ordinarily be of double the degree of the primitive equation; hence, the class of a parallel is in general double the class of the primitive. More generally, to a cylinder enveloping the primitive corresponds a cylinder enveloping the parallel surface, and being the parallel of the former cylinder. Hence the characteristics of the general tangent cone to the parallel are derived from those of the general tangent cone to the primitive by the rules for plane curves (*Higher Plane Curves*, Art. 117a). Thus then, since (Art. 279 *et seq.*) we have for the tangent cone to the primitive,

$$\begin{aligned} \mu &= a = m(m-1), & \nu &= n = m(m-1)^2, \\ \kappa &= 3m(m-1)(m-2), & \iota &= 4m(m-1)(m-2), \end{aligned}$$

we have for the tangent cone to the parallel (*Higher Plane Curves*, l. e.)

$$\begin{aligned} \mu &= 2(n+a) = 2m^2(m-1), & \nu &= 2n, \\ \kappa &= 2m(m-1)(4m-5), & \iota &= 8m(m-1)(m-2). \end{aligned}$$

* It is to be noted that every parallel to any of these planes coincides with the plane itself. The paper of Mr. S. Roberts which I use in this article is in *Proceedings of the London Mathematical Society*, 1873.

Again, the reciprocal of a parallel surface is of the order $2n$, having a cuspidal curve of the order $8m(m-1)(m-2)$, and a nodal of the order

$$m(m-1)(2m^4 - 6m^3 + 6m^2 - 16m + 25).$$

The parallel surface will ordinarily have nodal and cuspidal curves. In fact, since the equation of the parallel surface may also be regarded as an equation determining the lengths of the normals from any point to the surface, if we form the discriminant of this with regard to k (see *Conics*, p. 337), it will include a factor which will represent a surface locus, from each point of which two distinct normals of equal length can be drawn to the surface. Such a point will be a double point on the parallel surface whose modulus is equal to this length. In like manner, each parallel surface will have a determinate number of triple points. The discriminant just mentioned will also include a factor representing the surface of centres; and plainly to those points on the primitive at which a principal radius of curvature is equal to the modulus, will correspond points on the surface of centres which will form a cuspidal curve on the parallel surface. Mr. Roberts determines the order of the cuspidal curve as double that of the surface of centres, and confirms his result by observing, that in the limiting case $k = \infty$, the locus of points on the surface of centres for which a principal radius of curvature $= k$, is the section of the surface of centres by the plane infinity, counted twice, since k may be $\pm \infty$. The singularities of the parallel surface here assigned are sufficient to determine the remainder by the help of the general theory of reciprocal surfaces hereafter to be explained.

In the case of the parallel to a quadric, it appears from what has been stated, that the reciprocal is of the fourth order, and having no cuspidal curve, but having a nodal conic. The parallel itself is of the twelfth order; its cuspidal curve is of the twenty-fourth order, being the complete intersection of a quartic with a sextic surface. The nodal curve is of the twenty-sixth order, and includes five conics, one in each of the principal planes, and two in the plane infinity, namely, the section of the quadric itself and the circle at infinity. The remainder of the

nodal curve consists of 16 right lines, each meeting the circle at infinity.*

514. *Pedals.* The locus of the feet of perpendiculars let fall from any fixed point on the tangent planes of a surface, is a derived surface to which French mathematicians have given a distinctive name, "podaire," which we shall translate as the *pedal* of the given surface. From the pedal may, in like manner, be derived a new surface, and from this another, &c., forming a series of second, third, &c., pedals. Again, the envelope of planes drawn perpendicular to the radii vectores of a surface, at their extremities, is a surface of which the given surface is a pedal, and which we may call the first negative pedal. The surface derived in like manner from this is the second negative pedal, and so on. Pedal curves and surfaces have been studied in particular by Mr. W. Roberts, *Liouville*, vols. x. and XII., by Dr. Tortolini, and by Dr. Hirst, Tortolini's *Annali*, vol. II., p. 95; see also the corresponding theory for plane curves, *Higher Plane Curves*, Art. 121. We shall here give some of their results, but must omit the greater part of them which relate to problems concerning rectification, quadrature, &c., and do not enter into the plan of this treatise. If Q be the foot of the perpendicular from O on the tangent plane at any point P , it is easy to see that the sphere described on the diameter OP touches the locus of Q ; and consequently the normal at any point Q of the pedal passes through the middle point of the corresponding radius vector OP . It immediately follows hence, that the perpendicular OR on the tangent plane at Q lies in the plane POQ , and makes the angle $QOR = POQ$, so that the right-angled triangle QOR is similar to POQ ; and if we call the angle QOR , α , so that the first perpendicular OQ is connected with the radius vector by the equation $p = \rho \cos \alpha$, then the second perpendicular OR will be $\rho \cos^2 \alpha$, and so on.†

* The parallel to a curve in space might also have been discussed. This is a tubular surface.

† Thus the radius vector to the n^{th} pedal is of length $\rho \cos^n \alpha$, and makes with the radius vector to the curve the angle $n\alpha$. Using this definition of the method of

It is obvious that if we form the polar reciprocals of a curve or surface A and of its pedal B , we shall have a curve or surface a which will be the pedal of b ; hence, if we take a surface S and its successive pedals $S_1, S_2, \dots S_n$, the reciprocals will be a series $S', S'_{-1}, S'_{-2}, \dots S'_{-n}$, those derived in the latter case being negative pedals.

It is also obvious that the first pedal is the *inverse* of the polar reciprocal of the given surface (that is to say, the surface derived from it by substituting in its equation, for the radius vector, its reciprocal); and that the inverse of the series $S_1, S_2, \dots S_n$ will be the series $S', S'_{-1}, \dots S'_{-n-1}$.

515. *Inverse Surfaces.* As we may not have the opportunity to return to the general theory of inversion, we give in this place the following statement (taken from Hirst, *Tortolini*, vol. II., p. 165) of the principal properties of inverse surfaces (see *Higher Plane Curves*, Arts. 122, 281).

(1) Three pairs of corresponding points on two inverse surfaces lie on the same sphere, (and two pairs of corresponding points on the same circle) which cuts orthogonally the unit sphere whose centre is the origin.

(2) By the property of a quadrilateral inscribed in a circle the line ab joining any two points on one curve makes the same angle with the radius vector Oa , that the line joining the corresponding points $a'b'$ makes with the radius vector Ob' . In the limit then, if ab be the tangent at any point a , the corresponding tangent on the inverse curve makes the same angle with the radius vector.

(3) In like manner for surfaces, two corresponding tangent planes are equally inclined to the radius vector, the two corresponding normals lying in the same plane with the radius vector, and forming with it an isosceles triangle whose base is the intercepted portion of the radius vector.

derivation, Mr. Roberts has considered fractional derived curves and surfaces. Thus for $n = \frac{1}{2}$, the curve derived from the ellipse is Cassini's oval. An analogous surface may be derived from the ellipsoid.

(4) It follows immediately from (2), that the angle which two curves make with each other at any point is equal to that which the inverse curves make at the corresponding point.

(5) In like manner it follows from (3), that the angle which two surfaces make with each other at any point is equal to that which the inverse surfaces make at the corresponding point.

(6) The inverse of a line or plane is a circle or sphere passing through the origin.

(7) Any circle may be considered as the intersection of a plane, and a sphere A through the origin. Its inverse, therefore, is another circle, which is a sub-contrary section of the cone whose vertex is the origin, and which stands on the given circle.

(8) The centre of the second circle lies on the line joining the origin to a , the vertex of the cone circumscribing the sphere A along the given circle. For a is evidently the centre of a sphere B which cuts A orthogonally. The plane, therefore, which is the inverse of A cuts B' the inverse of B orthogonally, that is to say, in a great circle, whose centre is the same as the centre of B' . But the centres of B and of B' lie in a right line through the origin.

(9) To a circle osculating any curve, evidently corresponds a circle osculating the inverse curve.

(10) For inverse surfaces, the centres of curvature of two corresponding normal sections lie in a right line with the origin. To the normal section α at any point m corresponds a curve α' situated on a sphere A passing through the origin; and the osculating circle c' of α' is the inverse of c the osculating circle of α . If now α_1 be the normal section which touches α' at the point m' , then, by Meunier's theorem, the centre of c' is the projection on its plane of the centre of c_1 the osculating circle of α_1 . But the normal $m'c_1$ evidently touches the sphere A at m' , so that c_1 is the vertex of the cone circumscribed to A along c' , and theorem (10) therefore follows from theorem (8).

(11) To the two normal sections at m whose centres of curvature occupy extreme positions on the normal at m , will

evidently correspond two sections enjoying the same property; therefore to the two principal sections on one surface correspond two principal sections on the other, and to a line of curvature on one, a line of curvature on the other.*

In the case where the surface has no special relation to the plane or circle at infinity it is easy to see, as at *Higher Plane Curves*, p. 106, that the inverse of a surface is of the order $2m$, and class $3m + 2a + n = m^3 + 2m$, that it passes m times through the origin and m times through the circle at infinity; and hence that the order and class of the first pedal are $2n$, $m + 2a + 3n$, and of the first negative pedal $3m + 2a + n$ and $2m$.

516. The first pedal of the ellipsoid $\frac{x^2}{a^2} + \frac{y^2}{b^2} + \frac{z^2}{c^2} = 1$, being the inverse of the reciprocal ellipsoid, has for its equation

$$a^2x^2 + b^2y^2 + c^2z^2 = (x^2 + y^2 + z^2)^2.$$

This surface is Fresnel's "Surface of Elasticity." The inverse of a system of confocals cutting at right angles is evidently a system of surfaces of elasticity cutting at right angles; the lines of curvature therefore of the surface of elasticity are determined as the intersection with it of two surfaces of the same nature derived from concyclic quadrics.

The origin is evidently a double point on this surface, and the imaginary circle in which any sphere cuts the plane at infinity is a double line on the surface.

517. Prof. Cayley first obtained the equation of the first *negative pedal* of a quadric, that is to say, of the envelope

* Dr. Hart's method of obtaining focal properties by inversion (explained *Higher Plane Curves*, Art. 281) is equally applicable to curves in space and to surfaces. The inverse of any plane curve is a curve on the surface of a sphere, and in particular the inverse of a plane conic is the intersection of a sphere with a quadric cone. And as shown (*Higher Plane Curves*, Art. 281) from the focal property of the conic $\rho + \rho' = \text{const.}$ is inferred a focal property of the curve in space $l\rho + m\rho' + n\rho'' = 0$. So, in like manner, the inverse of a bicircular quartic is a curve in space with similar focal properties. (See Casey on Cyclides and Sphero-Quartics, *Phil. Trans.*, vol. 161; Darboux *Sur une classe remarquable de courbes et de surfaces algébriques*). A surface which is its own inverse with regard to any point has been called an *anallagmatic* surface.

of planes drawn perpendicular to the central radii at their extremities. It is evident that if we describe a sphere passing through the centre of the given quadric, and touching it at any point $x'y'z'$, then the point xyz on the derived surface which corresponds to $x'y'z'$ is the extremity of the diameter of this sphere, which passes through the centre of the quadric. We thus easily find the expressions

$$x = x' \left(2 - \frac{t}{a^2} \right), \quad y = y' \left(2 - \frac{t}{b^2} \right), \quad z = z' \left(2 - \frac{t}{c^2} \right),$$

where

$$t = x'^2 + y'^2 + z'^2.$$

Solving these equations for x' , y' , z' and substituting their values in the two equations

$$xx' + yy' + zz' = x'^2 + y'^2 + z'^2, \quad \frac{x'^2}{a^2} + \frac{y'^2}{b^2} + \frac{z'^2}{c^2} = 1,$$

we get

$$\frac{x^2}{\left(2 - \frac{t}{a^2} \right)} + \frac{y^2}{\left(2 - \frac{t}{b^2} \right)} + \frac{z^2}{\left(2 - \frac{t}{c^2} \right)} = t,$$

$$\frac{x^2}{a^2 \left(2 - \frac{t}{a^2} \right)^2} + \frac{y^2}{b^2 \left(2 - \frac{t}{b^2} \right)^2} + \frac{z^2}{c^2 \left(2 - \frac{t}{c^2} \right)^2} = 1.$$

Now the second of these equations is the differential, with respect to t , of the first equation; and the required surface is therefore represented by the discriminant of that equation, which we can easily form, the equation being only of the fourth degree. If we write this biquadratic

$$At^4 + 4Bt^3 + 6Ct^2 + 4Dt + E,$$

it will be found that A and B do not contain x , y , z , while C , D , E contain them, each in the second degree. Now the discriminant is of the sixth degree in the coefficients, and is of the form $A\phi + B^2\psi$; consequently it can contain x , y , z only in the tenth degree. This therefore is the degree of the surface required.

It appears, as in other similar cases, that the section by one of the principal planes z consists of the discriminant of

$$\frac{x^2}{2 - \frac{t}{a^2}} + \frac{y^2}{2 - \frac{t}{b^2}} = t,$$

which is a curve of the sixth degree, and is the first negative pedal of the corresponding principal section of the ellipsoid, together with the conic, counted twice, obtained by writing $t = 2c^2$, in the last equation. This conic, which is a double curve on the surface, touches the curve of the sixth degree in four points. The double points on the principal planes evidently answer to points on the ellipsoid, for which $t = x'^2 + y'^2 + z'^2 = 2a^2$ or $2b^2$ or $2c^2$. There is a cuspidal conic at infinity, and, besides, a finite cuspidal curve of the sixteenth degree.

The reader will find (*Philosophical Transactions*, 1858, and *Tortolini*, vol. II., p. 168) a discussion by Prof. Cayley of the different forms assumed by the surface and by the cuspidal and nodal curves according to the different relative values of a^2 , b^2 , c^2 .

518. Mr. W. Roberts has solved the problem discussed in the last article in another way, by proving that the problem to find the negative pedal of a surface is identical with that of forming the equation of the parallel surface. The former problem is to find the envelope of the plane

$$xx' + yy' + zz' = x'^2 + y'^2 + z'^2,$$

where x' , y' , z' satisfy the equation of the surface. The second problem, being that of finding the envelope of a sphere whose centre is on the surface and radius = k , is to find the envelope of

$$(x - x')^2 + (y - y')^2 + (z - z')^2 = k^2,$$

or $2xx' + 2yy' + 2zz' = x^2 + y^2 + z^2 - k^2 + x'^2 + y'^2 + z'^2.$

Now in finding this envelope the unaccented letters are treated as constants, and it is evident that both problems are particular cases of the problem to find, under the same conditions, the envelope of

$$ax' + by' + cz' = x'^2 + y'^2 + z'^2 + d.$$

It is also evident that if we have the equation of the parallel surface, we have only to write in it for k^2 , $x^2 + y^2 + z^2$, and then $\frac{1}{2}x$, $\frac{1}{2}y$, $\frac{1}{2}z$ for x , y , z ; when we have the equation of the negative pedal. Thus having obtained (p. 176) the equation of the parallel to a quadric, we can find, by the substitutions here explained, the equation of the first negative, the origin

being anywhere, as easily as when the origin is the centre. Further, if we write for k , $k + k'$, and then make the same substitution for k , we obtain the first negative, the origin being anywhere, of the parallel to the quadric, a problem which it would probably not be easy to solve in any other way.

Having found, as above, the equation of the first negative of a quadric, we have only to form its inverse, when we have the equation of the second positive pedal of the reciprocal quadric (Art. 514).

Ex. 1. To find the envelope of planes drawn perpendicularly at the extremities of the radii vectores to the plane $ax + by + cz + d$.

Here the parallel surface consists of a pair of planes, whose equation is $(ax + by + cz + d)^2 = k^2$, that of the envelope is therefore

$$(ax + by + cz + 2d)^2 = x^2 + y^2 + z^2.$$

Ex. 2. To find, in like manner, the first negative of the sphere

$$(x - \alpha)^2 + (y - \beta)^2 + (z - \gamma)^2 = r^2.$$

The parallel surface consists of the pair of concentric spheres

$$(x - \alpha)^2 + (y - \beta)^2 + (z - \gamma)^2 = (r \pm k)^2.$$

The envelope is therefore

$$(x - 2\alpha)^2 + (y - 2\beta)^2 + (z - 2\gamma)^2 = \{2r \pm \sqrt{(x^2 + y^2 + z^2)}\}^2,$$

which denotes a quadric of revolution.

CHAPTER XV.

SURFACES OF THE THIRD DEGREE.

519. THE general theory of surfaces, explained Chap. XI., gives the following results, when applied to cubical surfaces. The tangent cone whose vertex is any point, and which envelopes such a surface, is, in general, of the sixth degree, having six cuspidal edges and no ordinary double edge. It is consequently of the twelfth class, having twenty-four stationary, and twenty-seven double tangent planes. Since then through any line twelve tangent planes can be drawn to the surface, any line meets the reciprocal in twelve points; and the reciprocal is, in general, of the twelfth degree. Its equation can be found as at *Higher Plane Curves*, Art. 91. The problem is the same as that of finding the condition that the plane

$$\alpha x + \beta y + \gamma z + \delta w$$

should touch the surface. Multiply the equation of the surface by δ^3 , and then eliminate δw by the help of the equation of the plane. The result is a homogeneous cubic in x, y, z , containing also $\alpha, \beta, \gamma, \delta$ in the third degree. The discriminant of this equation is of the twelfth degree in its coefficients, and therefore of the thirty-sixth in $\alpha, \beta, \gamma, \delta$; but this consists of the equation of the reciprocal surface multiplied by the irrelevant factor δ^{24} . The form of the discriminant of a homogeneous cubical function in x, y, z is $64S^3 + T^2$ (*Higher Plane Curves*, Art. 224). The same, then, will be the form of the reciprocal of a surface of the third degree, S being of the fourth, and T of the sixth degree in $\alpha, \beta, \gamma, \delta$; (that is to say, S and T are *contravariants* of the given equation of the above degrees). It is easy to see that they are also of the same degrees in the coefficients of the given equation.

520. Surfaces may have either multiple points or multiple lines. When a surface has a double line of the degree p , then any plane meets the surface in a section having p double points. There is, therefore, the same limit to the degree of the double curve on a surface of the n^{th} degree that there is to the number of double points on a curve of the n^{th} degree. Since a curve of the third degree can have only one double point, if a surface of the third degree has a double line, that line must be a right line.* A cubic having a double line is necessarily a ruled surface, for every plane passing through this line meets the surface in the double line, reckoned twice, and in another line; but these other lines form a system of generators resting on the double line as director. If we make the double line the axis of z , the equation of the surface will be of the form

$$(ax^3 + 3bx^2y + 3cxy^2 + dy^3) + z(a'x^2 + 2b'xy + c'y^2) + (a''x^2 + 2b''xy + c''y^2) = 0,$$

which we may write $u_3 + zu_2 + v_2 = 0$. At any point on the double line there will be a pair of tangent planes $z'u_2 + v_2 = 0$. But as z' varies this denotes a system of planes in involution (*Conics*, Art. 342). Hence *the tangent planes at any point on the double line are two conjugate planes of a system in involution.*

There are two values of z' , real or imaginary, which will make $z'u_2 + v_2$ a perfect square; there are, therefore, two points on the double line at which the tangent planes coincide; and any plane through either of them meets the surface in a section having this point for a cusp. If the values of these squares be X^2 and Y^2 , it is evident that u_2 and v_2 can each be expressed in the form $lX^2 + mY^2$. If, then, we turn round the axes so as to have for coordinate planes the planes X , Y , that is to say, the tangent planes at the cuspidal points, then every term

* If a surface have a double or other multiple line, the reciprocal formed by the method of the last article would vanish identically; because then *every* plane meets the surface in a curve having a double point, and, therefore, the plane $\alpha x + \beta y + \gamma z + \delta w$ is to be considered as touching the surface, independently of any relation between α , β , γ , δ . The reciprocal can be found in this case by eliminating x , y , z , w between $u = 0$, $\alpha = u_1$, $\beta = u_2$, $\gamma = u_3$, $\delta = u_4$.

in the equation will be divisible by either x^2 or y^2 , and the equation may be reduced to the form $zx^2 = wy^2$.*

In this form it is evident that the surface is generated by lines $y = \lambda x$, $z = \lambda^2 w$, intersecting the two directing lines xy , zw ; and the generators join the points of a system on zw to the points of a system in involution on xy , homographic with the first system. Any plane through zw meets the surface in a pair of right lines, and is to be regarded as touching the surface in the two points where these lines meet zw . Thus, then, as the line xy is a line, every point of which is a double point, so the line zw is a line, every plane through which is a double tangent. The reciprocal of this surface, which is that considered Art. 468, is of like nature with itself.

The tangent cone whose vertex is any point, and which envelopes the surface, consists of the plane joining the point to the double line, reckoned twice, and a proper tangent cone of the fourth order. When the point is on the surface the cone reduces to the second order.

521. There is one case, to which my attention was called by Prof. Cayley, in which the reduction to the form $zx^2 = wy^2$ is not possible. If u_2 and v_2 , in the last article, have a common factor, then choosing the plane represented by this for one of the coordinate planes, we can easily throw the equation of the surface into the form $y^3 + x(zx + wy) = 0$.

The plane x touches the surface along the whole length of the double line, and meets the surface in three coincident right lines. The other tangent plane at any point coincides with the tangent plane to the hyperboloid $zx + wy$. This case may be considered as a limiting case of that considered in the last

* It is here supposed that the planes X , Y , the double planes of the system in involution, are real. We can always, however, reduce to the form $w(x^2 \pm y^2) + 2zxy$, the upper sign corresponding to real, and the lower to imaginary, double planes. In the latter case the double line is altogether "really" in the surface, every plane meeting the surface is a section having the point where it meets the line for a real node. In the former case this is only true for a limited portion of the double line, sections which meet it elsewhere having the point of meeting for a conjugate point, the two cuspidal points marking these limits on the double line. A right line, every point of which is a cusp, cannot exist on a cubic unless when the surface is a cone.

article; viz., when the double director xy coincides with the single one wz . The following generation of the surface may be given: Take a series of points on xy , and a homographic series of planes through it, then the generator of the cubic through any point on the line lies in the corresponding plane, and may be completely determined by taking as director a plane cubic having a double point where its plane meets the double line, and such that one of the tangents at the double point lies in the plane which corresponds to the double point considered as a point in the double line.*

522. The argument which proves that a proper cubic curve cannot have more than one double point does not apply to surfaces. In fact, the line joining two double points, since it is to be regarded as meeting the surface in four points, must lie altogether in the surface; but this does not imply that the surface breaks up into others of lower dimensions. The consideration of the tangent cone, however, supplies a limit to the number of double points on the surface. We have seen (Art. 279) that the tangent cone is of the sixth degree, and has six cuspidal edges, and it is known that a curve of the sixth degree having six cusps can have only four other double points. Since, then, every double point on the surface adds a double edge to the tangent cone, a cubical surface can at most have four double points.

It is necessary to distinguish the various kinds of node which the surface may possess. (A) At an ordinary node† (Art. 283) the tangent plane is replaced by a quadric cone. The line joining the node to any assumed point, is, as has been said, a double edge of the tangent cone from the latter point; and since to the tangent cone from any point corresponds a plane section of the reciprocal surface, this double edge evidently reduces by two the order of the reciprocal, or the class of the given surface. (B) The quadric cone may degenerate into a

* The reader is referred to an interesting geometrical memoir on cubical ruled surfaces by Cremona, "Atte del Reale Instituto Lombardo," vol. II., p. 291.

† Prof. Cayley calls the kind of node here considered a *cubic-node*, and it is referred to accordingly as C_2 .

pair of planes. Such a node may be called a *binode*; the planes the *biplanes*, and their intersection the *edge*. In the case first considered, it is easy to see that the tangent planes to any tangent cone along its double edge are the planes drawn through this line to touch the nodal cone. When, therefore, the nodal cone reduces to two planes, these tangent planes coincide, and the line to the binode is a cuspidal edge of the tangent cone. A binode, therefore, ordinarily reduces the class of the surface by three. A cubic cannot have more than three binodes, since a proper sextic cone cannot have more than nine cuspidal edges. But there may be special cases of binodes. (1) At an ordinary binode B_3 the edge does not lie on the surface; but if it does, the binode is special B_4 , and reduces the class of the surface by four. Thus, let xyz be the binode, x, y the biplanes, the general equation of the surface will be of the form $u_3 + xy = 0$, where $u_3 = c_0z^3 + 3c_1z^2x + 3c_2z^2y + \&c$. The case where $c_0 = 0$ is the special one under consideration. This kind of binode may be considered as resulting from the union of two conical nodes. (2) In the special case last considered, the surface is touched along the edge by a plane $c_1x + c_2y$, which commonly is distinct from one of the biplanes; but it may coincide with one of them, that is to say, we may have either c_1 or $c_2 = 0$. In this case, the binode B_5 reduces the class of the surface by five. Such a point may be considered as resulting from the union of a conical node and binode. (3) Lastly, we may have either x or y a factor in u_3 , and we have then a binode B_6 , which may be regarded as resulting from the union of three conical nodes, and which reduces the class of the surface by six. In this case the edge is said to be *oscular*.* (C) The two biplanes may coincide, when we have what may be called a *unode* U_6 , which reduces the class of the surface by six; the equation then being reducible to the form $u_3 + x^2 = 0$.

* In general, if a surface is touched along a right line by a plane, the right line counts twice as part of the complete intersection of the surface by the plane, the remaining intersection being of the order $n - 2$. The line may, however, count three times, the remaining intersection being only of the order $n - 3$. Prof. Cayley calls the line *torsal* in the first case, *oscular* in the second. He calls it *scrolar* if the surface merely contain the right line, in which case there is ordinarily a different tangent plane at each point of the line.

The uniplane x meets the surface in three right lines, which are commonly distinct; but either, two of these may coincide, or all three may coincide, when we have special cases of unodes, U_7 , U_8 which reduce the class of the surface by seven and eight respectively. U_6 may be regarded as equivalent to three conical nodes, U_7 to two conical and a binode, U_8 to two binodes and a conical.

523. Distinguishing cubic surfaces according to the singularities described in the preceding articles, we can enumerate twenty-three possible forms of cubics, which are exhibited in the following table :

	1, 2, 3, 4, 5, 6, 7, 8, 9, 10,
class	12, 10, 9, 8, 8, 7, 7, 6, 6, 6,
singularities	0, $C_2, B_3, 2C_2, B_4, B_3 + C_2, B_5, 3C_2, 2B_3, B_4 + C_2,$
	11, 12, 13, 14, 15, 16, 17, 18,
class	6, 6, 5, 5, 5, 4, 4, 4,
singularities	$B_6, U_6, B_3 + 2C_2, B_5 + C_2, U_7, 4C_2, 2B_3 + C_2, B_4 + 2C_2,$
	19, 20, 21,
class	4, 4, 3,
singularities	$B_6 + C_2, U_8, 3B_3.$

These are the various possible combinations of nodal points; and the number twenty-three is completed by the two kinds of ruled surfaces or scrolls described Arts. 520, 521, each of which is of the third class.*

Ex. 1. What is the degree of the reciprocal of $xyz = w^3$?

Ans. There are three biplanar points in the plane w , and the reciprocal is a cubic.

Ex. 2. What is the reciprocal of $\frac{l}{x} + \frac{m}{y} + \frac{n}{z} + \frac{p}{w} = 0$?

Ans. This represents a cubic having the vertices of the pyramid $xyzw$ for double points; and the reciprocal must be of the fourth degree.

* The effect of the nodes C_2, B_3, U_6 on the class of the surface was pointed out by me, *Cambridge and Dublin Mathematical Journal*, 1847, vol. II., p. 65; and the twenty-seven right lines on the surface were accounted for in each case where we have any combination of these nodes, *Cambridge and Dublin Mathematical Journal*, 1849, vol. IV., p. 252. The special cases B_4, B_5, B_6, U_7, U_8 were remarked by Schläfli, *Phil. Trans.*, 1863, p. 201. See also Prof. Cayley's Memoir on Cubic Surfaces, *Phil. Trans.*, 1869, pp. 231-326.

The equation of the tangent plane at any point $x'y'z'w'$ can be thrown into the form $\frac{lx}{x'^2} + \frac{my}{y'^2} + \frac{nz}{z'^2} + \frac{pw}{w'^2} = 0$, whence it follows that the condition that

$$ax + \beta y + \gamma z + \delta w$$

should be a tangent plane is

$$(la)^{\frac{1}{2}} + (m\beta)^{\frac{1}{2}} + (n\gamma)^{\frac{1}{2}} + (p\delta)^{\frac{1}{2}} = 0,$$

an equation which, cleared of radicals, is of the fourth degree.* Generally the reciprocal of $ax^n + by^n + cz^n + dw^n$ is of the form

$$Aa^{\frac{n}{n-1}} + B\beta^{\frac{n}{n-1}} + C\gamma^{\frac{n}{n-1}} + D\delta^{\frac{n}{n-1}} = 0,$$

(*Higher Plane Curves*, p. 73).

The tangent cone to this surface, whose vertex is any point on the surface, being of the fourth degree, and having four double edges, must break up into two cones of the second degree.

A cubic having four double points is also the envelope of

$$a\alpha^2 + b\beta^2 + c\gamma^2 + 2l\beta\gamma + 2m\gamma\alpha + 2n\alpha\beta,$$

where a, b, c, l, m, n represent planes; and $\alpha : \gamma, \beta : \gamma$ are two variable parameters. It is obvious that the envelope is of the third degree; and it is of the fourth class; since if we substitute the coordinates of two points we can determine four planes of the system passing through the line joining these points.

Generally the envelope of $a\alpha^n + b\beta^n + \&c.$ is of the degree $3(n-1)^2$ and of the class n^2 . The tangent cone from any point is of the degree $3n(n-1)$. It has a cuspidal curve whose order is the same as the order of the condition that $U + \lambda V$ may represent a plane curve having a cusp, U and V denoting plane curves of the n^{th} order; or, in other words, is equal to the number of curves of the form $U + \lambda V + \mu W$ which can have a cusp. The surface has a nodal curve whose order is the same as the number of curves of the form $U + \lambda V + \mu W$ which can have two double points. For these numbers, see *Higher Algebra*, Lesson XVIII.

524. The equation of a cubic having no multiple point may be thrown into the form $ax^3 + by^3 + cz^3 + dv^3 + ew^3 = 0$, where x, y, z, v, w represent planes, and where for simplicity we suppose that the constants implicitly involved in $x, y, \&c.$ have been so chosen, that the identical relation connecting the equations of any five planes (Art. 38) may be written in the form $x + y + z + v + w = 0$. In fact, the general equation of the third degree contains twenty terms, and therefore nineteen independent

* Writing x, y, z, w in place of $la, m\beta, n\gamma, p\delta$ respectively, the equation of the reciprocal surface is

$$\surd(x) + \surd(y) + \surd(z) + \surd(w) = 0,$$

which rationalised is

$$(x^2 + y^2 + z^2 + w^2 - 2yz - 2zx - 2xy - 2xw - 2yw - 2zw)^2 - 64xyzw = 0,$$

the surface commonly known as Steiner's quartic. It has three double lines meeting in a point; every tangent plane cuts it in two conics, &c.: its properties have been studied by Kummer, Weierstrass, Schröter, Cremona (see *Crelle*, vols. 63, 64), and more recently in a memoir by F. Gerbaldi, Turin, 1881.

constants, but the form just written contains five terms and, therefore, four expressed independent constants, while, besides, the equation of each of the five planes implicitly involves three constants. The form just written, therefore, contains the same number of constants as the general equation. This form given by Mr. Sylvester in 1851 (*Cambridge and Dublin Mathematical Journal*, vol. VI., p. 199) is very convenient for the investigation of the properties of cubical surfaces in general.*

525. If we write the equation of the first polar of any point with regard to a surface of the n^{th} order,

$$x'L + y'M + z'N + w'P = 0,$$

then, if it have a double point, that point will satisfy the equations

$$\begin{aligned} ax' + hy' + gz' + lw' = 0, & \quad hx' + by' + fz' + mw' = 0, \\ gx' + fy' + cz' + nw' = 0, & \quad lx' + my' + nz' + dw' = 0, \end{aligned}$$

where $a, b, \&c.$ denote second differential coefficients corresponding to these letters, as we have used them in the general equation of the second degree. Now, if between the above equations we eliminate $x'y'z'w'$, we obtain the locus of all points which are double points on first polars. This is of the degree $4(n-2)$, and is, in fact, the *Hessian* (Art. 285). If we eliminate the $xyzw$ which occur in $a, b, \&c.$, since the four equations are each of the degree $(n-2)$, the resulting equation in $x'y'z'w'$ will be of the degree $4(n-2)^3$, and will represent the locus of

* It was observed (*Higher Plane Curves*, Art. 25) that two forms may apparently contain the same number of independent constants, and yet that one may be less general than the other. Thus, when a form is found to contain the same number of constants as the general equation, it is not absolutely demonstrated that the general equation is reducible to this form; and Clebsch has noticed a remarkable exception in the case of curves of the fourth order (see note, Art. 235). In the present case, though Mr. Sylvester gave his theorem without further demonstration, he states that he was in possession of a proof that the general equation could be reduced to the sum of five cubes, and in but a single way. Such a proof has been published by Clebsch (*Crelle*, vol. LIX., p. 193). See also Gordan *Math. Annalen*, v. 341; and on the general theory of cubic surfaces Cremona, *Crelle*, vol. 68; Sturm, *Synthetische Untersuchungen über Flächen dritter Ordnung*. Clebsch erroneously ascribes the theorem in the text to Steiner, who gave it in the year 1856 (*Crelle*, vol. LIII., p. 133); but this, as well as Steiner's other principal results, had been known in this country a few years before.

points whose first polars have double points. Or, again, H is the locus of points whose polar quadrics are cones, while the second surface, which (see *Higher Plane Curves*, Art. 70) may be called the *Steinerian*, is the locus of the vertices of such cones. In the case of surfaces of the third degree, it is easy to see that the four equations above written are symmetrical between $xyzw$ and $x'y'z'w'$; and, therefore, that the Hessian and Steinerian are identical. Thus, then, *if the polar quadric of any point A with respect to a cubic be a cone whose vertex is B , the polar quadric of B is a cone whose vertex is A .* The points A and B are said to be corresponding points on the Hessian (see *Higher Plane Curves*, Art. 175, &c.).

526. *The tangent plane to the Hessian of a cubic at A is the polar plane of B with respect to the cubic.* For if we take any point A' consecutive to A and on the Hessian, then since the first polars of A and A' are consecutive and both cones, it appears (as at *Higher Plane Curves*, Art. 178) that their intersection passes indefinitely near B , the vertex of either cone; therefore the polar plane of B passes through AA' ; and, in like manner, it passes through every other point consecutive to A . It is, therefore, the tangent plane at A . And the polar plane of any point A on the Hessian of a surface of any degree is the tangent plane of the corresponding point B on the Steinerian. In particular, *the tangent planes to U along the parabolic curve are tangent planes to the Steinerian*; that is to say, in the case of a cubic *the developable circumscribing a cubic along the parabolic curve also circumscribes the Hessian.* If any line meet the Hessian in two corresponding points A, B , and in two other points C, D , the tangent planes at A, B intersect along the line joining the two points corresponding to C, D .

527. We shall also investigate the preceding theorems by means of the canonical form. The polar quadric of any point with regard to $ax^3 + by^3 + cz^3 + dv^3 + ew^3$ is got by substituting for w its value $-(x + y + z + v)$, when we can proceed according to the ordinary rules, the equation being then expressed in terms of four variables. We thus find for the polar quadric

$ax'x^2 + by'y^2 + cz'z^2 + dv'v^2 + ew'w^2 = 0$. If we differentiate this equation with respect to x , remembering that $dw = -dx$, we get $ax'x = ew'w$; and since the vertex of the cone must satisfy the four differentials with respect to x, y, z, v , we find that the coordinates x', y', z', v', w' of any point A on the Hessian are connected with the coordinates x, y, z, v, w of B , the vertex of the corresponding cone, by the relations

$$ax'x = by'y = cz'z = dv'v = ew'w.$$

And since we are only concerned with mutual ratios of coordinates, we may take 1 for the common value of these quantities and write the coordinates of B , $\frac{1}{ax'}, \frac{1}{by'}, \frac{1}{cz'}, \frac{1}{dv'}, \frac{1}{ew'}$. Since the coordinates of B must satisfy the identical relation $x + y + z + v + w = 0$, we thus get the equation of the Hessian

$$\frac{1}{ax} + \frac{1}{by} + \frac{1}{cz} + \frac{1}{dv} + \frac{1}{ew} = 0,$$

or $bcdeyzvw + cdeazvwx + deabvwx y + abcwxyz + abcdxyzv = 0$. This form of the equation shows that the line vw lies altogether in the Hessian, and that the point xyz is a double point on the Hessian; and since the five planes x, y, z, v, w give rise to ten combinations, whether taken by twos or by threes, we have Sylvester's theorem that *the five planes form a pentahedron whose ten vertices are double points on the Hessian and whose ten edges lie on the Hessian*. The polar quadric of the point xyz is $dv'v^2 + ew'w^2$, which resolves itself into two planes intersecting along vw , any point on which line may be regarded as the point B corresponding to xyz ; thus, then, *there are ten points whose polar quadrics break up into pairs of planes; these points are double points on the Hessian, and the intersections of the corresponding pairs of planes are lines on the Hessian*. It is by proving these theorems independently* that the resolution of the given equation into the sum of five cubes can be completely established.

* It appears from *Higher Algebra*, Lesson XVIII., that a symmetric determinant of p rows and columns, each constituent of which is a function of the n^{th} order in the variables, represents a surface of the np^{th} degree having $\frac{1}{6}p(p^2 - 1)n^3$ double points; and thus that the Hessian of a surface of the n^{th} degree always has $10(n - 2)^3$ double points.

The equation of the tangent plane at any point of the Hessian may be written

$$\frac{x}{ax'^2} + \frac{y}{by'^2} + \frac{z}{cz'^2} + \frac{v}{dv'^2} + \frac{w}{ew'^2} = 0,$$

which, if we substitute for x' , $\frac{1}{ax'}$, &c., becomes

$$ax'^2x + by'^2y + cz'^2z + dv'^2v + ew'^2w = 0,$$

but this is the polar plane of the corresponding point with regard to U .

528. If we consider all the points of a fixed plane, their polar planes envelope a surface, which (as at *Higher Plane Curves*, Art. 184) is also the locus of points whose polar quadrics touch the given plane. The parameters in the equation of the variable plane enter in the second degree; the problem is therefore that considered (Ex. 2, Art. 523) and the envelope is a cubic surface having four double points. The polar planes of the points of the section of the original cubic by the fixed plane are the tangent planes at those points, consequently this polar cubic of the given plane is inscribed in the developable formed by the tangent planes to the cubic along the section by the given plane (*Higher Plane Curves*, Art. 185). The polar plane of any point A of the section of the Hessian by the given plane touches the Hessian (Art. 526), and is, therefore, a common tangent plane of the Hessian and of the polar cubic now under consideration. But the polar quadric of B , being a cone whose vertex is A , is to be regarded as touching the given plane at A ; hence B is also the point of contact of the polar plane of A with the polar cubic. We thus obtain a theorem of Steiner's that *the polar cubic of any plane touches the Hessian along a certain curve*. This curve is the locus of the points B corresponding to the points of the section of the Hessian by the given plane. Now if points lie in any plane $lx + my + nz + pv + qw$, the corresponding points lie on the surface of the fourth order $\frac{l}{ax} + \frac{m}{by} + \frac{n}{cz} + \frac{p}{dv} + \frac{q}{ew}$. Also the intersection of this surface with the Hessian is of the sixteenth order, and includes the ten right lines xy , zw , &c.

The remaining curve of the sixth order is the curve along which the polar cubic of the given plane touches the Hessian. The four double points lie on this curve; they are the points whose polar quadrics are cones touching the given plane.

529. If on the line joining any two points $x'y'z'$, $x''y''z''$, we take any point $x' + \lambda x''$, &c., it is easy to see that its polar plane is of the form $P_{11} + 2\lambda P_{12} + \lambda^2 P_{22}$, where P_{11} , P_{22} are the polar planes of the two given points, and P_{12} is the polar plane of either point with regard to the polar quadric of the other. The envelope of this plane, considering λ variable, is evidently a quadric cone whose vertex is the intersection of the three planes. This cone is clearly a tangent cone to the polar cubic of any plane through the given line, the vertex of the cone being a point on that cubic. If the two assumed points be corresponding points on the Hessian, P_{12} vanishes identically; for the equation of the polar plane, with respect to a cone, of its vertex vanishes identically. Hence *the polar plane of any point of the line joining two corresponding points on the Hessian passes through the intersection of the tangent planes to the Hessian at these points.** In any assumed plane we can draw three lines joining corresponding points on the Hessian; for the curve of the sixth degree considered in the last article meets the assumed plane in three pairs of corresponding points. The polar cubic then of the assumed plane will contain three right lines; as will otherwise appear from the theory of right lines on cubics, which we shall now explain.

530. We said, note, p. 29, that a cubical surface necessarily contains right lines, and we now enquire how many in general lie on the surface.† In the first place it is to be observed that

* Steiner says that there are one hundred lines such that the polar plane of any point of one of them passes through a fixed line, but I believe that his theorem ought to be amended as above.

† The theory of right lines on a cubical surface was first studied in the year 1849, in a correspondence between Prof. Cayley and me, the results of which were published, *Cambridge and Dublin Mathematical Journal*, vol. iv., pp. 118, 252. Prof. Cayley first observed that a definite number of right lines must lie on the surface; the determination of that number as above, and the discussions in Art. 533 were supplied by me.

if a right line lie on the surface, every plane through it is a double tangent plane because it meets the surface in a right line and conic; that is to say, in a section having two double points. The planes then joining any point to the right lines on the surface are double tangent planes to the surface, and therefore also double tangent planes to the tangent cone whose vertex is that point. But we have seen (Art. 519) that the number of such double tangent planes is *twenty-seven*.

This result may be otherwise established as follows: let us suppose that a cubic contains one right line, and let us examine in how many ways a plane can be drawn through the right line, such that the conic in which it meets the surface may break up into two right lines. Let the right line be wz ; let the equation of the surface be $wU = zV$; let us substitute $w = \mu z$, divide out by z , and then form the discriminant of the resulting quadric in x, y, z . Now in this quadric it is seen without difficulty that the coefficients of x^2 , xy , and y^2 only contain μ in the first degree; that those of xz and yz contain μ in the second degree, and that of z^2 in the third degree. It follows hence that the equation obtained by equating the discriminant to nothing is of the fifth degree in μ ; and therefore that *through any right line on a cubical surface can be drawn five planes, each of which meets the surface in another pair of right lines*; and, consequently, *every right line on a cubic is intersected by ten others*. Consider now the section of the surface by one of the planes just referred to. Every line on the surface must meet in some point the section by this plane, and therefore must intersect some one of the three lines in this plane. But each of these lines is intersected by eight in addition to the lines in the plane; there are therefore twenty-four lines on the cubic besides the three in the plane; that is to say, *twenty-seven in all*.

We shall hereafter show how to form the equation of a surface of the ninth order meeting the given cubic in those lines.

531. Since the equation of a plane contains three independent constants, a plane may be made to fulfil any three

conditions, and therefore a finite number of planes can be determined which shall touch a surface in three points. We can now determine this number in the case of a cubical surface. We have seen that through each of the twenty-seven lines can be drawn five triple tangent planes: for every plane intersecting in three right lines touches at the vertices of the triangle formed by them, these being double points in the section. The number 5×27 is to be divided by three, since each of the planes contains three right lines; *there are therefore in all forty-five triple tangent planes.*

532. *Every plane through a right line on a cubic is obviously a double tangent plane; and the pairs of points of contact form a system in involution.* Let the axis of z lie on the surface, and let the part of the equation which is of the first degree in x and y be $(az^2 + bz + c)x + (a'z^2 + b'z + c')y$; then the two points of contact of the plane $y = \mu x$ are determined by the equation

$$(az^2 + bz + c) + \mu(a'z^2 + b'z + c') = 0,$$

but this denotes a system in involution (*Conics*, Art. 342). It follows hence, from the known properties of involution, that two planes can be drawn through the line to touch the surface in two coincident points; that is to say, which cut it in a line and a conic touching that line. The points of contact are evidently the points where the right line meets the parabolic curve on the surface. It was proved (Art. 287) that the right line touches that curve. The two points then, where the line touches the parabolic curve, together with the points of contact of any plane through it, form a harmonic system. Of course the two points where the line touches the parabolic curve may be imaginary.

533. The number of right lines may also be determined thus. The form $ace = bdf$ (where $a, b, \&c.$ represent planes) is one which implicitly involves nineteen independent constants, and therefore is one into which the general equation of a cubic may be thrown.* This surface obviously contains nine

* It will be found in one hundred and twenty ways.

lines (ab , cd , &c.). Any plane then $a = \mu b$ which meets the surface in right lines meets it in the same lines in which it meets the hyperboloid $\mu ce = df$. The two lines are therefore generators of different species of that hyperboloid. One meets the lines cd , ef , and the other the lines cf , de . And, since μ has three values, there are three lines which meet ab , cd , ef . The same thing follows from the consideration that the hyperboloid determined by these lines must meet the surface in three more lines (Art. 345).

Now there are clearly six hyperboloids, ab , cd , ef ; ab , cf , de , &c. which determine eighteen lines in addition to the nine with which we started, that is to say, as before, twenty-seven in all.

If we denote each of the eighteen lines by the three which it meets, the twenty-seven lines may be enumerated as follows: there are the original nine ab , ad , af , cb , cd , cf , eb , ed , ef ; together with $(ab.cd.ef)_1$, $(ab.cd.ef)_2$, $(ab.cd.ef)_3$, and in like manner three lines of each of the forms $ab.cf.de$, $ad.bc.ef$, $ad.be.cf$, $af.bc.de$, $af.be.cd$. The five planes which can be drawn through any of the lines ab are the planes a and b , meeting respectively in the pairs of lines ad , af ; bc , be ; and the three planes which meet in $(ab.cd.ef)_1$, $(ab.cf.de)_1$; $(ab.cd.ef)_2$, $(ab.cf.de)_2$; $(ab.cd.ef)_3$, $(ab.cf.de)_3$. The five planes which can be drawn through any of the lines $(ab.cd.ef)_1$, cut in the pairs of lines, ab , $(ab.cf.de)_1$; cd , $(af.cd.be)_1$, ef , $(ad.bc.ef)_1$; and in $(ad.be.cf)_2$, $(af.bc.de)_3$; $(ad.be.cf)_3$, $(af.bc.de)_2$.

534. Prof. Schläfli has made a new arrangement of the lines (*Quarterly Journal of Mathematics*, vol. II. p. 116), which leads to a simpler notation, and gives a clearer conception how they lie. Writing down the two systems of six non-intersecting lines

$$ab, cd, ef, (ad.be.cf)_1, (ad.be.cf)_2, (ad.be.cf)_3,$$

$$cf, be, ad, (ab.cd.ef)_1, (ab.cd.ef)_2, (ab.cd.ef)_3,$$

it is easy to see that each line of one system does not intersect the line of the other system, which is written in the same

vertical line, but that it intersects the five other lines of the second system. We may write then these two systems

$$\begin{array}{c}
 a_1, a_2, a_3, a_4, a_5, a_6, \\
 b_1, b_2, b_3, b_4, b_5, b_6,
 \end{array}$$

which is what Schläfli calls a "double-six." It is easy to see from the previous notation that the line which lies in the plane of a_1, b_2 , is the same as that which lies in the plane of a_2, b_1 . Hence the fifteen other lines may be represented by the notation c_{12}, c_{34} , &c., where c_{12} lies in the plane of a_1, b_2 , and there are evidently fifteen combinations in pairs of the six numbers 1, 2, &c. The five planes which can be drawn through c_{12} are the two which meet in the pairs of lines a_1b_2, a_2b_1 , and those which meet in $c_{34}c_{56}, c_{35}c_{46}, c_{36}c_{45}$. There are evidently thirty planes which contain a line of each of the systems a, b, c ; and fifteen planes which contain three c lines. It will be found that out of the twenty-seven lines can be constructed thirty-six "double-sixes."

535. We can now geometrically construct a system of twenty-seven lines which can belong to a cubical surface. We may start by taking arbitrarily any line a_1 and five others which intersect it, b_2, b_3, b_4, b_5, b_6 . These determine a cubical surface, for if we describe such a surface through four of the points where a_1 is met by the other lines and through three more points on each of these lines, then the cubic determined by these nineteen points contains all the lines, since each line has four points common with the surface. Now if we are given four non-intersecting lines, we can in general draw two transversals which shall intersect them all; for the hyperboloid determined by any three meets the fourth in two points through which the transversals pass (see Art. 57*d* and note p. 419). Through any four then of the lines b_3, b_4, b_5, b_6 we can draw in addition to the line a_1 another transversal a_2 , which must also lie on the surface since it meets it in four points. In this manner we construct the five new lines a_2, a_3, a_4, a_5, a_6 . If we then take another transversal meeting the four first of these lines, the theory already explained shows that it will be a line b_1 , which will also meet the fifth. We have thus constructed a

“double-six.” We can then immediately construct the remaining lines by taking the plane of any pair a_1b_2 , which will be met by the lines b_1, a_2 in points which lie on the line c_{12} .

536. M. Schläfli has made an analysis of the different species of cubics according to the reality of the twenty-seven lines. He finds thus five species: *A.* all the lines and planes real; *B.* fifteen lines and fifteen planes real; *C.* seven lines and five planes real; that is to say, there is one right line through which five real planes can be drawn, only three of which contain real triangles; *D.* three lines and thirteen planes real: namely, there is one real triangle through every side of which pass four other real planes; and, *E.* three lines and seven planes real.

I have also given (*Cambridge and Dublin Mathematical Journal*, vol. IV. p. 256) an enumeration of the modifications of the theory when the surface has one or more double points. It may be stated generally, that the cubic has always twenty-seven right lines and forty-five triple tangent planes, if we count a line or plane through a double point as two, through two double points as four, and a plane through three such points as eight. Thus, if the surface has one double point, there are six lines passing through that point, and fifteen other lines, one in the plane of each pair. There are fifteen treble tangent planes not passing through the double point. Thus $2 \times 6 + 15 = 27$; $2 \times 15 + 15 = 45$.

Again, if the surface have four double points, the lines are the six edges of the pyramid formed by the four points (6×4), together with three others lying in the same plane, each of which meets two opposite edges of the pyramid. The planes are the plane of these three lines 1, six planes each through one of these lines and through an edge (6×2), together with the four faces of the pyramid (4×8).

The reader will find the other cases discussed in the paper just referred to, and in a later memoir by Schläfli in the *Philosophical Transactions* for 1863.

537. It is known that in a plane cubic the polar line, with respect to the Hessian, of any point on the curve, meets on

the curve the tangent at that point. Clebsch has given as the corresponding theorem for surfaces, *The polar plane, with respect to the Hessian, of any point on the cubic, meets the tangent plane at that point, in the line which joins the three points of inflexion of the section by the tangent plane.* It will be remembered that the section by a tangent plane is a cubic having a double point, and therefore having only three points of inflexion lying on a line. If w be this line, xy the double point, the equation of such a curve may be written

$$x^3 + y^3 + 6xyw = 0.$$

Writing the equation of the surface (the tangent plane being z), $x^3 + y^3 + 6xyw + zu = 0$, where u is a complete function of the second degree $u = dz^2 + 6lxw + 6myw + 3nzw + \&c.$, of which we have only written the terms we shall actually require; and working out the equation of the Hessian, we find the terms below the second degree in x, y, z to be $d^2w^4 + d(n - 2lm)zw^3$. The polar plane then of the Hessian with respect to the point xyz is $4dw + (n - 2lm)z$, which passes through the intersection of zw , as was to be proved.

If the tangent plane $z = 0$ pass through one of the right lines on the cubic, the section by it consists of the right line x and a conic, and may be written $x^3 + 6xyw = 0$; and, as before, the polar plane of the point xyz with respect to the Hessian passes through the line w , a theorem which may be geometrically stated as follows: *When the section by the tangent plane is a line and a conic, the polar plane, with respect to the Hessian, of either point in which the line meets the conic, passes through the tangent to the conic at the other point.* If the tangent plane passes through two right lines on the cubic, the section reduces to xyw , and the polar plane still passes through w , that is to say, through the third line in which the plane meets the cubic. If the point of contact is a cusp, it is proved in like manner that the line through which the polar plane passes is the line joining the cusp to the single point of inflexion of the section.

The conclusions of this article may be applied with a slight modification to surfaces of higher degree than the third: for if we add to the equation of the surface with which we have

worked, terms of higher degree in xyz than the third, these will not affect the terms in the equation of the Hessian which are below the second degree in x, y, z . And the theorem is that the polar plane, with respect to the Hessian, of any point on a surface intersects the tangent plane at that point, in the line joining the points of inflexion of the section, by the tangent plane, of the polar cubic of the same point.

INVARIANTS AND COVARIANTS OF A CUBIC.

538. We shall in this section give an account of the principal invariants, covariants, &c., that a cubic can have. We only suppose the reader to have learned from the *Lessons on Higher Algebra*, or elsewhere, some of the most elementary properties of these functions. An invariant of the equation of a surface is a function of the coefficients, whose vanishing expresses some permanent property of the surface, as for example that it has a nodal point. A covariant, as for example the Hessian, denotes a surface having to the original surface some relation which is independent of the choice of axes. A contravariant is a relation between $\alpha, \beta, \gamma, \delta$, expressing the condition that the plane $\alpha x + \beta y + \gamma z + \delta w$ shall have some permanent relation to the given surface, as for example that it shall touch the surface. The property of which we shall make the most use in this section is that proved (*Lessons on Higher Algebra*, Art. 139), viz. that if we substitute in a contravariant for α, β , &c., $\frac{d}{dx}, \frac{d}{dy}$, &c., and then operate on either the original function or one of its covariants, we shall get a new covariant, which will reduce to an invariant if the variables have disappeared from the result. In like manner, if we substitute in any covariant for x, y , &c., $\frac{d}{d\alpha}, \frac{d}{d\beta}$, &c., and operate on a contravariant, we get a new contravariant or invariant.

Now, in discussing these properties of a cubic we mean to use Sylvester's canonical form, in which it is expressed by the sum of five cubes. We have calculated for this form the

Hessian (Art. 527), and there would be no difficulty in calculating other covariants for the same form. It remains to show how to calculate contravariants in the same case. Let us suppose that when a function U is expressed in terms of four independent variables, we have got any contravariant in $\alpha, \beta, \gamma, \delta$; and let us examine what this becomes when the function is expressed by five variables connected by a linear relation. But obviously we can reduce the function of five variables to one of four, by substituting for the fifth its value in terms of the others, viz. $w = -(x + y + z + v)$. To find then the condition that the plane $\alpha x + \beta y + \gamma z + \delta v + \epsilon w$ may have any assigned relation to the given surface, is the same problem as to find that the plane $(\alpha - \epsilon)x + (\beta - \epsilon)y + (\gamma - \epsilon)z + (\delta - \epsilon)v$ may have the same relation to the surface, its equation being expressed in terms of four variables; so that the contravariant in five letters is derived from that in four by substituting $\alpha - \epsilon, \beta - \epsilon, \gamma - \epsilon, \delta - \epsilon$ respectively for $\alpha, \beta, \gamma, \delta$. Every contravariant in five letters is therefore a function of the differences between $\alpha, \beta, \gamma, \delta, \epsilon$. This method will be better understood from the following example:

Ex. The equation of a quadric is given in the form

$$ax^2 + by^2 + cz^2 + dv^2 + ew^2 = 0,$$

where $x + y + z + v + w = 0$; to find the condition that $\alpha x + \beta y + \gamma z + \delta v + \epsilon w$ may touch the surface. If we reduce the equation of the quadric to a function of four variables by substituting for w its value in terms of the others, the coefficients of x^2, y^2, z^2, v^2 are respectively $a + e, b + e, c + e, d + e$, while every other coefficient becomes e . If now we substitute these values in the equation of Art. 79, the condition that the plane $\alpha x + \beta y + \gamma z + \delta v$ may touch, becomes

$$\alpha^2 (bcd + bce + cde + dbe) + \beta^2 (cda + cde + dae + ace) + \gamma^2 (dab + dae + a\delta e + b\delta e) + \delta^2 (abc + a\delta e + b\delta e + cae) - 2e (ad\beta\gamma + b\delta\gamma\alpha + cda\beta + bca\delta + ca\beta\delta + ab\gamma\delta) = 0.$$

Lastly, if we write in the above for $\alpha, \beta, \gamma, \delta$, $\alpha - \epsilon, \beta - \epsilon$, &c., it becomes

$$bcd (\alpha - \epsilon)^2 + cda (\beta - \epsilon)^2 + dab (\gamma - \epsilon)^2 + abc (\delta - \epsilon)^2 + bce (\alpha - \delta)^2 + cae (\beta - \delta)^2 + a\delta e (\gamma - \delta)^2 + ade (\beta - \gamma)^2 + b\delta e (\alpha - \gamma)^2 + cde (\alpha - \beta)^2 = 0,$$

a contravariant which may be briefly written $\Sigma cde (\alpha - \beta)^2 = 0$.

539. We have referred to the theorem that when a contravariant in four letters is given, we may substitute for $\alpha, \beta, \gamma, \delta$ differential symbols with respect to x, y, z, w ; and that then by operating with the function so obtained on any covariant we get a new covariant. Suppose now that we operate

on a function expressed in terms of five letters x, y, z, v, w . Since x appears in this function both explicitly and also where it is introduced in w , the differential with respect to x is $\frac{d}{dx} + \frac{dw}{dx} \frac{d}{dw}$, or, in virtue of the relation connecting w with the other variables, $\frac{d}{dx} - \frac{d}{dw}$. Hence, a contravariant in four letters is turned into an operating symbol in five by substituting for

$$\alpha, \beta, \gamma, \delta; \frac{d}{dx} - \frac{d}{dw}, \frac{d}{dy} - \frac{d}{dw}, \frac{d}{dz} - \frac{d}{dw}, \frac{d}{dv} - \frac{d}{dw}.$$

But we have seen in the last article that the contravariant in five letters has been obtained from one in four, by writing for $\alpha, \alpha - \epsilon$, &c. It follows then immediately that *if in any contravariant in five letters we substitute for $\alpha, \beta, \gamma, \delta, \epsilon, \frac{d}{dx}, \frac{d}{dy}, \frac{d}{dz}, \frac{d}{dv}, \frac{d}{dw}$, we obtain an operating symbol, with which operating on the original function, or on any covariant, we obtain a new covariant or invariant.* The importance of this is that when we have once found a contravariant of the form in five letters we can obtain a new covariant without the laborious process of recurring to the form in four letters.

Ex. We have seen that $\Sigma cde (\alpha - \beta)^2$ is a contravariant of the form

$$ax^2 + by^2 + cz^2 + dv^2 + ew^2.$$

If then we operate on the quadric with $\Sigma cde \left(\frac{d}{dx} - \frac{d}{dy}\right)^2$, the result, which only differs by a numerical factor from

$$bcde + cdea + deab + eabc + abcd,$$

is an invariant of the quadric. It is in fact its discriminant, and could have been obtained from the expression, Art. 67, by writing, as in the last article, $a + e, b + e, c + e, d + e$ for a, b, c, d , and putting all the other coefficients equal to e .

540. In like manner it is proved that we may substitute in any covariant function for x, y, z, v, w , differential symbols with regard to $\alpha, \beta, \gamma, \delta, \epsilon$, and that operating with the function so obtained on any contravariant we get a new contravariant. In fact if we first reduce the function to one of four variables, and then make the differential substitution, which we have a

right to do, we have substituted for

$$x, y, z, v, w; \frac{d}{d\alpha}, \frac{d}{d\beta}, \frac{d}{d\gamma}, \frac{d}{d\delta}, \text{ and } -\left(\frac{d}{d\alpha} + \frac{d}{d\beta} + \frac{d}{d\gamma} + \frac{d}{d\delta}\right).$$

But since the contravariant in five letters was obtained from that in four by writing $\alpha - \varepsilon$ for α , &c., it is evident that the differentials of both with regard to $\alpha, \beta, \gamma, \delta$ are the same, while the differential of that in five letters with respect to ε is the negative sum of the differentials of that in four letters with respect to $\alpha, \beta, \gamma, \delta$. But this establishes the theorem. By this theorem and that in the last article we can, being given any covariant and contravariant, generate another, which again, combined with the former, gives rise to new ones without limit.

541. The polar quadric of any point with regard to the cubic $ax^3 + by^3 + cz^3 + dv^3 + ew^3$ is

$$ax'x^2 + by'y^2 + cz'z^2 + dv'v^2 + ew'w^2 = 0.$$

Now the Hessian is the discriminant of the polar quadric. Its equation therefore, by Ex., Art. 539, is $\Sigma bcdeyzvw = 0$, as was already proved, Art. 527. Again, what we have called (Art. 528) the polar cubic of a plane

$$\alpha x + \beta y + \gamma z + \delta v + \varepsilon w,$$

being the condition that this plane should touch the polar quadric is (by Ex., Art 538) $\Sigma cdezvw (\alpha - \beta)^2 = 0$. This is what is called a mixed concomitant, since it contains both sets of variables x, y , &c., and α, β , &c.

If now we substitute in this for α, β , &c., $\frac{d}{dx}, \frac{d}{dy}$, &c., and operate on the original cubic, we get the Hessian; but if we operate on the Hessian we get a covariant of the fifth order in the variables, and the seventh in the coefficients, to which we shall afterwards refer as Φ ,

$$\Phi = abcde \Sigma abx^2y^2z.$$

In order to apply the method indicated (Arts. 539, 540) it is necessary to have a contravariant; and for this purpose I have calculated the contravariant σ , which occurs in the equation

of the reciprocal surface, which, as we have already seen, is of the form $64\sigma^3 = \tau^2$. The contravariant σ expresses the condition that any plane $\alpha x + \beta y + \&c.$ should meet the surface in a cubic for which Aronhold's invariant S vanishes. It is of the fourth degree both in $\alpha, \beta, \&c.$, and in the coefficients of the cubic. In the case of four variables the leading term is α^4 multiplied by the S of the ternary cubic got by making $x=0$ in the equation of the surface. The remaining terms are calculated from this by means of the differential equation (*Lessons on Higher Algebra*, Art. 150). The form being found for four variables, that for five is calculated from it as in Art. 538. I suppress the details of the calculation, which, though tedious, present no difficulty. The result is

$$\sigma = \Sigma abcd (\alpha - \epsilon) (\beta - \epsilon) (\gamma - \epsilon) (\delta - \epsilon) \dots\dots\dots [1].$$

For facility of reference I mark the contravariants with numbers between brackets, and the covariants by numbers between parentheses, the cubic itself and the Hessian being numbered (1) and (2). We can now, as already explained, from any given covariant and contravariant, generate a new one, by substituting in that in which the variables are of lowest dimensions, differential symbols for the variables, and then operating on the other. The result is of the difference of their degrees in the variables, and of the sum of their degrees in the coefficients. If both are of equal dimensions, it is indifferent with which we operate. The result in this case is an invariant of the sum of their degrees in the coefficients. The results of this process are given in the next article.

542. (a) Combining (1) and [1], we expect to find a contravariant of the first degree in the variables, and the fifth in the coefficients; but this vanishes identically.

(b) (2) on [1] gives an invariant to which we shall refer as invariant A ,

$$A = \Sigma b^2 c^2 d^2 e^2 - 2abcde \Sigma abc.$$

If A be expressed by the symbolical method explained (*Lessons on Higher Algebra*, XIV., XIX), its expression is

$$(1235) (1246) (1347) (2348) (5678)^2.$$

(c) Combining [1] with the square of (1) we get a covariant quadric of the sixth order in the coefficients

$$abcde(ax^2 + by^2 + cz^2 + dv^2 + ew^2) \dots \dots \dots (3),$$

which expressed symbolically is (1234)(1235)(1456)(2456).

(d) (3) on [1] gives a contravariant quadric

$$a^2b^2c^2d^2e^2\Sigma(\alpha - \beta)^2 \dots \dots \dots [2].$$

(e) [2] on (1) gives a covariant plane of the eleventh order in the coefficients

$$a^2b^2c^2d^2e^2(ax + by + cz + dv + ew) \dots \dots \dots (4).$$

(f) (3) on [2] gives an invariant B ,

$$a^3b^3c^3d^3e^3(a + b + c + d + e).$$

(g) Combining with (3) the mixed concomitant (Art. 541) we get a covariant cubic of the ninth order in the coefficients

$$abcde\Sigma cde(a + b)zvw \dots \dots \dots (5).$$

(h) Combining (5) and [1] we have a linear contravariant of the thirteenth order in the coefficients

$$abcde\Sigma(a - b)(\alpha - \beta)\{(a + b)c^2d^2e^2 - abcde(cd + de + ec)\} \dots [3].$$

It seems unnecessary to give further details as to the steps by which particular concomitants are found, and we may therefore sum up the principal results.

543. It is easy to see that every invariant is a symmetric function of the quantities a, b, c, d, e . If then we denote the sum of these quantities, of their products in pairs, &c., by p, q, r, s, t , every invariant can be expressed in terms of these five quantities, and therefore in terms of the five following fundamental invariants, which are all obtained by continuing the process exemplified in the last article

$$A = s^2 - 4rt, \quad B = t^3p, \quad C = t^4s, \quad D = t^6q, \quad E = t^8;$$

whence also

$$C^2 - AE = 4t^9r.$$

We can, however, form skew invariants which cannot be rationally expressed in terms of the five fundamental invariants, although their squares can be rationally expressed in terms of these quantities. The simplest invariant of this kind is got

by expressing in terms of its coefficients the discriminant of the equation whose roots are a, b, c, d, e . This, it will be found, gives in terms of the fundamental invariants A, B, C, D, E an expression for t^{36} multiplied by the product of the squares of the differences of all the quantities $a, b, \&c.$ This invariant being a perfect square, its square root is an invariant F of the one-hundredth degree. Its expression in terms of the fundamental invariants is given, *Philosophical Transactions*, 1860, p. 233.

The discriminant of the cubic can easily be expressed in terms of the fundamental invariants. It is obtained by eliminating the variables between the four differentials with respect to x, y, z, v , that is to say,

$$ax^2 = by^2 = cz^2 = dv^2 = ew^2.$$

Hence $x^2, y^2, \&c.$ are proportional to $bcd, cdea, \&c.$ Substituting then in the equation $x + y + z + v + w = 0$, we get the discriminant

$$\sqrt{(bcde)} + \sqrt{(cdea)} + \sqrt{(deab)} + \sqrt{(eabc)} + \sqrt{(abcd)} = 0.$$

Clearing of radicals, the result, expressed in terms of the principal invariants, is

$$(A^2 - 64B)^2 = 16384(D + 2AC).$$

544. The cubic has four fundamental covariant planes of the orders 11, 19, 27, 43 in the coefficients, viz.

$$L = t^2 \Sigma ax, \quad L' = t^3 \Sigma bcde x, \quad L'' = t^5 \Sigma a^2 x, \quad L''' = t^8 \Sigma a^3 x.$$

Every other covariant, including the cubic itself, can, in general, be expressed in terms of these four, the coefficients being invariants. The condition that these four planes should meet in a point, is the invariant F of the one hundredth degree.

There are linear contravariants, the simplest of which, of the thirteenth degree, has been already given; the next being of the twenty-first, $t^4 \Sigma (a - b)(\alpha - \beta)$; the next of the twenty-ninth, $t^5 \Sigma cde (a - b)(\alpha - \beta)$, &c.

There are covariant quadrics of the sixth, fourteenth, twenty-second, &c. orders; and contravariants of the tenth, eighteenth, &c., the order increasing by eight.

There are covariant cubics of the ninth order $t\Sigma cde(a+b)zvw$, and of the seventeenth, $t^3\Sigma a^2x^3$, &c.

If we call the original cubic U , and this last covariant V , since if we form a covariant or invariant of $U + \lambda V$, the coefficients of the several powers of λ are evidently covariants or invariants of the cubic: it follows that, given any covariant or invariant of the cubic we are discussing, we can form from it a new one of the degree sixteen higher in the coefficients, by performing on it the operation

$$t^3 \left(a^2 \frac{d}{da} + b^2 \frac{d}{db} + c^2 \frac{d}{dc} + d^2 \frac{d}{dd} + e^2 \frac{d}{de} \right).$$

Of higher covariants we only think it necessary here to mention one of the fifth order, and fifteenth in the coefficients t^3xyzvw , which gives the five fundamental planes; and one of the ninth order, Θ the locus of points whose polar planes with respect to the Hessian touch their polar quadrics with respect to U . Its equation is expressed by the determinant, Art. 79, using α, β , &c. to denote the first differential coefficients of the Hessian with respect to the variables, and a, b , &c. the second differential coefficients of the cubic.

The equation of a covariant, whose intersection with the given cubic determines the twenty-seven lines, is $\Theta = 4H\Phi$, where Φ has the meaning explained, Art. 541. I verified this form, which was suggested to me by geometrical considerations, by examining the following form, to which the equation of the cubic can be reduced, by taking for the planes x and y the tangent planes at the two points where any of the lines meet the parabolic curve, and two determinate planes through these points for the planes w, z ,

$$z^2y + w^2x + 2xyz + 2xyw + ax^2y + by^2x + cx^2z + dy^2w = 0.$$

The part of the Hessian then which does not contain either x or y is z^2w^2 ; the corresponding part of Φ is $-2(cz^5 + dw^5)$, and of Θ is $-8w^2z^2(cz^5 + dw^5)$. The surface $\Theta - 4H\Phi$ has therefore no part which does not contain either x or y , and the line xy lies altogether on the surface, as in like manner

do the rest of the twenty-seven lines* Clebsch obtained the same formula directly, by the symbolical method of calculation, for which we refer to the *Lessons on Higher Algebra*.

* This section is abridged from a paper which I contributed to the *Philosophical Transactions*, 1860, p. 229. Shortly after the reading of my memoir, and before its publication, there appeared two papers in Crelle's *Journal*, vol. LVIII., by Professor Clebsch, in which some of my results were anticipated; in particular the expression of all the invariants of a cubic in terms of five fundamental, and the expression given above for the surface passing through the twenty-seven lines. The method, however, which I pursued was different from that of Professor Clebsch, and the discussion of the covariants, as well as the notice of the invariant F , I believe were new. Clebsch has expressed his last four invariants as functions of the coefficients of the Hessian. Thus the second is the invariant $(1234)^4$ of the Hessian, &c.

CHAPTER XVI.

SURFACES OF THE FOURTH ORDER.

545. THE theory of quartic surfaces in general has hitherto been little studied. The quartic developable, or torse, has been considered, Art. 367. Other forms of quartics, to which much attention has been paid, are the ruled surfaces or scrolls which have been discussed by Chasles, Cayley,* Schwarz, and Cremona; and quartics with a nodal conic which have been studied, in their general form, by Kummer,† Clebsch, Korndörfer, and others; and in the case where the nodal curve is the circle at infinity (under the names of cyclides and anallagmatic surfaces) by Casey, Darboux, Moutard, and others. In fact, in the classification of surfaces according to their order, the extent of the subject increases so rapidly with the order, that the theory for example of the particular kind of quartics last mentioned may be regarded as co-extensive with the entire theory of cubics.

546. The highest singularity which a quartic can possess is a triple line, which is necessarily a right line. Every such surface is a scroll, for it evidently contains an infinity of right lines, since every plane section through the triple line consists of that line counted thrice and another line. The equation may be written in the form $u_4 = zu_3 + wv_3$, where u_4 , u_3 , v_3 are functions of the fourth and third orders respectively

* See his memoirs on Scrolls, *Phil. Trans.*, 1864, p. 559; and 1869, p. 111, and the references there given.

† Kummer, *Berlin Monatsberichte*, July, 1863; *Crelle*, LXIV. (1864); Clebsch, *Crelle*, LXIX. (1868); Korndörfer, *Math. Annalen*, III.; Casey and Darboux, as cited, p. 481. See also the list of memoirs on the same subject given in Darboux's work.

in x and y , and xy denotes the triple line. The three tangent planes at any point on the triple line are given by the equation $z'u_3 + w'v_3 = 0$. Forming the discriminant of this equation, we see that there are in general four points on the triple line, at which two of its tangent planes coincide. We may take z and w as planes passing each through one of these points, and x and y as the corresponding double tangent planes, when the equation becomes $u_4 = z(ax^3 + bx^2y) + w(cxy^2 + dy^3)$. Further, by substituting for z , $z + \alpha x + \beta y$, and for w , $w + \gamma x + \delta y$, we can evidently determine α , β , γ , δ , so as to destroy the terms x^4 , x^3y , y^3x , y^4 in u_4 ; and so, finally, reduce the equation to the form $mxy^2 = z(ax^3 + bx^2y) + w(cxy^2 + dy^3)$. The planes z , w evidently touch the surface along the whole lengths of the lines zy , wx , respectively; and we see that the surface has four *torsal* generators, see note, p. 489. The surface may be generated according to the method of Art. 467, the directing curves being the triple line, and any two plane sections of the surface; that is to say, the directing curves are two plane quartics, each with a triple point, and the line joining the triple points, the quartics also having common the points in which each is met by the intersection of their planes. But the generation is more simple if we take each plane section as one made by the plane of two generators which meet in the triple line. This will be a conic in addition to these lines; and the scroll is generated by a line whose directing curves are two conics, and a right line meeting both conics.

The equation of a quartic with a triple line may also be obtained by eliminating, between the equations of two planes, a parameter entering into one in the first, into the other in the third degree; for instance,

$$\lambda x + y = 0, \quad \lambda^3 u + \lambda^2 v + \lambda w + z = 0;$$

that is to say, the generating line is the intersection of one of a series of planes through a fixed line with the corresponding one of a series of osculating planes to a twisted cubic, or tangent planes to a quartic torse. The four points where the torse meets the fixed line are the four torsal points already considered.

547. Returning to the equation

$$mx^2y^2 = z(ax^3 + bx^2y) + w(cxy^2 + dy^3)$$

there is an important distinction according as m does or does not vanish; or, in the form first given, according as u_4 is or is not capable of being expressed in the form $(\alpha x + \beta y)u_3 + (\gamma x + \delta y)v_3$. When m vanishes (II) the surface contains a right line zw which does not meet the triple line; otherwise (I) there is no such line. The existence of such a line implies a triple line on the reciprocal surface and *vice versa*. In fact, we have seen that every plane through the triple line contains one generator; to it will correspond in the reciprocal surface a line through every point of which passes one generator; that is to say, which is a simple line on the surface. Conversely, if a quartic scroll contain a director right line, every plane through it meets the surface in a right line and a cubic, and touches the surface in the three points where these intersect. Every plane through the right line therefore being a triple tangent plane, there will correspond on the reciprocal surface a line every point of which is a triple point. In the case, therefore, where m vanishes the equation of the reciprocal is reducible to the same general form as that of the original. In the general case (I) we can infer as follows the nature of the nodal curve in the reciprocal. At each point on the triple line can be drawn three generators. Consider the section made by the plane of any two; this will consist of two right lines and a conic through their intersection; and the plane will touch the surface at the two points where the lines are met again by the conic. Hence, at each point of the triple line three bitangent planes can be drawn to the scroll; and reciprocally every plane through the corresponding line meets the nodal curve of the reciprocal surface in three points. We infer then that this curve is a skew cubic, and we shall confirm this result by actually forming the equation of the reciprocal surface. It will be observed how the argument we have used is modified when the scroll has a simple director line, the three generators at any point of the triple line then lying all in one plane. If we substitute $y = \lambda x$ in the equation

of the scroll, we see that any generator is given by the equations

$$y = \lambda x, \quad m\lambda^2 x = z(a + b\lambda) + w(c\lambda^2 + d\lambda^3),$$

and joins the points

$$\begin{aligned} x = a + b\lambda, \quad y = \lambda(a + b\lambda), \quad z = m\lambda^2, \quad w = 0, \\ x = c + d\lambda, \quad y = \lambda(c + d\lambda), \quad z = 0, \quad w = m. \end{aligned}$$

The reciprocal line is therefore the intersection of

$$(x + \lambda y)(a + b\lambda) + m\lambda^2 z = 0, \quad (x + \lambda y)(c + d\lambda) + mw = 0,$$

and the equation of the reciprocal is got by eliminating λ between these equations. But if we consider the scroll generated by the intersection of corresponding tangent planes to two cones

$$\lambda^2 x + \lambda y + z = 0, \quad \lambda^2 u + \lambda v + w = 0,$$

this will be a quartic $(xw - uz)^2 = (yw - zv)(xv - yu)$ which has a twisted cubic for a nodal line, since the three quadrics represented by the members of this equation have common a twisted cubic, as is evident by writing their equations in the form $\frac{u}{x} = \frac{v}{y} = \frac{w}{z}$. In the case actually under consideration,

the equation of the reciprocal is

$$\begin{aligned} \{m^2 zw + mczx + mbyw + (bc - ad)xy\}^2 \\ = \{mdzx + mczy + (bc - ad)y^2\} \{mbxw + amyw + (bc - ad)x^2\}. \end{aligned}$$

This equation would become illusory if m vanished; and we must in that case (II) revert to the original form of the equations of a generator, which gives $y = \lambda x, (a + b\lambda)z + \lambda^2(c + d\lambda)w = 0$. The generator of the reciprocal scroll will be $\lambda y + x = 0, \lambda^2(c + d\lambda)z = (a + b\lambda)w$, and the reciprocal is obviously of like nature with the original.

The two classes of scrolls we have examined each include two subforms according as either b or c , or both, vanish. In these cases the triple line has either one or two points at which all three tangent planes coincide. According to the mode of generation, noticed at the end of last article, the fixed line touches the torse, and either one pair or two pairs of the torsal points coincide.

548. Besides the two classes of quartic scrolls with a triple line, already mentioned, we count the following :

III. u_3 and v_3 may have a common factor, which answers to the case $ad = bc$ in the equation already given: which is then reducible to the form

$$mx^2y^2 = (ax + by)(zx^2 + wy^2).$$

In this case also, in the method of Art. 546, the fixed line touches the torse. The generator of the scroll in one position coincides with the fixed line, $ax + by$ being the corresponding tangent plane which osculates along its whole length. Also the equation of the reciprocal scroll being

$$(mzw + axz + byw)^2 = zw(ay + bx)^2,$$

we see that it has as nodal lines the plane conic $ay + bx$, $mzw + axz + byw$, and the right line zw which intersects that conic. This class contains as subform, the case where $u_3 + \lambda v_3$ includes a perfect cube. The equation may then be reduced to the form $my^4 = x(zx^2 + wy^2)$, the reciprocal of which is $(xz - mw^2)^2 = y^2zw$.

IV. Again, u_3 and v_3 may have a pair of common factors and the equation is reducible to the form $x^2y^2 = (ax^2 + bxy + cy^2)(xz + yw)$, an equation which is easily seen by the same method, as before, to have a reciprocal of like form with itself.

V. Lastly, u_3 and v_3 may have common a square factor, the equation then taking the form

$$x^2y^2 = (ax + by)^2(xz + yw),$$

which is also its own reciprocal.* In this case two of the three sheets, which meet in the triple line, unite into a single cuspidal sheet. The case where u_3 and v_3 have three common factors need not be considered, as the surface would then be a cone.

549. We come now to quartic scrolls with only double lines. If a quartic have a non-plane nodal line, it will ordinarily be a scroll. For take any fixed point on the nodal line, and there is only one condition to be fulfilled in order that the line

* The first four classes enumerated answer to Cayley's ninth, third, twelfth, sixth, respectively; the last might be regarded as a subform of that preceding, but I have preferred to count it as a distinct class.

joining this to any variable point on the nodal line may lie altogether in the surface, a condition which we can ordinarily fulfil by means of the disposable parameter which regulates the position of the variable point. There being thus an infinite series of right lines, the surface is a scroll. But a case of exception occurs, when the surface has three nodal right lines meeting in a point. Here the section by the plane of any two consists of these lines, each counted twice, and there is no intersecting line lying in the surface. This is Steiner's quartic mentioned note p. 491. We consider now the other cases of quartics with nodal lines, commencing with those in which the line is of the third order. The case where the nodal lines are three right lines, no two of which are in the same plane, need not be considered, since it is easy to see that then the quartic is nothing else than the quadric, counted twice, generated by a line meeting these three director lines.

Let us commence with the case where the nodal line is a twisted cubic (VI and VII). Such a cubic may be represented by the three equations $xz - y^2 = 0$, $xw - yz = 0$, $yw - z^2 = 0$; the planes x and w being any two osculating planes of the cubic. The coordinates of any point on it may be taken as $x : y : z : w = \lambda^3 : \lambda^2 : \lambda : 1$. If the three quantities $xz - y^2$, $xw - yz$, $yw - z^2$ are called α, β, γ respectively, any quartic which has the cubic for a nodal line will be represented by a quadratic function of α, β, γ , say

$$a\alpha^2 + b\beta^2 + c\gamma^2 + 2f\beta\gamma + 2g\gamma\alpha + 2h\alpha\beta = 0.$$

Now consider the line joining two points on the cubic λ, μ ; the coordinates of any point on it will be of the form $\lambda^3 + \theta\mu^3$, $\lambda^2 + \theta\mu^2$, $\lambda + \theta\mu$, $1 + \theta$. If we substitute these values in α, β, γ , they become, after dividing by the common factor $\theta(\lambda - \mu)^2$, $\lambda\mu$, $\lambda + \mu$, 1 . Consequently the condition that the line should lie on the surface is

$$a\lambda^2\mu^2 + b(\lambda + \mu)^2 + c + 2f(\lambda + \mu) + 2g\lambda\mu + 2h\lambda\mu(\lambda + \mu) = 0.$$

Thus if either point be given, we have a quadratic to determine the position of the other; and we see that the surface is a scroll, and that through each point of the nodal line can be drawn two generators, each meeting the cubic twice. The six coordi-

nates (Art. 57a) of the line joining the points λ, μ are easily seen to be (omitting a common factor $\lambda - \mu$)

$$\lambda^2 + \lambda\mu + \mu^2, (\lambda + \mu), 1, \lambda\mu, -\lambda\mu(\lambda + \mu), \lambda^2\mu^2,$$

and as the condition just found is linear in these coordinates, we may say that a quartic scroll is generated by a line meeting a twisted cubic twice and whose six coordinates are connected by a linear relation, or, in other words, by the lines of an "involution of six lines" (see note, p. 419), which join two points on a twisted cubic.

In fact, if p, q, r, s, t, u be the six coordinates, we have the relation

$$bp + 2fq + cr + (b + 2g)s - 2ht + au = 0.$$

We saw (Art. 57c) that a particular case of the linear relation between the six coordinates of a line is the condition that it shall intersect a fixed line; and from what was there said, and from what has now been stated, it follows immediately that all the generators of the scroll will meet a fixed line, provided the quantities multiplying $p, q, \&c.$ in the preceding equation be themselves capable of being the six coordinates of a line; that is to say (VII), provided the condition be fulfilled,

$$b(b + 2g) - 4fh + ac = 0.$$

When this condition is fulfilled, it appears, from Art. 547, that the reciprocal of the scroll will have a triple line, the reciprocal in fact belonging to the first class of scrolls with a triple line there considered.

550. In order to find the equation of the reciprocal in the general case VI, we observe that to the generator joining the points, whose coordinates are $\lambda^3, \lambda^2, \lambda, 1; \mu^3, \mu^2, \mu, 1$, will correspond on the reciprocal scroll the generator whose equations are

$$x\lambda^3 + y\lambda^2 + z\lambda + w = 0, \quad x\mu^3 + y\mu^2 + z\mu + w = 0,$$

and the equation of the reciprocal is got by eliminating λ, μ between these equations and the relation already given connecting λ, μ . This elimination has been performed by Prof. Cayley; the work is too long to be here given, but the result is that the equation of the reciprocal scroll is of the same form and with the same coefficients as the original; so that the

scroll which has been defined as generated by a line in involution twice meeting a skew cubic may also be defined as generated by a line in involution lying in two osculating planes of a skew cubic. Thus then the fundamental division of scrolls with nodal skew cubic is into scrolls whose reciprocals are of like form (VI), and scrolls whose reciprocals have a triple line (VII). It is to be noted that the general form of the equation of the reciprocal contains as a factor the quantity $b^2 + 2bg - 4fh + ac$, the vanishing of which implies that the scroll belongs to the latter class. The two classes of scrolls may be generated by a line twice meeting a skew cubic, and also meeting, in the one case, a conic twice meeting the cubic; in the other, a right line.*

551. If we put $\lambda = \mu$ in the equation just given, we obtain the points at which a generator will coincide with a tangent to the cubic; and this equation being of the fourth degree we see that the intersection of the scroll with the torse $4\alpha\gamma - \beta^2 = 0$, of which the cubic is the cuspidal edge, is made up of the cubic together with four common generators. There will be four points on the cubic, at which the two tangent planes to the scroll coincide,† these points being obtained by arranging the condition already obtained

$$\mu^2 (a\lambda^2 + 2h\lambda + b) + 2\mu \{h\lambda^2 + (b + g)\lambda + f\} + b\lambda^2 + 2f\lambda + c = 0,$$

and forming the discriminant

$$(a\lambda^2 + 2h\lambda + b) (b\lambda^2 + 2f\lambda + c) = \{h\lambda^2 + (b + g)\lambda + f\}^2.$$

We might have so chosen our planes of reference that one of these four points should correspond to $\lambda = 0$, the other extremity of the generator through that point being $\mu = \infty$, and in this case $f = 0$, $b = 0$; or the equation of the scroll may always be transformed to the form

$$a\alpha^2 + c\gamma^2 + 2g\gamma\alpha + 2h\alpha\beta = 0.$$

Or, again, by choosing the planes of reference so that two of

* These classes, my sixth and seventh, answer to Cayley's tenth and eighth.

† Points on a double line at which the two tangent planes coincide are called by Prof. Cayley *pinch points*.

the four points may be $\lambda = 0$, $\lambda = \infty$, the equation may be changed to the form $(a\alpha + b\beta + c\gamma)^2 = 4m^2\gamma\alpha$.

We have a subform of the scroll, if either a or $c = 0$ in this equation; for in this case two of the four cuspidal points on the nodal curve coincide, the generator at this point being also a generator of the torse, and there is a common tangent plane to scroll and torse along this line.

A third of the pinch points would unite if we had $b = m$; and if along with this condition we have both a and $c = 0$, the surface is the torse $\beta^2 - 4\gamma\alpha = 0$.

552. The next species of scrolls to be considered is when the nodal curve consists of a conic and right line (VIII and IX). The line necessarily meets the conic, which includes every point of the section of the scroll by its plane. This scroll may be generated by a line meeting two conics which have common the points in which each is met by the intersection of their planes, and also a line meeting one of the conics. It is easy to see that the most general equation of the scroll can be reduced to the form

$$(xz - y^2)^2 + myw(xz - y^2) + w^2(axy + by^2) = 0,$$

where $xz - y^2$, w is the nodal conic, xy the double line, and yz is one position of the generator. Take then any point on the conic, whose coordinates are $\lambda^2, \lambda, 1, 0$; and any point $z = \mu w$ on the line xy , and the line joining these points will lie altogether on the surface if

$$\lambda^2\mu^2 + m\lambda\mu + a\lambda + b = 0.$$

Thus two generators pass through any point of either nodal line or nodal conic. The reciprocal is got by eliminating between $\lambda^2x + \lambda y + z = 0$, $\mu z + w = 0$, and the preceding equation, and is

$$(bxz - w^2)^2 - y(bxz - w^2)(by + mw - az) + xz(by + mw - az)^2 = 0,$$

which for b not equal 0 is a scroll of the same kind having the nodal conic, $bxz - w^2$, $by + mw - az$, and the nodal line zw , this is VIII. If, however, $b = 0$, we have the case IX; the reciprocal quartic has here a triple line, and is of the third class

already considered.* There is one pinch point on the conic and two on the line. There is a subform when $m^2 = 4b$, that is to say, when the equation is of the form

$$(xz - y^2 + myw)^2 = aw^2xy,$$

in which case there is but one pinch-point, and that on the line.

553. The next case is where the conic degenerates into a pair of lines, in other words, where there are two non-intersecting double lines, and a third cutting the other two. This class is a particular case of that next to be considered, viz. where the scroll is generated by a line meeting two non-intersecting right lines. If in any case two positions of the generator can coincide we have a double generator, and the scroll is that now under consideration. Thus, for example, the scroll generated by a line meeting two lines not in the same plane and also a conic is (Art. 467) of the fourth order and has the two right lines as double lines; but two positions of the generator coincide with the line joining the points where the directing lines meet the plane of the conic, which is accordingly a third double line on the scroll. The general equation may be written as in last article.

$$x^2z^2 + mxzyw + w^2(axy + by^2) = 0;$$

the line $x = \lambda y$, $z = \mu w$ will be a generator if

$$\lambda^2\mu^2 + m\lambda\mu + a\lambda + b = 0,$$

and the reciprocal is

$$y^2w^2 + mxzyw + xz^2(bx - ay) = 0,$$

that is to say, is of the same nature as the original. This is Cayley's second species. As before, the form $(xz - yw)^2 = axyw^2$ may be regarded as special.

554. Next let us take the general case (Cayley's first species) where there are two non-intersecting double lines. This scroll may be generated by a line meeting a plane binodal quartic, and two lines, one through each node. When the quartic has

* These two species, my eighth and ninth, are Cayley's seventh and eleventh respectively.

a third node we have the species of last article. The most general equation is

$$x^2 (az^2 + 2hzw + bw^2) + 2xy (a'z^2 + 2h'zw + b'w^2) + y^2 (a''z^2 + 2h''zw + b''w^2) = 0,$$

the reciprocal of which is easily shown to be of like form. There are obviously four pinch-points on each line, and subforms may be enumerated according to the coincidence of two or more of these points.

But again, in the generation by the binodal quartic just mentioned two of the nodes may coalesce in a tacnode; and we have then a scroll with two coincident double lines (Cayley's fourth species), the general equation of which may be written

$$u_4 + (yw - xz) u_2 + (yw - xz)^2 = 0,$$

where u_4 , u_2 are a binary quartic and quadratic in x and y ; and the reciprocal is of like form. Once more this class of scrolls also admits of a double generator. This will be the case if any factor $y - \alpha x$ of u_2 enters twice into u_4 . In that case it is obvious that the line $y - \alpha x$, $\alpha w - z$ is a double line on the surface. This is Cayley's fifth species. Every quartic scroll may be classed under one of the species which we have enumerated.

555. The only quartics with nodal lines which have not been considered are those which have a nodal right line or a nodal conic. In either case the surface contains a finite number of right lines. For take an arbitrary point on the nodal line, and an arbitrary point on any plane section of the surface, and the line joining them will only meet the surface in one other point. We can, by Joachimsthal's method, obtain a simple equation determining the coordinates of that point in terms of the coordinates of the extreme points. In order that the line should lie altogether on the surface, both members of this equation must vanish; that is to say, two conditions must be fulfilled. And since we have two parameters at our disposal we can satisfy the two conditions in a finite number of ways.*

* The same argument proves that if a surface of the n^{th} order have a multiple line of the $(n - 2)^{\text{th}}$ order of multiplicity, the surface will contain right lines. If the

In the case where the quartic has a nodal right line xy , substituting $y - \lambda x$ in the equation, and proceeding, as in Art. 530, we find that eight planes can be drawn through the nodal line which meet the surface, each in two other right lines, and thus that there are sixteen right lines on the surface besides the nodal line.

556. We do not attempt to give a complete account of the different kinds of nodal lines on a quartic, the varieties being very numerous, but merely indicate some of the cases which would need to be considered in a complete enumeration.* The general equation of a quartic with a nodal right line may be written

$$u_4 + zu_3 + wv_3 + z^2t_2 + zwu_2 + w^2v_2 = 0,$$

where u_4, u_3 , &c. are functions in x and y of the order indicated by the suffixes. Now, attending merely to the varieties in the last three terms, and numbering the general case (1), we have the following additional cases; (2) the three quantities t_2, u_2, v_2 may have a common factor. In this case one of the tangent planes is the same along the double line, and one of the sixteen lines on the surface coincides with that line; (3) the last terms may be divisible by a factor not containing x or y , and so be reducible to the form $(az + bw)(zu_2 + wv_2)$; (4) there may be both a factor in x and y and also in z and w , the terms being reducible to the form $(ax + by)(a'z + b'w)(xz + yw)$; (5) we may have t_2, u_2, v_2 only differing by numerical factors, in which case there are two fixed tangent planes along the double line, and the case may be distinguished when the factor in z and w is a perfect square, that is to say, we have the two cases: (5a) the terms of the second degree reducible to the form $xyzw$, and (5b) reducible to the form xyz^2 ; (6) the three terms may break up

multiple line be a right line it is easily proved, as in Art. 530, that the number of other right lines is $2(3n - 4)$. If the multiple line be not plane, or if the surface possess in addition any other multiple line, the surface is generally a scroll. See a paper by R. Sturm, *Math. Annalen*, t. IV. (1871).

* On the subject of multiple right lines on a surface the reader may consult a memoir by Zeuthen, *Math. Annalen*, IV. (1871).

into the factors $(xz - yw)(zu_1 + wv_1)$; (7) the terms may form a perfect square $(xz + yw)^2$, in which case the line is cuspidal, the two tangent planes at each point coinciding but varying from point to point; (8) the cuspidal tangent plane may be the same for every point, the three terms being reducible to the form (8a), x^2zw , or (8b), x^2z^2 . This enumeration does not completely exhaust the varieties; and we have not taken into consideration the varieties resulting from taking into account the preceding terms, as for instance, if a factor $xz + yw$ divide not only the last three terms but also the terms $zu_3 + wv_3$. From the theory of reciprocal surfaces afterwards to be given it appears that a quartic with an ordinary double line is of the twentieth class, and that when the line is cuspidal the class reduces to the twelfth. It would need to be examined whether the class might not have intermediate values for special forms of the double line, and, again, what forms of the double line intervene between the cuspidal and the tacnodal for which we have seen that the surface is a scroll, the class being the fourth.

557. A quartic with a nodal line may have also double points. Two of the eight planes which meet the surface in right lines will coincide with the plane joining the nodal line to one of the nodal points. It is easy to write down the equation of a quartic with a nodal line and four nodal points. For let U, V, W represent three quadrics having a right line common and consequently four common points, then any quadratic function of U, V, W represents a quartic on which the line and points are nodal.

There are in the case just mentioned four planes, each passing through the nodal line and a nodal point, each such plane meeting the surface in the nodal line twice, and in two lines intersecting in the nodal point. There are at most four planes containing a nodal point, but any such plane may meet the surface in the nodal line twice, and in a two-fold line having upon it *two* nodal points; the surface may thus have as many as eight nodal points. The quartic with eight nodes and a nodal line is Plücker's *Complex Surface* (Art. 455), and its

equation is

$$\begin{vmatrix} x, y, 1 \\ x, a, h, g \\ y, h, b, f \\ 1, g, f, c \end{vmatrix} = 0,$$

where a, b, h are of form $(z, w)^2$; f, g of form $(z, w)^1$, and c is constant. There are through the nodal line four planes, the section by each of them being a two-fold line, and on each such two-fold line there are two nodes.

Suppose that the pairs of nodes are 1, 2; 3, 4; 5, 6; 7, 8; so that 12, 34, 56, 78 each meet the nodal line. For a node 1, the circumscribed sextic cone is $P^2 U_4 = 0$, where P is the plane through the double line—this should contain the lines 12, 13, 14, 15, 16, 17, 18 each twice; but P contains the line 12, and therefore P^2 contains it twice; hence, U_4 should contain the remaining six lines each twice, that is, it breaks up into four planes $ABCD$ which intersect in pairs in the six lines. Taking in like manner $P'^2 A'B'C'D' = 0$ for the sextic cone belonging to the node 2, the eight nodes lie by fours in the eight planes $A, B, C, D, A', B', C', D'$, and through each of the nodes there pass four of these planes; it is easy to construct geometrically such a system of eight points lying by fours in eight planes; the figure may be conceived of as a cube divested of part of its symmetry.

A special case would arise if one or more of the nodal points were to coincide with the nodal line. Thus the equation

$$\begin{aligned} ax^4 + bx^3y + cx^2y^2 + dxy^2(y - mw) + ey^2(y - mw)^2 + (Ax^3 + Bx^2y + Cxy^2)z \\ + Dy^2z(y - mw) + (A'x^3 + B'x^2y)w + C'xyw(y - mw) \\ + (\alpha x^2 + \beta xy + \gamma y^2)z^2 + (\alpha'x^2 + \beta'xy)zw + \alpha''x^2w^2 = 0, \end{aligned}$$

represents a quartic having the line xy as nodal and the point $x, z, y - mw$ as a nodal point; and if in the above we make $m = 0$, the point will lie on xy . The kind of nodal line here indicated appears to be different from any of those previously considered.

558. Let us take next the case where there are two intersecting nodal lines. The equation then is

$$x^2y^2 + 2mxyzw + w^2u_2 = 0,$$

where u_2 is a quadratic function of x, y, z, w . Proceeding as before we find immediately that four planes, besides the plane w , can be drawn through each of the nodal lines to meet the surface in right lines; and thus that there are sixteen lines on the surface, eight meeting each nodal line. It is easy also to see that each line of one system meets four lines of the other system. Besides the nodal lines, the surfaces may have four nodal points. The theory of this case is included in that which we have next to consider, namely, where the nodal line is a conic.

559. In this case any arbitrary plane meets the surface in a binodal quartic; if the plane be a tangent plane the quartic will be trinodal; if the plane be doubly a tangent plane the quartic will break up into two conics.* If the plane touch three times, the section must have an additional double point; that is to say, one of the conics must break up into two right lines; and since a surface has in general a definite number of triple tangent planes we see, as we have already inferred from other considerations, that the surface contains a definite number of right lines. This number is sixteen, as may be shown by the method indicated, Art. 555, but we do not delay on the details of the proof, as we shall have occasion afterwards to show how the theorem was originally inferred by Clebsch. Each of the sixteen lines is met by five others, the relation between the lines being connected by Geiser and Darboux, with the 27 lines of a cubic surface, as follows, if on a cubic surface we disregard any one line and the ten lines which meet it, then the sixteen remaining lines are, in regard to their mutual intersections related to each other as the sixteen lines on the quartic.

In fact this is easily shown by the method of inversion in the case where the nodal conic is the circle at infinity, a case to which the general form can always be reduced by homographic transformation. The inverse of such a quartic, the centre of

* It was from this point of view these surfaces were studied by Kummer, viz. as quartics on which lie an infinity of conics.

inversion being any point on the surface, is a cubic also passing through the circle at infinity. Of the twenty-seven right lines on this cubic, one lies in the plane at infinity, ten meet that line, and the remaining sixteen meet the circle at infinity; and these last, and these only, are inverted into right lines on the quartic.

The lines may be grouped in "double fours," such that in a double four each line of the one four meets three lines of the other four; but no two lines of the same four meet each other. There are in all twenty double fours, each line therefore entering into ten of them.

560. In what follows, we suppose the surface to be a cyclide, as the term is used by Casey and Darboux, that is to say, having the circle at infinity as the nodal conic: and in order to generalize the results, it is only necessary in the equations of the nodal line, $w = 0$, $x^2 + y^2 + z^2 = 0$, to suppose x, y, z, w to be any four planes; while in the special case w is at infinity, and x, y, z are ordinary rectangular coordinates. The properties of the cyclide may be studied in exactly the same manner as the properties of bicircular quartics were treated, *Higher Plane Curves*, Arts. 251, 272, &c. Consider any quartic whose equation may be written $(X, Y, Z, W)^2 = 0$, where X, Y, Z, W represent quadrics, and we equate to zero a complete quadratic function of these quantities. By a linear transformation of these quantities we may reduce this equation as the general equation of the second degree was reduced, and so bring it to either of the forms $aX^2 + bY^2 + cZ^2 + dW^2 = 0$, or $XY = ZW^*$, only in the latter case the separate factors are not necessarily real. From the latter form it is apparent that there are on such a quartic at least two singly infinite series of quadriquadric curves, and that through two curves belonging one to each system can be drawn a quadric

* It has been shown by Dr. Valentiner, *Zeuthen Tidsskrift* (4), III., that the form of the equation of a quartic here considered is not of the greatest generality, and in fact that any surface of the n^{th} degree which contains the complete curve of intersection of two surfaces must be a special surface when n exceeds 3. The equation of a quartic which contains a quadriquadric curve depends on only 33 independent constants.

$\lambda\mu X - \lambda Z - \mu W + Y = 0$, touching the surface in the eight points where these curves intersect. And, generally, the quadric $\alpha X + \beta Y + \gamma Z + \delta W$ will touch the quartic, provided $\alpha, \beta, \gamma, \delta$ satisfy the familiar relation of Art. 79. All quadrics included in this form have a common Jacobian on which will lie all possible vertices of cones involved in the system. Thus, through each of the quadric quadric curves just spoken of, can be drawn four cones whose vertices lie on the Jacobian.

A special case is when the equation of the quartic can be expressed in terms of three quadrics only $(X, Y, Z)^2 = 0$. This cannot happen unless the quartic have double points, since all points common to the three quadrics X, Y, Z are double points on the quartic. In this case the equation can be brought by linear transformation to either of the forms $aX^2 + bY^2 + cZ^2 = 0$, or $XZ = Y^2$. Such a quartic is evidently the locus of the system of curves $Y = \lambda X, Z = \lambda Y$, and the quadric $\lambda^2 X - 2\lambda Y + Z$ touches the quartic along the whole length of this curve. The generators of any quadric of this system are bitangents to the quartic.

561. To apply this to the cyclide, it is easy to see that if X, Y, Z, W be four spheres, the equation $(X, Y, Z, W)^2 = 0$ is general enough to represent any cyclide. Since the Jacobian of four spheres is the sphere which cuts them at right angles, all spheres of the system $\alpha X + \beta Y + \gamma Z + \delta W$ cut a fixed sphere orthogonally. Further, the coordinates of the centre of any such sphere are easily seen to be proportional to linear functions of $\alpha, \beta, \gamma, \delta$; and, reciprocally, these quantities are proportional to linear functions of these coordinates. Thus the condition of contact (Art. 79) being of the second degree in $\alpha, \beta, \gamma, \delta$, establishes a relation of the second degree in these coordinates. Hence we have a mode of generation for cyclides corresponding to that given for bicircular quartics (*Higher Plane Curves*, Art. 273), viz. a cyclide is the envelope of a sphere whose centre moves on a fixed quadric F , and which cuts a fixed sphere J orthogonally. From this mode of generation several consequences immediately follow. First, the cyclide is its own inverse with regard to the sphere J ; for any sphere

which cuts J orthogonally is its own inverse in respect to it, so that the generating sphere not being changed by inversion, neither is the envelope. Thus, the cyclide is an anallagmatic surface, see note, p. 481. Secondly, the intersection of F and J is a focal curve of the cyclide; for the Jacobian J is the locus of all point-spheres belonging to the system $\alpha X + \beta Y + \gamma Z + \delta W$; and therefore, from the mode of generation, every point of the curve FJ is a point-sphere having double contact with the quartic; that is to say, is a focus. Thirdly, in the case where the centre of the enveloped sphere is at infinity on F , the sphere reduces to a plane through the centre of J (or more strictly to that plane, together with the plane infinity). It follows then, that if a cone be drawn through the centre of J whose tangent planes are perpendicular to the edges of the asymptote cone of F , these tangent planes are double tangent planes to the quartic, which they meet therefore each in two circles, while the edges of this cone are bitangent lines to the quartic.

562. We have thus far considered the equation of the cyclide expressed in terms of four quadrics; but it is even more obvious, that the equation can be expressed in terms of three quadrics. In fact, the equation of a quartic having for nodal line the intersection of the quadric U by the plane P , may obviously be written $U^2 = P^2V$. Or, again, if we write down the following most general equation of a quartic, having as a nodal line the intersection of $x^2 + y^2 + z^2$, and w ,

$$(x^2 + y^2 + z^2)^2 + 2wu_1(x^2 + y^2 + z^2) + w^2u_2 = 0;$$

this can obviously at once be written in the above form as,

$$(x^2 + y^2 + z^2 + wu_1)^2 = w^2v_2.$$

We can simplify this equation by transformation to parallel axes through a new origin, so as to make the u_1 disappear, and we may suppose the axes of coordinates to be parallel to the axes of the quadric v_2 , so that v_2 does not contain the terms yz, zx, xy . It appears then from what has been said, that the cyclide, the general equation being reduced to the form

$$(x^2 + y^2 + z^2)^2 = ax^2 + by^2 + cz^2 + 2lx + 2my + 2nz + d = V,$$

is the envelope of the quadric $V + 2\lambda(x^2 + y^2 + z^2) + \lambda^2 = 0$, every quadric of this system touching the quartic at every point where it meets it. The discriminant of this quadric equated to zero gives

$$\frac{l^2}{a + 2\lambda} + \frac{m^2}{b + 2\lambda} + \frac{n^2}{c + 2\lambda} = d + \lambda^2,$$

and this equation being a quintic in λ , we see that there are five values of λ for which this quadric reduces to a cone, and therefore five cones whose edges are bitangents to the quartic. Taking this in connection with what was stated at the end of the last article, it may be inferred that there are five spheres J , each of which combined with a corresponding quadric F gives a mode of generating the cyclide. And this may be shown directly by investigating the condition that the sphere $x^2 + y^2 + z^2 - u_1$ should have double contact with the cyclide, or meet it in two circles. For, substituting in the equation of the cyclide we get $u_1^2 = V$, and if we add this to $\lambda(x^2 + y^2 + z^2 - u_1)$ and determine λ by the condition that the sum shall represent two planes, we get the same quintic as before for λ ; and we find also that the centre of the sphere must satisfy the equation

$$\frac{\alpha^2}{\lambda - a} + \frac{\beta^2}{\lambda - b} + \frac{\gamma^2}{\lambda - c} = 1,$$

from which we see that there are five series of double tangent spheres; that the locus of the centre of the spheres of each series is a quadric, and that the five quadrics are confocal.

It appears from what has been said that through any point can be drawn ten planes cutting the cyclide in circles, namely, the pairs of tangent planes which can be drawn through the point to the five cones.

563. The five-fold generation may be shown in another way. If we suppose the quadric locus of centres F to be identical with the sphere J which is cut orthogonally, we evidently get for the cyclide J itself counted twice. Again, if we have two cyclides both expressed in the form $(X, Y, Z, W)^2 = 0$, it appears from the theory of quadrics that by substituting for X, Y, Z, W linear functions of these quantities both can be expressed in the form $aX^2 + bY^2 + cZ^2 + dW^2$. Thus then it

is possible to express the equation of any cyclide in the form $a'X^2 + b'Y^2 + c'Z^2 + d'W^2$, while at the same time we have an identical equation $J^2 = aX^2 + bY^2 + cZ^2 + dW^2$. For the actual transformation we refer to Casey, p. 599, Darboux, p. 135, but we can show in another way what this identical equation is. Multiply by the ordinary rule the two determinants

$$\begin{vmatrix} \rho^2, & -x, & -y, & -z, & 1 \\ d, & -l, & -m, & -n, & 1 \\ d', & -l', & -m', & -n', & 1 \\ d'', & -l'', & -m'', & -n'', & 1 \\ d''', & -l''', & -m''', & -n''', & 1 \end{vmatrix} \begin{vmatrix} 1, & 2x, & 2y, & 2z, & \rho^2 \\ 1, & 2l, & 2m, & 2n, & d \\ 1, & 2l', & 2m', & 2n', & d' \\ 1, & 2l'', & 2m'', & 2n'', & d'' \\ 1, & 2l''', & 2m''', & 2n''', & d''' \end{vmatrix},$$

(where we have written for brevity ρ^2 instead of $x^2 + y^2 + z^2$, and where either determinant equated to zero gives the equation of the sphere cutting orthogonally four spheres), and the product is

$$\begin{vmatrix} 0, & X, & Y, & Z, & W \\ X, & -2r^2, & (12), & (13), & (14) \\ Y, & (12), & -2r'^2, & (23), & (24) \\ Z, & (13), & (23), & -2r''^2, & (34) \\ W, & (14), & (24), & (34), & -2r'''^2 \end{vmatrix},$$

where (12) is $d + d' - 2ll' - 2mm' - 2nn'$, and vanishes if the two spheres cut each other orthogonally. On the supposition then that each pair of the four given spheres cut orthogonally, the square of the equation of the sphere cutting them at right angles is proportional to

$$\begin{vmatrix} 0, & X, & Y, & Z, & W \\ X, & -2r^2, & 0, & 0, & 0 \\ Y, & 0, & -2r'^2, & 0, & 0 \\ Z, & 0, & 0, & -2r''^2, & 0 \\ W, & 0, & 0, & 0, & -2r'''^2 \end{vmatrix},$$

whence it immediately follows that if five spheres cut each other orthogonally, the identical relation subsists

$$\frac{X^2}{r^2} + \frac{Y^2}{r'^2} + \frac{Z^2}{r''^2} + \frac{V^2}{r'''^2} + \frac{W^2}{r''^2} = 0,$$

It may be noted in passing, that in virtue of this identity, the equation $W=0$ may be written in the form

$$\left(\frac{X-W}{r}\right)^2 + \left(\frac{Y-W}{r'}\right)^2 + \left(\frac{Z-W}{r''}\right)^2 + \left(\frac{V-W}{r'''}\right)^2 = 0,$$

showing that the sphere W meets the four others in four planes, which form a self-conjugate tetrahedron with respect to W . To return to the cyclide, it having been proved that its equation may be written in the form

$$aX^2 + bY^2 + cZ^2 + lV^2 = 0,$$

and that it may be generated as the envelope of a sphere cutting W orthogonally, we may, by the help of the identity just given, eliminate any other of the quantities $X, Y, \&c.$, and write for example the equation in the form $a'Y^2 + b'Z^2 + c'V^2 + d'W^2 = 0$, and generate the cyclide as the envelope of a sphere cutting X orthogonally.

564. The condition that two surfaces whose equations are expressed in terms of the five spheres X, Y, Z, V, W should cut each other orthogonally, admits of being simply expressed. It is in the first instance

$$\begin{aligned} \left(\frac{d\phi}{dX} \frac{dX}{dx} + \&c.\right) \left(\frac{d\psi}{dX} \frac{dX}{dx} + \&c.\right) \\ + \left(\frac{d\phi}{dX} \frac{dX}{dy} + \&c.\right) \left(\frac{d\psi}{dX} \frac{dX}{dy} + \&c.\right) + \&c. = 0. \end{aligned}$$

This equation is reduced by the two following identities, which are easily verified,

$$\begin{aligned} \left(\frac{dX}{dx}\right)^2 + \left(\frac{dX}{dy}\right)^2 + \left(\frac{dX}{dz}\right)^2 &= 4X + 4r^2, \\ \frac{dX}{dx} \frac{dY}{dx} + \frac{dX}{dy} \frac{dY}{dy} + \frac{dX}{dz} \frac{dY}{dz} &= 2(X + Y). \end{aligned}$$

The condition may then be written

$$\begin{aligned} 2 \left(X \frac{d\phi}{dX} + Y \frac{d\phi}{dY} + \&c.\right) \left(\frac{d\psi}{dX} + \&c.\right) \\ + 2 \left(X \frac{d\psi}{dX} + \&c.\right) \left(\frac{d\phi}{dX} + \&c.\right) + 4 \left(r^2 \frac{d\phi}{dX} \frac{d\psi}{dX} + \&c.\right) &= 0. \end{aligned}$$

The first two groups of terms vanish, because ϕ and ψ , which are satisfied by the coordinates of the point in question, are homogeneous functions of X , Y , &c. The condition therefore is

$$r^2 \frac{d\phi}{dX} \frac{d\psi}{dX} + r'^2 \frac{d\phi}{dY} \frac{d\psi}{dY} + \&c. = 0.$$

We may simplify the equations by writing X instead of $X:r$, &c., so that the identity connecting the five spheres becomes

$$X^2 + Y^2 + Z^2 + V^2 + W^2 = 0,$$

and the condition for orthogonal section

$$\frac{d\phi}{dX} \frac{d\psi}{dX} + \frac{d\phi}{dY} \frac{d\psi}{dY} + \&c. = 0,$$

a condition exactly similar in form to that for ordinary coordinates.

565. We can now immediately, after the analogy of quadrics, form the equation of an orthogonal system of cyclides. For write down the equation

$$\frac{X^2}{\lambda - a} + \frac{Y^2}{\lambda - b} + \frac{Z^2}{\lambda - c} + \frac{V^2}{\lambda - d} + \frac{W^2}{\lambda - e} = 0,$$

in which λ is a variable parameter; and, in the first place, it is easy to see that three cyclides of the system can be drawn through any assumed point: for the equation in λ , though in form of the fourth degree, is in reality only of the third, the coefficient of λ^4 vanishing in virtue of the identical equation. And from the condition just obtained, it follows at once, in the same manner as for confocal quadrics, that any two surfaces of the system cut each other at right angles.* These cyclides are confocal, there being a common focal curve on each of the five spheres. It is evident from what has been proved, that confocal cyclides cut each other in their lines of curvature.

566. The mode of generating cyclides as the envelope of a sphere admits of being stated in another useful form. All

* Casey and Darboux seem to have independently made this beautiful extension to three dimensions of Dr. Hart's theorem for the corresponding plane curves, *Higher Plane Curves*, Art. 278.

spheres whose centres lie in a fixed plane, and which meet a given sphere orthogonally, pass through two fixed points, there being two linear relations connecting the coefficients. And it is easy to see what the fixed points are, for since the spheres cut at right angles every sphere through the intersection of the fixed sphere and the plane, they contain the two point-spheres of that system, or the limit points (*Conics*, Art. 111) of the plane and the fixed sphere, these points being real only when the sphere and plane do not intersect in a real curve. In the case, then, where the centre of the moveable sphere lies in a fixed surface, it follows, obviously, that the envelope may be described as the locus of the limit points of each tangent plane to the fixed surface and of the fixed sphere. We are thus led to a mode of transformation in which to a tangent plane of one surface answer two points on another; or, if we take the reciprocal of the first surface, it is a (1, 2) transformation, in which to one point on one surface answer two on the other. Dr. Casey has easily proved, p. 598, that the results of substituting the coordinates of one of these limit points in the equations of the spheres of reference are proportional to the perpendiculars let fall from the centres of these spheres on the tangent plane. Thus, if the surface locus of centres be given by a tangential equation between the perpendiculars from the four centres $\phi(\lambda, \mu, \nu, \rho) = 0$, the derived surface is $\phi(X, Y, Z, W) = 0$; and if the first be the equation of a quadric, the second will be the corresponding cyclide.

567. From the construction which has been given an analysis has been made by Casey and Darboux of the different forms of cyclides according to the different species of the quadric locus of centres, and the nature of its intersection with the fixed sphere. We only mention the principal cases, remarking in the first place that the spheres whose centres lie along any generator of the quadric all pass through the same circle, namely, that which has for its anti-points the intersections of the line and the sphere. The circle in question is part of the envelope, which may, therefore, be regarded as the locus of the circles answering to the several right lines of the quadric, there being,

of course, two series of circles answering to the two series of right lines.

Now if the quadric be a cone, these circles all lie on the same sphere, that which has its centre at the vertex of the cone and which cuts the given sphere orthogonally, and the cyclide may be regarded as degenerating into the spherical curve which is the envelope of those circles, that curve being the intersection of the sphere by a quadric, which curve has been called a sphero-quartic. Strictly speaking, the cyclide locus of these circles is an annular surface flattened so as to coincide with the spherical area, which is bounded by the sphero-quartic curve. The properties of these sphero-quartics have been investigated in detail by Casey and Darboux. These curves may be inverted into plane bicircular quartics, and therefore (see note, p. 481) have four foci, the distances from which to any point of the curve are connected by linear relations.

If the quadric be a paraboloid the cyclide degenerates into a cubic surface passing through the circle at infinity. If the quadric be a sphere the cyclide is the surface of revolution generated by a Cartesian oval round its axis: but Darboux has given the name Cartesian to the more general cyclide generated when the quadric is a surface of revolution.

The cyclide may have one, two, three, or four double points. The nodal cyclides present themselves as the inverse of quadrics, the inverse of the general quadric being a cyclide with one node, that of the general cone one with two, of the general surface of revolution one with three, of the cone of revolution one with four. The last mentioned, or tetranodal cyclide, is the surface to which the name cyclide was originally given by Dupin, and may therefore be called Dupin's Cyclide. According to its original conception this was the envelope of the spheres, each touching three given spheres; or, more accurately, we have thus, four cyclides, for the tangent-spheres in question form four distinct series, those of each series enveloping a cyclide. The spheres of each series are distinguished as having their centres in a given plane; and we have thus a more precise definition, that the cyclide is the envelope of a series of spheres each having its centre in a given plane and touching two given

spheres. But all such spheres have their centres on a conic; and we thus arrive at a better definition; viz. the cyclide is the envelope of a series of spheres each having its centre on a given conic and touching a given sphere.

In the last definition the given sphere is not unique but it forms one of a singly infinite series; in fact, we may, without altering the cyclide, replace the original sphere by any sphere of the series; the new series of spheres have their centres on a conic. It is to be added that instead of the series of spheres having their centres on the first conic, we may obtain the same cyclide as the envelope of a series of spheres having their centres on the second conic, and touching a sphere having its centre at any point of the first conic.

The two conics have their planes at right angles, and are such, that two opposite vertices of each conic are foci of the other conic; these conics are focal conics of a system of confocal quadric surfaces, one of them is an ellipse and the other a hyperbola.

The relation of the ellipse and hyperbola is such, that taking—

(1) Two fixed points on the ellipse, the difference of the distances of these from a variable point on the hyperbola is constant, $= +c$ if the variable point is on one branch, $-c$ if it is on the other branch of the hyperbola (the value of c of course depending on the position of the two fixed points).

(2) Two fixed points on the hyperbola, if on different branches, the sum, but if on the same branch, the difference of their distances from a variable point on the ellipse is constant, the value of this constant, of course, depending on the position of two fixed points.

And using these properties, we see at once how the same surface can be obtained as the envelope of a series of spheres having their centre on either conic, and touching a sphere having its centre at any point of the other conic.

Dupin's Cyclide is also the envelope of a series of spheres having their centres on a conic, and cutting at right angles a given sphere; for instead of the quadric surface in the construction for the general cyclide, we have here a conic.

568. Passing now to quartic surfaces without singular lines, they may have any number of nodes (ordinary conical points) up to 16; each such node diminishes the class by 2, so that for the surface with 16 nodes the class is $36 - 2 \cdot 16, = 4$. Some of the nodes may be replaced by, or may coalesce into, binodes or unodes, but the theory has not been investigated.

The general cone of contact to a quartic is, by Art. 279, of the twelfth degree, having twenty-four cuspidal and twelve nodal lines, and sixteen is the greatest number of additional nodal lines it can possess without breaking up into cones of lower dimensions. When the surface has sixteen nodes, the cone of contact from each node is of the sixth degree, and has the lines to the other fifteen as nodal lines; from which it follows that this cone breaks up into six planes.

569. It is to be observed that the equation of a quartic surface contains thirty-four constants, that is, the surface may be made to satisfy thirty-four conditions; and that if a given point is to be a node of the surface, this is $=4$ conditions. It would, therefore, at first sight appear that we could with eight given points as nodes determine a quartic surface containing two constants; but this is not so. We have through the eight points two quadric surfaces $U=0, V=0$ (every other quadric surface through the eight points being in general of the form $U + \lambda V = 0$) and the form with two constants is in fact $U^2 + \alpha UV + \beta V^2 = 0$, which breaks up into two quadric surfaces, each passing through the eight points. It thus appears that we can find a quartic surface with at most seven given points as nodes.

570. The cases of a surface with 1, 2, or 3 nodes may be at once disposed of; taking for instance the first node to be the point $(1, 0, 0, 0)$, the second the point $(0, 1, 0, 0)$, and the third the point $(0, 0, 1, 0)$, we can at once write down an equation $U=0$, with 30, 26, or 22 constants, having the given node or nodes. We might in the same manner take the fourth node to be $(0, 0, 0, 1)$ and write down the equation with 18 constants; but, in the case of four nodes and in reference to those which follow, it becomes interesting to consider how the

equation can be built up with quadric functions representing surfaces which pass through the given nodes. In the case of 4 given nodes we have six such surfaces $P=0$, $Q=0$, $R=0$, $S=0$, $T=0$, $U=0$, every other quadric surface through the four points being obtained by a linear combination of these; and we have thence the quartic equation $(P, Q, R, S, T, U)^2=0$, containing apparently twenty constants. The explanation is that the six functions, although linearly independent, are connected by two quadric equations, and the number of constants is thereby reduced to $20 - 2, = 18$, which is right.

In the case of 5 given nodes we have through these the five quadric surfaces $P=0$, $Q=0$, $R=0$, $S=0$, $T=0$, and we have the quartic surface $(P, Q, R, S, T)^2=0$, containing, as it should do, 14 constants.

571. In the case of 6 given nodes, we have through these the four quadric surfaces $P=0$, $Q=0$, $R=0$, $S=0$, and the quartic surface $(P, Q, R, S)^2=0$ contains only 9 constants; there is in fact through the six points a quartic surface, the Jacobian of the four functions, $J(P, Q, R, S)=0$, not included in the foregoing form, and the general quartic surface with the six given nodes is

$$(P, Q, R, S)^2 + \theta J(P, Q, R, S) = 0,$$

containing, as it should do, 10 constants.

The foregoing surface $J(P, Q, R, S)=0$, where $P=0$, $Q=0$, $R=0$, $S=0$ are any quadric surfaces through the six given points, or are any quadric surfaces having six common points, is a very remarkable one; it is in fact the locus of the vertices of the quadric cones which pass through the six points. It hereby at once appears that the surface has upon it $15 + 10, = 25$ right lines, namely, the 15 lines joining each pair of the six points, and the 10 lines each the intersection of the plane through three of the points with the plane through the remaining three points.

In the case of 7 given nodes we have through these three quadric surfaces $P=0$, $Q=0$, $R=0$; but forming herewith the equation $(P, Q, R)^2=0$, this contains only five constants; that it is not the general surface with the seven given nodes appears

also by the consideration that it has, in fact, an eighth node, for each of the intersections of the three quadric surfaces is a node on the surface. We can without difficulty find a quartic surface not included in the form, but having the seven given nodes: for instance, this may be taken to be $\nabla = 0$, where ∇ is made up of a cubic surface having four of the points as nodes and passing through the remaining three points, and of the plane through these three points. And the general equation then is

$$(P, Q, R)^2 + \theta\nabla = 0,$$

containing, as it should do, 6 constants.

572. Passing to the surfaces with 8 nodes, only seven of these can be given points; the eighth may be the remaining common intersection of the quadric surfaces through the seven points, and we thus have a form of surface

$$(P, Q, R)^2 = 0,$$

with eight nodes, the common intersection of three quadric surfaces; this is the octadic eight-nodal quartic surface.

Among the surfaces of the form in question are included the reciprocals of several interesting surfaces, for example, order six, parabolic ring; order eight, elliptic ring; order ten, parallel surface of paraboloid, and first central negative pedal of ellipsoid; order twelve, centro-surface of ellipsoid and parallel surface of ellipsoid—the surfaces include also the general torus or surface generated by the revolution of a conic round a fixed axis anywhere situated.

There is, however, another kind of 8-nodal surface for which the eighth node is any point whatever on a certain surface determined by means of the seven given points; and this is called the octo-dianome.

The last-mentioned surface may be made to have another node, which is any point whatever on a certain curve determined by means of the eight nodes; we have thus the ennea-dianome; and finally this may be made to have a new node, one of a certain system of twenty-two points determined by means of the nine nodes; this is the deca-dianome. But starting with

seven *given* points as nodes, the number of nodes of the quartic surface is at most = 10.

A kind of 10-nodal surface is the symmetroid, which is represented by means of a symmetrical determinant

$$\begin{vmatrix} a, & h, & g, & l \\ h, & b, & f, & m \\ g, & f, & c, & n \\ l, & m, & n, & d \end{vmatrix} = 0,$$

where the several letters represent linear functions of the coordinates; such a surface has ten nodes, for each of which the circumscribed sextic cone breaks up into two cubic cones; and thus the ten nodes form a system of points in space, such that joining any one of them with the remaining nine, the nine lines are the intersections of two cubic cones; these are called an ennead, and the ten points are said to form an enneadic system.

Some of the kinds of surfaces with 11, 12, and 13 nodes, and the surfaces with 14, 15, and 16 nodes were considered by Kummer. Reverting to the consideration of the circumscribed cone having its vertex at a node, observe that for a surface with 16 nodes, this is a sextic cone with fifteen nodal lines, or it must break up into six planes, say the sextic cone is (1, 1, 1, 1, 1, 1); and the form being unique, this must be the case for the cone belonging to each node of the surface, say the surface is the sixteen-nodal 16 (1, 1, 1, 1, 1, 1).

Similarly, in the case of 15 nodes, the sextic cone has fourteen nodal lines, or it breaks up into a quadricone and four planes, say it is (2, 1, 1, 1, 1); which form being also unique, the surface is the 15-nodal 15 (2, 1, 1, 1, 1).

In the case of 14 nodes, the cone has thirteen nodal lines, it must be either a nodal cubic cone and three planes, or else two quadricones and two planes; that is (3, 1, 1, 1) or (2, 2, 1, 1). It is found that there is only one kind of surface, having eight nodes of the first sort and six nodes of the second sort; say this is the fourteen-nodal 8 (3, 1, 1, 1) + 6 (2, 2, 1, 1).

In the case of 13 nodes, the cones are (4₃, 1, 1), (3₁, 2, 1), (3, 1, 1, 1), or (2, 2, 2), viz. (4₃, 1, 1) is a three-nodal quartic

cone and two planes, and so (3, 2, 1) is a nodal cubicone, a quadricone, and a plane. It is found that there are two forms of surface, the 13-(α)-nodal

$$3(4_3, 1, 1) + 1(3, 1, 1, 1) + 9(3, 2, 1),$$

and the 13-(β)-nodal 13(2, 2, 2).

The like principles apply to the cases of twelve, eleven, &c. nodes, but the number of kinds has not been completely ascertained.

573. We only consider the 16-nodal quartic, the equation of which in general can be exhibited. Write for shortness

$$P = \frac{x}{\alpha} + \frac{y}{\beta} + \frac{z}{\gamma}, \quad P' = \frac{x}{\alpha'} + \frac{y}{\beta'} + \frac{z}{\gamma'}, \quad P'' = \frac{x}{\alpha''} + \frac{y}{\beta''} + \frac{z}{\gamma''},$$

where $\alpha + \beta + \gamma = 0, \alpha' + \beta' + \gamma' = 0, \alpha'' + \beta'' + \gamma'' = 0,$

$$X = \alpha(\gamma'\gamma''y - \beta'\beta''z), \quad Y = \beta(\alpha'\alpha''z - \gamma'\gamma''x), \quad Z = \gamma(\beta'\beta''x - \alpha'\alpha''y),$$

$$X' = \alpha'(\gamma''\gamma y - \beta''\beta z), \quad Y' = \beta'(\alpha''\alpha z - \gamma''\gamma x), \quad Z' = \gamma'(\beta''\beta x - \alpha''\alpha y),$$

$$X'' = \alpha''(\gamma\gamma'y - \beta\beta'z), \quad Y'' = \beta''(\alpha\alpha'z - \gamma\gamma'x), \quad Z'' = \gamma''(\beta\beta'x - \alpha\alpha'y),$$

$$A = x^2 + y^2 + z^2 - 2yz - 2zx - 2xy,$$

$$B = \alpha\alpha'\alpha''(y^2z - z^2y) + \beta\beta'\beta''(z^2x - zx^2) + \gamma\gamma'\gamma''(x^2y - xy^2) + Mxyz,$$

$$C = \alpha\alpha'\alpha''yz + \beta\beta'\beta''zx + \gamma\gamma'\gamma''xy$$

where $M = (\beta - \gamma)\alpha'\alpha'' + (\gamma - \alpha)\beta'\beta'' + (\alpha - \beta)\gamma'\gamma''$
 $= (\beta' - \gamma')\alpha''\alpha + (\gamma' - \alpha')\beta''\beta + (\alpha' - \beta')\gamma''\gamma$
 $= (\beta'' - \gamma'')\alpha\alpha' + (\gamma'' - \alpha'')\beta\beta' + (\alpha'' - \beta'')\gamma\gamma'$
 $= -\frac{1}{3}\{(\beta - \gamma)(\beta' - \gamma')(\beta'' - \gamma'') + (\gamma - \alpha)(\gamma' - \alpha')(\gamma'' - \alpha'')$
 $\quad + (\alpha - \beta)(\alpha' - \beta')(\alpha'' - \beta'')\},$

values which give identically

$$AC - B^2 = 4\alpha\alpha'\alpha''\beta\beta'\beta''\gamma\gamma'\gamma''xyzPP'P'';$$

then the equation of the surface may be written in the irrational form

$$\sqrt{\{x(X - w)\}} + \sqrt{\{y(Y - w)\}} + \sqrt{\{z(Z - w)\}} = 0,$$

which rationalized is $Aw^2 + 2Bw + C,$

and is one of four hundred and eighty like forms.

For each node the sextic cone is made up of six planes, but we thus obtain in all only sixteen planes; for each of these planes is a singular plane touching the surface along a conic, on which conic are contained six nodes of the surface. The coordinates of the sixteen nodes and the equations of the sixteen planes can easily be obtained. For instance, the planes are $X, Y, Z, W, P, P', P'', X-w, X'-w, X''-w, Y-w$, &c.

574. The 16-nodal quartic includes as a particular case Prof. Cayley's tetrahedroid, obtained by him as a mere homographic transformation of the wave surface. In this case the sixteen planes pass in fours through the summits of a tetrahedron. To obtain its equation independently of the general case, write down the general equation of a quartic met by each of the four coordinate planes in two conics having for common conjugate points the vertices of the tetrahedron of reference which lie in that plane. The equation so formed contains in general a term $xyzw$ and represents a surface without nodes: but if we add the further condition that this term shall vanish, the surface at once acquires sixteen nodes, each of the intersections of the two conics in each of the four planes becoming a node. The equation may be written

$$\begin{vmatrix} 0, & x^2, & y^2, & z^2, & w^2 \\ x^2, & 0, & h, & g, & l \\ y^2, & h, & 0, & f, & m \\ z^2, & g, & f, & 0, & n \\ w^2, & l, & m, & n, & 0 \end{vmatrix} = 0,*$$

or, what is the same thing,

$$(A, B, C, D, E, F, G, H, L, M, N)(x^2, y^2, z^2, w^2),$$

where the coefficients are those of the reciprocal of a quadric wanting the terms x^2, y^2, z^2, w^2 . The equation expanded is (see Art. 208)

$$mnfx^4 + nlgy^4 + lmhz^4 + fghw^4$$

$$+ \lambda (ly^2z^2 + fx^2w^2) + \mu (mz^2x^2 + gy^2w^2) + \nu (nx^2y^2 + hz^2w^2) = 0,$$

$$\text{where } \lambda = lf - mg - nh, \quad \mu = -lf + mg - nh, \quad \nu = -lf - mg + nh.$$

* The deduction of this form from that of the general 16-nodal is a process of some difficulty; and it is to be noted that the x, y , &c. here used are not the same coordinates as those used in that equation.

And the nodes may be exhibited by writing the equation in the following or one of the three corresponding forms

$$(2mnfx^2 + nvy^2 + m\mu z^2 + f\lambda w^2)^2 \\ = \nabla (1, 1, 1, -1, -1, -1 \chi y^2 n, z^2 m, w^2 f)^2;$$

where $\nabla = l^2 f^2 + m^2 g^2 + n^2 h^2 - 2mng h - 2nlh f - 2lmfg.$

These last equations serve to show that the sections by a plane of the tetrahedron are two conics as above mentioned; thus writing in the first of them $w = 0$ it becomes

$$(2mnfx^2 + nvy^2 + m\mu z^2)^2 = \Delta \{y^2 n - z^2 m\}^2,$$

a pair of conics.

To deduce the ordinary form of the equation of the wave-surface write

$$l = \alpha\beta\gamma (b\gamma - c\beta), \quad m = \alpha\beta\gamma (c\alpha - a\gamma), \quad n = \alpha\beta\gamma (a\beta - b\alpha),$$

$$f = k\alpha\alpha (b\gamma - c\beta), \quad g = kb\beta (c\alpha - a\gamma), \quad h = kc\gamma (a\beta - b\alpha),$$

equations which serve to determine the ratios $a : b : c : \alpha : \beta : \gamma : k$ in terms of $l, m, n, f, g, h.$ The equation of the surface then becomes

$$\alpha\beta\gamma (ax^2 + by^2 + cz^2) (ax^2 + \beta y^2 + \gamma z^2) + k^2 abc w^4 \\ - k\alpha\alpha (b\gamma + c\beta) x^2 w^2 - kb\beta (c\alpha + a\gamma) y^2 w^2 - kc\gamma (a\beta + b\alpha) z^2 w^2 = 0,$$

which putting in X, Y, Z for $\frac{x}{w} \sqrt{\left(\frac{\alpha}{k}\right)}, \frac{y}{w} \sqrt{\left(\frac{\beta}{k}\right)}, \frac{z}{w} \sqrt{\left(\frac{\gamma}{k}\right)}$

respectively, and $\alpha a^2, \beta b^2, \gamma c^2$ for $a, b, c,$ becomes

$$(X^2 + Y^2 + Z^2) (a^2 X^2 + b^2 Y^2 + c^2 Z^2) + a^2 b^2 c^2 \\ - (b^2 + c^2) a^2 X^2 - (c^2 + a^2) b^2 Y^2 - (a^2 + b^2) c^2 Z^2 = 0,$$

the equation of the wave-surface.

CHAPTER XVII.

GENERAL THEORY OF SURFACES.

575. WE shall in this chapter proceed, in continuation of Art. 287, with the general theory of surfaces, and shall first give for surfaces in general a few theorems proved for quadrics (Art. 233, &c.).

The locus of the points whose polar planes with regard to four surfaces U, V, W, T (whose degrees are m, n, p, q) meet in a point, is a surface of the degree $m + n + p + q - 4$; the Jacobian of the system. For its equation is evidently got by equating to nothing the determinant whose constituents are the four differential coefficients of each of the four surfaces. If a surface of the form $\lambda U + \mu V + \nu W$ touch T , the point of contact is evidently a point on the Jacobian, and must lie somewhere on the curve of the degree $q(m+n+p+q-4)$ where the Jacobian meets T . In like manner, $pq(m+n+p+q-4)$ surfaces of the form $\lambda U + \mu V$ can be drawn so as to touch the curve of intersection of T, W ; for the point of contact must be some one of the points where the curve TW meets the Jacobian.

It follows hence, that the tact-invariant of a system of three surfaces U, V, W (that is to say, the condition that two of the mnp points of intersection may coincide), contains the coefficients of the first in the degree $np(2m+n+p-4)$; and in like manner for the other two surfaces. For, if in this condition we substitute for each coefficient a of U , $a + \lambda a'$, where a' is the corresponding coefficient of another surface U' of the same degree as U , it is evident that the degree of the result in λ is the same as the number of surfaces of the form $U + \lambda U'$, which can be drawn to touch the curve of intersection of V, W .*

* Moutard, *Terquem's Annales*, vol. XIX. p. 58.

I had arrived at the same result otherwise thus: (see *Quarterly Journal*, vol I. p. 339). Two of the points of intersection coincide if the curve of intersection UV touch the curve UW . At the point of contact then the tangent planes to the three surfaces have a line in common; and these planes therefore have a point in common with any arbitrary plane $\alpha x + \beta y + \gamma z + \delta w$. Thus the point of contact annuls the determinant, which has for one row, $\alpha, \beta, \gamma, \delta$; and for the other three, the four differentials of each of the three surfaces. The condition that this determinant may vanish for a point common to the three surfaces is got by eliminating between the determinant and U, V, W . The result will contain $\alpha, \beta, \gamma, \delta$ in the degree mnp ; and the coefficients of U in the degree $np(m+n+p-3) + mnp$. But this result of elimination contains as a factor the condition that the plane $\alpha x + \beta y + \gamma z + \delta w$ may pass through one of the points of intersection of U, V, W . And this latter condition contains $\alpha, \beta, \gamma, \delta$ in the degree mnp , and the coefficients of U in the degree np . Dividing out this factor, the quotient, as already seen, contains the coefficients of U in the degree

$$np(2m+n+p-4).$$

576. The locus of points whose polar planes with regard to three surfaces have a right line common is, as may be inferred from the last article, the Jacobian curve denoted by the system of determinants

$$\begin{vmatrix} U_1 & U_2 & U_3 & U_4 \\ V_1 & V_2 & V_3 & V_4 \\ W_1 & W_2 & W_3 & W_4 \end{vmatrix} = 0.$$

But this curve (see *Higher Algebra*, Art. 257) is of the order

$$(m'^2 + n'^2 + p'^2 + m'n' + n'p' + p'm'),$$

where m' is the order of U_1 , &c., that is to say, $m' = m - 1$, &c. If a surface of the form $\lambda U + \mu V$ touch W , the point of contact is evidently a point on the Jacobian curve, and therefore the number of such surfaces which can be drawn to touch W is equal to the number of points in which this curve meets W , that is to say, is p times the degree of that curve. Reasoning

then, as in the last article, we see that the tact-invariant of two surfaces U, V , that is to say, the condition that they should touch, contains the coefficients of U in the degree

$$n(n'^2 + 2m'n' + 3m'^2),$$

or $n(n^2 + 2mn + 3m^2 - 4n - 8m + 6)$.

This number may be otherwise expressed as follows: if the order and class of V be M and N , and the order of the tangent cone from any point be R , then the degree in which the coefficients of U enter into the tact-invariant is

$$N + 2R(m - 1) + 3M(m - 1)^2.$$

We add, in the form of examples, a few theorems to which it does not seem worth while to devote a separate article.

Ex. 1. Two surfaces U, V of the degrees m, n intersect; the number of tangents to their curve of intersection, which are also inflexional tangents of the first surface, is $mn(3m + 2n - 8)$.

The inflexional tangents at any point on a surface are generating lines of the polar quadric of that point; any plane therefore through either tangent touches that polar quadric. If then we form the condition that the tangent plane to V may touch the polar quadric of U , which condition involves the second differentials of U in the third degree, and the first differentials of V in the second degree, we have the equation of a surface of the degree $(3m + 2n - 8)$ which meets the curve of intersection in the points, the tangents at which are inflexional tangents on U .

Ex. 2. In the same case to find the degree of the surface generated by the inflexional tangents to U at the several points of the curve UV .

This is got by eliminating $x'y'z'w'$ between the equations

$$U' = 0, \quad V' = 0, \quad \Delta U' = 0, \quad \Delta^2 U' = 0,$$

which are in $x'y'z'w'$ of the degrees respectively $m, n, m - 1, m - 2$, and in $xyzw$ of the degrees $0, 0, 1, 2$. The result is therefore of the degree $mn(3m - 4)$.

Ex. 3. To find the degree of the developable which touches a surface along its intersection with its Hessian. The tangent planes at two consecutive points on the parabolic curve intersect in an inflexional tangent (Art. 269); and, by the last example, since $n = 4(m - 2)$, the degree of the surface generated by these inflexional tangents is $4m(m - 2)(3m - 4)$. But since at every point of the parabolic curve the two inflexional tangents coincide, and therefore the surfaces generated by each of these tangents coincide, the number just found must be divided by two, and the degree required is $2m(m - 2)(3m - 4)$.

Ex. 4. To find the characteristics, as at p. 298, of the developable circumscribed along any plane section to a surface whose degree is m . The section of the developable by the given plane is the section of the given surface, together with the tangents at its $3m(m - 2)$ points of inflexion. Hence we easily find

$$\mu = 6m(m - 2), \quad \nu = m(m - 1), \quad r = m(3m - 5), \quad \alpha = 0, \quad \beta = 2m(5m - 11), \quad \&c.$$

Ex. 5. To find the characteristics of the developable which touches a surface of the degree m along its intersection with a surface of degree n .

Ans. $\nu = mn(m-1)$, $\alpha = 0$, $r = mn(3m+n-6)$, whence the other singularities are found as at p. 298.

Ex 6. To find the characteristics of the developable touching two given surfaces, neither of which has multiple lines.

Ans. $\nu = mn(m-1)^2(n-1)^2$; $\alpha = 0$, $r = mn(m-1)(n-1)(m+n-2)$.

Ex. 7. To find the characteristics of the curve of intersection of two developables.

The surfaces are of degrees r and r' , and since each has a nodal and cuspidal curve of degrees respectively x and m , x' and m' , therefore the curve of intersection has $rx' + r'x$ and $rm' + r'm$ actual nodal and cuspidal points. The cone therefore which stands on the curve, and whose vertex is any point, has nodal and cuspidal edges in addition to those considered at Art. 343; and the formulæ there given must then be modified. We have as there $\mu = rr'$; but the degree of the reciprocal of this cone is

$$\rho = rr'(r+r'-2) - r(2x'+3m') - r'(2x+3m),$$

or, by the formulæ of Art. 327, $\rho = rn' + nr'$. In like manner

$$\nu = ar' + a'r + 3rr'.$$

Ex. 8. To find the characteristics of the developable generated by a line meeting two given curves. This is the reciprocal of the last example. We have therefore $\nu = rr'$, $\rho = rm' + mr'$, $\mu = \beta r' + \beta'r + 3rr'$.

Ex. 9. To find the characteristics of the curve of intersection of a surface and a developable. The letters M, N, R relate to the surface as in the present article; m, n, r to the developable. Ans. $\mu = Mr$, $\rho = rR + nM$, $\nu = aM + 3rR$.

Ex. 10. To find the characteristics of a developable touching a surface and also a given curve. Ans. $\mu = \beta N + 3rR$, $\rho = rR + mN$, $\nu = Nr$.

577. The theory of *systems of curves* given in *Higher Plane Curves*, p. 372, obviously admits of extension to surfaces. Let it be supposed that we are given one less than the number of conditions necessary to determine a surface of the n^{th} order; the surfaces satisfying these conditions form a system whose characteristics are μ, ν, ρ ; where μ is the number of surfaces of the system which pass through any point, ν is the number which touch any plane, and ρ the number which touch any line. It is obvious that the sections of the system of surfaces by any plane form a system of curves whose characteristics are μ, ρ ; and the tangent cones drawn from any point form a system whose characteristics are ρ, ν . Several of the following theorems answer to theorems already proved for curves.

(1) *The locus of the poles of a fixed plane with regard to surfaces of the system is a curve of double curvature of the*

order ν . The locus is a curve, since the plane itself can only be met by the locus in a finite number of points ν . Taking the plane at infinity, we find, as a particular case of the above, the locus of the centre of a quadric satisfying eight conditions. Thus, when eight points are given, the locus is a curve of the third order; when eight planes, it is a right line.

(2) *The envelope of the polar planes of a fixed point, with regard to all the surfaces of the system, is a developable of the class μ .*

(3) *The locus of the poles with regard to surfaces of the system, of all the planes which pass through a fixed right line, is a surface of the degree ρ . There are evidently ρ and only ρ points of the locus, which lie on the assumed line. The theorem may otherwise be stated thus: understanding by the polar curve of a line with respect to a surface, the curve common to the first polars of all the points of the line; then, the polar curves of a fixed line with regard to all the surfaces of the system lie on a surface of the degree ρ .*

(4) *Reciprocally, The polar planes of all the points of a line, with respect to surfaces of the system, envelope a surface of the class ρ .*

(5) *The locus of the points of contact of lines drawn from a fixed point to surfaces of the system is a surface of the order $\mu + \rho$, having the fixed point as a multiple point of order μ . This is proved as for curves. The problem may otherwise be stated: "To find the locus of a point such that the tangent plane at that point to one of the surfaces of the system which passes through it shall pass through a fixed point." Hence we may infer the locus of points where a given plane is cut orthogonally by surfaces of the system. It is the curve in which the plane is cut by the locus surface $\mu + \rho$, answering to the point at infinity on a perpendicular to the given plane.*

(6) *The locus of points of contact, with surfaces of the system, of planes passing through a fixed line, is a curve of the order $\nu + \rho$ meeting the fixed line in ρ points. This also may be stated as the locus of points, the tangent planes at which to surfaces of the system passing through it contain a given line.*

(7) *The locus of a point such that its polar plane with regard to a given surface of degree m , and the tangent plane at that point to one of the surfaces of the system passing through it, intersect in a line which meets a fixed right line, is a surface of the degree $m\mu + \rho$. The locus evidently meets the fixed line in the ρ points where it touches the surfaces of the system, and in the m points where it meets the fixed surface, these last being multiple μ .*

(8) *If in the preceding case the line of intersection is to lie in a given plane, the locus will be a curve of the order $m(m-1)\mu + m\rho + \nu$. The ν points where the fixed plane is touched by surfaces of the system are points on the locus; and also the points where the section of the fixed surface by the fixed plane is touched by the sections of the surfaces of the system. But the number of these last points is $\mu m(m-1) + m\rho$.*

The locus just considered meets the fixed surface in $m\{m(m-1)\mu + m\rho + \nu\}$ points. But it is plain that these must either be the $\mu m(m-1) + m\rho$ points just mentioned, or else points where surfaces of the system touch the fixed surface. Subtracting, then, from the total number the number just written, we find that—

(9) *The number of surfaces of the system which touch a fixed surface is $\mu m(m-1)^2 + \rho m(m-1) + \nu m$; or, more generally, if n be the class of the surface, and r the order of the tangent cone from any point, the number is $\mu n + r\rho + \nu m$.*

We can hence determine the number of surfaces of the form $\lambda U + V$ which can touch a given surface. For if U and V are of the degree m , these surfaces form a system for which $\mu = 1$, $\nu = 3(m-1)^2$, $\rho = 2(m-1)$. If, then, n be the degree of the touched surface, the value is

$$n(n-1)^2 + 2n(n-1)(m-1) + 3n(m-1)^2,$$

the same value as that given, Art 576. This conclusion may otherwise be arrived at by the following process.

578. *If there be in a plane two systems of points having a (n, m) correspondence, that is, such that to any point of the first system correspond m of the second, and to any*

point of the second correspond n of the first: and, moreover, if any right line contains r pairs of corresponding points, then the number of points of either system which coincide with points corresponding to them is $m + n + r$. Let us suppose that the coordinates of two corresponding points $xy, x'y'$, are connected by a relation of the degrees μ, μ' in $xy, x'y'$ respectively; and by another relation of the degrees ν, ν' ; then if $x'y'$ be given, there are evidently $\mu\nu$ values of xy , hence $n = \mu\nu$. In like manner $m = \mu'\nu'$. If we eliminate x, y between the two equations, and an arbitrary equation $ax + by + c = 0$, we obtain a result of the degree $\mu\nu' + \mu'\nu$ in $x'y'$; showing that if one point describe a right line, the other will describe a curve of the degree $\mu\nu' + \mu'\nu$, which will, of course, intersect the right line in the same number of points, hence $r = \mu\nu' + \mu'\nu$. But if we suppose x' and y' respectively equal to x and y , we have $(\mu + \mu')(\nu + \nu')$ values of x and y ; a number obviously equal to $m + n + r$.

579. Let us now proceed to investigate the nature of the locus of points, whose polar planes with respect to surfaces of the system coincide with their polars with respect to a fixed surface; and let us examine how many points of this locus can lie in an assumed plane. Let there be two points A and a in the plane, such that the polar plane of A with respect to the fixed surface coincides with the polar plane of a with respect to surfaces of the system. Now, first, if A be given, its polar plane with regard to the fixed surface is given; and the poles of that plane with respect to surfaces of the system lie, by theorem (1), on a curve of the order ν . This curve will meet the assumed plane in the points a which correspond to A , whose number therefore is ν . On the other hand, if a be given, its polar planes with respect to surfaces of the system envelope, by theorem (2), a developable whose class is μ ; but the polar planes of the points of the given plane with regard to the fixed surface envelope a surface whose class is $(m - 1)^2$;^{*} this surface and the developable have common $\mu(m - 1)^2$ tangent planes, which will be the number of points A corresponding to a .

* It was mentioned (p. 491) that if the equation of a plane contain two parameters in the degree n , its envelope will be of the class n^2 .

Lastly, let A describe a right line, then its polar planes with respect to the fixed surface envelope a developable of the class $m - 1$; but with respect to the surfaces of the system, by theorem (3), envelope a surface of the class ρ . There may, therefore, be $\rho(m - 1)$ planes whose poles on either hypothesis lie on the assumed line. Hence, last article, the number of points A which coincide with points a is $\mu(m - 1)^2 + \rho(m - 1) + \nu$. The locus, then, of points whose polar planes with respect to the system, and with respect to a fixed surface, coincide, will be a curve of the degree just written, and it will meet the fixed surface in the points where it can be touched by surfaces of the system.

580. We add a few more theorems given by De Jonquières.

(10) *The locus of a point such that the line joining it to a fixed point, and the tangent plane at it to one of the surfaces of the system which pass through it, meet the plane of a fixed curve in a point and line which are pole and polar with respect to that curve, is a curve of the degree $\mu m(m - 1) + \rho m + \nu$. This is proved as theorem (8). Let the fixed curve be the imaginary circle at infinity, and the theorem becomes the locus of the feet of the normals drawn from a fixed point to the surfaces of the system is a curve of the degree $2\mu + 2\rho + \nu$.*

(11) If there be a system of plane curves, whose characteristics are μ, ν , the locus of a point such that its polar with regard to a fixed curve of degree m , and the tangent at it to one of the curves of the system which pass through it, cut a given finite line harmonically, is a curve whose degree is $m\mu + \nu$. Consider in how many points the given line meets the locus, and evidently its ν points of contact with curves of the system are points on the locus. But, reasoning as in other cases, we find that there will be m points on the line, whose polars with respect to the fixed curve divide the given line harmonically. And since these are points on the locus for each of the μ curves which pass through them, the degree of the locus is $m\mu + \nu$. Taking for the finite line the line joining the two imaginary circular points at infinity, it follows that there are $m(m\mu + \nu)$ curves of the system which cut a given curve orthogonally. De Jonquières finds that in like manner *the locus of a point such that its polar plane with*

regard to a fixed surface, and the tangent plane at that point to one of the surfaces of the system, meet the plane of a fixed conic in two lines conjugate with respect to the conic, is a surface of the order $m\mu + \rho$. And consequently that a surface of this order meets the fixed surface in points where it is cut orthogonally by surfaces of the system.

(12) If from each of two fixed points Q, Q' tangents be drawn to a system of plane curves of the n^{th} class, the locus of the intersections of the tangents of one system with those of the other is a curve of the order $\nu(2n - 1)$. For consider any curve touching the line QQ' , then one point of the locus will be the point of contact, and $n - 1$ of the others will coincide with each of the points Q, Q' . And since there may be ν such curves, each of the points Q, Q' , is a multiple point of the order $(n - 1)\nu$, and the line QQ' meets the locus in $\nu(2n - 1)$ points. Let the points QQ' be the two circular points at infinity, and it follows that the locus of foci of curves of the system is a curve of degree $\nu(2n - 1)$. If we investigate, in like manner, *the locus of the intersection of cones drawn to a system of surfaces from two fixed points QQ'* , it is evident, from what has been said, that any plane through QQ' meets the locus in a curve whose order is $\rho(2n - 1)$; but the line QQ' is a multiple line of degree ρ , being common to both cones in every case where the line QQ' touches a surface of the system. *The order of the locus therefore is $2n\rho$* ; and accordingly, 4ρ is the order of the locus of foci of sections of a system of quadrics by planes parallel to a fixed plane.*

* Chasles has given the theorem that if there be a system of conics whose characteristics are μ, ν , then $2\nu - \mu$ conics of the system reduce to a pair of lines, and $2\mu - \nu$ to a pair of points. It immediately follows hence, as Cremona has remarked, that if there be a system of quadrics, whose characteristics are μ, ν, ρ , of which σ reduce to cones and σ' to plane conics, then considering the section of the system by any plane, we have $\nu = 2\rho - \mu$, $\sigma' = 2\mu - \rho$, and, reciprocally, $\sigma = 2\nu - \rho$. These theorems, however, are obviously subject to modifications if it can ever happen that a surface of the system can reduce to a pair of planes or a pair of points. Thus in the simple case of the system through six points and touching two planes, the ten pairs of planes through the six points are to be regarded as surfaces of the system, since a pair of planes is a quadric which touches every plane. For the same reason the problem to describe a quadric through six

581. The theory of the *transformation* of curves and of the *correspondence* of points on curves (explained *Higher Plane Curves*, Chap. VIII.) is evidently capable of extension to space of three dimensions, but only a very slight sketch can here be given of what has been done on this subject. The reader may consult Cremona, *Mémoire de géométrie pure sur les surfaces du troisième ordre*, *Crelle*, LXVIII. pp. 1–96 (1868); Clebsch, *Ueber die Abbildung algebraischer Flächen insbesondere der vierten und funften Ordnung*, *Math. Annalen*, I. pp. 253–316 (1868); Cayley, *On the rational transformation between two spaces*, *Proc. Lond. Math. Soc.*, III. pp. 127–180 (1870); and other papers by the same authors, and by Darboux, Klein, Korndörfer, Nöther, Zeuthen, and others.

It will be recollected that a unicursal curve is a curve, the points of which have a (1, 1) correspondence with those of a line; or, analytically, we can express the coordinates x, y, z of a point of it as proportional to homogeneous functions, of the same order m , of two parameters λ, μ . Similarly, a unicursal surface is a surface, the points of which have a (1, 1) correspondence with those of a plane; or, analytically, we can express the coordinates x, y, z, w of any of its points as proportional to homogeneous functions, of the same order m , of three parameters λ, μ, ν . When the points of a surface have thus a (1, 1) correspondence with those of a plane, it is evident that every curve on the surface corresponds in the same manner to a curve in the plane, which latter curve may, therefore, be taken as a representation (*Abbildung*) of the former curve.

582. It is geometrically evident that quadrics and cubics are unicursal surfaces. If we project the points of a quadric on a plane by means of lines passing through a fixed point O on the surface, we obtain at once a (1, 1) correspondence between the points of the quadric and of the plane. In the

points to touch three planes does not, as might be thought, admit of 27 but only of 17 solutions, the ten pairs of planes counting among the apparent solutions.

I have attempted to enumerate the number of quadrics which satisfy nine conditions, *Quarterly Journal*, VIII. 1 (1866). The same problem has been more completely dealt with by Chasles and Zeuthen (see *Comptes Rendus*, Feb. 1866, p. 405).

case of the cubic, taking any two of the right lines on the surface, any point on the surface may be projected on a plane by means of a line meeting the two assumed lines, and we have in this case also a (1, 1) correspondence between the points of the surface and of the plane. From the construction in the case of the quadric can easily be derived analytical expressions giving x, y, z, w as quadratic functions of three parameters. And such expressions can be obtained in several other ways: for instance, coordinate systems have been formed by Plücker and Chasles (see p. 358) determining each point on the surface by means of the two generators which pass through it. And, indeed, the method by which the generators are expressed by means of parameters (Art. 108) at once suggests a similar expression for the coordinates of a point (see p. 382) on the surface. Thus, on the quadric $xw = yz$, the systems of generators are $\lambda x = \mu y, \mu w = \lambda z$; $\lambda x = \nu z, \nu w = \lambda y$, whence the coordinates of any point on the quadric may be taken $\mu\nu, \lambda\nu, \lambda\mu, \lambda^2$. The construction we have indicated in the case of a cubic may also be used to furnish expressions for the coordinates in terms of parameters; but other methods effect the same object more simply. For instance, Clebsch has used the theorem that any cubic may be generated as the locus of the intersection of three corresponding planes, each of which passes through a fixed point. If A, B, C ; A', B', C' ; A'', B'', C'' represent planes, we evidently obtain the equation of a cubic by eliminating λ, μ, ν between the equations $\lambda A + \mu B + \nu C = 0, \lambda A' + \mu B' + \nu C' = 0, \lambda A'' + \mu B'' + \nu C'' = 0$; and if we take λ, μ, ν as parameters, we can evidently, by solving these three equations for x, y, z, w , which they implicitly contain, obtain expressions for the coordinates of any point on the cubic, as cubic functions of the three parameters.

583. It will be more simple, however, if we proceed by a converse process. Let us suppose that we are given a system of equations $x : y : z : w = P : Q : R : S$, where P, Q, R, S are functions, of the m^{th} order, of three parameters λ, μ, ν . This system of equations evidently represents a surface, the equation of which can be found by eliminating λ, μ, ν from the equations, when there results a single equation in x, y, z, w . If λ, μ, ν

be taken as the coordinates of a point in a plane, the given system of equations establishes a (1, 1) correspondence between the points of the surface and of the plane. $P=0$, &c., denote curves of the m^{th} order in that plane. Let us first examine the order of the surface represented by the system of equations, or the number of points in which it is met by an arbitrary line $ax+by+cz+dw$, $a'x+b'y+c'z+d'w$. To these points evidently correspond in the plane the intersections of the two curves

$$aP+bQ+cR+dS=0, \quad a'P+b'Q+c'R+d'S=0,$$

whence it follows that the order of the surface is in general m^2 . If, however, the curves P, Q, R, S have α common points,* the two curves have besides these only $m^2 - \alpha$ other points of intersection, and accordingly this is the order of the surface. Then to any plane section of the surface will correspond in the plane a curve $aP+bQ+cR+dS$ passing through the α points: these two curves will have the same deficiency, and we are thus in each case enabled to determine whether a plane section of the surface contains double points, that is to say, whether the surface contains multiple lines. To the section of the surface, by a surface of the k^{th} order, $ax^k + \&c.=0$ corresponds in the plane a curve $aP^k + \&c.=0$ of the order mk , and on this each of the α points is a multiple point of the order k . Again, the given system of equations determines a point on the surface corresponding to each point of the plane, except in the case of any of the α points. For each of these, the expressions for x, y, z, w vanish, and their mutual ratios become indeterminate: to one of these points then corresponds on the surface not a point, but a locus, which will ordinarily be a right line on the surface. To a curve of degree p on the plane will correspond on the surface a curve the order of which (that is to say, the number of points in which it is met by an arbitrary plane) is the same as the number of points in which the given plane curve is met by a curve $aP+bQ+cR+dS$. This number will be, in general, mp , but it will be reduced one

* For simplicity, we only notice the case where the common points are ordinary points, but of course some of them may be multiple points.

for each passage of the given curve through one of the α points.

584. In conformity, then, with the theory thus explained, let P, Q, R, S be quadratic functions of λ, μ, ν ; then $P=0$, &c represent conics; and in order that the corresponding surface should be a quadric, it is necessary and sufficient that the conics P, Q, R, S should have two common points A, B . Then to any point in the plane ordinarily corresponds a point on the surface, except that to the points A, B correspond right lines on the surface. To a plane section of the quadric corresponds in general a conic passing through AB ; but this conic may in some cases break up into the line AB , together with another line; and in fact the previous theory shows that to every right line in the plane thus corresponds in general a conic on the quadric. If, however, the line in the plane pass through either of the points A, B , the corresponding locus on the quadric is only of the first degree, and we are thus by this method led to see the existence of two systems of lines on the surface, the lines of one system all meeting a fixed line A , those of the other a fixed line B .

585. If the conics P, Q, R, S have but one common point A , the surface is a cubic; but as each plane section of the cubic corresponds to a conic, and is therefore unicursal, it must have a double point, and the cubic surface has a double line. And since to every line through the point A corresponds a line on the surface, we see that the cubic is a ruled surface. In like manner, if P, Q, R, S have no common point, the surface is a quartic; but every plane section being unicursal, the quartic has a nodal curve of the third order; this is Steiner's surface already referred to.

586. Again, let P, Q, R, S be cubic functions of λ, μ, ν ; in order that the surface represented should be a cubic, the curves P, Q, R, S must have six common points. Then the deficiency of the curve $aP + \&c$. being unity, this is also the deficiency of a plane section of the cubic; that is to say, the surface has no double line. To the six points will correspond six non-

intersecting lines on the surface; these will be one set of the lines of a Schläfli's double-six.

To a line in the plane corresponds on the surface a skew cubic curve, but if the line pass through one of the six points, the corresponding curve will be a conic, and if the line join two of the six points, the corresponding curve will be a right line. We thus see that there are on the surface, in addition to the six lines with which we started, fifteen others, each meeting two of the six lines. Again, to a conic in the plane corresponds in general a sextic curve on the surface, but this will reduce to a line if the conic pass through five of the six points. We have thus six other lines on the surface, each meeting five of the original six; and thus the entire number is made up of $27 = 6 + 15 + 6$.

Suppose, however, P, Q, R, S to be still cubic functions, but that the curves represented by them have only five common points, then, by the previous theory, the surface represented is a quartic, but the deficiency of a plane section being unity, the quartic must have a nodal conic. There will be on the quartic right lines, viz. five corresponding to the five common points, one corresponding to the conic through these points, and ten to the lines joining each pair of the points; or sixteen in all (see Art. 559). This is the method in which Clebsch arrived at this theory (*Crelle*, vol. 69).

587. The "deficiency" of a plane curve of the order n with δ double points and κ cusps is $=\frac{1}{2}(n-1)(n-2) - \delta - \kappa$, it is equal to the number of arbitrary constants contained (homogeneously) in the equation of a curve of the order $n-3$, which passes through the $\delta + \kappa$ double points and cusps; and it was found by Clebsch that there is a like expression for the "deficiency" of a surface of the order n having a nodal and a cuspidal curve; it is equal to the number of arbitrary constants contained (homogeneously) in the equation of a surface of the order $(n-4)$, which passes through the nodal and cuspidal curves of the given surface.* Prof. Cayley thence deduced the

* More generally, if the surface has an i -ple curve and also j -ple points, then it is found by Dr. Nöther that the deficiency is equal to the number of constants,

expression

$D = \frac{1}{6}(n-1)(n-2)(n-3) - (n-3)(b+c) + \frac{1}{2}(q+r) + 2t + \frac{7}{2}\beta + \frac{5}{2}\gamma + i - \frac{1}{8}\theta$,
 where b, q are the order and class of the nodal curve, c, r those of the cuspidal curve, t the number of triple points on the nodal curve, β, γ, i the number of intersections of the two curves (β of those which are stationary points on the nodal curve, γ stationary points on the cuspidal curve, i not stationary on either curve), and θ the number of singularities of a certain other kind. In the case where there is only a double curve without triple points the formula is

$$D = \frac{1}{6}(n-1)(n-2)(n-3) - (n-3)b + \frac{1}{2}q.$$

Thus in the several cases,

Quadric surface	$n = 2, b = 0, q = 0.$
General cubic surface	$n = 3, b = 0, q = 0.$
Quartic with nodal right line	$n = 4, b = 1, q = 0.$
„ „ nodal conic	$n = 4, b = 2, q = 2.$
Quintic with nodal curve,	
a pair of non-intersecting right lines	$n = 5, b = 2, q = 0.$
„ „ nodal skew cubic	$n = 5, b = 3, q = 4,$

and in all these cases we find $D = 0$ or the surface is unicursal.

CONTACT OF LINES WITH SURFACES.

588. We now return to the class of problems proposed in Art. 272, viz. to find the degree of the curve traced on a surface by the points of contact of a line which satisfies three conditions. The cases we shall consider are: (*A*) to find the curve traced by the points of contact of lines which meet in four consecutive points; (*B*) when a line is an inflexional tangent at one point, and an ordinary tangent at another, to find the degree of the curve formed by the former points, and (*C*) that of the curve formed by the latter; (*D*) to find the curve traced by the points of contact of triple tangent lines. To

as above, in the equation of a surface of the order $n-4$, which passes $(i-1)$ times through the i -ple curve (has this for an $(i-1)$ ple line), and $(j-2)$ times through each j -ple point (has this for a $(j-2)$ ple point).

these may be added: (a) to find the degree of the surface formed by the lines A ; (b) to find the degree of that formed by the lines considered in (B) and (C); (c) to find the degree of that generated by the triple tangents.

Now to commence with problem A : if a line meet a surface in four consecutive points we must at the point of contact not only have $U' = 0$, but also $\Delta U' = 0$, $\Delta^2 U' = 0$, $\Delta^3 U' = 0$. The tangent line must then be common to the surfaces denoted by the last three equations.

But since the six points of intersection of these surfaces are all coincident with $x'y'z'w'$, the problem is a case of that treated in Art. 473. Since then, by that article, the condition $\Pi = 0$, that the three surfaces should have a common line, is of the degree

$$\lambda'\lambda''\mu + \lambda''\lambda\mu' + \lambda\lambda'\mu'' - \lambda\lambda'\lambda'';$$

substituting

$$\lambda = 1, \lambda' = 2, \lambda'' = 3; \mu = n - 1, \mu' = n - 2, \mu'' = n - 3;$$

we find that Π is of the degree $(11n - 24)$. *The points of contact then of lines which meet the surface in four consecutive points lie on the intersection of the surface with a derived surface S of the degree $11n - 24$.**

The intersection of this surface S with the given surface U is a curve of the order $n(11n - 24)$, "the flecnodal curve" of U ; at any point of this curve the tangent plane of U meets U in a curve having at the point a flecnode, or double point having there an inflexion on one branch; the tangent to this inflected branch is of course the osculating (4-pointic) tangent.

589. We proceed to give Clebsch's calculation, determining the equation of this surface S which meets the given surface

* I gave this theorem in 1849 (*Cambridge and Dublin Journal*, vol. IV. p. 260). I obtained the equation in an inconvenient form (*Quarterly Journal*, vol. I. p. 336); and in one more convenient (*Philosophical Transactions*, 1860, p. 229) which I shall presently give. But I substitute for my own investigation the very beautiful piece of analysis by which Professor Clebsch performed the elimination indicated in the text, *Crelle*, vol. LVIII, p. 93. Prof. Cayley has observed that exactly in the same manner as the equation of the Hessian is the transformation of the equation $rt - s^2$ which is satisfied for every point of a developable, so the equation $S = 0$ is the transformation of the equation (Art. 437) which is satisfied for every point on a ruled surface.

at the points of contact of lines which meet it in four consecutive points. It was proved, in last article, that in order to obtain this equation it is necessary to eliminate between the equations of an arbitrary plane and of the surfaces $\Delta U'$, $\Delta^2 U'$, $\Delta^3 U'$. This elimination is performed by solving for the coordinates of the two points of intersection of the arbitrary plane, the tangent plane $\Delta U'$, and the polar quadric $\Delta^2 U'$; substituting these coordinates successively in $\Delta^3 U'$, and multiplying the results together. Let the four coordinates of the point of contact be x_1, x_2, x_3, x_4 ; the running coordinates y_1, y_2, y_3, y_4 ; the differential coefficients u_1, u_2, u_3, u_4 ; the second and third differential coefficients being denoted in like manner by suffixes, as u_{12}, u_{123} . Through each of the lines of intersection of $\Delta U'$, $\Delta^2 U'$, we can draw a plane, so that by suitably determining t_1, t_2, t_3, t_4 , we can, in an infinity of ways, form an equation identically satisfied

$$\Delta^2 U' + (t_1 y_1 + t_2 y_2 + t_3 y_3 + t_4 y_4) \Delta U' \\ = (p_1 y_1 + p_2 y_2 + p_3 y_3 + p_4 y_4) (q_1 y_1 + q_2 y_2 + q_3 y_3 + q_4 y_4) \dots \text{(I)}.$$

We shall suppose this transformation effected; but it is not necessary to determine the actual values of t_1 , &c., for it will be found that these quantities disappear from the result. Let the arbitrary plane be $c_1 y_1 + c_2 y_2 + c_3 y_3 + c_4 y_4$, then it is evident that the coordinates of the intersections of the arbitrary plane, the tangent plane $u_1 y_1 + u_2 y_2 + u_3 y_3 + u_4 y_4$, and $\Delta^2 U'$, are the four determinants of the two systems

$$\left\| \begin{array}{cccc} c_1 & c_2 & c_3 & c_4 \\ u_1 & u_2 & u_3 & u_4 \\ p_1 & p_2 & p_3 & p_4 \end{array} \right\|, \quad \left\| \begin{array}{cccc} c_1 & c_2 & c_3 & c_4 \\ u_1 & u_2 & u_3 & u_4 \\ q_1 & q_2 & q_3 & q_4 \end{array} \right\|.$$

These coordinates have now to be substituted in $\Delta^3 U'$, which we write in the symbolical form $(a_1 y_1 + a_2 y_2 + a_3 y_3 + a_4 y_4)^3$; where a_1 means $\frac{d}{dx_1}$, &c., so that, after expansion, we may

substitute for any term $a_1 a_2 a_3 y_1 y_2 y_3$, $u_{123} y_1 y_2 y_3$, &c. It is evident then that the result of substituting the coordinates of the first point in $\Delta^3 U'$ may be written as the cube of the symbolical determinant $\Sigma a_1 c_2 u_3 p_4$, where, after cubing, we are to substitute third differential coefficients, for the powers of the

a 's as has been just explained. In like manner, we write the result of substituting the coordinates of the second point $(\Sigma b_1 c_2 u_3 q_4)^3$, where b_1 is a symbol used in the same manner as a_1 . The eliminant required may therefore be written

$$(\Sigma a_1 c_2 u_3 p_4)^3 (\Sigma b_1 c_2 u_3 q_4)^3 = 0.*$$

The above result may be written in the more symmetrical form

$$(\Sigma a_1 c_2 u_3 p_4)^3 (\Sigma b_1 c_2 u_3 q_4)^3 + (\Sigma b_1 c_2 u_3 p_4)^3 (\Sigma a_1 c_2 u_3 q_4)^3 = 0.$$

For, since the quantities a , b are after expansion replaced by differentials, it is immaterial whether the symbol used originally were a or b ; and the left-hand side of this equation when expanded is merely the double of the last expression. We have now to perform the expansion, and to get rid of p and q by means of equation (I). We shall commence by thus banishing p and q .

590. Let us write

$$F = (\Sigma a_1 c_2 u_3 p_4) (\Sigma b_1 c_2 u_3 q_4), \quad G = (\Sigma b_1 c_2 u_3 p_4) (\Sigma a_1 c_2 u_3 q_4).$$

The eliminant is $F^3 + G^3 = 0$, or $(F + G)^3 - 3FG(F + G) = 0$. We shall separately examine $F + G$, and FG , in order to get rid of p and q . If the determinants in F were so far expanded as to separate the p and q which they contain we should have

$$F = (m_1 p_1 + m_2 p_2 + m_3 p_3 + m_4 p_4) (n_1 q_1 + n_2 q_2 + n_3 q_3 + n_4 q_4),$$

$$G = (n_1 p_1 + n_2 p_2 + n_3 p_3 + n_4 p_4) (m_1 q_1 + m_2 q_2 + m_3 q_3 + m_4 q_4),$$

where, for example, m_4 is the determinant $\Sigma a_1 c_2 u_3$, and n_4 is $\Sigma b_1 c_2 u_3$. If then i, j be any two suffixes, the coefficient of $m_i n_j$ in $F + G$ is $(p_i q_j + p_j q_i)$. And we may write

$$F + G = \Sigma \Sigma m_i n_j (p_i q_j + p_j q_i),$$

where both i and j are to be given every value from 1 to 4.

* The reason why we use a different symbol for $\frac{d}{dx_1}$, &c. in the second determinant is because if we employed the same symbol, the expanded result would evidently contain sixth powers of a , that is to say, sixth differential coefficients. We avoid this by the employment of different symbols, as in Prof. Cayley's "Hyperdeterminant Calculus" (*Lessons on Higher Algebra*, Lesson XIV.), with which the method here used is substantially identical.

But, by comparing coefficients in equation (I), we have

$$p_i q_j + p_j q_i = 2u_{ij} + (t_i u_j + t_j u_i),$$

whence $F + G = 2 \sum \sum m_i n_j u_{ij} + \sum \sum m_i n_j (t_i u_j + t_j u_i)$.

Now it is plain that if for every term of the form $p_i q_j + p_j q_i$ we substitute $t_i u_j + t_j u_i$, the result is the same as if in F and G we everywhere altered p and q into t and u . But, if in the determinants $\sum a_{i,c_2} u_3 q_4$, $\sum b_{i,c_2} u_3 q_4$ we alter q into u , the determinants would vanish as having two columns the same. The latter set of terms therefore in $F + G$ disappears, and we have $\frac{1}{2} (F + G) = \sum \sum m_i n_j u_{ij}$.

Now, if we remember what is meant by m_i, n_j , this double sum may be written in the form of a determinant

$$- \begin{vmatrix} u_{11}, & u_{12}, & u_{13}, & u_{14}, & a_1, & c_1, & u_1 \\ u_{21}, & u_{22}, & u_{23}, & u_{24}, & a_2, & c_2, & u_2 \\ u_{31}, & u_{32}, & u_{33}, & u_{34}, & a_3, & c_3, & u_3 \\ u_{41}, & u_{42}, & u_{43}, & u_{44}, & a_4, & c_4, & u_4 \\ b_1, & b_2, & b_3, & b_4 & \dots\dots\dots \\ c_1, & c_2, & c_3, & c_4 & \dots\dots\dots \\ u_1, & u_2, & u_3, & u_4 & \dots\dots\dots \end{vmatrix}.$$

For since this determinant must contain a constituent from each of the last three rows and columns it is of the first degree in u_{11} , &c., and the coefficient of any term u_{14} is

$$- \{ \sum a_2 c_3 u_4 \sum b_1 c_2 u_3 + \sum a_1 c_2 u_3 \sum b_2 c_3 u_4 \} \text{ or } - (m_1 n_4 + m_4 n_1).$$

In the determinant just written the matrix of the Hessian is bordered vertically with a, c, u ; and horizontally with b, c, u . As we shall frequently have occasion to use determinants of this kind we shall find it convenient to denote them by an abbreviation, and shall write the result that we have just arrived at,

$$F + G = -2 \begin{pmatrix} a, c, u \\ b, c, u \end{pmatrix}.$$

591. The quantity FG is transformed in like manner. It is evidently the product of

$$(m_1 p_1 + m_2 p_2 + m_3 p_3 + m_4 p_4) (m_1 q_1 + m_2 q_2 + m_3 q_3 + m_4 q_4),$$

and $(n_1 p_1 + n_2 p_2 + n_3 p_3 + n_4 p_4) (n_1 q_1 + n_2 q_2 + n_3 q_3 + n_4 q_4)$.

Now if the first line be multiplied out, and for every term $(p_1q_2 + p_2q_1)$ we substitute its value derived from equation (I), it appears, as before, that the terms including t vanish, and it becomes $\Sigma\Sigma m_{,m}u_{,j}$, which, as before, is equivalent to $\begin{pmatrix} a, c, u \\ a, c, u \end{pmatrix}$, where the notation indicates the determinant formed by bordering the matrix of the Hessian both vertically and horizontally with a, c, u . The second line is transformed in like manner; and we thus find that $(F + G)^3 - 3FG(F + G) = 0$ transforms into

$$\begin{pmatrix} a, c, u \\ b, c, u \end{pmatrix} \left\{ \pm \begin{pmatrix} a, c, u \\ b, c, u \end{pmatrix}^2 - 3 \begin{pmatrix} a, c, u \\ a, c, u \end{pmatrix} \begin{pmatrix} b, c, u \\ b, c, u \end{pmatrix} \right\} = 0.$$

It remains to complete the expansion of this symbolical expression, and to throw it into such a form that we may be able to divide out $c_1x_1 + c_2x_2 + c_3x_3 + c_4x_4$. We shall for shortness write a, b, c , instead of $a_1x_1 + a_2x_2 + a_3x_3 + a_4x_4$, $b_1x_1 + \&c.$, $c_1x_1 + \&c.$

592. On inspection of the determinant, Art. 590, which we have called $\begin{pmatrix} a, c, u \\ b, c, u \end{pmatrix}$, it appears that since

$$u_{11}x_1 + u_{12}x_2 + u_{13}x_3 + u_{14}x_4 = (n-1)u_1, \&c.,$$

this determinant may be reduced by multiplying the first four columns by x_1, x_2, x_3, x_4 , and subtracting their sum from the last column multiplied by $(n-1)$, and similarly for the rows; when it becomes

$$-\frac{1}{(n-1)^2} \begin{vmatrix} u_{11} & u_{12} & u_{13} & u_{14} & a_1 & c_1 & 0 \\ u_{21} & u_{22} & u_{23} & u_{24} & a_2 & c_2 & 0 \\ u_{31} & u_{32} & u_{33} & u_{34} & a_3 & c_3 & 0 \\ u_{41} & u_{42} & u_{43} & u_{44} & a_4 & c_4 & 0 \\ b_1 & b_2 & b_3 & b_4 & 0 & 0 & -b \\ c_1 & c_2 & c_3 & c_4 & 0 & 0 & -c \\ 0 & 0 & 0 & 0 & -a & -c & 0 \end{vmatrix},$$

which partially expanded is

$$\frac{1}{(n-1)^2} \left\{ c^2 \begin{pmatrix} a \\ b \end{pmatrix} - ac \begin{pmatrix} c \\ b \end{pmatrix} - bc \begin{pmatrix} c \\ a \end{pmatrix} + ab \begin{pmatrix} c \\ c \end{pmatrix} \right\},$$

where $\begin{pmatrix} a \\ b \end{pmatrix}$ denotes the matrix of the Hessian bordered with a single line, vertically of a 's and horizontally of b 's.

In like manner we have

$$\begin{pmatrix} a, c, u \\ a, c, u \end{pmatrix} = -\frac{1}{(n-1)^2} \left\{ c^2 \begin{pmatrix} a \\ a \end{pmatrix} - 2ac \begin{pmatrix} a \\ c \end{pmatrix} + a^2 \begin{pmatrix} c \\ c \end{pmatrix} \right\},$$

$$\begin{pmatrix} b, c, u \\ b, c, u \end{pmatrix} = -\frac{1}{(n-1)^2} \left\{ c^2 \begin{pmatrix} b \\ b \end{pmatrix} - 2bc \begin{pmatrix} b \\ c \end{pmatrix} + b^2 \begin{pmatrix} c \\ c \end{pmatrix} \right\}.$$

Now as it will be our first object to get rid of the letter a , we may make these expressions a little more compact by writing $cb_1 - bc_1 = d_1$, &c., when it is easy to see that

$$\begin{pmatrix} d \\ d \end{pmatrix} = c^2 \begin{pmatrix} b \\ b \end{pmatrix} - 2bc \begin{pmatrix} b \\ c \end{pmatrix} + b^2 \begin{pmatrix} c \\ c \end{pmatrix};$$

$$\begin{pmatrix} c \\ d \end{pmatrix} = c \begin{pmatrix} b \\ c \end{pmatrix} - b \begin{pmatrix} c \\ c \end{pmatrix}; \quad \begin{pmatrix} a \\ d \end{pmatrix} = c \begin{pmatrix} a \\ b \end{pmatrix} - b \begin{pmatrix} a \\ c \end{pmatrix}.$$

Thus

$$\begin{pmatrix} b, c, u \\ b, c, u \end{pmatrix} = -\frac{1}{(n-1)^2} \begin{pmatrix} d \\ d \end{pmatrix}, \quad \begin{pmatrix} a, c, u \\ b, c, u \end{pmatrix} = -\frac{1}{(n-1)^2} \left\{ c \begin{pmatrix} a \\ d \end{pmatrix} - a \begin{pmatrix} c \\ d \end{pmatrix} \right\},$$

and the equation of the surface, as given at the end of last article, may be altered into

$$\left\{ c \begin{pmatrix} a \\ d \end{pmatrix} - a \begin{pmatrix} c \\ d \end{pmatrix} \right\} \left[4 \left\{ c \begin{pmatrix} a \\ d \end{pmatrix} - a \begin{pmatrix} c \\ d \end{pmatrix} \right\}^2 - 3 \begin{pmatrix} d \\ d \end{pmatrix} \left\{ c^2 \begin{pmatrix} a \\ a \end{pmatrix} - 2ac \begin{pmatrix} a \\ c \end{pmatrix} + a^2 \begin{pmatrix} c \\ c \end{pmatrix} \right\} \right].$$

593. We proceed now to expand and substitute for each term $a_1 a_2 a_3$, &c., the corresponding differential coefficient. Then, in the first place, it is evident that

$$a^3 = n(n-1)(n-2)u = 0; \quad a^2 a_1 = (n-1)(n-2)u_1, \quad \&c.$$

Hence
$$a^2 \begin{pmatrix} a \\ c \end{pmatrix} = (n-1)(n-2) \begin{pmatrix} u \\ c \end{pmatrix}.$$

But the last determinant is reduced, as in many similar cases, by subtracting the first four columns multiplied respectively by x_1, x_2, x_3, x_4 from the fifth column, and so causing it to vanish, except the last row. Thus we have

$$a^2 \begin{pmatrix} a \\ c \end{pmatrix} = -(n-2) Hc.$$

Again, $\binom{a}{a}$ is (see *Lessons on Higher Algebra*, Art. 34) $= -\Sigma \frac{dH}{du_{mn}} a_m a_n$.

We have therefore

$$a \binom{a}{a} = -(n-2) \Sigma \frac{dH}{du_{mn}} u_{mn} = -4(n-2) H.$$

Lastly, it is necessary to calculate $a \binom{a}{c} \binom{a}{d}$. Now if U_{mn} denote the minor obtained from the matrix of the Hessian by erasing the line and column which contain u_{mn} , it is easy to see that $a \binom{a}{c} \binom{a}{d} = -(n-2) \Sigma U_{mp} U_{qn} u_{mn} c_p d_q$, where the numbers m, n, p, q are each to receive in turn all the values 1, 2, 3, 4. But (see *Lessons on Higher Algebra*, Art. 33)

$$U_{mp} U_{nq} = U_{mn} U_{pq} - H \frac{dU_{pq}}{du_{mn}}.$$

Substituting this, and remembering that $\Sigma U_{mn} u_{mn} = 4H$, we have

$$a \binom{a}{c} \binom{a}{d} = -(n-2) H \binom{c}{d}.$$

Making then these substitutions we have

$$\begin{aligned} \left\{ c \binom{a}{d} - a \binom{c}{d} \right\}^3 &= c^3 \binom{a}{d}^3 + 3(n-2) H c^2 \binom{c}{d} \binom{d}{d} - 3(n-2) H c d \binom{c}{d}^2, \\ \left\{ c \binom{a}{d} - a \binom{c}{d} \right\} \left\{ c^2 \binom{a}{a} - 2ac \binom{a}{c} + a^2 \binom{c}{c} \right\} \\ &= c^3 \binom{a}{d} \binom{a}{a} + 4(n-2) H c^2 \binom{c}{c} - (n-2) H c d \binom{c}{c}. \end{aligned}$$

But attending to the meaning of the symbols d_1 , &c., we see that d or $d_1 x_1 + d_2 x_2 + d_3 x_3 + d_4 x_4$ vanishes identically. If then we substitute in the equation which we are reducing the values just obtained, it becomes divisible by c^3 , and is then brought to the form

$$4 \binom{a}{d}^3 - 3 \binom{a}{d} \binom{a}{a} \binom{d}{d} = 0.$$

594. To simplify this further we put for d its value, when it becomes

$$4 \left\{ c \binom{b}{a} - b \binom{c}{a} \right\}^3 - 3 \binom{a}{a} \left\{ c \binom{b}{a} - b \binom{c}{a} \right\} \left\{ c^2 \binom{b}{b} - 2bc \binom{b}{c} + b^2 \binom{c}{c} \right\}.$$

Now this is exactly the form reduced in the last article, except that we have b instead of a , and a in place of d . We can then write down

$$4 \left\{ c \binom{b}{a} - b \binom{c}{a} \right\}^3 = 4 \left\{ c^3 \binom{b}{a}^3 + 3(n-2) H c^2 \binom{c}{a} \binom{a}{a} - 3(n-2) H c a \binom{c}{a}^2 \right\},$$

while the remaining part of the equation becomes

$$3 \binom{a}{a} \left\{ c^3 \binom{b}{a} \binom{b}{b} + 4(n-2) H c^2 \binom{c}{a} - (n-2) H c a \binom{c}{c} \right\}.$$

But (last article) the last term in both these can be reduced to $12(n-2)^2 H^2 c \binom{c}{c}$. Subtracting, then, the factor c^2 divides out again, and we have the final result cleared of irrelevant factors, expressed in the symbolical form

$$\binom{b}{a} \left\{ 4 \binom{b}{a}^2 - 3 \binom{b}{b} \binom{a}{a} \right\} = 0.$$

595. It remains to show how to express this result in the ordinary notation. In the first place we may transform it by the identity (see *Lessons on Higher Algebra*, Art. 33)

$$H \binom{a, b}{a, b} = \binom{a}{a} \binom{b}{b} - \binom{a}{b}^2,$$

whereby the equation becomes

$$\binom{b}{a} \binom{a}{a} \binom{b}{b} - 4H \binom{b}{a} \binom{a, b}{a, b} = 0.$$

Now $\binom{b}{a} \binom{a}{a} \binom{b}{b}$ expresses the covariant which we have before called Θ . For giving to U_{mn} the same meaning as before, the symbolical expression expanded may be written $\Sigma U_{mn} U_{pq} U_{rs} u_{mnr} u_{pqrs}$, where each of the suffixes is to receive every value from 1 to 4. But the differential coefficient of H with respect to x_r can easily be seen to be $\Sigma U_{mn} u_{mnr}$, so that Θ is $\Sigma U_{rs} \frac{dH}{dx_r} \frac{dH}{dx_s}$, which is, in another notation, what we have called Θ , p. 510. The covariant S is then reduced to the form $\Theta - 4H\Phi$, where

$$\Phi = \binom{b}{a} \binom{a, b}{a, b} = \Sigma U_{mn} U_{pq, rs} u_{mpq} u_{nrs},$$

where $U_{pq,rs}$ denotes a second minor formed by erasing two rows and two columns from the matrix of the Hessian, a form scarcely so convenient for calculation as that in which I had written the equation, *Philosophical Transactions*, 1860, p. 239. For surfaces of the third degree Clebsch has observed that Φ reduces, as was mentioned before, to $\Sigma U_{mn}H_{mn}$, where H_{mn} denotes a second differential coefficient of H .

596. *The surface S touches the surface H along a certain curve.* Since the equation S is of the form $\Theta - 4H\Phi = 0$, it is sufficient to prove that Θ touches H . But since Θ is got by bordering the matrix of the Hessian with the differentials of the Hessian, $\Theta = 0$ is equivalent to the symbolical expression $\begin{pmatrix} H \\ H \end{pmatrix} = 0$. But, by an identical equation already made use of, we have

$$H \begin{pmatrix} c, H \\ c, H \end{pmatrix} = \begin{pmatrix} H \\ H \end{pmatrix} \begin{pmatrix} c \\ c \end{pmatrix} - \begin{pmatrix} H \\ c \end{pmatrix}^2,$$

where c is arbitrary. Hence Θ touches H along its intersection with the surface of the degree $7n - 15$, $\begin{pmatrix} H \\ c \end{pmatrix}$. It is proved then that S touches H , and that through the curve of contact an infinity of surfaces can pass of the degree $7n - 15$.

597. The equation of the surface generated by the 4-pointic tangents is got by eliminating $x'y'z'w'$ between $U' = 0$, $\Delta U' = 0$, $\Delta^2 U' = 0$, $\Delta^3 U' = 0$; which result, by the ordinary rule, is of the degree

$$n(n-2)(n-3) + 2n(n-1)(n-3) + 3n(n-1)(n-2) = 6n^3 - 22n^2 + 18n.$$

Now this result expresses the locus of points, whose first, second, and third polars intersect on the surface; and, since if a point be anywhere on the surface, its first, second, and third polars intersect in six points on the surface, we infer that the result of elimination must be of the form $U^6 M = 0$. The degree of M is therefore

$$2n(n-3)(3n-2).$$

598. We can in like manner solve problem *B* of article 577. For the point of contact of an inflexional tangent we have $U' = 0$, $\Delta U' = 0$, $\Delta^2 U' = 0$; and if it touch the surface again, we have besides $W' = 0$, where W' is the discriminant of the equation of the degree $n - 3$ in $\lambda : \mu$, which remains when the first three terms of the equation, p. 242, vanish. For W' then we have $\lambda'' = (n + 3)(n - 4)$, $\mu'' = (n - 3)(n - 4)$; and having, as in Art. 577 and last article, $\lambda = 1$, $\mu = n - 1$; $\lambda' = 2$, $\mu' = n - 2$, we find for the degree of Π

$$2(n - 3)(n - 4) + (n - 2)(n + 3)(n - 4) \\ + 2(n - 1)(n + 3)(n - 4) - 2(n + 3)(n - 4).$$

The degree, then, of the surface which passes through the points *B* is $(n - 4)(3n^2 + 5n - 24)$.

The equation of the surface generated by the lines (*b*) which are in one place inflexional and in another ordinary tangents, is found by eliminating $x'y'z'w'$ between the four equations $U' = 0$, $\Delta U' = 0$, $\Delta^2 U' = 0$, $W' = 0$; and, from what has been just stated as to the degree of the variables in each of these equations, the degree of the resultant is

$$n(n - 2)(n - 3)(n - 4) + 2n(n - 1)(n - 3)(n - 4) \\ + n(n - 1)(n - 2)(n + 3)(n - 4) = n(n - 4)(n^3 + 3n^2 - 20n + 18).$$

But it appears, as in the last article, that this resultant contains as a factor U in the power $2(n + 3)(n - 4)$. Dividing out this factor, the degree of the surface (*b*) remains

$$n(n - 3)(n - 4)(n^2 + 6n - 4).$$

599. In order that a tangent at the point $x'y'z'w'$ may elsewhere be an inflexional tangent, we must have $\Delta U' = 0$, (an equation for which $\lambda = 1$, $\mu = n - 1$), and, besides, we must have satisfied the system of two conditions, that the equation of the degree $n - 2$ in $\lambda : \mu$, which remains when the first two terms vanish of the equation, p. 242, may have three roots all equal to each other. If then λ' , μ' ; λ'' , μ'' be the degrees in which the variables enter into these two conditions, the order of the surface which passes through the points (*C*) is, by Art. 473, $\lambda'\mu'' + \lambda''\mu' + (n - 2)\lambda'\lambda''$. But (see *Higher*

Algebra on the order of restricted systems of equations)

$$\lambda'\lambda'' = (n-4)(n^2+n+6), \quad \lambda'\mu'' + \lambda''\mu' = (n-2)(n-4)(n+6).$$

The order of the surface C is, therefore,

$$(n-2)(n-4)(n^2+2n+12).$$

The locus of the points of contact of triple tangent lines is investigated in like manner, except that for the conditions that the equation just considered should have three roots all equal, we substitute the conditions that the same equation should have two distinct pairs of equal roots. But (see *Higher Algebra*) for this system of conditions we have

$$\lambda'\lambda'' = \frac{1}{2}(n-4)(n-5)(n^2+3n+6),$$

$$\lambda'\mu'' + \lambda''\mu' = (n-2)(n-4)(n-5)(n+3).$$

The order of the surface which determines the points (D) is, therefore, $\frac{1}{2}(n-2)(n-4)(n-5)(n^2+5n+12)$.

To find the surface generated by the triple tangents we are to eliminate $x'y'z'w'$ between $U=0$, $\Delta U=0$, and the two conditions, the order of the result being

$$n\mu'\mu'' + n(n-1)(\lambda'\mu'' + \lambda''\mu');$$

but since this result contains as a factor $U^{\lambda'\lambda''}$, in order to find the degree of the surface (c) we have to subtract $n\lambda'\lambda''$ from the number just written. Substituting the values last given for $\lambda'\lambda''$, $\lambda'\mu'' + \lambda''\mu'$; and for $\mu'\mu''$, $\frac{1}{2}(n-2)(n-3)(n-4)(n-5)$, we get, for the order of the surface (c), after dividing by three,

$$\frac{1}{3}n(n-3)(n-4)(n-5)(n^2+3n-2).$$

The following examples are solved by the numbers found in Art. 588 and the last three articles:

Ex. 1. To find the degree of the curve formed by the points of simple intersection of the four-point tangents.

The complete curve of intersection with U of the ruled surface M whose degree is a consists of the curve of points of simple intersection, whose order we call a_1 , and of the curve of fourfold points, whose order we call a_4 . We have manifestly $4a_4 + a_1 = na$. Putting in their values $a = 2n(n-3)(3n-2)$, $a_4 = n(11n-24)$, we find $a_1 = 2n(n-4)(3n^2+n-12)$.

Ex. 2. To find the degree of the curve formed by the points of simple intersection of inflexional tangents which touch the surface again.

The complete curve of intersection of the ruled surface b with U consists of the curve of points at which the tangents are inflexional, of order b_3 ; of that of the ordinary contacts, of order b_2 ; and of that of the simple intersections, of order b_1 . Among these we have the obvious relation $nb = 3b_3 + 2b_2 + b_1$; putting in their values

$$b = n(n-3)(n-4)(n^2+6n-4), \quad b_3 = n(n-4)(3n^2+5n-24),$$

$$b_2 = n(n-2)(n-4)(n^2+2n+12),$$

we find

$$b_1 = n(n-4)(n-5)(n^3+6n^2-n-24).$$

Ex. 3. To find the degree of the curve formed by the points of simple intersection of triple ordinary tangent lines.

Here with a similar notation $nc = 2c_2 + c_1$, whence as

$$c = \frac{1}{3}n(n-3)(n-4)(n-5)(n^2+3n-2) \text{ and } c_2 = \frac{1}{2}n(n-2)(n-4)(n-5)(n^2+5n+12),$$

we have

$$c_1 = \frac{1}{3}n(n-4)(n-5)(n-6)(n^3+3n^2-2n-12).$$

600. There remains to be considered another class of problems, the determination of the number of tangents which satisfy four conditions. The following is an enumeration of these problems. To determine: (α) the number of points at which both the inflexional tangents meet in four consecutive points; (β) the number of lines which meet in five consecutive points; (γ) the number of lines which are doubly inflexional (fourpoint) tangents in one place, and ordinary tangents in another; (δ) of lines inflexional in two places; (ϵ) inflexional in one place and ordinary tangents in two others; (ζ) of lines which touch in four places.

The first of these problems has been solved, as follows, by Clebsch, *Crelle*, vol. LXIII. p. 14, but with an erroneous result, as has been shown by Dr. Schubert, *Math. Ann.*, vol. XI. p. 375. It was proved, Art. 537, that the points of inflexion of the section by the tangent plane at any point on a surface, of the polar cubic of that point, lie on the plane $xH_1 + yH_2 + zH_3 + wH_4$. Let it be required now to find the locus of points $x'y'z'w'$ on a surface such that the line joining $x'y'z'w'$ to one of these points of inflexion may meet any assumed line: this is, in other words, to find the condition that coordinates of the form $\lambda x' + \mu x$, $\lambda y' + \mu y$, &c. (where $xyzw$ is the intersection of the assumed line with the tangent plane) may satisfy the equation of the polar with respect to the Hessian $\Delta H'$, and also of the polar cubic $\Delta^3 U'$. Now

the result of substitution in $\Delta H'$ is $4(n-2)\lambda H' + \mu\Delta H' = 0$. When we substitute in $\Delta^3 U'$, the coefficient of λ^3 vanishes because $x'y'z'w'$ is on the surface, and that of λ^2 vanishes because $xyzw$ is in the tangent plane. The result is then $3(n-2)\lambda\Delta^2 U' + \mu\Delta^3 U' = 0$. Eliminating $\lambda : \mu$ between these two equations, we have $4H'\Delta^3 U' = 3\Delta H'\Delta^2 U'$, where in $\Delta^3 U'$, &c. we are to substitute the coordinates of the intersection of an arbitrary line with the tangent plane; that is to say, the several determinants of the system

$$\left\| \begin{array}{cccc} u_1, & u_2, & u_3, & u_4 \\ \alpha, & \beta, & \gamma, & \delta \\ \alpha', & \beta', & \gamma', & \delta' \end{array} \right\|.$$

By this substitution $\Delta^3 U'$ becomes in $x'y'z'w'$ of the degree $n-3 + 3(n-1) = 4n-6$, and H' being of the degree $4(n-2)$, the equation is of the degree $8n-14$. This, then, is the degree of the locus required.

Now the points at which two fourpoint tangents can be drawn belong to this locus. At any one of these points the doubly inflexional tangents evidently both lie on the polar cubic of that point, and their plane will therefore intersect that cubic in a third line which, as we saw (Art. 537), lies in the plane $\Delta H'$. *Every* point on that line is to be considered as a point of inflexion of the polar cubic; and therefore the plane through the point $x'y'z'w'$ and any arbitrary line *must* pass through a point of inflexion. The points then, whose number we are investigating, and which are evidently double points on the curve US , are counted doubly among the $n(11n-24)(8n-14)$ intersections of the curve US with the locus determined in this article. Let us examine now what other points of the curve US can belong to the locus. At any point on this curve the fourpoint tangent lies in the polar cubic, the section of which by the tangent plane consists of this line and a conic; and since all the points of inflexion of such a system lie in the line, the fourpoint tangent itself is, in this case, the only line joining $x'y'z'w'$ to a point of inflexion. And we have seen, Art. 597, that the number of such tangents which can meet an assumed line is $2n(n-3)(3n-2)$.

Now Schubert first pointed out in applying his method of enumeration to the present problem, as we shall immediately show, that these lines must be counted three times. We have, then, the equation

$$2\alpha + 6n(n-3)(3n-2) = n(11n-24)(8n-14),$$

whence $\alpha = 5n(7n^2 - 28n + 30)$,

which is the solution of the problem proposed.

601. To find the points on a surface where a line can be drawn to meet in five consecutive points, we have to form the condition that the intersection of $\Delta U'$, $\Delta^2 \bar{U}'$, and an arbitrary plane should satisfy $\Delta^4 U'$, as well as $\Delta^3 U'$. Clebsch applied to $\Delta^4 U'$ the same symbolical method of elimination which has been already applied to $\Delta^3 U'$. He succeeded in dividing out the factor c^6 from this result; but in the final form which he found, and for which I refer to his memoir, there remain c symbols in the second degree, and the result being of the degree $14n-30$ in the variables, all that can be concluded from it is that through the points which I have called β (Art. 600) an infinity of surfaces can be drawn of the degree $14n-30$. We can say, therefore, that the number of such points does not exceed $n(11n-24)(14n-30)$.

602. The numerical solution of the problems proposed in Art. 600 accomplished by Dr. Schubert* are derived from the principle of correspondence, which may be stated as follows:

Take any line and consider the correspondence between two planes through it, such that when the first passes through a given point there are p points which determine the second, and when the second passes through a given point q points determine the first, and, moreover, such that there are g pairs of corresponding points whose connecting lines meet an arbitrary right line, then the number of planes of the system which

* *Gött. Nachr.*, Feb. 1876; *Math. Ann.*, x. p. 102, xi. pp. 348-378. See also his *Kalkül der abzählenden Geometrie* (1879), pp. 236-7, 246.

contain a pair of corresponding points is $p + q$; but since of these there are g whose connecting lines meet the arbitrary line, the remaining $p + q - g$ contain coinciding pairs of points of the systems.

We proceed in the first place to establish the value already stated for α . The points of contact of the inflexional tangents which meet an arbitrary given right line l are easily shown as in p. 546, to lie on the intersection of U with a surface of the degree $3n - 4$. This surface meets the flecnodal curve (see notation in Examples, Art. 599) in $(3n - 4) a_4$ points, which consist of the a points of contact of fourpoint tangents which meet the line l , and the $d = (3n - 4) a_4 - a$ flecnodes, whose ordinary inflexional tangent meets l .

Accordingly, we may suppose a pencil of rays in a plane such that to each ray which meets a fourpoint tangent corresponds one which meets the other inflexional tangent at the same flecnode. In such a pencil there will be $a + d = (3n - 4) a_4$ rays meeting as well a fourpoint tangent as also the other inflexional tangent at its flecnode. But these rays include the a_4 rays to the points of the flecnodal curve in the plane of the pencil and $(n - 1) a_4$ which lie in the tangent planes through the vertex of the pencil to U at flecnodes. Thus there remain

$$a + d - a_4 - (n - 1) a_4 = 2(n - 2) a_4$$

rays having the above property. These must be the rays which intersect tangents which have fourfold contact at parabolic points. It is not difficult to show otherwise from Art. 596 by the usual algebraical methods that there are

$$2n(n - 2)(11n - 24)$$

points on a surface of the degree n in which *coincident inflexional tangents have a fourpoint contact*.

The d tangent lines generate a ruled surface intersecting U in a curve of degree nd which consists of the curve of threefold points whose degree is a_4 and of that of ordinary intersections of degree a'_1 . These give

$$a'_1 + 3a_4 = nd.$$

Now applying the principle of correspondence, to each of the a_4 points in a plane correspond $n - 3$ simple intersections of the tangents at them with U and to each of the points a_1' corresponds a single flecnode. But the surface generated by d lines meets any right line in d points through each of which pass $n - 3$ lines connecting a point a_1' with a point a_4 . Hence putting $(n - 3)d$ for g ,

$$a_1' + (n - 3)a_4 - (n - 3)d$$

is the number of coincidences of a flecnode and one of the simple points on the ordinary inflexional tangent. Now we saw that in $2(n - 2)a_4$ fourfold points the two osculating tangents coincide, hence the difference

$$a_1' + (n - 3)a_4 - (n - 3)d - 2(n - 2)a_4 = (8n - 14)a_4 - 3a$$

is double the number of biflecnodal points, as in Art. 600.

603. Next to determine β . A fivepoint contact arises from a fourpoint contact by the coincidence of one additional simple point of intersection. To each of the a_4 points in a plane correspond $n - 4$ simple intersections of the osculating tangents at them with U ; and to each of the points a_1 in the plane corresponds a single fourfold point. Hence the number $p + q$ for these two systems is $(n - 4)a_4 + a_1$. But the surface M meets any right line in a points through each of which passes a line connecting the $n - 4$ points a_1 to the corresponding a_4 ; hence in this case g is $(n - 4)a$. Accordingly, the number of coincidences of a point a_1 with a point a_4 is

$$\beta = (n - 4)a_4 + a_1 - (n - 4)a = (n - 8)a_4 + 4a = 5n(n - 4)(7n - 12).$$

The same number is found from the analogous relation

$$\beta = b_2 + b_3 - b,$$

since the union of a threepoint with an ordinary contact also leads to a fivepoint one.

Again, fourpoint tangents having another ordinary contact may arise either through coincidence of two simple intersections

on a fourpoint tangent, giving in a similar manner by the principle of correspondence

$$\gamma = 2(n-5)a_1 - (n-5)(n-4)a;$$

or, through the coincidence of a simple intersection with the threepoint contact of an inflexional tangent which touches elsewhere, giving

$$\gamma = (n-5)b_3 + b_1 - (n-5)b;$$

or, lastly, by the coincidence of two contacts of a triple ordinary tangent, giving

$$\gamma = 4c_2 - 6c.$$

Each method leads to

$$\gamma = 2n(n-4)(n-5)(3n-5)(n+6).$$

Tangents inflexional in two places arise from the coincidences of an ordinary intersection with an ordinary contact on an inflexional tangent, thus

$$(n-5)b_2 + b_1 - (n-5)b = 2\delta,$$

which gives

$$\delta = \frac{1}{2}n(n-4)(n-5)(n^3 + 3n^2 + 29n - 60).$$

Inflexional tangents having two further ordinary contacts arise from coincidences of two simple intersections among those on inflexional tangents having one other ordinary contact, thus

$$2\varepsilon = 2(n-6)b_1 - (n-5)(n-6)b;$$

or, from coincidence of a simple intersection with one of the ordinary contacts among those on tangents having three such, whence

$$\varepsilon = (n-6)c_2 + 3c_1 - 3(n-6)c$$

$$= \frac{1}{2}n(n-4)(n-5)(n-6)(n^3 + 9n^2 + 20n - 60).$$

Finally, four ordinary contacts arise from coincidence of two simple intersections in the case of a tangent line having three ordinary contacts. Whence

$$4\zeta = 2(n-7)c_1 - (n-6)(n-7)c;$$

$$\zeta = \frac{1}{4}n(n-4)(n-5)(n-6)(n-7)(n^3 + 6n^2 + 7n - 30).$$

CONTACT OF PLANES WITH SURFACES.

604. We can discuss the cases of planes which touch a surface in the same algebraic manner as we have done those of touching lines. Every plane which touches a surface meets it in a section having a double point; but since the equation of a plane includes three constants, a determinate number of tangent planes can be found which will fulfil two additional conditions. And if but one additional condition be given, an infinite series of tangent planes can be found which will satisfy it, those planes enveloping a developable, and their points of contact tracing out a curve on the surface. It may be required either to determine the number of solutions when two additional conditions are given, or to determine the nature of the curves and developables just mentioned, when one additional condition is given. Of the latter class of problems we shall consider but two, the discussion of the case when the plane meets the surface in a section having a cusp, and that when it meets it in a section having two double points. Other cases have been considered by anticipation in the last section, as for example, the case when a plane meets in a section having a double point, one of the tangents at which meets in four consecutive points.

605. Let the coordinates of three points be $x'y'z'w'$, $x''y''z''w''$, $xyzw$; then those of any point on the plane through the points will be $\lambda x' + \mu x'' + \nu x$, $\lambda y' + \mu y'' + \nu y$, &c.; and if we substitute these values for $xyzw$ in the equation of the surface, we shall have the relation which must be satisfied for every point where this plane meets the surface. Let the result of substitution be $[U] = 0$, then $[U]$ may be written

$$\lambda^n U' + \lambda^{n-1} \mu \Delta_{,,} U' + \lambda^{n-1} \nu \Delta U' + \frac{1}{2} \lambda^{n-2} (\mu \Delta_{,,} + \nu \Delta)^2 U' + \&c. = 0,$$

where
$$\Delta_{,,} = x'' \frac{d}{dx'} + y'' \frac{d}{dy'} + z'' \frac{d}{dz'} + w'' \frac{d}{dw'},$$

$$\Delta = x \frac{d}{dx'} + y \frac{d}{dy'} + z \frac{d}{dz'} + w \frac{d}{dw'}.$$

The plane will touch the surface if the discriminant of this equation in λ , μ , ν vanish. If we suppose two of the points

fixed and the third to be variable, then this discriminant will represent all the tangent planes to the surface which can be drawn through the line joining the two fixed points.

We shall suppose the point $x'y'z'w'$ to be on the surface, and the point $x''y''z''w''$ to be taken anywhere on the tangent plane at that point; then we shall have $U' = 0$, $\Delta_{''}U' = 0$, and the discriminant will become divisible by the square of $\Delta U'$. For of the tangent planes which can be drawn to a surface through any tangent line to that surface, two will coincide with the tangent plane at the point of contact of that line. If the tangent plane at $x'y'z'w'$ be a double tangent plane, then the discriminant we are considering, instead of being, as in other cases, only divisible by the square of the equation of the tangent plane, will contain its *cube* as a factor. In order to examine the condition that this may be so, let us, for brevity, write the equation $[U]$ as follows, the coefficients of λ^n , $\lambda^{n-1}\mu$ being supposed to vanish,

$$T\lambda^{n-1}\nu + \frac{1}{2}\lambda^{n-2}(A\mu^2 + 2B\mu\nu + C\nu^2) + \&c. = 0.$$

T represents the tangent plane at the point we are considering, C its polar quadric, while $A = 0$ is the condition that $x''y''z''w''$ should lie on that polar quadric. Now it will be found that the discriminant of $[U]$ is of the form

$$T^2A(B^2 - AC)^2\phi + T^3\psi = 0,$$

where ϕ is the discriminant when T vanishes as well as U' and $\Delta_{''}U'$. In order that the discriminant may be divisible by T^3 , some one of the factors which multiply T^2 must either vanish or be divisible by T .

606. First, then, let A vanish. This only denotes that the point $x''y''z''w''$ lies on the polar quadric of $x'y'z'w'$; or, since it also lies in the tangent plane, that the point $x''y''z''w''$ lies on one of the inflexional tangents at $x'y'z'w'$. Thus we learn that if the class of a surface be p , then of the p tangent planes which can be drawn through an ordinary tangent line two coincide with the tangent plane at its point of contact, and there can be drawn $p - 2$ distinct from that plane; but that if the line be an inflexional tangent, three will coincide

with that tangent plane, and there can be drawn only $p - 3$ distinct from it. If we suppose that $x''y''z''w''$ has not been taken on an inflexional tangent, A will not vanish, and we may set this factor aside as irrelevant to the present discussion.

We may examine, at the same time, the conditions that T should be a factor in $B^2 - AC$, and in ϕ .

The problem which arises in both these cases is the following: Suppose that we are given a function V , whose degrees in $x'y'z'w'$, in $x''y''z''w''$, and in $xyzw$ are respectively (λ, μ, μ) . Suppose that this represents a surface, having as a multiple line of the order μ , the line joining the first two points; or, in other words, that it represents a series of planes through that line; to find the condition that one of these planes should be the tangent plane T , whose degrees are $(n - 1, 0, 1)$. If so, any arbitrary line which meets T will meet V , and therefore if we eliminate between the equations $T = 0$, $V = 0$, and the equations of an arbitrary line

$$ax + by + cz + dw = 0, \quad a'x + b'y + c'z + d'w = 0,$$

the resultant R must vanish. This is of the degree μ in $abcd$, in $a'b'c'd'$, and in $x''y''z''w''$, and of the degree $\mu(n - 1) + \lambda$ in $x'y'z'w'$. But evidently if the assumed right line met the line joining $x'y'z'w'$, $x''y''z''w''$, R would vanish even though T were not a factor in V . The condition ($M = 0$), that the two lines should meet, is of the first degree in all the quantities we are considering; and we see now that R is of the form $M^\mu R'$. R' remains a function of $x'y'z'w'$ alone, and is of the degree $\mu(n - 2) + \lambda$.

607. To apply this to the case we are considering, since the discriminant of $[U]$ represents a series of planes through $x'y'z'w'$, $x''y''z''w''$, it follows that $B^2 - AC$ and ϕ both represent planes through the same line. The first is of the degree $\{2(n - 2), 2, 2\}$, while ϕ is of the degrees $(n - 2)(n^2 - 6)$, $n^3 - 2n^2 + n - 6$, $n^3 - 2n^2 + n - 6$, as appears by subtracting the sum of the degrees of T^2 , A , and $(B^2 - AC)^2$ from the degrees of the discriminant of $[U]$, which is of the degree $n(n - 1)^2$ in all the variables. It follows then from the last article that the condition ($H = 0$) that T should be a factor in $B^2 - AC$

is of the degree $4(n-2)$, and the condition $(K=0)$ that T should be a factor in ϕ is of the degree $(n-2)(n^3-n^2+n-12)$. At all points then of the intersection of U and H the tangent plane must be considered double. H is no other than the Hessian; the tangent plane at every point of the curve UH meets the surface in a section having a cusp, and is to be counted as double (Art. 269). The curve UK is the locus of points of contact of planes which touch the surface in two distinct points (Art. 286). It is called by Prof. Cayley the node-couple curve.

608. Let us consider next the series of tangent planes which touch along the curve UH . They form a developable whose degree is $\rho = 2n(n-2)(3n-4)$, Ex. 3, Art. 576. The class of the same developable, or the number of planes of the system which can be drawn through an assigned point, is $\nu = 4n(n-1)(n-2)$. For the points of contact are evidently the intersections of the curve UH with the first polar of the assigned point. We can also determine the number of stationary planes of the system. If the equation of U , the plane z being the tangent plane at any point on the curve UH , be $z + y^2 + u_3 + \&c. = 0$, it is easy to show that the direction of the tangent to UH is in the line $\frac{d^2u_3}{dx^2} = 0$. Now the tangent planes to U are the same at two consecutive points proceeding along the inflexional tangent y . If then u_3 do not contain any term x^3 (that is to say, if the inflexional tangent meet the surface in four consecutive points), the direction of the tangent to the curve UH is the same as that of the inflexional tangent; and the tangent planes at two consecutive points on the curve UH will be the same. The number of stationary tangent planes is then equal to the number of intersections of the curve UH with the surface S . But since the curve touches the surface, Art. 596, we have

$$\alpha = 2n(n-2)(11n-24).$$

From these data all the singularities of the developable which touches along UH can be determined, ρ being the r , ν the n ,

and α the same as at p. 292, we have

$$\mu = n(n-2)(28n-60), \quad \nu = 4n(n-1)(n-2), \quad \rho = 2n(n-2)(3n-4),$$

$$\alpha = 2n(n-2)(11n-24), \quad \beta = n(n-2)(70n-160);$$

$$2g = n(n-2)(16n^4 - 64n^3 + 80n^2 - 108n + 156),$$

$$2h = n(n-2)(784n^4 - 4928n^3 + 10320n^2 - 7444n + 548).$$

The developable here considered answers to a cuspidal line on the reciprocal surface, whose singularities are got by interchanging μ and ν , α and β , &c. in the above formulæ.

The class of the developable touching along UK , which is the degree of a double curve on the reciprocal surface, is seen as above to be $n(n-1)(n-2)(n^3 - n^2 + n - 12)$. Its other singularities will be obtained in the next section, where we shall also determine the number of solutions in some cases where a tangent plane is required to fulfil two other conditions.

THEORY OF RECIPROCAL SURFACES.

609. Understanding by ordinary singularities of a surface, those which in general exist either on the surface or its reciprocal, we may make the following enumeration of them. A surface may have a double curve of degree b and a cuspidal of degree c . The tangent cone, determined as in Art. 277, includes doubly the cone standing on the double curve and trebly that standing on the cuspidal curve, so that if the degree of the tangent cone proper be a , we have

$$a + 2b + 3c = n(n-1).$$

The class of the cone a is the same as the degree of the reciprocal. Let a have δ double and κ cuspidal edges. Let b have k apparent double points, and t triple points which are also triple points on the surface; and let c have h apparent double points. Let the curves b and c intersect in γ points, which are stationary points on the former, in β which are stationary points on the latter, and in i which are singular points on neither. Let the curve of contact a meet b in ρ points, and c in σ points. Let the same letters accented denote singularities of the reciprocal surface.

610. We saw (Art. 279) that the points where the curve of contact meets $\Delta^2 U$, give rise to cuspidal edges on the tangent cone. But when the line of contact consists of the complex curve $a + 2b + 3c$, and when we want to determine the number of cuspidal edges on the cone a , the points where b and c meet $\Delta^2 U$ are plainly irrelevant to the question. Neither shall we have cuspidal edges answering to all the points where a meets $\Delta^2 U$, since a common edge of the cones a and c is to be regarded as a cuspidal edge of the complex cone, although not so on either cone considered separately. The following formulæ contain an analysis of the intersections of each of the curves a, b, c , with the surface $\Delta^2 U$,

$$\left. \begin{aligned} a(n-2) &= \kappa + \rho + 2\sigma \\ b(n-2) &= \rho + 2\beta + 3\gamma + 3t \\ c(n-2) &= 2\sigma + 4\beta + \gamma \end{aligned} \right\} \dots\dots\dots (A).$$

The reader can see without difficulty that the points indicated in these formulæ are included in the intersections of $\Delta^2 U$ with a, b, c , respectively; but it is not so easy to see the reason for the numerical multipliers which are used in the formulæ. Although it is probably not impossible to account for these constants by *a priori* reasoning, I prefer to explain the method by which I was led to them inductively.*

611. We know that the reciprocal of a cubic is a surface of the twelfth degree, which has a cuspidal edge of the twenty-fourth degree, since its equation is of the form $64S^3 = T^2$, where S is of the fourth and T of the sixth degree (p. 485). Each of the twenty-seven lines (p. 497) on the surface answers to a double line on the reciprocal. The proper tangent cone, being the reciprocal of a plane section of the cubic, is of the sixth degree, and has nine cuspidal edges. Thus we have $a' = 6, b' = 27, c' = 24, n' = 12, a' + 2b' + 3c' = 12.11$. The

* The first attempt to explain the effect of nodal and cuspidal lines on the degree of the reciprocal surface was made in the year 1847, in two papers which I contributed to the *Cambridge and Dublin Mathematical Journal*, vol. II. p. 65, and IV. p. 188. It was not till the close of the year 1849, however, that the discovery of the twenty-seven right lines on a cubic, by enabling me to form a clear conception of the nature of the reciprocal of a cubic, led me to the theory in the form here explained. Some few additional details will be found in a memoir which I contributed to the *Transactions of the Royal Irish Academy*, vol. XXIII. p. 461.

intersections of the curves c' and b' with the line of contact of a cone a' through any assumed point, answer to tangent planes to the original cubic, whose points of contact are the intersections of an assumed plane with the parabolic curve UH , and with the twenty-seven lines. Consequently there are twelve points σ' and twenty-seven points ρ' ; one of the latter points lying on each of the lines, of which the nodal line of the reciprocal surface is made up.

Now the sixty points of intersection of the curve a' with the second polar, which is of the tenth degree, consist of the nine points κ' , the twenty-seven points ρ' , and the twelve points σ' . It is manifest, then, that the last points must count double, since we cannot satisfy an equation of the form $9a + 27b + 12c = 60$, by any integer values of a , b , c except 1, 1, 2. Thus we are led to the first of the equations (A).

Consider now the points where any of the twenty-seven lines b meets the same surface of the tenth order. The points β' answer to the points where the twenty-seven right lines touch the parabolic curve; and there are two such points on each of these lines (Art. 287). There are also five points t on each of these lines (Art. 530), and we have just seen that there is one point ρ . Now, since the equation $a + 2b + 5c = 10$, can have only the systems of integer solutions (1, 2, 1) or (3, 1, 1), the ten points of intersection of one of the lines with the second polar must be made up either $\rho' + 2\beta' + t'$, or $3\rho' + \beta' + t'$, and the latter form is manifestly to be rejected. But, considering the curve b' as made up of the twenty-seven lines, the points t' occur each on three of these lines: we are then led to the formula $b'(n' - 2) = \rho' + 2\beta' + 3t'$.

The example we are considering does not enable us to determine the coefficient of γ in the second formula A , because there are no points γ on the reciprocal of a cubic.

Lastly, the two hundred and forty points in which the curve c meets the second polar are made up of the twelve points σ' , and the fifty-four points β' . Now the equation $12a + 54b = 240$ only admits of the systems of integer solutions (11, 2), or (2, 4), and the latter is manifestly to be preferred. In this way we are led to assign all the coefficients of the equations (A) except those of γ .

612. Let us now examine in the same way the reciprocal of a surface of the n^{th} order, which has no multiple points. We have then $n' = n(n-1)^2$, $n' - 2 = (n-2)(n^2+1)$, $a' = n(n-1)$; and for the nodal and cuspidal curves we have (Art 286)

$$b' = \frac{1}{2}n(n-1)(n-2)(n^3 - n^2 + n - 12), \quad c' = 4n(n-1)(n-2).$$

The number of cuspidal edges on the tangent cone to the reciprocal, answering to the number of points of inflexion on a plane section of the original, gives us $\kappa' = 3n(n-2)$. The points ρ' and σ' answer to the points of intersection of an assumed plane with the curves UK and UH (Art. 607); hence $\rho' = n(n-2)(n^3 - n^2 + n - 12)$, $\sigma' = 4n(n-2)$. Substitute these values in the formula $a'(n'-2) = \kappa' + \rho' + 2\sigma'$, and it is satisfied identically, thus verifying the first of formulæ (A).

We shall next apply the same case to the third of the formulæ (A). It was proved (Art. 608) that the number of points β' is $2n(n-2)(11n-24)$. Now the intersections of the nodal and cuspidal curves on the reciprocal surface answer to the planes which touch at the points of meeting of the curves UH , and UK on the original surface. If a plane meet the surface in a section having an ordinary double point and a cusp, since from the mere fact of its touching at the latter point it is a double tangent plane, it belongs in two ways to the system which touches along UK ; or, in other words, it is a stationary plane of that system. And, since evidently the points β' are to be included in the intersections of the nodal and cuspidal curve, the points U , H , K must either answer to points β' or points γ' . Assuming, as it is natural to do, that the points β count double among the intersections of UHK , we have

$$\begin{aligned} \gamma' &= n \{4(n-2)\} \cdot \{(n-2)(n^3 - n^2 + n - 12)\} - 4n(n-2)(11n-24) \\ &= 4n(n-2)(n-3)(n^3 + 3n - 16). \end{aligned}$$

But if we substitute the values already found for c' , n' , σ' , β' , the quantity $c'(n'-2) - 2\sigma' - 4\beta'$ becomes also equal to the value just assigned for γ' . Thus the third of the formulæ A is verified. It would have been sufficient to assume that the points β count μ times and that the points γ count μ times among the intersections of UHK , and to have written that

formula provisionally $c(n-2) = 2\sigma + \mu\beta + \lambda\gamma$, when, proceeding as above, it would have been found that the formula could not be satisfied unless $\lambda = 1$, $\mu = 4$.

It only remains to examine the second of the formulæ (A). We have just assigned the values of all the quantities involved in it except t' . Substituting then these values, we find that the number of triple tangent planes to a surface of the n^{th} degree is given by the formula

$$6t' = n(n-2)(n^7 - 4n^6 + 7n^5 - 45n^4 + 114n^3 - 111n^2 + 548n - 960),$$

which verifies, as it gives $t' = 45$ when $n = 3$.

613. It was proved (Art. 279) that the points of contact of those edges of the tangent cone which touch in two distinct points lie on a certain surface of the degree $(n-2)(n-3)$. Now when the tangent cone is, as before, a complex cone $a + 2b + 3c$, it is evident that among these double tangents will be included those common edges of the cones ab , which meet the curves a , b in distinct points; and, similarly, for the other pairs of cones. If then we denote by $[ab]$ the number of the apparent intersections of the curves a and b , that is to say, the number of points in which these curves seen from any point of space seem to intersect, though they do not actually do so, the following formulæ will contain an analysis of the intersections of a , b , c , with the surface of the degree $(n-2)(n-3)$:

$$a(n-2)(n-3) = 2\delta + 3[ac] + 2[ab],$$

$$b(n-2)(n-3) = 4k + [ab] + 3[bc],$$

$$c(n-2)(n-3) = 6h + [ac] + 2[bc].$$

Now the number of apparent intersections of two curves is at once deduced from that of their actual intersections. For if cones be described having a common vertex and standing on the two curves, their common edges must answer either to apparent or actual intersections. Hence,

$$*[ab] = ab - 2\rho, \quad [ac] = ac - 3\sigma, \quad [bc] = bc - 3\beta - 2\gamma - i.$$

* If the surface have a nodal curve, but no cuspidal, there will still be a determinate number i of cuspidal points on the nodal curve, and the above equation receives the modification $[ab] = ab - 2\rho - i$. In determining, however, the degree of the reciprocal surface the quantity $[ab]$ is eliminated.

Substituting these values, we have

$$\left. \begin{aligned} a(n-2)(n-3) &= 2\delta + 2ab + 3ac - 4\rho - 9\sigma \\ b(n-2)(n-3) &= 4k + ab + 3bc - 9\beta - 6\gamma - 3i - 2\rho \\ c(n-2)(n-3) &= 6h + ac + 2bc - 6\beta - 4\gamma - 2i - 3\sigma \end{aligned} \right\} \dots(B).$$

The first and third of these equations are satisfied identically if we substitute for $\beta, \gamma, \rho, \sigma, \&c.$, the values used in the last article, to which we are to add $2\delta' = n(n-2)(n^2-9)$, $i' = 0$, and the value of h' got from (Art. 608),

$$2h' = n(n-2)(16n^4 - 64n^3 + 80n^2 - 108n + 156).$$

The second equation enables us to determine k' by the equation

$$8k' = n(n-2)(n^{10} - 6n^9 + 16n^8 - 54n^7 + 164n^6 - 288n^5 + 547n^4 - 1058n^3 + 1068n^2 - 1214n + 1464);$$

from this expression the rank of the developable, of which b' is the cuspidal edge, can be calculated by the formula

$$R' = b'^2 - b' - 2k' - 6t' - 3\gamma'.$$

Putting in the values already obtained for these quantities we find

$$R' = n(n-2)(n-3)(n^2 + 2n - 4).$$

This is then the rank of the developable formed by the planes which have double contact with the given surface.

614. From formulæ A and B we can calculate the diminution in the degree of the reciprocal caused by the singularities on the original surface enumerated Art. 609. If the degree of a cone diminish from m to $m-l$, that of its reciprocal diminishes from $m(m-1)$ to $(m-l)(m-l-1)$; that is to say, is reduced by $l(2m-l-1)$. Now the tangent cone to a surface is in general of the degree $n(n-1)$, and we have seen that when the surface has nodal and cuspidal lines this degree is reduced by $2b+3c$. There is a consequent diminution in the degree of the reciprocal surface

$$D = (2b + 3c)(2n^2 - 2n - 2b - 3c - 1).$$

But the existence of nodal and cuspidal curves on the surface causes also a diminution in the number of double and cuspidal edges in the tangent cone. From the diminution in the degree

of the reciprocal surface just given must be subtracted twice the diminution of the number of double edges, and three times that of the cuspidal edges. Now, from formulæ *A*, we have

$$\kappa = (a - b - c)(n - 2) + 6\beta + 4\gamma + 3t.$$

But, since if the surface had no multiple lines, the number of cuspidal edges on the tangent cone would be $(a + 2b + 3c)(n - 2)$, the diminution of the number of cuspidal edges is

$$K = (3b + 4c)(n - 2) - 6\beta - 4\gamma - 3t.$$

Again, from the first system of equations in last article, we have

$$(a - 2b - 3c)(n - 2)(n - 3) = 2\delta - 8k - 18h - 12[bc],$$

and putting for $[bc]$ its value

$$2\delta = (a - 2b - 3c)(n - 2)(n - 3) + 8k + 18h + 12bc - 36\beta - 24\gamma - 12i.$$

But if the surface had no multiple lines, 2δ would

$$= (a + 2b + 3c)(n - 2)(n - 3).$$

The diminution then in the number of double edges is given by the formula

$$2H = (4b + 6c)(n - 2)(n - 3) - 8k - 18h - 12bc + 36\beta + 24\gamma + 12i.$$

Thus the entire diminution in the degree of the reciprocal $D - 3K - 2H$ is, when reduced,

$$n(7b + 12c) - 4b^2 - 9c^2 - 8b - 15c + 8k + 18h - 18\beta - 12\gamma - 12i + 9t.$$

615. The formulæ *B*, reduced by the formula

$$a + 2b + 3c = n(n - 1),$$

become

$$\left. \begin{aligned} a(-4n + 6) &= 2\delta - a^2 - 4\rho - 9\sigma \\ b(-4n + 6) &= 4k - 2b^2 - 9\beta - 6\gamma - 3i - 2\rho \\ c(-4n + 6) &= 6h - 3c^2 - 6\beta - 4\gamma - 2i - 3\sigma \end{aligned} \right\} \dots (C).$$

To each of these formulæ we add now four times the corresponding formula *A*; and we simplify the results by writing for $a^2 - a - 2\delta - 3\kappa$, n' the degree of the reciprocal surface, by giving R the same meaning as in Art. 613, and by writing for $c^2 - c - 2h - 3\beta$, S the order of the developable generated by the curve c ; we thus obtain the formulæ in the more convenient shape,

$$\left. \begin{aligned} n' - a &= \kappa - \sigma \\ 2R &= 2\rho - \beta - 3i \\ 3S + c &= \beta + 5\sigma - 2i \end{aligned} \right\} \dots\dots\dots (D).$$

From the first of equations A and D we may also obtain the equation

$$(n-1)a = n' + \rho + 3\sigma,$$

the truth of which may be seen from the consideration that a , the curve of simple contact from any one point, intersects the first polar of any other point, either in the n' points of contact of tangent planes passing through the line joining the two points, or else in the ρ points where a meets b , or the σ points where it meets c , since every first polar passes through the curves b, c .

616. The effect of multiple lines in diminishing the degree of the reciprocal may be otherwise investigated. The points of contact of tangent planes, which can be drawn through a given line, are the intersections with the surface of the curve of degree $(n-1)^2$, which is the intersection of the first polars of any two points on the line. Now, let us first consider the case when the surface has only an ordinary double curve of degree b . The first polars of the two points pass each through this curve, so that their intersection breaks up into this curve b and a complementary curve d . Now, in looking for the points of contact of tangent planes through the given line, in the first place, instead of taking the points where the complex curve $b+d$ meets the surface, we are only to take those in which d meets it, which causes a reduction bn in the degree of the reciprocal. But, further, we are not to take all the points in which d meets the surface: those in which it meets the curve b have to be rejected; they are in number $2b(n-2) - r$ (Art. 346) where r is the rank of the system b . Now, these points consist of the r points on the curve b , the tangents at which meet the line through which we are seeking to draw tangent planes to the given surface, and of $2b(n-2) - 2r$ points at which the two polar surfaces touch. These last are cuspidal points on the double curve b ; that is to say, points at which the two tangent planes coincide, and they count for three in the intersections of the curve d with the given surface, since the three surfaces touch at these points; while the r points being ordinary points on the double line

only count for two. The total reduction then is

$$nb + 2r + 3 \{2b(n-2) - 2r\} = b(7n-12) - 4r,$$

which agrees with the preceding theory.

If the curve b , instead of being merely a double curve, were a multiple curve on the surface of the order p of multiplicity, I have found for the reduction of the degree of the reciprocal (see *Transactions of the Royal Irish Academy*, vol. XXIII. p. 485)

$$b(p-1)(3p+1)n - 2bp(p^2-1) - p^2(p-1)r,$$

for the reduction in the number of cuspidal edges of the cone of simple contact

$$b\{3(p-1)^2n - p(p-1)(2p-1)\} - p(p-1)(p-2)r,$$

and for twice the reduction in the number of its double edges

$$2bp(p-1)n^2 - b(p-1)(14p-8)n$$

$$+ bp(p-1)(8p-2) - p^2(p-1)^2b^2 + p(p-1)(4p-6)r.*$$

617. The theory just explained ought to enable us to account for the fact that the degree of the reciprocal of a developable reduces to nothing. This application of the theory both verifies the theory itself and enables us to determine some singularities of developables not given, Arts. 325, &c. We use the notation of the section referred to. The tangent cone to a developable consists of n planes; it has therefore no cuspidal edges and $\frac{1}{2}n(n-1)$ double edges. The simple line of contact (α) consists of n lines of the system each of which meets the cuspidal edge m once, and the double line x in $(r-4)$ points (see Art. 330). The lines m and x intersect at the α points of contact of the stationary planes of the system; for since there three consecutive lines of the system are in the same plane, the intersection of the first and third gives a point on the line x .†

* The method of this article is not applied to the case where the surface has a cuspidal curve in the Memoir from which I cite, and I have not since attempted to repair the omission.

† It is only on account of their occurrence in this example that I was led to include the points i in the theory.

We have then the following table. The letters on the left-hand side of the equations refer to the notation of this Chapter and those on the right to that of Chapter XII.:

$$n = r, \quad a = n, \quad b = x, \quad c = m;$$

$\rho = n(r - 4), \quad \sigma = n, \quad \kappa = 0, \quad \beta = \beta, \quad h = h, \quad i = \alpha; \quad n' = 0, \quad S = r;$
and the quantities t, γ, R remain to be determined. On substituting these values in formulæ A and D , Arts. 610, 615, we get the system of equations

$$\left. \begin{aligned} n(r - 2) &= n\{2 + (r - 4)\}, \\ x(r - 2) &= n(r - 4) + 2\beta + 3\gamma + 3t, \\ m(r - 2) &= 2n + 4\beta + \gamma, \\ -n &= -n, \\ 2R &= 2n(r - 4) - \beta - 3\alpha, \\ 3r + m &= 5n - 2\alpha + \beta, \end{aligned} \right\} \dots\dots(E).$$

The first and fourth of these equations are identically true, and the sixth is verified by the equations of Arts. 326, 327. The three remaining equations determine the three quantities, whose values have not before been given, viz. t the number of "points on three lines" of the system; γ the number of points of the system through each of which passes another non-consecutive line of the system; and R the rank of the developable of which x is the cuspidal edge. These quantities being determined, we can by an interchange of letters write down the reciprocal singularities, the number of "planes through three lines," &c.

Ex. 1. Let it be required to apply the preceding theory to the case considered Art. 329. Call k_1 the number of apparent double points on b , Art. 609, &c.

Ans. $\gamma = 6(k - 3)(k - 4), \quad 3t = 4(k - 3)(k - 4)(k - 5),$

$$k_1 = (k - 3)(2k^3 - 18k^2 + 57k - 65), \quad R = 2(k - 1)(k - 3).$$

And for the reciprocal singularities

$$\gamma' = 2(k - 2)(k - 3), \quad 3t' = 4(k - 2)(k - 3)(k - 4),$$

$$k_1' = (k - 2)(k - 3)(2k^2 - 10k + 11), \quad R' = 6(k - 3)^2.$$

Ex. 2. Two surfaces intersect the sum of whose degrees is p and their product q .

Ans. $\gamma = q(pq - 2q - 6q + 16).$

This follows from the table, p. 309, but can be proved directly by the method used (Arts. 343, 471), see *Transactions of the Royal Irish Academy*, vol. XXIII. p. 469,

$$R = 3q(p - 2)\{q(p - 3) - 1\}.$$

Ex. 3. To find the singularities of the developable generated by a line resting twice on a given curve. The planes of this system are evidently "planes through two lines" of the original system: the class of the system is therefore y ; and the other singularities are the reciprocals of those of the system whose cuspidal edge is x , calculated in this article. Thus the rank of the system, or the order of the developable, is given by the formula

$$2R' = 2m(r - 4) - \alpha - 3\beta.$$

618. Since the degree of the reciprocal of a ruled surface reduces always to the degree of the original surface (p. 105) the theory of reciprocal surfaces ought to account for this reduction. I have not obtained this explanation for ruled surfaces in general, but some particular cases are examined and accounted for in the Memoir in the *Transactions of the Royal Irish Academy* already cited. I give only one example here. Let the equation of the surface be derived, as in Art. 464, from the elimination of t between the equations

$$at^k + bt^{k-1} + \&c. = 0, \quad a't^l + b't^{l-1} + \&c. = 0,$$

where $a, a', \&c.$ are any linear functions of the coordinates. Then if we write $k + l = \mu$, the degree of the surface is μ , having a double line of the order $\frac{1}{2}(\mu - 1)(\mu - 2)$, on which are $\frac{1}{6}(\mu - 2)(\mu - 3)(\mu - 4)$ triple points. For the apparent double points of this double curve we have

$$2k = \frac{1}{4}(\mu - 2)(\mu - 3)(\mu^2 - 5\mu + 8);$$

and the developable generated by that curve is of the order $2(\mu - 2)(\mu - 3)$. It will be found then that we have

$$a = 2(\mu - 1), \quad b = \frac{1}{2}(\mu - 1)(\mu - 2), \quad \kappa = 3(\mu - 2), \quad \delta = 2(\mu - 2)(\mu - 3)$$

values which agree with what was proved, Art. 614, that the number of cuspidal edges in the tangent cone is diminished by $3b(\mu - 2) - 3t$, while the double edges are diminished by $2b(\mu - 2)(\mu - 3) - 4k$. In verifying the separate formulæ B the remark, note, Art. 613, must be attended to.

I have also tried to apply this theory to the surface, which is the envelope of the plane $a\alpha^n + b\beta^n + c\gamma^n + \&c.$, where α, β, γ are arbitrary parameters, but have only succeeded when $n = 3$. We have here (see Art. 523, Ex. 2) $n = 12, n' = 9, a = 18$; b being the number of cubics with two double points (that is, of systems of conic and line) which can be drawn through seven points, is 21; c is 24, since the cuspidal curve is the intersection

of the surfaces of the fourth and sixth order represented by the two invariants of the given cubic equation; for the same reason $h = 180$ and $S = c^2 - c - 2h - 3\beta = 192 - 3\beta$; t being the number of cubics with three double points (that is, of systems of three right lines) which can be drawn through six points, is 15. The reciprocal of envelopes of the kind we are considering can have no cuspidal curve. This consideration gives $\kappa = 27$, $\delta = 108$. The formulæ A and D then give

$$\begin{aligned} 180 &= 27 + \rho + 2\sigma, & 210 &= \rho + 2\beta + 3\gamma + 45, & 240 &= 2\sigma + 4\beta + \gamma, \\ 9 - 18 &= 27 - \sigma, & 2R &= 2\rho - \beta, & 3(192 - 3\beta) + 24 &= 5\sigma + \beta. \end{aligned}$$

These six equations determine the five unknowns and give one equation of verification. We have

$$\rho = 81, \quad \sigma = 36, \quad \beta = 42, \quad \gamma = 0, \quad R = 60.$$

619. It may be mentioned here that the Hessian of a ruled surface meets the surface only in its multiple lines, and in the generators each of which is intersected by one consecutive. For, Art. 463, if xy be any generator, that part of the equation which is only of the first degree in x and y is of the form $(xz + yw)\phi$. Then, Art. 287, the part of the Hessian which does not contain x and y is

$$\left\{ \left(\phi + z \frac{d\phi}{dz} \right) \left(\phi + w \frac{d\phi}{dw} \right) - wz \frac{d\phi}{dz} \frac{d\phi}{dw} \right\}^2,$$

which reduces to ϕ^4 . But xy intersects ϕ only in the points where it meets multiple lines. But if the equation be of the form $ux + vy^2$ (Art. 287) the Hessian passes through xy . Thus in the case considered in the last article, the number of lines which meet one consecutive are easily seen to be $2(\mu - 2)$; and the curve UH , whose order is $4\mu(\mu - 2)$, consists of these lines, each counting for two and therefore equivalent to $4(\mu - 2)$ in the intersection, together with the double line equivalent to $4(\mu - 1)(\mu - 2)$. Again, if a surface have a multiple line whose degree is m , and order of multiplicity p , it will be a line of order $4(p - 1)$ on the Hessian, and will be equivalent to $4mp(p - 1)$ on the curve UH . Now the ruled surface generated by a line resting on two right lines and on a curve m (which is supposed to have no actual multiple point) is of

order $2m$, having the right lines as multiples of order m , having $\frac{1}{2}m(m-1) + h$ double generators, and $2r$ generators which meet a consecutive one. Comparing then the order of the curve UH with the sum of the orders of the curves of which it is made up, we have

$$16m(m-1) = 8m(m-1) + 4m(m-1) + 8h + 4r,$$

an equation which is identically true.

ADDITION BY PROF. CAYLEY ON THE THEORY OF RECIPROCAL SURFACES.

620. In further developing the theory of reciprocal surfaces it has been found necessary to take account of other singularities, some of which are as yet only imperfectly understood. It will be convenient to give the following complete list of the quantities which present themselves :

- n , order of the surface.
- a , order of the tangent cone drawn from any point to the surface.
- δ , number of nodal edges of the cone.
- κ , number of its cuspidal edges.
- ρ , class of nodal torse.
- σ , class of cuspidal torse.
- b , order of nodal curve.
- k , number of its apparent double points.
- f , number of its actual double points.
- t , number of its triple points.
- j , number of its pinch-points.
- q , its class.
- c , order of cuspidal curve.
- h , number of its apparent double points.
- θ , number of its points of an unexplained singularity.
- χ , number of its close-points.
- ω , number of its off-points.
- r , its class.
- β , number of intersections of nodal and cuspidal curves, stationary points on cuspidal curve.

- γ , number of intersections, stationary points on nodal curve.
 i , number of intersections, not stationary points on either curve.
 C , number of enicnodes of surface.
 B , number of binodes.

And corresponding reciprocally to these :

- n' , class of surface.
 a' , class of section by arbitrary plane.
 δ' , number of double tangents of section.
 κ' , number of its inflexions.
 ρ' , order of node-couple curve.
 σ' , order of spinode curve.
 b' , class of node-couple torse.
 k' , number of its apparent double planes.
 f' , number of its actual double planes.
 t' , number of its triple planes.
 j'' , number of its pinch-planes.
 q' , its order.
 c' , class of spinode torse.
 h' , number of its apparent double planes.
 θ' , number of its planes of a certain unexplained singularity.
 χ' , number of its close-planes.
 ω' , number of its off-planes.
 r' , its order.
 β' , number of common planes of node-couple and spinode torse, stationary planes of spinode torse.
 γ' , number of common planes, stationary planes of node-couple torse.
 i' , number of common planes, not stationary planes of either torse.
 C' , number of cnictropes of surface.
 B' , number of its bitropes.

In all 46 quantities.

621. In part explanation, observe that the definitions of ρ and σ agree with those given, Art. 609: the nodal torse is the torse enveloped by the tangent planes along the nodal curve; if

the nodal curve meets the curve of contact a , then a tangent plane of the nodal torse passes through the arbitrary point, that is, ρ will be the number of these planes which pass through the arbitrary point, viz. the class of the torse. So also the cuspidal torse is the torse enveloped by the tangent planes along the cuspidal curve; and σ will be the number of these tangent planes which pass through the arbitrary point, viz. it will be the class of the torse. Again, as regards ρ' and σ' : the node-couple torse is the envelope of the bitangent planes of the surface, and the node-couple curve is the locus of the points of contact of these planes; similarly, the spinode torse is the envelope of the *parabolic* planes of the surface, and the spinode curve is the locus of the points of contact of these planes; viz. it is the curve UH of intersection of the surface and its Hessian; the two curves are the reciprocals of the nodal and cuspidal torsos respectively, and the definitions of ρ' , σ' correspond to those of ρ and σ .

622. In regard to the nodal curve b , we consider k the number of its apparent double points (excluding actual double points); f the number of its actual double points (each of these is a point of contact of two sheets of the surface, and there is thus at the point a single tangent plane, viz. this is a plane f' , and we thus have $f' = f$); t the number of its triple points; and j the number of its pinch-points—these last are not singular points of the nodal curve *per se*, but are singular in regard to the curve as nodal curve of the surface; viz. a pinch-point is a point at which the two tangent planes are coincident. The curve is considered as not having any stationary points other than the points γ , which lie also on the cuspidal curve; and the expression for the class consequently is $q = b^2 - b - 2k - 2f - 3\gamma - 6t$.

623. In regard to the cuspidal curve c we consider h the number of its apparent double points; and upon the curve, not singular points in regard to the curve *per se*, but only in regard to it as cuspidal curve of the surface, certain points in number θ , χ , ω respectively. The curve is considered as not having any actual double or other multiple points, and as not having any stationary points except the points β , which lie also

on the nodal curve; and the expression for the class consequently is $r = c^2 - c - 2h - 3\beta$.

624. The points γ are points where the cuspidal curve with the two sheets (or say rather half-sheets) belonging to it are intersected by another sheet of the surface; the curve of intersection with such other sheet belonging to the nodal curve of the surface has evidently a stationary (cuspidal) point at the point of intersection.

As to the points β , to facilitate the conception, imagine the cuspidal curve to be a semi-cubical parabola, and the nodal curve a right line (not in the plane of the curve) passing through the cusp; then intersecting the two curves by a series of parallel planes, any plane which is, say, above the cusp, meets the parabola in two real points and the line in one real point, and the section of the surface is a curve with two real cusps and a real node; as the plane approaches the cusp, these approach together, and, when the plane passes through the cusp, unite into a singular point in the nature of a triple point (= node + two cusps); and when the plane passes below the cusp, the two cusps of the section become imaginary, and the nodal line changes from crunodal to acnodal.

625. At a point i the nodal curve crosses the cuspidal curve, being on the side away from the two half-sheets of the surface acnodal, and on the side of the two half-sheets crunodal, viz. the two half-sheets intersect each other along this portion of the nodal curve. There is at the point a single tangent plane, which is a plane i'' ; and we thus have $i = i''$.

626. As already mentioned, a cnic-node C is a point where, instead of a tangent plane, we have a tangent quadri-cone; and at a binode B the quadri-cone degenerates into a pair of planes. A cnictrope C' is a plane touching the surface along a conic; in the case of a bitrope B' , the conic degenerates into a flat conic or pair of points.

627. In the original formulæ for $a(n-2)$, $b(n-2)$, $c(n-2)$, we have to write $\kappa - B$ instead of κ , and the formulæ are further

modified by reason of the singularities θ and ω . So in the original formulæ for $a(n-2)(n-3)$, $b(n-2)(n-3)$, $c(n-2)(n-3)$, we have instead of δ to write $\delta - C - 3\omega$; and to substitute new expressions for $[ab]$, $[ac]$, $[bc]$, viz. these are

$$[ab] = ab - 2\rho - j,$$

$$[ac] = ac - 3\sigma - \chi - \omega,$$

$$[bc] = bc - 3\beta - 2\gamma - i.$$

The whole series of equations thus is

$$(1) \quad a' = a.$$

$$(2) \quad f' = f.$$

$$(3) \quad i' = i.$$

$$(4) \quad a = n(n-1) - 2b - 3c.$$

$$(5) \quad \kappa' = 3n(n-2) - 6b - 8c.$$

$$(6) \quad \delta' = \frac{1}{2}n(n-2)(n^2-9) - (n^2-n-6)(2b+3c) \\ + 2b(b-1) + 6bc + \frac{3}{2}c(c-1).$$

$$(7) \quad a(n-2) = \kappa - B + \rho + 2\sigma + 3\omega.$$

$$(8) \quad b(n-2) = \rho + 2\beta + 3\gamma + 3t.$$

$$(9) \quad c(n-2) = 2\sigma + 4\beta + \gamma + \theta + \omega.$$

$$(10) \quad a(n-2)(n-3) \\ = 2(\delta - C - 3\omega) + 3(ac - 3\sigma - \chi - 3\omega) + 2(ab - 2\rho - j).$$

$$(11) \quad b(n-2)(n-3) \\ = 4k + (ab - 2\rho - j) + 3(bc - 3\beta - 2\gamma - i).$$

$$(12) \quad c(n-2)(n-3) \\ = 6h + (ac - 3\sigma - \chi - 3\omega) + 2(bc - 3\beta - 2\gamma - i).$$

$$(13) \quad q = b^2 - b - 2k - 2f - 3\gamma - 6t.$$

$$(14) \quad r = c^2 - c - 2h - 3\beta.$$

Also, reciprocal to these

$$(15) \quad a' = n'(n'-1) - 2b' - 3c'.$$

$$(16) \quad \kappa = 3n'(n'-2) - 6b' - 8c'.$$

$$(17) \quad \delta = \frac{1}{2}n'(n'-2)(n'^2-9) - (n'^2-n'-6)(2b'+3c') \\ + 2b'(b'-1) + 6b'c' + \frac{3}{2}c'(c'-1).$$

$$(18) \quad \alpha' (n' - 2) = \kappa' - B' + \rho' + 2\sigma' + 3\omega'.$$

$$(19) \quad b' (n' - 2) = \rho' + 2\beta' + 3\gamma' + 3t'.$$

$$(20) \quad c' (n' - 2) = 2\sigma' + 4\beta' + \gamma' + \theta' + \omega'.$$

$$(21) \quad \alpha' (n' - 2) (n' - 3) \\ = 2(\delta' - C' - 3\omega') + 3(\alpha'c' - 3\sigma' - \chi' - 3\omega') + 2(\alpha'b' - 2\rho' - j').$$

$$(22) \quad b' (n' - 2) (n' - 3) \\ = 4k' + (\alpha'b' - 2\rho' - j') + 3(b'c' - 3\beta' - 2\gamma' - t').$$

$$(23) \quad c' (n' - 2) (n' - 3) \\ = 6h' + (\alpha'c' - 3\sigma' - \chi' - 3\omega') + 2(b'c' - 3\beta' - 2\gamma' - t').$$

$$(24) \quad q' = b'^2 - b' - 2k' - 2f' - 3\gamma' - 6t'.$$

$$(25) \quad r' = c'^2 - c' - 2h' - 3\beta',$$

together with one other independent relation, in all 26 relations between the 46 quantities.

628. The new relation may be presented under several different forms, equivalent to each other in virtue of the foregoing 25 relations; these are

$$(26) \quad 2(n-1)(n-2)(n-3) - 12(n-3)(b+c) \\ + 6q + 6r + 24t + 42\beta + 30\gamma - \frac{3}{2}\theta = \Sigma;$$

$$(27) \quad 26n - 12c - 4C - 10B + \beta - 7j - 8\chi + \frac{1}{2}\theta - 4\omega = \Sigma,$$

in each of which two equations Σ is used to denote the same function of the accented letters that the left-hand side is of the unaccented letters.

$$(28) \quad \beta' + \frac{1}{2}\theta' = 2n(n-2)(11n-24) \\ + (-66n + 184)b \\ + (-93n + 252)c \\ + 22(2\beta + 3\gamma + 3t) \\ + 27(4\beta + \gamma + \theta) \\ + \beta + \frac{1}{2}\theta \\ - 24C - 28B - 27j - 38\chi - 73\omega \\ + 4C' + 10B' + 7j' + 8\chi' - 4\omega'.$$

Or, reciprocally,

$$\begin{aligned}
 (29) \quad \beta + \frac{1}{2}\theta &= 2n'(n' - 2)(11n' - 24) \\
 &+ (-66n' + 184)b' \\
 &+ (-93n' + 252)c' \\
 &+ 22(2\beta' + 3\gamma' + 3t') \\
 &+ 27(4\beta' + \gamma' + \theta') \\
 &+ \beta' + \frac{1}{2}\theta' \\
 &- 24C' - 28B' - 27j' - 38\chi' - 73\omega' \\
 &+ 4C + 10B + 7j + 8\chi - 4\omega.
 \end{aligned}$$

Where the equation (26) in fact expresses that the surface and its reciprocal have the same deficiency; viz. the expression for the deficiency is

$$\begin{aligned}
 (30) \quad \text{Deficiency} &= \frac{1}{6}(n-1)(n-2)(n-3) - (n-3)(b+c) \\
 &+ \frac{1}{2}(q+r) + 2t + \frac{7}{2}\beta + \frac{5}{2}\gamma + i - \frac{1}{6}\theta, \\
 &= \frac{1}{6}(n'-1)(n'-2)(n'-3) - \&c.
 \end{aligned}$$

629. The equation (28) (due to Prof. Cayley) is the correct form of an expression for β' , first obtained by him (with some errors in the numerical coefficients) from independent considerations, but which is best obtained by means of the equation (26); and (27) is a relation presenting itself in the investigation. In fact, considering a as standing for its value $n(n-1) - 2b - 3c$, we have from the first 25 equations

6	a	$= \Sigma$
+ 2	$3n - c - \kappa$	$= \Sigma$
- 2	$a(n-2) - \kappa + B - \rho - 2\sigma - 3\omega$	$= \Sigma$
- 4	$b(n-2) - \rho - 2\beta - 3\gamma - 3t$	$= \Sigma$
- 6	$c(n-2) - 2\sigma - 4\beta - \gamma - \theta - \omega$	$= \Sigma$
+ 2	$n + \kappa - \sigma - 2C - 4B - 2j - 3\chi - 3\omega$	$= \Sigma$
- 3	$2q - 2\rho + \beta + j$	$= \Sigma$
- 2	$3r + c - 5\sigma - \beta - 4\theta + \chi - \omega$	$= \Sigma$

and multiplying these equations by the numbers set opposite to them respectively, and adding, we find

$$\begin{aligned}
 &-2n^3 + 12n^2 + 4n + b(12n - 36) + c(12n - 48) \\
 &-6q - 6r - 4C - 10B - 41\beta - 30\gamma - 24t - 7j - 8\chi + 2\theta - 4\omega = \Sigma,
 \end{aligned}$$

and adding hereto (26) we have the equation (27); and from this (28), or by a like process, (29), is obtained without much difficulty. As to the 8 Σ -equations or symmetries, observe that the first, third, fourth, and fifth are in fact included among the original equations (for an expression which vanishes is in fact = Σ); we have from them moreover $3n - c = 3a' - \kappa'$, and thence $3n - c - \kappa = 3a' - \kappa - \kappa'$, which is = Σ , or we have thus the second equation; but the sixth, seventh, and eighth equations have yet to be obtained.

630. The equations (15), (16), (17) give

$$\begin{aligned} n' &= a(a-1) - 2\delta - 3\kappa, \\ c' &= 3a(a-2) - 6\delta - 8\kappa, \\ b' &= \frac{1}{2}a(a-2)(a^2-9) - (a^2-a-6)(2\delta+3\kappa) \\ &\quad + 2\delta(\delta-1) + 6\delta\kappa + \frac{3}{2}\kappa(\kappa-1); \end{aligned}$$

from (7), (8), (9) we have

$$\begin{aligned} (a-b-c)(n-2) &= \kappa - B - 6\beta - 4\gamma - 3t - \theta + 2\omega, \\ (a-2b-3c)(n-2)(n-3) &= \\ &= 2(\delta-C) - 8k - 18h - 6bc + 18\beta + 12\gamma + 6i - 6\omega, \end{aligned}$$

and substituting these values for κ and δ , and for a its value $= n(n-1) - 2b - 3c$ we obtain the values of n' , c' , b' ; viz. the value of n' is

$$\begin{aligned} n' &= n(n-1)^2 - n(7b+12c) + 4b^2 + 8b + 9c^2 + 15c \\ &\quad - 8k - 18h + 18\beta + 12\gamma + 12i - 9t \\ &\quad - 2C - 3B - 3\theta. \end{aligned}$$

Observe that the effect of a cnicnode C is to reduce the class by 2, and that of a binode B to reduce it by 3.

631. We have

$$(n-2)(n-3) = n^2 - n + (-4n+6) = a + 2b + 3c + (-4n+6),$$

and making this substitution in the equations (10), (11), (12), which contain $(n-2)(n-3)$, these become

$$\begin{aligned} a(-4n+6) &= 2(\delta-C) - a^2 - 4\rho - 9\sigma - 2j - 3\chi - 15\omega, \\ b(-4n+6) &= 4k - 2b^2 - 9\beta - 6\gamma - 3i - 2\rho - j, \\ c(-4n+6) &= 6h - 3c^2 - 6\beta - 4\gamma - 2i - 3\sigma - \chi - 3\omega, \end{aligned}$$

(the foregoing equations (C)); and adding to each equation four times the corresponding equation with the factor $(n-2)$, these become

$$\begin{aligned} a^2 - 2a &= 2(\delta - C) + 4(\kappa - B) - \sigma - 2j - 3\chi - 3\omega, \\ 2b^2 - 2b &= 4k - \beta + 6\gamma + 12t - 3i + 2\rho - j, \\ 3c^2 - 2c &= 6h + 10\beta + 4\theta - 2i + 5\sigma - \chi + \omega. \end{aligned}$$

Writing in the first of these $a^2 - 2a = n' + 2\delta + 3\kappa - a$, and reducing the other two by means of the values of q, r , the equations become

$$\begin{aligned} n' - a &= -2C - 4B + \kappa - \sigma - 2j - 3\chi - 3\omega, \\ 2q + \beta + 3i + j &= 2\rho, \\ 3r + c + 2i + \chi &= 5\sigma + \beta + 4\theta + \omega, \end{aligned}$$

which give at once the last three of the 8 Σ -equations.

The reciprocal of the first of these is

$$\sigma' = a - n + \kappa' - 2j' - 3\chi' - 2C' - 4B' - 3\omega',$$

viz. writing herein

$$a = n(n-1) - 2b - 3c \quad \text{and} \quad \kappa' = 3n(n-2) - 6b - 8c,$$

this is $\sigma' = 4n(n-2) - 8b - 11c - 2j' - 3\chi' - 2C' - 4B' - 3\omega'$,

giving the order of the spinode curve; viz. for a surface of the order n without singularities this is $= 4n(n-2)$, the product of the orders of the surface and its Hessian.

632. Instead of obtaining the second and third equations as above, we may to the value of $b(-4n+6)$ add twice the value of $b(n-2)$; and to twice the value of $c(-4n+6)$ add three times the value of $c(n-2)$, thus obtaining equations free from ρ and σ respectively; these equations are

$$\begin{aligned} b(-2n+2) &= 4k - 2b^2 - 5\beta - 3i + 6t - j, \\ c(-5n+6) &= 12h - 6c^2 - 5\gamma - 4i - 2\chi + 3\theta - 3\omega, \end{aligned}$$

equations which, introducing therein the values of q and r , may also be written

$$\begin{aligned} b(2n-4) &= 2q + 5\beta + 6\gamma + 6t + 3i + j + 4f, \\ c(5n-12) + 3\theta &= 6r + 18\beta + 5\gamma + 4i + 2\chi + 3\omega. \end{aligned}$$

Considering as given, n the order of the surface; the nodal curve with its singularities b, k, f, t ; the cuspidal curve and its singularities c, h ; and the quantities β, γ, i which relate to the intersections of the nodal and cuspidal curves; the first of the two equations gives j , the number of pinch-points, being singularities of the nodal curve quoad the surface; and the second equation establishes a relation between θ, χ, ω , the numbers of singular points of the cuspidal curve quoad the surface.

In the case of a nodal curve only, if this be a complete intersection $P=0, Q=0$, the equation of the surface is $(A, B, C \chi P, Q)^2=0$, and the first equation is

$$b(-2n+2) = 4k - 2b^2 + 6t - j;$$

or, assuming $t=0$, say $j=2(n-1)b - 2b^2 + 4k$, which may be verified; and so in the case of a cuspidal curve only, when this is a complete intersection $P=0, Q=0$, the equation of the surface is $(A, B, C \chi P, Q)^2=0$, where $AC - B^2 = MP + NQ$; and the second equation is

$$c(-5n+6) = 12h - 6c^2 - 2\chi + 3\theta - 3\omega,$$

or, say $2\chi + 3\omega = (5n-6)c - 6c^2 + 12h + 3\theta$, which may also be verified.

633. We may in the first instance out of the 46 quantities consider as given the 14 quantities

$$n : \quad b, k, f, t \quad : \quad c, h, \theta, \chi \quad : \quad \beta, \gamma, i : C, B,$$

then of the 26 relations, 17 determine the 17 quantities

$$\begin{aligned} a, \delta, \kappa, \rho, \sigma : j, q & \quad : r, \omega \\ n' : a', \delta', \kappa' & \quad : b', f' \quad : c' & \quad : i', \end{aligned}$$

and there remain the 9 equations

$$(18), (19), (20), (21), (22), (23), (24), (25), (28),$$

connecting the 15 quantities

$$\rho', \sigma' : k', t', j', q' : h', \theta', \chi', \omega', r : \beta', \gamma' : C', B'.$$

Taking then further as given the 5 quantities $j', \chi', \omega', C', B'$, equations (18) and (21) give ρ', σ' ,

$$\text{equation (19) gives } 2\beta' + 3\gamma' + 3t',$$

$$\text{,, (20) ,, } 4\beta' + \gamma' + \theta',$$

$$\text{,, (28) ,, } \beta' + \frac{1}{2}\theta',$$

so that taking also t' as given, these last three equations determine β' , γ' , θ' ; and finally

equation (22) gives k' ,

„ (23) „ h' ,

„ (24) „ q' ,

„ (25) „ r' ,

viz. taking as given in all 20 quantities, the remaining 26 will be determined.

614. In the case of the general surface of the order n , without singularities, we have as follow :

$$n = n,$$

$$a = n(n-1),$$

$$\delta = \frac{1}{2}n(n-1)(n-2)(n-3),$$

$$\kappa = n(n-1)(n-2),$$

$$n' = n(n-1)^2,$$

$$a' = n(n-1),$$

$$\delta' = \frac{1}{2}n(n-2)(n^2-9),$$

$$\kappa' = 3n(n-2),$$

$$b' = \frac{1}{2}n(n-1)(n-2)(n^3-n^2+n-12),$$

$$k' = \frac{1}{8}n(n-2)(n^{10}-6n^9+16n^8-54n^7+164n^6-288n^5 \\ + 547n^4-1058n^3+1068n^2-1214n+1464),$$

$$t' = \frac{1}{6}n(n-2)(n^7-4n^6+7n^5-45n^4+114n^3-111n^2+548n-960),$$

$$q' = n(n-2)(n-3)(n^2+2n-4),$$

$$\rho' = n(n-2)(n^3-n^2+n-12),$$

$$c' = 4n(n-1)(n-2),$$

$$h' = \frac{1}{2}n(n-2)(16n^4-64n^3+80n^2-108n+156),$$

$$r' = 2n(n-2)(3n-4),$$

$$\sigma' = 4n(n-2),$$

$$\beta' = 2n(n-2)(11n-24),$$

$$\gamma' = 4n(n-2)(n-3)(n^3-3n+16),$$

the remaining quantities vanishing.

615. The question of singularities has been considered under a more general point of view by Zeuthen, in the memoir "Recherche des singularités qui ont rapport à une droite multiple d'une surface," *Math. Annalen*, t. IV. pp. 1-20, 1871. He attributes to the surface:

A number of singular points, viz. points at any one of which the tangents form a cone of the order μ , and class ν , with $y + \eta$ double lines, of which y are tangents to branches of the nodal curve through the point, and $z + \zeta$ stationary lines, whereof z are tangents to branches of the cuspidal curve through the point, and with u double planes and v stationary planes; moreover, these points have only the properties which are the most general in the case of a surface regarded as a locus of points; and Σ denotes a sum extending to all such points. [The foregoing general definition [includes the cnic-nodes ($\mu = \nu = 2$, $y = \eta = z = \zeta = u = v = 0$), and the binodes ($\mu = 2$, $\eta = 1$, $\nu = y = \&c. = 0$)].

And, further, a number of singular planes, viz. planes any one of which touches along a curve of the class μ' and order ν' , with $y' + \eta'$ double tangents, of which y' are generating lines of the node-couple torse, $z' + \zeta'$ stationary tangents, of which z' are generating lines of the spinode torse, u' double points and v' cusps; it is, moreover, supposed that these planes have only the properties which are the most general in the case of a surface regarded as an envelope of its tangent planes; and Σ' denotes a sum extending to all such planes. [The definition includes the cnictropes ($\mu' = \nu' = 2$, $y' = \eta' = z' = \zeta' = u' = v' = 0$), and the bitropes ($\mu' = 2$, $\eta' = 1$, $\nu' = y' = \&c. = 0$)].

616. This being so, and writing

$$x = \nu + 2\eta + 3\zeta, \quad x' = \nu' + 2\eta' + 3\zeta',$$

the equations (7), (8), (9), (10), (11), (12), contain in respect of the new singularities additional terms, viz. these are

$$a(n-2) = \dots + \Sigma [x(\mu-2) - \eta - 2\zeta],$$

$$b(n-2) = \dots + \Sigma [y(\mu-2)],$$

$$c(n-2) = \dots + \Sigma [z(\mu-2)],$$

$$a(n-2)(n-3) = \dots + \Sigma [x(-4\mu+7) + 2\eta + 4\zeta],$$

$$b(n-2)(n-3) = \dots + \Sigma [y(-4\mu+8)] - \Sigma' (4u' + 3v'),$$

$$c(n-2)(n-3) = \dots + \Sigma [z(-4\mu+9)] - \Sigma' (2v'),$$

and there are of course the reciprocal terms in the reciprocal equations (18), (19), (20), (21), (22), (23). These formulæ are given without demonstration in the memoir just referred to: the principal object of the memoir, as shown by its title, is the consideration not of such singular points and planes, but of the multiple right lines of a surface; and in regard to these, the memoir should be consulted.

INDEX.

- Abbildung, 553.
 Allman, on paraboloids, 93
 Amiot, on non-modular foci of quadrics, 136.
 Anallagmatic surfaces, 481, 512, 529.
 Anchor ring, its properties, 392, 404, 539.
 Anharmonic ratio, of four planes, 24, 86, 88.
 Of four generators of a quadric, 92.
 Of sphero-conics, 220.
 Of four fixed tangent planes of quartic developable, 305.
 Of four tangent planes to any ruled surface, 423.
 Apparent, double points, 292.
 Intersection of curves, 311.
 Apsidal surfaces, 455.
 Area of surface of ellipsoid, 371.
 Asymptotic lines on surfaces, 238.
 Axes, of a quadric found, 66.
 How found when three conjugate diameters are given, 157.
 Of central section of a quadric, 80, 82, 144.
 Of tangent cone to a quadric, 147.
 Bedetti, on section of surface by its tangent plane, 234.
 Bertrand, his theory of the curvature of surfaces, 265.
 On fundamental property of geodesics, 274.
 On curves of double curvature, 336.
 On the proof of a theorem of Gauss', 354.
 On the lines of curvature of the wave surface, 464.
 Besge, on geodesic tangents to a line of curvature, 367.
 Bifecnodes, number of, 574.
 Binodes, 489.
 Binormal, 324.
 Biplanes, 489.
 Bitangent, lines, 244, 246, 420, 474.
 Planes, 251, 579.
 Blackburn on representation of curves, 285.
 Bonnet, on surfaces applicable to one another, 357.
 On orthogonal surfaces, 442.
 On second geodesic curvature, 361, 362.
 Boole, his method of finding axes of a quadric, 66.
 On integration of equation of lines of curvature of an ellipsoid, 269.
 Boole, on the envelope of surfaces whose equations contain parameters, 407.
 Booth, on centro-surface of quadric, 172.
 Bouquet, on the condition that a surface should belong to a triple orthogonal system, 441, 449.
 Bour, on surfaces applicable to one another, 357.
 Brianchon-hexagon and point, 123.
 Brioschi, on lines of curvature of wave surface, 464.
 Canonical form, reduction of equations of two quadrics to their, 206.
 Of equation of a cubic, 491.
 Cartesian surfaces, 535.
 Cartesians, twisted, 317.
 Casey, on obtaining focal properties by inversion, 481.
 On cyclides, 481, 527, &c.
 Cauchy's proof that discriminating cubic has only real roots, 67.
 Cayley, on moment of two lines, 34.
 On equality of degree of ruled surface with that of reciprocal, 105.
 On developable of tangents to curve common to two quadrics, 190.
 On tact-invariants, 211.
 On discriminants of discriminants, 213.
 On the section of a surface by its tangent plane, 234.
 On contact of Hessian with surface, 252.
 On the fundamental property of geodesics, 274.
 On differential equation of orthogonal systems, 441.
 On representation of curves, 282.
 On singularities of developables, 291.
 On singularities of curves, 298.
 On quintic developables, 313.
 On description of quartic curves through eight points, 315.
 Distinguishes planar and multiplanar developables, 318.
 On geodesics, 370.
 On contour and slope lines, 381.
 On equations of Pro-Hessians, 408.
 On ruled surfaces, 416, 429, 430, 431, 435, 512.
 On centro-surface, 471.
 Obtains equation of first negative pedal of a quadric, 481.
 On cubical ruled surface, 487.

- Cayley, on scolar and oscular lines, 489.
 On species of cubics, 490.
 On right lines on a cubic, 496.
 On involution of six lines, 419.
 On generalization of wave surface, 542.
 On differential equation of ruled surfaces, 559.
 On reciprocal surfaces, 592.
 On transformation and correspondence, 553.
 On deficiency of surfaces, 557.
- Centro-surface of a quadric, 170, 465.
 Its reciprocal, 172.
 Its equation formed, 178.
 Sections by principal planes, 171, 468.
 Its cuspidal and nodal lines, 469, 470.
 Extension of problem by Clebsch, 465.
- Centro-surface, in general, 271.
 Tangent planes at points where normal meets cut at right angles, 272.
 When has double lines, 272.
 Its characteristics, 471.
 Of a developable, 337.
- Characteristic, of envelopes, 290, 401.
 Their differential equations, 410.
 Characteristics, of curves which together make up intersection of two surfaces, how connected, 322.
 of developable, 319.
 of systems of surfaces, 547.
- Chasles, on lines joining corresponding vertices of conjugate tetrahedra, 119.
 On analogues to Pascal's theorem, 122.
 On foci and confocal quadrics, 126, &c.
 On focal lines of tangent cones to a quadric, 152.
 On the axes of these tangent cones, 155.
 On finding the axes of a quadric, 157.
 On sphero-conics, 215.
 On curves of third order, 300.
 On curves of fourth order, 317.
 On enumeration of developables, 318.
 On curves on a hyperboloid, 358, 564.
 On geodesics of ellipsoids, 368, &c.
 On ruled surfaces, 416, 512.
 On involution of six lines, 419.
 On systems of surfaces, 552.
- Circular sections of a quadric, 82.
 The problem considered geometrically, 116.
 Sum or difference of angles made with by any plane depends on axes of section, 224.
- Clairaut, on name "curves of double curvature," 342.
- Clebsch, on double lines of surface of centres, 273.
 On condition that four consecutive points of a curve should lie in a plane, 329.
 On surface of centres, and normals from any point to a quadric, 465, &c.
 On reduction of a cubic to its canonical form, 492.
 On intersection of tangent plane and polar with respect to Hessian, 502.
- Clebsch, on surface passing through 27 lines of a cubic, 511.
 Its equation calculated, 559.
 On quartics with nodal conics, 512, 557.
 On doubly inflexional tangents, 559.
 On number of points at which two doubly inflexional tangents can be drawn, 570.
 On representation of curves on surfaces, 553.
 On generation of cubic surfaces, 554.
- Cnicnodes, 488, 240, 248.
- Combescure, on lines of curvature of wave surface, 464.
- Combinants of quadrics, 209.
- Complexes, 63, 190, 214, 416.
- Complex surface, 420, 524.
- Condition, that two planes cut at right angles, 17.
 That right lines should lie completely in surface, 29, 64.
 That two lines intersect, in terms of six coordinates, 43.
 That a plane or line should touch a quadric, 58, 59.
 That a tetrahedron self-conjugate with respect to one quadric may be inscribed in another, 175.
 That two quadrics should touch, 175.
 That a tetrahedron may be inscribed in one quadric having two pairs of opposite edges on another, 180.
 That three asymptotic lines or planes should be rectangular, 183.
 That line should pass through intersection of two quadrics, 189.
 That equation in quadriplanar coordinates represent a sphere, 202.
 That section of quadric be a parabola or equilateral hyperbola, 202.
 That three quadrics may be polars to same cubic, 209.
 That two intersections of three quadrics may coincide, 211.
 That four points of intersection of three quadrics be coplanar, 211.
 How many necessary to determine a surface, 233.
 That three quadrics should meet a line in involution, 214.
 That four consecutive points of a curve should lie in a plane, 329.
 That intersecting surfaces should have a common line, 433.
 That four lines should be met by only one transversal, 419.
 That five lines may have a common transversal, 419.
 That two surfaces should touch, 546.
- Cone, defined, 48.
 Equation of a, with given vertex and resting on a given curve, 101.
 Properties of, 215, &c., 387.
 Equation of right cone, 227.
- Confocal quadrics, surfaces inscribed in a common developable, 128.

- Confocal quadrics, properties of, hence derived, 197.
 Cut at right angles, 143.
 And also appear to do so, 153.
 General form of equation, 196.
- Congruencies, 416.
 Order and class how connected, 473.
 Formed by normals to a surface, 417.
 Of bitangents to focal surface, 421.
- Conical points on surfaces, 240, 248, 488.
- Conicoids, 45.
- Conjugate tangents, 239.
 Lines of quadric, 107.
- Contact, of two surfaces a double point on their intersection, 177, 234, 283, 310.
 Of lines with surfaces, 558.
 Of planes with surfaces, 576.
- Contravariants of systems of quadrics, 185.
 Of cubics, 485, 504.
- Corresponding points on confocals, 161.
- Correspondence, 473, 549, 553, 572.
- Covariants of quadrics, 187.
- Cremona, on section of a surface by its tangent plane, 234.
 On curves of third order, 300, &c.
 On curves of fourth order, 317.
 On developables of fifth order, 319.
 On cubical ruled surfaces, 488.
 On Steiner's quartic, 491.
 On cubics, 492.
 On ruled quartics, 512.
 On transformation and correspondence, 553.
- Cubic twisted, 300, &c.
 Different species of, 306.
- Curvature of quadrics, 167.
 Of surfaces in general, 252.
 Lines of curvature, 167, 170, 266.
 their differential equations, 268, 344.
 their property, if plane, 277.
 the same for two orthogonal surfaces, 270.
 their differential equation integrated for quadrics, 269.
 if geodesic is plane, 277.
 Gauss's theory of curvature, 350, &c.
 Second curvature of curves, 335.
 Geodesic curvature, 360.
 Lines of wave surface, 464.
- Curve in space how represented by equations, 281.
- Cuspidal edge, of developables and envelopes, 271, 290.
 Of polar developable, 339.
 Its differential equation, 413.
- Cyclic planes of cone, 220.
- Cyclides, 481, 512, 527, &c.
- Cylinders, defined, 15.
 Limiting case of cones, 48, 279.
 Their differential equation, 386.
- Darboux, on orthogonal surfaces, 442, 451.
 On centro-surface of quadric, 469.
 On centro-surface in general, 471, 473.
 On cyclides, 481, 527, &c.
 On transformation of surfaces, 553.
- De Jonquières, on systems of surfaces, 551.
- Deficiency of curve in space, 319, of surface, 557.
- Desboves on normals to quadrics, 475.
- Developable defined, 89, 104.
 Circumscribing two quadrics, 188, 208.
 Generated by tangent lines of their common curve, 190.
 How these developables meet the quadric, 191.
 Imaginary, which touches a system of confocals, 195.
 Generated by normals along a line of curvature, 271.
 General theory of, 284, &c.
 Plücker-Cayley equations of, 293, 295.
 Of same degree, as developable generated by reciprocal curve, 294.
 Planar and multiplanar, 318.
 Polar of curves, its singularities, 341.
 Differential equation of, 407.
 Which touches along parabolic curve, its degree and singularities, 546, 579.
 Which touches a surface along a given curve, 546.
 Generated by a line meeting two given curves, 547.
 By a line meeting a given curve twice, 590.
 Generated by curve of intersection of two given surfaces, 308.
 Enveloping two given surfaces, 547.
 Enveloped by bitangent planes, 580.
 Theory of their reciprocals, 588.
- Dickson, on geodesics, 358, 362.
- Diguët, on the proof of a theorem of Gauss's, 354.
- Distance, between centres of inscribed and circumscribing circles of spherical triangles, 228.
- Discriminant, of a quadric, 51.
 Of a surface in general, 249.
 Of discriminants, 213.
- Double, points on surfaces, 240, 457, 488, 595.
 On curves, 310.
 Curves are ordinary singularities, 249.
 on developables, 297.
 on surface of centres, 272, 470.
 on ruled surfaces, 428.
- Generators on ruled surfaces, 432.
- Points, apparent, on common curve of two surfaces, 292, 310.
- Tangent lines, how many pass through a point, 244, 246.
- Tangent planes, locus of their points of contact, 251, 579.
- Sixes, Schläfli's, 500.
- Dupin, on indicatrix and elliptic, &c., points, 234, 236.
 On cyclide, 535.
 On conjugate tangents, 239.
 On orthogonal surfaces, 269, 436, &c.
- Elasticity, surface of, 481.
- Elliptic coordinates, 162, 370, 460.
- Ellis, on Dupin's theorem, 270.

- Envelope of a plane containing one parameter, 286.
 entering rationally, 296.
 Of a plane containing two parameters, 288.
 entering rationally, 491, 590.
 General theory of, 401.
- Equilateral hyperboloids, 102, 120, 183.
- Euler, on curvature of surfaces, 254.
- Evolutes of curves, 339, &c.
- Families of surfaces, 383, &c.
- Faure, extension of his theorem on self-conjugate triangles, 175.
- Ferrer's proof of theorem of Chasles, 119.
- Feuerbach's theorem on circles touching sides of a triangle, 229.
- Flecnodal curve, 559.
- Focal conics of quadrics, 129, 139.
 tangential equation in general, 199.
 Curves, general definition of, 128.
 Lines of cones, 106, 133.
 Properties obtained by inversion, 481.
- Foci, general definition of, 127.
 Of section normal to focal conic, 132.
 Of plane section of a quadric, coordinates of, 203.
- Fourier, on polar developable of curves, 338.
- Frenet, on curves of double curvature, 342.
- Fresnel, on wave surface, 453.
 On surface of elasticity, 481.
- Frost and Wolstenholme's treatise on Solid Geometry, 45.
- Gauss's theorems on geodesics, 358.
 On curvature of surfaces, 343, &c., 356.
- Gehring, on differential equation of geodesics, 363.
- Geiser, on right lines of nodal quartics, 526.
- Geodesics, fundamental property, 273, 358.
 Their differential equation, 362.
 On centro-surface, 275.
 On ellipsoid, 364, &c.
 Curvature, 360.
 Polar coordinates, 356, 373.
- Gerbaldi, on Steiner's quartic, 491.
- Gordan, on cubics, 492.
- Graves, his translation of Chasles on sphero-conics, 215.
 Theorem on arcs of sphero-conics, 225.
 extended to geodesics, 366.
 Proof of Joachimsthal's theorem, 362.
- Gregory's solid geometry, 234, 268, 270.
- Gudermann, on spherical coordinates, 216.
- Hamilton, Sir Wm. R., his method of generating quadrics, 102.
 His theorem that umbilics lie in threes on eight lines, 116.
 On circles which touch three great circles, 232.
 On lines of curvature at umbilics, 266.
 On curves of double curvature, 343.
 On nodal points of wave surface, 457.
 On congruencies, 416.
- Hart, his extension of Feuerbach's theorem, 229.
 On twisted cubics, 299.
 Proof of Joachimsthal's theorem, 364.
 On geodesics, 376, 380.
 On obtaining focal properties by inversion, 481.
 Theorem that confocal plane circular cubics cut orthogonally, 533.
- Helix and Helicoid, 325, 332, 338, 390.
- Hesse, on the construction of a quadric through nine points, 113.
 On Brianchon's hexagon, 123.
 Theorem as to the vertices of two self-conjugate tetrahedra, 175.
 On osculating plane of curves, 328.
 On integration of equation of geodesic on ellipsoid, 372.
 On geodesics, 363.
- Hessian of a surface, 250.
 Touched by every right line on the surface, 251.
 Has double points, 494.
 Of a developable, 408.
 Of cubic identical with Steinerian, 493.
 Of a ruled surface, 591.
- Hirst, on pedal surfaces, 478.
 On inverse surfaces, 479.
- Homographic correspondence; surface generated by line joining corresponding points on two lines, or enveloped by plane joining corresponding points on three, 92, 304.
 Locus of intersection of three corresponding planes, 554.
- Imaginary circle at infinity, its equation, 184, 199, 227.
 Generators of quadric, 116, 469.
- Indicatrix, 236.
- Inextensible surfaces, 357.
- Inflexion linear on curves, 295.
 On quartics, 316.
- Inflexional tangents of surfaces, 236.
 How many pass through a point, 245.
 How many tangents to a given curve on a surface are inflexional, 546.
- Intersection of two surfaces, its singularities, 308.
 Of three surfaces, common curve equivalent to how many points, 321.
- Invariants and covariants of quadrics, 173, &c.
 Of a cone and quadric, 182.
 Of sections of quadrics, 202.
 Of a system of three quadrics, 208.
 Of circles on a sphere, 228.
 Of a cubic, 503.
- Inverse surfaces, 479.
- Inversion applied to obtaining focal properties, 481.
 To study of cyclides, 528.
- Involution of tangent and normal planes to a ruled surface, 423.
 Of six lines, 419, 518.

- Ivory's theorem on distance between corresponding points of confocals, 164.
- Jacobi, on focal lines to tangent cones of quadrics, 152.
His mode of generating quadrics, 164.
Integrates equation of geodesics on an ellipsoid, 361, 362, 372.
- Jacobian of four quadrics, 205.
Curve, 213.
Of four surfaces, 544.
- Jellett, on inextensible surfaces, 357.
- Joachimsthal, his method of finding intersection of a line with a surface, 56, 242, 522.
On tetrahedra, 120.
On normal to ellipsoid, 165.
His theorem on plane lines of curvature, 276.
On curves of the third order, 303.
On geodesics of an ellipsoid, 361.
- Klein, edits Plücker's work on lines, 416.
On relation between order and class of congruency, 473.
On transformation and correspondence, 553.
- Korndörfer on quartics with nodal lines, 512.
On representation of curves, 553.
- Kummer, on double lines of surfaces of centres, 273.
On Steiner's quartic, 491.
On quartics, 540; with nodal conic, 512, 526.
On congruencies, 416.
- Lacroix, contributions of to the theory of curves of double curvature, 343.
On lines of striction, 424.
- Lamé, curvilinear coordinates, 349, 442.
- Lancret's theorem, 277.
On curves of double curvature, 343.
- Legendre, on area of ellipsoid, 371.
- Level, lines of, 380.
- Levy, on orthogonal surfaces, 442.
- Line, six coordinates of, 33, 60, 193, 282, 518.
- Liouville, his calculation of radius of geodesic curvature, 360.
His mode of writing equation of geodesics of an ellipsoid, 366.
On elliptic coordinates, 370.
- Lloyd, on conical refraction, 457.
- Locus of intersection of three rectangular tangent lines to a quadric, 100, 160, 196.
Of three rectangular tangent planes, 77, 196.
If the planes each touch one of three confocals, 155.
Of points on quadric whose normals meet a fixed normal, 101, 167; on any surface, 265.
Of centres of quadrics satisfying eight conditions, 112, 548.
Of pole of plane with regard to a series of confocals, 146.
- Locus of vertices of right cones circumscribing a quadric, 158.
Of intersection of rectangular generators of a hyperboloid, 160.
Of points of contact of parallel tangent planes to confocals, 166.
Of centres of spheres circumscribing self-conjugate tetrahedron, 175.
Of foci of central sections of a quadric, 203.
Of foci of sections parallel to a given line, 204.
Of vertices of cones through six points, 205.
Of intersection of rectangular tangents to a sphero-conic, 225.
Of points of contact of double tangent planes to a surface, 579.
Of curves of contact from points on axes to system of confocal ellipsoids, 452.
Of intersection of three homographically corresponding planes, 551.
- Mac Cullagh, on foci and confocal surfaces, 126.
On modular property of foci, 135.
On bifocal chords, 157.
On apsidal surfaces and wave surface, 456, &c.
- Marcks, on order of centro-surface, 473.
- M'Cay's proof of theorem of Chasles, 120.
On foci of sections of quadric, 204.
- Meunier's theorem, 168, 256, 267, 360.
Used to prove fundamental property of geodesics, 274.
- Möbius, on intersection of cones and spheres, 215.
On twisted cubics, 300.
- Modular property of foci, 135.
- Monge, on lines of curvature, 266, 273.
On geodesics, 273.
On tetrahedron, 120.
On envelopes, 289, 290.
On polar lines of curves, 331.
On evolutes, 339.
On curves of double curvature, 342.
On families of surfaces, 410, 414, 415.
- Monoid, defined, 282.
- Moutard, on anallagmatic surfaces, 512.
On condition that surfaces should touch, 544, 546.
- Node couple curve, 579.
- Normal to a surface, its equations, 244.
Plane to a curve, 324.
To confocals through given line generate paraboloid, 153.
To any ruled surface along a generator, 423.
When intersects consecutive, 264.
Extension of notion of, 465.
To a quadric, Clebsch on, 465.
How many can be drawn from a point to a surface, 472.
- Normopolar surface, 475.

- Nöther, on deficiency of surfaces, 553, 557.
- Order of condition that three surfaces should have a common line, 434.
- Orthogonal hyperboloid, 100, 183.
- Surfaces, Dupin's theorem on, 269, 436, &c.
- On systems of, 441, &c.
- Cayley's differential equation of, 443.
- Confocal quadrics are, 143.
- Confocal cyclides are, 533.
- Osculation of two surfaces, condition for, 329.
- Osculating plane, 104, 283, 324.
- Sphere of a curve, 331, 341.
- Right cone of a curve, 335.
- Oscular lines on a surface, 489.
- Painvin, on foci of sections of a quadric, 204.
- Parabolic, points defined, 237.
- Tangent planes at, count double, 240.
- Polar quadrics of, are cones, 249.
- Paraboloid, its equation reduced, 71.
- Parallel to a quadric, 176, 477.
- Its sections by principal planes, 468.
- To a surface in general, 475.
- To a curve, 478.
- Pascal, theorem of, 122.
- Plane, 123.
- Pedal surfaces, 478.
- Perpendicularity, generalization of the relation, 200, 465.
- Condition of for two circles on sphere, 219.
- Pinch points, 519, 594.
- Plücker's relations between singularities of plane curves, 291.
- On curves on a hyperboloid, 358, 554.
- On complexes, &c., 63, 416.
- On wave surface, 457.
- On complex surface, 420, 524.
- Polar, of points on a surface, 243.
- Of line to a quadric, 49, 60.
- Developable of a curve, 331, 338.
- Curve of a line, 548.
- Pole of plane with regard to quadric, coordinates of, 58.
- Principal planes of quadric, equation of, 55.
- Pro-Hessians, 408.
- Projections of lines of curvature on planes of circular sections, 163.
- Puiseux, on curves of double curvature, 336.
- On the proof of Gauss's theorem, 354.
- Purser, F., envelope of face of tetrahedron, 180.
- On intersecting normals to quadric, 167.
- On bitangents to centro-surface, 474.
- Quadrics, 45.
- Having double contact, 115, 314.
- Touching four planes or going through four points, 181.
- Quadriplanar coordinates, 23, 199.
- Conditions general equation in, may represent a sphere, 202.
- Quartic curves, two families of, 312.
- Quartic surfaces, 512, &c.
- Nodal quartics, 537.
- Quintic curves, species of, 318.
- Radii of curvature, principal, their lengths, 257, 276.
- Of any normal section, 259, 278.
- Of a curve of double curvature, 331, 333.
- Rank of system, 292.
- Reciprocal surfaces, 103.
- Cones, their sections, 101, 105.
- Of double points on surfaces, 241.
- Of a surface, its degree, 248.
- Of ruled surface and of developable, of same degree, 105, 294, 590.
- Of apsidal surface, 456.
- Of cubic surfaces, 485.
- Of cubic surface with double line, 487.
- General theory of, 580.
- How affected by double and multiple lines, 587.
- Rectilinear generators of a quadric, 85.
- Rectifying developable of curves, 336.
- Reech, on closed surfaces, 381.
- Revolution, surface of, conditions quadric should be, 96.
- This problem considered geometrically, 116.
- Reciprocal of quadric, when a, 137.
- Generated by revolution of right line, 99.
- Differential equation of family of surfaces of, 390.
- Right lines on a cubic, 29, 496.
- On a surface touch the Hessian, 251.
- On quartic with nodal lines, 523, 527.
- Roberts, M., his theorems on geodesics on an ellipsoid, 356, 365, 376.
- On differential equation of cuspidal edge of enveloping developable, 413.
- Roberts, S., on parallel surfaces, 476.
- Roberts, W., on geodesics of an ellipsoid, 380.
- On orthogonal surfaces, 451.
- On equation of wave surface in elliptic coordinates, 459.
- On pedal surfaces, 478.
- On negative pedals, 483.
- Roberts, W. R., on curve of intersection of two quadrics, 193.
- Routh, on curves of double curvature, 337.
- Ruled surfaces, 89, 422, &c., 590.
- Their differential equation, 400, 559.
- Reciprocals of same degree, 105, 428.
- Generated by a line meeting three directing curves, 429.
- By a line meeting a curve three times, 432.
- Double generators on, 433.
- Cubical, 486.
- Quartic, 512—522,

- Saint Venant, on curves, 324, 342.
 Schläfli, on reduction of degree of reciprocal by nodal points, 490.
 On right lines on a cubic, 499.
 Analysis of different species of cubics, 490, 501.
 Schröter, on orthogonal and equilateral hyperboloids, 100, 102, 120.
 On curves of the third order, 300.
 On Steiner's quartic surface, 491.
 Schubert, on fourpoint inflexional tangents, 570.
 On fivepoint contact, 574.
 Schwarz, on developables, 318, 320.
 Scrolls, 89, 512.
 Serret, on orthogonal surfaces, 441, 450.
 Slope, line of greatest, 381, 389, 411.
 Sphere circumscribing tetrahedron, its radius, 37.
 Its equation, 201.
 Inscribed in a tetrahedron, 201, 227.
 Cutting four spheres at right angles, 206.
 Principal spheres, have stationary contact, 264.
 Spherical curvature, line of, 262.
 Sphero-conics, 215.
 Sphero-quartics, 535.
 Spinode torse and curve, 594.
 Stationary contact, 178.
 Implies contact in two consecutive points, 263.
 Principal spheres, have stationary contact, 178, 257.
 Points on twisted curve, 292.
 Conditions for stationary contact of two surfaces, 329.
 Tangent planes to a surface, 240.
 How many pass through a point, 250.
 v. Staudt, sine of solid angle, 37.
 Steiner, on perpendiculars in tetrahedron, 120.
 Quartic surface cut by every tangent plane in two conics, 491, 517, 556.
 On cubical surfaces, 492, 495, 496.
 Steinerians, 493.
 Striction, lines of, 424.
 Sturm, on cubics, 492.
 On multiple lines, 523.
 Sylvester, on canonical form of a cubic, 492, 494.
 On twisted cartesians, 317.
 On involution of six lines, 419.
 Symmetroid, 540.
 Synnormal explained, 475.
 Systems of quadrics through a common curve, 111.
 Inscribed in a common developable, 111.
 Of surfaces whose equations include one indeterminate, 547.
 Tact-invariant of two quadrics, 175; of three quadrics, 211.
 Of any two surfaces, 546; of any three surfaces, 544.
 Tait on curves, 285.
 Tangent to a curve, 283.
 Tangent cone to a quadric, its equation, 57, 148.
 To any surface, its equation and singularities, 245, 247.
 Tangential equation, of quadric, 58, 109.
 Of imaginary circle at infinity, 184, 199.
 Of a curve in space, 184.
 Of a sphere, 200.
 Of the centro-surface of a quadric, 172.
 Tetrahedroid, 542.
 Tetrahedron, intersection of lines joining middle points of sides, 6.
 Volume of, formed by four points or four planes, 21, 22.
 in terms of edges, 35.
 in quadriplanar coordinates, 39.
 Sphere circumscribed to, 37.
 Relation between perpendiculars in, 120.
 Self-conjugate with regard to a quadric, 117, 175.
 Lines joining corresponding vertices of two conjugates, how connected, 118.
 Thomson's proof of Dupin's theorem, 270.
 On curves, 285.
 Tinseau, on curves of double curvature, 343.
 Toeplitz, on a combinant of three quadrics, 210, 214.
 Torsal lines on a surface, 489.
 Torse, 89.
 Torsion, angle of, 334.
 Tortolini, on pedal surfaces, 478.
 Torus, 539.
 Townsend, on quadric through nine points, 113.
 On foci of quadric, 136.
 On Jacobi's mode of generating quadrics, 165.
 Triple tangent lines to a surface, 569.
 Planes, an ordinary singularity of surfaces, 235.
 For cubic, 498.
 Their number in general, 584.
 Tubular surfaces, 402, 409, 478.
 Umbilics of quadric defined, 85.
 Their coordinates, 142.
 Lie in threes on right lines, 116.
 Section of enveloping quadric by tangent plane at, 117.
 Conditions for, 260, 278.
 Their number in general, 263.
 Three lines of curvature pass through, 266.
 Umbilicar foci, 131.
 Unicursal curve, 282.
 Surface, 553.
 Unodes, 489.
 Valentiner, on general quartic, 527.

- Voss, on umbilics, 263.
- Wallis's cono-cuneus, 390.
- Wave surface, 453, &c.
Generalization of, 542.
- Weierstrass, on integration of equation of
geodesics, 372.
- Weierstrass, on Steiner's quartic, 491.
- Williamson, on Gauss's investigation of
lines of curvature, 348, 352.
- Zeuthen, on multiple lines, 523.
On singularities of surfaces, 603.
On systems of surfaces, 553.

THE END.

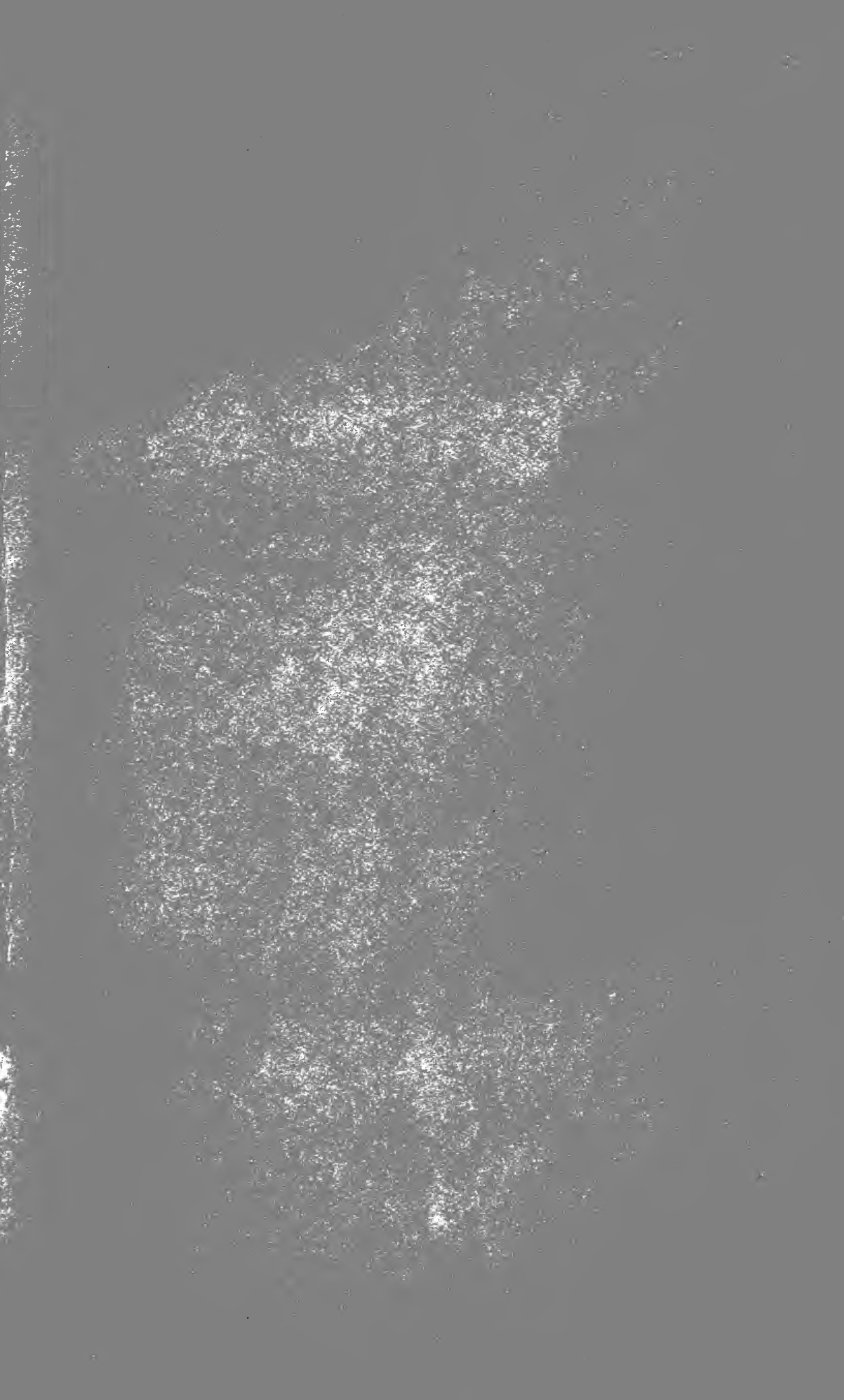

RETURN Astronomy/Mathematics/Statistics Library
TO → 100 Evans Hall 642-3381

LOAN PERIOD 1 1 MONTH	2	3
4	5	6

ALL BOOKS MAY BE RECALLED AFTER 7 DAYS

DUE AS STAMPED BELOW

AUG 10 1998		
MAY 10 1999		
Rec'd UCB A/M/S		
MAR 20 1999		

U. C. BERKELEY LIBRARIES



C048063910

QA
553
S3
1882
MATH

