



THE LIBRARY
OF
THE UNIVERSITY
OF CALIFORNIA
LOS ANGELES

GIFT OF

Mrs. Clifford B. Walker





Digitized by the Internet Archive
in 2007 with funding from
Microsoft Corporation



A TREATISE
ON THE
MOTOR APPARATUS OF THE EYES

EMBRACING AN EXPOSITION OF THE

ANOMALIES OF THE OCULAR ADJUSTMENTS
AND THEIR TREATMENT

WITH THE

ANATOMY AND PHYSIOLOGY OF THE MUSCLES
AND THEIR ACCESSORIES

BY

GEORGE T. STEVENS, M.D., PH.D.

Illustrated with 184 Engravings, some in Colors



PHILADELPHIA

F. A. DAVIS COMPANY, PUBLISHERS

1906

COPYRIGHT, 1906,

BY

F. A. DAVIS COMPANY

[Registered at Stationers' Hall, London, England.]

Philadelphia, Pa., U.S.A.:
Press of F. A. Davis Company
1916 Cherry Street.

W W

400

S 844 t

1906

PREFACE.

WHEN, in my work on "Functional Nervous Diseases," published in 1884, I intimated that it would be followed by one on the "Anomalies of the Muscles of the Eyes," my purpose was to compile the facts and views extant at that time. It then seemed that such a compilation, including the few new suggestions which I had myself advanced, would constitute a valuable accession to the working means required in treating many forms of nervous disturbances.

The work was commenced, but it soon appeared that much was to be learned in this field and that it would be wiser to publish the ~~work~~ which appeared to me to have been settled by my own investigations, in the expectation that, ~~it~~ be assembled into book

ERRATA.

Page 1, Preface, for *e' Oculistique*, read *d' Oculistique*.

Page 112, footnote, for *ηλαγίος*, read *πλάγιος*.

Page 119, line 23, for *Spherical*, read *Plane*.

Page 436, footnote, for *νευστάξεν*, read *νευστάξειν*.

Page 436, footnote, for *τάλάντωδης*, read *τάλάντωσις*.

ing the subject as it then
. As these articles ap-
peared in Ophthalmology
crest in the subject was

Under the teachings of experience and the closer investigation of the principles underlying the phenomena, that the publication of the work as a whole seemed further and further from realization. Several times the work has apparently been ready for presentation, yet as often new light has been thrown upon the facts already known in such manner as to make delay still desirable.

At length, while I do not by any means imagine that the subject is advanced to its limit, for nothing is more true than that the answering of a question in science only opens the way for other questions, I believe that a good purpose will be served by presenting in a systematic form the principles which appear to me to govern the physiological actions and the anomalous disturbances of the motor apparatus of the eyes. Whatever progress may be made in future

(iii)

COPYRIGHT, 1906.

[Register

Philadelphia, Pa., U.S.A.:
Press of F. A. Davis Company
1916 Cherry Street.

WW

400

S844 t

1906

PREFACE.

WHEN, in my work on "Functional Nervous Diseases," published in 1884, I intimated that it would be followed by one on the "Anomalies of the Muscles of the Eyes," my purpose was to compile the facts and views extant at that time. It then seemed that such a compilation, including the few new suggestions which I had myself advanced, would constitute a valuable accession to the working means required in treating many forms of nervous disturbances.

The work was commenced, but it soon appeared that much was to be learned in this field and that it would be wiser to publish the principles which appeared to me to have been settled by my own investigations and experience in occasional articles, in the expectation that, at a later period, the substance of these might be assembled into book form.

A series of articles, progressively developing the subject as it then presented itself, was consequently published. As these articles appeared from time to time, mostly in the *Archives of Ophthalmology* and *Annals d'Oculistique*, a very general interest in the subject was awakened both in America and in Europe.

The subject, however, grew so rapidly under the teachings of experience and the closer investigation of the principles underlying the phenomena, that the publication of the work as a whole seemed further and further from realization. Several times the work has apparently been ready for presentation, yet as often new light has been thrown upon the facts already known in such manner as to make delay still desirable.

At length, while I do not by any means imagine that the subject is advanced to its limit, for nothing is more true than that the answering of a question in science only opens the way for other questions, I believe that a good purpose will be served by presenting in a systematic form the principles which appear to me to govern the physiological actions and the anomalous disturbances of the motor apparatus of the eyes. Whatever progress may be made in future

(iii)

will not, I believe, supplant the general principles which I have here formulated, but will, I trust, serve to explain many questions which can not now be answered.

In the domain of anatomy I have endeavored to present known facts as I have found them in the works of others, adding very little of my own. My purpose has been to set these facts more clearly and concisely before the reader than has been done before.

In the physiological division, while endeavoring to set forth the essential doctrines which have been to an important extent accepted, I have not hesitated to place new interpretations upon known phenomena, and I have advanced a number of entirely new views while placing some of the older views in new light.

It is in the field of systematizing and elucidating the principles upon which the anomalies of the motor apparatus of the eyes depend that I have presented a system which, while originally based upon older knowledge, has so far deviated from the original views that the whole system may be regarded as new, except as it has been from time to time stated by myself.

In the division devoted to paralytic and obstructive affections of the eye muscles I have compiled in a condensed form the principal facts as they have been advanced by many observers.

The work is a sequel to that on "Functional Nervous Diseases." It is believed that a practical acquaintance with the principles and practice included here will promote the more systematic development of the central doctrine of that work, which was, *difficulties of adjustments of the eyes are a source of nervous trouble and more frequently than other conditions constitute a neuropathic tendency.*

This proposition was, when it was announced by myself, absolutely new both as to the statement that such difficulties of adjustment constitute a neuropathic tendency and as to the comparative importance of this source of disturbance. An experience of nearly thirty years has fully confirmed this proposition and I have no hesitation in restating it here.

In view of this proposition a knowledge of the principles of the adjustments of the eyes and their anomalies becomes of greatest importance.

GEORGE T. STEVENS.

TABLE OF CONTENTS.

INTRODUCTION.

HISTORICAL NOTES OF STRABISMUS AND OTHER ANOMALIES OF THE EYE MUSCLES.

	PAGE
First Period—Strabismus.....	1
Second Period—Heterophoria.....	14

PART I.

ANATOMY OF THE MOTOR MUSCLES OF THE EYES AND OF THE PARTS ACCESSORY TO THEM.

SECTION I.	
Movements and Position of the Eyes.....	28
Position of the Eyes in Animals.....	28
SECTION II.	
Comparative Anatomy of the Eye Muscles.....	29
Peculiarities of the Eye Muscles in Fishes.....	29
Peculiarities in Amphibious Reptiles.....	30
Peculiarities in Birds.....	32
Peculiarities in Mammals.....	33
SECTION III.	
The Orbits.....	35
Measurements of the Orbits.....	39
Plane of the Optic Axis.....	44
Orbital Axes in Ethnology.....	46
Contents of the Orbits.....	47
SECTION IV.	
The Muscles.....	48
The Internal Rectus.....	50
The External Rectus.....	51
The Superior Rectus.....	51
The Inferior Rectus.....	51
The Superior Oblique.....	52
The Inferior Oblique.....	53
SECTION V.	
Insertions of the Tendons.....	54
SECTION VI.	
The Capsule of Tenon or Orbito-Ocular Aponeurosis.....	61
Internal or Bulbar Capsule.....	64
External Capsule or External Aponeurosis.....	65
Ligamentous Ailerons or Bridles—Orbital Muscles.....	67
General Considerations Regarding the Ailerons and Aponeurosis.....	68

	PAGE
SECTION VII.	
The Vessels Supplying the Muscles of the Eyes.....	69
SECTION VIII.	
The Nerves of the Muscles.....	71
SECTION IX.	
Nuclear Origin of the Nerves of the Ocular Muscles.....	76
SECTION X.	
Circulation to the Nuclei of the Nerves of the Ocular Muscles.....	84

PART II.

PHYSIOLOGY.

SECTION XI.	
The Centre of Movements of the Ocular Globe.....	86
SECTION XII.	
Definitions of Terms Employed in Describing the Positions and Divisions of the Head and of the Relations of the Eyes and of Objects Seen to the Head.....	90
SECTION XIII.	
Direction of the Influence of the Various Motor Muscles of the Eyes..	93
Resumé of the Movements of Each Eye Singly.....	102
Associated Movements of the Eyes.....	103
SECTION XIV.	
Some of the Phenomena, Causes and Laws of Torsions of the Eyes....	106
Accidental Images.....	115
SECTION XV.	
Visual Perception of Space.....	124
SECTION XVI.	
Perspective.....	137
SECTION XVII.	
The Stereoscope, the Stereostroboscope and the Pseudoscope.....	143
SECTION XVIII.	
Unconscious Conclusions.....	153
SECTION XIX.	
The Field of Binocular Vision.....	164
SECTION XX.	
Of Corresponding Points.....	166
SECTION XXI.	
The Horopter.....	177
SECTION XXII.	
The Directions of the Apparent Vertical and Horizontal Meridians....	194
SECTION XXIII.	
Voluntary Torsion and its Physiological Effects.....	200

SECTION XXIV.	PAGE
The Normal Direction of the Planes of Vision in Relation to Certain Cranial Characteristics.....	203

PART III.

ANOMALOUS CONDITIONS OF THE MOTOR MUSCLES OF THE EYES
CONSISTENT WITH THE PHYSIOLOGICAL STATE.

SECTION XXV.	
Synopsis of the Classification.....	214
SECTION XXVI.	
Exposition of the Classes.....	217
<i>Class I.</i>	
Relations of the Normal Plane of Vision of the Individual to the Cranium.....	217
Anophoria and Katophoria.....	217
Anotropia and Katotropia.....	223
SECTION XXVII.	
Determination of the Extent of the Rotations of the Eyes.....	225
The Tropometer.....	225
Treatment of Anophoria and Katophoria.....	231
SECTION XXVIII.	
<i>Class II.</i>	
Declinations, or the Normal Declinations of the Retinal Meridians....	233
Instruments for Determining Declinations.....	237
Some of the Relations Between Declinations and Heterophoria.....	242
Empirical Scheme for some of the Relations of Declination and Heterophoria.....	245
Heterotropia, or Strabismus and Declination.....	248
Local Symptoms of Declinations.....	249
Astigmatism and Myopia.....	251
Declinations, the Contour of the Brows and the Relative Positions of the Eyes.....	252
Pose of the Head from Declination.....	254
Other Symptoms.....	255
Treatment of Declinations.....	256
SECTION XXIX.	
<i>Class III.</i>	
Accommodative Axial Adjustments.....	257
SECTION XXX.	
Difference of Degree of Anomalous Conditions of the Motor Muscles...	258
SECTION XXXI.	
Equilibrium.....	260
SECTION XXXII.	
Orthophoria.....	261
SECTION XXXIII.	
Heterophoria.....	261

	PAGE
SECTION XXXIV.	
Principles of Examination in Heterophoria.....	263
SECTION XXXV.	
Significance of Heterophoric Conditions.....	270
SECTION XXXVI.	
Time for Attending to the Anomalies of Heterophoria.....	271
SECTION XXXVII.	
Specific Methods and Instruments for Examinations in Heterophoria..	272
SECTION XXXVIII.	
Esophoria.....	286
SECTION XXXIX.	
Exophoria	288
SECTION XL.	
Hyperphoria.....	291
SECTION XLI.	
Nature and Causes of Heterophoria.....	297
SECTION XLII.	
Summary of Procedure in Examinations for Heterophoria, Anophoria, Katophoria and Declinations.....	302
SECTION XLIII.	
Clinical Features of the Non-Strabismic Anomalies of the Ocular Muscles.....	306
SECTION XLIV.	
Facial Expressions Resulting from the Conditions of the Eye Muscles..	318
SECTION XLV.	
General Treatment of Non-Strabismic Anomalies.....	327
The Use of Prisms.....	330
Gymnastics for Declination.....	331
Prisms Worn as Spectacles.....	333
Decentering of Spherical and Cylindrical Glasses for Obtaining Pris- matic Effect.....	334
SECTION XLVI.	
Surgical Treatment.....	336
Operative Treatment of Declinations.....	340
Procedure in Anophoria and Katophoria.....	345
Operative Treatment for Heterophoria.....	347
Graduated Tenotomy.....	348
Tendon Contraction.....	352
SECTION XLVII.	
Heterotropia—Strabismus	354
Deviation in Exclusion.....	372
Tests by Diplopia.....	373
SECTION XLVIII.	
Esotropia—Converging Strabismus.....	378
Exotropia—Diverging Strabismus.....	382
Hypertropia—Strabismus Sursumvergens.....	384

	PAGE
SECTION XLIX.	
Anotropia and Katotropia—The Two Forms of Double Vertical Strabismus.....	388
SECTION L.	
Periodic or Intercurrent Strabismus.....	393
SECTION LI.	
Causes of Strabismus.....	395
SECTION LII.	
The Relations of the Function of Accommodation to that of Convergence	397
SECTION LIII.	
Hereditv of Strabismus.....	407
SECTION LIV.	
A Table of Strabismus Cases.....	408
SECTION LV.	
Treatment of Strabismus.....	414
Surgical Treatment.....	418
The Empirical Method.....	421
SECTION LVI.	
Results of Treatment of Strabismus.....	422
SECTION LVII.	
Resumé of the Operative Treatment of Strabismus.....	423
SECTION LVIII.	
Antipathy to Single Vision.....	426
SECTION LIX.	
<i>Class IV.</i>	
Nystagmus—Talantaopia	436

PART IV.

ANOMALOUS CONDITIONS OF THE MOTOR APPARATUS OF THE EYES
NOT CONSISTENT WITH THE PHYSIOLOGICAL STATE.

SECTION LX.	
<i>Class V.</i>	
Colytopia—Spasm, Paralysis, Obstruction, etc.....	444
SECTION LXI.	
Spasm. Spasmodic Colytopia.....	446
Word Blindness. Psychic Colytopia.....	450
SECTION LXII.	
Paralysis. Paralytic Colytopia.....	452
Paralysis of the External Rectus.....	455
Paralysis of the Internal Rectus.....	457
Paralysis of the Superior Rectus.....	457
Paralysis of the Inferior Rectus.....	460
Paralysis of the Superior Oblique.....	460
Paralysis of the Inferior Oblique.....	464

	PAGE
SECTION LXIII.	
Relations of the Double Images in Paralysis of the Ocular Muscles....	466
SECTION LXIV.	
Objective Manifestations of Paralysis of the Ocular Muscles.....	466
SECTION LXV.	
Limitation of Action of the Paralyzed Muscle.....	469
SECTION LXVI.	
Measurement of the Deviations of Paralysis.....	469
SECTION LXVII.	
Nuclear Paralysis.....	470
Nuclear Paralysis of the Oculo-Motor Nerve.....	474
Total Oculo-Motor Paralysis.....	475
SECTION LXVIII.	
Causes of Nuclear Paralysis.....	479
SECTION LXIX.	
Fascicular Paralysis.....	483
Peripheral Paralysis.....	485
SECTION LXX.	
Obstructive Colytopia.....	485
SECTION LXXI.	
Traumatic Colytopia.....	486
SECTION LXXII.	
Arrested Development of Ocular Muscles.....	487
SECTION LXXIII.	
Treatment of Colytopia.....	488

LIST OF ILLUSTRATIONS.

FIG.	PAGE
Portrait of Dr. John Taylor	Facing 26
1. Eye Muscles of Cod (<i>Morrhua Americana</i>). (Colored).	30
2. Head of a Frog (<i>Rana fontinalis</i> , Showing the Muscles of One of the Eyes. (Colored.)	31
3. Head of Winter Gull (<i>Larus argentatus</i>), Showing a Dissection of the Eye Muscles. (Colored.)	33
4. The External Muscles of the Eye of the Domestic Sheep. (Colored.)	34
5. The Orbits	36
6. The External Wall of the Orbit	37
7. The Internal Wall of the Orbit	38
8. Vertical and Transverse Diameters of the Orbit	41
9 to 11. Characteristic Forms of the Orbits	44
12. Stevens's Craniostat for the Examination of the Planes of the Orbit .	45
13. The Motor Muscles of the Eyes. (Colored).	49
14. Schwalbe's Scheme of the Origin of the Eye Muscles at the Posterior Portion of the Orbit of the Right Eye	50
15. Diagrams Indicating the Insertions of the Muscles in Three Pairs of Eyes of Young Persons	57
16. Design by the Author to Indicate the Relative Insertions of the Different Muscles into the Sclera	59
17. Diagram Indicating the Arrangement of the Capsule of Tenon, from a Side View. (Colored).	62
18. Investment of the Muscles of the Eye by the Capsule of Tenon . . .	64
19. 1, Sclera. 2, Tendon. 3, Fold of the Capsule. 4, External Layer of the Capsule	66
20. Arteries Supplying the Muscles of the Eye. (Colored).	70
21. Distribution of the Nerves of the Muscles of the Eyes. (Colored). .	71
22. Diagram Indicating the Origin of the Third and Fourth Nerves . . .	73
23. Diagrammatic Representation of Mid-brain with Approximate Situations of the Nuclear Groups from which Arise the Third, Fourth, Fifth, and Sixth Nerves	75
24. Scheme Showing the Different Groups of Nervous Cells which Constitute the Nuclear Origin of the Common Oculo-motor Nerve . . .	77
25. Professor Bernheimer's Diagram of the Nucleus of the Oculomotor and of the Trochlearis Nerves. (Colored).	81
26. Bernheimer's Diagram of the Connections of the Nuclei of the Oculo-motor Nerve and the Cortex	82
27. Arteries Supplying the Pons Varolii and Mid-brain	85
28. Position of Images as shown by Ophthalmometer	88

FIG.		PAGE
29.	Planes of the Head	91
30.	Diagram Indicating the Traction Direction of the Lateral Recti with the Axis of Rotation by these Muscles	95
31.	Direction of Traction of the Superior and Inferior Rectus and the Axis of Rotation by them	97
32.	Position of Vertical Meridian of the Cornea with Different Directions of the Eye	99
33.	Direction of Traction of the Superior and Inferior Oblique Muscles with the Axis of Rotation	100
34, 35.	Stevens's Ophthalmotrope	114
36, 37.	Positions of Accidental Images. (Colored).	116
38.	Diagram from Helmholtz	117
39.	Position of Accidental Images from a Vertical Line	118
40.	Illustration of Correspondence of the Images	123
41.	Illusion of Height and Breadth	132
42.	The Muller-Lyer Illusion	132
43.	Geometric Illusion, after Hering	133
44.	Geometric Illusion, after Wundt	133
45.	Zollner's Figure	134
46.	Diagram Illustrating Angle of Movement	135
47.	Geometric Illusion, after Lehmann	136
48.	Poggendorff Illusion	137
49.	Schroder's Diagram	139
50.	Diagram representing the principle of Wheatstone's Stereoscope	144
51.	Brewster's Stereoscope. (Colored).	145
52.	Diagram Illustrating Blending of Images	147
53.	Landolt's Stereoscope for Reestablishing Binocular Vision	149
54.	The Stereostroscope	150
55.	Wheatstone's Pseudoscope	152
56 to 61.	Stereoscopic Diagrams 156, 158, 160, 161, 162,	163
62.	The Common Field of Vision	165
63.	Maculas and Corresponding Points According to the Accepted Doctrine	168
64.	Volkman's Diagram	170
65.	Retinal Corresponding Points	171
66.	Diagram Illustrating Different Positions of Images	174
67.	Helmholtz's Figure Indicating the Position of the Horopter when the Eyes are directed toward the Horizon	179
68 to 73.	Diagrams for Ascertaining the Horopter. 185, 186, 187, 188,	189
74.	Clinoscope Objectives	197
75.	Diagram for Testing Meridians	198
76.	Helmholtz's Squares	199
77.	Torsion Objectives	201
78.	The Long Head, from above	205
79.	The Tall Head, from above	205
80.	The Broad Head, from above	205
81.	The Long Head, side view	206
82.	The Tall (Medium) Head, side view	206
83.	The Broad Head, side view	206

FIG.	PAGE
84. Broca's Calipers	206
85. Author's Facial Goniometer	207
86. The Author's Method of Determining the Axis of the Orbit	208
87. Front View of Long Skull	209
88. Front View of Tall Skull	209
89. Front View of Broad Skull	209
90. Stevens's Tropometer	226
91. The Tropometer Scale	227
92, 93. Before and After Correction of Katophoria	232
94. Diagram Illustrating Declination	235
95. The Clinoscope	238
96. Objective Lines for the Clinoscope	239
97. The Lens Clinoscope	239
Method of Testing the Clinoscope	240
98 to 101. Diagram Illustrating Relations of Declination and Heterophoria. (Colored).	246, 247
102. Diagram Illustrating Diplopia Induced by Prism	264
103. Diagram Illustrating Diplopia	265
104. Author's Phorometer	273
105. Author's Improved Rotating Prism Slide	274
106. Maddox Rod	276
107. Author's Stenopaic Lens	277
108. Form of Images by the Author's Stenopaic Lens	278
109. The Long Head with Prognathous Face	314
110 to 113. Carriage of Head with Various Peculiarities of Adjustments of Eyes	316, 317
114. Expression of Eyebrows	319
115, 116. Asymmetrical Positions of Eyes in Declination	320
117, 118. Expressions of Eyebrows	321, 322
119. Typical Adjustment of the Facial Muscles with Orthophoria	323
120. Typical Adjustment of the Facial Muscles with Exophoria	323
121. Typical Adjustment of the Facial Muscles with Exophoria	324
122. Typical Adjustment of the Facial Muscles with Hyperphoria	324
123, 124. With a High Degree of Esophoria	326
125, 126. With Typical Expressions of Exophoria	326
127, 128. Before and After Correction of Hyperexophoria	327
129. The Rod Clinoscope	332
130. Objectives for Clinoscope	332
131. Diagram Illustrating Decentering of Lens for Prismatic Effect.	335
132. Diagram Illustrating the Change of the Line of Insertion of the Ten- don of the Internus	342
133. Flexible Eye Speculum	343
134. Lid Retractor	343
135. Fine Forceps	343
136. Scissors	343
137. Fine, Sharp Hook	343
138. Small Tendon Hook	343
139. Grooved Director	343

FIG.	PAGE
140. Needle-holder	343
141. Lance Probe	343
142. Catch Forceps	343
143. Diagram of Stevens's Operation for Tenotomy	349
144. Diagrammatic Representation of von Graefe's Operation for Tenotomy	350
145, 146. Diagrams Illustrating Deviations of the Eye	363, 364
147 to 149. Two Cases of Convergent Strabismus and One of Paralysis	380
150, 151. Indicating the Compound Direction of the Deviating Eye in Diverging Strabismus	383
152. Left Eye in Fixation, Right Deviating up	391
153. Right Eye in Fixation, Left Deviating up	391
154 to 157. Cases of Converging Strabismus Depending on Vertical Deviations and after Treatment Directed to the Superior Recti only	392
158, 159. Showing the Correction of a Converging Strabismus by a Weak Prism with its Base Down	400
160 to 162. Influence of a Convex Glass in Correcting an Inward Deviation	401
163 to 165. Various Forms of Deviation, Depending on Choice of Fixation	404
166. Insertion of Tendons	406
167, 168. A Case of Strabismus at Different Periods of Life	419
169, 170. Results of Over-correction of Converging Strabismus	426
171. A Case of Converging Strabismus which Changed to Diverging Strabismus in Later Life	431
172. Slight Diverging Strabismus Succeeding the Convergence Seen at Fig. 171	431
173. Diverging Strabismus Converted into the Converging Form by the Instillation of Atropine	432
174. Diverging Strabismus which in Youth Became Marked Converging Squint	433
175. Motor Area for the Eyes, according to Beevor and Horsley	449
176, 177. Paralysis of External Rectus, Left Eye	456
178, 179. Paralysis of Superior Rectus of Right Eye	457
180. Diagram Indicating the Relative Positions of the Images in Paralysis of Individual Muscles of the Right Eye	468
181. Arm of Stevens's Perimeter	470
182. Professor Bernheimer's Diagram of the Nucleus of the Oculomotor and of the Trochlearis Nerve	473
183. Ophthalmoplegia Externa in an Adult	476
184. Paralysis of the Third Nerve in a Child	478

INTRODUCTION.

HISTORICAL NOTES OF STRABISMUS AND OTHER ANOMALIES OF THE EYE MUSCLES.¹

ONLY the notable defects in the directions of the eyes were likely to have been taken into account by the ancients. The lesser anomalies were unobserved until very recent times.

Of the notably conspicuous defects there was the dubious gaze of the diverging squint; then there was the sinister and contracted visage of the converging squint, and lastly there was the convenient vertical squint that enabled its possessor to keep "one eye on the pot and the other up the chimney."

Only these forms of deviation from the positions most agreeable to see claimed the attention of the observer until quite within our own day.

We may then divide our subject into two periods of time, each of which will be characterized by the forms of defect observed. Thus, the first period will be that of the recognition of strabismic affections, while the second period will include also the recognition and study of the lesser affections, which are now known as those of heterophoria.

FIRST PERIOD—STRABISMUS.

In the earliest medical writings mention is made of strabismus. Yet, as it was in the times of those early writings regarded as a permanent deformity rather than as a defect which might yield to treatment, only meager space was assigned to its discussion.

Hippocrates, whose works date about twenty-two centuries ago, mentions distortion of the eyes as one of the consequences of epilepsy in children.² He also recognizes it as an inherited defect, reasoning that, as children with bald heads are born to bald-headed parents, so parents with squinting eyes have also squint-eyed children.

¹ This introduction was read before the Western Ophthalmologic and Otolaryngologic Association, at New Orleans, February, 1899. It has been subjected to only very slight revision in order to adapt it to this work.

² "The Genuine Works of Hippocrates," by Adams, New York, p. 217.

Celsus, in the first century of our era, devotes a short paragraph to strabismus and paralysis of the eye muscles.

It is only after some centuries that we find authors giving more attention to the defect as one susceptible to amelioration by proper treatment.

Paulus Ægineta, a celebrated Greek medical writer of the seventh century, recommended the wearing of a mask which should extend below the nose and through which there should be an opening for each eye, so placed as to induce the eyes to assume direct positions in order to see through these openings.

And Ambroise Paré, the pioneer in scientific surgery of France, and whose works were published from about 1561 to 1577, describes strabismus (squint-eyes) as a distortion of the eyes with inequality of vision. It originates, he says, when the cradle is placed in such a way that the child sees the light on one side, or when the nurse squints and the child imitates her. For treatment he adopts the mask of Paulus Ægineta, and he also recommends spectacles of horn attached to a leathern band and perforated in the middle of each of the discs of horn.

Paré's aetiology of squint has come down through the centuries, and even at the present time there are oculists who claim to be *en rapport* with modern ophthalmology who gravely inform the parents of their young patients with devious directions of the visual axes that the fault was with the cradle or with the nurse or companion.

Later still Antoine Maitre-Jan¹ states that some authors attribute the malady to the crystalline lens, believing that it is situated irregularly or that it is pushed to one or the other side; while other authors, he says, regard the trouble as one involving the whole eye or attribute it to certain imaginary vices of the visual spirits; still others regarding it as a spasm or retraction of some of the muscles of the eye.

The learned author himself accepts none of these theories, but places the defect to the credit of the cornea as one of its many affections. He comprehends squinting in the same class as myopia, and says that the two conditions are really one.

The author then discourses learnedly on the refraction and adds that it follows also that those who squint see objects larger than those who do not, and that they see better at night and can read better by moonlight.

¹"Traité des Maladies de l'Oeil," 1707.

Indeed there appear so many advantages in the strabismic condition that the distinguished author makes no suggestion for improvement.

For much of the neglect and many of the misconceptions regarding the nature of strabismus in early times we may, perhaps, find an explanation in the fact that during the early periods of what is known as medical history it was unlawful and sacrilegious to make dissections of the human body. This difficulty had, however, been in a great measure overcome in the time of the writer just quoted, and indeed, some of the most beautiful engravings of dissections of the eye and its muscles are to be found in the works of the seventeenth and eighteenth centuries.

It was in the very beginning of the nineteenth century that Tenon gave to the world his descriptions of the anatomy of the parts within the orbit,¹ which have remained classic till the present time. On the other hand, the fact that dissections had not shown any disease or appreciable defect of the muscles toward which strabismic eyes turned, may have caused the withdrawal of attention from the muscles as a direct cause of the defect and thus have delayed the practice of the treatment which was adopted during the last half of the nineteenth century.

Erasmus Darwin² asserts that squinting is generally owing to "one eye being less perfect than the other; on which account the patient endeavors to hide the worst eye in the shadow of the nose that his vision by the other may not be confused.

"Calves, which have an hydatid with insects inclosed in it in the frontal sinus of one side, turn toward the afflicted side; because the vision on that side by the pressure of the hydatid becomes less perfect"

In regard to treatment he continues: "If the squinting has not been confirmed by long habit, and one eye be not much worse than the other, a piece of gauze stretched on a circle of whale bone, to cover the best eye in such a manner as to reduce the distinctness of vision of this eye to a similar degree of imperfection with the other, should be worn some hours every day, or the better eye should be totally darkened by a tin cup covered with black silk for some hours daily."

¹Tenon: "Memoirs et d'Observations sur l'Anatomie, etc., de l'Oeil," Paris, 1806.

²Zoonomia, 1801.

In more recent time Rossi¹ reported his researches on the pathology and treatment of strabismus which led him to the belief that, in strabismus, the orbital cavity "instead of having the form of a right pyramid as is natural, has that of a pyramid more or less oblique," and his treatment was similar to that of Ægineta and Paré.

Thus we have, by recalling the writings of representative authors, sketched an outline of the history of the views entertained by the learned of their times from the earliest authoritative writings in medicine up to the era of an entirely new departure in respect to the views concerning the ætiology and treatment of this defect. It is easy to see that even up to the beginning of the nineteenth century the ideas of those of highest authority were, in respect to both the ætiology and treatment, crude and confused, and that they had scarcely been modified in essential respects from those of Paulus Ægineta in the seventh century. It may be added that the subject of strabismus during a period of many years preceding the epoch of which we are presently to speak found only rarest mention in the periodical literature of the times.

Before entering upon an account of the new era, however, we may for a moment consider the relations of two persons, of most opposite character, to the progress of events in this line of surgical research.

Rather more than a century and a half ago an itinerant oculist, John Taylor by name, announced in a book which he distributed on his itineraries, and through newspapers, that he practiced the straightening of cross eyes by operation. The title of one of Taylor's pamphlets was, "De Vera Causa Strabismi,"² and he related the results claimed by his operations.

Taylor styled himself oculist of King George II of England. Elsewhere he styled himself papal oculist, ducal and court oculist, with other high sounding titles.

The following announcement³ of these operations appeared in the *Mercury of France*, in June, 1737: "Dr. Taylor, oculist to the King of Great Britain, has just arrived in Paris, at the London Hotel, Rue Dauphine, where he proposes remaining till the beginning of July, after which he will leave for Spain. He requests us

¹ Mem. Acad. Scien., Turin, T. 34. Also Neue Unters. und Erf. über das Schiel, u. s. v., Gottingen, 1841.

² Paris, Lisbonne, 1738.

³ Walton: "Diseases of the Eye," p. 366.

to publish the discoveries he has made of straightening squint eyes by a slight and almost painless operation, and without fear of accident."

Nearly twenty years later, in 1756, Heuerman, a German surgeon, published a work entitled "Abhandlung der neusten Chirurgische Operationen" in which the author thus mentions Taylor's claims¹:—

"Taylor has also proposed to cure squinting by the division of the tendon of the superior oblique muscle of the eye. But this deformity is not, in every case, produced by the contraction of this muscle; and moreover the inferior oblique muscle is apt to draw the eyeball in the opposite direction when the superior one is divided, thus giving rise to a new sort of squinting. In addition to this, the recti muscles, the contraction of which often occasions squinting, cannot be easily cut across, in consequence of their situation. We thus see that the operation performed by Taylor can only be of temporary benefit; and we cannot expect that patients will submit to it, seeing that it is attended with a good deal of pain, and its results are so uncertain."

Lucien Boyer² quotes from a long forgotten address by LeCat at the Academie des Sciences, Belles Lettres et Arts, of Rouen, the following narrative.

The writer, after noticing the danger of charlatanism which should be met not only by the medical profession but by the laws, illustrates his theme by relating that he had seen Dr. T., whose bearing and accessories he thus describes:—

"This refined and amiable man came to Rouen the —, and within a few days became the object of general admiration. He had an arsenal of superb instruments and handled them with great dexterity. He showed portfolios filled with authentic and highly commendatory credentials. The door to his hotel was guarded by soldiers and it was necessary for one to have an introduction in order to visit him. His operations were done in the midst of a brilliant circle of select persons.

"The great operation, the most marvelous of all, was that by which he proposed to straighten squinting eyes. His method was as follows: With a needle of silk he caught a portion of the conjunctiva of the squinting eye at the inferior part of the globe, and having made

¹ *Medico-Chirurgical Review*, 1842, p. 194.

² "Recherches sur l'Operation du Strabisme," 1842, p. 38.

a loop of this silk he used it to draw toward him that portion of the conjunctiva which it included, which he cut with the scissors; then he applied a plaster to the sound eye; the squinting eye at once righted itself and every one cried out, 'a miracle.'

"I availed myself of the freedom which he accorded me to inquire the motive for an operation which appeared to me to be absolutely useless, not to say dangerous. He replied that an eye only squinted because the equilibrium between its muscles was destroyed, and that to re-establish this equilibrium it was only necessary to weaken the muscle which dominated the others and that this is what he did in cutting one of the nerve filaments which was distributed to this too powerful muscle."

Whatever may have been Taylor's method, whether he divided the superior oblique as Heuerman asserts or the inferior oblique as others state, whether the brilliant and clever man described by LeCat really only cut a fold of conjunctiva, it is certain that Taylor's work had no influence in introducing the surgical method of treatment to the world. If he divided one of the oblique muscles as he was supposed to do, he did not correct the squint, and if he simply divided the conjunctiva and some supposed nervous filaments which were assumed to supply a muscle, he still did not cure the squinting. There remain two possibilities: first, that the secret of the whole operation lay in the fact stated by LeCat: he covered the sound eye with plaster; the squinting eye became straight and the people cried "a miracle." Second, and it is much more probable, however, that he cut the internal rectus, but that he did not confide too much in his not well-informed critics.

The story of Taylor is interesting for what it suggests, first in regard to himself, and second in regard to the medical profession. If Taylor really corrected squint by an operation on a lateral muscle, he would have acquired enduring fame had his discovery been made permanently known by an exact and honest description of his methods. If he carried the idea that he operated upon an oblique, when he in reality cut an internal rectus, he committed suicide for his reputation. If, on the other hand, he really cut an oblique, he made no cure and therefore has no claim to be regarded as a pioneer in the surgery of strabismus.

There is a view of the whole subject, however, which is not to be lost sight of. That Taylor was a man of learning is not to be doubted. He had studied at Leyden and at other universities. That

he was a charlatan may also be true, but the age was an age of charlatanism. His works which remain to us show that, breaking away from the theories of Maitre-Jan and of all his predecessors, he had correctly appreciated the cause of strabismus. That a man of undoubted ability and who correctly interpreted the phenomena of squinting should have resorted to a cheap trick which must have been exposed without delay, while he absolutely failed to practice the principle which he certainly understood, seems incredible.

That no published description is known or seems to have been known is certain. But it is too true that in medical, as well as in other fields of science, a truth not acceptable or not understood by the contemporaries of the discoverer is either distorted in transmission or altogether lost to the world by neglect. The fact that we know of no detailed description is not evidence that there was none, and the description of the distinguished LeCat would not be further from a true comprehension of the actual facts, in case Taylor really performed a tenotomy of the internus, than is shown by distinguished authorities of the present time when they attempt the description of some procedure with which they are not fully in sympathy.

The history of Taylor's claims is therefore interesting in its bearings upon some characteristics of the medical profession.

The claim that strabismus could be corrected by relaxing "the too dominant tendon" was not only rational, but would seem to be one which should have been seized upon by the surgical mind. Doctors are, however, like other men, and the fact that Taylor was an itinerant and therefore assumed to be a man of no scientific authority, instead of setting men to think in the right way, prompted them only to oppose the idea as unscientific.

Let us now turn to a person of widely different character.

The mention of the name of Charles Bell suggests at once to the mind a series of researches in respect to the anatomy and physiology of the nerves which were in the highest degree epoch-making. It is needless to mention any of these remarkable inquiries and discoveries save a single series of observations relating to the movements of the eyes.¹

In his experimental inquiries Sir Charles divided (1) the superior rectus in a rabbit and felt some disappointment on observing the

¹ Read before the Royal Society, March 20, 1823. Published as a chapter of "The Nervous System of the Human Body," 1830.

eye remain stationary. Shortly afterward on looking at the animal he saw "the pupil depressed." The animal could not raise the eye.

(2) On opening the eyelids and irritating the eye of which the superior rectus had been divided, the eye was turned up; showing, as the experimenter believed, that though voluntary motion was lost, involuntary motion remained by the influence of the obliques.

(3) Wishing to ascertain if the oblique muscles contract to force the eyeball laterally toward the nose, he put a fine thread around the tendon of the superior oblique muscle of a rabbit and appended a glass bead to it of a weight to draw out the tendon a little. On touching the eye with a feather the bead was drawn up.

Experiments made on the dead body had shown him that the action of the superior oblique muscle is to turn the pupil downward and outward and that the inferior oblique "reverses this action of the eye." He concluded from the bead experiment that the combined action of the two oblique muscles is to draw the eye to the nose.

(4) He cut through the tendon of the superior oblique muscle of a monkey. He saw no change in the appearance or movements of the eye.

(5) A similar result followed section of the inferior oblique.

From these experiments he considered it proved that division of the oblique muscle does not affect voluntarily motions by which the eye is directed to objects, and that division of the recti does not prevent involuntary motions.¹

In the experiment on the superior rectus muscle the learned investigator saw the eye dropped from its normal direction yet still able to move upward. We are led to wonder why so brilliant an anatomist and physiologist could have turned away from the evident teaching of his own experiment. We have an instance of one who has placed before himself all the elements of a grand discovery, but who turns away from the positive to the negative teachings of the conditions which he has induced. Had an anatomist desired to prove to himself and others that squinting could not be cured by section of the obliques these experiments would have been satisfactory to him.

It not infrequently happens that the state of mind in which an inquiry is entered upon controls the result whatever may have been the facts evolved by the inquiry.

¹ In the summary of these experiments the words of the author have been employed as far as it has been found convenient.

We now enter upon the period of actual discovery of the surgical treatment of strabismus.

The process now known as the operation for strabismus was suggested and described by Stromeyer, professor of surgery in the University of Erlangen, in 1838, and the first authenticated operation was executed on the 26th of October, 1839, by Dieffenbach, in Berlin.

A full appreciation of these two stages in the discovery of what was then called ocular myotomy requires some knowledge of the contemporary tendencies of surgery. The time was emphatically a period of myotomies. The two names which figure most prominently in the introduction of the strabismus operation are also those of two among the most distinguished myotomists of the time. Stromeyer, whose first subcutaneous tenotomy of the tendo-achillis, in 1831, had fallen far short of success, had yielded to no discouragements, but had extended the process to all parts of the human body, and Dieffenbach claimed to have myotomized nearly forty different muscles, some of them a great number of times.

M. Jules Guerin, "le Grande Myotomiste" of the Orthopedic Institute of Paris, whose friends claimed for him a large measure of credit for the introduction of the strabismus operation, in an article in the *Gazette Medicale*, gave a list of the parts which he had divided by the method of subcutaneous incision which looks almost like a catalogue of the muscles of the trunk, neck, upper and lower extremities.

Such was the drift of surgical thought and action when, in 1838, there was published, at Hanover, a treatise on "Subcutaneous Orthopedics," by Prof. L. Stromeyer,¹ in which he showed that strabismus might be regarded as a vicious contraction of the eye muscles and that the same treatment might be applied to it as to club-foot. He fully described the procedure by which the operation could be done and reported the effect of many tenotomies done by his method on the dead subject. For a time no attention seems to have been attracted to Stromeyer's views of squint, but at length it was noised abroad in all lands that Dieffenbach, of Berlin, had applied the method of Stromeyer to the living subject.

In February, 1840, Dieffenbach communicated his discovery to the French Academy of Sciences, which at the time was offering the Moynton prize for a notable discovery in medicine and surgery, but

¹ Beiträge zur Operativen Orthopädie u. s. v., Hanover, 1838.

to the commission having the matter in charge the claim of the Berlin surgeon appeared so improbable that it was regarded rather as a burlesque than a serious claim for the award. Still later Dieffenbach forwarded a second communication in which he not only reported many cases, but gave the minute details of the process and of the progress of the new operation.

From this time the medical journals in which the mention of strabismus had been only at intervals of years, teemed with articles on the now interesting topic.

The commission of the Academy of Sciences could now no longer withhold its recognition of the great value of the discovery and in awarding the prize the commission reported: "The commission has the honor to propose to the Academy to award Messrs. Stromeyer and Dieffenbach a prize of six thousand francs to be divided between them. They awarded it to M. Stromeyer for having first conceived and executed the operation of strabismus upon cadavers, and to M. Dieffenbach for having first successfully practiced the operation upon the living man."¹

It will be interesting and profitable to inquire into the methods and principles involved in these early operations, and to trace any modifications which may have resulted from larger experience and fuller examination of the subject.

Dieffenbach's first operation, described in *Medicinische Zeitung*, November, 1839, omitting the details of fixation of the eye and the lids, details not essential to the method of operating, consisted in "cutting through the conjunctiva and separating the connective tissue," then "dividing the internal rectus muscle, using scissors, *close to its insertion*. The eye was immediately drawn outward by the external rectus, as if it had received an electric shock; and in another instant became straight. . . ."

In his second case "the operation was performed as in the last case, the conjunctiva being cut through and the sclerotic laid bare to the extent of four lines, in order to bring the muscle into view, which was cut with a curved scissors as before."

Mr. P. Bennett Lucas, one of the earliest of English surgeons to perform the operation of Dieffenbach, describes his operation in the *Provincial Medical and Surgical Journal*, October, 1840. After dividing the conjunctiva and the connective tissue to the desired

¹Space does not permit of mention of the many claims which were set up for priority as soon as the operation became a success.

extent, "the blunt hook being inserted beneath the muscle, the operator transfers it to the left hand, and having brought the tendon into view, he divides it with a sharp-pointed pair of scissors *as close to its insertion as is compatible with the safety of the sclerotic.*"

Mr. Liston also, in the *London Lancet*, 1840, says: "With a little dissection the muscle is seen just as it ends in its tendon, and with a pair of scissors it is cut across *close to its insertion into the sclerotic.*"

It thus appears that in the earliest history of the operation it consisted essentially of a division of the conjunctiva over the insertion of the tendon, usually about a third of an inch in extent, introducing a probe or blunt hook beneath the tendon and dividing the latter with a pair of scissors *close to the sclerotic.*

The cure of strabismus soon became a show operation, and while the political press teemed with columns of sensational descriptions of the operation, surgeons plunged with a will into a system of charlatanism and surrounded themselves with admiring crowds to witness the miraculous changes which their art could produce. As is usual when surgery is done for popular applause, the question of the best method for obtaining best effects became an entirely secondary one and tenotomies soon gave place to myotomies. Dieffenbach himself led in the degradation of his operation and asserted that the further back the muscle is divided the more effectually will the more pronounced cases of strabismus be relieved. "If," he says,¹ "the conjunctiva be divided over a greater arc and toward the back of the globe, if the cellular tissue be extensively separated and the muscle be detached far back and divided at its middle, then the eye, even in cases in which the whole cornea was hidden in the internal angle, stands quite straight after the operation."

The practice of dividing the tendon at some distance from the sclera was continued for a number of years. The text and illustration descriptive of the operation in the edition of 1854, of McKenzie's "Treatise on the Eye," shows the section of the tendon several lines removed from the sclera. That a reaction against the operation set in was but the legitimate result of these extravagant destructions of the rotating powers of the eyes.

It was in this stage of repudiation by a large proportion of conservative surgeons that the great authority of von Graefe called his

¹ Casper's "Wochenschrift," July, 1840, quoted in Braithwaite's "Retrospect."

colleagues to a return to a more conservative policy. He advised that the incision in the conjunctiva be made near the cornea, that the section of the tendon be made close to the sclera, and that in all but cases in which extensive effects were required, a suture should be introduced in the conjunctival wound. - In pronounced cases he divided the whole of the tendon and all the surrounding connective tissue with the capsule; in less pronounced cases the connective tissue was less completely divided, and in slight cases he severed the tendon except the upper or the lower border of a lateral muscle or an inner or an outer border of a vertically acting muscle, a process which he termed partial tenotomy, and which must of necessity have been accompanied by a tilt of the globe, a condition as little to be commended as the myotomies of his predecessors. In all essential features this operation became the standard operation in all countries, and with slight modifications representing the fancy of individual operators has remained the classic operation in all the text-books to the present time.

A moment's reflection will show that the operation as laid down by von Graefe and repeated in the current text-books is that executed and described by Dieffenbach, Lucas, Liston, and other pioneers in the operation, and that the real difference between the modern procedure and that of the earliest operators consists in the details of holding the lids apart and of fixing the eye.

It will not be without interest to compare the text and illustrative figure referring to the operation in the text-book of Desmarres, 1847, and the corresponding text and illustrations from the more modern text-books.

It will not be out of place here to inquire into the exact meaning of one expression which characterizes the rule given by the early operators and that given by von Graefe. We are told by both authorities to perform the section of the tendon as nearly as possible to the sclera. And the question arises as to the precise meaning of the phrases in which this direction is given.

If we are to accept the illustrative figures which accompany the modern text-books as representing the operation, if we are to accept the ordinary practice of the great majority of surgeons who follow the teachings of von Graefe, and especially if we consider the instruments which are generally figured and used, it becomes evident that these phrases are intended to teach that the section is to be made in the near vicinity of the sclera, but that a dissection of the tendon at its very union could not be intended. Such a dissection would be almost

out of the question with the instruments employed by von Graefe and which are still quite in vogue.

As a matter of fact in these operations, done according to the prevailing method, the section is made at a few millimeters from the globe.

From the aetiological point of view there has been, during the half-century and more since the introduction of the surgical treatment of squint, omitting for the present any reference to any suggestions of my own, one notable doctrine, that of Donders, which he formulated as follows:—

1. Strabismus convergens almost always depends upon hypermetropia.

2. Strabismus divergens is usually the result of myopia.

These propositions were at once universally accepted, yet there is to-day quite sufficient reason for revising the judgment of the profession, for there is adequate ground for saying that the doctrine of Donders rests upon neither theoretical nor practical grounds. With the exception of the doctrine of Donders, the accepted views respecting the aetiology of strabismus have in the profession at large undergone slight change during the half-century.

In the meantime if some views which I have myself advanced are at least new, it is not my purpose to discuss them in this connection, beyond saying that by the aid of the tropometer and the clinoscope we may now arrive at the conditions underlying the great majority of cases of squint with so much certainty that we are able to relieve the defect without inducing another, as was the universal rule under the former regime.

In the half-century, much careful work has added to the stock of precise anatomical knowledge of the muscles of the eyes and their insertions. Observations from a physiological standpoint have also furnished material not accessible a half century since which permits of more correct conclusions.

The different varieties of concomitant strabismus were described in the years immediately following the introduction of the operation for tenotomy of the recti muscles much as they are to-day in the best text-books.

SECOND PERIOD—HETEROPHORIA.

ANOMALIES OF THE EYE MUSCLES LESS THAN STRABISMUS.

Leaving for the present the subject of strabismus, we may trace the history of the progress of knowledge in respect to those anomalies of the eye muscles less conspicuous, but as experience is proving, no less important, which are at the present time known under the generic term *heterophoria*. To these anomalies may be added those of declination and those others which may be investigated by the tropometer.

While it is true that the names of some of those who have been identified with the progress of modern ophthalmology have been also identified with a *single aspect* of this special branch of the subject of anomalies now to be considered, it is also true that previously to my own contributions, not only had attention been directed exclusively to this single aspect, but even in respect to that no clear and definite views were entertained.

In 1857 von Graefe called attention to a form of strabismus, less evident to the general observer than the recognized form, which he termed latent strabismus or insufficiency of the internal recti, which was characterized by an ability to hold the images of the two eyes in union while the gaze was directed at distant objects, but by deviation of one eye outward when a near object was looked at. Thus, if a pencil were held in front of the subject of this defect and the eyes were directed toward it, the axis of each eye appeared to be directed to the object until it approached as near as the reading distance, when one eye deviated outward. This condition he found mostly in cases of myopia of high degree and, as just mentioned, he called it "Insufficiency of the Internal Recti Muscles."¹

There is no reason to suppose that von Graefe designed by this term to intimate that the internal recti were weak; that interpretation was the result of an imperfect understanding on the part of some who did not fully comprehend the meaning of von Graefe's language. Von Graefe's meaning was, that in these cases of myopia, where the object must be held close to the eyes and the tendency of the lines of sight was

¹"Another source of asthenopia is quite independent of the accommodative function, and lies in the contractile ability of the inner eye muscles. I have several years since spoken of this form as 'Insufficiency of the Internal Recti Muscles,' etc. V. Graefe, Arch. f. Oph. viii, ii, 315, 1861.

outward, greater than normal tension was required of the interni and they were insufficient for the unusual task. This is the meaning which runs through all his writings on the subject. He speaks of the *contraction excess* required to induce the proper convergence, not the contraction weakness. True, he mentions the general muscular weakness attending convalescence from severe illness, but he includes such cases in a class by themselves. They are temporary cases which result in "spontaneous recovery."

This condition of insufficiency of the internal recti he regarded as a cause of asthenopia equal to hypermetropia and he proposed methods for examinations and treatment. In examining he used the method already mentioned, the fixing of the gaze upon a pencil as it was made to approach from a distance.

For more accurate measurement of the deviation a prism was held with its edge up before one eye while the patient looked at a card held a foot or more in front of the eyes and on which was drawn a vertical line with a dot in the middle. If this line separated and the dots separated heteronymously there was insufficiency of the internal recti to the extent of the value of the prism which, held horizontally, would throw the two dots on a single line.

Von Graefe employed spectacles of prisms with their bases in for the relief of this condition, but he preferred the more radical method of dividing the external rectus of the deviating eye or, more rarely, of both externi, to the extent that the dots would continue on the one vertical line. He was willing to sacrifice single vision at the distance, causing homonymous diplopia by his operation, for since these people were mostly myopic, the homonymous double images would, in his estimation, cause little inconvenience, while the object sought, the ability to converge at near points, would be accomplished.¹

This was practically the whole doctrine of "insufficiency" up to the time when more especial attention was called to these conditions by myself. In all the text-books and in all the current literature, so far as the subject received any notice, muscular asthenopia was "insufficiency of the interni."

It is true that there were a few references to "insufficiency of the externi." It requires but a glance at these references to see that they related generally, if not in every instance, to moderate cases of converging strabismus. To this we shall presently return.

¹ *Loc. cit.*, p. 348.

Von Graefe left to the world, among his richest contributions to the literature of science, extensive memoirs upon subjects connected with the ocular muscles, replete with the evidences of his great powers of observation and of his remarkable genius.

His observations were those of a pioneer. They were not complete and the interpretations conformed to the modes of thought of his time. His conclusions were influenced by his environments.

To return to the single phase of the conditions now known as heterophoria to which his observations were confined, it may be said that even that phase in its broader signification scarcely, if at all, occupied his attention.

Von Graefe regarded the ability to direct the axes of the two eyes to the same point at the visual distance of reading, especially of myopic eyes, without excessive effort, as a practical standard of "equilibrium." He taught that this should be gained even at the expense of very great loss of equilibrium at greater distances.

No such standard as he assumed could be now accepted. Equilibrium does not exist when the power of fusion has been gained at one point at the expense of difficulty, or impossibility, of fusion at another. The doctrine that equilibrium must be attained by inducing fusion at all distances equally and with no abnormal effort was first insisted upon by myself and has now become, at least in America, universally accepted.

In order to make this retrospective view more effective it will be of interest here to reproduce the views which were standard when my own contributions to the subject commenced.

Von Graefe, as has been observed, performed his operations for "insufficiency of the internal recti" entirely in the interest of uniting the visual lines at the near point, generally of extremely myopic people. The near point was in such cases extremely near. In his treatise on "Asthenopia," he says¹:—

"As point of departure (for tenotomy of the externus) we must choose according to the reading distance of the subject. . . . If we should do a little too much it would not cause, at the near point, the least trouble. Strabismus convergens could only occur if we have exceeded the measure of *the total abduction*. . . . There will then become necessary at the distance a tension of the externi. *This in itself is, fortunately for the tenotomy, of no consequence, as for the act of vision at the distance the same results from continuous strain*

¹ Archiv für Ophthal., viii, 2, 349.

do not occur. Against this, however, occurs a real trouble. If, in the main, the power of the externi is no longer sufficient for fixation at the distance, strabismus convergens with homonymous diplopia is the result. When, in brief, will this occur? Necessarily, if the definite effect of the tenotomy does not correspond to the *extremest abduction* for the distance. We therefore find the measure for the tenotomy by ascertaining the strongest prism which can be overcome by divergence for the distance. The linear deflection which corresponds to the prism we can remove without harm in order to take from the interni at the near as much work as possible.

“After such an adjusted tenotomy, binocular fixation for the distance takes place with *the greatest strain for the externi*. What is then required of the externi for the distance favors the interni at the near point.”

Von Graefe often operated in this way, causing 15° or 20° homonymous diplopia at distance in the hope that at some time the annoyance from the double images might disappear. Further on, in illustrating the grades of “insufficiency” and the treatment, von Graefe says:—

“Let a second patient have, at the near point, insufficiency (prism) 16° , at the distance (v. Graefe regarded three meters, six meters, etc., indifferently as distance), insufficiency 6° with abduction (prism) 16° . We can take from him by tenotomy the full insufficiency for the near as that is equal to the abduction for the distance; thus he will now be just able to fix for the distance though with *the greatest possible strain* of his abducting power, to which, *as we have already found, there is no objection.*”

I have quoted at some length the words of the master in order to show the meaning of his term “insufficiency of the interni” and to throw light on a question which will presently arise, whether the fact of the existence of an opposite condition had in his mind any importance.

It will be seen that “insufficiency” was exclusively confined to the condition of difficulty in convergence at very near points and that any other so-called insufficiency was of no account. A condition barely short of converging strabismus was entirely satisfactory and one of slight converging strabismus not especially objectionable and what objection might exist was attributable, not to the strain, but to the annoyance of diplopia.

The “Insufficiency of the Interni” of von Graefe was the condi-

tion of its class recognized in the text-books at the time that attention was called by myself to the imperfection of the doctrine.

Soelberg Wells¹ devoted a section to the discussion of "Muscular Asthenopia (insufficiency of the interni)." His tests for the affection were made at the near point. In determining abduction and adduction he removed the object to a distance of from 6 to 10 feet.

Galezowski² discussed "latent divergent strabismus," or muscular asthenopia, and says that muscular asthenopia is due to "insufficient contractile force of the interni recti." His only test, like that of Wells, was the dot and line of von Graefe and made at a distance of 15 centimeters from the eyes.

Landolt³ defined muscular asthenopia as "insufficiency of the internal recti muscles." In later writings he lays much stress upon "insufficiency of convergence,"⁴ but he had not when my classification of these anomalies was published, modified his definition. Stellwag⁵ said: "The immediate cause of asthenopia is *always* the overburdening of the muscle of accommodation, or of the *internal recti*, as the case may be." In a single sentence in one edition there appears a recognition of "insufficiency of the externi" as a possible cause of asthenopia.

Schweigger⁶ in his work on "Squint" devoted a chapter to "Muscular Asthenopia," which he attributed solely to insufficiency of the interni.

These representative authors fairly indicate the views of all, and their views show the importance attached to the conditions since known as heterophoria and that what was known as insufficiency of the externi was in fact a difficulty in holding the eyes converged for a very near point.

The system which is included in this work had gradually developed under my observations until in 1886 when the terminology of heterophoria was published,⁷ after which a series of papers⁸ on the "Anomalies of the Ocular Muscles" developed the system to an advanced point.

¹ "Diseases of the Eyes."

² "Maladies des Yeux," pp. 739 and 789.

³ "Manual of Examination of Eyes," translated by Burnett.

⁴ "L'Amplitude de Convergence," 1885; "Insufficient Power of Convergence," 1886; "Refraction and Accommodation of the Eye," 1886, etc.

⁵ "Diseases of the Eyes."

⁶ London translation, 1887.

⁷ Archives d'Ophthalmologie, November, 1886; New York Medical Journal, December, 1886.

⁸ In Archives of Ophthalmology, New York, commencing 1887.

The condition now known as hyperphoria had never been referred to in the literature of the profession under any name previous to my own description of it.¹ Vertical strabismus was well known. Hyperphoria or any condition to which the term is now applied was absolutely unknown.

The condition of esophoria was also not recognized.

This statement is made with due consideration of all the facts. Von Graefe, it is true, mentioned in a single paragraph "insufficiency of the externi," but the quotations which have been made above show in the most positive manner that only a moderate squint was indicated by the term. When he wrote that his patient would, after the tenotomies of the externi, "be just able to fix for the distance though with the greatest possible strain of his abducting power, to which, *as we have already found, there is no objection,*" he placed his views definitely on record.

A few other writers alluded to the condition of "insufficiency of the externi" generally as a condition which might be found by placing a red glass before one eye, when homonymous diplopia would be manifest. One of these writers, more specific than others, states that in his case there was 30° of homonymous diplopia. Another reports an operation for insufficiency of the externi on a myopic girl who had homonymous diplopia the degree of which is not stated.

Of course such cases would not for a moment now be regarded as anything but somewhat inconspicuous cases of converging squint.

Since hyperphoria was not recognized there could have been no recognition of the conditions now recognized as hyperesophoria, etc.

We come now to the only condition previously recognized which can be regarded as in any way included within my classification of 1886, and we find that while "exophoria" may be included in the very indefinite condition then known as "insufficiency of the interni," it does not by any means signify the same thing. The condition known to von Graefe, and which may be found by the dot and line test, includes all the way from a mild diverging strabismus to decided esophoria. It is not at all uncommon for persons with high degrees of esophoria to show the so-called "insufficiency of the interni" by the dot and line test.

Thus it is seen that of the conditions in my classification only one can by any stretch of courtesy be considered as a condition pre-

¹ Essay on "Functional Nervous Diseases." Submitted to the Royal Academy of Medicine of Belgium, December, 1883.

viously recognized, and that one is so restricted and defined in the classification that it is no longer the old condition. It follows that in the classification of heterophoria the new terminology was not designed to apply to familiar conditions, but was the expression of new facts by new terms.

Much more than twenty-five years ago I reported operations for the correction of definite degrees of "insufficiency of the externi," much less than strabismus. In 1881, at the International Medical Congress held in London, I reported other such cases of operative treatment, and in the essay which received the award at the competition on the subject of "Functional Nervous Diseases" offered by the Royal Academy of Medicine of Belgium, 1883, 315 cases of operative treatment were reported.

These were the first single cases and this was the first series of cases of operations for definite non-strabismic "insufficiencies of the externi." In the prize essay just mentioned was also the earliest recognition of the condition now known as hyperphoria, as distinguished from vertical strabismus.

The proposition which constituted the central thought of that essay was, that difficulties of the adjustments of the eyes are a source of nervous trouble, and, more frequently than other conditions, constitute a neuropathic tendency.

In the development of this proposition, which has continued during all these years, a refinement of methods of examination, of terminology, and of treatment have led to results which, in the early stages of the investigations, were little anticipated.

It will not be out of place here to present in brief a summary of the difference between the views which I have presented in progressive stages since 1880 and those which were previously held. And, since no one had, up to that time, materially added to or modified the doctrine of von Graefe his views are accepted as those held by ophthalmologists.

The radical difference, then, between the views taught by von Graefe and the system which has been developed in my contributions lies primarily in the fact that that great authority sought to adjust the eyes for the very near point at any sacrifice of the relations of the visual lines at greater distances short of inducing the annoyance of diplopia. His examinations at a distance were not in the interest of actual equilibrium of the ocular muscles, but in respect mainly to the

question of how much could be sacrificed to establish convergence at the reading point.

In the system, the elements of which I have from time to time presented, the ideal sought is the perfect equilibrium of all the muscular tensions, in all respects, in vertical as well as in lateral directions, so that without violence to any of the laws of movement of the eyes they may adjust in all parts of the field of regard without inconvenience and without irregular torsions.

Von Graefe, with others, spoke of "equilibrium" of the ocular muscles, but their tests were for something else. They regarded the ability to direct the axes of the two eyes to the same point at the usual distance of reading for the individual as a practical standard of equilibrium, a standard to be gained at all hazards.

Passing to the further stages in the evolution of the doctrines of anomalies of the ocular muscles I trust that I may not incur the charge of egotism if I mention these stages of progress as I have myself suggested them.

With the refinements of diagnosis came refinements of therapeutics and operative procedures. The method of Dieffenbach and of von Graefe, of severing a tendon from its insertion into the sclera was seen to be a mutilation. More delicate, more exact, and far more effective operative methods were adopted, and to this end more delicate and far better constructed instruments were required.

In examinations systematic accuracy was sought in the use of the phorometer.

Notwithstanding all these refinements it was evident that there were anomalous elements in many of the cases which were either outside those which had already been classified or that these known elements were not completely understood. It now seems curious that with this knowledge and with an earnest desire to solve the problem of the exceptions to the ordinary rules, the conditions which we may now easily discover by the tropometer were not appreciated until the conditions of heterophoria had been diligently studied during more than fifteen years. Before the tropometer was brought into use, however, anomalies of the upward and downward directions of the optic axes had been recognized by me and tested rudely, and had even been found to be important elements of strabismus.¹ When at length the instrument came into existence, it shed such a flood of light upon

¹ See Transactions of International Ophthalmological Congress, 1894, and *Annales d'Oculistique*, April and June, 1895.

many obscure questions that for a time it seemed as though the key had been found which would unlock the secrets that had been so long concealed. The normal and the anomalous positions of the plane of vision were now first defined and the importance of the conditions anophoria and katophoria were shown.¹

A year of work, while progressively showing new revelations and fresh explanations of many problems, showed that beyond the phenomena revealed by the phorometer, and beyond those shown by the tropometer, there must still be a field of research not yet opened.

Helmholtz and other philosophers had investigated, from a physiological point of view, *the directions of the apparent meridians of the retina*. Notwithstanding the crudity of his methods and the paucity of observations, Helmholtz had based his grand theory of the horopter on the results of his researches respecting his own eyes. The fact that the adjustments of his eyes might not represent the best normal for ocular adjustments did not occur to him and was not taken into account. When in listening to the conversation of a bore he incontinently multiplied his misfortune by seeing two bores before him, or when, after a frugal dinner at which wines had cut no especial figure, all his friends about the table assumed the aspect of Siamese twins, he attributed the phenomenon to no defect of his own eyes, but appeared to think that it was the way that eyes were made. It was to him simply a phenomenon in physiological optics. Hence, failing to realize his own visual peculiarities, he drew conclusions from his observations which could not be verified by others, and thus one of the masterpieces of his great genius was rejected as of no physiological importance, as, in a technical sense, it really was. I need not in this place refer to the investigations of Donders, Hering, Volkman, LeCompt, and others in this field, all of whom were influenced by the same misapprehension.²

It was in considering how it happened that this grand labor had failed that the idea of a practical and exact method for making the essential examinations was suggested. The result was the clinoscope. It was devised as an instrument for the study of a technical phys-

¹ *Annales d'Oculistique*, April and June, 1895.

² I have included among the pioneer observations only those which, had the phenomena been studied more accurately, might have led to the discovery of true declinations. Crude theories of disabilities of the oblique muscles, based on experiments in which the elementary principles of investigation were disregarded, since they could neither have suggested nor aided in revealing the real nature of these anomalies, require no mention here.

ological phenomenon. It soon became the means for making a class of examinations of the most practical character which go farther to explain the phenomena, not only of heterophoria, but of strabismus, than all the instruments and means of examinations that had gone before.

This is not the place for detail. It is only possible to touch upon generalities, and those only in most comprehensive terms.

Yet, to illustrate what is meant by the remark just made, I will venture a single detail as an example.

For many years previous to the introduction of the clinoscope it had appeared to me that the condition which we knew as exophoria was not an ultimate and independent condition. This view had more than once been expressed in my writings and I had hoped that the reason for its manifestations might be discovered in some more primary state. If now we search for that primary state by the aid of the clinoscope, we will be likely to find that the vertical meridian of each eye leans outward,¹ that is, there is positive declination in each eye. Now, if we consider for a moment the legitimate result of such a position of the vertical meridians, an explanation of the exophoria will be at hand.

There is no stronger visual impulse than that of maintaining the uprightness of the images perceived by the eye. A leaning of the image of one eye or those of both eyes means to the possessor of that or of those eyes that the earth has lost its equilibrium, that walking is difficult or unsafe and that surrounding buildings threaten to fall. Compare, in this respect, the state of the patient with paralysis of an oblique muscle. To avoid this most unpleasant impression the muscles which are most influential in rotating the eye upon its axis are brought into active contraction. With the contraction of these muscles something beyond the simple rolling of the eye upon the optic axis occurs, namely, a turning of the eyeball down and out. In other words, if, with positive declination of the vertical meridians of the two eyes the horizontal and vertical meridians are forced into the appropriate positions for receiving the horizontal and vertical lines of images, there will result a tendency of the eyes to swing outward in proportion to the amount and symmetry of the declinations. Practical observations in large numbers have shown that this is the

¹Among the cases usually met with in private practice the opposite condition, double negative declination, is much more rare, for ethnological reasons.

general law of exophoria. Others of the deviating tendencies and of the actual deviations of the eyes can be explained on similar principles, and I am sure that I shall make no mistake in saying, that when the excesses or deficiencies of vertical rotation of the eyes are considered in connection with the normal declinations of the retinal meridians, it will be no longer necessary to perform the well-known and standard operations for converging or diverging squint.

This statement, while strictly conforming to the theory of the actions of the muscles, is not an hypothesis built solely on that theory, but is the actual growth from the experience of every-day work.

Thus, by the knowledge and the proper interpretation of the vertical rotations of the eyes, as shown by the tropometer and by the corresponding knowledge and interpretation of the relations of the vertical meridians to the cranium as revealed by the clinoscope, we are able to place the various phenomena of heterophoria and of heterotropia in their exact physiological relations with each other, and to discover that various forms of anomalies are not isolated facts, but a class of phenomena so well arranged and so interdependent that a knowledge of them fairly constitutes a science.

Let it not be supposed that the existence of such a science has its bearing simply in the realm of the immediate affections of the eyes. The influence of this science extends as far as the jurisdiction of the nervous system.

The conservatism which comes with a good many years of hard experience, not by any means free from sore disappointments, does not lead to exuberant declarations of things hoped for but which are in reality only the active workings of a lively imagination. I speak the words of truth and sobriety when I say that oculists will in the near future hold closer relation to the general physical well-being of their patients and of the community than any other class of medical practitioners, except those who, as general practitioners, are called first in every form of ailment.

Glance for a moment in a single direction.

There is a class of boys and girls who, whether standing, walking or sitting, throw the forehead far in advance and the chin into the breast. They are everywhere, especially in our Northern States. Intellectually, they are the brightest of their class. Their shoulders bend with their heads and they are charged by their friends in constantly reiterated exhortations to stand up straight and hold the shoulders erect. No amount of admonition does any good, they see

easier when the head is advanced. If these young people are examined it will be found by the tropometer that they all have the eyes adjusted for a plane much higher than the horizon, or that in certain cases there is notable anomalous declination of a character to induce a similar bodily pose. It is often the penalty for a head in which the process of evolution has carried the axes of the orbits too far from the original low plane of the distant ancestors of these young persons.

Can the pose of these young people be changed? By a slight relaxation of the superior recti muscles, or by a correction of the declination, the chin will lift as if by magic. But what harm can come from the projecting forehead and receding chin? Is it not easy to see that the position of the head causes the upper air passages to shut like a valve? The hinge is at the larynx. Not all such persons suffer the full penalty for this restriction in the act of respiration, but too many do.

If we visit one of the modern hospitals for consumptives the most striking thing to a close observer will be this prevailing pose of the head, and this mechanical obstruction of the larynx.

Could those heads have been raised and could those shoulders have been made erect before they finally caved in? In a short time and by a safe and painless process. Would the patient have had consumption had this been done in time? I can only say that by the correction of the anophoria, and of the declination which sometimes has a like effect on the pose of the head, more would have been accomplished than by any change of climate or any medical régime that could have been prescribed.

Perhaps some one will reply: "Consumption is the effect of the presence of bacilli in the lungs."

We have seen a field where a farmer has just burned his piles of brush. We have observed the blackened soil sprinkled with the white ashes where the brush heaps were burned. If we pass the same place the next year or the year after we will see that where the fires were are thick masses of the purple flowering fire-weed—*epilobium*—completely covering the fired spots. It grows nowhere else in the field. But the *epilobium* seeds were carried by the wind all about. Why do they spring only where the soil has been burned? The soil of these spots is exactly suited to the growth of the *epilobium*, just as the mucous membrane in the quiet eddies of a half-filled lung is best suited to the propagation of the consumption bacillus.

It is very certain that we do not often see consumptives who hold the chin high in the air. In other words, we do not see consumptives whose eyes are adjusted below the plane of the horizon. The oculist can adjust the eyes for the plane of the horizon, or if he desires, which I hope he would not, for a plane far below it.

This is but a single glance in a single direction, and one may find startling truths in many directions if one will look with the mental vision open to what is to be seen.

If it is thought that my picture is a fancy sketch it will require no very long series of observations, if one observes well, to reach the conclusion that I have drawn but a rude outline of a realistic portrait.

Looking, then, over the great field which is opened by the knowledge of the relations of the eyes to the general nervous economy, we see that, when the first eye flew into place under the instruments of Dieffenbach, there was started a course of investigation which, with varying fortunes of halting, retreating and advancing, has led to results which are infinitely more far-reaching than appeared to his astonished vision, results which it is the province and the privilege of the skilled surgeon to carry to higher and yet higher attainments.

That branch of medical science which brings its votaries in closest relation with the study of the highest of physiological actions, and with the solution of most interesting questions of physiological psychology and of physiological optics; with the study of the expressions of the face and with the types of the cranium, and which, therefore, leads to interesting and practical investigations in physiognomy and craniology; which is in the highest sense both mathematical and mechanical and which demands of its practitioners the highest originality of method and the greatest refinement in execution; which requires of its servants ability to adjust themselves to constantly recurring new situations and to form logical conclusions from their personal observations, leading them out of the beaten path into new and enticing fields; that branch, beyond all question, is the one which deals with the relations of the eyes to each other and of those relations to the system at large.



Effigiem Taylor tibi qui demissus ab alto est,
 Turba alias expers luminis, ecce videt,
 Hic Maculas tollitt, *Cataractas* deprimit omnes
 Amisum Splendens excitat ille Tubar.
 Miranda praxi Sublata *Ophthalmia* quævis
 Artifici dextræ gutta Serena Cedit
 Ecce Virum! Cujus cignatur tempora lauro
 Dignum, cui laudes sæcula tonga canent.

Since writing this introduction I have had the good fortune to come into possession of an engraved portrait of John Taylor, who, whatever may be our conclusion regarding any claim in his behalf that he first operated by tenotomy of the lateral muscles for the cure of strabismus or whatever view we may take of his code of ethics, is and must always be a personality of much interest to all who may be occupied with the history of ophthalmology, and especially with that of strabismus.

This old print, engraved about 1745, throws some additional light on the peculiarities and the work of Taylor. We have the titles of several of his works and we have the inscription laudatory of his accomplishments and abilities, all of which was doubtless directed by Taylor himself.

It is to be recalled that in Taylor's time fulsome praise of this sort accompanies the portrait of many a man less prominent than he—that it was not at all unusual for men of some distinction to anticipate the posthumous fame of a high-sounding epitaph by inscribing below their "effigies" pretentious and magniloquent panegyrics of themselves.

In the much-reduced copy, which I believe will be of interest here, the titles of the works have been rendered so inconspicuous that I transcribe some of them here.

They are, in part:—

Taylor. Mechanism of the eye. 1727.
 On the muscles of the eye. 1740.
 Mech. de l'Oeil. 1739.
 On the Mo— Beauty of the eye. 1744.
 Traite de Strabisme. 1733.
 On the Chrystallin— 1735.
 Mechan. du Globe de l'Oeil. 1737.
 Syllabus Cursus Anat: 1742.

On the manuscript at the left is inscribed, "Coll: of the Opinion of the Universities on his Operations, etc."

"Sents. of the University of Basle in Swizd. Oct. 26, 1734, when admitted Doctr. of Physk."

"..... of Leige Ap. 20, 1735."

"..... of Cologne May 2, 1735, both in Germany."

"..... of Caimbra, Sept. 9th, 1738, in Portugual."

If Taylor received degrees from all these institutions it would seem that some more definite knowledge of his position as a man of learning than we now possess might be obtained.

PART I.

ANATOMY OF THE MOTOR MUSCLES OF THE EYES AND OF THE PARTS ACCESSORY TO THEM.

SECTION I.

MOVEMENTS AND POSITION OF THE EYES.

THROUGH the influence of the various muscles attached to the globe of the eye, that organ executes numerous movements, not only upon the vertical and horizontal axes and the axes approximating to these, but also upon the antero-posterior axis. Thus the eyes move in all directions, but within certain limits. In different species of vertebrate animals we observe marked differences in the extent of these movements, varying from those scarcely perceptible to those greatly extended. In general this motile ability increases as the species to which the animal belongs rises in the scale of organism. More particularly the movements of the eyes are greatest in those species in which the eyes are placed most anteriorly, and in which such movements are necessary in order to extend the field of regard.

It is only in the highest order of vertebrates that the rotary movements of the eyes reach their greatest development.

The comparative length and the specialization of action of the muscles controlling these movements depend largely upon the position of the orbits and of the eyes relatively to the cranium.

POSITION OF THE EYES IN ANIMALS.

In vertebrate animals the eyes are situated, in general, more or less laterally and upon the anterior portion of the cranium. In the lowest orders they are placed quite at the side, in the highest more anteriorly. As the animal rises in the scale of existence, and as it has greater occasion to direct the eyes toward the front, in fact, as the animal becomes more observant of special objects, the axes approach toward parallelism. In proportion to this parallelism is any considerable range of binocular vision possible. This form of vision

is found principally in the highest animals and, except within narrow limits, is confined to that class.

Commencing with fishes, in which class the axes of the two eyes are almost in a continuous straight line, and passing to reptiles, in which the axes form an obtuse angle, then to birds, where the angle is less obtuse, and finally to the class of mammals in which the axes approach more nearly to parallelism—as a rule, with an angle progressively less obtuse as the animal rises in the scale of classification—there is found with these modifications in the directions of the axes a larger motility as the angle becomes less.

From a cursory glance at the gradual change in the direction of the optical axes, it would be easy to suppose that the nearest approach to parallel axes would be found in man. So far as the axes of the orbits are concerned there are exceptions to this rule which might be based upon the gradual evolution of animal types, for in certain monkeys and apes the orbits form a more acute angle than is found in man. In fact, however, while the divergence of the orbital axes in those species in which they approach most nearly to parallelism is less than in man, the axes of the eyes themselves are, in these lower animals, more divergent.

SECTION II.

COMPARATIVE ANATOMY OF THE EYE MUSCLES.

PECULIARITIES OF THE EYE MUSCLES IN FISHES.

There are six muscles:—

Four recti, analogous to those in man.

Two oblique, also analogous to those in man.

The origins of the four recti differ from the common point of origin in man, in that while in man all the recti have their origin in a circle around the optic nerve, in fishes the points of origin are behind this nerve. The extent to which the origins are posterior to the nerve varies, depending upon the depth of the sphenoidal canal. In the species in which this canal is profound, the posterior insertions are found within it. In those less deep, the insertions are in front of the canal. In the first group, all the muscles are placed very obliquely to the axis of the globe. In the second group, the four recti muscles are nearly parallel with the axis.

In no vertebrate animals are the superior and inferior muscles parallel with the axis, they are always obliquely placed.

In fishes the oblique muscles are less variable than the recti. There is also very little difference of length and size, such as is found among mammals, between the superior and inferior oblique.

There is no pulley, but the two oblique muscles are inserted close together at the antero-internal angle of the orbit, and are diverted from this point of insertion backward and outward to the upper and lower faces of the eyeball and to the portion anterior to the equator. Instead of exerting a force toward the front or outward, as in man, these muscles have a backward energy. They are inserted in advance of the insertions of the recti; not behind, as in the higher vertebrates.

In certain species of fishes, strong fasciculi of muscular fibres

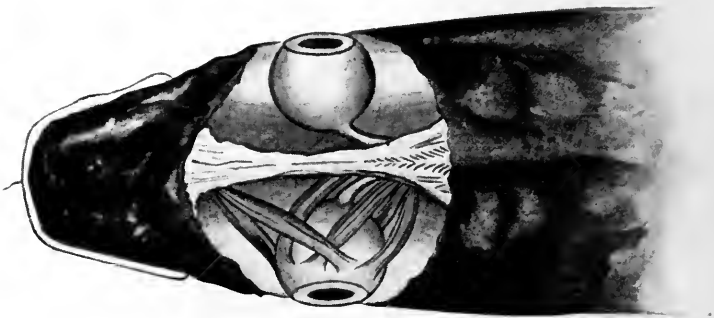

Fig. 1.—Eye Muscles of Cod (*Morrhua Americana*). (Drawing by the Author.)

constituting accessory muscles divide from the main course of the recti muscles and, instead of being inserted into the sclera, unite with the capsule, giving an appearance of a double set of recti muscles. Fig. 1 shows the muscles of the eye in the cod. The course of the four recti is more nearly analogous to that in man than that of some fishes, and they pass more directly backward. The origin of the muscles is not shown, but the posterior extremities, instead of taking their origin from a circle around the nerve, start backward further, finding their origin in the sphenoidal canal.

PECULIARITIES IN AMPHIBIOUS REPTILES.

Batrachians: In addition to the four recti and two obliques, there is the *choanoideus*, which has the effect of retracting the eye—a muscle having a greater volume than the recti and obliques together.

This funnel-shaped muscle first appears in batrachians and is found in many of the mammals. It forms a ring within the circuit of the recti muscles, being inserted into the sclerotic at its posterior face, and having its origin at the entrance of the optic nerve into the orbit, is divided into three portions, not always, however, very clearly separated.

The posterior superior rectus in frogs offers the first suggestion of the peculiarity of arrangement of the superior oblique in man; starting from the sphenoid its muscular fasciculus passes outward and upward, is directed forward and upward until it encounters a



Fig. 2.—Head of a Frog (*Rana fontinalis*), Showing the Muscles of One of the Eyes. The two oblique muscles are seen to proceed from a common point backward to be inserted, one on the outer, the other on the inner, side of the eyeball and above the insertions of the recti. The *posterior* rectus passes forward from the sphenoid until it encounters a transverse band of fibers, where it changes its course upward to be inserted into the posterior portion of the globe. The *choanoideus* is seen behind and below the insertions of the recti, forming an envelope for the optic nerve. The colors of all the muscles are purposely exaggerated. In fact the color is a faint pink. (Drawing by the Author.)

strong transverse band of fibers which acts as a sort of pulley. The muscle then becomes strongly reflected in its course, passing almost directly outward and upward to its insertion in the posterior portion of the anterior hemisphere of the sclerotic.

The retractor muscle (*choanoideus*) serves in these animals to draw the eye, usually projecting, to the plane of the surface of the

cranium, thus protecting the organ from injury in the case of its leaping, diving into the mud, and such contingencies.

In frogs (Fig. 2), as in fishes, the two oblique muscles are inserted in advance of the superior and inferior anterior recti muscles, but in serpents the insertion of the superior oblique is sometimes *behind* the superior anterior rectus. Here is the first indication of the position of the oblique muscles of the higher vertebrates *behind* the recti muscles.

PECULIARITIES IN BIRDS.

In birds there are, as in fishes and reptiles, six muscles, whose office is to rotate the globe of the eye.

In fishes and in certain reptiles the recti muscles find their origin far posterior to the optic nerve. In some reptiles the muscles arise more nearly in relation to this nerve. In birds the muscles commence in a circle around the optic nerve. Beyond this there is no marked peculiarity in the direction and disposition of the muscles as compared with those of reptiles. But it is to be observed that in birds, as in frogs, the superior oblique is inserted somewhat posteriorly to the superior rectus. Its insertion into the sclera is very extensive, starting as far forward as the insertion of the superior rectus and extending over this muscle and backward behind the equator.

The muscles are named, respectively, the anterior rectus, posterior rectus, inferior and superior rectus, with the superior and inferior oblique muscles. The anterior corresponds to the internal rectus in man, the posterior to the external. The insertion of the anterior rectus is considerably nearer to the superior than to the inferior oblique. The posterior rectus is attached to the posterior portion of the eyeball and rounding the convexity, passes under the eye to the border of the optic foramen.

The shortness of the muscles and the fact that the eye, to a very great extent, fills the orbit, serve to limit the motility of the eyes materially, so that the ocular movements are actually very slight.

It is noticeable that birds which hunt their prey from great heights have very large eyes and very slightly developed eye muscles; while waders and birds which seek for food at little distance have smaller eyes and more fully developed muscles.

Fig. 3, representing the head of the winter gull, *Larus argentatus*, shows a dissection of the eye muscles. It is seen that the four

recti pass backward to the foramen for the optic nerve and are inserted about the entrance of this nerve to the orbit. The two oblique muscles pass from the upper and lower border of the eyeball forward to be inserted into the anterior part of the orbit.

PECULIARITIES IN MAMMALS.

There are in certain mammals seven ocular muscles: four recti, two oblique, and the choanoideus, which, as we have already seen, is found also in certain reptiles. This seventh muscle is present in

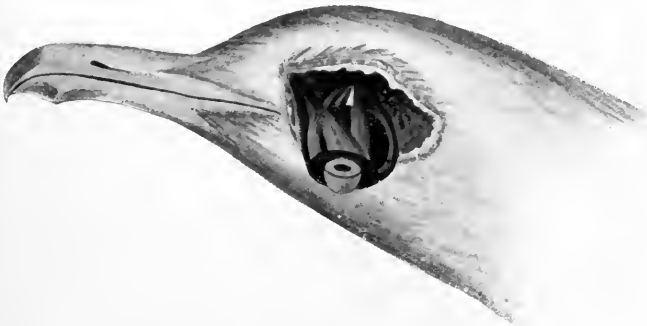

Fig. 3.—Head of Winter Gull (*Larus argentatus*), Showing a Dissection of the Eye Muscles. (Drawing by the Author.)

very many of the lower species of mammalia; but although found in lemurs, has not been observed in monkeys, except in rare cases when it consists of a small fasciculus. It is most prominently developed among ruminants. In those species in which it is principally developed, Motais¹ found its origin not only from around the optic foramen, but still more from the sphenoidal canal, from which a very large portion of the fibers emerges in close relation with the third and sixth nerves. It surrounds the optic nerve in its outward course as an enveloping cone, and it is inserted into the posterior portion of the sclera in a somewhat irregular ring (Fig. 4). Its office appears to be to draw the eye into the orbit and it may also act as the organ of suspension for the eye. It is in close relation with

¹ Motais, "Anatomie de l'Appareil de l'Oeil de l'Homme et des Vertébrés, Paris, 1887.

the so-called third eyelid which exists in reptiles, birds and some mammals, and in proportion to the development of one is that of the other (Motais). In man and most monkeys in which the third eyelid is absent there is also an absence of the choanoideus.

The origin, course and insertion of the recti muscles are analogous to those in the human subject. From each of the four recti in certain species there arise from the surface of the muscle bands of fibers which, in some instances, become veritable accessory tendons connecting the muscles with the walls of the orbits. Sappey describes such bands arising from internal and external recti of man. Motais

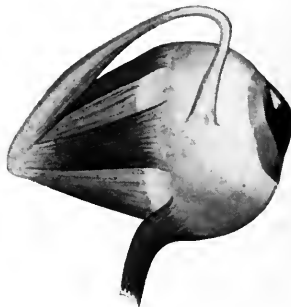

Fig. 4.—The External Muscles of the Eye of the Domestic Sheep. The superior oblique is seen to be inserted in front of the insertions of the recti instead of behind them, as in the case of man. The external rectus is turned aside to show the conical-shaped choanoideus, which is inserted into the posterior portion of the globe and envelopes the optic nerve. (Drawing by the Author.)

asserts that he has found similar bands from each of the four recti in man.

The oblique muscles no longer conserve their uniformity of origin, as in the lower orders. The inferior oblique maintains its origin at the anterior border of the orbit, but in all mammals the superior oblique takes its origin with the recti muscles at the posterior portion of the orbit, and in all cases the muscle takes its course through a pulley in or near the superior border of the orbit and is reflected backward to the insertion into the sclera.

Only in monkeys and in man is the insertion of the superior oblique on the posterior hemisphere of the globe. In these the pulley is placed further in advance and the insertion more posteriorly on the

globe. Hence, while in many species the action of the superior oblique is almost in a transverse direction, in the highest orders it is more obliquely from before backward. In my dissections I find, what I have not seen elsewhere noted, that the recti muscles are loosely attached to the eyeball of the domestic sheep, the insertion being into an extremely delicate capsule which surrounds the eyeball as far as the cornea, rather than into the sclera. These muscles do not appear to have any rotating power worth considering. The oblique muscles are more intimately connected with the sclera, but the cartilaginous pulley for the superior oblique is buried in the soft orbital tissues and is not directly attached to the bone of the orbit, nor has it, apparently, any point of resistance. As seen in the accompanying sketch the funnel-shaped choanoidcus is the principal muscle of the eye and it is more directly inserted into the sclera than any of the others. There seems to be no reason to regard the recti or the oblique muscles of the domestic sheep as little more than as vestiges of organs which in some ancestral animals served a useful purpose.

SECTION III.

THE ORBITS.

The eyes are surrounded, protected, and indirectly supported by walls built from many separate bones which together form somewhat pyramidal cavities, the orbits, the apices of which are behind, while the bases or orbital overture are toward the general plane of the face. These cavities are somewhat quadrilateral, especially toward the base. The outer walls of the two orbits approach each other as they extend backward, while the inner walls are nearly parallel. The upper wall also descends toward the apex, the lower being more nearly horizontal. The axes of these two cones or pyramids would, if extended backward, according to Sappey,¹ cross each other very nearly at the basilar apophysis of the occipital bone. Other anatomists place the crossing of these lines at the center of the sella turcica (Cruveilhier).²

These different results follow from the choice of different guiding marks at the extremity of the orbital cavity; for while some anatomists have selected the optic foramen as the point through which the axis should be prolonged, others have selected the broader portion of the

¹ *Traite d'Anatomie Descriptive*, 1868.

² *Traite d'Anatomie Descrip.* t ii, partie 2e.

sphenoidal fissure; others still have chosen the broader portion of the speno-maxillary fissure, while a fourth group of observers have taken the narrow portion of the same fissure. Even when the same points are selected as points of direction there is found a variation in the angles formed by the axes of the two orbits in different individuals, depending on the general form of the skull, a variation which will throw the crossing more or less backward. The subject of the angle formed by the axes of the orbits and the p'lane in which they lie, with

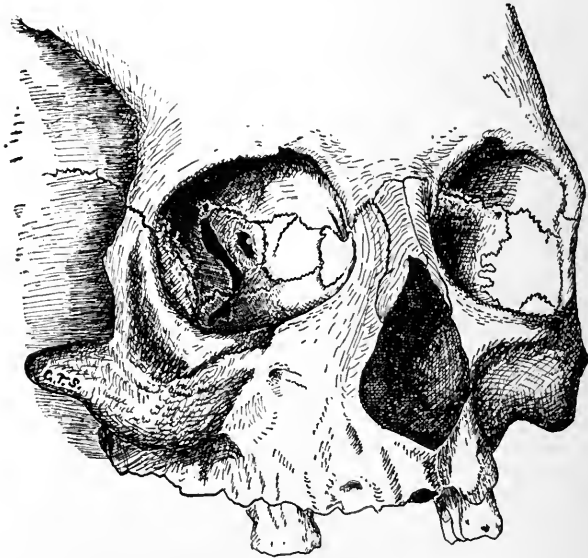

Fig. 5.—The Orbits.

the measurements of the walls and openings, will be considered as we proceed.

Several bones enter into the construction of the orbit. Thus the roof, the largest of the four walls (paries superior), is formed anteriorly by the orbital plate of the frontal bone, and more posteriorly by the lesser wing of the sphenoid. Below, the orbital process of the superior maxilla, the orbital process of the malar bone and the orbital process of the palate bone constitute in their order from before backward the floor of the orbit (paries inferior). The wall of the nasal side (paries medialis), the least in extent of the four, is formed mainly by the os planum of the ethmoid and the orbital surface of the lachry-

mal. From before backward the four bones entering into the composition of this wall are: the nasal process of the superior maxillary, the os unguis, the os planum of the ethmoid, and a small part of the body of the sphenoid. The nasal process of the superior maxilla constitutes a portion of the inner anterior wall as well as a portion of the anterior floor. The lesser wing of the sphenoid with its optic foramen forms the posterior portion, not only of this, but of the other walls.

The greater wing of the sphenoid and the malar bone, with the temporal extension of the orbital portion of the frontal bone, constitute the elements of the exterior wall (*paries lateralis*).

The inner wall has a thickness of from 2 millimeters to 4 millimeters, which greater thickness is posteriorly. The inferior wall is

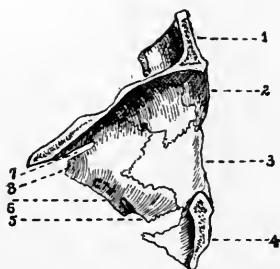

Fig. 6.—The External Wall of the Orbit. 1, Section of temporal bone. 2, Orbital surface of temporal bone. 3, Orbital surface of malar bone. 4, Section of Malar bone. 5, Infra-orbital groove. 6, Orbital surface of Greater Wing of Sphenoid. 7, Sphenoidal fissure. 8, External orbital foramen. (Drawing by the Author.)

from 0.5 millimeter to 1 millimeter in thickness, while the outer wall is from 1.5 millimeters to 2 millimeters, and the superior wall is, like the inner wall, extremely thin.

At the apex of the orbit is the optic foramen for transmission of the nerve of the same name and of the ophthalmic artery. This optic foramen is in fact the space between the two roots of the lesser wing of the sphenoid bone. A tubercle within this bony wing serves as an attachment for the common tendon with which several of the eye muscles are connected.

In these orbital walls are found many openings besides the optic foramen, among which are principally the sphenoidal fissure, nearly vertical and anterior and external to the optic foramen,

for the transmission of the third, the fourth, the ophthalmic portion of the fifth and the sixth nerves, and the ophthalmic vein. In fresh dissections the foramen is closed by a layer of the lining membrane of the orbit which closely envelopes the transmitted nerves and vessels. In the lower and external walls is the speno-maxillary fissure for the passage of the tempero-maxillary and the malar artery. Besides these are several other openings, among which are the foramina or grooves in the superior arches for the exit of the supra-orbital nerves and vessels.

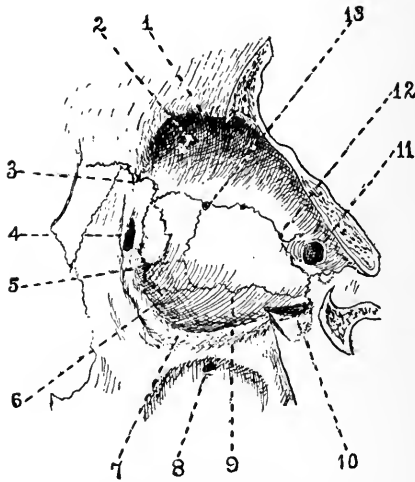

Fig. 7.—The Internal Wall of the Orbit. 1, Supra-orbital margin of frontal bone. 2, Spine of trochlea. 3, Fronto-maxillary suture. 4, Lachrymal groove. 5, Lachrymo-ethmoidal suture. 6, Lachrymo-maxillary suture. 7, Infra-orbital margin. 8, Infra-orbital foramen. 9, Ethmoido-maxillary suture. 10, Infra-orbital groove. 11, Optic foramen. 12, Posterior ethmoidal fissure. 13, Anterior ethmoidal fissure. (Drawing by the Author.)

A fossa just within the lower part of the nasal margin of the orbit forms the bed for lodgment of the lachrymal sac; while another fossa situated just behind the border at the superior external part of the orbit is the location of the orbital portion of the lachrymal gland (*the lachrymal fossette*). Somewhat outside the border of the floor of the orbit is situated the *infra-orbital* foramen, which is the termination of the infra-orbital canal. The *infra-orbital groove*, or *sulcus*, occupying a longitudinal space in the posterior floor, constitutes a

part of this canal. Inside the border of the superior floor is situated a small spine, the foundation of the trochlea.

Anteriorly, the boundaries of the orbital opening are more or less definitely divided into four parts by as many angles. These angles, of which the two superior and the two inferior are called the external and internal superior and the external and internal inferior angles respectively, are to a considerable extent variable. The variation may extend even to the effacement of all except the inferior angle, which is always present as an angle, and is hence known as the angle of the eye.

The projection of the border of the orbit, forming a distinct margin around most of its circumference, results in a diminution of its size at its anterior overture, the diameter being greatest at a little more than two-thirds the distance from the posterior extremity.

The upper or supercilliary border of these orbital arcades, formed from the frontal bone, projects beyond the lower border, permitting a range of vision downward greater than would exist were the lower border equally as prominent as the upper. So also the lateral border is several millimeters behind the medial border. Indeed, the whole general form of the orbit is such as to permit a wide range of movements of the globe of the eye and of a field of regard extended in many directions. The internal border, which furnishes an important point for orbital and interorbital measurements, is formed by the internal orbital process of the frontal and the nasal process of the superior maxillary bones. At the union of these two and of the lachrymal bone is the point known as the *dacryon*, the starting point of various measurements. The distance between the dacryon of one orbit and that of the other is known as the interorbital space. The form of the orbital overture varies from nearly round to almost rectangular.

MEASUREMENTS OF THE ORBITS.

The results of measurements of different parts of the orbit must vary according to the age and sex of the individual and according to race.

Measurements conducted by different authors have not been altogether uniform, and the methods adopted by different craniologists have not been equally satisfactory.

Anteriorly the points selected as fixed points in the measurements are the four angles (only one of which is, however, constant) and the

diameters between the orbital borders between these angles. Naturally, as the angles are often badly defined, these second measurements are equally uncertain.

Topinard¹ adopts the following points: The horizontal diameter is measured from the dacryon to the point horizontal with and opposite to the dacryon. The vertical diameter starts from the lower border at the spot where the naso-maxillary suture meets the infra-orbital edge and cutting perpendicularly the horizontal diameter.

The greatest diameter in height and the greatest diameter in the horizontal direction do not coincide with these lines, as will be seen from the diagram at Fig. 8, copied from Toldt's "Atlas of Anatomy." Virchow measures the greatest horizontal diameter parallel to the plane of the horizon and the greatest vertical diameter at right angles to the first. Broca's measurements² are nearly those described by Topinard, but are more oblique, like those on the right in the Toldt diagram.

Stilling,³ of Strasbourg, bases upon the orbital index a theory of compression of the globe by the superior oblique. He believes, without sufficient evidence, that a low index predisposes to myopia, and the opposite state, a high index, predisposes to hyperopia.

Weiss also thinks⁴ that the orbit is lower in myopes than in hyperopes, the capacity of the orbits in the former being less than in the latter. Weiss, however, does not concur in all the conclusions of Stilling.

Broca and other craniologists, in comparing the various measurements of breadth and height, employ the term "orbital index," which is the relation of the horizontal diameter of the base overture of the orbit to its vertical diameter. (Fig. 8.)

For adults of Anglo-Saxon lineage the dimensions of the orbits may be contingently stated as follows:—

From the optic foramen

To the internal angle of the base, about 45 mm.

To the external angle of the base, about 50 mm.

To the middle of the superior arch, about 52 mm.

To the middle of the inferior arch, about 52 mm.

¹Topinard; "Anthropology."

²Broca: "Instructions Craniologiques et Craniometriques," p. 72.

³"Über Entstehung der Myopie." Transactions Seventh International Ophthalmological Congress, Heidelberg, 1886.

⁴Weiss: International Ophthalmological Congress, Heidelberg, 1889.

The measurements of the diameters of the orbit are as varied as those of the length.

In the future chapter it will be shown that the orbital index varies with the type of the skull; that the excursions of the eyes in the vertical directions vary correspondingly to the type of the orbit, and therefore largely corresponding to the type of the cranium. The orbital index of the young child exceeds that of the adult. The orbit of the infant is oval, the larger part being the temporal.

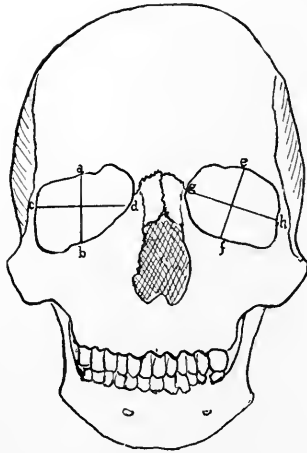

Fig. 8.—Vertical and Transverse Diameters of the Orbit. *ef* and *gh*, the greatest vertical and transverse diameters of the orbit, according to Broca; *ab*, *cd*, the direct vertical and horizontal diameters of Virchow. (From Toldt's Anatomical Atlas.)

Emmert, of Basle, has given¹ the results of his examinations of 44 skulls of native Swiss, of 9 Turkish soldiers who had died in Switzerland, and of 11 other persons foreign to Switzerland. He averages the results under five groups, of which:—

First group consists of 19 native Swiss, from 0 to 17 years of age.

Second group, 10 native Swiss women, from 23 to 77 years old.

Third group, 15 native Swiss men, from 20 to 67 years old.

Fourth group, 9 Turkish adults.

Fifth group, 11 other foreign adults.

¹“Auge und Schädel.” Emil Emmert, Berlin, 1880.

The interorbital distance in Emmert's groups he found as represented below:—

INTERORBITAL DISTANCE:	FIRST GROUP (Children)	SECOND GROUP (Swiss Women)	THIRD GROUP (Swiss Men)
Average	80.8 millimeters	96.0 millimeters	97.0 millimeters
Greatest	96.0 “	103.5 “	106.5 “
Least	59.0 “	91.0 “	91.75 “

The following table gives the results of the average measurements of the breadth, height, and orbital index, and also of the cephalic index of these groups.

The “orbital index” is found by dividing the height by the breadth and multiplying the result by 100; or by the formula, $100 : \text{height} :: \text{breadth} : \text{index}$.

ORBIT	FIRST GROUP Infants and Adults	SECOND GROUP Female Adults (Swiss)	THIRD GROUP Male Adults (Swiss)	FOURTH GROUP Adults (Turkish)	FIFTH GROUP Other Adults
Breadth . .	34.3 mm.	39.8 mm.	41.6 mm.	40.65 mm.	42.8 mm.
Height . .	29.2 “	33.6 “	34.0 “	34.40 “	34.9 “
Orbital Index	85.	84.5	81.7	84.6	81.6
Cephalic Index } .	81.3	83.00	83.4	75.8	75.7

I have made a careful analysis of the individual cases reported by Emmert in order to ascertain the comparative orbital index to the type of skull—an analysis which Emmert did not attempt—and have compared the results with my own examinations made for the purpose of ascertaining the direction of the axis of the orbit in respect to the horizon.

If we class skulls having the cephalic index less than 77.77 as long or dolicho-cephalic heads;¹ those having the cephalic index from 77.78 to 83.34 as medium or meso-cephalic heads, and all above 83.34 as broad or brachy-cephalic heads, the result of this analysis gives us, for Emmert's cases, the following table:—

¹The measurements adopted by Topinard, “Anthropology,” p. 238.

Analysis by the Author of Emmert's Examination of Forty-four Skulls.

TYPE OF SKULL	Long (dolicho-cephalic)	Medium (meso-cephalic)	Broad (brachy-cephalic)
Cephalic Index	77.77 and below	77.78 to 83.34	Above 83.34
Average Orbital Index	82.9	87.00	83.5

Comparing these results with an analysis of the comparative cephalic and orbital indices found by myself, using the methods of Broca, in my investigation of the *Normal Directions of the Planes of Vision in Relation to Certain Cranial Characteristics*,¹ and using only the 40 crania examined at the Army Medical Museum at Washington, comprising 6 Bavarians, 3 Austrians, 1 Japanese, 17 unclassified whites, principally Americans, and 13 negroes, we have the following table:—

Analysis of Stevens's Examination of Forty Skulls.

TYPE OF SKULL	Long (dolicho-cephalic)	Medium (meso-cephalic)	Broad (brachy-cephalic)
Cephalic Index	77.77 and below	77.78 to 83.34	Above 83.34
Average Orbital Index . . .	79.9	88.00	82.25

It will be seen that two investigators, by independent methods, and with different ends in view, have arrived at results, so far as the relative forms of the orbits to the type of skull are concerned, which are remarkably similar; for while the figures in these two tables differ slightly, they are practically in harmony in showing that, with the long skull the orbit is low, with the broad skull it is still low but rather higher than in case of the long skull; while in the medium skull the orbit exceeds either of the other forms in height by a very important measurement.

These peculiarities in the form of the orbit are not merely interesting coincidents, they are characters which have most important bearings upon the motile condition of the eyes, as will be seen as we advance.

¹ Archives of Ophthalmology, No. 3, 1897.

The following figures, drawn from crania in the Army Medical Museum at Washington, will serve to illustrate the three characteristic types of crania and the associated types of orbits.



Fig. 9.



Fig. 10.



Fig. 11.

Figs. 9, 10, 11.—Characteristic Forms of Orbits. Fig. 9 shows the long and oblique orbit of the long skull; Fig. 10, the much higher and less oblique form of that of the medium or tall skull, and Fig. 11, the long and oblique orbit of the broad skull, somewhat similar to that of the long skull, but not extending as low at the temporal side and being less triangular. (Drawings by the Author.)

PLANE OF THE OPTIC AXES.

The plane of the axes of the orbits in respect to the horizontal plane is of much more than merely ethnic interest. We shall see that this plane doubtless plays a part of great importance in the normal plane of regard, and that upon it depend some of the most important functional peculiarities with which the practical oculist has to contend.

For the method of Broca¹ for ascertaining this axis the reader is referred to Fig. 12, page 45, where Broca's instrument for ascertaining the direction of the orbital axis is shown in connection with the author's craniostat.

Broca assumes that the optic axis passes in a line cutting the center of the vertical diameter of the orbit and the center of the optic foramen. In the figure, the star-shaped body serves to separate the branches to the extent that the extremity of each branch is in contact with the orbital border. The central branch will then be situated exactly midway between the two outer branches, and therefore in the outer extremity of the axis of the orbit. The needle is then pushed backward, through an opening in the extremity of the central

¹ Sur le Plan horizontal de la Tête.

branch, passing through the optic foramen. The needle does not pass through the center of this foramen, but comes in contact with its upper border.

By ascertaining the direction of the needles passing through both orbits, in relation to each other and to the horizon, the plane of the axis of the orbit as well as the interorbital angle is established.

The horizontal plane of the skull is, by Broca, arbitrarily established as the plane passing from the lowest border of the alveola of the upper jaw backward to the lowest point at the condyles of the occipital bone.

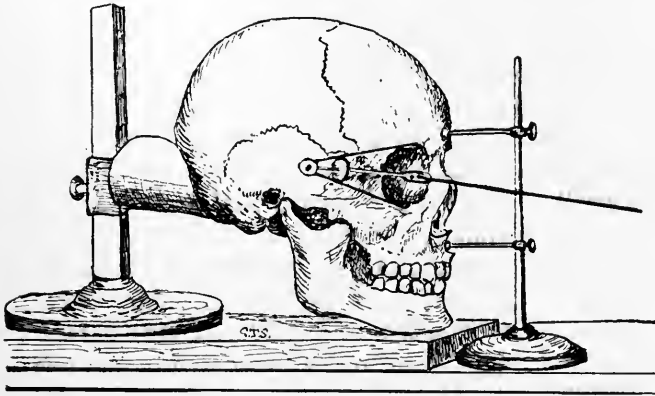

Fig. 12.—Stevens's Craniostat for the Examination of the Planes of the Orbit. The triangular, speculum-like instrument with the long projecting needle is Broca's instrument for ascertaining the direction of the orbital axis.

The two fixed points thus chosen are convenient for the craniologist, but one of them is absolutely useless in the living subject and the other is impracticable.

The points selected by myself as fixed points to indicate the vertical position of the skull are the ridge or elevation between the two superciliary ridges (the glabella) and the concavity just below the nasal spine, each in the median plane. This line would, in most cases, vary a few degrees from a right angle to the horizontal line of Broca, but it is as liable to be correctly chosen as that of Broca, is practicable during life, and is essential in measurements of the rotations of the eyes made by the tropometer.

Fig. 12 shows the author's method of placing the cranium for examination of the planes of the orbit.

Broca finds that the plane of the optic axis varies in different skulls to the extent of 19° , a variation which corresponds with the variation of the vertical rotations of the eyes as shown by the tropometer.

It has been shown that the orbital index varies with the type of the skull, and I have also been able to show that the excursions of the eyes of the living subject in the vertical directions vary correspondingly to the type of the orbit, and therefore largely corresponding to the type of the cranium.

Weiss and others have shown that the breadth of the orbital opening compared to the height is much greater in infancy than in adult life.

The cephalo-orbital index is the proportion between the capacity of the cranium and that of the orbit. In general, it may be stated that the index is about 27. The data in regard to different races is not sufficient to make this index an important element of distinction.

The smallest distance between the borders of the two orbits is known as the interorbital distance.

The plane which occupies the space between the orbital borders of either orbit is known as the base of the orbit. The planes or bases of the two orbits deviate, the outer border of each toward the rear forming an angle of about 10° or 15° with a horizontal line.

These bony walls do not by any means adjust themselves to the globular forms of the contained globes, but between the ocular globes and the orbital walls are considerable spaces, narrowing toward the anterior axes of the orbits.

ORBITAL AXES IN ETHNOLOGY.

We are not in possession of sufficient data to venture more than the suggestion whether, even in the human race, there may not have been a gradual advance toward parallelism of the optic axes; whether the orbital axes of the races which are probably the most primitive approach in this respect more nearly in the direction of the lower species than to the more advanced races. Ethnologists who have given great attention to the "orbital index" have supplied us with scanty facts in regard to the angles of the orbital axes.¹

¹The value of the orbital angle would seem to be worthy of a greater degree of attention than it has received from ethnologists. Broca has given some data from which it appears that the angle formed by the axes of the two orbits varies in man, ranging from 40° to 50° , while in the monkey tribe

CONTENTS OF THE ORBITS.

Within these orbital cavities are contained, besides the ocular globes, the cushions of fatty substance and loose connective tissue which form the beds in which the eyes rotate, the muscles which communicate the movements to the eyes and the elevator muscle of the upper lid, the blood-vessels and nerves which supply the eyes, muscles and other contents of the orbit, as well as some vessels and nerves which pass to the parts beyond.

The ocular portion of the lachrymal glands, the lachrymal caruncle, and the folds of conjunctiva, the pulley of the tendon of the superior oblique, are also among the contents of the orbits, while the capsule of Tenon, considered as an independent membrane, forms an investiture of all these organs.

If the muscles are carefully separated from the eyeball, the eye raised in such a manner that the optic nerve may be severed without injury to other parts, and the eye removed from its bed, this cushion is seen to be a concave half-sphere with surface lubricous and smooth. The lining membrane of this glistening bed is formed by an expansion of the capsule of Tenon, a membrane which not only serves as a surface on which the globe of the eye rests, but which envelops the tendinous insertions of the muscles, unites them with each other, and, as we shall see as we discuss its character more in detail, forms a practical augmentation of the extent of these insertions into the globe of the eye, thus in practice being a notable element in the surgical treatment of these muscles.

The fatty fibrous cushion, owing to the conical shape of the bony cavity and the extent to which the eye fills it at the equator, admits of but very slight compressibility, as it is easy to observe by pressing against the front of the eyeball; and in the normal condition the pressure of the cushion behind the eye is not augmented in such a manner as to modify materially the action of the muscles. We shall find, however, that the pressure of the tissues at the inner side of the

the minimum angle is 33° and the maximum 62° . The anthropoid apes have a small orbital angle. In five gorillas the angle was 39.04° , while in forty-three men the average angle was 47.47° . Among lemurs the angle was raised to 73° . Below this, in the scale of mammalian life, the angle greatly increases, reaching 109.89° in the horse and 143° in the rabbit. Emmert ("Auge und Schädel") made measurements of the angles in 64 crania, mostly of Swiss, but did not carry the investigation to other than Europeans. The investigations made by myself have been confined mostly to the crania of those who were of American birth. On the whole the data are meager.

eyeball may be so diminished or augmented as to affect to a certain extent the relative tensions of the motor muscles; and the same may perhaps be said of modifying influences of comparative pressure above and below, at or in advance of the equator of the eye. Nevertheless, the total displacement to any considerable extent of the eye in mass, from side to side, or above and below, is not permitted by the bony walls and the softer environments, in the normal condition of the orbital tissues.

While it is true that in the normal condition there are no important transient changes in the volume of the cushion against which the eye rests, and in which it performs its rotations, under certain circumstances of disease or of emaciation the amount of pressure behind the eye may be materially modified.

So also by an unusual tension of the oblique muscles the eyes may be forced forward so as to assume a position of conspicuous prominence, a phenomenon not unusual in very pronounced declination.

It is through this elastic fatty cushion that the muscles, vessels, and nerves of the eye take their course, that of the recti muscles forming a cone with the apex at the orbital foramen and the base at the equator of the eye.

This orbital tissue is formed by fatty cells enveloped in connective tissue which forms a network which surrounds each fat cell, and then uniting in strong trabeculae divides the mass of cells into separate groups or lobules, to each of which group is supplied its branches of vessels.

The character of the fat varies with its position. That immediately surrounding the capsule which envelops the eyeball and also that surrounding the optic nerve, is extremely fine, the fat cells being held in a very loose mesh of connective tissue, thus forming a bed in which the eye moves with the least possible resistance. In other parts of the orbit the fatty tissue is more firm and affords support for the muscles which traverse it.

SECTION IV.

THE MUSCLES.

The movements of the eye are communicated through the influence of six ribbon-like muscles which find a lodgment within the orbit. These are the four recti and the two oblique muscles.

With the exception of the inferior oblique, all these muscles have

their origin at the optic foramen. Here the orbital periosteum forms, at the apex of the orbit, a strong fibrous ring, *the circle of Zinn*, which surrounds and forms a channel for the passage of the optic nerve, while it affords an unyielding support for the tendinous origin of these five long muscles, as well as that of the elevator of the upper eyelid. From this point of support, they extend forward, in gradually diverging directions, until they pass the equator of the eye, to the places where the four recti find their insertion directly upon the surface of the globe; while the superior oblique proceeds in an indirect manner toward a similar insertion somewhat behind the equator.

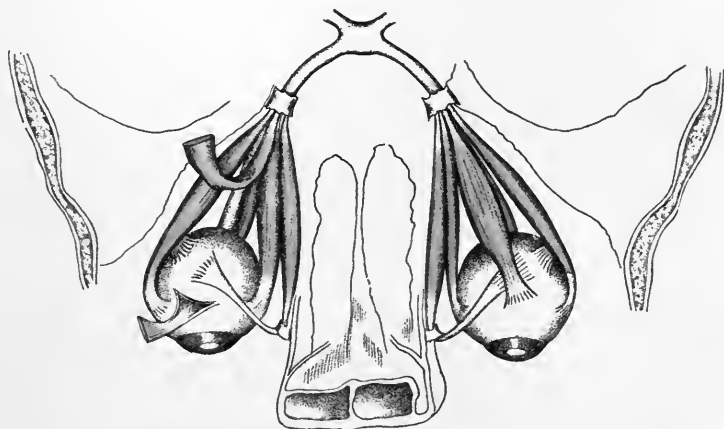

Fig. 13.—The Motor Muscles of the Eyes. (Drawing by the Author.)

Schwalbe's scheme of a section through the posterior extremities of the muscles is represented in the accompanying diagram. (Fig. 14.)

It will be seen that the superior oblique and a fasciculus from the external rectus find their origin somewhat removed from the circle of the recti terminating the pyramid of the four straight muscles.

Within the circle of insertions are the passages of the naso-ciliary branch of the ophthalmic, the common oculo-motor (III) and the abducens (VI) nerves.

Below the circle no nerves traverse the sphenoidal fissure.

At about 8 to 10 millimeters from the circle of Zinn, the tendons become changed into muscles, which again become tendinous before reaching the points of insertion into the eyeball. According to the

researches of Fuchs¹ and others the locality of the insertions varies considerably, and this variability is especially noticeable in the muscles acting vertically.

THE INTERNAL RECTUS.

(Synonyms: *Musculus medialis*, *M. adducens*.)

The origin of the internal rectus is at the circle of Zinn, but a tendinous fasciculus also arises further back from the sheath of the optic nerve. Passing forward nearly parallel to the inner wall of the orbit, it comes in contact with the eyeball at the equator, and continues its contact until it emerges from the capsule of Tenon to be inserted

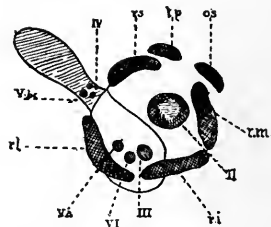

Fig. 14.—Schwalbe's Scheme of the Origin of the Eye Muscles at the Posterior Portion of the Orbit of the Right Eye. (From Schwalbe, "Lehrbuch der Anatomie des Auges," p. 227.) II, Optic nerve. III, Oculomotor nerve. IV, Trochlear nerve. Va, Naso-ciliary branch of ophthalmic nerve. Vbc, Ophthalmic branches of lachrymal and frontal nerves. VI, Abducens nerve. lp, Levator palpebrae superioris muscle. os, Superior oblique. rs, Superior rectus. rm, Internal rectus. ri, Inferior rectus. rl, External rectus.

into the eyeball at a distance of about 8.8 millimeters behind the border of the cornea. Its insertion is usually either a straight line or forms a slight curve with the convexity forward.

The internal rectus is next to the longest and is the strongest of the recti muscles. It is about 41 millimeters in length, weighs, according to Volkmann, $\frac{3}{4}$ gram, and its tendon insertion into the eyeball is 10.3 millimeters long. This, however, is subject to considerable variation. The variations in the length and position of the insertion will be discussed further on.

¹"Graefe's Arch.," B. xxx, Abtheilung iv, pp. 1-60.

THE EXTERNAL RECTUS.

(Synonyms: *Musculus lateralis*, *M. abducens*.)

The second strongest and third in length of the recti muscles arises by two fasciculi, one from the zonula of Zinn—the inferior—and one—the superior—from the fibrous sheath of the third nerve (Sappey). Passing forward nearly parallel to the outer orbital wall, it rounds the globe of the eye at the equator, to be inserted into the sclera about 7 millimeters distant from the border of the cornea. Its length is 40.6 millimeters, its weight $\frac{7}{10}$ gram, and the extent of the tendinous insertion 9.2 millimeters. Like the insertion of the internus it is nearly straight. From its sheath it sends a strong fasciculus to be inserted at the external angle of the orbit.

THE SUPERIOR RECTUS.

(Synonyms: *Musculus attolens*; *M. levator oculi*.)

The rectus superior, the weakest and longest of the group, has its origin at the upper and outer part of the zonula of Zinn and at the border of the sphenoidal fissure. Traversing the long diameter of the orbit, and rising at an angle equal to that of the arcade, it turns upon the eyeball at the equator and passes forward to be inserted at about 7.7 millimeters above and behind the border of the cornea, nearly at the median line. Its length is stated at 41.8 millimeters and its weight is about $\frac{1}{2}$ gram. The length of its tendinous insertion is greater than that of the other recti, being on the average, 10.6 millimeters. The insertion forms a stronger curve than either of the laterally acting muscles, and sometimes the ends curve strongly backward. In some cases the insertion has the appearance of a swallow's wings, and in other cases it is an irregular wavy line.

The capsular sheath of the superior rectus is so closely united by fibrous bands to the sheath of the elevator muscle of the upper lid that the action of these two muscles is in a measure associated.

THE INFERIOR RECTUS.

(Synonyms: *Musculus deprimens*; *M. humilis*.)

The inferior rectus, arising from the zonula of Zinn, by a tendon in common with the internal rectus, extends along the lower border of the orbit, and, like the other recti muscles, turns upon the globe

of the eye and is inserted below and behind the cornea, at a distance of 6.5 millimeters, by an expansion of its tendon 9.8 millimeters in extent. It is 40 millimeters long, and weighs $\frac{2}{3}$ gram. Its insertion is like that of the superior rectus, curved with the convexity forward. It occupies a position such that the horizontal meridian of the eyeball would divide the insertion into two unequal parts, the greater being at the nasal side.

As the capsular sheath of the superior rectus is intimately connected by fibrous bands to the sheath of the elevator muscle of the lid, so the sheath of the inferior rectus sends bands to the cul-de-sac of the conjunctiva and to the cartilage of the lower lid.

The numbers above given, representing the length, breadth, weight, etc., are those given by Volkmann and other authorities, and are, of course, approximate only for the adult, and must of necessity vary according to the age and size of the individual, and it will also be seen that variations result from the axial length of the eye, being thus associated with the refractive conditions and with the direction of the axis of the orbit, and that there are many normal variations. But while the comparative relations of size and strength will remain nearly in the proportion given, the rotatory influence of each muscle must be to a certain extent determined by the position of the insertions.

THE SUPERIOR OBLIQUE MUSCLE.

(Synonyms: *Musculus oblique major*; *M. oblique longus*.)

The superior oblique, arising from the zonula of Zinn, between the origin of the rectus internus and the superior rectus, has its course forward and inward toward the superior internal angle of the orbit, where it is transformed into a round tendon which passes through a tendinous pulley, the trochlea.

This fibrous extension of the periosteum (the trochlea) is situated at the trochlear fossa of the frontal bone, and is lined by a synovial membrane.

From the trochlea the tendon changes its direction, passing outward, downward and backward, forming an angle with its former direction of about 50° , expanding again into a flattened fusiform band which passes upon the upper surface of the bulb between the eyeball and the superior rectus, beyond the equator of the eye in its course backward and outward to the posterior half of the upper surface of the globe, and mostly outside the median line. Its insertion is, therefore,

mostly at the upper, outer, posterior quadrant of the eye, attached obliquely, with its upper or posterior extremity more toward the median line, encroaching upon this and in many cases crossing it, the lower extremity finding its attachment more externally. Dividing the ball by the equator and by a vertical median meridian, a small portion of the tendinous insertion is found, in hypermetropic and in certain emmetropic eyes, at the upper posterior and inner quadrant as above remarked, while much the more extensive part of this insertion is in the upper, posterior, and outer quadrant of the sclerotic surface. In emmetropic and myopic eyes, the insertion upon the outer quadrant is more general (Fuchs).

If we examine Fig. 16 we see that the insertion is, like that of the other long muscles, varied, and that not only the position of the insertion but its length and curvature are subject to variations.

The diagram shows also that the anterior extremity extends outward about as far as the outer extremity of the external rectus, and that it forms with a line drawn parallel to the horizontal meridian and at the upper border of the cornea, an angle of about 45° (Fuchs).¹ The antero-external extremity approaches very near to the posterior external extremity of the rectus, so near indeed that the capsular investment of the two muscles is often joined, giving the insertions the appearance of being continuous. Fuchs found in a single instance that the tendons themselves were actually continuous. The diagram shows also the curving of the insertion with the convexity of the curve outward and backward. Weiss finds the average length of the insertion 7.26 millimeters, ranging from 5.5 millimeters to 9.75 millimeters.

THE INFERIOR OBLIQUE.

(Synonyms: *Musculus oblique minor*; *M. oblique brevis*.)

Of all the muscles which communicate motion to the eyes, the inferior oblique alone does not find its origin in the posterior part of the orbit. Arising from a depression in the orbital plate of the superior maxillary bone, at the inferior and internal angle of the orbit and just within the border of the cavity, its course is backward and outward, passing just between the orbital wall and the inferior rectus, then between the globe of the eye and the external rectus muscles, to

¹ According to Weiss, "Wachstum des Menschlichen Auges," from 30° to 62° .

the superior external and posterior quadrant of the globe, where it finds its insertion by a broad aponeurosis into the sclera, nearly facing, but somewhat behind, the insertion of the superior oblique. In its course, as it hugs the globe of the eye, it grows gradually wider toward its insertion, which is more nearly horizontal than that of the superior oblique. According to Fuchs, the insertion of this muscle is the most variable of any of the eye muscles. According to Weiss, the length of the insertion-line varies from 10.5 to 13 millimeters, averaging 11.45 millimeters. In general the line of the insertion is, at the extremity nearest the cornea, rather above the lower extremity of the insertion of the external rectus, and about 10 millimeters external to that insertion. At a distance varying in different cases it rises obliquely, passing to the horizontal meridian, curving, with its convexity upward. The inner and lower portion of the insertion is more irregular, as a rule, than the outer and upper portion, and occasionally receives one or two small bundles of tendons from a partial insertion line, which soon unite with the main body of the tendon. A straight line drawn from the two extremities of the insertion would form an angle with the horizontal meridian of the eyeball varying from 16° to 30° (Weiss).

SECTION V.

INSERTIONS OF THE TENDONS.

The insertion of the tendons of the long muscles into the eyeball is by no means entirely uniform in direction in different eyes.

In less than half of the cases are the lines of insertion of the internal and external recti so placed as to make right angles with the horizontal meridian. In general, when either does not, the upper end approaches more nearly to the cornea. On the contrary, in case of the external rectus, the majority of insertions have the upper portion nearer to the equator than the lower extremity.

The lines of insertion of the rectus superior and rectus inferior have their outer extremities nearest the equator. (Fig. 16, p. 59.)

In their relations to the median horizontal meridian the insertions also vary by being placed more to one or the other side of the meridian line. Thus the internal and external rectus in about half the cases have the middle of the tendinous line coinciding with the horizontal meridian, while, when this is not the case, the middle of the insertion of the internus is generally below the horizontal line,

even in some cases to the extent that two-thirds of the insertion is below the meridian, while the external rectus, on the contrary, more frequently varies by having the greater part of its insertion line above the meridian.

The importance of such irregularities is apparent; for while the action of the internus in such cases, if at all extreme, may cause a modification of the declination of the vertical meridian, the comparative distance of the insertion from the cornea will also materially affect the action of the muscle. The nearer the insertion is to the cornea, the greater will be the influence, *ceteris paribus*, in rotating the eye in the direction of its action.

It will be seen from what has preceded, that it is not practicable to form a table of exact distances of insertion from the cornea, and that such tables and statements must be accepted only as approximate results of many examinations.

The insertions also vary, as will be seen by the diagram at page 59, in length and direction. It is not to be assumed, however, that a narrow tendon indicates a feebly acting muscle, for a muscle of full rotating capacity may have a narrow insertion.

It should be remembered, from a surgical point of view, that the muscles of the eye have what may be regarded as a double insertion: that directly to the sclerotic, and that formed by the capsule.

The study of the attachments of the individual muscles to the globe of the eye, is of primal importance to the surgeon. The exact extent and direction of each insertion has an important bearing upon the rotations, whether by a single muscle, or by the united contractions of more than one. In every attempt also to modify the rotating influence to any exactly graduated extent, either by relaxation or by contraction, a knowledge of the extent and direction of the insertion is essential to the highest success.

We are indebted to Fuchs¹ for a most careful and valuable study of the comparative locations and directions of the insertions of the various

¹"Beitrag zur Normalen Anatomie des Augapfels;" Archiv für Oph., Bd. xxx, Abth. iv, p. 1. Only in recent years have the comparative positions of the insertions of the eye muscles been studied. Thus Sommering (1), 1791, and Munz (2), 1815, state that the insertions of the four recti are at equal distances from the cornea. Somewhat more accurate measurements were given by Merkel (3), 1820, and others, and in 1845 Rute (4) stated the insertion of the rectus superior to be 7.2 millimeters, of the rectus inferior 6.8 millimeters, of the rectus internus 5.2 millimeters, and of the rectus externus 7.5 millimeters from the corneal border. Ross (5), Hollsteen, Piltz (6), Henle (7), Hoffman (8), and Merkel (9) gave other measurements with advancing

muscles attached to the eyeball. This study, undertaken primarily as a topographical investigation bearing upon the subject of myopia, includes incidentally other points which constitute valuable contributions to this subject.

Although the refraction of the eyes used as material in his investigations was unknown, the author estimated it from the length of the optical axis in each case. From this estimate he divides the eyes employed in the investigation into emmetropic, myopic, and hypermetropic, and arrived at somewhat different results according to the assumed refractive conditions.

The following table gives the average distances of the insertions of the recti muscles into the globe from the corneal border, as found by this author:—

Table of Measurements of the Breadth of the Insertion Tendons of the Recti Muscles.—
(From Fuchs.)

	31 EMMETROPIC EYES			20 MYOPIC EYES			4 HYPER- OPIC EYES.
	Max.	Min.	Average	Max.	Min.	Average	Total Average
Rectus internus . .	12.0	8.8	10.3	13.7	9.8	11.4	10.2
“ externus . .	10.2	8.5	9.2	12.7	8.8	10.1	9.1
“ superior . .	13.2	8.5	10.6	12.7	9.0	10.9	9.9
“ inferior . .	13.2	7.8	9.8	13.2	8.8	10.4	9.6

The findings of Weiss¹ for the measurements of the breadth of the insertions of the recti were an average for adults:—

- For the internal rectus, 10.76. (Max., 12.5. Min., 10.)
- For the superior rectus, 10.75. (Max., 11.25. Min., 10.)
- For the inferior rectus, 10.35. (Max., 11.10. Min., 10.)
- For the external rectus, 9.67. (Max., 12.0. Min., 8.3)

completeness. See Weiss; “Über das Wachstum des Menschlichen Auges,” for more lengthy details.

- (1) “Muskellehre,” 1791.
- (2) Martin Munz: “Handbuch der Anatomie,” 1825.
- (3) “Anatomie,” 1820.
- (4) “Lehrbuch d'Ophthalmologie,” 1845.
- (5) “Chirurg. Anatomy,” 1848.
- (6) “Augenheilkunde,” 1859.
- (7) Henle: “Handbuch d'Anatomie,” 1866.
- (8) “Anatomie,” 1872.
- (9) Graefe und Samisch.

¹Leopold Weiss, “Über des Wachstum des Menschlichen Auges,” 1897.

Right Eye of Six Year Old Child.

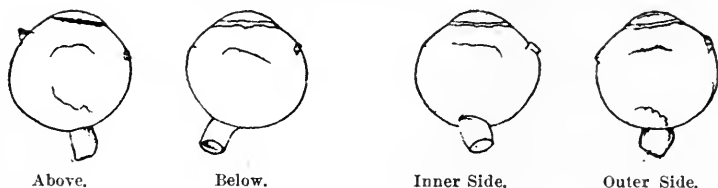

Left Eye of Girl Thirteen Years Old.

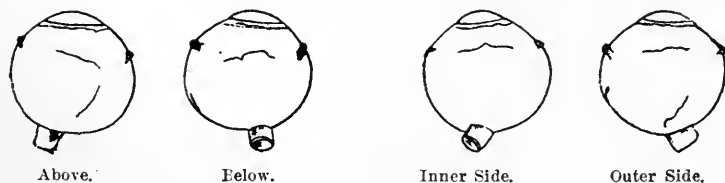

Right Eye. Known to Have Been Emmetropic.

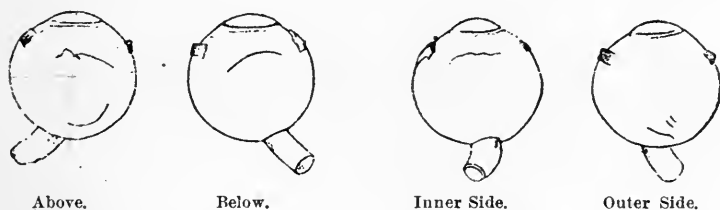

Fig. 15.—Diagrams Indicating the Insertions of the Muscles in Three Pairs of Eyes of Young Persons. (From "Wachstum des Menschlichen Auges." Used by permission of Professor Weiss.)

The table on following page gives the distances of the insertions of the recti muscles into the globe from the corneal border as found by Fuchs.¹

¹"Beitrage Zur Normalen Anatomie des Augapfels;" Archiv für Oph., Bd. xxx, Abth. iv, p. 1.

Table of Distances of the Insertions of the Muscles from the Cornea.— From Fuchs.)

	31 EMMETROPIC EYES Dist. from Border			20 MYOPIC EYES Dist. from Border			4 HYPER- OPIC EYES From Border
	Max.	Min.	Average	Max.	Min	Average	Average
Rectus internus . .	6.7	4.3	5.5	6.2	4.8	5.5	5.2
“ inferior . . .	8.2	5.3	6.5	8.5	6.3	6.9	6.0
“ externus . . .	8.2	5.3	6.9	8.2	5.8	6.9	6.4
“ superior . . .	9.0	6.8	7.7	9.7	6.3	7.7	7.1

It is readily seen from the differences of the figures for the maximum and minimum that the individual variations are considerable. But not only are these variations in the distance of the insertions of the tendons of the individual muscles from the cornea, the direction of the attachment and its length are different for different eyes.¹

In the new-born, the measurements were:—

Average for the rectus internus, 3.6 mm. (Max., 4.3. Min., 3.0.)

Average for the rectus externus, 4.9 mm. (Max., 5.5. Min., 4.0.)

Average for the rectus inferior, 5.0 mm. (Max., 5.5. Min., 4.0.)

Average for the rectus superior, 5.8 mm. (Max., 7.0. Min., 5.0.)

In adult cases:—

Average for the rectus internus, 5.85 mm. (Max., 6.75. Min., 5.0.)

Average for the rectus externus, 6.75 mm. (Max., 7.75. Min., 6.25.)

Average for the rectus inferior, 6.85 mm. (Max., 7.5. Min., 6.0.)

Average for the rectus superior, 8.01 mm. (Max., 9.0. Min., 6.75.)

Although the rule was found to prevail that when the distance from the cornea of a tendon insertion is greater or less than normal the insertion of the other tendons is similar, and that thus the comparative arrangement for an individual eye is in most cases subject to the general plan, this rule was by no means constant. In case of the relations between the rectus externus and rectus inferior the variations are sometimes extreme.

The results of the very careful measurements were in each case represented upon a diagram in which a line indicated the exact length

¹ Leopold Weiss (“Über das Wachstum des Menschlichen Auges,” etc.) found marked differences in the distances of the insertions of the recti muscles from the border of the cornea. That of the superior rectus was, however, greatest, and the internal rectus the least.

of the insertion and its relations to the cornea and equator magnified four times. The majority of the measurements were drawn upon the same paper.

Thus the diagrams enable one to compare the variations in the insertions of the individual muscles. All these diagrams were drawn

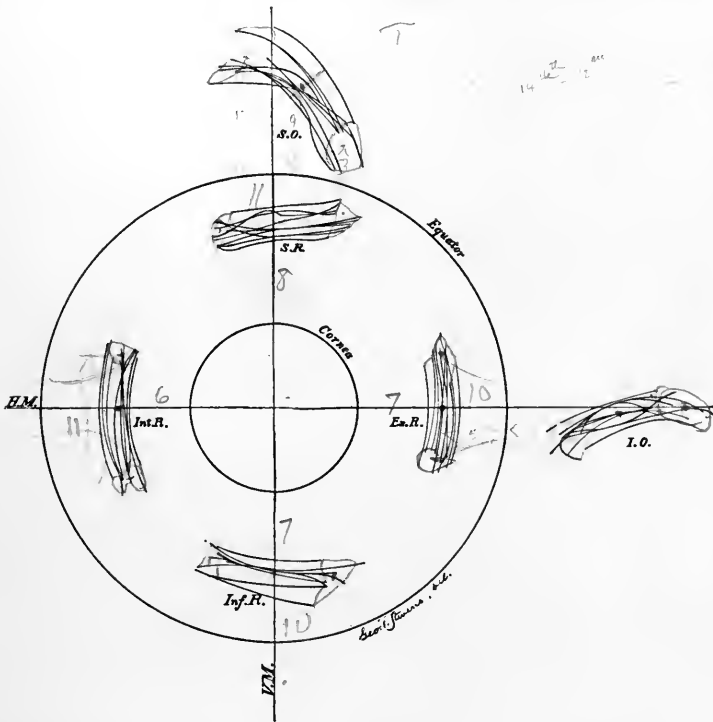

Fig. 16.—Design by the Author to Indicate the Relative Insertions of the Different Muscles into the Sclera (according to the data supplied by Professor Fuchs). *S.O.*, Superior oblique. *S.R.*, Superior rectus. *I.O.*, Inferior oblique. *Ex.R.*, External rectus.

upon a projection plane in which straight lines replaced the curves of the cornea and equator.

In order to present in much less space and in a manner somewhat more readily comprehended the results arrived at by this investigation, I have in the accompanying figure attempted to reproduce these diagrams in a combined form, reducing at the same time the enlargement from four times to rather less than twice the length. If I have not fully succeeded, I have at least represented graphically the gen-

eral fact of these variations. In the figure the larger circle represents the equator of the eye, the smaller the cornea. The vertical line represents the vertical meridian, and the horizontal the horizontal meridian. On the left side are shown the lines representing the insertions of the internal recti of nine eyes assumed to be emmetropic; on the right the insertions of the external recti of the same series of eyes; on the vertical line are superior and inferior recti, and assuming a more oblique direction are those of the superior and inferior oblique, the first on the vertical, the second on the horizontal line.

It requires no long study of the lines in this diagram to learn that not only are the insertions of the muscles of different lengths, but that they are inserted at different angles with the border of the cornea, and that the distances between the corneal border and the insertions vary materially; and we may well adopt the conclusion of the author that, "from the above facts it would seem not improbable that changes in the relations of the insertion distances should have the result of a disturbance in the muscular balances." From this very reasonable deduction, however, the learned investigator soon escapes, for apparent difficulties arise which lead him to a different conclusion. The fact that the greater number of deviations of the eyes as they have been commonly observed appear to him to be in the lateral direction and not in the vertical, leads him to say: "*We are not to attribute too much meaning to these variations of insertion distance; we observe the same things with respect to the rectus superior and rectus inferior.*" The relations of the insertions of these two muscles are in fact very variable and they are frequently found entirely different in the two eyes belonging to the same person. Indeed, he might have made this statement regarding variations still stronger by giving the actual results.

This declaration that we must abandon a legitimate conclusion because it does not harmonize with apparent and conventionally recognized phenomena is based upon the almost universally superficial observations in regard to the ordinary forms of strabismus. And the further statement of the author that "disturbances of these (vertically acting) muscles are however only rarely met with," may be easily shown to be erroneous by examinations with the tropometer. I have shown¹ that the lateral deviations of strabismus (strabismus divergens and strabismus convergens) are very frequently the result of vertical

¹ *Annales d'Oculistique*, April, 1895. I had previously shown that hyperphoria is frequently the inducing cause of lateral deviations.

tensions, and in the course of this work it will be seen that such vertical tensions *combined with the declinations due to the manner in which the tendons are inserted into the sclera* are most commonly the cause of the lateral deviations. From the table found in the section on "Strabismus," it will also be seen that cases of vertical deviations are quite as common as lateral.

The position of the insertion line of the four recti muscles in respect to the meridian line and the equator is seen by the diagram to be subject to many irregularities. Commencing with the insertions of the outer and inner muscles it will be observed that in about one-half the cases the horizontal meridian cuts the insertion in the middle. In general, when this is the case, the insertions usually extend below rather than above this symmetrical position. In some cases nearly two-thirds lies below the horizontal meridian. In respect to the external rectus, while about the same proportion of the insertions are cut by the horizontal meridian, the variations are more frequently above than below that meridian, and these variations are frequently of high grade.

In less than half the cases are the insertion lines found at right angles with the horizontal meridian; while the upper extremity of the internus oftenest lies nearest the cornea, the reverse is true of the externus.

In the largest proportion of cases the tendon of the rectus superior has its longest part outside the vertical meridian. The displacement of the inferior rectus insertion is often outward, but to a less extent. The inner border of each of these lies nearer to the cornea than the outer. As a rule, this obliquity is quite marked.

SECTION VI.

THE CAPSULE OF TENON OR ORBITO-OCULAR APONEUROSIS.

(Synonyms: "Fascia Tenoni; F. albuginea bulbi; Tunica vaginalis bulbi.)

As has already been stated, much of the space of the orbit is filled by fatty material enclosed in a network of loose fibrous tissue. This fibrous tissue is closely connected with the periosteum and may be regarded as a modification of this membrane. In certain positions this fibrous tissue assumes the character of a well-defined membrane which serves as an investment of the eyeball and of the tendons of the muscles within the orbit.

HISTORICAL NOTE ON THE CAPSULE OF TENON.

Realdus Columbus, whose writings appeared about the middle of the 16th century, a friend of Vesalius, and an anatomist distinguished for his great erudition and accuracy in research, for whom is claimed the honor of the discovery of the stapes (an honor, however, awarded by Fallopius to Ingrassias), described what is now known as the capsule of Tenon under the name *tunica innominata*, and claimed to have discovered this membrane. It had, however, probably been described by Galen under the name of *tunica sexta*. But the knowl-

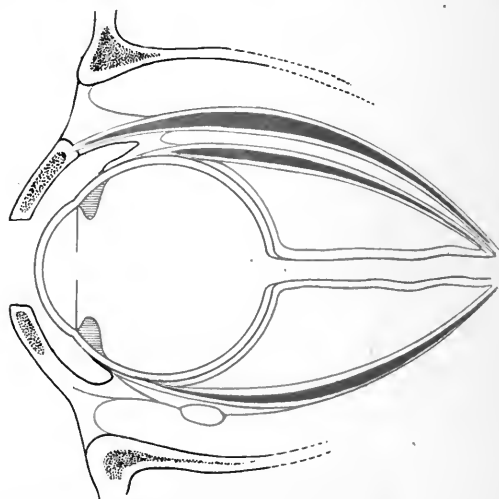

Fig. 17.—Diagram Indicating the Arrangement of the Capsule of Tenon, from a Side View. The narrow carmine lines represent the positions of the capsule. (Drawing by the Author.)

edge possessed by Galen, Columbus, and others who followed them was, concerning the actual extent and character of the membrane, extremely vague. It remained for the French anatomist Tenon to describe the capsule in its various modifications and relations to the organs within the orbit.¹

Tenon called attention to the difficulties which at his time surrounded the investigation of the subject, but showed that the aponeurosis was common to the optic nerve, to the globe of the eye, and to the eyelids; that it constituted an extension of the insertion of the tendons of the motor muscles; and that it sent out strong bands which connected the eyeball with the orbit.

¹ Tenon: "Memoires et d'Observations sur l'Anatomie, la Pathologie et la Chirurgie, et Principalement sur l'Organe de l'Oeil," p. 193. Paris, 1806.

Like many another discovery in science, this remarkable exposition was forgotten through many years, and it was only after the discovery of strabotomy by Stromeyer in 1839, when questions relative to the contents of the orbit assumed a new interest, that the observations of Tenon were revived and their importance comprehended.

Much has since then been added to the knowledge of this tunic through the researches of later anatomists, but the honor of the first systematic description rests with Tenon.

In regard to some of the subsequent discoveries, Bonnet¹ says: "Tenon discovered the existence of this capsule. . . . M. Maligne insisted more than Tenon upon the part of the capsule which is intermediary to the conjunctiva and the sclerotic. M. Baudrus found the sheaths which the capsule sends to the recti and oblique muscles. I discovered the intimate adherances of the muscles with their sheaths and with the capsule."

In this Bonnet gives scant credit to Lucien Boyer for his observations upon the close union of the muscles with each other and to the eye through the medium of the capsule and its extensions.²

This capsule of Tenon, while it has not failed to be recognized as an important anatomical factor of the contents of the orbit, has not been sufficiently considered from the standpoint of conservative surgical corrections of anomalous tensions of the eye muscles. Attention has been called more especially to its importance as an accessory to the recti muscles, requiring surgical division in order to increase the effect of the tenotomy of the tendon of the muscle itself, rather than to its office in maintaining exact and physiological relations between the muscle tendon and the eyeball, not only in the normal state, but in case of a division of the former.³

¹ Annal. d'Oculistique, 1842, p. 148.

² Gazette des Hôpitaux, 1841.

³ Bonnet first called attention (*Annales d'Oculistique, 1841, pages 27-30*) to the fact that unless the capsular extension constituting the sheath of a tendon was divided in the operation for strabismus, the muscle might continue to act as before. Hence, if the incision was first made through this the "*stilet (then used instead of the hook) glides without obstacle behind the sheath of the muscles, and one may cut them (the muscles) together with their aponeuroses surely and completely.*"

The more recent methods of introducing a hook beneath the tendon and behind its insertion, and bringing the extremity out at the other side of the tendon, thus making the section of what is included, results practically the same as the complete section recommended by Bonnet. It also effectually destroys the physiological relation of the tendon to the eyeball and to the neighboring muscles.

While it is true that some reference has from time to time been made to the importance of preserving, in some measure, the capsular attachments, the actual practice has been to sever them.

In respect to the importance of the office of the capsule of Tenon in modifying and maintaining the effects of surgical operations upon the eye muscles, the views advanced and maintained by myself during a number of years are in contrast with the views previously maintained.¹

INTERNAL OR BULBAR CAPSULE.

The eyeball rests in this portion of the capsule much as an acorn lies in its cup. Commencing at the point where the connective tissue

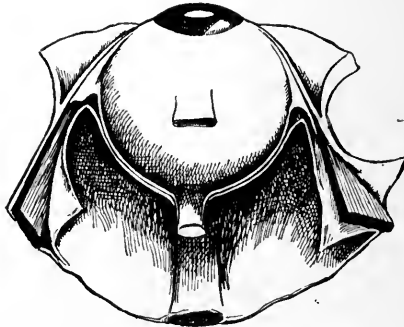

Fig. 18.—Investment of the Muscles of the Eye by the Capsule of Tenon. Reproduced from Motais's "Anatomie de l'Appareil Moteur de l'Œil," by the kind permission of Professor Motais.

is condensed into a membranous ring at the entrance of the optic nerve within the orbit, we may trace the capsule as an outer sheath of that nerve and as a membrane forming the lining of the socket in which lies the greater part of the globe of the eye. The surface of this bulbar portion of the capsule facing the sclera is smooth and covered with epithelium,² thus receiving the character of a serous membrane. It is closely attached to the sclera around the entrance of the optic nerve. The ciliary nerves and short ciliary arteries penetrate the membrane at this point and receive an investment from it. Further forward the *vasa vorticosa* traverse this portion of the mem-

¹ These views will be stated in the sections on Heterophoria and Strabismus.

² Schwalbe: "Lehrbuch des Anatomie des Auges."

brane. Behind the line of insertion of the muscles the capsule is reflected backward to form the *common aponeurosis* of the group of muscles occupying the orbit. It is called also the *external capsule* or *muscular capsule*. It invests the tendons as a sheath of some thickness, becoming more intimately attached to the surface of the muscles and thinner as it extends backward. Between the muscles, it extends as a distinct but rather thin membrane forming a continuous structure.

Posteriorly, returning to the ring from which the long muscles have their origin, it undergoes histological changes and unites with or assumes the form of the periosteum.

EXTERNAL CAPSULE OR EXTERNAL APONEUROSIS.

Returning now to the line where the bulbar capsule is reflected as the common aponeurosis of the muscles, we find the portion of this structure most interesting from the surgical point of view. In text-books of anatomy and ophthalmology it is generally stated that the tendons of the muscles "penetrate" the capsule at this insertion. This expression conveys an incorrect impression. As we have seen, the capsule is reflected back upon the muscles. In the general line of this reflection, it extends between them as a strong band and from the borders of the tendons the sheath spreads out in such a manner as to give the appearance of a greatly extended tendon. To render this extension more important, strong bands extend from the angle of reflection to unite with the sclera, thus constituting the capsular extension an accessory portion of the tunica of much importance.

The aponeurosis, for the better understanding of this course, may be regarded as consisting of two layers, one of which lines the inner, the other the outer surface of the muscles; the two being united in the spaces between the different muscles. The reflection of the internal of these layers occurs at a distance of several millimeters behind the insertion of the muscle, so that if the muscle is raised from the eyeball (as in Fig. 19) a triangular space is left, the three sides being formed respectively by the sclera, the tendon and the fold of the capsule.

As the muscle is raised, the membrane is seen to be smooth, shining, and perfectly continuous upon the inner surface of the muscle, and upon the surface of the globe, as well as at the location of the fold.

The external layer follows the tendon closely, but leaves it at its proximal fifth, and, passing forward, becomes closely united with the sclera, extending nearly to the cornea. At this point it is somewhat difficult to separate it from the sclera on the one side, and the conjunctiva on the other.

This layer while resting upon the muscle and tendon, until the latter is lost in the sclera, is free in the anterior part of the course of the tendon. The layer here surrounds the eye as a band and does not consist simply of fibers radiating from the tendons. Anterior to the equator, it becomes thickened and strengthened, thus forming, with the internal layer, a double sheath, in which are found the tendons of all the motor muscles of the eye.

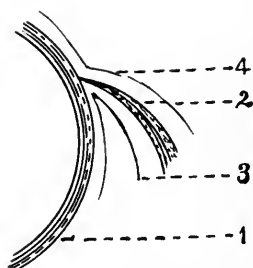

Fig. 19.—1, Sclera. 2, Tendon. 3, Fold of the capsule. 4, External layer of the capsule. (Diagram by the Author.)

A strong layer, dividing from this external layer at the *cul-de-sac* of the conjunctiva, passes forward beneath the conjunctiva of the lids, and this layer again dividing, sends a thick and strong layer to the border of the orbit.

Still another important reflection from this portion of the membrane is that which covers the elevator muscle of the lid and again divides, sending a layer toward the margins of the orbit, where it becomes continuous with the periosteum, and as such it lines the orbital walls and, passing backward, completes the circle of the external layer at the orbital foramen. At various parts of its course, the membrane sends off layers of tissue which serve as envelopes to vessels and nerves which traverse it, and other more delicate layers which surround the fatty lobules which constitute the fatty cushion of the orbit.

LIGAMENTOUS AILERONS OR BRIDLES—ORBITAL MUSCLES.

("Gaines Muscularis," C. Sappey: "Recherches sur Quelques Muscles a Fibres Lisses," etc., 1867. "Fasciæ Musculares Oculi," etc.)

Tenon described strong bands of fibers which pass from the surface of the sheath of the internal and external recti to the orbital walls, under the name of *ligamentous ailerons*. Sappey found that these ailerons contained muscular tissue and gave to them the name of orbital muscles. Motais finds similar bands, but wanting muscle fibers, extending from the other recti muscles and from the lesser oblique. These ailerons or orbital muscles are, in fact, modifications of the capsule, containing in case of the internus and externus a few muscular fibers. One such band passes from the superior rectus to the tissues connected with the upper eyelid, and may impart to the lid a movement associated with that of the rectus. Other bands connect the superior rectus and the elevator of the lids; a similar fasciculus unites the inferior rectus and inferior tarsal cartilage.

Of these ailerons, that from the external rectus is the most important in strength and extent. Taking its origin from the whole breadth of the capsular sheath of the anterior portion of the external rectus, it is condensed into a conspicuous band which, parting from the anterior portion of the muscle, extends to the external angle of the orbit. It has, according to Motais, a breadth of 7 or 8 millimeters, and a length, from its commencement on the sheath of the muscle to its insertion into the orbit, of 18 to 20 millimeters. Its thickness varies from 3 to 6 millimeters. At the somewhat extended region of its origin, the sheath becomes very firmly attached to the muscle, so that an attempt to separate the capsular investment from the muscle results in tearing the latter. Its insertion at the orbital border is about 6 or 7 millimeters in extent.

The aileron from the internal rectus, though less thick and conspicuous than that from the external rectus, is still easy to find. Like the origin of that of the external rectus, the inner aileron and the sheath at the locality of the origin is very intimately connected with the muscle through a space of 6 or 7 millimeters from before backward. Leaving the muscle at its anterior portion, it proceeds to the internal angle of the orbit, where it is inserted into the os unguis. Sappey has found in it many muscular fibers, especially in its anterior extremity. Fibers which pass to the tarsal cartilage are known as Horner's muscle or tensor tarsi.

The band extending from the superior rectus joins the sheath of the elevator of the lid; starting from about as far back as the equator of the eye, it attaches itself by one layer to the elevator muscle, being reflected back upon it, while another layer passes to the cartilage of the upper lid.

The aileron from the inferior rectus forms behind the equator of the eye and passing forward and downward, enveloping the inferior oblique, finds its insertion in the cartilage of the lower lid.

The inferior oblique muscle sheath sends a band strongly ligamentous downward and outward and forward, having a muscular origin of 7 or 8 millimeters and an insertion into the inferior interior angle of the orbit of about 5 or 6 millimeters. The union of this ligament and of that from the inferior rectus forms a support to the oblique, somewhat similar to a pulley.

These fibrous bands, ailerons, bridles, orbital muscles, or orbital tendons as they are called may act as bands of restraint, preventing excessive rotation of the eyes from too great contraction of the muscles. Not only may these bands serve as means of restraint to excessive excursions of the eyes, they may also serve as media of association of action. For example, between the superior rectus and the elevator of the lid the bands may assist in associating the elevating influence of the two muscles which act, one upon the eyeball, and the other upon the lid, which must be raised simultaneously with the eye, in order that the pupil may remain uncovered. Between the capsule or fascia as it covers the upper lid and the skin of the lid these bands are again conspicuous.

GENERAL CONSIDERATION REGARDING THE AILERONS AND APONEUROSIS.

It is easy to see that these strong bands may have a very important influence in case of tenotomy of either of the muscles from which they take their origin.

It is easy also to observe that the broad insertion of the capsule upon the sclera near the cornea, closely enveloping the insertions of the recti muscles must lend important, indeed, essential, support to the muscle, in case the tendinous insertion is separated from the sclera.

The glistening surface of the inner capsule in which the eye rests strongly suggests the rotation of the eye upon this smooth surface,

as the head of the femur rotates in its socket. And this is the interpretation almost universally given by authors:

The fact, however, of the close adhesion of the capsule around the scleral entrance of the optic nerve and that of its firm insertion around the eye near the cornea, appear to render such movement of a very limited character. Experiments of Motais would indicate that the eye with its immediate investing capsule rotates in the bed of fat.

One of the strong bands from the aponeurosis closes the sphenoidal fissure. It was described by H. Müller under the name of orbital muscle, and it is to this band that the term is at present more especially applied. It contains, like some of the ailerons, bundles of unstriated muscular fibers which serve to give it a certain elasticity by which the contents of the orbit are prevented from pressing backward into the sphenoidal fissure. It is supplied by nerve fibers from the great sympathetic, and it is thought that this fact accounts for the sinking of the eye in some cases of paralysis of certain branches of that nerve.

SECTION VII.

THE VESSELS SUPPLYING THE MUSCLES OF THE EYE.

ARTERIES.

The ophthalmic artery, a branch of the internal carotid, entering the orbit at the orbital foramen at the external side of the optic nerve and rather below its center, furnishes the principal blood supply to the muscles. Advancing nearly horizontally a distance of about three-fourths of an inch, its main trunk rises above the level of the nerve (sometimes turning beneath it)¹ and passes to the inner wall of the orbit, along which it takes its course lying between the external rectus and the superior oblique. At the border of the orbit it divides into two main branches, as the nasal and frontal arteries.

As the artery passes over from the outer to the inner side of the optic nerve, it gives off several branches which go to supply the lachrymal gland, the interior of the eyeball, the cellular tissues of the orbit, and the six motor muscles.

The infra-orbital artery, branching from the internal maxillary, which originates from the external carotid, in its course through the

¹F. Meyer ("Morpholog. Jahrbuch," t xii, p. 414) says that he has observed this peculiarity in 20 cases.

infra-orbital canal, gives off branches which ascend to the orbit and are distributed to the internal rectus, the inferior oblique, and the lachrymal gland. Elsehnig finds that in case of obstruction of the blood supply arriving from the internal carotid, the circulation may be supplemented from the external carotid to the extent of fully supplying the parts usually supplied by the internal carotid.

VEINS.

The ophthalmic veins, superior and inferior, are formed of branches somewhat corresponding to those of the ophthalmic artery

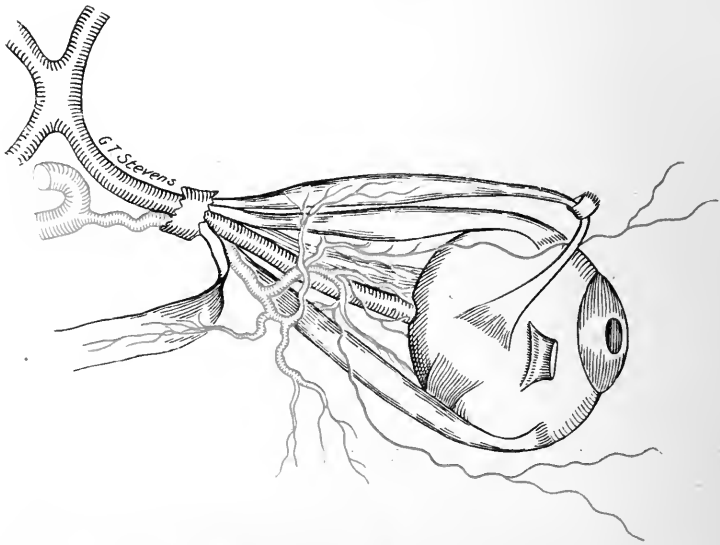

Fig. 20.—Arteries Supplying the Muscles of the Eye. (Drawing by the Author.)

and which unite in a single group at the summit of the orbit which, passing backward between the heads of the external rectus, enters the sphenoidal fissure and opens into the cavernous sinus. The superior ophthalmic is the largest of the two and corresponds closely in its course with the ophthalmic artery. It anastomoses at the internal angle of the eye with the frontal and nasal veins.

The inferior ophthalmic vein appears in the inferior part of the orbit, receiving branches from the nose, the face, the lids, and the lachrymal passages, and passes backward to unite with the superior ophthalmic vein or to discharge directly into the cavernous sinus.

SECTION VIII.

THE NERVES OF THE MUSCLES.

The six motor eye muscles receive their innervation from three cranial nerves. These are the third (oculomotorius or oculo-motor), the fourth (trochlear), and the sixth (abducens). Of these, the third nerve presides over the movements of four of these muscles: the rectus internus, the rectus superior, the rectus inferior, and the inferior oblique muscle. The fourth nerve acts upon the superior oblique, while the sixth nerve supplies the external rectus.

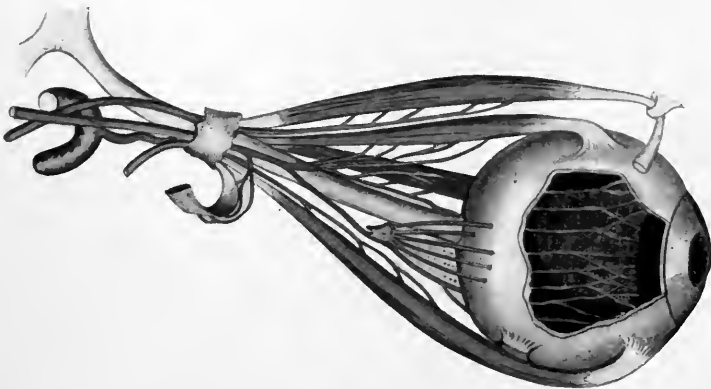

Fig. 21.—Distribution of the Nerves of the Muscles of the Eyes.
(Drawing by the Author.)

1. *The third (oculomotor) nerve* (Synon: *N. oculi motoris*) arises from a nucleus consisting of a column of large yellowish cells, situated in the ventral floor of the third ventricle and aqueduct of Sylvius. From this group of nuclear cells the fibers in various small groups pass forward through the nucleus ruber-tegmente to the pedunculus corporis mammillaris, then, before uniting, emerge from the brain substance at the line of the oculomotor groove between the two crura cerebri, and form a fasciculus of about a dozen cords which unite at a short distance from their exit from the brain as the third cranial nerve. The nerve at its thickest part is about 3 millimeters in diameter and, according to Krause, contains about 15,000 fibers. A small bundle of fibers passes through the substance of the crus cerebri, then unites with the main bundle. The origin of motor

nerves, as a rule, is in fibers some of which cross, and some of which are not crossed. In respect to the oculomotor nerve in man, the crossing of any part of the origin is questioned by some authors while others profess to have demonstrated the crossing. According to van Gudden (1887), it is shown that in rabbits the source of this nerve is of half-crossed origin. In man, the course of fibers from the main subdivision of the anterior or ventral group of cells of the nucleus is characterized by a well-developed commissural system of fibers which connect each nucleus with its fellow of the opposite side.¹ In the diagram of Edinger (Fig. 22) the crossing fibers are seen passing from the posterior median mass across the median line to join the nerve stem of the opposite side.

The symmetry of action of the muscles of the two sides which are supplied by the third nerves strongly suggest their crossed origin, and such a crossing is now generally conceded.

It has been apparently demonstrated by Duval and Laborde, that the oculomotor nerve of one side is in connection, by means of the posterior longitudinal bundle, with the abducens nerve of the opposite side.² But the observation of Nussbaum on the brains of kittens are not in line with this view. The conclusions of Bernheimer will be presented in connection with the subject of the nucleus of the third nerve.

The nerve makes its extra cerebral appearance near the internal border of the cerebral peduncle, immediately behind the pons Varolii. At this point of apparent origin, it consists, not of a single compact nervous cord, but of from 8 to 12 filaments, which at a distance of from 3 to 5 millimeters unite as a single nerve and as such proceeds toward the region of its distribution.

Passing forward and outward between the posterior cerebral and the superior cerebellar arteries, it emerges through the dura mater at the point where the tentorium cerebelli unites with the base of the skull, and makes its way along the external walls of the cavernous sinus. It lies in its course through the cavernous sinus at the inner side of the sixth nerve and of the ophthalmic branch of the fifth nerve, with which in this region it anastomoses. It also, in this part of its course, anastomoses with the great sympathetic. In its course through the cavernous sinus it assumes a grayish aspect, as if

¹ Alex. Bruce: "Mid and Hind Brain."

² Obersteiner: "Anatomy of Central Nervous Organs." Translated by Hill, 1890.

toward the eyeball, except in the case of the inferior oblique, which the nerve enters upon the outer side.

Through filaments which unite with the ophthalmic branch a connection is established between the muscular root of the third nerve and the region supplied from the ophthalmic ganglion. Hence the iris may be involved in an affection at the nuclear origin of this nerve. This, however, as may be seen from the observations by Hensen and Volckers which will be referred to later, and as will appear when the subject of ophthalmoplegia externa and interna is discussed, will depend upon the portion of the nucleus involved.

Continuing behind the group of cells constituting the nucleus of the third nerve is another group of large cells, with no distinctive boundary between it and the first group. This group of cells (the anterior trochlear nucleus) constitutes the principal origin of the *fourth nerve* (n. trochlearis), which supplies the superior oblique muscle. These cells lie in a mass of gray matter in the plane of the front of the quadrigeminal body.

From this rounded gray mass the main body of fibers of the nerve takes its origin, but farther back on the dorsal side of the posterior longitudinal bundle is another group of smaller cells (posterior trochlear nucleus). Passing obliquely backward and downward the fibers unite in bundles which take a somewhat complicated course to find their exit at a point much farther back, at the velum medullæ anterius. In their backward course the fibers, passing around the walls of the aqueduct finally, at its roof, cross with their fellows of the opposite side, the fibers of each side finding their exit from the opposite side of the roof of the aqueduct from their origin, at the velum medullæ anterius. While it is certain that the principal bundles of fibers thus cross, certain lesser bundles find their exit from the same side with their origin.

From this apparent origin at the velum medullæ anterius at the point of contact of the two crura, and just behind the corpora quadrigemina (valve of Vieussens), the nerve proceeds as the smallest of the cranial nerves (its thickness being only 0.4 millimeter) to its distribution, the trochlear muscle. The number of its fibers is said to be about 2150 (Merkel). Turning outward, around the superior peduncle of the cerebellum, and forward across the crus cerebri, it reaches the anterior portion of the crus and proceeds along the transverse fissure and between the posterior cerebral and the superior cerebral arteries, and over the internal carotid arteries. Penetrating the

dura mater beneath the tentorium, it continues its course along the outer wall of the cavernous sinus, in contact with and above the ophthalmic nerve and outside the abducens, obliquely crossing the third nerve, and enters the orbit by way of the inner end of the sphenoidal fissure. It is separated from the other contents of the cavernous sinus by a thin bony partition. As it enters the orbit it passes above the external rectus over the levator palpebræ and superior rectus, entering the upper surface of the trochlearis muscle.

The nerve anastomoses with a fillet from the sympathetic nerve in its course through the outer wall of the cavernous sinus at the

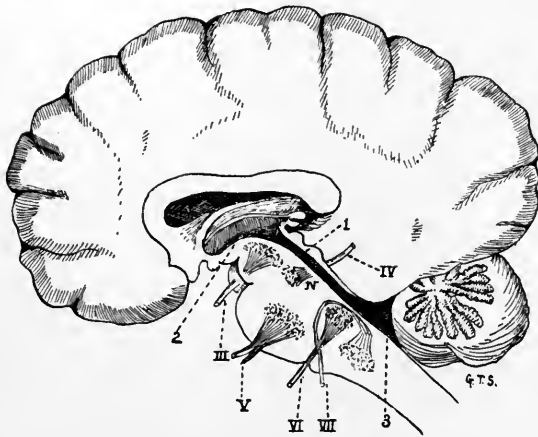

Fig. 23.—Diagrammatic Representation of Mid-brain with Approximate Situations of the Nuclear Groups from which Arise the Third, Fourth, Fifth and Sixth Nerves. (Design by the Author.)

point where it crosses the internal carotid, and also a small branch may unite this nerve with the ophthalmic branch of the fifth nerve through which, as in case of the third nerve, relations between the nucleus of this nerve and the parts supplied by the ciliary nerves may be established.¹ A small filament may sometimes be traced also to the carotid plexus, and one to the infra-trochlear nerves.² J. Stilling mentions also a small root from the cerebellum which, passing forward without crossing, unites with the trochlearis.

The Abducens or Sixth Nerve (synon. *N. oculus externus*) arises from a nucleus at the floor of the fourth ventricle behind the

¹ Luschka: "Die Nerven in der Hirnhäuten," taf. 1, 1850.

² Allen: "System of Anatomy," p. 518.

nucleus of the motor root of the fifth nerve in close connection with the nucleus of the seventh nerve. The nucleus consists of a rounded mass of large cells. From this nucleus the nerve fibers pass toward the medial line and forward (ventrally) to make their exit from the medulla just behind the pons. A small bundle of fibers from the nucleus turns median-wards and unites with the fibers of the abducens nerve of the opposite side. At a point between the anterior pyramid and the pons Varolii the nerve has its apparent origin. It passes directly forward, pierces the dura mater to enter the cavernous sinus, in its course through which it lies close to the floor in contact with the outer side of the internal carotid artery. It enters the orbit through the sphenoidal fissure below the other nerves which enter through the same channel, and passes between the two heads of the external rectus to the inner surface of which its terminal fibers are distributed. At its entrance into the orbit it is about 2 millimeters in diameter, and contains about 2000 to 2500 fibers. While in transit through the cavernous sinus the nerve receives filaments from the sympathetic plexus about the carotid artery, and further on, as it enters the orbit, a branch from the ophthalmic nerve also joins it.

Allen ("System of Anatomy") remarks that it is found that the sixth nerve is the best example of a motor nerve of all the cranial series. According to Valentin, it is the only member of the ocular group the section of which fails to elicit evidences of pain.

SECTION IX.

NUCLEAR ORIGIN OF THE NERVES OF THE OCULAR MUSCLES.

Situated in the mid-brain and in the floor of the third ventricle and extending from the level of the posterior commissure, in front of the anterior corpora quadrigemina and backward to about half-way between the anterior and posterior corpora quadrigemina lie groups of cells which give rise to the three nerves supplying the oculo-motor muscles. It is a collection of several groups which lie in somewhat irregular order from before backward, extending along the floor of the aqueduct of Sylvius to the fourth ventricle, each group of which constitutes the nuclear origin of a cerebral nerve, including the third, fourth, and sixth, which are the nerves governing the muscles of the eyes, as well as the fifth which also sends filaments to unite with some of the first mentioned. The figure above (Fig. 23) will

serve as a reminder of the general arrangement of the parts of the mid-brain in which these groups of cells are found, and approximately the relative location of this succession of groups.

The nuclear group of the third nerve is the most anterior of the series, lying above (behind) and closely connected with the posterior longitudinal bundle or fasciculus. It is a compact mass, in length, according to Perlia,¹ about 10 millimeters, but Bernheimer²

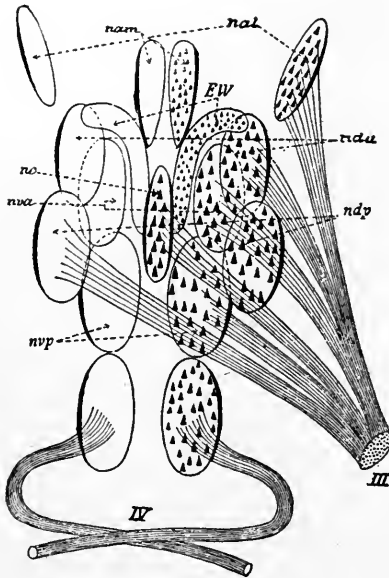

Fig. 24.—Scheme Showing the Different Groups of Nervous Cells which Constitute the Nuclear Origin of the Common Oculo-motor Nerve. (Diagram of Professor Perlia.)

gives the length as 6 millimeters. A transverse section through the masses shows two oval-shaped bodies, the lesser ends of which approach at the bottom, lying almost in contact with the longitudinal bundle. Investigators have distinguished different collections of cells in this nuclear group which have been designated according to the results arrived at by each.

¹"Archiv. für Ophthalmol." Bd. 35.

²"Wurzelgebiet des Oculomotorius," 1894. "Arch. für Ophthalmol." Bd. xlv, Ab. 3.

Perlia¹ distinguishes the groups from before backward as shown in the following:—

1. Eninger Westphal Group.
2. Anterior Lateral.
3. Anterior Dorsal.
4. Central.
5. Posterior Dorsal and Posterior Ventral.

Dr. Alexander Bruce² gives the order of the cell groups of the oculomotor nucleus thus:—

- A. An anterior group.
- B. A postero-external group.
- C. A median nucleus.
- D. A postero-internal nucleus.
- E. A superior nucleus.

According to Bruce the anterior group extends along the greater part of the oculomotor nucleus, lying closely upon the inner fibers of the posterior longitudinal fasciculus, and may itself be divided into two subordinate groups, of which that lying nearest the nucleus for the fourth nerve is nearly circular and contains no commissural fibers associating it with the corresponding subordinate group of the opposite side, while the larger subordinate group has a highly developed system of commissural fibers connecting it with its fellow of the opposite nucleus.³ Even these subordinate groups are divided into lesser collections.

The group B (postero-external group), known also as the dorsal nucleus of Erlinger⁴ and Siemerling,⁵ lies on the outer fibers of the anterior fasciculus, and is distinctly separated from the anterior group.

The group C (median nucleus) is less extensive than the two above mentioned and is situated nearer to the median line. A layer of fibers passes from it to the posterior longitudinal fasciculus, some of which also join the fibers constituting the root of the nerve.

The group D (postero-internal nucleus) is situated above the median nucleus and between it and the posterior external.

¹ *Op. cit.* Bd. 35.

² "Proceedings of the Royal Society of Edinburgh." 1889-1890.

³ Bernheimer states that these crossing bands are not commissural but are nerve fibers. *Loc. cit.* p. 11.

⁴ "Arch. für Psych.," 1885, Zwölf Vorlesungen.

⁵ "Arch. für Psych.," xxii, Suppl., Heft.

The superior nucleus (group E) is a small circular group situated above the posterior external group.

All of the groups are connected by fibers with the posterior longitudinal fasciculus, and the root fibers of the nerve pass forward in separate bundles.

Bernheimer,¹ as stated, gives the length of the nuclear mass as 6 millimeters. He thinks that the measurement of Perlia is erroneous in including the superior lateral nucleus which Bernheimer regards as completely isolated from the principal group.

The oculomotorious group, according to him, borders directly on the lesser trochlear group behind, left and right from the median line, partly under the aqueduct and bounded below by the fibers of the posterior longitudinal fasciculus; the two lateral portions of the nucleus rise as though two eggs were standing side and side with the small ends down and approaching each other. The several divisions which have been described he regards as illusions and considers the nuclear mass as undivided.² At the distal end exist detached groups of associated ganglion cells which he calls *lateral ganglion cells*, and which are in relation with those of the main group through fibers which connect them.

Centrally and toward the anterior end there are wedge-shaped groups much as described by others.

Bernheimer and others believe that they have established the proof that fibers of the optic nerve pass to the region of the quadrigeminal bodies and to the nuclear masses of the oculomotor nerve, and thereby is an association established between the sense of sight and the nerves directing the movements of the eyes.³

According to the experiments of Hensen and Volckers,⁴ made upon the exposed nucleus in dogs by electrical excitation, the nucleus of the oculomotor nerve extends from the floor of the third ventricle as far forward as the corpora mamillæ and backward along the floor of the aqueduct of Sylvius, until it joins the nucleus of the fourth nerve. These observers concluded that they recognized separate portions of this nuclear origin as presiding over the divisions of the

¹ "Wurzelgebiete des Oculomotorious beim Menschen," 1894.

² *Loc. cit.* Page 13.

³ "Die Wurzelgebiete der Augennerven." Graefe-Saemisch Handbuch, 1900, Leif, 16, S. 87.

⁴ "Über den Ursprung der Accommodations Nerven, nebst Bemerkungen über die Function der Wurtzeln des Nervus Oculomotorius;" Arch. für Ophthalmol. Bd. xxiv, 1, p. 1, 1878.

third nerve distributed to different muscles. They locate these portions as follows: First, from the floor of the third ventricle spring the fibers governing the muscle of accommodation and of the sphincter of the pupil and of the tensor choroideæ. Where the aqueduct of Sylvius enters the third ventricle, commences the source of that portion of the nerve governing the rectus internus, and behind this, on the floor of the aqueduct, that governing the rectus superior and the levator palpebræ superioris. Behind these cells lie, near the corpora quadrata, the origin cells of the branches for the rectus inferior and the inferior oblique. In respect to the origin cells of the levator superioris, of the inferior rectus, and of the inferior oblique, these observers speak without doubt.

Kahler and Pick,¹ also from the standpoint of pathology, are in accord with Hensen and Volckers that the part of the nerve governing the pupil has its origin in the anterior portion of the group of nuclear cells of the nerve, while the innervation of the four motor muscles arises from the cells more posterior, those governing the upward movements of the eyes and of the lids lying most posteriorly. In the sagittal direction, the extent of the nucleus in man is, according to Obersteiner, 5 millimeters, but according to Perlia, 10 millimeters. Mauthner gives these locations according to Kahler and Pick in the following scheme:—

	1. Nucleus for the accommodation.	
	2. Nucleus for the splincter of the iris.	
In the median line.	3. Nucleus for the int. rectus. 4. Nucleus for inf. rectus.	5. Nucleus for levator palp. sup. 6. Nucleus for superior rectus. 7. Nucleus for inferior oblique.

Then follows:

The nucleus for trochlearis.

Bernheimer,² from experiments by destruction of individual muscles and the resulting degeneration of portions of the nuclear mass in apes, arrives at the conclusion that the centers for the origin of the nerves are in the following order from behind forward:—

1. Fibers to the internal muscles (not in the experiments).
2. Rectus inferior of the eye of the opposite side.

¹“Zur Localization partieller Oculomotorius Lähmungen.” “Prager Zeitschrift für Heilkunde.” 1881.

²Archiv für Ophthalmol., xlvii, 3.

3. Inferior oblique of the eye of the opposite side with cells supplying fibers to nerve for inferior oblique of the same side.

4. Rectus inferior of the same side with perhaps fibers to the opposite side.

5. Rectus superior of same side.

6. Levator palpebræ of same side.

The importance of these investigations justifies the introduction of the results arrived at by these various observers in this place.

It has not been ascertained through what course the connection between the nuclear origin of the nerves supplying the motor mus-

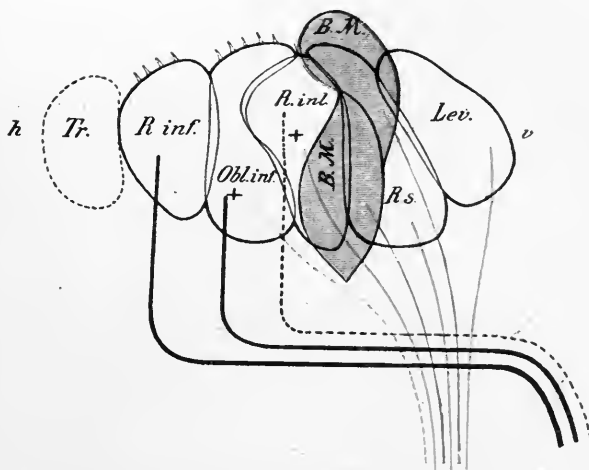

Fig. 25.—Professor Bernheimer's Diagram of the Nucleus of the Oculomotor and of the Trochlearis Nerves. (By permission of Professor Bernheimer.)

cles of the eyes and the cortex is established. In certain cases of cortical disease the elevator muscle of the lid is paralyzed, while the motor eye muscles remain intact. This fact might suggest the conclusion that the fibers for the levator palpebræ may diverge from the fibers of the other eye muscle nerves or that the fibers running to the very anterior portion of the nuclear mass are from the affected part.

The angular gyrus is the supposed location of the cortical center for the levator palpebræ. It would also appear that the center for the coördinate movements of the eyes is located in the superior frontal convolution, since a lesion at this convolution causes conjugate devia-

tion of the eyes toward the side opposite the lesion and renders the movements toward the diseased side impossible.

Stimulation by electrical means of several cortical areas has caused turning of both eyes in the same direction and toward the side opposite to that to which the stimulus is applied. These con-

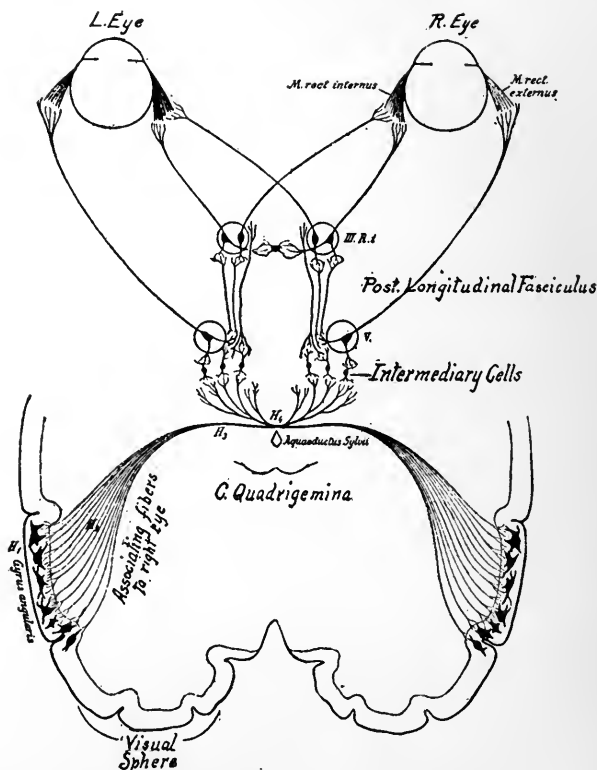

Fig. 26.—Bernheimer's Diagram of the Connections of the Nuclei of the Oculo-motor Nerve and the Cortex. (Permission of Professor Bernheimer.)

jugate deviations occur when stimulation is applied to the occipital region as well as to the region to which reference has already been made. The possibility of such effects resulting through special connections between different areas of the cortex renders the study of the subject through local stimulation difficult and inconclusive.

The researches of Bernheimer above referred to have, however, more conclusively established the relation between the angular gyrus

and nerves governing the lateral and convergence movements of the eyes.

The scheme suggested by Bernheimer of the associating connections is shown by the annexed diagram, which is copied by his permission. (Fig. 26.)

It will be observed that the connection is made through what he calls intermediary or association cells (Schaltzellen).

Notwithstanding the important researches of these more recent observers we are still unable, returning to the nuclear masses, to make with certainty a statement of the definite connections between special portions of the nucleus of the third nerve and the special muscles to which the branches of this nerve are distributed. Marina¹ even raises the question whether indeed the center for the enervation of the iris lies in the oculomotor nucleus.

Immediately behind the somewhat extended collection of cells forming the nucleus of the third nerve, and closely approximated, lies the nucleus of the fourth nerve. So closely are these two masses located that in many instances it is rather by the larger size of the cells of the latter than by any well-defined special separation that the limits of the two are to be determined. In other cases there is a separation of a slight interval. The nucleus of the fourth nerve is much less extended than its neighbor, is oval in form and lies near the middle line. It is situated near the depression which divides the anterior and posterior corpora quadrigemina, and, like the nucleus of the oculomotor, lies above (dorsally to) the posterior longitudinal bundle and below (ventrally to) the aqueductus Sylvii.

The cylindrical prolongations from which originate the fibers of the nerve pass at first outward and backward as far as the descending root of the fifth nerve, then they curve around the aqueduct of Sylvius, where, becoming more united, they decussate with the bundle of fibers from the opposite nucleus, and forming the root of the nerve, pass to the side opposite to the origin in the valve of Vieussens to form the trunk of the nerve, whose course has been described at page 75. (See Fig. 23, N, IV.)

If the nuclear masses of the third and fourth nerves are in close approximal relations, that of the sixth nerve is separated from both by a distinct and considerable interval.

Between the two former and the latter is situated the nucleus of the fifth nerve, but in a plane somewhat different—more deeply in the annular protuberance. The grayish nucleus of the sixth nerve

¹ "Über Multiple Augenmuskel Lähmungen, 1896.

is situated in the floor of the fourth ventricle and its position is marked by the eminentia teres. It is nearly spherical in form and is surrounded on three sides, lower, inner, and upper, by the loop which the fibers of the facial nerve make near their origin. Its cells are large and multipolar.

At the inner side it sends out the fibers which unite to form the nerve, which pass forward and outward and finally leave the cerebral trunk at the posterior border of the annular protuberance.

Van Gehuchten¹ says that a crossing of fibers from the two nuclei of the sixth nerve has not been found. Bruce² describes a special fasciculus of fibers which passes between the root of the facial nerve and the posterior longitudinal fasciculus, and crossing the raphé enters the opposite fasciculus. In this fasciculus these fibers may ascend to the third nucleus. In this case the sixth nerve would supply fibers to the nerve supplying the internal rectus of the opposite eye, while it furnishes the body of fibers for the nerve directed to the external rectus of the same side with itself. Muscular action from the stimulus of this nerve root therefore would induce conjugate lateral rotations of the eye toward the side on which the nucleus is located.

Fibers also pass to the superior olive, to the external auditory nucleus, and to the cortex of the opposite hemisphere.

Again, referring to Fig. 23, the situation of this nuclear mass in its relations to the other nuclear groups and to the mid-brain will be seen.

SECTION X.

CIRCULATION TO THE NUCLEI OF THE NERVES OF THE OCULAR MUSCLES.

The two vertebral arteries unite to form a single trunk, the basilar artery, which lies upon the pons Varolii. From this trunk pass a considerable number of branches, the course of which is nearly at right angles with the main trunk, and which penetrate the pons, and passing to the floor of the fourth ventricle and of the aqueduct of Sylvius, furnish to this region its principal blood supply.

These branches, unlike the vessels which supply the cortex, do not divide in arborescent and anastomosing branches, but pass directly

¹"Système Nerveux de L'Homme," 1893, page 400.

²"Mid and Hind Brain," p. 12.

as terminal vessels from the main trunk to the region which they supply. They are almost parallel with each other, forming a series of direct and comparatively straight lines. (Fig. 27.)

The trunk of the basilar artery also gives off some larger branches, the posterior cerebellar, the middle cerebellar, and the anterior cerebellar. From these branches, also, small and direct arterial twigs penetrate the substance of the pons, having the same general characteristics as those arising directly from the main trunk.

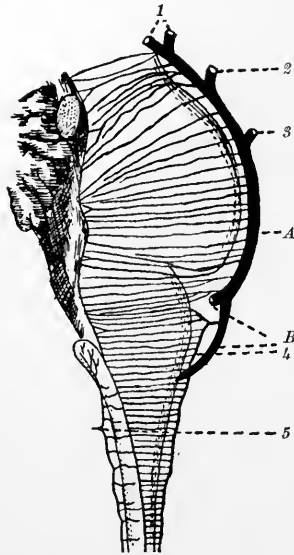

Fig. 27.—Arteries Supplying the Pons Varolii and Mid-brain. (After Duret.)

A, Trunk of Basilar artery. B, Right and left vertebral arteries. 1, Posterior cerebellar. 2, Superior cerebellar. 3, Middle cerebellar. 4, Anterior spinal. 5, Posterior spinal.

The basilar artery and its branches also send branches to the roots along the course of the nerves arising from the floor of the aqueduct and the fourth ventricle. The peculiar arrangement of the branches from these different sources renders the parts supplied by each isolated from each other, a fact of no little significance from a pathological point of view.

A series of veins resembling in their course the arteries just described empty themselves into a venous plexus which lies upon the pons.

PART II.

PHYSIOLOGY.

SECTION XI.

THE CENTER OF MOVEMENTS OF THE OCULAR GLOBE.

Before proceeding to the investigation of the movements of the eyes, it is important that the position of the center about which these movements are made should be, as definitely as practicable, understood.

Much thought and labor have been bestowed upon this subject, and the results obtained by different competent observers (Müller, Volkmann, Donders, Valentin, Barrow, and others) have not been entirely uniform. Notwithstanding some diversity in the methods and determinations the general results have somewhat approximated.

Most of the earlier observers placed the center of rotation very nearly at the center of the optic axis.

Volkmann,¹ as a result of his researches in regard to the point of crossing of the lines of direction (center of similitude), believed that he had also arrived at a determination of the center of rotation, that the point of crossing of the lines of direction and the center of rotation were identical, and that the point was situated at the middle of the axis of the eye (12.50 millimeters behind the apex of the cornea). Helmholtz² and Barrow,³ while not agreeing with the methods of Volkmann regarding the point of crossing of the lines of direction, arrived at a determination of the center of rotation nearly accordant with that of Volkmann, they placing this center at 12.40 millimeters behind the apex of the cornea. J. J. Müller, of Zürich,⁴ believed that the center of rotation changes as the eye is directed upward, that the higher the extent of upward rotation the further is the center removed from the cornea.

¹ "Neue Beiträge zur Physiol. d. Gesichtsinns," Leipzig, 1836, Cap. iv.

² "Optique Physiol.," p. 117.

³ "Beiträge zur Physiologie u. Physik d. Menchl. Auges." Berlin, 1841.

⁴ Archiv f. Ophthalmol. xiv, 3, 216.

Donders,¹ recognizing the fact that ametropia depends principally upon a difference in length of the visual axis, concluded that the distance at which the center of motion lies behind the cornea must undergo modifications depending upon the degree and kind of ametropia. He therefore instituted, in connection with Doyer, an investigation from which were obtained results differing from those previously accepted.

According to these results it appeared that in the emmetropic eye the center of motion is situated at the distance of 1.77 millimeters behind the middle of the visual axis.

Supposing the length of the visual axis to be 23.53 millimeters, the average in the emmetropic eyes examined by him, the distance of the center of motion behind the apex of the cornea averaged 13.54 millimeters, and in front of the posterior surface of the sclera 9.99 millimeters.

In myopia the average position was at 14.52 millimeters behind the cornea, and in hypermetropia 13.22 millimeters, while the average length of the visual axis in the latter condition was but 22.10 millimeters, thus placing the center of motion 2.17 millimeters behind the middle of the visual axis.

The subjoined table gives the average results obtained by Donders for emmetropic, myopic, and hypermetropic subjects²:—

	a Length of Visual Axis	Position of the Center of Motion				f Angle Be- tween the Axis of the Cornea and the Visual Line
		b Behind the Cornea	c Before the Posterior Surface of Sclerotic	d In Percentage Proportion	e Behind the Middle of the Visual Axis	
	mm.	mm.	mm.		mm.	
1 E.	23.53	13.54	9.99	57.32 : 42.46	1.77	5° .082
2 M.	25.55	14.52	11.03	56.83 : 43.17	1.55	2°
3 H.	22.10	13.22	8.88	59.8 : 40.2	2.17	7° .55

Donders's method consisted in determining how great the angles of motion (with equal excursions on both sides) must be, in order to make the two extremities of the measured horizontal diameter of

¹"Accommodation and Refraction of the Eye."

²Donders: *Loc. cit.*, p. 181.

the cornea coincide alternately with the same point in space. In other words, Donders proceeded to determine the center of rotation by procuring the elements of a triangle, one side of which, the diameter of the cornea, was known, the other sides being the two lines proceeding from the two extremities of this known line to join at the center of motion.

To this end, the diameter of the cornea was measured by the aid of the ophthalmometer of Helmholtz, the flame of a lamp being placed perpendicularly above the instrument. Through the ophthalmometer the image of the flame was seen reflected on the cornea. By means of another lamp, screened from the ophthalmometer, the cornea was illuminated. The eye to be investigated was given a definite direction by looking at a "sight" or mire which was movable.

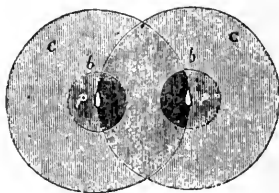

Fig. 28.—From Donders.

It was easily possible to bring the eye into such position that the reflected image of the flame should appear exactly at the center of the cornea. The ophthalmometer giving double images, the images of the flame could be made to fall upon the extreme border of the two images of the cornea, as is shown in the figure.

The number of degrees read off on the ophthalmometer required to bring the double image into this position gave one-half of the chord subtending the cornea. By turning the plates of the instrument other confirming measurements were made, and the average was taken as representing the half diameter of the cornea.

This element having been thus accurately determined, the next step was to ascertain the arc which the cornea must describe in traversing this ascertained distance, its own transverse diameter.

A ring was suspended before the examined eye in which a fine hair was perpendicularly stretched. It was then ascertained how many degrees the eye must be moved in order that the hair should appear first at one, then at the other margin of the cornea. This number of degrees corresponded to the angle which the eye had de-

scribed from its center of motion. This angle was found to be in normal eyes about 50°. The knowledge of the diameter of the cornea and of this angle of motion then served as data for the determination of the center of motion.

Giraud-Toulon¹ took exception to Donders's method on the ground that the arbitrarily described arc chosen by Donders assumed the very point which was in question. The method, he declared, would be unassailable if this arc with its arbitrary radius could be shown to have its center at the center of movement of the eye. This observer arrived at conclusions practically in accord with those of Volkman, Barrow, and Valentin, that the center of rotation is identical with the center of the globe. The methods of Giraud-Toulon, however, do not appear to have been sufficiently exact to have enabled him to have arrived at technically correct conclusions.

Ludwig Mauthner² arrived at results more in accord with those of Donders, yet somewhat at variance with them.

His average results are shown by the subjoined table, as compared with those of Donders:—

Position of the Center of Motion.

	Behind the Cornea		Behind the Middle of the Visual Axis	
	Donders	Mauthner	Donders	Mauthner
Refraction				
Emmetropia	13.54 mm.	13.73 mm.	1.77 mm.	1.24 mm.
Hypermetropia	13.01 “	13.22 “	2.17 “	1.47 “
Myopia	14.52 “	15.54 “	1.75 “	1.82 “

It may be readily concluded that the variations in the results as shown in the above table might arise from the selection of cases for examination in the groups for hypermetropia and myopia, and that the difference of about 0.2 millimeter in emmetropia might be the result of the difference in manipulation, and hence a difference which may be disregarded. The center of motion must necessarily be modified by the size of the globe of the eye. In young children the eye has not reached its full development and some anatomists have stated that it does not reach the typical form of the emmetropic eye

¹“Contribution à la Physiologie de la Vision,” *Annales d'Oculist.*, 1868.

²“Optische Fehler,” pp. 634-649, 1876; “Augenmuskellanungen,” p. 475, 1889.

until after a few years. This view does not seem, however, to be sustained by recent investigations. It would seem that the eye reaches its permanent form and size earlier than other organs. The following table is made from results of measurements of Weiss, but selecting only a part of the data given by him. According to these measurements there appears to be a rapid increase in the size of the eye during the first three or four years. From that time no very material advance is made before the twelfth year, but from that forward to the twentieth there is a steady growth. It is highly probable that with a larger number of measurements a more uniform increase in the growth of the eye would be shown:—

Subjects	Sagittal Diameter	Horizontal Diameter
	mm.	mm.
1 year and less	16 to 18 5	15 5 to 19
4 years old	21	21.75
6 years old	21.3	21.3
8 years old	21	21.5
10 years old	20.5	20.3
12 years old	21	20.8
15 years old	22 6	21.5
18 years old	23.3	23
20 years old	23.8	24.8

SECTION XII.

DEFINITIONS OF TERMS EMPLOYED IN DESCRIBING THE POSITIONS AND DIVISIONS OF THE HEAD AND OF THE RELATIONS OF THE EYES AND OF OBJECTS SEEN TO THE HEAD.

In determining the movements of the eyes toward the objects to which they are directed it is necessary that the position of the head be defined, that its various mechanical divisions be understood, and that the directions of the eyes in relation to the position of the head be clearly stated. For these purposes a nomenclature has been adopted by Henly,¹ and employed with some variations by Helmholtz. The definitions as given below are, with some changes, condensed from Helmholtz.²

The head is composed of two symmetrical parts, and the plane which divides them (*ab*, Fig. 29) is called the *median plane*. This

¹ "Handbuch der Systematischen Anatomie."

² Optique physiol. p. 508.

plane passes from before backward, completely dividing the two parts. *Sagittal* planes, or sections, are planes passing from before backward and parallel to the median plane (*cd*). Transverse planes join corresponding parts of the two sides of the head (*ef*); they are perpendicular to the median plane.

The primary position is that natural position in which the head is erect upon an erect body, and the gaze is directed exactly in advance (the lines of regard being parallel to the median plane) toward the horizon. In this position the ridge above the root of the

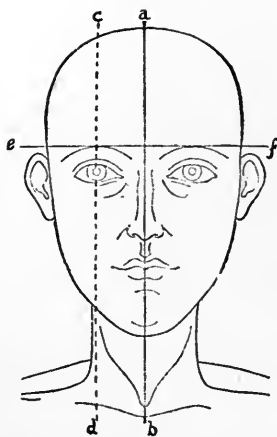

Fig. 29.—Planes of the head.

nose will be, as a rule, in a vertical line with the teeth of the upper jaw.¹

Horizontal sections, or transverse sections are planes extending from before backward when the head is in the primary position.

Frontal sections are vertical sections perpendicular to the median plane.

Sagittal lines are lines drawn from before backward in the median or sagittal planes. Such lines mark the intersection of the sagittal (or median) planes and the horizontal planes. The two sides

¹ As there is much irregularity in the position of the teeth, the author has chosen as fixed points the ridge above the root of the nose, and the point below the nose, just below the spine of the superior maxillary, the lips being pressed so that the distance from the bone is equal, as nearly as possible, at the two points. (See page 45.)

of the head separated by the median plane are the right and left; and the two sides as divided by a sagittal plane are temporal and nasal or medial. The parts above and below a transverse plane or section are superior and inferior, and when for an inclined position of the head the terms superior and inferior would not be strictly applicable, Serre proposes the terms frontal and jugal.

The two parts separated by a frontal plane are anterior and posterior.

The *point of regard*, or the point of fixation, is a point fixed by the two eyes, the point at which the visual lines of the two eyes meet.

The *line of regard* is a straight line drawn from the object fixed, through the center of rotation of an eye, and to the macula.

The *visual line* differs slightly from the line of regard, and is slightly to its external side, but for the most part, practically, these lines may be regarded as identical.

The *plane of regard* is the plane drawn by and included within the two lines of regard.

The *base line* is the line drawn between the centers of motion of the two eyes, and which therefore forms the base of a triangle of which the lines of regard form the other two sides.

The *median line* of the plane of regard is the line drawn from the middle of the base line to the point of fixation, therefore bisecting the plane of regard.

The *field of regard* is the field which the point of regard may traverse. It is less extensive than the visual field.

Helmholtz considers the field of regard "as a part of a spherical surface of which the center will be at the center of rotation."

Every new position of the plane of regard with reference to an initial position may be determined if the angle which the newly established plane forms with the initial position is known.

The *ascensional angle of regard* is the angle formed by the primary and the new position of the plane of regard above or below the first. When the plane is displaced toward the forehead, the sign of the angle is positive; when toward the chin the sign is negative.

Lateral displacements of regard are the displacements of the lines of regard in the plane of regard, and the displacements are measured by the lateral angle of displacement. This angle is positive for displacements to the right, and negative for displacements to the left.

The ascensional and the lateral angle suffice to define the position of the line of regard.

The globe of the eye may execute movements about the line of regard taken as its axis, which line may remain fixed. The extent of such movements (wheel-like) is called by Germans *Raddrehungswinkel*, and by writers in French and English, *torsion*. These voluntary rotations are to be discriminated from the leanings of the vertical meridians when the eyes are in the position of minimum innervation. These latter conditions are declinations and are not related to torsion. The extent of torsion is measured by the angle which a plane invariably joined to the eye makes with the plane of regard. For this fixed plane Helmholtz selects the plane which in the retina coincides with the plane of regard when that plane is in the primary position, and to this plane he gives the name of the *retinal horizon*. The angle of torsion is the angle of displacement of the vertical meridian when the eye passes from the primary to a secondary position. When the superior extremity of the vertical meridian of the retina is displaced to the right, Helmholtz makes the sign positive; when displaced to the left, negative. In this work displacement to the temporal side is positive; to the median side, negative.

SECTION XIII.

DIRECTION OF THE INFLUENCE OF THE VARIOUS MOTOR MUSCLES OF THE EYES.

All the rotations of the eye occur about a fixed point known as the center of rotation. This center, as we have seen, is situated rather more than a millimeter posterior to the center of the optic axis. For the practical purposes of the present chapter, in order to reduce the elements in the problems before us, the center of the optic axis may be assumed to be the center of rotation.

The six muscles which contribute to the rotations of the eye are divided into three pairs, and each pair acting by itself alone causes the eye to rotate upon a definite axis which in every instance cuts the center of rotation. In respect to one pair (superior and inferior oblique) the expression "a definite axis" has to be accepted with the reservation that it is not exactly, but for the purpose of this discussion, practically "a definite axis."

While it will be necessary in this connection to speak of the action of muscles of each eye to a certain extent independently, it is to be remembered that neither eye acts independently, but that, by virtue of their innervation, the two eyes act in definite relations and associations with each other.

Hering has expressed this law somewhat as follows: "The two eyes in their service of the visual sense are directed as though they were a single organ. To the moving impulse it matters not that this single organ exists as two different members, since it is unnecessary that either of the two should be moved or directed only for itself. One and the same impulse governs the two eyes at the same time as one may with a single rein guide a pair of horses."

While from their peculiar positions the actions of the oblique muscles upon the rotation of the globe are evidently not those of simple traction from side to side, or directly up and down, the influence of the four recti might at first thought appear to be exercised in the interest of direct movements, laterally or vertically; and that each pair, those acting laterally and those acting vertically, are directly antagonistic to each other.

That this is not the fact in the case of the vertically acting recti will presently appear, and the fact is one of much weight both in its bearing upon the subject of paresis of these muscles and upon torsions.

In regard to the planes of action of the rectus internus and rectus externus, they may indeed be regarded as nearly identical, although as seen at page 55 there are variations from the ideal insertions and therefore variations from the rotations according to the rule. If a section were made which would cut the eyeball and the two lateral recti in such manner as that the plane of the section would be identical with the center of the axis of action of one of these muscles, this plane should also divide the other muscle in about the same manner, and the plane would be carried through the antero-posterior axis of the eyeball. If the attachments of these two muscles were always uniform and in the average position, it might be said that the plane of division in such a case would be identical in each case. Unfortunately for theories of exact planes of the axis of rotation, this is rarely the case.¹

¹ Volkmann ("Berichte über die Verhandlung der Kugel," 1869) found in thirty observations that the action of the internal and external rectus included a downward movement of the eye, with a slight turning upon the antero-pos-

Thus it results that from a contraction of the internal rectus alone, the eye with typical attachments of these two muscles is rotated exactly in and undergoes no modification in its direction from the horizontal plane. In like manner, by contraction of the externus the eye is rotated directly outward, while it still maintains its original relation to the horizontal plane. *The axis of turning for the eye by the influence of these two muscles is therefore vertical.* Thus, if in the diagram (Fig. 30), the line *ab* represents a vertical axis drawn

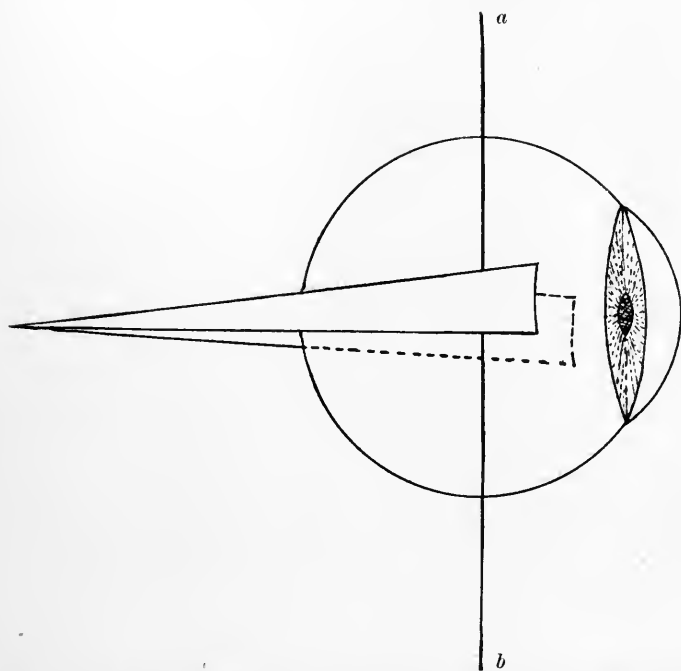

Fig. 30.—Diagram Indicating the Traction Direction of the Lateral Recti with the Axis of Rotation by these Muscles.

through the point of motion (center of rotation), by the action of the lateral recti the eye will be turned exactly upon this axis and the axis will not be forced from its original vertical position.

Notwithstanding the symmetry of action of these two antagonistic axes—this latter being less than 1° . Since the slight leanings of the axes of rotation of the two muscles would neutralize each other, and since a greater number of observations might result differently, this slight leaning may be neglected.

istic muscles, their course backward is not correspondent; for whereas the rectus internus, after rounding the eyeball, passes somewhat directly backward, and the two interni approach each other toward their origin at an angle of about 10° , the course of the externi toward the point of origin at the apex of the orbit is much more convergent, the angle of convergence being nearly 65° . It follows that the point of action upon the eyeball is farther back upon the eyeball in the case of the externi than in the case of their opponents.

As in the case of the lateral recti the planes of the muscular traction are nearly identical, so also is the plane of the action of the superior and inferior recti practically common to both. A plane through the length of one would cut the length of the other. Here, as in the case of the lateral recti, the absence of exactly uniform anatomical conditions is to be considered. Unlike the lateral recti, however, the course of the superior and of the inferior rectus is not parallel with the antero-posterior axis of the eye. From an insertion upon the eyeball, the center of which corresponds nearly to a sagittal plane drawn through the center of the eye,¹ but which is obliquely placed with reference to a horizontal line drawn above or below the cornea, its inner extremity approaches much more nearly to this line than the outer extremity, and as is shown in the diagram (Fig. 31), the course of each is backward toward its origin obliquely to the axis of the eye and inward. Thus, if the line of traction of each of these muscles now projected forward and backward, the forward extremities of such a projected line would point toward the temporal side, the other extremity inward toward the median line, and if the projection were carried sufficiently backward the lines of the traction planes of the two superior recti would meet at a point about an inch behind the sella turcica. The lines projected backward from the traction axis of the inferior recti would also meet in a like manner. Inasmuch as the center of traction from the insertion, both for the superior and for the inferior, is nearly at the point cut by a sagittal plane through the center of the eye, and as in each case the line of traction is inward, it follows that this line of traction would fall, not through the center of rotation, but to the inner side of it.

This will be seen by the diagram, in which the line *ab* is the

¹ By a study of the diagram Fig. 16, representing the insertions as found by Fuchs, it will be seen that in the majority of cases the center of the insertion of the superior rectus is somewhat external, and that of the inferior rectus somewhat to the nasal side of this sagittal plane.

optical axis, cd the horizontal axis, d its inner extremity, e the rectus superior, and e' the inferior rectus, while the center of rotation is at the crossing of the horizontal and antero-posterior axis.

From this arrangement it will be seen that were all the other muscles at rest while both the vertically acting muscles were in active and equal contraction, the eye would be rotated upon the vertical axis inward.

The horizontal rotation axis for these two muscles is naturally not at right angles to the optic axis as was the vertical axis in the

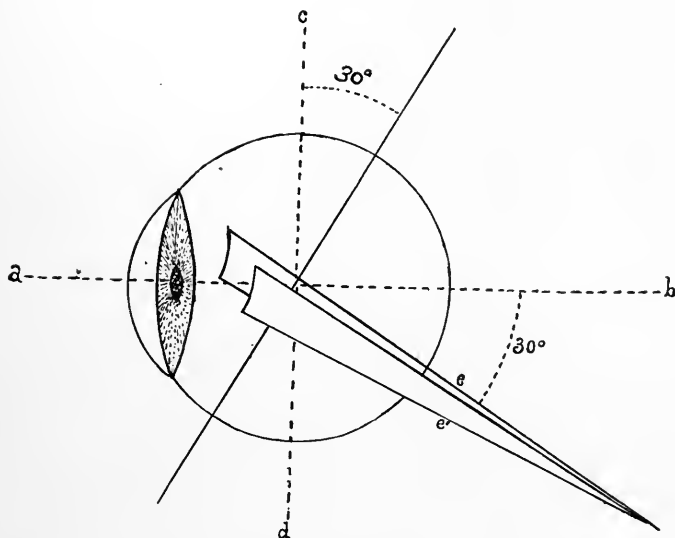

Fig. 31.—Direction of Traction of the Superior and Inferior Rectus and the Axis of Rotation by them. a, b , Optic axis. c, d , Horizontal axis. e and e' , Superior and inferior rectus.

case of the lateral recti, but cuts it obliquely, being at a right angle with the course of traction of the muscles. This rotation axis is in relation to the line of regard, according to the determination of Reute¹ at an angle of about 70° . Mauthner makes the angle with the transverse axis about 30° . This axis of rotation then points outward and backward and inward and forward and in the horizontal plane when the eye is in the primary position.

¹ "Lehrbuch der Ophthalmologie," 1857. Reute assumes the rotation point to be the center of the globe.

But the action of these two muscles upon the eyeball, as the result of their direction and as a result of the direction of this rotating axis, cannot be uniform under all circumstances. For whereas in the primary position the axis of rotation for these muscles is at an angle of about 30° with the transverse diameter of the eye, when the eye leaves the primary position, through the influence, for example, of one or the other of the lateral muscles, the relations between the axis of rotation and the transverse axis of the eye must change. In proportion as the eye is moved outward, up to a certain degree, the two axes will be more and more in accord, and in proportion as it is moved inward, up to a certain degree, will the axes diverge. Thus, in rotating out, the angle at the primary position formed by the axis of the eye and the course of the muscles being 30° , a change of the direction of the optic axis outward 30° would bring this optic axis and the axis of rotation coincident, so that in this position the action of the two muscles together would neutralize each other or, separately, one would roll the ball directly up, the other directly downward and without rotation on the optic axis. On the contrary, could the eye be turned in 60° from the direction of the line of regard in the primary position (normally placed eyes cannot be thus turned, but in some strabismic cases it is easily accomplished), the muscles would exercise their traction directly around the antero-posterior axis, and acting together would rotate it inward, while acting separately they would simply roll it upon this axis without modifying its direction.

It will be seen that at points intermediate to these extreme positions the eye must undergo not only a change in the direction of the optic axis as the result of the separate action of the members of this pair of muscles, but it must be caused to revolve upon the optic axis as a wheel upon an axle, the extent of this revolution depending upon the angle made by the transverse axis of the eyeball and the axis of action of the two muscles.

Hence, if there were to be found upon the cornea a vertical white line, this line, when the eye would be turned from the primary position inward (through the action of the internus) and upward (through the influence of the superior rectus) would be observed not only to move inward and upward with the general movement of the eye, but to tilt with its upper end inward, and the farther the eye were to turn inward the more would the originally vertical line lean toward the median line of the face.

On the other hand, were the eye to be turned outward more than

30° and upward (action of the externus and superior), this white line would lean with the upper end outward more and more as the eye would be directed more and more outward.

Again, should the internal and the inferior recti act together, rotating the eye inward and downward, the vertical line upon the cornea would lean with its upper end toward the temple; but should the eye be drawn by the combined action of the externus more than 30° and by the inferior rectus, the line would lean with its summit nasalward.

The diagrams here seen will illustrate the position of the vertical corneal line under these various circumstances:—



Fig. 32.—Position of Vertical Meridian of the Cornea with Different Directions of the Eye.

A moment's consideration will show that this revolving upon the antero-posterior axis is the result of the peculiar direction of the traction of the superior and inferior rectus, and not of any complication arising from the action of the lateral muscles, except that by the action of these the vertically acting muscles are caused to exercise their force at different angles with the optic axis.

The normal wheel-like revolutions to which the eye is subjected about the axis of the eye under the influence of contractions of the muscles, are called by Helmholtz and other physiologists torsions; and to this subject we shall return after we have considered the next pair of muscles, the obliques.

Much mystery has been thrown about the subject of the action of these oblique muscles, and some misleading assumptions have led to errors respecting their actions and their defects, and thus it has happened that many phenomena arising from the action of the recti muscles, if not understood by the inquirer, have without hesitation and even without inquiry been assigned to the action of the oblique muscles. From what we have already seen respecting the four recti muscles, their action is not so simple as would be the case were all four to act

in line with the line of regard. These variations from the direct and uniform action against a fixed point have led to a somewhat popular impression that for all such variations the oblique muscles must be responsible. The peculiar course and origin of this pair of muscles have encouraged such errors. Listing, Donders, Helmholtz, and others have placed this subject clearly before us, yet, owing to its apparent difficulties, misunderstandings still often arise.

As the two lateral muscles act through a common plane, one

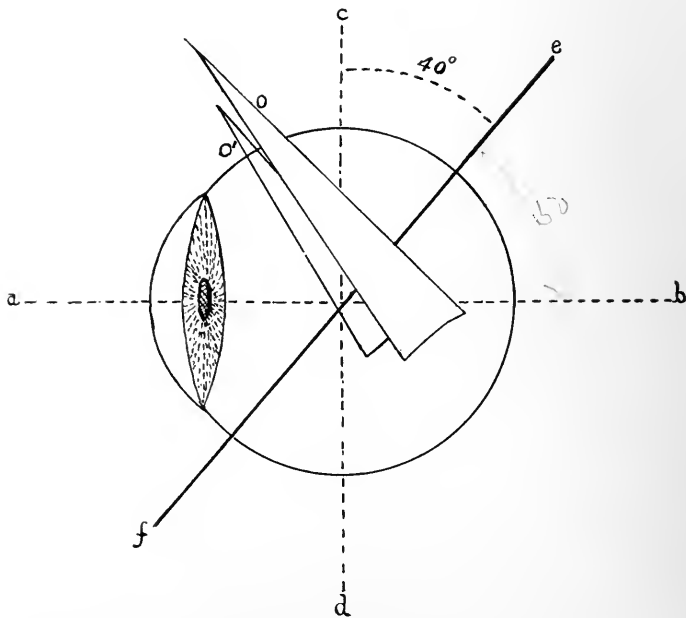

Fig. 33.—Direction of Traction of the Superior and Inferior Oblique Muscles with the Axis of Rotation. *a, b*, Optic axis. *c, d*, Horizontal axis. *e, f*, Axis of Rotation of Obliques. *o*, Superior oblique. *o'*, Inferior oblique.

being directly antagonistic to the other, and as also a common plane would cut the course of action of the rectus superior and inferior, so also have the two oblique muscles approximately a common plane of action, and, like the other pairs, they are mutually nearly antagonistic. Their axis of rotation is, like that of the superior and inferior rectus, horizontal (or nearly so), and this axis forms with the line of regard, according to Reute, an angle of about 35° ; according to Volkmann about 39° , and according to Mauthner about 40° .

It is sometimes stated that, acting together against the center of rotation, these two muscles would rotate the eye inward; but that singly the action changes. It may be questioned whether the first part of the statement is correct; this combined action, however, sometimes forces the eye forward. By the position of its axis of rotation each muscle singly swings the anterior pole of the axis of the eye outward. The contraction of the superior oblique (head and eye in primary position) causes the anterior pole to describe a curve downward and outward, while by the contraction of the inferior oblique a curve upward and outward is described. Neither the lateral nor vertical movement resulting from these contractions is great, yet in practice it is of sufficient account to demand attention. The most notable result, however, of the action of this pair of muscles is the rolling of the eye upon its antero-posterior axis. In this respect the action is similar to that of the superior and inferior recti, but more pronounced. The action of the superior rectus draws the eye upward and inward, and tilts the upper end of the vertical meridian of the cornea inward. The superior oblique, acting singly, turns the eye downward and outward, and gives to the vertical corneal meridian a turning of its upper end, also inward.

The action of the inferior rectus depresses the eye, turns it toward the medial line and causes the vertical meridian to lean outward. The inferior oblique lifts the eye, rotates it slightly outward, and causes the upper end of the vertical meridian to lean outward.

As in the case of the rectus superior and inferior, the effect of the action of this pair also varies according to the position of the line of regard with respect to the primary position. In proportion as the line of regard is carried to the temporal side, their influence becomes less upon the rotation laterally and vertically, while the torsion becomes greater. On the other hand, in proportion as the line of regard is transferred to the medial side, the influence of these muscles becomes greater in vertical movements in proportion to the degree of turning inward, while the torsion is proportionately reduced.

RESUMÉ OF MOVEMENTS OF EACH EYE SINGLY.

Starting from the primary position, if the movement were to be executed by a single muscle acting alone, always assuming a typical insertion of the muscles, the resulting rotations would be such as are indicated in the following table:—

Muscle	Direction of Rotation
Internal rectus	Directly to nasal side.
External rectus	Directly to temporal side.
Superior rectus	{ Upward and inward with rotation of the upper end of the vertical meridian of the cornea to the nasal side.
Inferior rectus	{ Downward and inward with rotation of the vertical meridian of the cornea to the temporal side.
Superior oblique	{ Downward and outward with rotation of the vertical meridian to the nasal side.
Inferior oblique	{ Upward and outward with rotation of the vertical meridian to temporal side.

But if we analyze the various movements which can be made by an eye with respect to the muscles required in the execution of these movements, we find the results in the following table:—

1.—*Straight Movements.*

Direction	Muscles
To nasal side	Internal rectus.
To temporal side	External rectus.
Upward	Superior rectus and inferior oblique.
Downward	Inferior rectus and superior oblique

2.—*Oblique Movements.*

Direction	Muscles
Upward and to nasal side	{ Superior rectus, internal rectus and inferior oblique.
Upward and to temporal side	{ Superior rectus, external rectus and inferior oblique.
Downward and to nasal side	{ Inferior rectus, internal rectus and superior oblique.
Downward and to temporal side	{ Inferior rectus, external rectus and superior oblique.

ASSOCIATED MOVEMENTS OF THE EYES.

Having seen what are the effects of the various muscles and pairs upon the movements of the eyes singly, it is necessary to inquire into the relative movements by the associated actions of the muscles of the two eyes.

Slight consideration will suggest that in respect to single pairs there may be a loss of conformity of action when the two eyes are moved both to the same side of the median plane. A critical study will show the reasons for this absence of conformity, and will indicate the reasons for such nonconformity when corresponding pairs only, or when two corresponding pairs only act together.

Beginning with the internal and external recti of the two eyes, we find the exceptional instance in which the associated movements of the two eyes are, when the ideal conditions exist, in a straight line. Thus, if the internus of the right eye and the externus of the left contract simultaneously, the eyes are rotated to the left and the plane of regard will remain in the same horizontal plane. The simultaneous action of the other left internus and right externus will induce corresponding rotation in the same horizontal plane to the right. This results from the fact that the plane of muscle traction of each pair is also the horizontal plane of the eye from before backward and the action is around a perfectly vertical axis. With these side movements arising from the action of the lateral recti no changes in the relative position of the meridians of the eyes are effected; thus, the vertical meridian of the primary position remains vertical in the secondary position. A study of the actual insertions of this pair of muscles shows that there are many exceptions to this ideal adjustment.

When next we come to the combined action of the superior or of the inferior recti of the two eyes, the results are different for the reason that the plane of the muscle traction of each pair does not correspond with the vertical plane of the eye.

If the two superior recti act together, they will draw the two eyes upward, but not in vertical or parallel lines, for the more the plane of regard is elevated the more will the visual lines approach each other. On the other hand, if the plane of regard is depressed by the associated action of the two inferior recti the direction of movements will not be vertically downward, but downward and inward; and again, the more the gaze is depressed, the more will the visual lines approach.

But not only will the movements of the two eyes in raising and depressing the plane of regard induce a change from parallelism to convergence, the meridians will undergo a partial revolution (torsion) in such manner that when the plane of regard is raised by the action of these two muscles only the upper extremities of the vertical meridian will roll toward each other, while in depressing the gaze these extremities will roll away from each other.

Passing to the third and last pairs, the obliques, by the contraction of the superior pair the visual lines would be depressed and caused to diverge, while the upper extremities of the vertical meridians would also be wheeled strongly toward each other. By the associated action of the other, the inferior pair, the visual lines would be raised and made divergent, and the superior extremities of the vertical meridians would roll away from each other.

Having traced the movements of the eyes under the circumstances of being acted upon by single pairs of muscles acting in corresponding directions upon each other, we may next examine the combined action of two pairs acting upon each of the two eyes.

Taking the combined workings of the principal lateral rotators, the internal and external recti, and the principal vertical rotators, the superior and inferior recti, the combined action which will raise the plane of regard and at the same time turn the gaze to one side will be unlike for the two eyes. For, as the plane of regard is raised and the axis of each eye is turned toward one side, the lateral action of the superior rectus of the eye turning nasalward is increased, and its elevating action is decreased, the first in proportion to the rotation inward, the last in proportion to the angle of elevation of the eye. On the other hand, the eye which turns temporalward is restrained in its lateral movement by the superior rectus, while its vertical movement is increased as it turns outward. Thus it follows that were those two pairs of muscles working in this direction without the coöperation of a third pair, the visual line of the eye directed temporalward would be raised above the visual line of the eye turned medianward and double vision at the side would result, with vertical and crossed diplopia. In like manner diplopia would follow the turning of the eyes downward and sideways, for the action of the inferior rectus would increase the lateral movement of the inward rotating eye, while it would impede that of the outward turning one. The depressing action of the inferior recti would also be decreased for the first and increased for the other, and as before double vision would

result. In each case also, whether in depression or elevation of the line of regard with side turning, the vertical meridians of the two eyes would be subjected to tiltings of different extents.

Combined for the two eyes the action of the recti superior or inferior with either of the oblique the results are somewhat different. Examining first the superior recti and the superior obliques, the first elevators, the other depressors, the elevating power of the first would be in some measure neutralized by the second, and the lateral influence more completely; while by a simultaneous action unregulated by other muscles the medial torsion of the eyes would be exaggerated. The superior recti and inferior oblique acting together would raise the eyes, the lines of elevation being parallel, and no torsion occurring. So also by the combined action of the superior recti and the superior oblique will the eyes be depressed without torsion and without convergence.

From this analysis of the workings of separate muscles and of different pairs we are prepared to examine the movements when all the muscles are considered.

The lateral movements to either side require, as has already been shown, only the exercise of the force of the lateral muscles and the eyes pass from the primary to the secondary position in the same horizontal plane without any leaning of the vertical meridians (torsions). In case of irregular insertions and unfavorable adjustments of the axes the auxiliary influence of other muscles may be demanded.

In all other associated movements more than a single pair is called into requisition.

In the field of regard (that field through which the line of regard may be drawn by the action of the various muscles) the line of regard may be displaced, not only directly in the horizontal plane (lateral displacement) and above and below (ascensional displacement), but these lateral and ascensional displacements may be combined in all directions within the field of regard, passing from the primary position to any other position.

These displacements have been recognized as of five sorts, which are: the lateral, the upward, the downward, the converging, and the rolling or wheel-like movements. These definite forms, however, are so combined that, as stated in the last paragraph, the displacements are in all directions.

SECTION XIV.

SOME OF THE PHENOMENA, CAUSES AND LAWS OF TORSIONS OF THE EYES.

In this section some of the principles set forth in the preceding one will be restated in order to bring them directly in relation with the subject in hand. This is the more excusable since there are many and serious difficulties in the way of a complete mastery of the abstruse problems presented by the torsions of the eyes in their various associated movements. Referring to one of the accepted laws upon this subject, Mauthner says: "Simple as is this law and easy as it sounds, it is certain that no one comprehends it on first hearing it."¹ The distinguished writer might have made his declaration much stronger and yet have been within the limits of truth. Indeed, so confusing are the elements of this subject that in the enunciation of one of its most important laws, a law to which he had brought great research, one of the greatest of authorities himself fell into error in its statement.

No apology is therefore necessary for such repetitions as may be required in order to arrange the principles bearing upon the subject in their order and in direct connection with its parts.

About a fixed point, the center of rotation, one pair of muscles, the lateral, rotates the eye on a vertical axis which always remains vertical when the rotations are induced by these muscles only whether the line of regard passes toward the temple or toward the nasal side. From the action of these muscles alone therefore there is no wheel-like rotation or torsion in any position of the eye.

Another pair, the vertically acting muscles, each rotates the eye upon a horizontal axis which points to the temporal side and backward and to the nasal side and forward. From the primary position the action of the superior rectus is to elevate the eye, turn it to the nasal side, and rotate it upon the optic axis, causing the horizontal meridian of the eye to tilt upward at the temporal end. The action of the inferior rectus from the same position depresses the eye, turns it to the nasal side, and induces a rotation on the optic axis which tilts the temporal end of the horizontal meridian of the eye downward.

¹ "Augenmuskel Lähmungen," p. 519.

The pair of oblique muscles, unlike the recti muscles, which act from a fixed point behind the eye, have their fixed points of traction in front of the equator. They rotate the eye upon an axis which is nearly horizontal and points forward and somewhat to the temporal side. The superior oblique, in the primary position, rotates the eye somewhat outward and downward, but principally turns it on its optic axis, causing the horizontal meridian to tilt with its temporal end upward. The inferior oblique rotates the eye outward and upward and causes the horizontal meridian to tilt with its temporal end downward.

The line of regard leaving the primary position in the horizontal plane causes no change in the action of the lateral recti, but materially modifies the action of all the other muscles.

The superior and inferior recti act more and more as simple elevator and depressor as the eye is directed outward from the primary position to the extent of 30° , when they act directly on a horizontal axis at a right angle to the course of the muscles. There is, therefore, at this point no adduction or rotation on the optic axis. Beyond this, as the line of regard is directed toward the temple, these muscles increase the outward rotation, acting as abductors, and rotate it on its optic axis. If the line of regard is turned toward the median line the action of these muscles becomes gradually more influential in turning the eye toward the nose, and the torsion effect increases until at a supposed turning in of 60° their action is only in rolling the eye upon the optic axis.

The action of the two obliques from the primary position if combined may force the eye somewhat forward. Singly each gives to the eye an outward movement, the superior a downward, and the inferior an upward movement, and each rolls it on the optic axis. This latter rotation is almost the only result of the action of these muscles when the line of regard is directed medianward about 35° . As the line of regard is directed outward the torsion from these muscles decreases.

The turning of the eye upon its own antero-posterior axis by the direction of the traction of the superior and inferior recti and the oblique muscles as they are above described, are called torsions.¹ All

¹ Helmholtz says that the rotation of the eye about the visual line should be called *Raddrehung*, wheel-movement, since the iris by it rotates as a wheel. In the French edition of his great work on "Physiological Optics" the word *torsion* is employed, and this among English and French-speaking authors is the term which has come into universal use. That the term,

these torsions are governed by fixed laws which would be invariable were all the factors in a given movement of the eye to remain uniform. In this work torsions which tilt the upper end of the vertical meridian to the nasal side (and elevate the external part of the horizontal meridian) are called negative. Those which tilt the upper end of the vertical meridian outward (and the outer part of the horizontal meridian down) are positive.¹

These torsions should not be associated in the mind with the conditions called declinations, to be described in another section, as they are in no way related.

We are now in position to discuss the movements of the eye by the combined action of two or more muscles when the eye is rotated above or below the primary plane.

If the line of regard is carried directly upward the act is not effected by the superior rectus alone. This muscle may act independently, but in that case, as shown above, the line of regard would be led up, but also inward, and the horizontal meridian external to the center of rotation would tilt up. In other words there would be, with the upward and inward movement, negative torsion. The consciousness may take no note of the inward movement or of the torsion, but if the movement is to be directly upward and no torsion is to occur, the action of the superior rectus must be supplemented by that of the inferior oblique. There is no such essential or automatic relation between these two actions that they must be combined, the consciousness of the torsion determining the compensating action and its extent. The auxiliary muscle aids in elevating the line of regard; it forces it outward, counteracting the inward action of the superior rectus, and induces a positive torsion to compensate for the negative torsion of the superior rectus.

It is easy to see how, in depressing the gaze directly, the same principles must hold, and the two depressor muscles, the inferior rectus and the superior oblique, must act conjointly.

If now, with an upward or downward movement, a side move-

torsion, is open to objection cannot be denied. But since universal custom has sanctioned it I have not thought it wise to replace it by any other. Hering (*Lehr. vom binokular Sehen*, 1868) preferred the term *Rollung*, which does not appear to be an improvement on Helmholtz's term.

¹ Helmholtz ("*Optique Physiologique*," p. 601) calls all torsions to the right positive and to the left negative. In this work, except in the immediate statement of Helmholtz's doctrines, in positive torsions the superior end of the vertical meridian leans toward the temple, and in negative torsions toward the median line.

ment is introduced, a more complicated state arises. In such a movement no less than three muscles will be demanded.

Let the line of regard be carried upward and to the right. Here it will be convenient to consider the elements of movement of both eyes. In this way we will not only arrive at the elements influencing one eye when directed upward and outward and of one directed upward and inward, but also the associated influence for blending the images of the two eyes may be at the same time observed.

In carrying the gaze thus upward and to the right, the right eye is thereby rotated outward and the left inward. Let it be assumed that the line of regard is brought to its position by the action of the external rectus and the superior rectus. Through the influence of the first a lateral movement only is imparted. Through that of the second the eye is raised, but by reason of the tendency of this muscle to draw the eye inward as well as upward, the action of the external rectus is in some measure neutralized. The superior rectus also wheels the eye in negative torsion, forcing the vertical meridian to lean inward.

The influence for inward rotation and that for torsion from the action of this superior rectus diminish in proportion to the extent of the outward rotation.

Turning our attention now to the left eye, we find that the line of regard is directed inward by the internus without any modification of the direction of the vertical meridian, and that this line of regard is also elevated by means of the action of the superior rectus, which, now that the line of regard is directed inward, also acts in the lateral direction, assisting in the inward turning of the eye. In proportion to the extent of the inward direction of the line of regard, the influence of the superior becomes more marked as an adductor, while its power for raising the line of regard diminishes. The elevator muscle also causes the vertical meridian to lean inward in negative torsion, an effect which increases in proportion to the rotation inward.

If, now, it is assumed that the influence in the lateral direction of the externus of the right eye and of the internus of the left eye are equal, and that the elevating influence of the two superior recti are, from the primary position, equal, there has been induced a relation of the two eyes which must result in confusion and diplopia. For if the outward turning of the line of regard of the right eye is compared with the inward turning of the line for the left eye, it will be seen that the outward turning of the right has been hindered by the action

of the superior, while the inward direction of the line of regard of the left eye has been assisted by the superior. The right eye has been elevated more than the left, for the superior rectus has become more completely an elevator as the eye has rotated outward, while the left superior rectus has become less an elevator as the eye has rotated inward. Hence the left eye has outstripped its fellow in its lateral movement, but has fallen behind it in the vertical movement, which would induce homonomous diplopia, with one image above the other. It is also seen that each of the vertical meridians tilts in, the right more than the other, a condition which would cause the images seen by the two eyes to tilt away from each other at the top. It requires no long consideration to perceive that such a state of the vision of the two eyes would be intolerable.

By the action of a third pair of muscles, the obliques, the rotations are so regulated and compensated that single vision is made possible. In many if not in all such complicated movements it is probable that still other muscles lend their aid in bringing about the adjustment. The compensating and equalizing actions above mentioned are not automatic, performed as though by interlocked machinery. The neutralizing action of the obliques is directed and graduated by the will. It is true that the inherited consciousness of the relative actions of the different muscles renders the will effort easy and rapid, but it is no less an independent action.

After this analysis of the muscular actions involved in looking up and out, it will be easy to form a similar analysis of the elements of a downward and outward direction of the gaze. It is unnecessary to enter upon the details, since the principles and facts already shown can be readily applied.

Having considered the primary and compensating forces which influence the line of regard in parallel directions, let us next consider the elements that enter into convergence with depression of the lines of regard. The position of the eyes in reading is an important one and at some times is a long-continued position.

In this position of the lines of regard they may be supposed to be directed, each, downward and inward. Under these circumstances the inferior recti not only act the part of depressors and of auxiliaries to the internal recti as convergers, they also tilt the superior part of the vertical diameter of the eye outward, inducing positive torsion, and the greater the convergence with a given degree of depression,

and the greater the depression with a given extent of convergence, the more considerable is the torsion.

When we come to discuss the Law of Listing we shall find that in the interest of clear vision a certain amount of tilting out of the meridians is necessary when the gaze is thus directed. But as a result of the action of the two muscles already mentioned, this tilting may be in excess or insufficient. In either case a compensating action is demanded of the superior obliques, and this is an entirely independent action governed by the will. Should the obliques be thus called on, they also act to restrain the converging action of the interni, while they supplement the depressing action of the inferior recti.

As a matter of fact these three pairs act together so nearly automatically that the agency of the obliques in restraining the convergence, in supplementing the depression, and in modifying the tilting, are all very nearly proportioned to the demands of the situation.

If the lines of regard were to be converged and depressed while each line should be directed through the tube of an instrument arranged on the principle of the clinoscope, there would, under these circumstances, be found marked positive torsion for each eye.¹

Thus far we have mainly considered the torsions induced by individual muscles acting in the planes of their traction, with the compensating action of supplemental muscles when the eye is directed in various ways. We have now to consider another class of more or less oblique positions of the horizontal meridians which have been known as torsions, but which differ essentially from those which have been already described. They are due to the combined action of two or more muscles of the eye when the gaze is directed in different parts of the field of regard.

Torsions of the former class depend upon the direction of the insertion of the tendon upon the eyeball and the absence of accordance between the plane of traction of the individual muscle and the line of the optic axis. In the so-called torsions about to be discussed, there is no rotation of the cornea about the optic axis, although the horizontal meridian of the cornea rotates from the true horizon.

If we are to use the same term to describe the two classes of phenomena, we should at least limit the term in the present class by calling them torsions of orientation. In the first class the torsion is in-

¹ A normal negative declination might to some extent neutralize the torsion, but, as above remarked, all anomalies are supposed to be eliminated from the present discussion.

duced by a force acting on the globe obliquely to the optic axis and rotating the eye around that axis. In the case of the torsions of orientation, or what might be better termed *plagiotropia*,¹ the pole of the globe is urged by forces acting nearly at right angles to each other, and the yielding of the pole to these forces is in the same manner in which the pole of any globe would respond to similarly acting forces. The line of regard, yielding to the action of the two forces combined, is directed to its new position as it would be were a single force applied in a direction between these two and parallel with the optic axis, at an angle depending upon the comparative influence of the two actual forces. In a movement induced by a supposed muscle thus placed, the eye would change direction more or less obliquely in connection with, but not around, the optic axis. If this principle could be well understood it would relieve the subject of the tiltings of the meridians induced by oblique movements of the eyes of many of the technical difficulties which have been associated with the subject.

Listing expressed the change of direction of the axis of rotation in the well-known and much discussed proposition known as *Listing's Law*. It is as follows²:—

“When the line of regard passes from the primary position to any other position, the angle of the torsion of the eye is the same as though the eye had come to this position by turning upon a fixed axis, perpendicular to the first and second position of the line of regard.”

In this law no account is taken of the real torsions which may be induced by individual muscles and we, following this precedent, may formulate the law in three sections thus:—

I. When the line of regard passes from the primary position to any oblique position the meridian which corresponds to the plane of movement of the line of regard remains unchanged in its relation to the horizon, while every other meridian changes this relation.

II. The horizontal meridian occupies the plane to which it would come if the eye had rotated upon an axis passing through the equator and the center of rotation of the globe and at right angles to the line of regard in its second position.

III. When the signs³ of the lateral and ascensional angles are the

¹ *ηλαγίος*, slanting; *τροπος*, a turn.

² Listing's Law appeared first in Reute's *Lehrbuch der Ophthalmologie*, 1853.

³ In this work the turning of the line of regard to the temporal side or upward is regarded as positive, while the turning of the line of regard of either eye to the medial side or downward is negative. The tilting of the vertical

same for either eye, the leaning of the horizontal plane is negative. When the signs of the ascensional and lateral angles are unlike for the two eyes, the leaning of the horizontal plane is positive.

These slopings or tiltings, these plagiotropic movements of the meridians resulting from orientation, are not then, it may be repeated, true torsions. The term torsion has been employed here, but the term in this connection should be regarded as plagiotropia only. It is to be remembered that they are meridional tiltings plainly separated from the torsions arising from the oblique actions of different individual muscles.

Bearing in mind the influence which a single muscle acting parallel to the optic axis and placed at any angle in which an oblique movement of the eye is to be made, it will not be difficult to understand in what direction the vertical meridian would tilt with any given oblique movement.

Donders sums up the principle in the words: "*To a determined position of the line of regard there responds a determined and invariable value of the angle of torsion*" (meridional tilting or plagiotropia).

Helmholtz has formulated the principle of meridional tiltings in a law which is easy to remember. He applies the sign "positive" to the angle up and to that to the right. "Negative" he applies to the angle down or to the left. The sign for the tilting is positive to the right, negative to the left. Bearing this meaning of the terms in mind, the law is plain, and its correctness or incorrectness can be easily verified by placing a rubber ball with the vertical meridian marked in ink in a fixed ring and moving the ball in the different directions. Careful experiments will show that the law is not correctly stated.

The law as stated by Helmholtz is as follows:—

"When the ascensional and lateral angles are both of the same sign the torsion is negative, if they are of contrary signs the torsion is positive."¹

The real facts resulting from this principle are, stating them in the terms positive and negative as used by Helmholtz and not as used in this work:—

1. Right eye, line of regard directed upward and to the right (ascensional angle +, lateral angle +), torsion to the right +.

meridian toward the temple is positive, toward the medial plane negative. Hence the tilting of the temporal part of the horizontal plane down is positive.

¹"Optique Physiologique," p. 603.

2. Left eye, line of regard directed upward and to the right (ascensional angle $+$, lateral angle $+$), torsion to the right $+$.

3. Right eye, line of regard directed downward and to the right (ascensional angle $-$, lateral angle $+$), torsion to the left $-$.

4. Left eye, line of regard directed downward and to the right (ascensional angle $-$, lateral angle $+$), torsion to the left $-$.

Comparing now these facts with the law as announced by Helmholtz, we find that there is a radical difference; for while the law declares that with like signs the sign of torsion is negative, the facts show that with like signs the torsion is positive, and with unlike signs the torsion is negative.



Fig. 34



Fig. 35

Stevens's Ophthalmotrope.

The disagreement between the facts and the rule might be accounted for on the theory of a misprint did not the context forbid this view. Others have discovered this error,¹ but the explanations to prove the error have been sometimes worse than the original error. It is reasonable to suppose that one so familiar with the philosophy of torsion as the great physiologist might very easily substitute for the objective phenomena of torsion the subjective phenomena, as shown by accidental images, of which we are presently to speak. This, it

¹ Le Conte, Mauthner and others.

appears to me, is the explanation of the inconsistency of the law with the objective phenomena. It would be an error extremely easy to make without implying any false view on the part of the master.

We may therefore write Helmholtz's law thus: *When the ascensional and the lateral angles are both of the same sign, the torsion is positive; if they are of contrary signs the torsion is negative.*

For illustrating the positions of the meridians in the different adjustments of the eyes I have devised the model or ophthalmotrope, on the principle of that of Reute, shown in Figs. 34 and 35. A glance at Fig. 34 shows the eye in the primary position with the horizontal meridian exactly horizontal and the vertical meridian precisely vertical. As the eye rotates up and to one side (Fig. 35) it is seen that the curve of the horizontal meridian strikes the border of the cornea at the right about 2 millimeters above the point at which it cuts the border at the left. Also, the point at which the vertical meridian cuts the border of the cornea above is about 2 millimeters to the left of the point where it meets the border below.

Thus it will be seen that, if we regard the model as representing the left eye, a turning up (+) and to the right (+), the torsion (plagiotropia) is to the right (+). Or, if we regard the model as representing the right eye, we have unlike signs with plagiotropia to the left (—). Thus the law as announced by Helmholtz should be restated, as I have shown above.

ACCIDENTAL IMAGES.

Having thus traced the workings of the various muscles in turning the eye upon its center of rotation while the lines of regard of the two eyes are parallel, and having observed the objective effects of these workings upon the relative positions of the eyes, we may next turn our attention to some subjective phenomena which illustrate and confirm the facts already stated.

For this purpose we may avail ourselves of the study of accidental images—a method of investigation introduced by Reute.¹ Such images are the result of the principle that after a strong impression has for a considerable time been presented to the same portion of the retina, that part of the retina becomes dulled in its sensibility to that particular impression.

For example, if one looks at a white spot on a dark background

¹“Das Ophthalmotrop.” Göttingen, 1845.

for some time, and then turns the eyes away to look at some neutral surface, there will appear a dark spot on the surface, which represents the point in the retina which has become dulled to the extent that it no longer sees the neutral surface uniform, but in the absence of a strong stimulant at that point gives the impression of a point not well illuminated. In the same manner the retina becomes dulled to the sensibility of a particular color which may be presented continuously to it, but in turning the eye away from it the complementary color may appear in its place.

In the experiments with accidental images this last class of phe-

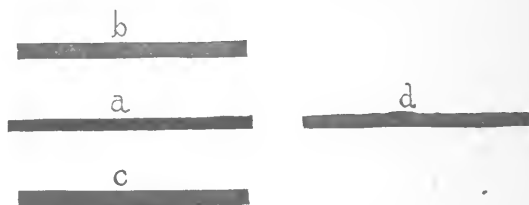

Fig. 36

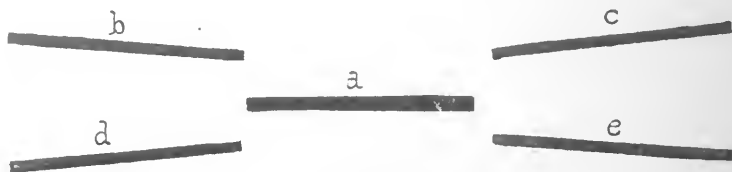

Fig. 37

Positions of Accidental Images. From a Horizontal Line.

nomena is especially available, and for the methodical system of research by its means we are indebted to Donders.¹

Upon the wall of a neutral tint, preferably of a light gray, the observer fastens a strip of red ribbon horizontally and at a level with his eyes. Sitting at a distance of several feet from the wall, and maintaining the primary position, he directs the eyes fixedly at the ribbon and at its center, which may be marked. After half a minute or more the observer will see a light halo all about the ribbon, and he may now remove his gaze to any selected point upon the wall. As

¹ "Holländische Beiträge," Bd. i, 1848, S., 105.

soon as the gaze is fixed he will observe an image in light green of the form and size of the red ribbon.

If in the experiment the gaze has been directed exactly above the band, the greenish band will appear above the red one and exactly parallel to it (b. Fig. 36), so if the gaze is carried downward the accidental image will appear parallel with the original (c. Fig. 36). If the gaze is transferred to a point in the same horizontal plane with the ribbon, but laterally, toward the right or left, the secondary image will be in the same horizontal line with the other (d. Fig. 36).

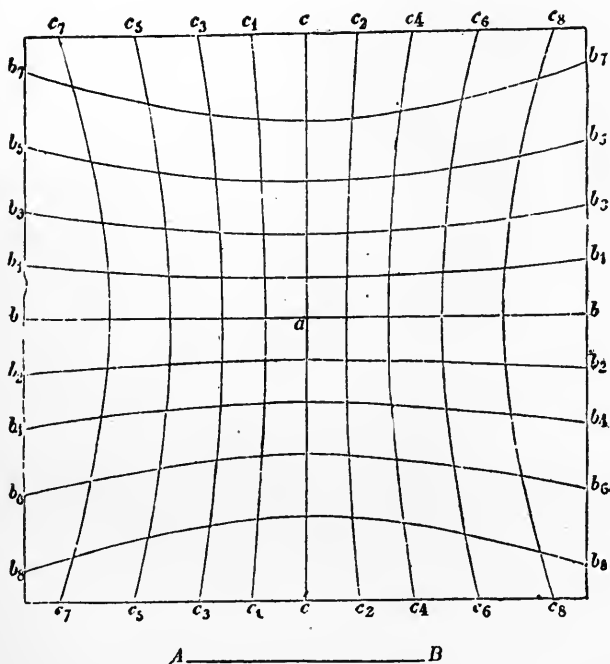

Fig. 38.—Diagram from Helmholtz. These curved lines represent the inclination of the horizontal and vertical images when projected upon a plain wall. If a is the point first fixed, the accidental image, as the regard passes from a to some other point, the position of the accidental image will conform to the direction of the line on which the regard rests.

If, however, the gaze is directed to any other position, the accidental image will no longer form a continuation of the line of the original band nor remain parallel with it. If the regard is carried

above and to one side, or below and to one side, the accidental image will tilt, and this tilting will correspond invariably with the direction of the gaze, so that from the tilting of the accidental image the position of the eyes could be deduced.

Helmholtz suggests a method for exact and somewhat elaborate observations of these images, to which we need here only refer. The results of such observations have been so carefully recorded that tables indicating the value of the angles of torsions have been prepared. We may, without entering into this minute detail, quickly verify the general results.

If we look first at the horizontal ribbon and then direct the line of regard upwards and to the right we shall see the accidental image with its right end higher than the left. Or, applying the terms applied to the meridian of the eye, the image tilts to the left, as at c. Fig. 37; but if the gaze is directed upward and to the left the

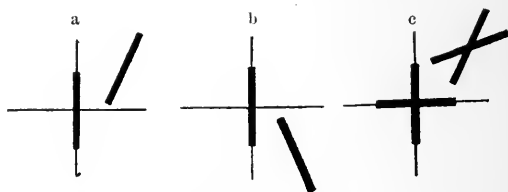

Fig. 39.—Position of Accidental Images from a Vertical Line.

accidental image will appear with its left end higher than the right (b. Fig. 37), that is, the image now tilts to the right. So if the gaze is directed downward and to the right, the accidental image tilts down at the right extremity, as at e; and when the gaze is directed down and to the left, the tilting is as shown at d.

There is a series of effects apparently contrary to those just mentioned if the ribbon is placed vertically. For now, if the regard is carried from the ribbon to the right and upwards, the upper extremity of the accidental image will lean to the right (a. Fig. 39), while if the gaze is directed to the right and downward the image tilts to the left (b. Fig. 39). If the gaze is carried upward and to the left the image tilts to the left; if downward and to the left the tilting is to the right. These apparently contradictory results are forcibly illustrated when a cross composed of a horizontal and vertical ribbon is substituted for the single ribbon, for now if the line of regard is carried from the cross upward and to the right the horizontal limb of the

cross will lean to the left, while the vertical part will lean to the right (c. Fig. 39).

These facts are not, as they at first appear, in contradiction of the first series of observations, but, as Helmholtz has indicated, the apparent incongruity depends upon the fact that the plane of the wall does not coincide with the plane of regard or with a line at right angles to it.

Professor LeConte¹ placed an experimental plane in such a way that the line of sight is at right angles to this plane when the gaze is turned up and out, down and out, etc., and thus obtained results uniform with the laws of torsion in all positions. To obtain correct results it is necessary either that the accidental image be projected upon a surface which will in every case be at right angles to the line of regard, that is, upon the inner surface of a sphere at the center of which the eyes are in position, or that the plane (wall) upon which the observations are made shall be marked with lines which shall represent a series of spherical coördinates, in which case these lines may in the calculations replace the direct horizontal and vertical lines. The diagram (Fig. 38) from Helmholtz shows the inclinations for the horizontal and vertical images for different positions of the line of regard when the secondary image is projected upon a plane, vertical surface, as, for example, the wall of a room.²

The law of accidental images projected upon a spherical surface then may be formulated thus:—

When the line of regard is elevated and directed to the right the accidental image tilts to the left. When directed to the left, the image tilts to the right.

When the line of regard is depressed and directed to the right, the accidental image tilts to the right; when directed to the left, the image tilts to the left.

Hence, using the terms positive and negative as they are employed in this work—positive indicating the temporal, negative the medial side—and again positive indicating above and negative below, the law of accidental images may be stated thus:—

When the ascensional and lateral signs are alike for either eye, the sign of the accidental image for that eye is negative; when the

¹ Le Conte: "Sight," p. 173.

² Dr. Karl Grossman, Liverpool, using a transparent perimeter band, concludes that no rotation occurs about the optic axis. This is the conclusion which I have above expressed at page 111.

ascensional and lateral signs differ for either eye, the sign of the accidental image for that eye is positive.

Thus it will be seen that there exists an actual conformity between the objective torsions of the eye on its optic axis and the directions of the secondary images when projected upon a surface the parts of which are at right angles to the line of regard, for, since the lines of sight cross at the nodal point, the tilting of the accidental image to the left indicates an actual tilting of the cornea to the right. This important principle seems to have been lost sight of in the discussions of the subject.

We have in the discussion continued to use the word *torsion*, notwithstanding the fact that there is no torsion, in deference to the manner in which the subject has heretofore been treated. It would, as already remarked, be much in the interest of clear thinking and correct understanding of this somewhat difficult subject were the misleading term *torsion* absolutely abandoned for this special class of phenomena and if some other term or phrase were to be substituted.¹

While the law for the inclining of the corneal meridians holds for distant vision when the visual lines for the two eyes are practically parallel, there must be some modifications of the phenomena when the visual lines are converged.

The examination of these phenomena is somewhat more difficult than those just considered for an observer who has not been carefully and patiently trained in this class of observation. When, as it happens in experiments in this field of research, the retinal impressions are such as to contradict our ordinary experiences, both the mental and physical powers are brought to bear to annul the supposed false impression. Thus it may happen that accidental images formed for the two eyes which do not normally coincide within several degrees may appear to an observer to be absolutely coincident because the divergence is mentally suppressed.

The inclinations of the corneal meridians, the actual torsions or plagiotropic inclinations in convergence will, of course, vary according to the ascensional angle and the distance of the point of convergence.

If we take as the first position of convergence one in which there is no ascensional angle, that is, one in which convergence is made in the primary plane, there will, in perfectly adjusted eyes, be no in-

¹ See page 112, where the term *plagiotropia* is suggested.

clination of the corneal meridian,¹ that is, no torsion of either eye. In this plane convergence for any distance demands only the action of the laterally acting muscles and no inclination of the meridian results from their action. But if the plane of regard is depressed the adjustments for both eyes will be relatively symmetrical, that for the left eye being the same as when in parallel vision the line of regard is downward and to the right. Referring to our law it will be seen that in that case the angle of ascension for the left eye was negative, as was (according to our use of the terms) the lateral angle. This would result in a positive torsion for that eye. In convergence with depression of the line of regard the torsion would be uniform and positive for both eyes.

For the purpose of this examination the newer model of the clinoscope, with shorter tubes than the original model, which may be converged at fifteen inches from the eyes, is serviceable. The tubes can be depressed at any angle below the horizon, and the objective may remain vertical. By means of this instrument it is easy to show that in convergence with depression of the line of regard there is a positive or outward leaning of the vertical meridian of each cornea, and that the leaning corresponds with the demands of Listing's Law. On the other hand it appears that when the plane of regard is elevated above the primary plane with convergence, the vertical meridians lean toward the median plane.

By mathematical calculation the extent of the leaning of the vertical meridians may be determined. On the next page is found a table from Helmholtz² indicating the value of the torsion at different degrees of the ascensional and lateral angles. The table indicates the torsion for a single eye.

It is to be remarked that in experiments upon the leaning of the vertical meridians in convergence the ordinary stereoscope is of little practical use except it be in showing to what proximal extent corrections through voluntary torsional action may be made in the interest of binocular vision. Nor is the effort which expert persons are able

¹This statement is not in accord with that of Helmholtz, that in the primary position the eyes roll out $1^{\circ} 15'$ each. Nor of Le Conte ("Sight," p. 203), that the "two eyes in convergence roll out," to show which he introduces diagrams and experiments. Only in cases of some anomaly of adjustment do these rollings out occur in the primary position. These observers have mistaken their own peculiarities of adjustment for the typical adjustment of the eyes.

²"Optique Physiologique," p. 607.

Table Indicating the Extent of Torsions.

Lateral Angle	ASCENSIONAL ANGLE							
	5°	10°	15°	20°	25°	30°	35°	40°
5°	0° 13'	0° 26'	0° 40'	0° 53'	1° 7'	1° 20'	1° 35'	1° 49'
10°	0° 26'	0° 53'	1° 19'	1° 46'	2° 13'	2° 41'	3° 11'	3° 39'
15°	0° 40'	1° 19'	1° 59'	2° 40'	3° 21'	4° 2'	4° 45'	5° 29'
20°	0° 53'	1° 46'	2° 40'	3° 31'	4° 29'	5° 25'	6° 22'	7° 21'
25°	1° 7'	2° 13'	3° 21'	4° 29'	5° 38'	6° 48'	8° 0'	9° 14'
30°	1° 21'	2° 41'	4° 2'	5° 25'	6° 48'	8° 13'	9° 39'	11° 8'
35°	1° 35'	3° 10'	4° 45'	6° 22'	8° 0'	9° 39'	11° 21'	13° 6'
40°	1° 49'	3° 39'	5° 29'	7° 21'	9° 14'	11° 8'	13° 6'	15° 5'

to make to unite stereoscopic images without the aid of the stereoscope more satisfactory.

Notwithstanding the above remark the stereoscopic diagrams on the opposite page may aid in illustrating the directions of the vertical meridians of the eyes when the lines of regard are converged and depressed below the horizon.

If the page of the book is held up so that the diagrams are at right angles to the line of regard in the primary position the lines running horizontally and those running vertically unite perfectly and remain in union without effort indefinitely. But if the book is laid flat upon the table while the head maintains nearly the primary position, the lines do not perfectly coalesce. When they appear to do so the image leans, but the lines waver in and out, standing not parallel, but the vertical ones leaning, those of the right diagram to the left, those of the left diagram to the right; while the horizontal lines cross at the center, those of the right diagram rising above the others at the right, those of the left diagram rising at the left. In a diagram such as this, in which the impulse to fusion is feeble, the presence of an anomalous declination of even a very low degree may induce the leaning. Hence the diagram is much less satisfactory than the use of the clinoscope in which, the lines being properly adjusted for the normal declination, the torsional phenomenon is shown when depression and convergence occurs.

If, with body erect, the head is caused to lean toward one shoulder there will occur a rotation of the eyes on the visual line, but when

this leaning of the head is carried to a considerable extent the eye rotations do not follow in proportion. This can be shown by experiments with accidental images.

In the exposition of the various laws which govern the relative movements of the eyes as they are directed for fixation in different parts of the field of regard they have been stated from the mechanical and technical point of view. It is to be recalled that in the living subject great latitude is to be conceded to the psychologic element in

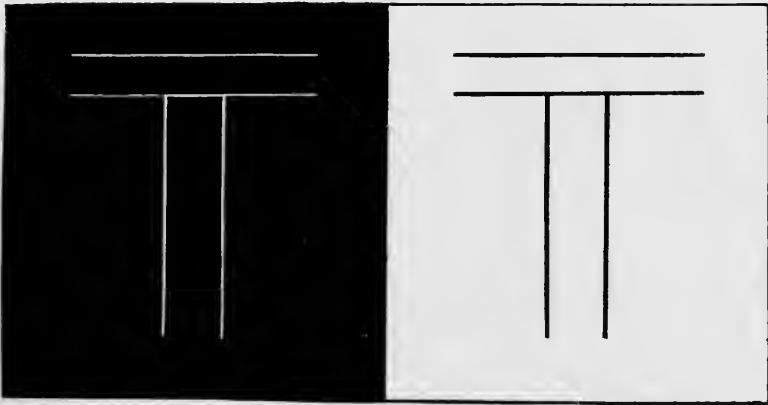

Fig. 40.—Illustration of Correspondence of the Images.

the act of vision. Movements which should be executed according to the laws which have been stated are often neglected, and other movements which are inconsistent with these laws, are often executed. In the first contingency the consciousness of the propriety of a given movement may take the place of the movement itself; in the second a similar consciousness of the movement demanded permits of a variation of the movement, the judgment making due allowance for the departure from the rule.

SECTION XV.

VISUAL PERCEPTION OF SPACE.

Visual perceptions of space, that is, of distance, of form, and of depth, arise from movement impulses rather than from the traditional "picture on the retina." The retina indeed receives from the object seen sensations of color, of light and shade, but the idea of space and of the position and form of objects in space is derived from the muscular impulse which is demanded in moving the eye in such directions as to bring these color points successively upon a single part of the retina, or from the consciousness of the expenditure of force which might be required to execute this movement. There are, indeed, circumstances under which the mind arrives at an estimation of the movement which would be required even when this movement is not executed. The intensity and the extent of a muscular act may be estimated before the movement is executed, and hence in case of instantaneous impressions in which time fails for the actual performance of muscular action, the mental consciousness of the extent of the impulse which the movement would demand is accepted for the movement itself.¹

The point in the retina from which all judgments of direction or distance are calculated is that of clearest vision, the center of the macula. If a given point of an object in space is selected by the mind for fixation by the eye, there is at once set in motion a process by which the macula is brought into line with this selected point.

Wundt² characterizes this process as reflex. But instantaneous though it is, and, so far as we can determine, possibly without the various stages of logical purpose, it would seem to be extending the meaning of the term reflex beyond its legitimate definition to accept it in this connection. That it is a subliminal phenomenon is certain, but of its reflex nature there is a reasonable doubt. That the muscles of the eye respond with a rapidity and an accuracy which is amazing, to the purpose of bringing the image of a selected point from a peripheral part of the retina to the macula, and that we cannot trace the stages of mental activity from the desire to see the point to the

¹ Thus, in the experiment of Dove, stereoscopic images appear united when illuminated by an electric spark; giving too little time for any actual adjustment of the eyes for such union to occur.

² "Human and Animal Psychol.," p. 128.

adjustment of the eyes for the reception of its image at the macula is marvelously true. This, however, does not necessarily place the phenomenon within the category of reflex actions, if by such we are to understand a nervous impulse which passes by a short cut, failing to reach the seat of general consciousness there to give origin to a purpose, which purpose is executed under the direction of the will.

If one sees an iron pound weight and takes it in the hand, there is before the act a very close judgment of the muscular impulse required to lift it. So closely is the judgment formed that should the supposed iron weight prove to be an imitation made of pasteboard, the hand would fly upward when the weight was taken and there would result a rather unpleasant muscular disappointment. A like disappointment would follow if the real iron weight should be held down by a concealed magnet. It can hardly be thought that the appearance of the iron weight determines a reflex movement of the muscles of the arm, there must be a mental conception, based upon experience, of the extent and character of the nervous impulse and muscular contraction required for lifting the weight.

Of a like nature, but of infinitely greater delicacy of judgment and rapidity of action, may we suppose the movement of the eye to be for adjusting the image upon the macula.

One of the most important acts in respect to the judgment of form, size, and distance of objects, and the fact which is perhaps least prominent in the minds of those whose attention has not been especially called to it, is that these judgments are largely based upon what is known as the muscular sense. This sense may reside in the muscles themselves or in the nervous centers from which the nerves supplying the muscles originate, or, indeed, in the nerves supplying the parts which are in contact with the muscles.

Helmholtz says that we are to distinguish under the term *muscular consciousness* a number of sensations essentially different.

Thus we may perceive:—

1. *The intensity of the effort of the will* by which we endeavor to cause the muscles to act.

2. *The tension of the muscles*, that is, the force with which these muscles strive to act.

3. *The result of the effort* which, independently of its perceptibility by the other senses, notably by those of sight and touch, are indicated externally by an effective shortening of the muscle which

may manifest itself also by a change of tension in the skin which covers it.¹

To this list of sensations as given by Helmholtz I have elsewhere suggested that there should be added another element which cannot be classed as a sensation. This is *the consciousness of the intensity of the will effort required to accomplish the muscular change*, and which may be formed *before the will impulse has been transmitted to the muscles*.² In other words, an element of the muscular sense is the knowledge gained by experience of the individual, or inherited from the experience of others, of the intensity of the will impulse demanded for the execution of a muscular act.

It will be seen when we come to study the phenomena of strabismus (see page 369) that an eye, the movements of which, by reason of unfavorable adjustments of the organ, have been mentally disregarded, becomes (or remains) practically a blind eye because of the absence of experience of any definite relation between the movements of the eye and the idea of space. If circumstances demand that experimental knowledge of this relation should be established, and a definite understanding is arrived at by which the mind recognizes the value of the eye movements, and the eye learns to act definitely under the guidance of the will, the sense of sight perceptions, even of the most favorable character, may be developed.

This muscular act, as has been stated, owing to the exceeding brevity of the time during which it may be required, may not in fact be executed, yet the mind may accept the judgment of the required impulse in place of the actual sensation of movement.

Ideas, then, of spatial relations of objects in the field of view depend on the muscular sense experienced in bringing different points which lie in the field of view to coincide with the central point of the fovea. If the image of one given point in the field of vision lies more at the periphery of the retina than another, the first point will require a greater change in the position of the eye, that is, more extensive muscular effort to bring the image to the macula than the second whose image is not so far removed from the macula, and hence the first will be seen as further from the original point of regard than the other.

Not only the extent of movement, but the direction of that move-

¹ "Optique Physiologique," p. 762.

² Stevens: "The Horopter." Psychological Review, April, 1904, etc.

ment, enters into the conception of the spatial relation between two points.

The eye does not start from an indifferent point to wander aimlessly over the surface of an object to be viewed, but starting from a selected point it passes, in directing the line of regard, from one selected point to another, until the form of the object has been mentally determined. It does not follow that the line of direct sight must compass in every detail the outline or sweep over the surface of the object. We have already seen that much is left to the processes of unconscious conclusions. These combined movements of the eyes in directing the lines of regard as they sweep over the surface of an object or a landscape, or the mental estimate of the movements required, constitute the basis for the conception of the form and size of the object or the outlines of the landscape.

A considerable number of elaborate experimental researches has recently been undertaken, in Germany, in America and elsewhere, principally in psychological laboratories, with the view of establishing definite facts relating to the fixation of points in the field of vision and to the movements of the eyes in the interest of the space percept. Photographic aid has been brought to the service of these investigations. Interesting as are most of these experiments, the deductions from them are not conclusive, and in all there is the notable absence of certain factors which are fundamental and essential to any final and satisfactory investigation of the facts.

The author of this work has no claim to speak with authority as a psychologist, but certain principles have become so manifestly evident in his own field of investigation that he assumes the liberty to advance some propositions in respect to investigations of visual motor processes, covering only certain intrinsic factors which have been conspicuously absent in these researches and, lacking which, no trustworthy conclusions can be reached.

Only two of the most noteworthy of these neglected factors need be here mentioned:—

1. No reliable results can be attained in the investigation of the facts of the movements of the eyes in space perception by observing the action of eyes, the condition of whose motor functions have not been positively determined. In the reported experiments, one who is expert in respect to the anomalous states of the motor apparatus of the eyes will detect many phenomena which, by the investigators, are regarded as typical, but which are evidently the results of the peculiarities of the adjustments of the eyes of the subject observed, that is, the person making the experiment. To repeat an illustration which I have used elsewhere, as well might a surveyor proceed with his triangulations from an eminence which he has not first located as for an investigator in visual phenomena to assume that the eyes of his intelligent subject represent the typical movements of eyes in general.

2. While psychologists might hardly admit that the element of attention has been absent from their experiments, it is evident to one who is largely

occupied with visual phenomena that there is in most, if not in all, of the experiments recorded a notable absence of any adequate means for fixing the attention.

To illustrate: If a point of light swings in space with a pendulum movement, photographic registration shows that the eye follows it, not in an uninterrupted and regular movement corresponding to that of the point of light, but with little halts and forward movements. From phenomena of this general order some have reasoned that this is the typical mode of motion of the eye in following the outline of an object. This by no means follows. In such a monotonous movement of the object it is unnecessary and somewhat difficult for the eye to maintain an absolute fixation. It is easier to permit the image of the object to pass out of the region of the fovea, the consciousness drawing upon the faculty of estimating its position, then catching up, than to hold the adjusting apparatus in continuous and accurate tension. Were the movements of the point of light more complex, such as could not be assumed beforehand, and to which more continuous and more fixed attention would be demanded, it is safe to believe that the movements of the eyes would be much more in correspondence with those of the object. The principle holds in respect to investigations with certain visual illusions that an impediment to continuous attention to a line of movement may modify the extent of that movement. By practice the attention may be more definitely confined to the object to be examined, and hence not only the movement of the eye, but the percept of space, may conform more nearly to the extent of the object viewed. It is an error to attribute this correction of the mental estimate of space to an overcoming of a mental illusion. It is the result of the ability of the observer to confine his attention to the direct line of extension while he ignores the hindering objects which are external to this main object, refusing to permit the attention to be diverted.

Devices can be prepared which will enable an investigator to be assured that the attention of the subject is continuously fixed upon the desired object. Also, with a complete knowledge of the personal peculiarities attending the movements of the eyes of the person under observation, more exact and more satisfactory investigations can be undertaken than those entered upon with the assumption that the eyes of every intelligent subject must be subject to the laws which would govern in a typical case.

In order, then, to appreciate size by the sense of vision, there must be movement or a mental conception of a movement, and there arises the interesting and practical question, what is the extent of the least movement which can be interpreted into an idea of size and form.

This resolves itself into the question of the space over which the line of regard must move in order to recognize magnitude. And at this extreme side of the question it may be doubted whether the problem does not assume a somewhat different character.

The observations of Hook, Weber, Volkmann, and others have

resulted in an acceptance of the opinion that a visual angle less than from 50 to 75" is too small for visual appreciation, but that a space occupying an angle equal to one of these may, under favorable circumstances, and with a good eye, be perceived as space.

It happens also that two rays of light entering the schematic eye of Listing at an angle of 73" and passing to the retina, would there be separated 0.0052 + millimeter. According to the measurements of Kolliker, the cones at the macula have a diameter of 0.0045 millimeter. Thus it would appear that the smallest movement which can be perceived is about that which would be required to move the ray of light from one cone to another. The question whether, in case the cones were much smaller, a less degree of motion could be interpreted by the idea of space, is of course a purely speculative one.

It was on the basis of an appreciation of space by a movement of the eye through an angle of 60" that Snellen constructed his system of test letters. He assumed, however, that an angle of 5' is the smallest at which characters for reading can be clearly made out by the average eye.

In researches for the determination of the rôle played by the convergence in the perception of distance or depth many experiments have been made, two only of which need here be mentioned. Wundt¹ placed the face before a box open at that side and having a horizontal slit in the other side through which both eyes could look at a white screen, all surrounding objects being shut out from view. A vertical thread kept taut by a weight hung between the slit and the screen. In experimenting to determine to what degree of certainty he could estimate the comparative distance of the thread when it was made to approach or recede, he was careful, whenever the thread was moved, to close the eyes during the movement and when opening them to look first at the screen, then at the thread. Wundt found that, while the degree of accuracy increased with the degree of convergence of the visual lines, on the average he could determine the approximation or the recession of the thread within $\frac{1}{50}$ of the distance. For example, if the thread hung at 50 centimeters from the eyes he could determine the fact that it was nearer when the thread was moved up to 49 centimeters.

Professor Bourdon² has made still more exact experiments. His results do not largely vary from those above mentioned. A con-

¹ Lectures on Human and Animal Psychology, 1894, p. 151.

² La Perception Visuelle de l'Espace, 1902.

vergence of 8' for each eye with the fixed object at 1.08 meters distant was necessary to recognize the fact of the approach or the recession of the very small object. The fact that the nature of the change of adjustment of about one-fourth of a degree between the two visual lines could be almost uniformly detected after an interval of time during which the eyes had been moved in various directions, indicates the extreme delicacy of the sense of movement of the visual apparatus.

It will be seen that the psychical processes in vision result from definite physical actions, and that the character of the perception received in vision is not determined so much by the picture printed on the retina as by the movements of the eyes, although, as above remarked, it does not follow that the line of sight must compass every detail of the figure seen. And we shall see presently that the apparent size, distance, and even color of objects are influenced largely by processes of mind, and that these mental processes differ in character under different circumstances. Conclusions drawn from experiences, contrasts, comparisons of environment, and a variety of psychical processes enter into the final conception upon which the mind settles.

By excluding to too great an extent the influence of these purely psychical elements of vision and confining ourselves to the examination wholly of physical phenomena, we may be misled in regard to many of the facts of vision, especially those relating to binocular vision.

Much time and space have been occupied in the attempt to show why the reversed image imprinted upon the retina should be recognized by the brain as an erect image. After an acceptance of the view that it is less the image seen than the motions felt, it is scarcely necessary to consider the retinal picture, nor would it seem important to show that the multitude of fibers which pass from the elementary bodies of the retina back to the brain substance are not so arranged in this complicated mass of cells as to form a mosaic in the receptive organ. We have no extensive knowledge of the course and destination of these fibers, but it is safe to presume that they find their connections with the brain cells not in any plane or other fixed form of which we have any conception, and that in the brain substance there is no up and down, right or left. And thus it is that the notion of a picture conveyed to the brain where it is "felt" or perceived is an evident hindrance to the study of spatial vision.

It is true that owing to the crossing of the rays in reaching the retina, the eye in following the outline of an object from right to

left must move from right to left and in following it from above downward must also move downward, yet this, in the light of the considerations above advanced, would seem hardly to sustain the assertion that because of the reversal of the image and the consequent movements of the eye symmetrically with the directions of the outline of the object, therefore it is *necessary* that the image should be reversed. An experienced photographer becomes unconscious of the reversal of the image on the ground glass of his camera, and if one were to observe images habitually from infancy in the same manner we have no reason to suppose that the fact would lead to disturbances of the faculty of localization, although, for obvious reasons, it would be attended by inconveniences arising from the resulting positions of the eye in limiting the field of regard.

It has been said above that in obtaining a mental conception of the form of an object in space the eye does not wander aimlessly on its surface; it in fact executes movements which may be compared to those of the hand if it were to pass around the object and thus by the muscular changes resulting in the hand and arm conveying to the mind an idea of the form of the object. Here we may introduce another comparison between the psychical results obtained by the movement of the eyes and those of the hand in feeling the form of an object. If the hand should be passed over two equal surfaces, for example, two squares of wood of equal size, one of which is perfectly smooth while the other is marked by transverse ridges, the smooth surface would appear to the hand, the eyes being closed, less extensive than the ridged surface if the hand pass at right angles with the ridges. In like manner, if the hand were to pass first in the longitudinal direction of the ridges and then in the transverse direction of the same surface, the surface would not seem to be of equal dimensions in the two directions, but of greater extent in the direction across the ridges.

The appreciation of the apparent size of objects by the sense of sight may be modified in much the same way.

The familiar illustration of the two equal squares, one marked by horizontal, the other by vertical lines, will help to impress this fact.

In Fig. 41 the square with the horizontal lines appears notably higher than the square with vertical lines, while the square with vertical lines is apparently broader than the other. In neither case do the squares seem, as they really are, to be equal on all sides.

In the case of the eyes, as in that of the hand, the single effort of sweeping directly from one extreme of the object to the other with-

out a halt or an obstacle in the course of the muscular impulse appears less extended than the effort in which the hand or the eye passes from one side of the object to the other by a series of smaller exertions. It is not that the square makes a larger impression along the horizontal meridian of the retina in one case than in the other, but that repeated small movements appear to be of more consequence than a single muscular sweep of equal extent to the sum of the lesser movements.

Another element in modifying the impression of the extent of an

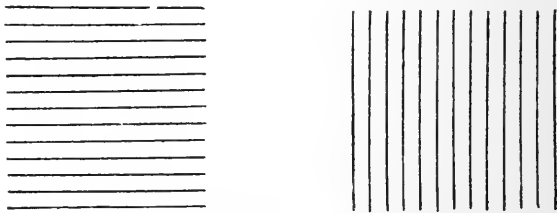

Fig. 41.—Illusion of Height and Breadth.

object is found in the contrast in the muscular sense between an action unimpeded and extended beyond the point of measurement to be determined and an action suddenly brought to a close and turned back upon itself. This is clearly seen in the figure known as the Müller-Lyer illusion (Fig. 42), in which the two parts of the horizontal line are of equal lengths, yet the line from which the short lines diverge



Fig. 42.—The Müller-Lyer Illusion.

in the direction partly continuous with the main line appears materially longer than the line from which the diverging lines turn backward.

In the first case the eye follows along the course of the main line and encountering the diverging lines with no sudden arrest in its course, passes, by a slight modification of direction, along one of the diverging lines. In the opposite case in the movement of the eye the attention is diverted to the retrograde line, and the movement is arrested before the extremity of the long line is reached.

If one should leap a certain distance and then follow the leap with some steps forward, an idea of the distance covered by the leap would result. If the person were now to repeat the leap, encountering an obstacle at the distance of the first leap which would not only prevent further advance but turn him back, the leap in the first instance would seem to have covered a greater extent than the second. Experiments in this direction may be varied in great number, showing that

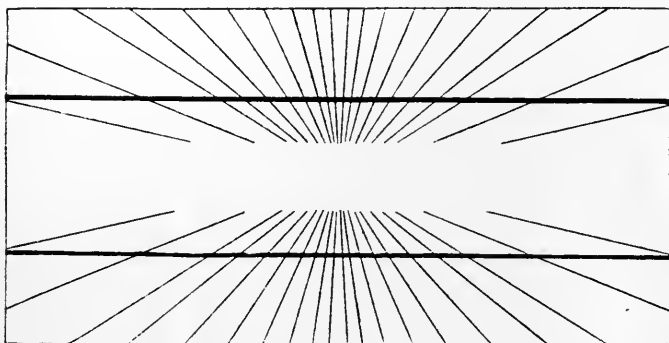

Fig. 43.—After Hering.

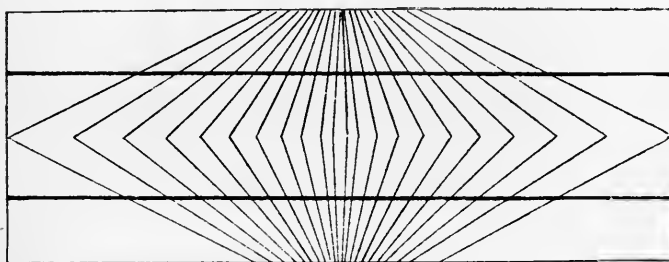

Fig. 44.—After Wundt.

not only the extent but the direction of objects in the field of view may be modified to the consciousness by impressions derived from the environments of the object seen.

In the accompanying two figures a straight line does not appear as a straight line and parallel lines do not appear parallel.

The explanation of the interesting phenomena shown in these diagrams is found in the principle already cited, that if a movement be continued beyond the point of determination the distance appears

greater than if the movement is suddenly arrested and turned back. In case of Fig. 43 the angles on the outer sides of the lines permit the movement to slide without sudden arrest, with the result that that side of the long line appears elongated, and the line also approaches the branching lines, not because the picture on the retina brings the long line in closer relation to the branches, but because in the movements required the two lines forming the acute angles are brought in relation to each other and, as Helmholtz remarks, there is the mental contrast of the angles between the direct and the oblique lines.

The two long lines appear then to approach toward the center

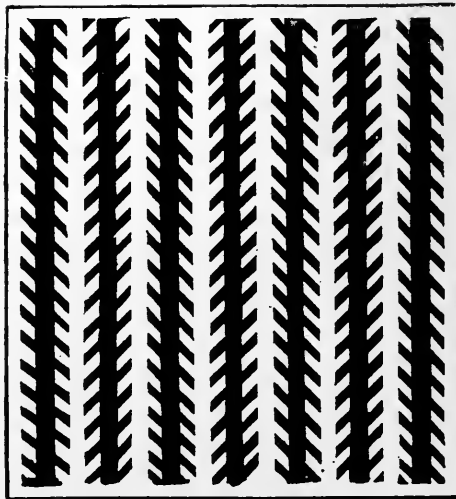

Fig. 45.—Zöllner's Figure.

and to diverge toward the extremities. The other figure shows the angles reversed, with the effect of changing the apparent curves of the really straight and parallel lines.

The principle of the following of the eye along the line of the object is further illustrated by the diagram of Zöllner (Fig. 45), in which the main vertical lines appear to diverge, the divergence being associated with the special direction of the short oblique lines.

Explaining the geometric illusions of Hering and Wundt, page 133, Hering takes the ground that the separation of two points removed from each other by a small distance is estimated at a greater relative value than that of points farther removed if there is no dividing

point between these latter, and that in like manner a small arc has a larger relative value than a greater one in visual perception. Hence, in the figures the acute angles are overestimated and the obtuse angles are underestimated.

Helmholtz also took the ground that these illusions are examples of the rule that the acute angles being small and sharply defined appear in general relatively too great when compared with right angles or obtuse angles undivided.

These explanations do not appear to reach the essential and ultimate reason, for we must ask ourselves, why should these acute angles be overestimated?

I suggest that an answer to this last question may be found in the fact that the movements of the eye for the acute angle are incomplete, while for the obtuse angles they are more in conformity with the full extent of the lines bounding the angles.

Thus, for example, if the line of sight, by movement of the eye,

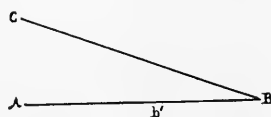

Fig. 46.

passes from the fixed point A to take cognizance of the angle ABC , its excursion may be arrested at b' and pass to C . Then, since the angle $Ab'C$ is greater than the angle ABC this latter angle is overestimated.

This hypothesis is, it would appear, fully sustained by the investigations of Judd¹ in respect to the Müller-Lyer illusion, where photographic registrations show that the movement of the eye in the direction of the acute angle is habitually arrested before the point of the angle is reached. The results of McAllister on the fixation of points in the visual field and those of Cameron and Steel on the Poggenдорff illusion² seem to point in the same direction.

In respect to a number of these geometrical illusions Helmholtz also regarded the phenomena of irradiation as a sufficient and satisfactory explanation in certain, if not in many, cases, and he pointed

¹ Yale Psycholog. Studies; Psychol. Review, March 1905.

² *Loc. cit.*

out the manner in which these phenomena, by the law of contrasts, might induce these effects.

In a more recent discussion of irradiation as the cause of geometric illusions, Alfred Lehmann¹ illustrates his thesis by the following figures in connected squares (Fig. 47), and asserts that the illusion at *B* in this case, must be entirely due to irradiation.

It will be observed that the two lines of squares at *B* appear to incline toward each other above and to recede from each other below, the fine connecting line being transformed into a series of zig-zags as suggested at *E*. He argues that, in this case, the highly and the feebly illuminated spaces are in close juxtaposition, permitting irradiation.

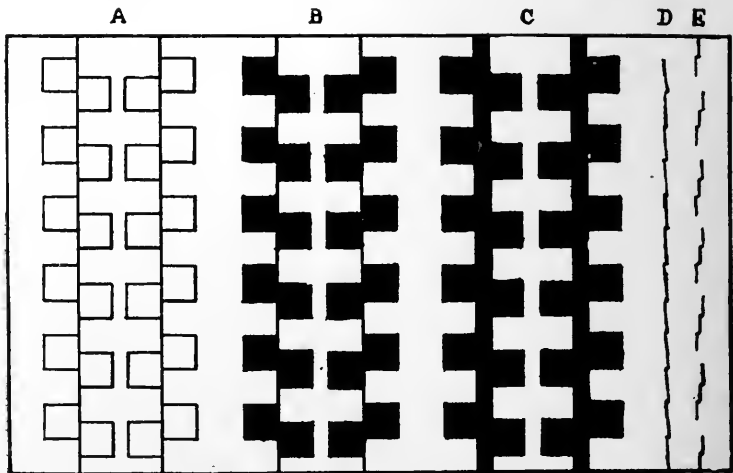

Fig. 47.—After Lehmann.

tion from the clear to the obscure squares. In the case of the two series of squares at *C*, the connecting line is so broad that the effect of irradiation does not extend to the black squares, hence there is no illusion. On the other hand, at *A* where there is no strong contrast in the illumination of the squares, the illusion is also absent.

This hypothesis, as Helmholtz well understood, would hardly apply to such figures as the Hering illusions (Figs. 43 and 44), or to that of the Müller-Lyer (Fig. 42); and while it might be supposed that the Poggendorff illusion (Fig. 48), when the upright column

¹Die Irradiation als Ursache geometrische-optischer Täuschungen. Pflüger's Archiv, 1904, Bd. 103, p. 84.

is of solid black, might be explained on this principle, it can hardly be supposed in case the figure is drawn in outline as here shown that irradiation can be an important factor in the illusion.

This principle of illusions of geometric forms and of contrasts in vision is a practical and important one, too little considered and as a rule neglected. It applies to many forms of art, especially to architecture, to drawing, and even to the furnishing and tapestries of private and public rooms. The architect who plans a public hall for public speaking in which there appear lines or curves which induce

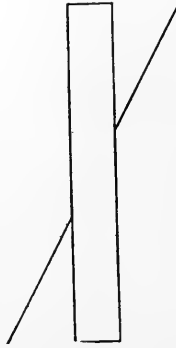

Fig. 48.—Poggendorff Illusion.

illusory impressions such as have been mentioned, draws the attention of listeners to the peculiarities of the structure, to the disadvantage of both hearers and speakers. Even the carpet on the floor may, by the annoying visual impressions to which it gives rise, occupy the attention of the hearers to the exclusion of subjects supposed to be more profitable.

SECTION XVI.

PERSPECTIVE.

Although the complete idea of perspective is gained only by the use of the two eyes, there are yet means of arriving at a knowledge of the distance of objects from the eye which are furnished by monocular vision. We have already seen how, as the eye sweeps from one point of an object to another, or from one object to another, the angle through which the line of regard passes represents an extent of move-

ment of the eye in respect to the body, or the extent of movement of the body itself, and that the comparative distance of the points or objects from each other in the field of vision, is measured by these movements. Yet there is in this statement of the case an important omission, for a comparatively small object near to the eye will occupy an angle in the field of regard equal to the angle occupied by a larger object which is more remote. Hence two objects of unequal size may demand equal movements of the line of regard, in order to sweep from one extremity to the other of each, and hence also they should appear of the same size. We find, so far as the movements of the eye are concerned, and so far as the distance of the points of the retina which correspond to the extreme points of the two objects are concerned, they are seen as though of equal size. Yet there is a consciousness that these objects are not of like dimensions, and this consciousness arises from the knowledge that one of the objects is removed to a greater distance from the eye than the other. We may then say that in order to give a correct impression of the comparative size of objects in the field of view, there must be not only a knowledge of the superficial extent of the images of these objects, but a knowledge of depth or distance.

This knowledge of distance from the eye is acquired by the experience of the individual in regard to the size of familiar objects, through the efforts made in accommodation of the eye, by comparison of the size of unfamiliar with familiar objects, and largely through the simultaneous use of the two eyes. For the present we are to consider only the means of judgment afforded by a single eye. Among these means are those employed by an artist who spreads a picture upon a canvas. It is a matter of small consequence, so far as the merits of the picture are concerned, whether it represents the objects included on a large or a small scale, if the relative proportions of size are maintained. In the picture the relative distance is suggested by the shadows, and by the relative size of familiar objects. Thus in many pictures it is essential that figures of persons or of domestic animals be introduced, in order to convey any just idea of the size of the principal objects represented.

It is possible within certain limits for those in whom the function of accommodation is active, to judge of the comparative distance of different objects along the line of regard. The limits of this means are narrow, for beyond a certain distance, a few feet only, the accommodation is not an element of importance, and even until the object

is almost within the reach of the hand, the influence of accommodation is only plainly perceptible for considerable differences of distance. Of course, after a certain age the accommodation plays no essential part in the estimation of distances.

Such comparisons are, of course, the result of experience. An infant, having little experience, reaches out for objects unattainable. Distant objects appear to the child small, not distant.

The relation of objects, as shown by the partial hiding of one by the other, serves as a means of comparison. If a tree of a certain kind stands in front of a hill so as to conceal a part of it, the tree must be nearer to the eye than the hill, and from a knowledge of the usual height of a tree of the kind when it has attained to a certain form, we may judge of the object behind it. If, however, an artist were to draw

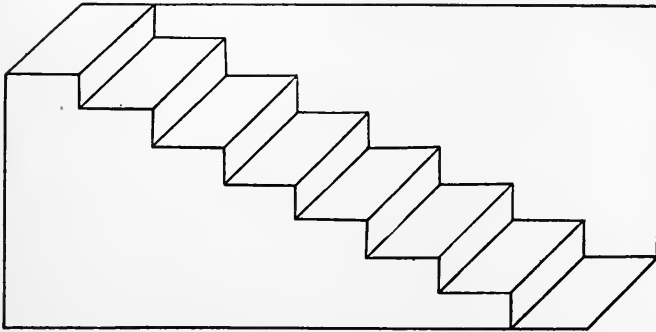

Fig. 49.—Schröder's Diagram.

a hill behind a plant of an unknown species, no judgment of the elevation of the hill could be formed from the comparison.

The perspective of such objects as surround us in our houses—tables, chairs, stairways, doors, etc.—is easily recognized usually by the angles formed by the line of regard and the object which is seen or the picture which is drawn of it. If the angles are such that they may apply to the object in more than a single position, the distances of the various parts may not be uniformly interpreted from a diagram, unless there is added the normal shading by which the relative positions become fixed in the mind. The diagram of Schröder¹ (Fig. 49),

¹“Poggendorff's Annalen,” *cv*, shown in Helmholtz, “Optique Physiologique.” Looking at the diagram the idea of a flight of stairs against a wall is suggested, but if the diagram is still further examined it appears as a piece

which permits a different interpretation, depending on the choice of a line as the near or distant one, illustrates the principle that such diagrams must have certain individual characteristics in order to present uniformly to the mind the same idea.

The character of illumination of an object often influences the mind in determining the quality of depth or of relief, and it is not infrequently the case that of two objects or two parts of one object which are at some distance from the eye, that having the strongest illumination will appear less remote than the other. The effects of shades become, in the hands of a skillful artist, his most important aids in giving to his canvas the appearance of nearness and distance, of foreground and background; and even the comparative size of objects in the picture is often determined by the length or position of the shadows. In the actual view of objects the same principles hold, for the artist only copies from Nature the effects of perspective which are afforded by the shadows.

Again, the comparative dimness with which objects are seen at a great distance, in contrast with the brightness of objects more nearly situated, forms another element in the mental estimate of relative distances.

A universal subject of speculation with writers who treat of perspective is the apparent size of the moon when seen near the horizon and when it appears near the zenith. That in the first position it appears larger than in the second, is well known, but the reasons for the phenomenon given by various writers have not all been in harmony.

When objects are at an infinite distance, there is no direct means of judging of the comparative size. Of two stars which may appear of the same size, one may be a planet of our system, the other a sun equal to many such planets. Yet on account of the comparative proximity of the moon, we may form an estimate of its apparent size under various circumstances. Helmholtz supposes that the aerial perspective, that is the dimness produced by the great extent of air, to which allusion has just been made, furnishes an explanation. An object occupying the same visual angle at the two positions, but seen through a greater extent of air at the horizon than at the zenith, and

of overhanging wall with graded shelvings. When one of these impressions has taken possession of the mind it is difficult to change to the other impression. Yet suddenly the change is made, when it is as difficult to return to the first impression.

therefore less sharply, appears, according to him, larger from the association of ideas arising from daily experience.

While this may be and doubtless is an element in the solution of the question, there is probably another equally important if not more influential. It is in the position of the eye when looking at the object in the different positions. We are accustomed, when looking at remote objects, to raise the eyes. With the idea of elevating the line of regard comes the idea of distance, and with it that of smallness. The association of ideas is somewhat complicated, and will be better understood when the section on "Unconscious Conclusions" is considered.

The elements in the conception of the third dimension which we have thus far studied, are those which may be obtained by the use of a single eye. They consist in some degree of efforts of accommodation, but more largely of movements of the line of regard, governed by contrasts of color and of light and shade, and are for the most part such as can be represented by a painter upon canvas. The appreciation of the meaning of the various arrangements of light and shade and of size and relative position of these color surfaces upon a canvas must of necessity be the result of experience. There can be no innate conception of the resemblance of the picture of a landscape to the landscape itself, for there is no essential resemblance between the two. The picture consists of signs which are interpreted by the mind in accordance with the various movements of the line of regard in relation to the lights and shadows of the picture and the accordance of these movements and these contrasts of light and shade with the ordinary experience in viewing the real landscape.

In considering the elements of the visual conception of the third dimension thus far, we have supposed the eye to be in a single and unvarying position, modified only by the movements necessary to enable the line of regard to sweep over the different points of the field of view.

An element of great importance may be added to these, in a change of position of the eye itself, so that the object may be seen from different points of view. Thus by a movement of the head, or by a change of position of the body, there may be added to the impressions which have already been discussed new impressions of immense importance in the formation of the conception of perspective. In this case the mind, carrying the impression received from the first position, adds this impression to that which is received in the new

position, and thus forms a more perfect idea of relief than was possible while the objects were seen from a single point in space only.

A new element in forming the conclusion also enters with the displacement of the eye relative to the object seen, for not only is the object itself seen from different points of view, but if the object is at a finite distance, all surrounding objects undergo an apparent change of position relative to the object regarded. If the other objects are at a greater distance from the eye than that which is fixed by the eye, the displacement of those objects will be in a direction the reverse of the change of position of the eye itself. If they are nearer than the object fixed, they will move in the same direction as the eye. Such relative changes in the apparent position of objects becomes a most important means of determining their relative distances, and without these changing angles, perspective is deprived of its most effective aid.

If this change of position of the eye through the movement of the head or body brings such material assistance to the conception of perspective by the mental comparison of the impressions received at successive moments of time, much more may we look for even greater assistance in this conception when two eyes, governed by the same will, and carrying impressions to the same sensorium, and which are situated at some distance from each other, receive simultaneous impressions from the objects within the field of regard. In this case there are presented to the mind simultaneous impressions of contrasting shadows and relative angles which can be instantly and accurately compared, and the results of experience brought into service while all the elements for forming the conception are present. By this means the ideas of distance may be accurately and quickly acquired.

Binocular vision, therefore—simultaneous vision with the two eyes—becomes a study of first importance.

Coming to the study of distance and of relief by binocular vision we have the elements for forming the judgment which we have already recognized in the case of using one eye only, to which a number of very important elements are added. In the recognition of distance and relief one must appreciate not only the absolute distance of the object, but the comparative distances of its different parts.

This may be arrived at, first, by a comparison of the outlines of the object as seen by the two eyes if the object is at a finite distance, for, owing to the difference of direction of the lines of regard, the form of the images recognized by the two eyes may not be the same, and

this difference of outline is quickly appreciated by the consciousness. Second, the direction in which upright lines appear to lean as seen by each eye. Third, the distribution or the extent of lights and shades may be unlike for the two eyes. Fourth, the relation of the object to objects behind or in front of it differs for the two eyes. Fifth, the sense of comparative convergence. Sixth, the difference presented to the two eyes in the apparent height of different parts of the object which may be of the same height. These and some other principles which enter into the subject can best be examined by the aid of the stereoscope and hence it is convenient, before entering more in detail upon the study of the phenomena of binocular vision, to investigate the mechanism and principle of the stereoscope as the instrument which affords the most important aid in that study.

SECTION XVII.

THE STEREOSCOPE.

It was Wheatstone, afterward Sir Charles Wheatstone, who in 1833 first enunciated the principle on which the stereoscope is constructed. He had put into practical application the vague ideas of binocular vision which had from time to time been suggested by Euclid, Galen, Leonardo da Vinci, and in later times somewhat more in detail by others, and was able to show that by placing before the eyes two pictures, differing as the impressions of natural objects differ when received by the two eyes, a single picture with the idea of relief was then obtained.

His enunciation was as follows: "A solid object being so placed as to be regarded by both eyes projects a different perspective figure on each retina; now, if these two perspectives be actually copied on paper and presented, one to each eye so as to fall on corresponding parts, the original solid figure will be apparently represented in such a manner that no effort of the imagination can make it appear as a plane surface."

The stereoscope of Wheatstone consisted of two glass mirrors fixed in frames and adjusted to an angle of 90° with each other. In a panel at each side, at an angle of 45° with the mirror of the same side, the drawings are placed. The image of each drawing received by its respective mirror is reflected toward the position at which it is to be received by the eye. By means of mechanical arrangements the pic-

tures may be moved to a greater or less distance from the mirror and also their angle to the mirror may be changed.

Thus the two pictures may be presented to the eyes when adjusted in parallelism or in convergence. The diagram (Fig. 50) represents the principles of the reflecting stereoscope.

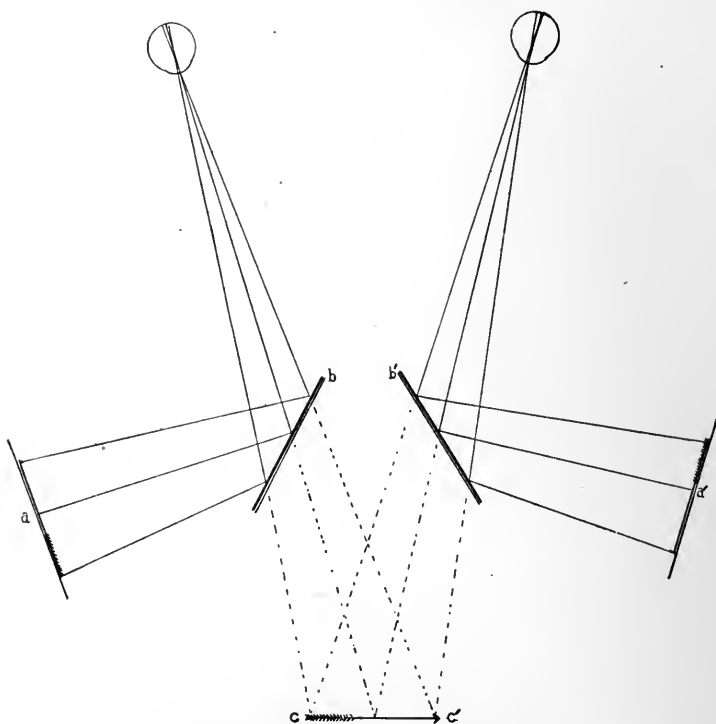

Fig. 50.—Diagram representing the principle of Wheatstone's Stereoscope. *a, a'*, The cards with the two pictures. *b, b'*, The mirrors. *c, c'*, The apparent position of the combined images.

The possibility of viewing the stereoscopic images with the visual lines parallel renders this form of instrument more serviceable in experiments with binocular vision than the form now in most general use and which is now to be described.

This, the commonly known stereoscope, is the modification of Brewster and is known as the refracting stereoscope. Essentially it consists of two prisms whose apices are turned toward each other.

These prisms are sufficiently strong to bring two pictures whose corresponding parts are two and a half inches distant from each other to coincide at the required distance from the lenses. A screen separates the two prisms and extends forward so as to shut out the left image from the right eye and the right image from the left eye. In practice the prisms are compound lenses, combining with the prismatic element a convex spherical curve by which the pictures are somewhat enlarged. By carrying the pictures to a greater or less distance from the glass the focus may be adjusted for different eyes. Fig. 51 illustrates the principle of the Brewster stereoscope.

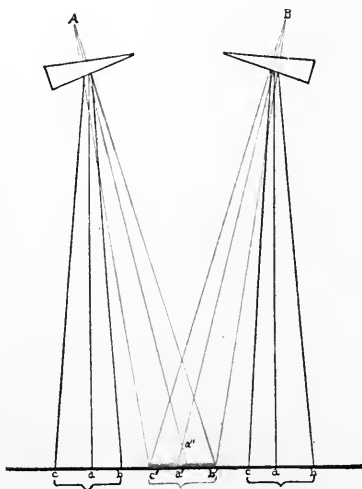

Fig. 51.—Brewster's Stereoscope.

Recognizing some of the defects of the refracting stereoscope of Brewster as an instrument in the study of physiological optics, yet appreciating the advantages of its form over that of the reflecting stereoscope of Wheatstone, Helmholtz constructed a stereoscope in which the lenses, mounted in tubes, could be raised or lowered and carried in or out. This stereoscope, although useful in physiological investigations, was not introduced into general use.

Another stereoscope, on a principle combining prisms and mirrors, was called by him the telestereoscope. This instrument was designed to obtain the effect of relief at great distances, and in order to reach this result, the base line between the points receiving the two

images was made greatly to exceed the base line between the eyes. Each eye looks into its respective tube, from which it receives the image which has first encountered the mirror and has been reflected by it along the horizontal tube until it is refracted by the prism into the short tube containing the ocular. The object is thus seen as from two points removed as far as from one extremity of the instrument to the other.

By recent modifications of this principle, field glasses of greatly improved stereoscopic effect are now manufactured.

By means of the stereoscope many of the phenomena of binocular vision may be so represented as to permit of analysis and comparison such as could not be controlled in ordinary binocular vision, and the knowledge of this subject may, in fact, be said to have dated from the invention of Wheatstone.

If two symmetrical or nearly symmetrical diagrams are drawn upon a piece of cardboard, at a distance about equal to that separating the two eyes, and the cardboard being held parallel to the base line uniting the eyes and directly in front, the images of these two diagrams may be made to unite and appear as a single image. If the two diagrams are symmetrical in form and position, the united image will be similar to each of the two original diagrams, but if there is slight asymmetry in form or position, the combined image will differ from both the originals, and will assume some features essentially different from either.

This experiment may be made in the following manner:—

Make any diagram, however simple. It may be two straight lines only, but situated at a distance apart equal to the nodal points of the two eyes. Let the direction of the two lines vary slightly, as in Fig. 52.

Holding the card directly in front of the observer, the visual lines are held in parallelism, but the accommodation is adjusted for the distance of the card. For those who are not practiced in the control of the eyes for optical experiments, it may be necessary to introduce some assistance, either in the form of a card which, being placed in the median line, prevents the crossing of the visual lines, or, still better, the experimenter may use a tube of a few inches in length, which he holds in the hand before one eye, and directs it toward diagram of the corresponding side. Two such tubes may be used, one before each eye. After some practice with the tubes, removing one

and then the other, the knack of blending the figures may be acquired.¹ It is much less easy for persons who have either esophoria or orthophoria to accomplish this than for those who have a moderate degree of exophoria.

Another method of blending, and one much more easily acquired than that just mentioned, is to cross the eyes (the right eye being directed to the left image, and *vice versâ*), so as to bring the combined image to the point of crossing of the visual lines. In this case the combined image will appear nearer than the two originals, and the eyes, instead of being in parallelism, are in convergence. The perspective is in this case reversed, so that pictures and diagrams have not the usual appearance of relief, but the parts of the diagram which should appear in advance will seem to be behind.



Fig. 52.

In the experiment (Fig. 52) the combined image will assume a direction different from either of the original diagrams. It will lean neither to the right, like the left object, nor to the left, like the right one. If combined with the visual lines parallel, as, for example, when looking through the mailing tubes, it will lean with its upper end approaching the observer, while if the union is made by converging the eyes, the upper end will appear remote, and the lower end will approach the observer. With the stereoscope the leaning will be in the direction seen with the mailing tubes.

In all experiments of this class, such as those made by Volkmann,

¹ For the experiments in this section and in that on "Unconscious Conclusions," the reader would do well to supply himself with two tubes known as "mailing tubes," which can be procured at most stationers at a very small expense.

Helmholtz, and others, in respect to corresponding lines and points of the retina, it is essential to know whether the blending is effected by one or the other of the methods just described, for if by the first method, the visual lines are supposed to be parallel, while by the second, those lines must be in convergence, and all tests might undergo an important modification, depending on the fact of convergence or not.

If we inquire why the two lines in the experiment blend, with the appearance of leaning, not to one or the other side, but from or toward the observer, according to the method of blending, the answer is that the two lines of the diagram represent the apparent position of an object which would lean as seen in the blended image, if the object were viewed separately by each eye.

If a pencil or rod is held in the hand, in front of the eyes, and made to lean with its upper extremity toward the observer, then if the two eyes are closed alternately, it will be seen that the pencil does not appear to lean backward so much as from side to side, according to the eye which sees it. If the right eye is closed, and the left is directed to the pencil, it appears to lean to the right, and if the left eye is closed, the leaning is reversed. Now if we combine in the mind these two impressions, we have the effect of binocular vision, and the two lines of the diagram represent in their positions the positions of a real object leaning away from us, as seen by the two eyes.

Hence stereoscopic pictures are such as would be seen if the object were looked at first with one eye and then with the other. And inasmuch as they thus render the various lines of the picture from the direction of the two eyes, the mind accepts the two pictures as though the real object were viewed binocularly.

A second experiment of a simple character will introduce another fundamental form of stereoscopic images:—

Hold two pencils or rods, one in the right hand, vertically, in front of the right eye, and at a distance of about fifteen inches; the other also vertically, and in front of the left eye, at the distance of eighteen inches. Now, if the right and left eyes are closed alternately, it will be seen that when the right eye is closed, the interval between the two rods is greater than the interval when the left eye is closed and the right eye is directed toward the two objects. If we would imitate this phenomenon on a stereoscopic card, we would represent the two vertical rods by two vertical lines on each end of the card, but the interval between the lines on the left-hand end of the

card would be greater than that between the lines at the right-hand end of the card. If now we accomplish a blending of these two couplets of lines, they will appear to the observer to have the same relative positions as the two rods in the first part of the experiment, that is, the left vertical line will appear most distant.

As it will be seen in the section devoted to the treatment of strabismus, the stereoscope has of late come into somewhat extensive use for reëstablishing and preserving the vision of the amblyopic strabismic eye. To this end a number of forms of the instrument have been devised, of which we mention only that proposed by Prof. E. Landolt, of Paris.¹

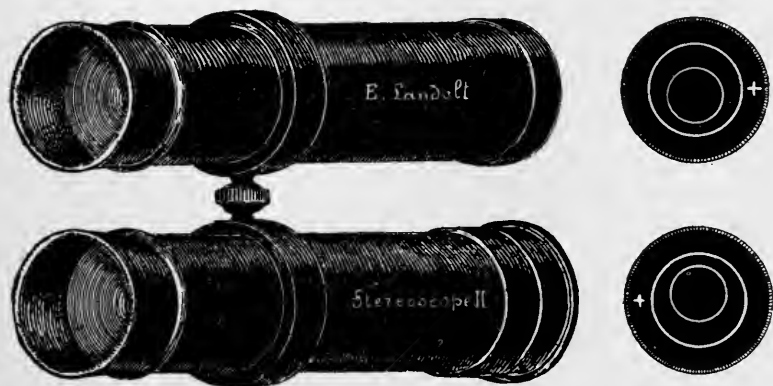

Fig. 53.—Landolt's Stereoscope for Reëstablishing Binocular Vision.

Professor Landolt says, the principal difficulty in attempts to reëstablish binocular vision (in strabismus) is found in the predominance of the visual impressions of the good eye. He therefore resorts to the expedient of reducing the visual acuity of the good eye by making a screen pass rapidly before it while the image presented to the amblyopic eye is of great luminosity. For this purpose he uses a stereoscope composed of two tubes (Fig. 53) about 12 centimeters long, which are joined by a ball and socket joint. Each tube has a convex lens as an ocular, the focus of which coincides with the length of the tube. At the further extremities are placed plaques which

¹"Un Nouveau Stereoscope Destiné au Rétablissement de la Vision Binoculaire." Proceedings International Congress of Ophthalmology at Utrecht, 1899, page 86.

carry the stereoscopic figures. They are to be viewed by strong illumination and are photographed on ground glass.

The intensity of the image of the good eye is reduced at will by superimposing glasses of somber tint in number sufficient to equalize the visual impressions of the two eyes and thus facilitate the union of their images. This may also be done gradually by an iris diaphragm.

Exercises are commenced by attempts to unite the most simple figures while the image of the best eye is caused to appear and disappear in rapid succession while the object is constantly presented to the poor eye.

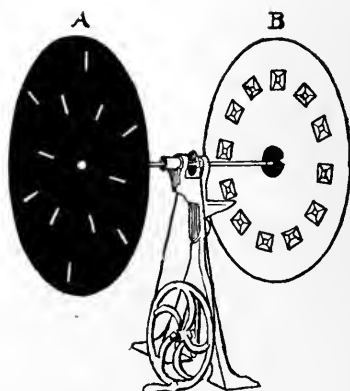

Fig. 54.—The Stereostroboscope.

THE STEREOSTROSCOPE.

With the view of representing objects in relief by several pictures presented to the two eyes in succession a number of instruments have been devised to which the name stereostroboscope has been applied.

In the stereostroboscope the eyes converge for one point, but do not simultaneously see the point. The principles of Münsterberg's instrument¹ may be briefly stated thus: Looking toward a disc, *B* (Fig. 54) on which are successive stereoscopic figures at equal distance from the margin and from each other, the observer sees through

¹"A Stereoscope Without Mirrors and Without Prisms," *Psychological Review*, I, 56, 1894.

another disc *A*, large enough to screen the first, through which are cut slits in two radial series so placed that the right eye sees through one series when the disc is rotated, the left through the other series. The slits for the right and left eye do not present themselves simultaneously, but alternately. The two discs are caused to rotate with each other. As the pictures are presented to the eyes alternately and as these pictures have alternately the characteristics of stereoscopic pictures the result is similar to the combined images with the stereoscope. To certain persons who find the union of the pictures with the stereoscope difficult or impossible, the stereostroboscope affords a substitute by which they are enabled to obtain the effects which are familiar to others.

THE PSEUDOSCOPE.

In the case of the stereoscope the pictures seen by the two eyes conform in shape and proportions to the images seen by the corresponding eyes when an object of three dimensions which they are intended to represent is seen in binocular vision.

A confirmation of the principles of the stereoscope is found when the conditions of seeing are reversed. For example, if the image of that side of the object which is ordinarily recognized by the right eye should be presented to the left and that for the left presented to the right eye, the object which should be seen in relief is perceived in intaglio. Also, if the course of the rays of light as they enter each eye is so changed that those rays which would, under ordinary circumstances, fall at the outer side of the point of clearest seeing, should be diverted to the inner side, and *vice versâ*, the result will be the conversion of the relief into that of depression, since the interpretations are changed by the inversion of the points impressed in the two fields of vision.

Such reversion of the course of the rays may be traced in Wheatstone's pseudoscope (Fig. 55), where the rays from the points *A* and *B* are caused to pass through right-angled prisms *P*, *P*.

The solid black lines as they pass from the two points to the eye indicate the uninterrupted course of the rays as they would pass without the prisms and show the relative points of impression on the retina. The dotted red lines show the diversion of the course of these rays, and it is clear that the course of the rays, *b*, *b*, from *B*, which

under ordinary conditions would fall at the temporal side from the points a, a , are so diverted from their usual course that they will fall at b', b' , or at the nasal side of the retina from a, a .

Prof. R. W. Wood¹ has suggested a more convenient form of

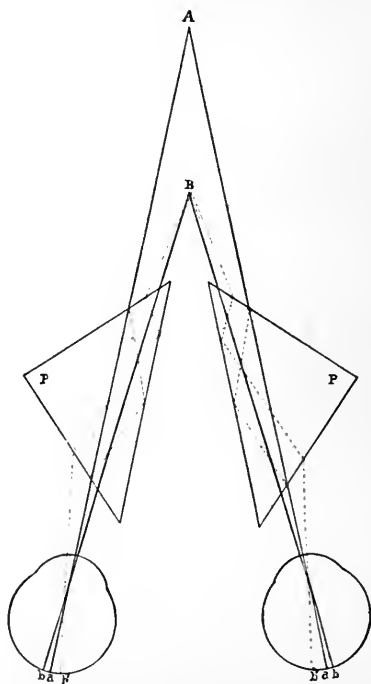

Fig. 55.—Wheatstone's Pseudoscope.

pseudoscope which can be arranged by a slight modification of the ordinary stereoscope. A pair of strong convex spherical lenses is so placed between the pictures and the lenses of the stereoscope at suitable distances that the observer sees, not the pictures directly, but their inverted images.

¹ Science, November, 1899.

SECTION XVIII.

UNCONSCIOUS CONCLUSIONS.¹

Applying the principles mentioned in the last section to experiments made with the stereoscope, we are able to explain by the comparisons which may be made between these experiments and our ordinary experiences many of the phenomena which would otherwise remain unexplained. Then, by employing these results we may reverse the process and gain a clear understanding of some of the phenomena of vision which have only been understood since the invention of the stereoscope.

As we proceed with the experiments of this section it will appear more and more clear that the acts of motion of the eyes are the basis upon which the idea of space as recognized by the visual sense is founded. It does not follow that motion is in every instance of judgment of space necessary, but that the experience which has been gained by the acts of motion is essential.

The experiment of Dove, already mentioned, shows that an object illuminated by an electric spark may be located in space although the light of the spark has not continued during a time sufficient to have enabled the eyes to adjust for the object. Here the knowledge of the distance and direction of the impression made upon the retina from the macula permits of a judgment of the extent and direction of the movement which would have to be made in order to accomplish the adjustment. That this form of judgment occurs constantly in respect to images which are received at points outside the maculas, and that it is essential to binocular perspective, was long since shown by Brück.

While it is true that the visual notion of space is the result of movements, it would not be possible to execute all the movements necessary in order to obtain an idea of the outline perspective of a complex body in the infinitely brief space of time in which such ideas are usually obtained. Consciousness is not the result of a single process.

Thus actual movements and potential efforts combine in the formation of the idea of visual space.

The long disputed question whether the ability to form judgment

¹This section on "Unconscious Conclusions" is the substance of an address given before the Troy Scientific Association, April 21, 1879, in which these diagrams were used with stereoscopes by the members.

from the signs given by the location of the impressions upon parts of the retina in relation to the macula is an inherited one, as the "nativists" hold, or an acquired one, as the "empyricists" declare, is not essential to our study. It may not be out of place, however, to venture the remark that it is most probable that the ability is derived both from inheritance and experience.

The ability of the chick to aim correctly at a grain of meal within the first hour of its existence has long been a stock illustration of the nativists, while the absolute inability of the young child to judge of visual space is equally the argument of the empyricist.

The question which might arise in the mind of one not wedded to either doctrine is whether the human being, the highest developed of all, has inherited less from his ancestors than have the more humble classes.

Is it not quite possible that the chick enters upon life with the nervous organization nearly perfect in all the essential relations of its parts, while the child is born less mature in this respect?

It is certain that some of the faculties in the human subject are developed only after several years of life. It is possible that with the growth of the individual there is not only the accumulation of experiences but a development of the inherited faculties which become immense factors in the ability to construct ideas from sensations.

It is fortunate that of the various channels through which the mind comes in contact with the world, that through which it acquires by far the greatest store of knowledge is the one with whose mechanism and workings we are best informed.

The study of the phenomena of vision leads us to the belief that our acquaintance with our surroundings is the result of mental deductions from physical signs. The impressions received by the visual sense are so many symbols from which the mind draws certain conclusions.

This method of drawing conclusions can be well illustrated by the effect upon the mind caused by certain combinations of diagrams, the elements of which, when examined under ordinary circumstances, appear in no way capable of presenting the appearances which they assume under circumstances somewhat modified.

The better to understand the significance of these unexpected appearances we should bring to mind the more generally entertained idea of the manner in which objects are perceived by the eye, and also an important but less generally understood view of the phenomena. Ac-

According to the more popular idea, rays of light from the different parts of an object, passing into the eye and through its refractive media, form an image upon the retina, or at least cause an impression of an image, which impression is transmitted from the retina, where it is formed, back to the brain, where it is perceived. This idea involves the transmission of the picture or impression as a whole.

The other idea is that the impression caused by the light on the retina acts as a sort of "finder," that the retina, possessing the function of recognizing light and color, acts as a guide to muscles which move the eyes, and that the movements of these muscles in bringing the most sensitive portion of the retina into direct relation with various parts of the object constitute a very important element in the recognition of the form and position of the object seen. In other words, that an important element in the act of vision is the mental recognition of certain muscular contractions by means of which the eyes are adjusted. There is also, in the conception of form, distance, and depth, the mental comparison of the two images or, to put it more technically, the two sets of required muscular adaptations.

It will be seen as we advance that these latter views have strong confirmation, and that, so far as they are correct, they indicate that the conception of an object, gained through the sense of sight, is after all, an idea made up from a variety of *unconscious conclusions*.

Beginning with ideas of a simple nature, and advancing to those more complex, we may, by the aid of a few diagrams and a stereoscope, illustrate the manner in which a large class of these mental conclusions are reached.

In the first diagram (Fig. 56) are two series of rings, arranged at a distance suitable for the stereoscope. Each series is like the other and each consists of several rings gradually decreasing in diameter, each smaller being included in the next larger. The rings have not all a common center, but the center of each, as it becomes smaller, is removed somewhat nearer toward the side next the other series than that of the next larger, until we reach the very smallest, which is exactly in the center of its surrounding ring.

Looking at these diagrams with the stereoscope we see the two series unite as one, but not as a series of concentric rings on a flat surface. The rings advance toward the observer from the larger to the smaller, projecting forward like a cone with its base on the paper and its apex in the air.

If we can give a reasonable account of this singular and beau-

tiful phenomenon we shall have at the same time made a step in comprehending a method by which the mind arrives at a conclusion in respect to relative distances.

Let us then examine what happens as we look through the glasses of the instrument. These glasses are essentially prisms with their edges set toward each other. The effect of each prism is to bend the light, which approaches it at right angles, toward its base. As one looks through the two prisms at the points a and a (Fig. 51) the line of light coming from a is bent at the prism, so that the observer turns the eyes in the direction from which the line of light from each image appears to come. As the eyes are thus turned to meet the line of light, the mental effect of this adjustment is to locate the image a at a' ; but the image of the second a is also similarly located,

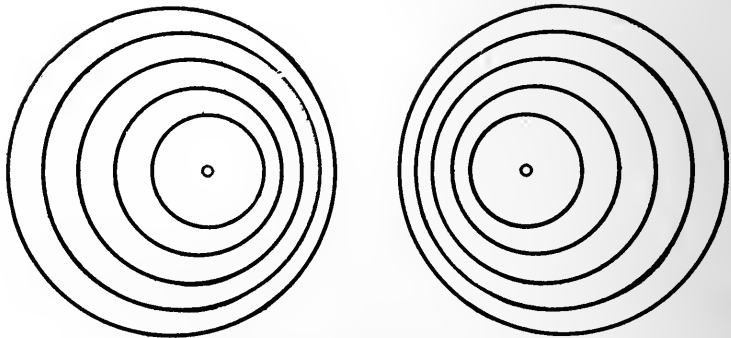

Fig. 56.

so that the two, provided that each consisted of a single element, would unite exactly at a' . Here we encounter a difficulty, for the figures at a and a are not simple elements, and were we to occupy ourselves with all the interesting questions which might arise in respect to this illustration, we would be slow in reaching the next diagram of our series. We may then pass directly to the statement that in this case the imaginary centers of the two largest rings would meet at a' . But it will be observed that the imaginary centers of the smallest rings are not so far removed from each other as the larger. As the prisms will bend the line of light from the smallest as much as the largest, it follows that the imaginary center of the smaller ring at a will be thought to be a little beyond a' toward b' , and likewise a corresponding excess of displacement of the smallest ring of b . In order to form a mental con-

ception of the union of these rings, therefore, they must be supposed to unite at a point at which lines drawn from the eyes to these two points would cross; that is, a little in front of a' at a'' , and in proportion as the muscular contraction for the convergence of the two eyes in observing the different pairs of rings is greater, the point at which the lines will cross is nearer to the observer. Hence the appearance of a series of rings rising toward the observer. But there is still an interesting point to be observed. Our cone is not perfect. Its apex is cut off, and in the center of the section is a dot exactly in the plane of the section. Why does the dot not advance to complete the cone? Because each of the dots is exactly in the center of a smaller ring, and the convergence of the eyes for the combined image of the dot is exactly the same as the average convergence, or the convergence for the imaginary centers of the rings. This experiment illustrates well the effect of the muscular adjustments upon our ideas of relative distance.

It may be said: "This is an interesting optical illusion!" But it is in reality a mental conclusion formed in the manner in which such conclusions are commonly formed. Then in what respect does it differ from the conclusions formed under ordinary circumstances? In this: that the result does not conform to the result of the impression gained by another important sense. If we pass our finger along the surface on which the diagram is printed we find that it encounters no raised cone of rings, it passes over a perfectly flat surface. In ordinary life the two senses agree. The infant sitting upon a smooth floor passes its hand along its surface and finds that he neither raises nor depresses the hand. The eyes follow the hand and he is conscious of no relative change in the angle at which the two are directed.

Suddenly the hand encounters a wooden cone and follows it to its summit. As the muscles of the arm elevate the hand, the muscles of the eyes perform a corresponding convergence. Thus the two classes of simultaneous movements are occupied with the same object. And, day by day and year by year these two senses, touch and sight, correct and supplement each other. This does not indicate that the infant is entirely destitute of that innate consciousness of relation, position, and distance which enables the just-hatched chick to seize its prey. It is enough to say that in the child the idea of position as recognized by sight is largely learned from muscular adjustments of the eyes, which correlate with adjustments of the muscles which are governed by the sense of touch. Whether, as Wundt holds, the visual sense

precedes the tactile, is not the question. It is, however, certain that the two senses supplement each other in the formation of the ideas of extension and of depth.

If now we have gained an idea of how we may arrive at a conception of nearness and distance we may advance to a more complicated class of conclusions. And here, even more than in the first instance, we shall see that what appears to us as a simple impression of sight is in reality the result of a process of abstract reasoning. (Fig. 57.)

As we examine this second diagram without the aid of the stereoscope we see each figure made up of two discs of exactly equal diam-

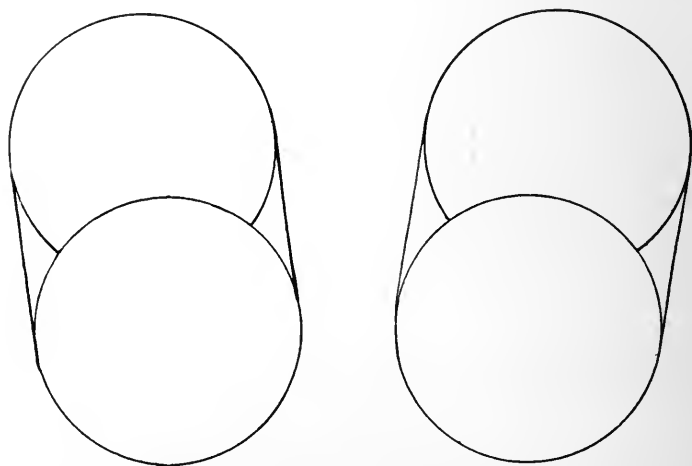

Fig. 57.

eter separated by lateral lines, and that the centers of one pair of discs are nearer to each other than the other. Using the stereoscope we now obtain a most interesting result. The two pairs of discs are united, the combined image of one pair in advance of the other. To this phenomenon we can apply the lesson already learned. But here is a new and interesting principle. The most distant disc is much larger than the other. Examine the diagrams again without the prisms. All the discs are of a like diameter. How then does one appear larger than the other? If a disc of a certain size were to be placed a foot in front of an eye, the eye, in looking along any diameter of the disc, would move through a certain angle. If another disc were placed exactly behind the first at a distance of two feet, it would require to

be much larger in order that, the eye moving through the same angle, that is, moved by an equivalent muscular adjustment, should see each border. We may therefore say, if the eye must move through equal angles in passing along the diameters of two discs at unequal distances, that the one which is furthest removed from the eye will be the largest.

Returning to our diagram, we have reached the conclusion that one of these discs is in advance of the other. But as the eye moves to an equal extent from side to side of each disc we reason that of necessity the disc farther removed must be the larger. Look as long as we please, we cannot reverse this judgment. Here then we have reached a primary conclusion, and then, basing our opinion upon the conclusion already formed, we draw a second conclusion, namely, that whereas one of these discs is nearer to us than the other, and whereas the eye must make as great an excursion in passing from one side to the other of the most distant as of the nearest disc, therefore the former is greater than the latter.

Here it will be in order once more to recur to the inquiry whether in reality the eye must move so as to bring the most sensitive point of the retina in linear relation to the different points of an object in order to estimate its size, and, again, whether in order to see the object singly with both eyes the image must fall upon this sensitive point of both eyes, or indeed of any corresponding points of the retina of both eyes. The experiment known to physiologists in which a person looking into a perfectly dark box sees an electric spark as a single impression, or by the illumination of this spark unites stereoscopic diagrams, shows that under certain circumstances retinal sensations may be felt at points not exactly corresponding, yet be received by the mind as a single impression. For, in looking into such a dark box, the eyes cannot be supposed to be adjusted so that the visual line of each would be directed to the point at which the spark would occur, nor adjusted for the haploscopic diagrams, and the duration of the spark is too brief to permit time for any such adjustment. Hence, at least under such circumstances, the mind accepts an impression under conditions in which the principle of muscular adjustments, upon which we have based the explanation of the results of the experiments just made, does not appear absolutely to prevail. Even these exceptions are not, however, opposed to the more common experience, for when such sensations fall upon non-corresponding points the mind may at once draw an inference from

the amount of adjustment which may be required to bring the sensations upon corresponding points, that is, the potential movement.

A running horse estimates the force which must be expended in leaping the ditch in front of him before the leap is made. In a similar way the amount of energy required for adjustment of the eyes is estimated before the adjustment is made.

Passing now to a class of phenomena in which the principle of mental conclusion from muscular adjustment, as already illustrated, is somewhat differently applied, we examine the third stereoscopic diagram. (Fig. 58.) Without the aid of the instrument we notice a pair of rectilinear figures, the outer lines of which are exactly alike. Within the outer frame-work in each figure three sides of a parallelo-

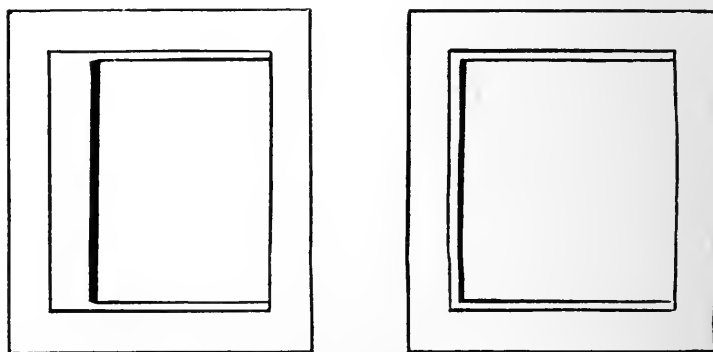

Fig. 58.

gram, in heavy lines, join the right side of the framework, which completes the parallelogram. Here for the first time the figures are not symmetrical, the heavy lines extending further across the right hand frame than the left.

Employing the instrument, another interesting phenomenon is observed. The framework is perfectly united at once, and after a moment the heavy lines also, but these latter swing backward like an open door. By what process of reasoning can these two figures induce this conception?

The following diagram may assist us in understanding the phenomenon (Fig. 59) :—

Suppose the eyes at *A* and *B* are directed toward *c d*, which may represent the space of a door, *ce* representing the door swung open.

In looking at the door space the eye *A* moves through the angle *cAd*, or from *c* to *d*. The eye at *B* makes an exactly equal excursion. Directing the gaze at the door itself, however, it will be seen that the eye at *A* will make a smaller excursion, that is, from *c* to *e'*, and the eye at *B* would also make an excursion less than *cd*, but greater than *ce'* (from *d'* to *c*), but that every excursion, both for the space and the door, reaches the point *c*. In other words, in looking at an open door arranged as in this figure the eyes make equal excursions for the open space and shorter but unequal excursions for the swinging door. These are the elements in the stereoscopic figure, and because these elements conform to the ordinary experience in adjusting the eyes the

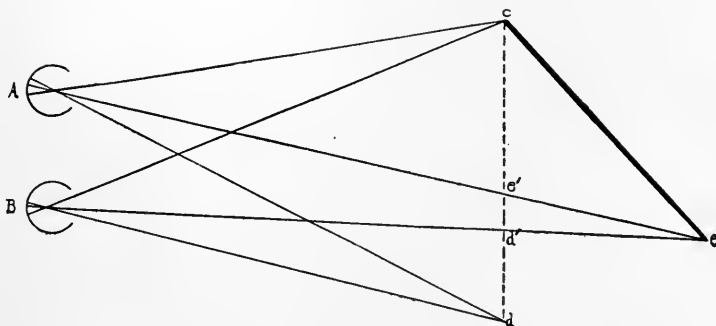

Fig. 59.

mind arrives at the conclusion that the object seen does not differ from what would, under ordinary circumstances, induce the corresponding ocular movements.

The same principle carried further will give other effects, such for instance as is seen in the diagram representing the guide-post. Here we get the principle of the door opening toward us and opening from us. (Fig. 60.)

Not only are the movements of the eyes made instrumental in the mental estimation of the physical characteristics of an object examined, but many of our ideas gained from the appearances of objects are gained through a process of conclusions in which the sense of touch would appear to have instructed the sense of sight. Although this brings us in some sense beyond the limit of muscular action, the general subject of these unconscious conclusions is so remarkably well illustrated by an examination of the elements which enter into our idea of luster that it may be profitably considered in

this relation. Examining with the stereoscope the diagram in which one parallelogram is white, the other black, a tilted mirror is seen. The principles already considered give the reasons for this tilting. The question of special interest here is how to account for the unexpected result of the stereoscopic combination of a black and a white surface. Ordinarily a mingling of black and white does not produce luster. We should expect it to produce either black or gray, and two dull surfaces are not supposed to unite to make a lustrous one. Let us take in our hand an object which gives a lustrous appearance—a perfectly smooth-cased gold watch, a smooth silver cup, or any such article which gives the effect of luster. Passing the hand over it

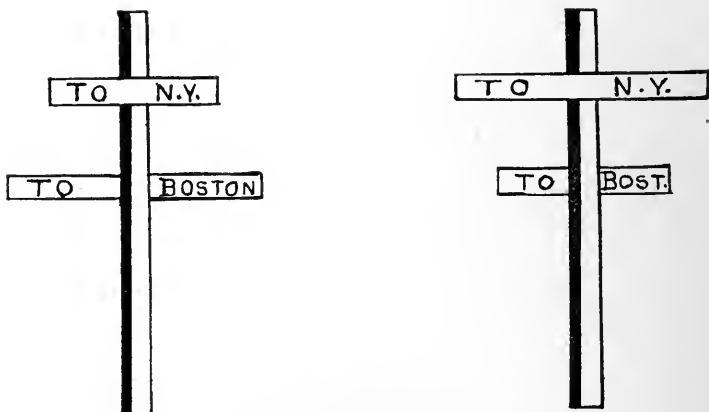

Fig. 60.

we find two prominent characteristics; first, the surface is composed of elements closely combined, giving a greater or less degree of density, and in the second place, the particles constituting this dense surface are exactly in the same plane. That is, the different superficial particles are never raised in irregular order, one above another. As we pass the hand we experience the sense of smoothness. What effect will this perfect smoothness of the surface produce upon light? First, the diffused light will pass to the eye as it would from a ball of wool or from a rough pebble; but second, another phenomenon will result which would not result in the case of the ball of wool or the rough pebble. As the direct light from some strongly illuminated point in the surrounding space falls upon this surface of dense and evenly disposed particles it is strongly reflected. If the

surface is curved these reflected rays light up certain portions of the surface much more strongly than others. Surfaces of which the superficial particles are roughly adjusted with respect to each other do not ordinarily give off these reflected rays.

Here then are two classes of sensations combined so nearly universally as to become firmly associated as characteristics of a certain class of conditions. There is the sense of density and of perfect uniformity of surface, gained from the touch; then there is the sense of the impression made by the diffused light in the eye and also the effect of the strong reflected rays. When the hand feels a surface of this kind in the dark the idea of the two kinds of light enters the mind, and when we see an object giving off from the same surface a weaker and a much stronger light the mind at once associates the



Fig. 61.

phenomenon with that of a perfectly smooth surface. Here then we have the associated ideas of luster. Looking now at our stereoscopic figure we have the usual elements of luster as they are presented to the eye, a weak light coming from the dark surface and a much stronger light coming from the white one. The mind at once enters upon a process of inference from which it quickly evolves the idea of the lustrous mirror surface.

Thus, returning to the experiments in form and distance, without entering upon any discussion of the relative merits of the question whether the mind derives its conceptions of the appearances of visible objects directly from the impression made upon the retina, or more indirectly through a wonderful series of muscular adjustments by which corresponding portions of the two retinae are brought into direct relations with the various parts of the object, we are able to see that beyond all question these delicate and intricate muscular

actions which guide the eyes are notably calculated to serve as media through which ideas of space and form may be obtained.

It is easy to see that many evils might result from imperfections in the instrumentalities through which these remarkable adjustments must be made, and we may find important subjects for reflection in the nicety of the machinery and the necessity of all its parts working without needless friction.

Directing our thoughts to the side of the relations of the principles already illustrated to conceptions of the beautiful in art, we find that the character of the movements of the eyes as governed by the various muscles which direct their visual axes is that which largely contributes to the kind and degree of pleasure derived from the contemplation of an artistic design.

It would be difficult or impossible for us to conceive how a picture with regular yet varied curves formed at the retina and transmitted to the brain, should cause a more soothing effect upon the mind than one with jagged and irregular outline. If, on the other hand, we think of the muscles of the eyes directing them along the undulations of soft curves or following around rough and ragged outlines, we can see that in one case there will be pleasurable but easy movement, while in the other there will be uneven or jerky movements, which may be tiresome or only stimulating, depending on their nature. On the theory, then, that the pleasure gained in looking at a picture or building, at a book or at the gestures of a speaker, depend upon movements of the eyes in following the outlines of stationary objects or the movements of the active objects, it will be seen that in order to induce continuous pleasure these movements must be varied. There must be easy swinging, monotonous drifting, sudden changes, and even irregular and harsh movements. The picture which would excite various emotions must combine these various classes of lines.

SECTION XIX.

THE FIELD OF BINOCULAR VISION.

In the ordinary vision with two eyes there is a part of the field in which objects are seen by both, for a part of the field seen by one eye extends over a part of the field seen by the other. There is also a part of the visual field of each eye which is seen only by itself.

This may be shown by the simple experiment of observing the extent of the visual field while both eyes are used and then slipping a card in front of one eye when some of the objects which were in the common field will be no longer visible. Or if one brings the right hand from behind forward until it just enters the field and then closes the right eye the hand will no longer be within the visual field. By advancing the hand it again enters the space in which objects are seen. By experiments of this kind but more carefully ordered, the extent

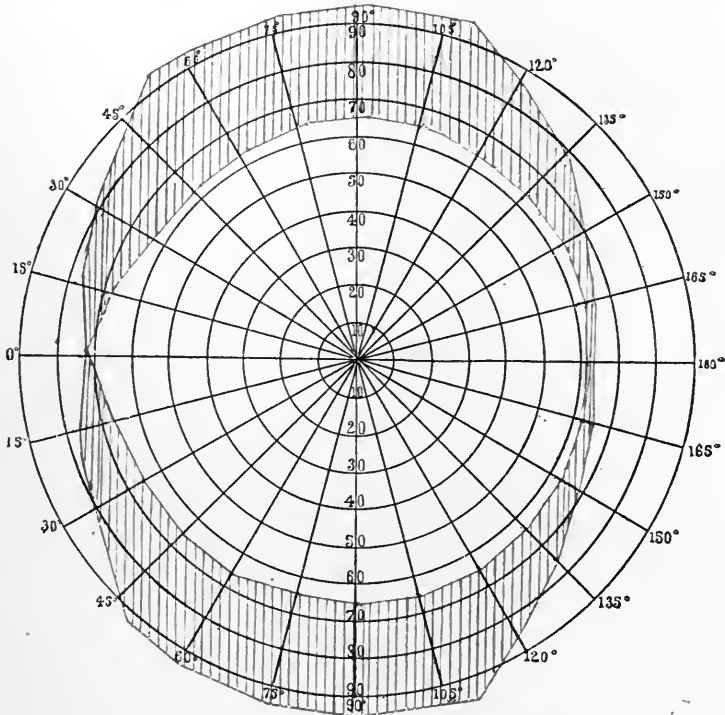

Fig. 62.—The Common Field of Vision.

of the field which is common to the two eyes and that which belongs to each eye separately may be ascertained.

The conformation of the face, especially the prominence of the nose and of the brows, is an important factor in the common field of vision.

The approximate area of the common and of the individual fields when the eyes are directed to a fixed point is indicated in the

accompanying diagram. That part of the diagram (Fig. 62) enclosed by the outer strong red lines suggests the whole field of view. That part which is not shaded is the portion common to both eyes, while of the shaded portions, that to the right of the line indicated by 90° belongs to the right eye only and that to the left of that line is seen only by the left eye.

Since it is only within a limited part of the field of view that objects are seen simultaneously by both eyes, it is only within a limited part of the field of view that the true sense of depth or the perspective of the third dimension is perceived. Within that field, impressions of sight derived from surrounding objects are received upon the two retinas, but owing to the varied positions of such objects within the field of sight these impressions cannot all, nor indeed a considerable proportion of them, be received simultaneously on corresponding portions of the retinas.

Unless, therefore, there were some system of selection of impressions which the mind should choose to recognize there must result a chaos of confused sensations from which no just idea of the objects seen could be formed in the consciousness.

As a matter of fact the eyes can make such selections, and it is possible, by appropriate movements, to place the two eyes in such relations to each other that a certain selected part from the general aggregation of sensations recognized by the eyes shall fall upon the parts of the retinas which are so related to each other in the mind that they may be said to be coinciding or corresponding points.

SECTION XX.

OF CORRESPONDING POINTS.

Johannes Müller,¹ employing a method which had been introduced twenty years before by Purkinje,² of inducing subjective images from both retinas by scleral compression, arrived at the conclusion that, in general, corresponding points of the two retinas are those which, were the two latter overlying so that the poles, with the vertical and horizontal meridians, would be in contact, all other identical points would be corresponding points. Later researches by Hering,

¹ Handbuch d. Physiologie, 1838.

² Beobachtungen über Versuche zur Physiolog. d. Sinne, 2, 44f., 1819.

Helmholtz, Volkmann, Van Moll, and Donders, introduced the doctrine which appeared to be universally established until the introduction of the clinoscope, that, while the doctrine of Müller would apply to horizontal meridians it would not apply to the vertical meridians of the retinas, since these last were supposed to diverge above and the divergence, by common consent, was equal to about $1\frac{1}{4}^{\circ}$ for each retina; though Donders, Van Moll, and others thought that the divergence above might be considerably greater. The early results of examinations by the clinoscope demonstrated that in all cases in which the vertical meridians lean the horizontal meridians lean in a corresponding direction and to an equal extent.

Corresponding points of the two retinas are, by no means, with a single exception, anatomically symmetrical points. There is no evidence in support of the old view that a nerve filament, in its course between its origin in the brain and its place in the retina, divides so that one part may be supplied to each retina. Except the condition of hemianopia there is no evidence of anatomical symmetry. With the existing knowledge of the subject we have only to recognize the phenomena.

Recognizing that, with the exception of the maculas, we are unable to locate corresponding points by anatomical symmetry, philosophers have, as we have seen above, with what has appeared a plausible degree of precision, located them from their geometrical relations. These observers apparently, in the search for the purely physical explanation of corresponding points, forgot that binocular vision is something more than a mere series of physical phenomena such as might occur in a passive optical instrument.

It is desirable that the doctrine should be considered from this purely physical side in order that we may discover the inadequacy of the reasoning and that we may be better prepared to consider the somewhat more difficult, but the more satisfactory, doctrine of a combination of physical and psychical phenomena.

Stating the doctrine as it has been accepted and as it is now accepted in works of physiological optics, it may be expressed as follows:—

If the image of a given point is located at the temporal side of the macula of the right eye the impression will also be located at the nasal side of the macula of the left eye and at a distance from it equal to that of the impression of the right eye from the macula. Also, if the image is impressed at a horizon above that which passes through

the maculas or below that horizon, the impression for each eye will be equally above or below this horizon.

These points are not anatomically but geometrically similar. A glance at Fig. 63 will make the principle of the doctrine plain.

Let A and B be the two retinas and X and X' the two maculas. If the selected impression is located on the retina A at O (*i.e.*, at the temporal side of the macula) it will be located at the point O' of the retina B at the nasal side of the macula and at the same distance from X' as O is from X .

It at once appears that the two retinal points O and O' are, from an anatomical point, in widely different localities.

But these two points will not only be equally removed from the maculas, they will be on corresponding horizontal meridians of the

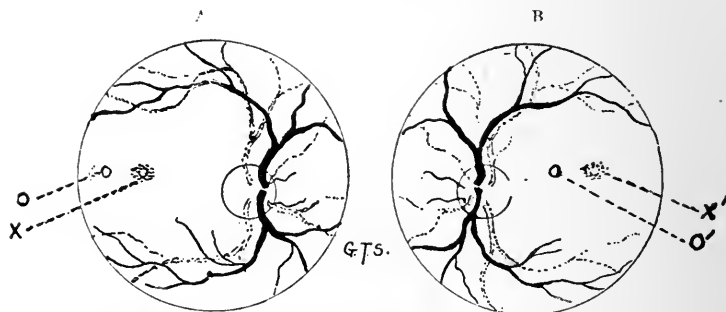

Fig. 63.—Maculas and Corresponding Points According to the Accepted Doctrine.

two retinas. Thus if the point O is on the horizontal meridian passing through the macula at X , the point O' will be on the horizontal meridian passing through the macula at X' . Also if the point O' is situated on a horizontal meridian above or below the meridian of X the point O will be on a horizontal meridian equally above or below the meridian of X' .

Helmholtz thus states the law of corresponding points:—

“Upon the apparently vertical concordant lines¹ (of the two eyes), points which are at equal distances from the horizontal meridians are corresponding points.” And *“points which in the retinal*

¹Helmholtz here speaks of “apparently vertical lines,” referring to his view that the vertical meridians are not truly vertical while the horizontal lines are truly horizontal.

horizons are at equal distances from the point of fixation are corresponding points."¹

In respect to corresponding points in the *field of vision* we may again quote: "*Corresponding points in the two visual fields are those which are at equal distances and equal in direction from the corresponding horizontal and apparently vertical meridians.*"²

While this proposition is not altogether clear, it is evident, from the context, that, according to it, a series of points equally distant in the field of view and from which proceed lines of direction toward points of the retina equally distant from the maculas and in corresponding meridians, are corresponding points.

The proposition first quoted and this last cannot both be true except under circumstances entirely at variance with Helmholtz's illustrative experiments. These experiments are made, not with curved surfaces, hollow spheres, but with plane surfaces like the usual stereoscopic cards or the pages of a book.

The propositions of Helmholtz are inconsistent with his examples. Indeed points of the two retinas which are at one moment corresponding points may at the next moment be non-correspondent if the ocular adjustments have changed. If we accept the experiments of Volkman, which are quoted and endorsed by Helmholtz, it must follow that the accepted theory is not tenable. The following is one of Volkman's experiments which Helmholtz characterizes as "exact." While accepting this characterization it must also be conceded that it is by no means conclusive. Indeed, it falls far short of a demonstration of the proposition he is aiming to prove.

"A rectangular cross is formed before each eye by the horizontal a, a' (Fig. 64) and the verticals s and s' , the distance between which should be equal to the interval of the eyes of the observer. Below the horizontal line and at the external side of each vertical there are traced two other horizontals b and b' of which the one, b , is fixed, while the other, b' , is mobile parallel to itself. The observer fixes the centers of the two crosses in such a manner as to obtain fusion. Then the mobile horizontal, b' , is adjusted in such a way that it becomes, apparently, a prolongation of b , which is immovable in the other visual field."

¹"Optique Physiolog.," p. 880 and 886.

²*Ibid.*, p. 896.

The distance from the eyes was 300 millimeters. When the movable horizontal was adjusted so as to appear precisely as a prolongation of the fixed horizontal, it was found, as the result of many experiments, that the distance of the two horizontals from the main horizontal line was always the same. Many experiments can be made which will more effectually prove that on a plane surface equally removed points will be recognized as such by both eyes acting simultaneously. Such experiments I have made in various ways by many devices and they all indicate that in the field of regard points of equal distance and in corresponding directions from the point of fixation and *in a plane at right angles to the plane of regard when that plane is in the horizontal direction and the head is in the pri-*

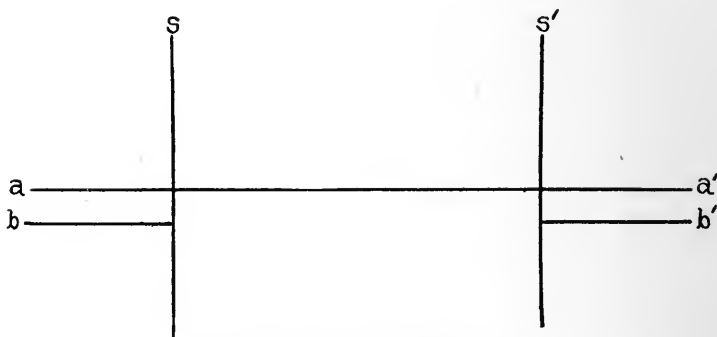

Fig. 64.—Volkman's Diagram.

mary position, fall upon corresponding points of the two retinas. *This does not indicate that the corresponding points for equal distances in the plane are, in the vault of the retina, at equal distances from each other.* Quite the contrary, these corresponding points must be variable, the variation depending upon the differential values of the angles formed by the direct line of sight and a line connecting another given point with the retina. Let us suppose the point of fixation to be removed 15 inches in front of the eyes, rather further than in Volkman's experiment, and in the median and horizontal plane. (Fig. 65.) Suppose also that the points *A, B, C*, etc., be at intervals of one centimeter each. These distances being equal, the distances of the points of the retinas at which the impressions would be received will be unequal. For each of the angles *ARB, BRC*, etc.,

are unequal. Moreover, the increments to consecutive angles are unequal, as it is plain from the text beneath the figure.

One of the conclusive proofs that retinal corresponding points are not at geometrically equal distances in the two retinas is that a

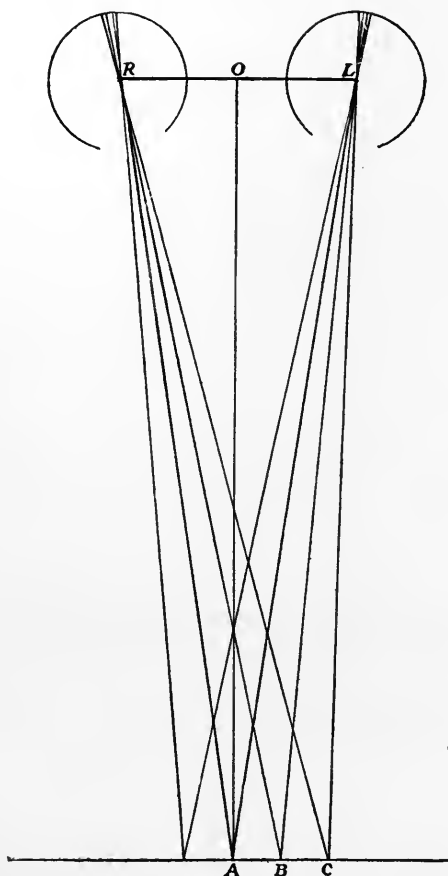

Fig. 65.—Let R and L be the nodal points of the two eyes and A the point of fixation. The points B , C , etc., are outside the point of fixation. Suppose

$$RO = 1.25 \text{ in.}, \quad OA = 15 \text{ in.}$$

$$\angle RAO = 4^\circ 45' 49''$$

$$\left\{ \begin{array}{l} \angle ARB = 1^\circ 53' 26'' \\ \angle ALB = 1^\circ 54' 5'' \end{array} \right.$$

$$\left\{ \begin{array}{l} \angle ARC = 3^\circ 46' 1'' \\ \angle ALC = 4^\circ 39' 58'' \end{array} \right.$$

The points corresponding to the incidence of the lines CR and CL are not thus equally removed from the maculas.

straight line drawn in the vertical or in the horizontal direction does not appear curved as it would positively do were the accepted doctrine correct. Hence the accepted view that the points of retinal correspondence are, by superficial measurement, equal, is incorrect. The ratios of consecutive pairs of increments cannot be simply stated, but may be determined by the method shown above.

Nevertheless there is a mental cognizance of relations of distances in space and distances on the retinal surfaces. They are recognitions of angular values rather than of equally removed spatial values on the retinas. In the section on the "Horopter" this view will be more fully developed.

New elements enter the problem when the eyes are in convergence with depression or elevation. In the case of depression the vertical meridians, by the act of adjustment, are caused to lean with the upper part of the meridian toward the temporal side and the lower part toward the median side. Hence, the lower parts of the meridians approach each other and the upper parts recede. Now, since a point in the lower portion of the field of regard is connected with the upper part of the retina by a straight line passing from one to the other, and since a straight line connects a point in the upper part of the field of regard with the lower part of the retina, it follows that if a point in space in the lower part of the field of regard is to be received at corresponding points of the two retinas, the lines leading from the point to the retinas will spread at a greater angle than will the lines connecting a point in space in the upper part of the field of regard. This lessening of the angle for the upper part of the field of regard and the increase of the angle for the lower part of the field would throw the upper part of the field of regard forward and draw the lower part backward, so that the plane of the field of regard would no longer be at right angles to the plane of regard, but would form with it an obtuse angle, which would increase in proportion to the convergence and depression. An opposite result would follow convergence with elevation of the plane of regard.

This very important principle becomes an element of the greatest moment in the investigation of the subject of the horopter.

Should the two eyes be directed to a given point so that the image of the point would fall at the two maculas it is evident that a certain number of other points in the common field of view would fall upon non-corresponding points. For example, should one look at a table, all of the legs and all of the angles could not fall upon corresponding

points simultaneously. The mind may not choose to take cognizance of any doubling of the images from these non-corresponding points. In the ordinary course of the use of the eyes no notice is taken of such phenomena. Just as one who is absorbed in listening to an eloquent address within a hall may not be conscious of the sounds of a brass band playing outside, although, if attention were to be directed to them, the sounds of the instruments might be distinct, so in the visual field impressions not directly conducive to the object of sight may be neglected or they may become indirectly important accessories to vision.

A very simple experiment will assist in making clear the statement that in the field of binocular view the greater number of objects are not seen singly.

If with one hand the person making the experiment holds a pencil at the distance of one foot directly in the median line in front of the eyes, it will appear as a single pencil. But if he holds with the other hand another pencil, in the same line and at two feet distance, the first pencil will appear double as soon as the gaze is directed beyond it to the second pencil. (Fig. 66.)

If the position of the double images of the first pencil is examined it will be seen that they are crossed, but if the gaze is again changed to fix the first pencil the second will appear double and the images will be homonymous.

Repeating the experiments in various ways it will be seen that if the eyes are fixed upon a point at a given distance all nearer objects in the same line and in many other lines, will seem, when the consciousness is directed to the phenomenon, doubled heteronymously, and more remote objects will appear doubled homonymously.

The diagram (Fig. 66) illustrates the position of the images of the more remote object when the lines of sight of the two eyes are fixed upon the near object. If the impression from the near object M falls upon the macula at m and m' , then the impression of the image of the object N will fall to the inner (nasal) side of the macula. Referring to page 167 it will be seen that the impressions thus caused cannot be united to form a single image. The two images will appear, each on the same side as the eye that receives it and at an angle with the line of vision directed to the near object, equal to the angle mon formed by the crossing of the lines as they pass through the nodal point. This would bring the images of the distant object at PP' , in the plane with the object M , at right angles

to the median plane. This is the theoretical position of these images. But there enters here another principle, a purely psychological one, which will be discussed in another section, by which the images are projected to the distance of the plane of the real object N . The images

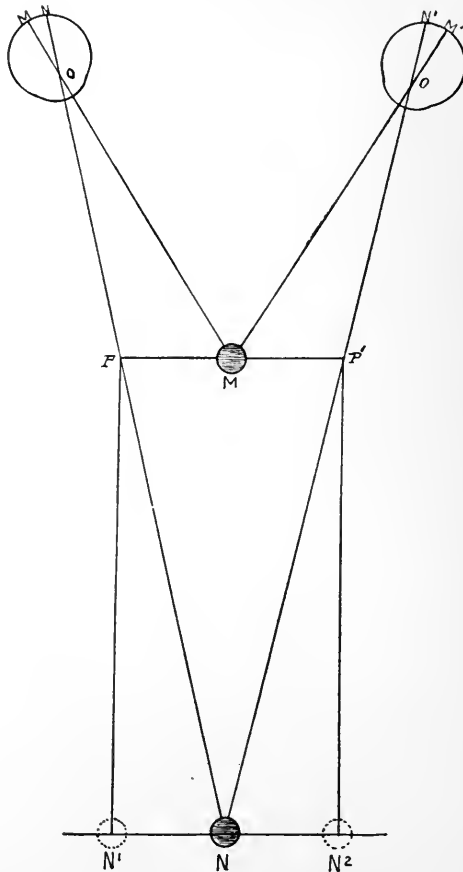

Fig. 66.

then appear at the distance of PM and $P'M$ removed in the lateral direction, and at the actual distance of MN beyond the near object.

When it is considered that in almost every field of binocular sight there are many objects and at various distances, it will appear, as has been already stated, that but a comparatively small number of

these objects, or these points in space, can fall upon corresponding points of the two retinas.

Are the images of these points or objects which are seen doubly mentally suppressed? Does the mind shut them out, refusing to take cognizance of them, or do they actually constitute an important, if not an essential, part of the physical impressions which unite to constitute the basis for a complete mental conception of the field of view?

Undoubtedly the latter contingency is the correct one, as will be more fully shown in the succeeding section.

We may for illustration of this introduce the experiences derived through another sense. The melody of tones is not derived simply from the uniform vibrations required to form sounds of certain pitch. We have, for example, the sound of the human voice repeated by the phonograph or the graphophone. The principal vibrations, the stronger, are repeated by the instrument. But the voice has lost its melody. The sounds of the machine are caricatures of the tones of the voice, without sweetness or melody, because the instrument fails to repeat the lesser vibrations, the under and over tones, which are characteristic in the voice itself.

So would it be could a method be devised by which only the parts of the field of vision in which images are received upon spatially corresponding points of the retinas would be recognized. The beauty of perspective and of the harmony of objects in the field of view would be absent, although the skeleton of the field of regard might remain. Experience of some persons subject to gradual atrophy of the optic nerve illustrates the principle, for when the field of view is much reduced they are unable to see their way to walk, though they may read letters directly in front of them at the standard distances.

The images which fall upon spatially non-corresponding points therefore serve an essential purpose. They serve as finders in the field of space. By means of these peripheral images not only are the eyes enabled to turn from one object to another and from one part of the same object to another part, but there is a mental estimate of their relative positions on the retinas, from which conclusions respecting the positions of objects in space are drawn. These processes, except for the presence of these images which some writers have supposed are mentally suppressed, could be effected by a series of trials and even then could be effected most imperfectly.

What has been said of single images when the impressions are located at corresponding points, and of double images when they are located at non-corresponding points, is then, in an important sense, a physical law, but, as it has been shown, there are circumstances which indicate that a higher law governs all these phenomena. It is the law of unconscious conclusions. Perhaps the psychologist might express the psychic process by some other term, but the term which I have used appears to me to express the actual process with sufficient accuracy.

If a person has a slight paresis of one of the superior recti muscles he may be able to bring the images to what would appear to be corresponding points, for there is neither lateral nor vertical displacement, yet the image seen by the affected eye appears beyond the other. It is customary to elevate the line of regard when looking at distant objects and to depress it for near objects. Since the effort to raise the affected eye to the given plane of vision is greater than for the other and greater than the life experience of the affected person has found necessary, its image is assigned to a more distant point.

Many examples might be cited to show that the purely spatial view of corresponding points is insufficient to explain all the phenomena.

Yet none of these examples furnish evidence that the mind shuts out any part of the impression made upon the retina, but all appear to me to point to a mental process which, taking cognizance of all the physical sensations, arranges them in logical relation to each other with a rapidity which is incomprehensible.

If the diagrams in the section on "Unconscious Conclusions" are examined with the aid of the stereoscope it will be seen that in each instance parts of the diagrams which by the law of Helmholtz could not be regarded as corresponding points in the visual field, are united as corresponding points in the mental conception of the form of the object.

Helmholtz himself introduces diagrams¹ to illustrate this principle, to which attention had been called by Wheatstone, the inventor of the stereoscope.

We may then sum up our conclusions respecting this subject in the following statement:—

Corresponding points are those points in the retinas which an-

¹ "Optique Physiologique," p. 960.

swer to proportional degrees of rotations of the eyes about their centers of rotation, and which, from given points in the plane of the point of fixation, receive incident rays which must pass through the nodal points.

They represent therefore the relation between the muscular and the retinal senses.

SECTION XXI.

THE HOROPTER.¹

Of all the subjects in physiological optics none has been thrown into greater confusion by conflicting views of different investigators and none has been surrounded by greater mystery than that of the horopter. Helmholtz, after devoting about ninety pages of his monumental work on physiological optics to the horopter, pages replete with experiments and with abstruse mathematical formulæ, evolved a theory which no other investigator could verify, even of the few who claimed to be able to understand it. With all this erudite labor and with all the enthusiastic interest of the great philosopher he worked out a single horopter of the infinite number which may exist, and even that one, being based on false premises, was absolutely faulty for well-adjusted eyes and entirely impracticable for any eyes.

It is, therefore, when all the divergent opinions are considered, not altogether without an appearance of justice, that so astute a man as Giraud-Teulon should have characterized the horopter as a "transcendental fancy."

"When," he says, "all the labor of determining the surface curve (fulfilling the geodesical condition of the horopter) was ended, it was discovered that this surface assumed the form of a *torus*. . . . It was not noticed that a table with four legs, a chair placed before

¹This section was read before the New York Branch of the American Psychological Association and the Section of Anthropology and Psychology of the New York Academy of Sciences, at Yale University, New Haven, October 20, 1903, and was printed in the *Psychological Review*, May, 1904. A few slight modifications and additions, taken from a paper read before the American Medical Association, in May, 1904, are here introduced, while some portions have been transferred to the section on "Corresponding Points" and another section.

us, were seen singly, although they certainly had none of the attributes of a torus."¹

Nevertheless the subject of the horopter or, to put it better, of horopters, is one of great practical importance. We may emphasize the expression and say that it is one of preëminent importance.

A horopter may be defined as consisting collectively of all the points in space whose images, with a given adjustment of the eyes, fall upon corresponding points of the two retinas.

Notwithstanding the view I have expressed of the notable rank which should be accorded to this subject, the general definition, as just given, is almost the only point concerning the phenomena of horopters on which investigators, those who have conceded a horopter, have agreed.

By some it has been described as a line, by others as a surface, and by Helmholtz, especially, as a most complex and quite incomprehensible combination of curves, planes, and straight lines.

Without entering upon the merits of Helmholtz's propositions that the horopter is "a line of double curvature produced by the intersection of surfaces of the second degree (hyperboloid to a nappe, cone, or cylinder)," that "it is a straight line and a curved plane of the second degree," etc., we may for a moment, without accepting the doctrine, consider the position of the horopter according to this philosopher when the plane of regard is directed to the horizon.

"In a single case only," says Helmholtz, "is the horopter a surface, it is when the point of regard is situated in the horizontal and median planes and at infinite distance. The plane of the horopter is then parallel to the plane of regard. . . . In the case of normal eyes thus directed toward the horizon the horopter coincides approximately with the ground on which the observer walks."

If we consider this proposition with care it will appear that if it were correct its accuracy would involve much ocular inconvenience. We do not look at the horizon when we walk. One who would hold the head erect and direct the eyes to the horizon would stumble often in his march. But, according to the proposition, if the eyes should be directed to the ground at a few feet in advance of the pedestrian he would bury his horopter beneath the soil, and all the objects in his pathway would appear, so far as a horopter is concerned, confused and indistinct.

¹"The Function of Vision." Translated by Owen.

I have taken so much space with an introduction in order that we may at the outset form an idea of the present state of the doctrine. Recurring to our definition, if a horopter is the collection of the points in space whose images, with a given adjustment of the eyes, fall upon corresponding points of the two retinas, it follows that horopters succeed each other in endless variety and with amazing rapidity. With every glance of the eyes, with the passing of the line of regard from one part of the page of a book to another, in fact, with every change of the head, of the body, or of the eyes themselves and with every degree of convergence a new horopter is developed. A horopter will be formed when the two eyes are so adjusted as to

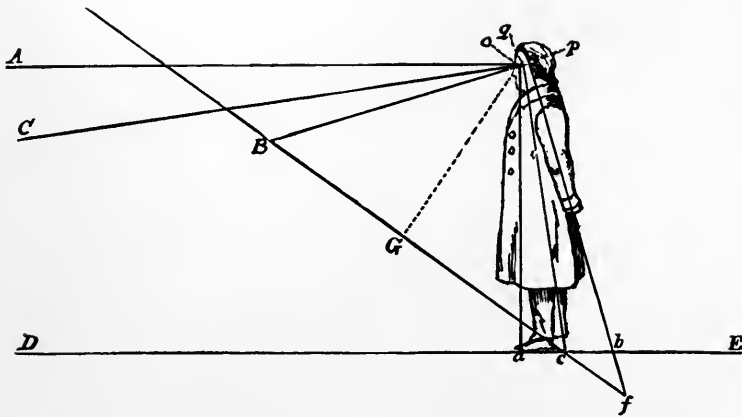

Fig. 67.—Helmholtz's Figure Indicating the Position of the Horopter when the Eyes are directed toward the Horizon. A, The Direction of the line of regard. DE, The Horopter.

enable the image of the point fixed to be located exactly at the maculas of the two retinas.

The innate impulsion to form a practically complete horopter with any given fixation is so imperious that only insurmountable obstacles will serve as a restraint.

Two tenets or conceptions constitute the essential foundation for the doctrine of the horopter. They are, the theory of the position and direction of the meridians of the retinas and the theory of corresponding points.

In respect to both tenets Helmholtz and most modern searchers

in this field have adopted views which have resulted in the confusion in which the subject has been involved. Before we can proceed to the phenomena of the horopter, then, it is essential to obtain a correct idea of these two fundamental theories.

We speak of vertical and of horizontal meridians of the retina. They are, like the meridians of the globe, imaginary lines, yet they have distinct relation to sight impressions. For example, let us suppose a horizontal meridian passing through the macula, the eye being directed straight forward and the head being in the primary position. The eye fixes a given point, the image of which is impressed at the macula. Now if another point at one side of this point of fixation is situated on a higher plane than the point of fixation, its image will be impressed at one side of the macula and below the horizontal meridian. It is unnecessary to consider in detail this doctrine, as we may assume an understanding of the general principles as they have been stated in the preceding section. Helmholtz, Volkmann, Hering, and other investigators came to the more or less uniform conclusion that the horizontal meridians were all parallel with the external horizon, but that the vertical meridians were only apparently vertical, and that they leaned out above and approached each other below. Helmholtz's experiments led him to the belief that the vertical meridians of each eye leaned out about $1\frac{1}{4}^{\circ}$. A number of investigators immediately found that their vertical meridians in each and every instance leaned out exactly $1\frac{1}{4}^{\circ}$.

My own researches led me to devise the clinoscope, which has become a most important and essential instrument in practical examinations of the eyes. One of the first things which the clinoscope did was to demonstrate that these leanings are natural defects—personal peculiarities—and that they vary with different individuals from one to many degrees; that the vertical meridian is at a right angle with the horizontal and that it is rare to find two persons in succession who record the same leaning. These leanings I have called *declinations*.

Abundant experience in the correction of these defects of declination have demonstrated beyond all reasonable doubt that the proper position for a vertical meridian is the vertical position.

That Helmholtz had what I have called a plus declination for each eye I am convinced. There is much reason, however, to believe that it was considerably in excess of $1\frac{1}{4}^{\circ}$.

Thus, Helmholtz included in his most elaborate mathematical

calculations his individual defects, which he assumed were physiological features common to mankind.

This was one of the fundamental errors.

The second foundation tenet is the doctrine of corresponding points of the retina.

The question of corresponding points has already been discussed in the preceding section, and it is only necessary here to recall our new definition of corresponding points as *those points in the retinas which answer to proportional degrees of rotations of the eyes about their centers of rotation, and which, from given points in the plane of the point of fixation, receive incident rays which must pass through the nodal points*. They represent therefore the relation between the muscular and the retinal senses.

This definition, while less easy to comprehend than it is to divide the retinas into squares of millimeters and point off so many to the temporal side of one and so many to the medial side of the other retina and call these corresponding points, has the advantage of being in harmony with the phenomena of vision.

As we have seen, the actual movements of the eyes about the rotation centers are not always essential to an estimation of the relative positions of objects in space. In the absence of the objective movement there is the subjective conception of the impulse required to induce a given movement. Recurring to the experiment of Dove, when the box is illuminated by the electric spark the image at the further end is seen singly, although, considering the position which the eyes would naturally have assumed, there should be double images.

In such a case, the consciousness of a single image for each retina and of its position external to the macula leads to the conclusion that a convergence of the eyes would be required to locate the image at the macula, and the extent of the required motion would indicate the angle of convergence and, therefore, the distance of the spark. Of course, there are other elements in this complex psychical phenomenon, but that mentioned is enough to suggest the course of the psychical process. It is such processes of unconscious conclusions that bring many points within the field of vision into a *subjective* horopter.

The subjective horopter is of the utmost importance and is governed by fixed laws. The physical horopter, including the points in space actually impressed at corresponding points of the two retinas, may be regarded as the skeleton, while the subjective horopter, includ-

ing points in space which are impressed at such points on the retinas as correspond to a demand for certain exact movements of the eyes necessary in order to place the image at the macula of each eye, constitute a mental assemblage of the lineaments of harmonic visual impressions. We may renew the comparison of this subjective horopter to the overtones of a musical sound. The fundamental tone is not pleasing; it is noise; it is the skeleton of the tone. But when combined with its multiplicity of overtones, which even the ear of the expert musician fails to differentiate, the musical tone finds its body and affords pleasure to the listener.

In the subjective horopter the consciousness of the required movements takes the place of the actual movements, as it does in the Dove experiment.

This doctrine of a subjective horopter does not by any means provide for a confused jumble of space perceptions, either in the retinas or in the mind. Every object in the subjective horopter is as much subject to the laws of angular valuation of muscular movements as are the objects in the physical horopter. We are to keep in mind the principle that while the image of a given point in space may fall on physically non-corresponding points of the retinas, a sub-liminal consciousness determines the relative positions of these two non-corresponding points to the maculae of the two eyes, and concludes on the impulse which would be demanded to make an actual adjustment for the macula were such movements to be executed; and it is this unconscious conclusion, based on accurate data, that places the object, singly, in its appropriate position in the field of view and at the proper distance relative to other objects in that field.

In our horopter, objects less distant than the point of fixation may still be within this subjective horopter, their images being impressed on the two retinas at points corresponding for the lines of incidence on one or other side of the macula. Then they will appear, as in the experiment of Dove, single. The principles controlling psychic phenomena in that experiment are, in this case, modified to meet the different conditions. Thus, a great number of objects within a fairly wide range may be brought within a perfect horopter.

If the direction of the gaze is changed while the head remains in the primary position a new horopter must be and is formed.

When the point of fixation is at infinite distance and in the median plane, all horizontal meridians are horizontal and all vertical meridians are vertical. So also if in the plane of the horizon the

point of fixation is brought nearer, the meridians maintain their original relations, and these relations will also continue if the eyes are directed upward or downward, provided the visual lines remain parallel. But if the point of fixation is at such distance as to demand convergence of the lines of regard, and if it is above or below the horizon (the head being supposed to be in the primary position), all horizontal and all vertical lines assume new directions. The eyes rotate on their antero-posterior axes. This form of rotation is, as we have seen, known as torsion. These torsional rotations are governed by fixed laws, and the general principle is known as the law of Listing.

Should the visual lines of the two eyes converge at the same time that the plane of regard is depressed the horizontal meridians of each eye will tilt downward toward the temporal side and upward toward the medial side. The vertical meridians will also tilt with the upper part outward and the lower part inward. The tilting is in every case in proportion to the depression and the lateral direction of the line of vision.

Accepting the two basic principles as they have been stated, and with an understanding of the laws of torsion, we are in position to examine the phenomena of the horopter, eliminating the mathematical intricacies of Helmholtz and substituting only simple calculations in plane trigonometry. It will not be necessary to inquire in detail into its form in many positions; three will suffice to illustrate the principles, and the details of only one of these need be given.

First, the observer directs the gaze toward the horizon in the median plane at infinite distance, the head being in the primary position. A horopter is formed at the distance of the point of fixation and it will be a plane surface at right angles to the plane of regard. Objects within or beyond the distance of the point of fixation will not be in the objective horopter, but may be in what we have termed a subjective horopter. They may be impressed on the two retinas and they will appear, as in the case of the spark or the figure in the Dove experiment, as single, the principles controlling the psychological phenomena in that experiment being here modified to meet these different conditions.

Second, if the gaze is directed somewhat downward and to a point a few feet in advance, as in the case of a person walking, the horopter will still be very nearly at right angles to the plane of regard, tipping forward slightly, since, although there is depression (a negative ascensional angle) of the plane of regard, the convergence (the

lateral angle) is so slight as to induce small torsional action and the principle of objective and subjective horopter may be applied as in the first case.

There is, also, at the lower part of the field of view a bending in of the horopter, so that more of the pathway is in the horopter than would be were it through its whole extent a plane.

Coming to the third case we may proceed in more mathematical detail.

Let us suppose the case in which the eyes are directed to the page of a book in the ordinary position for reading.

Assume that the gaze is directed so that the point of fixation is in the median plane, and that the plane of regard is depressed 35° . Assume also that the distance between the nodal points of the two eyes is $2\frac{1}{2}$ inches and that the convergence of the eyes (the lateral angle) is for each eye 5° . We have from these data to determine the distance of the horopter and its form and position relative to the plane of regard.

To determine the distance of the point of fixation (which will be in the center of the horopter field) we have the base, $2\frac{1}{2}$ inches, and the lateral angles, 5° . Taking one half the base and one lateral angle we have a base of $1\frac{1}{4}$ inches, a right angle and an angle of 5° to find the perpendicular or distance from the base line to the page of the book which is readily found to be 14.287 inches. (Fig. 68.)

The distance being ascertained by the formula $\frac{a}{b} = \cot A$, a being the base, 1.25 inches, A the angle opposite the base and b the distance sought. At this distance from the base line the image of the point of fixation will be exactly at the macula of each eye.

According to the law of torsions by this depression of the gaze and the convergence the meridians will have left the horizontal and vertical positions. Referring to the table of torsions found in Helmholtz's work¹ we find that for the ascensional angle of 35° and lateral angle of 5° the tilting of the horizontal (and of the vertical) meridians is $1^\circ 35'$. These conditions being given, what will be the relation of a straight line passing horizontally through the point of fixation across the page to the horizontal meridians of the retinas now tilted $1^\circ 35'$ from the actual horizon? A series of points in a straight

¹ "Optique Physiologique," p. 607.

line thus passing through the point of fixation must impress themselves along the horizontal meridian of each eye, otherwise the points will appear confused or double. But how can this series of points in a horizontal line be impressed upon the meridians which are tilted up toward the nasal side each $1^{\circ} 35'$?

It is a most interesting fact that the images of these points will in fact be thus impressed exactly along these tilted meridians of the retina, and it is precisely because these meridians of the retina are thus tilted that it is possible for the impressions to be made along the proper meridians.

Too much space would be occupied were we to enter upon a mathematical demonstration of this statement, but a little consideration by one familiar with the relation of lines and angles will show that in principle the statement is correct. A demonstration however

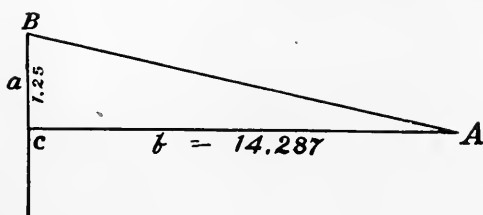

Fig. 68.—Angle $A = 5^{\circ}$, $\frac{b}{a} = \text{Cot } A$, $b = 14.287$.

would show that beyond a certain degree (10° to 20°) in the plane of regard a straight line actually appears to curve.

We come next to the more complicated question in respect to the position of a line running from the top to the bottom of the page. Will this line be at right angles to the plane of regard as the horizontal one is parallel with it or will it lean more or less toward or from the plane of regard?

We may select points above and below the point of fixation and determine their distance from the base line, and thus obtain the angle of the surface of the book to the plane of regard.

Take, first, a point 5° above and one 5° below the point of fixation. The distance of the point of fixation from the base line connecting the nodal points has already been determined at $14.28 +$ inches. In that case there was a lateral angle of 5° for each eye. Now, since the vertical meridian of the retina tilts out as it rises

above the macula this lateral angle will increase as the image is impressed above the macula and it will decrease in proportion to the extent that the impression is made below the macula. Before we can proceed, therefore, it is necessary to find the exact amount of increase and decrease for the selected points 5° above and 5° below the point of fixation, since our angle of convergence will increase in proportion to the extent to which the vertical meridian leans out from its original position exactly at the selected distance and decrease in proportion as the meridian leans in below the macula at the selected distance.

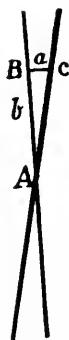

Fig. 69.—Angle $A = 1^\circ 35'$, $\frac{a}{b} = \tan A$, $\tan A = .02764$,
 $b = 5$, $a = 5 \times .02765 = 0^\circ 8' 52\frac{1}{2}''$.

We may find the extent of removal by the formula:—

$$\frac{a}{b} = \tan A; \quad \tan A = .02764,$$

$$a = 5 \times .02764 = 0.1382^\circ = 8' 52\frac{1}{2}'' \text{ (Fig. 69).}$$

In which b is the selected distance above or below the macula, a the required increase (or decrease) in the lateral angle and A the angle of $1^\circ 35'$.

This gives .1382 of a degree which is to be added to our lateral angle (angle of convergence), when we can proceed as in the first case to find the distance from the base line to the selected point below the point of fixation (Fig. 70), $\frac{b}{a} = \cot A$, in which b is the distance sought, a the base line, 1.25 inches, A the angle opposite a , $5^\circ.138$. From this we find that $b = 13.904$ inches.

To obtain the distance of the point above the point of fixation

we must subtract the $0^{\circ}.138$ ($0^{\circ} 8' 52\frac{1}{2}''$) from 5° , when by the same formula we find the distance to be 14.6976 inches (Fig. 71.)

We have now the distances

5° above the point of fixation.....	14.6976
At the point of fixation.....	14.287
5° below the point of fixation.....	13.905

Forming from these distances two triangles by joining the three lines at their extremities we have a line joining them and forming

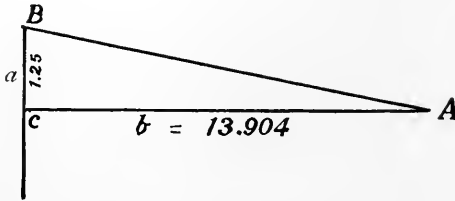

Fig. 70.—Angle $A = 5^{\circ} 8' 52\frac{1}{2}''$.

bases which represent a vertical line in the horopter at the level of the page of the book. (Fig. 72.)

The acute angle at this surface of the book for the upper triangle of these two is, $69^{\circ} 38'$. That of the lower triangle is $70^{\circ} 48' 50''$.

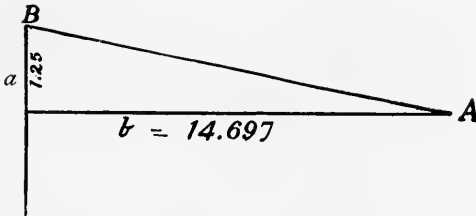

Fig. 71.—Angle $A = 4^{\circ} 51' 7\frac{1}{2}''$.

We have thus, in the space of 10° up and down the page, a curve of about 1° . In other words, the horopter in this direction is approximately a plane surface. If the calculation is carried to 10° each way, as in Fig. 72, equal to a space of about five inches on the page of the book, the result is nearly the same, but the curve is somewhat greater as we approach the periphery of the field of vision.

This gives us the position of the page in relation to the plane

of regard in which the horopter is most completely formed and we find that the page is tilted about 15° beyond the right angle with the plane of regard, or at about 105° . We have found only the direction of the horizontal and vertical meridians of the horopter, but any other meridian may be found in a similar manner.

An interesting and very simple experiment for those who are able to unite stereoscopic figures by convergence without the aid of a stereoscope beautifully confirms the above calculation.

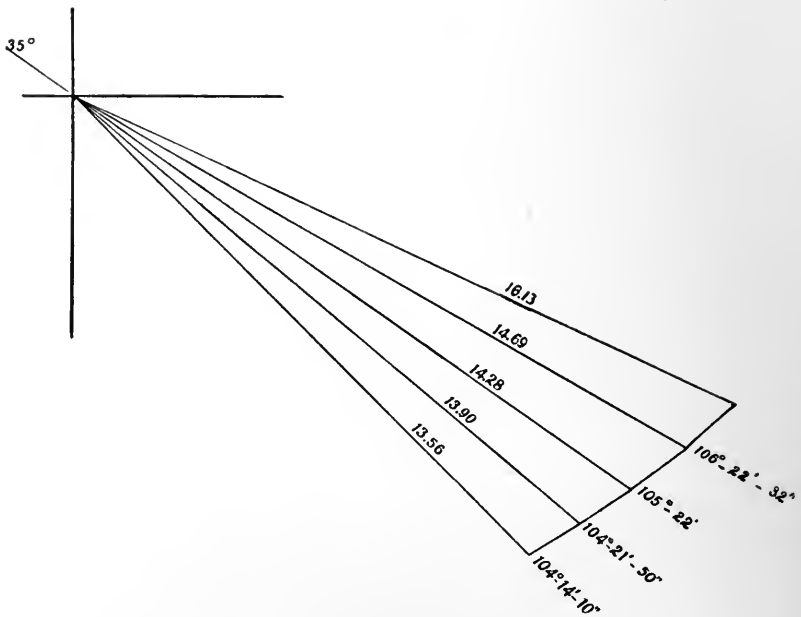

Fig. 72.

Draw two vertical lines parallel and at a distance of two and one-half inches from each other on a card board. (Fig. 73.)

Hold the card board so that in fixing the center of the lines the gaze is directed downward 35° . Hold the card board twenty-eight inches from the eyes.

One who is expert with such exercises will be able to unite the two lines at the distance of fourteen inches from the eyes.

If, instead of permitting a perfect union of the lines in the stereoscopic image they are held at about one-eighth of an inch

asunder it will be easy to find at what angle the board must be held to render the two stereoscopic images exactly parallel.

In my own case I find by numerous experiments and careful measurements that the board must be tilted forward as nearly as can be ascertained exactly 15° .

I have 1° of declination of the right eye, which would have little influence on the experiment.

Thus mathematical and experimental research lead to practically the same result in locating this horopter. By the formula given we may locate any horopter in the median plane. In other planes the formula will be modified.

Without discussing the application of these principles to space



Fig. 73.

perception, a field of much interest and in which many empirically known facts in art and in architecture may be analytically tested, only brief space remains to allude to the more practical application of the horopter.

All the discussion which has preceded has been based upon the assumption that the adjustments of the eyes are typical in the sense of being the most favorable to the function of combining the images of the two eyes in a horopter.

In real life anomalous conditions of adjustments, conditions which interpose difficulties in forming perfect horopters, are of extreme frequency.

These anomalous conditions may act as slight hindrances or they may prevent any but an imperfect horopter from being formed.

Let us consider some of these.

It has been seen that with a given depression of the plane of regard and a given convergence a horopter is formed in a position

which can be predicated when these two elements and the length of the base line between the nodal points are known. The depression of the plane of regard is controlled by an impulse which is not accidental or ephemeral, but which is automatic and uniform for different persons for the same depression under like circumstances.

Suppose a person whose eyes are so adjusted that with the minimum of impulse to the governing muscles they are directed 8° or 10° of arc above the plane of best adjustment. Among people of New England ancestry this is almost a characteristic, as it is with some other groups of people. It is not a disease, it is the normal development from a certain form of cranium.

Suppose again that this person takes a book in hand to read. He holds it in the position and at the distance which we have assumed for our third horopter. Is it not plain that this person must not only depress the plane of regard the 35° assumed, but that he must also induce an additional depression of 8° or 10° as the case may be?

This extra depression at once automatically induces a greater tilting of the meridians. No horopter can then be formed. To remedy the difficulty in a measure the person may throw the head forward 10° , but in so doing there is some disturbance of the equilibrium of the muscles, hence even with this concession the horopter, which will be better than before, may still be somewhat imperfect.

In several papers I have shown that as a matter of fact people with this adjustment of the eyes do throw the head forward and the bending of the neck is, other things being equal, in proportion to the excess of the normal upward direction of the eyes. We will return to this presently.

A second condition which may interfere with the formation of a horopter in the appropriate position is in direct contrast to this. The eyes may be adjusted so that the plane of vision is normally directed low.

Suppose one whose eyes are 10° too low. By the same reasoning as before we see that because the dynamic depression of the gaze would be less than in the typical adjustment, the tilting of the retinal meridians would be insufficient for the horopter, and such a person must force the chin high in the air in order to be obliged to depress the gaze sufficiently to induce the necessary torsion.

I have written of these conditions and writers have interpreted the difficulty as a strain on the muscles of depression or elevation.

This is an entire misapprehension. It does not follow that there is any considerable strain on the muscles of adjustment, but the head must be placed in position in which the automatic torsions shall in some measure correspond to the direction of the gaze.

A third form of hindrance to the constitution of the horopter is found in the condition which I have called declination.

This consists of an anomalous leaning of the meridians of one or both eyes. It is a very common defect and results in great perplexity to the adjusting muscles. Its practical importance is greater than those conditions already mentioned. It may induce, like the two conditions named, a throwing forward or a tipping backward of the head, or of the head to one side, depending on the direction, symmetry, or degree of the declination defects in the two eyes. All that has been said about the forward and backward holding of the head in the other conditions may apply to these cases, and in some instances the unnatural pose of the head and body from this cause are extreme. Since 1887 I have in various articles called attention to these unfavorable positions of the head and body, and as the knowledge of the nature of the anomalous adjustments has gradually developed, the relations between them and these abnormal positions of the body have been more clearly understood.

Recall the case of the person whose eyes are adjusted for too high a plane. The head is thrown forward as part of the automatic process of adjustment. The larynx is partly closed, the chest is sunken. Air passes less freely to the lungs than it would were the head held erect. It is among this class of people that consumption commits its ravages. There are few, if any, consumptives who do not have a high adjustment of the eyes or a form of declination which induces a corresponding head position.

Then there is the person whose eyes are adjusted for too low a plane and whose head is thrown back.

It is with this class of persons and with those whose declinations induce a similar pose that the occipital neuralgias, pains in back of the head and neck and in the lumbar region are principally found. The number of such persons is enormous and the suffering from this cause infinite.

From this cause also, the head being thrown back, the vertebral column often bends in toward the front, inducing not only the muscular pains just mentioned, but even a change in the cartilages be-

tween the vertebræ, thus inducing a chronic convexity of the spinal column.

Thus, also, when, to form a complete horopter, the head is thrown to one side, as it often is with hyperphoria, or with certain combinations of declination, there occur compensating directions of the body which induce lateral curvatures which, by long custom, reduce the energy of some muscles, while in others a state of unnatural tension becomes habitual, with the result of chronic lateral curvatures.

To such contingencies I long ago called attention, and it need only be said that the conditions above mentioned are only examples of the distinct effects which may and often do extend to the pelvis and to the extremities.

From declinations which do not induce false carriage of the head arise perplexities in adjusting for the horopter which result in headaches, dyspepsias, and a long array of nervous ills.

A subject whose importance cannot well be overestimated has been presented in this brief outline. It is worthy of the most careful research and minute attention.

Many of the nervous symptoms, pain, spasm, etc., which I at the time of the publishing of my work on "Functional Nervous Diseases" (1883) regarded as reflex are, in fact, direct results of muscular tension or of injury to or impairment of the functions of certain nerves as the result of the pose of the head or body, which is the result of unfavorable adjustments of the eyes, and sometimes from pressure upon or extension of nerves as a result of muscular tensions in the more immediate vicinity of the eyes.

Among nervous phenomena of the first class may be mentioned the habitual pains in the back of the head, that in the region of the spine of the seventh cervical vertebra, that under the angle of the shoulder blades, and also that in the lumbar region, which, for almost time out of mind, has in the case of women been attributed to organic displacements.

To these may be added the chronic pain often experienced in the shoulder, generally the left, running down the arm. So also we might add a number of forms of pain, spasm or impaired functional activity. Some of these symptoms, such as the pains in the muscles at the side of the neck, were correctly attributed to the tension on those muscles due to the carriage of the head to one side in hyperphoria.

Among the nervous manifestations of the second class may be mentioned a symptom which has interested me for a long time, and which I was confident must be a result of ocular maladjustments, since it regularly disappeared with appropriate treatment to these faults. I refer to the chronic and often severe pain experienced by many persons at the vertex of the head. This is a distressing symptom to a large number of persons.

I am now convinced that this pain is a manifestation of the pressure of the brows against the supra-orbital nerve as it turns over the border of the orbit and that the painful sensation is experienced, not at the point of pressure, but in the region of the distribution of the nerve.

It is easy to account for pains in the muscles more immediately surrounding the eye and the orbit, but the facial neuralgias which are not unfrequently the results of faulty eye adjustments are not so readily accounted for on this mechanical principal. A careful consideration will, however, enable one to locate the source of irritation in nearly all these cases, and I have no doubt that most of these facial neuralgias have for their original cause some pressure of or extension of nerves directly or indirectly from the efforts to adjust the eyes.

There are also much more distant and at first thought much less probable nervous reactions from these ocular causes which, while it is certain that they are in some way distinctly related to these ocular efforts, it is not so easy to trace the line of association. Many years ago, in my essay presented to the Royal Academy of Medicine of Belgium (1883), I mentioned dyspepsia, constipation, and irregularities in the action of the heart as among the distant manifestations of ocular conditions. That dyspepsia in various forms is, not occasionally, but generally, a manifestation of results of anomalous ocular adjustments, has for many years been, in my mind, an established fact. No less may be said of habitual constipation. These manifestations then must be either of reflex nature or a result of mechanical influence upon certain nerves.

Since my early observations of the pose of the head in relation to the adjustments of the eyes I have been struck by the very frequent association of dyspeptic symptoms with the condition of a depression of the planes of vision or with the corresponding pose of the head from declination. The cases are not by any means confined to persons with this pose of the head, but the large proportion of cases in which there is this association is most noticeable.

To account for this, from the mechanical point of view it is quite supposable that by reason of the relation of the pneumogastric nerve to the common carotid artery and the jugular vein as the nerve descends through the neck, lying between these two, one being in front, the other behind, a habitual position of the head in which it is thrown somewhat backward might induce a pressure by these two great vessels which might interfere with the conductivity of the great nerve, important branches of which are distributed to the heart and stomach.

This view is advanced as a possible hypothesis and not as an established proposition.

It would be less easy to trace the direct cause of the nervous disturbance in chronic constipation, but it seems, when these other facts are considered, quite reasonable to suppose that some similar mechanical cause may be suspected. The relation between the nervous condition and the adjustments of the eyes is in no doubt. It is not so evident through what channel the nervous relation is established.

It is not the purpose of this work to enter upon theories of disease, but this view of a mechanical origin of many of the symptoms which I previously

regarded as reflex appears to me to deserve a place in a work devoted to the motor apparatus of the eyes.

These views respecting the more purely mechanical effects arising from anomalous adjustments of the eyes do not disavow but are quite consistent with a belief in the reflex influence from the eyes. They indicate that some of the phenomena which were included in that belief are removed to another field, and it is not impossible that many other phenomena may at length be explained as the more direct and immediate influences of the motile apparatus of the eyes in adjusting for the horopter.

SECTION XXII.

THE DIRECTIONS OF THE APPARENT VERTICAL AND HORIZONTAL MERIDIANS.¹

COMPARISONS OF DATA REGARDING THE RETINAL MERIDIANS.

If the point of regard of the two eyes is fixed in the median and in the horizontal plane and at infinite distance while the head of the observer is in the primary position, it might be assumed that the vertical meridians of each retina would coincide with a plane perpendicular to the plane of regard, and that the horizontal meridian would coincide with the plane of regard.

In respect to a proposition so apparently simple and involving important questions, practical as well as theoretical, the views of the ablest investigators have been at variance. While Helmholtz concedes that the horizontal retinal meridians so nearly coincide with the plane of regard that they may be considered as practically identical with it, he characterizes the vertical meridians as "apparent" vertical meridians, and he reasons, from his own experiments and those of Volkmann, that these apparently vertical meridians, as a matter of fact, in normal eyes, converge downwards to the extent of $1\frac{1}{4}^{\circ}$ each, making thus an angle between the vertical meridians of the two eyes of $2\frac{1}{2}^{\circ}$, with the lower extremities of the meridians approaching each other.²

Basing his calculations on this proposition and on the law of Listing, Helmholtz³ deduced his remarkable demonstration of the horopter.

¹ My first exposition of this subject was published in Archives of Ophthalmology, No. 2, 1897, more at length than in this section.

² Nevertheless, Helmholtz concedes, incidentally, that others may not have the same inclination of the vertical meridians as his own. "Optique Physiol.," p. 732.

³ *Loc. cit.*, p. 900.

Meisner¹ also found, as he believed, a tilting of the apparent vertical meridians, but worked out a different theory of the horopter.

Hering² found a rolling of all the meridians of his own eyes and arrived at a conclusion that this was true of all eyes.

Le Conte³ thought that he had found the vertical meridians in his own case vertical, but his experiments were not so conducted as to be at all conclusive of his own position.

A subject of much physiological interest has been thus thrown into confusion by the variation of data from which learned investigators have drawn their conclusions.

All these divergencies of results and of opinions have arisen from imperfect methods of investigation, and generalizations have been based on the unwarranted assumption that each observer, without an examination of the adjustments of his own eyes, was able to say that what appeared to be a rule for him must also be a rule for all others with normal eyes, and by "normal eyes" was meant eyes which could see fairly well with proper glasses. It has been as though a surveyor had made careful triangulations of all the hilltops in view, but had neglected to locate the eminences from which the base line for his triangulations was made.

After the determination of an exact method for examining, the first necessity in an inquiry respecting the vertical meridians is an absolute understanding of the adjustments of the eyes of the observer. The fact that one sees well is only a single element in the problem. Is there a condition of declination, of heterophoria, of anophoria, or of katophoria? These and other questions in the same line are essential elements of the inquiry, and unless a statement of the conditions of the eyes in respect to each of these elements is included in the report of examinations in this field, observations have much the same value as the triangulations of the surveyor above supposed.

The question of the normal adjustments of the plane of regard of the individual with respect to the primary position of his own head when the minimum of nervous energy is directed to the muscles of the eyes, was not, previous to my own investigations, taken into account in the experiments of those who have interested themselves in the problems of corresponding points of the retinas and of the horopter, nor were questions of declination or of heterophoria.

¹ "Physiologie des Seeorgans."

² "Beiträge Zur Physiologie," p. 175; Archiv für Ophthal., Bd. xv, Abth., 1, S. I.

³ "Sight," p. 223.

In the section on the normal directions of the planes of vision in relation to cranial characteristics it will be shown that the eyes of many persons are normally adjusted much above the horizontal plane, that a deviation of 8° or 10° of arc above the horizontal plane is not very unusual, and that there is another large class of persons in whom the deviation of the plane of normal direction of the eyes is materially below the horizontal plane.

It need hardly be said that, in an investigation in which the law of Listing plays the principal rôle, such peculiarities must be taken into consideration, and that, in the absence of a due regard to the normal plane of direction as shown by the tropometer, there can be, as there have been, only confusion and results of uncertain value from the researches of investigators.

The requisites, then, for determining the actual position of the meridians, a suitable method having been chosen, are:—

1. A knowledge on the part of the observer of the adjustments of his own eyes in respect to heterophoria, anophoria, or katophoria, and especially in respect to the conditions known as declinations. Since the introduction of the clinoscope it is a matter of daily experience that anomalies in the directions of the meridians in individual cases are even more frequent than those anomalies which take the forms of heterophoria. It no more follows that because of such anomalies of declination it is impossible to arrive at a correct idea of the ideal position of the meridians than that, because of the anomalies of heterophoria, it is impossible to arrive at a just idea of orthophoria.

2. A means by which the exact position of the head may be maintained. The position described by Volkmann, Helmholtz, and others is inexact, uncertain, and irregular. Accurate data can hardly be expected in this field of inquiry when the position of the head of the observer is that which he happens to *think* at the moment is his primary position.

3. Examinations in this field of inquiry when the observer can see surrounding objects are of little if of any value. The instinct to correct a leaning of the meridians when surrounding objects would otherwise appear to lean is as great as the instinct to converge when the eyes are directed at a near point. Hence all objects but the test object must be eliminated from the field of regard.

4. When it is desirable to blend or compare test objects in the

field of regard of the two eyes as for the distant point, the blending or comparison should be made with the lines of regard of the two eyes *parallel*. This, of course, cannot be accomplished by the ordinary form of stereoscope, and it cannot be done when stereoscopic images are blended by converging the eyes without the intervention of the stereoscope.

All the conditions for physiological research in respect to the meridians when the lines of regard are parallel, are met by the clinoscope, which is described in the section on "Declinations."

In the practical work of the consulting-room, for examinations of anomalies of declination, the instrument is furnished with a single set of test objects which, in order that they may be always accurately adjusted, are not easily interchangeable with others. For the pur-

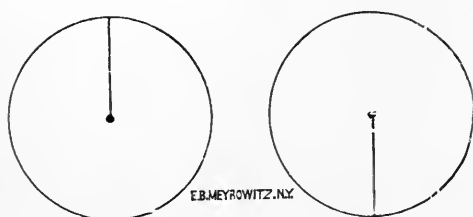

Fig. 74.—Clinoscope Objectives.

poses of physiological investigations the instrument is supplied with a number of these haploscopic diagrams and these can be multiplied at the desire of the investigator.

A modified instrument with short tubes, permitting convergence within a few inches of the eyes, has now replaced the older form, permitting examinations of a more precise character.

The pair of diagrams first represented (Fig. 74) is the pair in use for clinical purposes. It is also important in physiological research.

As the trained observer looks into the tubes the two discs blend and the two pins become one long pin with the head in the middle. When each pin is brought to the position that it appears to the observer to be exactly vertical and remains so, it marks the position of the vertical meridian of the observer's eye (except as it is controlled by automatic tension) as indicated by the pointer and scale above the tube for that eye.

Another pair of diagrams which is useful in testing the doctrine of Helmholtz, that the vertical meridians lean while the horizontal meridians are strictly horizontal, is shown at Fig. 75. Here both vertical and horizontal lines are included in the combined figure. In the discs themselves the lines represented here by black dots consist of series of faint red dots. The perfect union of both the vertical and horizontal lines, which can be effected by persons with good adjustments, would not confirm the view of Helmholtz.

As, by the aid of such diagrams the observer is enabled to unite the figures without the aid of convergence or divergence and without the aid of prisms or mirrors, and as the environments are so far shut out as to remove the suggestion of verticality and horizontality except as they are associated with the general muscular adjustments of the

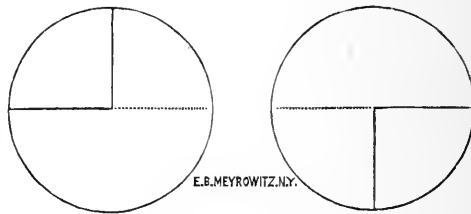

Fig. 75.

body, the experiments of Hering, Volkmann and Helmholtz can be made under correct conditions.

If the observer has found that his eyes are adjusted for a plane above the horizon, either the tubes of the instrument should be so adjusted as to allow for this amount of upward adjustment of the eyes or some other suitable provision, as, *e.g.*, the use of prisms or an allowance for the defect, is to be made. The rule holds when the tropometer shows an adjustment of the eyes for a plane below the horizon.

In respect to my own ocular adjustments, after a great number of examinations, continued through many years, I have failed to find even a slight degree of esophoria, exophoria, or hyperphoria; and the examinations made since the introduction of the tropometer have not shown that the eyes are adjusted for a plane either above or below the horizon. There is declination, right, $+1^\circ$; left, 0° .

Thus, experiments in my own case in regard to the direction of the apparent vertical meridians should be conducted with the tubes of the clinoscope directed horizontally.

When the question of a perfect union of exactly vertical and exactly horizontal lines simultaneously in the clinoscope is investigated, my own observations do not correspond with the results reported by Helmholtz, nor do I find that others who have no important errors of adjustments have any difficulty in blending lines which are exactly at right angles.

The well-known diagram of Helmholtz, representing the directions of vertical and horizontal lines, which he regarded as necessary for complete union in his own case, induces confusion of one or other sets of lines in my own experience and in that of all others with fairly good adjustments who have examined them in my presence, if the card is held in the primary position. But if the diagram is held so that the gaze is directed downward about 30° while I unite the two

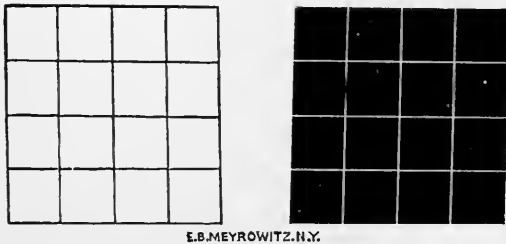

Fig. 76.—Helmholtz's Squares.

halves of the figure by convergence, the black and white lines coincide exactly.

All of my experiments, which have now been continued during several years, lead to the conclusion that the typical normal position for the vertical meridians is the exactly vertical position, and that the typical position of the horizontal meridians corresponds with the external horizon.

Deviations from these positions when the regard is directed in the primary position are anomalies, and are to be studied as such.

The passing of the meridians from the vertical and horizontal positions in making various adjustments of the eyes, is also a subject for study by itself.

The subject of the position of the meridians is treated at more length in my article which appeared in *Archives of Ophthalmology*, No. 2, 1897.

SECTION XXIII.

VOLUNTARY TORSION AND ITS PHYSIOLOGICAL EFFECTS.

When the eyes are turned to one side and upward or downward, there occurs also, as we have seen in the section on "Torsions," an apparent rotation on the optic axes. This peculiar apparent rotation of the eyes is not necessarily made as an independent movement, for it depends upon the passing of the eyes from one fixed position to another, and the consequent change in the relation of the cornea to the cranium.

But there is required in directions of the line of regard other than these oblique directions just mentioned, an actual turning upon the optic axes.

It is a fact long familiar to students of physiological optics that this power of torsion may be demonstrated in a number of ways, convenient among which is that of the uniting of linear figures with the stereoscope and giving to one of the figures a gradual turn.¹ The images will for a time continue united, but at length, when the rotation of the figure has been carried as far as the rotation of the eyes on the optic axes can follow, the images will separate. If, while the images of the two sides of the stereoscopic card are held united, but when the parallelism of the vertical lines is, to a considerable extent, lost, the observer closes the eyes for a moment and then opens them, the images will be seen double, with the vertical lines diverging above or below. After a little, the images may again adjust themselves and complete union may be re-established.

While the rotation thus demanded may be isolated from the movements with which it is usually associated, it is not, under ordinary conditions, possible to isolate the action of a single pair of muscles for its production.

As to the extent to which such voluntary torsion can be carried it is greater in convergence than in parallelism of the eyes. Hence, it is greater when the ordinary form of stereoscope is used for its determination than when the images of the two eyes are caused to blend without an instrument, or when some instrument is employed which does not, like the Brewster stereoscope, induce convergence.

For examination of the power of voluntary torsion the clinoscope

¹See foot note, page 201.

affords a means attended by a much greater degree of facility and of accuracy than any which has been suggested.¹ In using the instrument for this purpose the lines which cross but half the field are no longer useful, but straight lines, crossing the middle of the field and extending to its extremities (Fig. 77), are required.

If such lines are adjusted vertically and the two discs caused to blend and the tubes are then rotated, each in the positive direction (upper extremities of the lines outward), the mental conception of the position of the line formed by the union of the two is modified in an interesting manner. As soon as the tubes are thus rotated outward, the line, so long as it is held as a single line, begins to assume a direction approaching the horizontal. The lower extremity points in toward the observer and the upper extremity outward from the tube. If the observer has good powers of voluntary torsion, the line

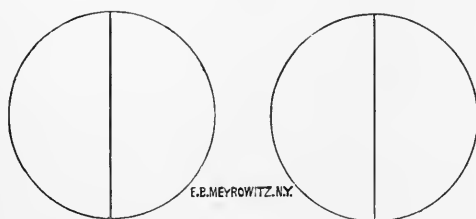

Fig. 77.—Torsion Objectives.

will at length appear to point almost horizontally and directly in and out, and to be materially elongated, as though an arrow were to be shot outward and slightly upward.

With a good power of such torsion, the lines may be held in union in the positive direction until each of the pointers marks 11° . Thus, between the vertical retinal meridians of the two eyes an angle of 22° , with its apex down, may be formed.

If the rotation is carried in the negative direction, a torsion of about an equal extent, or possibly 2° or 3° less, is induced, and, in this case, the line assumes again an approximation to the horizontal position, not pointing from within outward and upward, but outward and downward.

¹ In 1861, Professor A. Nagel investigated the voluntary rotations about the optic axis by experiments with the stereoscope ("Das Sehen mit zwei Augen," Leipzig). Later, by other methods, Helmholtz investigated the same phenomena. Neither of the methods was, for various reasons, exact, or could attain to any more than approximate results.

If one is able to induce with the clinoscope a torsion of 20° with the two eyes, he cannot (at least, this is true for the cases which I have examined), while maintaining the vertical position of one of the lines of the clinoscope, rotate the other to an extent equal to that to which the two were rotated. I find that with one line remaining vertical, I can rotate the other, either in the positive or negative direction, about 14° , which is, however, more than half of what I can accomplish with equal rotations of both tubes.

If the right tube remains with the vertical line at 0° and the left tube is caused to rotate outward, the combined image points outward, upward, and to the left. If the left tube is stationary at 0° and the right tube rolls out, the line points outward, upward, and to the right.

It is an interesting as well as an important practical fact, and one to which little if any attention has been given until my own investigations,¹ that horizontal lines cannot be held in union while being rotated from the horizontal direction to an extent nearly equal to that in which vertical lines can be held in union. If vertical lines can be held in union with a rotation of 20° or more, the horizontal lines usually become double, with a total rotation for both tubes from 6° to 8° . Indeed, it requires some practice to hold the lines in union with a rotation of each tube either out or in to the extent of 3° , inducing a torsion of 6° .

If the tubes rotate out, the line appears concave, bending outward at the center, or convex, according to the will of the observer. If the rotations are negative the line is convex or concave as before.

The fact of the difference in the ability to hold vertical and horizontal lines in union can be seen to constitute an important element in and to have a bearing upon experiments such as those by which Volkmann and Helmholtz investigated the directions of the different retinal meridians. For while there is an imperious mental necessity for holding the horizontal lines approximately so in order to unite the two images, a very considerable latitude is permitted in respect to the position of the vertical lines, and the torsional act may overcome an important deviation.

The principle holds in binocular vision in the ordinary uses of the eyes. The fact of difference in the case of torsion for horizontal and vertical lines has its practical application in many directions. A

¹"Directions of the Apparent Vertical and Horizontal Meridians of the Retina, etc." Stevens, Archives of Ophthalmology, No. 2, 1897.

single example may be introduced to serve as an illustration of this important principle. The question of the form and proportions of printed type, in order to produce the most easily legible characters, has long engaged those who are interested in the progress of the art of printing in its relation to the preservation of the functions of the eyes. Experience has, independent of any theory, taught practical men engaged in the art of typography, that the height of letters must be considerably greater than their breadth. In the ordinary type used in America and England the vertical length of all the letters of a line aggregates rather more than thirty millimeters to every twenty millimeters of the breadth of letters. In the French typography the height of letters is still greater. Examinations of different styles of typography will convince a careful investigator that broad, low letters are less easily held in perfect binocular union than the form more nearly approaching the Gothic style, and letters with a large proportion of horizontal lines are less easily recognized than those in which the vertical lines predominate. Thus, the letters *j*, *p*, *d*, and *w* are recognized more quickly than *e*, *a*, *s*, and *c*.

SECTION XXIV.

THE NORMAL DIRECTION OF THE PLANES OF VISION IN RELATION TO CERTAIN CRANIAL CHARACTERISTICS.¹

In regard to the ability of the eyes to rotate in the vertical direction, I have found that, under the best conditions, the full extent of the excursion amounts to about 83° of arc, and of this excursion about 50° is below the horizontal plane and about 33° above it. Of this adjustment, since it induces no torsional effect when the lines of regard are in the plane of the horizon, and does not unduly increase the torsion in convergence with depression of the plane of regard, since it exercises no unfavorable influence in inducing either lateral deviations or tendencies toward deviations, and since also practical experience has shown it to be the most favorable to the continued use of the eyes, it may be said that these rotations are associated with the typical position of the normal plane of vision.

If the total excursion of the eyes remains of about the same extent

¹ The principles discussed in this section were first announced in my paper in the Archives of Ophthalmology, No. 3, 1897.

(83°), but if the ability to rotate them upward is materially greater than 33°, that is, if it equals or exceeds about 37°, while the downward rotation is restricted to a corresponding extent, the normal visual plane is directed so high that at the horizon a slight outward torsion is induced. A failure to rotate the eyes up to the extent of, say, 30°, while the downward excursion is increased, indicates a depression of the normal plane of vision. It will be observed that a margin of about 3° on the side of a restriction of upward rotations is regarded as within the possible limits of the most favorable condition. In many cases this allowance appears to be too great and a failure of rotation up to at least 32° appears to induce mechanical effects which in practice are manifested in asthenopic or other nervous disturbances.

A somewhat greater limit in respect to an excess of upward rotation appears to be within the extent of typical rotations. Practical experience, however, proves that beyond a rotation of 37° in the upward direction a distinct torsion is induced in directing the gaze in the primary position.

In order to obtain exact and uniform measurements of the excursions of the eyes, the head of the person observed is to be placed and maintained during the examination in a position such as is indicated on page 226, where the conditions for examining by the tropometer are described.

Very soon after bringing the tropometer to its present state of adaptability to its purpose, and learning something of the peculiarities of ocular rotations from more critical methods than had hitherto been employed, it became evident that certain peculiarities in the excursions of the eyes, in the vertical direction especially, were, as a rule, associated with certain types of the cranium. The more attention was directed to these coincidences the more certain did it appear that there was, in this relation, an important law which would well repay more than a casual thought.

As investigations proceeded, it was found that three classes of ocular conditions were in close relation with the three great types of crania recognized by anthropologists and craniologists, and that the facial angles also, with some modification from the usual rules of craniologic measurements, serve as indications of directions of the eyes in passive adjustment with reference to the horizon.

In order to obtain a clear conception of this law, so far as it has been developed, some knowledge of the types of the cranium and of some of the angles of the face is requisite.

Craniologists classify skulls as *dolichocephalic* (long skulls), *mesocephalic* (medium skulls), and *brachycephalic* (broad skulls). The diagrams (Figs. 78, 79, and 80) give a general outline of these forms of the skull when looked at from above.

The basis for the classification consists of the proportion which the longest diameter from before backward bears to the longest transverse diameter. If the transverse diameter is $\frac{75}{100}$ that of the longer diameter or less than $\frac{75}{100}$, the head is said to be in the class of long heads; but if the transverse diameter equals or exceeds $\frac{85}{100}$ the length of the skull, it is a broad skull. Medium skulls, or, as we may call them, tall skulls, are those in which the transverse diameter is between $\frac{75}{100}$ and $\frac{85}{100}$ of the long diameter, and, as might be supposed, the measurement from the base of the skull to its summit, while



Fig. 78.—The Long Head.

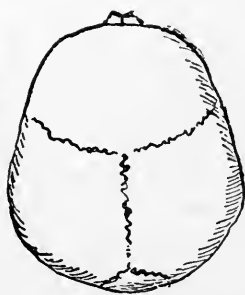

Fig. 79.—The Tall Head.

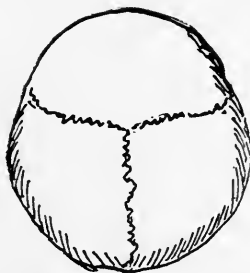

Fig. 80.—The Broad Head.

it may not of itself be greater in an individual case than that of one of the long or one of the broad type, nor even so great, is greater in proportion to the other measurements.

In typical heads belonging to any one of these types the outline of the face is likely to be characteristic of the type. Thus, the general outline of the face from the line of the brows to the tip of the chin as seen from the side differs, as a rule, according to the type of the cranium. Associated with the long cranium there is generally a convex facial outline, while a side view of the face of one from the class of tall heads shows usually very little or no curve. On the other hand, the face of one from the class of broad skulls is likely to show a concave line.

The next series of figures (81, 82, 83) gives an idea of the general form from a side view of each of these three types in the living subject.



Fig. 81.—The Long Head.
Facial Angle $+10^{\circ}$.

Fig. 82.—The Tall (Medium) Head.
Facial Angle 0° .

Fig. 83.—The Broad Head.
Facial Angle -10° .

To nearly all general laws affecting the form of the human body, there are exceptions, and the rule just stated is not absolutely uniform in its application. However, the type of head and the outline of face

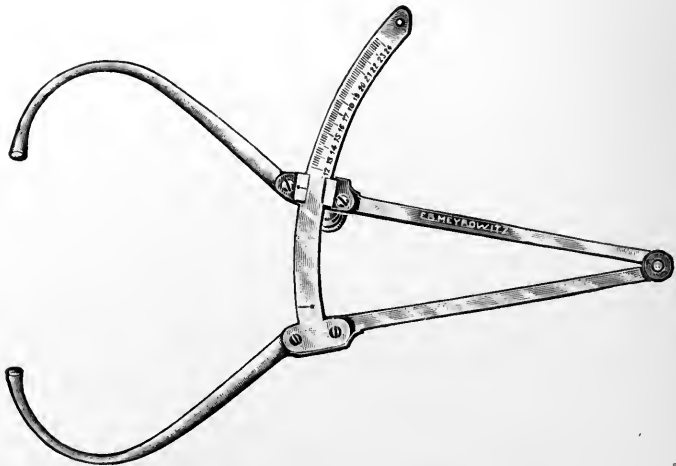

Fig. 84.—Broca's Calipers.

are generally in the relation shown by the diagrams, and the general fact may be thus stated: With the long skull the angle of the face is

high; with the medium or tall skull there is a low angle or none, while with the broad skull there is a negative facial angle.

By referring to the notes below the figures, it will be seen that the upward rotations of the eyes are quite different in these cases, and the rotations recorded under the figures fairly represent that which may be expected in association with a head belonging to the particular class, while there may be individual differences.

The transverse and longitudinal diameters of the head are determined by the calipers of Broca (Fig. 84), and the angle of the face by the facial goniometer which I have devised (Fig. 85). In using the calipers the bulbs are placed at the broadest interparietal diameter

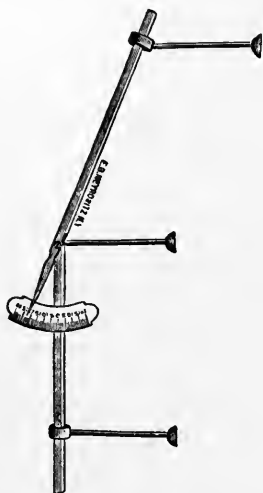

Fig. 85.—Author's Facial Goniometer.

for the transverse measurement, and on the glabella in front and at the occipital protuberance behind for the long diameter. In determining the facial angle the upper foot of the goniometer is placed at the glabella, the center foot at the depression immediately below the nose and the lower foot at the point of the chin, the teeth being naturally closed.

The direction of the normal visual plane to the type of the cranium in each of the three classes may be arrived at by direct and by indirect methods.

In the case of the living subject, the dimensions of the head may be taken and the plane of vision established in the same individual.

The determination of the plane of vision in the living subject is accomplished through the aid of the tropometer. The relation is thus established by a direct method.

The indirect method is that of ascertaining the direction of the imaginary line constituting the axis of the orbit in the prepared skull, the measurements of which are known. The orbits are more or less cone-shaped. If the extreme apex of the cone, at which the optic nerve enters it, is taken as one point of the line of the axis, and a point where two straight lines, drawn at nearly right angles with each other from certain parts of the circle of bone constituting the outer border of the orbit, cross is taken as another point in the line of the axis, the line which would pass through these two points would represent the axis. This imaginary line, if projected forward and beyond the orbit, would

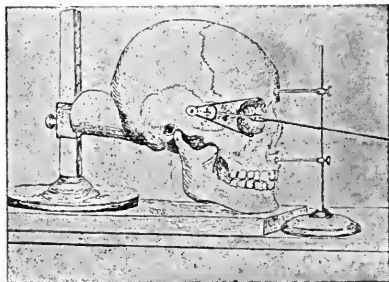

Fig. 86.—The Author's Method of Determining the Axis of the Orbit.

be seen in most cases to point somewhat downward, the skull being in the primary position, and in some types of skulls it points much more downward than in other types.

To maintain the skull in the correct position I have devised the apparatus shown at Fig. 86. The standard in front carries two bulb-bearing movable bars. One of these bulbs, the upper, is in contact with the glabella, the other with the depression below the nasal spine. Thus the skull is in a position corresponding with that of the head when the rotations are being determined by the tropometer.

It is interesting to find that the pointing of the imaginary line representing the axis of the orbit closely corresponds with the observations on the normal visual plane in the living subject.

The interest is more considerable when it is found that the form of the orbit in the different classes of skulls offers an explanation of

the peculiarities in the direction of the orbital axis, as well as of the normal plane of vision.

Figs. 87, 88, and 89 represent the front views of skulls of the long, tall and broad types respectively, showing the form of the orbit corresponding to each type. It will be seen that in the long skull (Fig. 87) the roof of the orbit is much lower than that of the tall skull (Fig. 88), and that the lower border extends more downward. The orbit of the tall skull is not only placed with its opening higher, but it is more narrow from side to side. In the case of the broad skull (Fig. 89) the roof of the orbit is low like that of the long skull, but the lower border does not extend so far downward and the direction of the transverse diameter is more oblique.

Measurements of the direction of the axis of the orbit in these three classes show that in the long skull the direction is usually quite



Fig. 87.

Front View of Long
Skull:



Fig. 88.

Front View of Tall
Skull:



Fig 89.

Front View of Broad
Skull:

low, that in the tall skull it is much higher, and that, while the axis of the broad skull is lower than that of the tall one, it is scarcely as low on the average as in the case of the long skull; and these comparative positions of the axes of the orbits in the prepared skulls correspond remarkably with the positions of the visual plane in the case of living subjects with heads of corresponding types. That is, the visual plane of the long head is low, of the broad head also low, and that of the tall head is high.

In the investigations which I have made I have found that while in mesocephalic skulls the axis of the orbit sometimes is higher than the plane of the horizon, the average of such skulls shows a slight depression. This depression in 22 mesocephalic skulls amounts, on

the average, to about 3° . In dolichocephalic skulls (index 78° and under) the axis of the orbit is directed below the plane of horizon from 5° to 15° , the average of those examined by me being 7° or 8° of depression. In brachycephalic skulls the orbital axis is also directed downward, but less, on the average, than in the case of the dolichocephalic. Here the depression of the axis ranges in general from 4° to 12° , averaging 6.5° . In two cases the axis has been elevated above the horizontal plane, but in these the head was very high in proportion to the length.

Notwithstanding the apparent simplicity of these relations of the form of the orbit with the type of the skull and of the direction of the visual plane to the type of cranium, there are, in practice, certain modifying features, principal among which is the facial angle already referred to.

Taking into consideration that even in the case of the mesocephalic skull the average orbital axis is rather below the horizon, and considering also that of the 83° of rotation only 33° to 37° are, in the best condition, above the horizon, it would seem that the most favorable position for the normal visual plane would not be exactly at the horizon, but slightly below it. In the use of the eyes the plane of regard is generally depressed and rarely elevated.

The form of the orbit is such that less freedom of rotation might be expected in the upward field than in the downward. Allowing for this, the difference is so considerable as to suggest a plane most favorable for the normal visual plane somewhat in conformity with the direction of the orbital axis.

Experiments made with the clinoscope have indicated clearly that the visual plane cannot be more than about 3° below the horizon, as shown by the restriction of upward rotation without inducing torsion; hence, with a latitude of from 32° to 37° of upward rotation we shall find the normal plane of vision within the limits of the best position.

The results of examinations, commenced in 1896 and extending up to the present time, and including a great number of cases, may be briefly summarized as follows:—

The normal plane of vision is rarely coincident with the horizon or within 3° below it, but is much more frequently elevated materially above it or depressed materially below it. In a large majority of cases after the subject of the examination has had sufficient practice to bring the elevator and depressor muscles fully into action, the

upward vertical rotation either falls below 30° or exceeds 37° . There is thus an interval of about 5° to 7° in the records of upward rotation within which the limit of excursion is more rarely found than above or below it.

In the class in which the upward rotation exceeds 37° it is most frequently about 40° , but may extend to 50° , or even more. In the class in which the upward rotation fails to reach 31° , it is most likely to reach from 28° to 30° , but may fall as low as 15° in eyes which are normal and in which the flexibility of youth and every accessory condition would seem favorable.

These facts may be compared with the remark of Benedikt¹ that in the measurements of a great series of skulls he has not found a case of orthognathism (one in which the facial angle is 0).

In mesocephalic heads with a very low facial angle (orthognathism) the rotation is usually high, with a corresponding restriction of the rotation downward. For example, if the upward rotation is 40° , the downward is limited to 40° , or perhaps 45° . If the head is quite high in proportion to its length, the upward rotation is likely to extend in proportion to the index of height of the cranium. A glance at Fig. 88 will help to understand the reason for this excess of rotation upward in this class of heads, for with the vault of the orbit extending upward to a greater extent than in the other types of the skull, there is space for this movement to be made without the restriction which exists in the other types. But since the lower floor of the orbit is also higher in this type, the downward rotation is of less extent. The axis of the orbit, as has been shown, in this type of skull points higher than in any of the types and the normal visual plane is higher than the plane of the horizon.

In long heads, especially long heads with a high positive facial angle (Fig. 80), the rotation upward nearly always comes short of the standard and the downward rotation exceeds 50° . Again, a reference to Fig. 87 shows the physical limitation of the upward rotation in the low vault of the orbit and of the extended rotation down in the lower plane for the floor of the cavity. The orbital axis points, with this type of skull, lower than with either of the others. The plane of vision is nearly uniformly below the horizon.

A glance at the figure of the broad (brachycephalic) skull will also show why the upward rotation of this type of head is restricted,

¹ Benedikt: "Kraniometrie und Kephalmetrie." Wien und Leipzig.

but it will also be seen that with this restriction upward there is a limitation downward, for the lower floor of the orbit approaches much nearer to the upper than it does in the long skull, and is, in fact, as high as that of the mesocephalic skull. In practice it is found that the upward rotation of a person with this type of head is usually about or less than 30° , while the downward rotation seldom equals 40° .

These peculiarities in the type of the head, and consequently in the form of the orbit, have a very practical bearing upon the adjustment of the eyes. If the plane of vision is normally situated coincident with the horizon when the head is in the primary position then (in the absence of other anomalies) with every adjustment for convergence with depression there occur the torsions exactly according to the law which has been shown. But if the normal plane of vision is directed above the horizon, then torsions must already occur before the visual plane coincides with the horizon, and when depression is effected, the torsions are excessive and the horopter is not formed. So also when the visual plane is normally depressed, the horopter is not formed at the point of regard, since the depression demanded of the eyes is less than the depression of the line of regard from the horizon. In either case there is confusion, which must be corrected by adjustments which are not automatic. In nearly all such cases the subject of the condition makes a compensating adjustment by the head. Thus, if the visual plane is normally elevated he carries the head forward so as to depress the orbital axis. The forehead is advanced beyond the position to which it would otherwise come. This influences the habitual pose of the body and the walk of such a person. On the other hand, if the plane of vision is depressed normally, the person subject to the condition is in nearly every case accustomed to throw the head back from the most natural pose. His usual bodily pose, his gait, and appearance are modified by the direction of the orbital axis.

In another section in which the applications of the principles of these special ocular adjustments are treated (Section XXX) this question of the horopter in its relation to the elevation or depression of the visual planes will be discussed from the practical point of view. It is sufficient here to say that these conditions are of great importance, and without a knowledge of them there can be no adequate understanding of the horopter or of the anomalies of the eye muscles.

It will be observed that more importance has been assigned to the rotations in the vertical than in the lateral direction. A careful con-

sideration of the principles discussed in the previous chapter will account for this. It will be seen, when these principles are recalled, that with a greater or less action of the muscles which rotate the eyes from side to side, torsions are not influenced, while even a moderate action of either the elevating or depressing muscles induces torsions and thereby influences the position of the horopter.

This most important principle is to be considered in all investigations of the anomalous actions of the eye muscles.

PART III.

ANOMALOUS CONDITIONS OF THE MOTOR MUSCLES OF THE EYES CONSISTENT WITH THE PHYSIOLOGICAL STATE. CLASSIFICATION AND EXPOSITION OF THE CLASSES.

SECTION XXV.

SYNOPSIS OF THE CLASSIFICATION.

In this classification will be included:—

1. The relation of the normal visual planes to the cranium.
2. The relation of the vertical meridians to the cranium.
3. The relation of the visual lines to each other.
4. Spasmodic affections of the eye muscles from functional causes.

*Class I.—Relations of the Normal Plane of Vision of the Individual to the Cranium.*¹

The head being exactly in the primary position, the *normal plane of vision* may be, with the minimum of nervous energy directed to the adjusting muscles of the eyes, located in a plane coincident with the plane of the horizon or not more than 3° to 5° below or above it. This state of adjustment, in order to distinguish it from the other adjustments of this class and from orthophoria, of Class III, may be called *euthyphoria*.

Of this first class there are five kinds of adjustments.

1. EUTHYPHORIA.—A passive adjustment of the normal plane

¹ The description of the conditions of this class and the terminology were first published in *Annales d'Oculistique*, April, 1894, from proceedings of British Medical Association, 1893.

of vision such that this visual plane is coincident with the plane of the horizon, or very nearly so.

2. ANOPHORIA.—A passive adjustment of the normal visual plane at an angle distinctly above the plane of the horizon.

3. KATOPHORIA.—A passive adjustment of the visual plane at an angle distinctly below the plane of the horizon.

4. ANOTROPIA.—An adjustment in which the visual line of either eye deviates upward when the other is in fixation.

5. KATOTROPIA.—An adjustment in which the visual line of either eye deviates downward when the other is in fixation.

Class II.—Declinations of the Retinal Meridians.

RELATIONS OF THE VISUAL LINES OF THE TWO EYES TO EACH OTHER.

Class III.

FIRST DIVISION.¹

Adjustment of the Directing Muscles of the Two Eyes by Which the Two Visual Lines May Be and Are so Related that Binocular Vision is Habitually Maintained.

The generic divisions of this class are:—

1. ORTHOPHORIA (ὀρθός, right; φορά, a tending).—A tending of the visual lines in parallelism, the determination being made for a point not less than 6 meters distant.

2. HETEROPHORIA (ἕτερος, different).—A tending of these lines in some other way, the determination being made for a distant point, as above indicated.

The specific conditions of heterophoria are:—

1. *Esophoria*.—A tending of the visual lines inward (or toward each other).

2. *Exophoria*.—A tending of the visual lines outward (or away from each other).

3. *Hyperphoria*. (right or left).—A tending of the right or of the left visual line in a direction above its fellow.

¹The classification and terminology of this Division were first published in Archives d'Ophthalmologie, November, 1886; New York Medical Journal, December 4, 1886.

*This term does not imply that the line to which it is referred is too high, but that it is higher than the other, without indicating which may be at fault.*¹

Tendencies in oblique directions are expressed as:—

4. *Hyperesophoria*.—A tendency of one visual line above the other with a tendency of the lines inward.

5. *Hyperexophoria*.—A tendency of one visual line above the other with a tendency of the lines outward. The designation “right” or “left” must be applied to these compound terms.

Class III.

SECOND DIVISION.

Adjustments by which Binocular Vision is not Habitually Maintained.

HETEROTROPIA (*τρέπειν*, to turn).—Deviations of the visual lines consistent with a physiological state of the motor muscles and nerves.

This class includes anomalous conditions in which, the visual line of one eye being directed to the distant point as above indicated, and, in general, to any point in the field of regard, the visual line of the other eye is directed to some other point.

The specific divisions in this class are:—

1. *Esotropia*.—A deviation of the visual lines inward.

2. *Exotropia*.—A deviation of the visual lines outward.

3. *Hypertropia* (right or left).—A deviation of one visual line above the other.

4. *Hyperesotropia*.—A deviation of one visual line inward and above the other.

5. *Hyperexotropia*.—A deviation of one visual line out and above the other.

When these conditions exist associated with the usual physiological state of the eye muscles the terms which have been in common use are, for *heterotropia*, concomitant strabismus; for *esotropia*, converging concomitant strabismus; for *exotropia*, diverging concomi-

¹ Hence there can be no necessity for a term to indicate that one line is lower than the other, since that follows as a matter of course. The attempts to force a redundant term in this connection indicate a confusion of mind in respect to the meaning of the term *hyperphoria*.

tant strabismus, and for *hypertropia*, strabismus sursumvergens, or strabismus deorsumvergens. For the compound conditions no specific terms have been used.

Class IV.—Spasmodic Affections from Functional Causes.

NYSTAGMUS.

SECTION XXVI.

EXPOSITION OF THE CLASSES.

Class I.—Relations of the Normal Plane of Vision of the Individual to the Cranium.

ANOPHORIA AND KATOPHORIA.¹

(This section should be read in connection with Section XXIV.)

In the preceding part of this work it has been shown that the relations of the normal plane of vision to the cranium constitute important factors in the associated use of the eyes.

It has been stated that with a person having a rotation of the eyes from the horizontal plane upward of from 32° to 37° and a downward rotation of 50° , the head being in the primary position, the plane of the least torsional effect is at the horizon. A person of quick perceptions and who is practiced with the clinoscope having these rotations may, if the clinoscope is pointed exactly in the plane of the horizon, find a certain degree of leaning of the vertical meridian of one of his eyes or of each of them. Taking note of this, which after a number of examinations he will consider his personal peculiarity (declination), he will find that by changing the direction of the tubes of the clinoscope this permanent factor is modified. Let us now suppose that the person with the rotations mentioned finds, declination, R. $+ 1^{\circ}$, L. 0° . If the tubes are directed upward from the horizon 5° the leaning of the meridians outward will increase,

¹ Stevens: *Annales d'Oculistique*, April, 1894; a paper read before the British Medical Association at its session, 1893.

bringing the declination to perhaps R. $+ 1\frac{1}{4}^{\circ}$; L. $+ \frac{1}{4}^{\circ}$. If he now causes the tubes of the instrument to point down (the head being always in the primary position) the leanings out will again increase. Thus, the minimum leaning of the meridians for this person will be practically at the horizon.

If a person with a greater upward rotation, say of 40° , after having carefully determined the leanings of the meridians at the horizon, points the instrument up 5° , the outward leanings, if there are any, will decrease. But if the tubes are made to point up again 5° , that is, in all 10° , the leanings out will again increase. Thus, for a person with this rotation the plane of least deviation of the meridians is not at the horizon but above it.

When the normal plane of vision is at the horizon no torsion occurs in that plane.¹ When the normal plane of vision is above the horizon there is torsion in the horizontal plane, but none in a certain plane above. In like manner if the normal plane of vision is below the horizon then the plane of least leaning out of the meridians of the eye is below the plane of the horizon.

By facts of this kind it has been found that with a rotation of the eyes up from the horizon from 32° to 36° or 37° , and with a downward rotation of from 45° to 50° , the plane of normal vision for the individual is practically at the horizon. If the upward rotation materially exceeds this the normal plane of vision is above the horizon, and, if it is materially less, this plane is below the horizon.

It is thus seen that as a result of various positions of the plane of vision horopters are not uniformly formed for different persons, and experience shows that the most favorable position for the normal plane of vision is at the horizon.

It is now known that anomalous muscular conditions which have been supposed to be quite independent of any influences outside the muscles apparently directly affected or of the nerves controlling these muscles are, in fact, not unfrequently manifestations of unfavorable relations of the normal plane of vision to the cranium.²

Only a small proportion of persons appear to have the normal

¹ The word *torsion* must not be confounded with *declination*, which is another condition.

² The important fact that when the normal visual plane does not coincide with the horizon disturbances of the harmonious actions of the muscles govern-

visual plane exactly at the horizon. In this respect examinations by the tropometer and clinoscope appear to be in harmony with the observations of craniologists.

ANOPHORIA.

Referring to Section XXIV it will be seen how, with the type of cranium, the axis of the orbit varies, forming an angle with the horizon, sometimes rising above that plane and sometimes falling below it. The extent of the rotations of the eyes in the vertical directions are, to a remarkable extent, in harmony with the cranial type. If the type of head is that known as mesocephalic, and especially if the line of the face is that of orthognathism, the rotations are so generally high that it may be regarded as a rule that with such a type of cranium there will be found the condition of anophoria.

Anophoria does not indicate a weakness of any set of muscles nor any overaction of any set. It is an adjustment coincident to the type of the head.

It may be suggested that a condition normal to the great class of people who have this type of head should be favorable to that type: that in the process of evolution, if that is the process to which the variations of cranial types are due, the adjustments of the eyes would conform to the most favorable plane as the evolutionary process proceeded.

This and other like suggestions may be met by the statement that practical experience does not confirm the view that anophoria, while it is normal to the average mesocephalic head, is a favorable adjustment of the eyes.

When entirely simple, when it is complicated by neither hyperphoria nor esophoria, and especially when it is not accompanied by a considerable degree of declination, it may cause little if any inconvenience, especially if it occurs in a person of vigorous constitution. Even with all these favoring circumstances, it may prove an element

ing the movements of the eyes may be induced by such adjustments, was first pointed out by me in 1894, in a paper read at the meeting of the British Medical Association, and later, in another paper read at the International Ophthalmological Congress at Edinburgh, August 10th, in the same year. The first of these papers was published in *Annales d'Oculistique*, April and June, 1895, the other in the proceedings. Also in *New York Medical Journal*, February 16, 1895.

of fatigue, local and general, it may affect the carriage of the individual quite unfavorably to the best interests of health, and it may induce general disturbance of the nervous functions.

Some of the more obvious indications of anophoria are readily recognized by the experienced observer in the facial expressions and in the bodily pose of the person subject of the condition.

So intimately, however, are the physical causes now under consideration and which induce these facial expressions and bodily poses associated with the phenomena of declinations which are to be discussed in the succeeding section, that it is difficult if not impossible to consider such expressions and poses from either standpoint separately. In nearly all of the more or less extreme cases of anophoria will be found also important degrees of declination, and these combine to give character to the tensions of the facial muscles, as they do also to the muscles which influence the bodily pose.

In respect also to the physical effects, the heterophoria, the nervous disturbances, the respiratory restrictions and other results of anophoria, these conditions of declinations become modifying factors of an important nature, sometimes intensifying the effects of the anophoria and sometimes, in a measure, neutralizing these effects. It is therefore, in practice, impossible, in discussion, to separate these two classes of conditions, both dependent on peculiarities in the construction of the orbits.

It must then be permitted that in discussing the subject of anophoria and katophoria, some things shall be anticipated which are not yet reached in the regular order of our classification and in the development of our subject.

Returning to the statement that some of the more obvious indications of anophoria are recognized in the facial expressions and in the bodily pose of the individual, one or two of the most characteristic of these may be here mentioned.

Anophoria, uncomplicated, induces a strong pressure of the brows downward. The line of each brow only slightly, if at all, arched is crowded down to the border of the orbit and against the upper part of the eyelids. The lids do not open widely, but show a narrow palpebral space.

A strong positive declination in each eye may so modify this as to elevate both brows, while a very decided positive declination for one eye and negative one for the other eye may elevate one brow and

force the other even to a greater compression than would the uncomplicated anophoria.

In pose of body the characteristics are marked. Uncomplicated, the head is thrown forward. The chin approaches the chest. The capacity of the chest is restricted and its full expansion hindered, and the respiration is often impeded by a partial closing of the air passages in the vicinity of the larynx. Positive declination of both eyes may raise the head to some extent, and, even when of very high degree, may give it the pose which we shall find most characteristic of katophoria, and homonymous declinations of high degree may throw the head to one side. As a rule, however, the head is thrown forward and the chest may be compressed.

From the facts above stated it may be seen that persons with this peculiar adjustment of the eyes must be more easily predisposed to phthisis than those whose normal visual plane is less elevated. The form of the head, including that of the orbits, is hereditary. The doctrine that phthisis is transmitted by inheritance has, during the past few years, materially lost ground, as, when it is considered that the essential element of the disease is the tubercular bacillus, it naturally would. But the fact remains that phthisis runs in families. When it is recalled that the shape of the bony walls of the orbits is inherited, and that, resulting from the peculiarities we have been considering, the respiratory act is less free than it should be, is it not easy to understand that this class of persons are in a physical state to invite the bacillus and that, from the mechanics of the respiratory tract, the earliest home of the germs would be in the upper parts of that tract?

Even when this bacillus fails to find lodgment, the restricted respiration is an important factor in modifying the physical condition; for since the blood is less completely aerated, there may be less of the anabolic process of nutrition, and even a process of katabolism may be induced. Fortunately, the condition of anophoria is most frequently found in a class of persons with large cranial capacity. When environments and circumstances are favorable, the large nerve centers may control the nutritive processes to such an extent as to render them abundantly sufficient. Under more adverse circumstances katabolism may result.

KATOPHORIA.

The eyes fail, in katophoria, to rotate upward to the extent which would indicate euthyphoria. It has been seen that with an excessive rotation up there is slight rolling outward of the vertical meridians of the eyes when the plane of regard is at the horizon, and that this rolling out decreases as the plane of regard is elevated up to a certain point, beyond which it again increases.

With katophoria, the plane of least rolling out of the meridians is below the horizon.

If the upward rotation of the eyes, for example, is 28° each, the leaning of the meridians is greater when the plane of regard is at the horizon than when it is at 5° below it. Beyond this 5° of depression the leaning again increases. The result is the same whether the tubes of the clinoscope are depressed or the chin of the person examined is thrust forward to give the facial line an equal recession. It is this class of facts that leads to the conclusion that the normal plane of vision, when best placed for conforming to all of the conditions involved in the Law of Listing, is that which is associated with an upward rotation of the eyes of from 33° to 37° .

Different cases of katophoria do not all show a uniform downward rotation compared to the upward. As it has been shown in Section XXIV, the downward rotation is usually greater when compared with the upward in heads of the dolichocephalic type than in those of the brachycephalic. And this difference is explained by the difference in the conformation of the orbit in the two classes. There are brachycephalic heads in which the upward rotations are even greater than of the mesocephalic, but this is not the general rule.

It follows that while the rotations are nearly equal in the whole vertical range in mesocephalic and dolichocephalic heads, being about 83° , they are less extensive in the average brachycephalic head.

The expression of the face and the bodily pose are quite in contrast with those which are characteristic of the uncomplicated case of anophoria.

In this class, unless the effect is neutralized by certain declinations, the brows are drawn up, the lines of the face are elongated vertically, the upper lip is elongated and the head is thrown back so that the chin is advanced and the forehead recedes when the individual walks or when he sits and looks considerably in advance. The body is often bent backward with the chest protruding.

It is easy to see that if the chest is restricted and the respiratory passages partly shut in a valve-like fashion in the former class, there is in this class no such restriction, either in the capacity of the chest or in the freedom of the air passages. It may not be impossible for people of this class to acquire phthisis, but as a matter of fact they rarely do. But the pains in the back of the neck, in the middle dorsal region, and even in the lumbar region are often the physical protest against the tension upon the muscles of these parts.

This work is not intended as a treatise on general diseases, but these references to a subject of infinite importance seem not out of place in this connection.

The effect of katophobia in inducing asthenopic affections is, like that of anophoria, very considerable, for since the horoptors are in neither case located at the points of convergence of the lines in depression, the perplexities which follow the use of the eyes may give rise to asthenopic symptoms of very troublesome character.

However much the conditions, anophoria and katophobia, may demand of increased muscular tension in making the necessary adjustments of the eyes for the different planes of regard, it may well be supposed that by far the greater excess of demands upon the nervous forces arise from this disturbance in the location of the horopters and the consequent maladjustments such as hyperphoria, esophoria, etc., which arise from these disturbances.

ANOTROPIA—KATOTROPIA.

In a paper read at the meeting of the British Medical Association in 1894, I described a class of strabismus deviations, not before recognized, as double vertical strabismus. The two forms of this class of squint I defined in *Annales d'Oculistique*, April, 1895, as:—

1. *Anotropia*.—A deviation of the visual line of either eye upward when the other eye is in fixation.

2. *Katotropia*.—A deviation of the visual line of either eye downward when the other is in fixation.

In this class of squint, if either eye is in exclusion while the other is in fixation, the excluded eye deviates upward or downward according to the form of the strabismus. Thus, in a case of anotropia, if the patient directs the gaze toward a distant object directly in front and at the level of the eyes, if a visiting card is slipped in front of the right eye, the left eye will fix the object while the right will

rise, in some cases, several millimeters. Then, changing the card to the left eye, the right comes into fixation while the left rises in the same way that the right did at first. The extent of these deviations is sometimes as much as one-half the diameter of the cornea. In katoptropia, whichever eye is excluded is depressed.

These cases often present the complication of an inward or outward squint.

In a continuation of the article referred to, it was shown that by tenotomies of the superior muscles the lateral squint disappeared.

Further study of these cases leads to the conclusion that, while in these cases there is very generally a marked excess of upward rotation in the anotropia cases and failure to rotate up, with excessive rotation down, in the others, there is yet another element which is essential in all these cases and one which was not at that time (1894) fully recognized. This is a declination of the meridians of the eye so pronounced that it may be easily seen by the observer as the eye moves up or down for fixation. In explanation of the phenomenon of each eye deviating I have become convinced that we are to look to the declination; for when, by tenotomy, the upward rotation of anotropic eyes has been reduced to the standard of 33° , the eyes will still squint upward in exclusion. On the other hand, if the extreme declination is materially reduced, the upward deviation ceases. We may regard the deviation as synergic. With the adjustment of the fixing eye to correct an extreme declination, the forcible action of the superior oblique may be demanded. With this strong action the fixing eye is depressed, but to counteract the depression, in order to effect fixation at the horizon, the superior rectus comes strongly into action. Simultaneously and synergically with this, the superior rectus of the excluded eye acts, but since there is no occasion for the depressing action of the oblique, that eye is raised.

This subject of synergic or correlative action will be more fully discussed in the sections on the lateral forms of strabismus.

SECTION XXVII.

DETERMINATION OF THE EXTENT OF THE ROTATIONS OF THE EYES.

Previous to the introduction of the tropometer there was no adequate means for arriving at even approximate measurements of all the rotations of the eyes.

The employment of perimeters for this purpose naturally led to imperfect results. The brow above, the cheek below, and the nose at the medial position each presented an obstacle to a complete measurement except where these parts were unusual in conformation. When distinguished authorities reported that by the aid of the perimeter they had found their own eyes to rotate medianward 50° , they forgot that it would have been physically impossible for them to have seen by direct vision the test object when it was carried in this direction nearly to that extent. So also the upward and downward rotations were reported as having been determined by this means to extents which would be out of the question by direct vision.

Hence the figures representing these rotations which had been endorsed by distinguished names were not only unreliable, but positively misleading.

THE TROPOMETER.¹

The tropometer is designed to measure the various rotations of the eyes about the point known as the "center of rotation."

Such measurements can be determined in every direction, up, down, right, left, and in oblique directions.

From what has gone before it is evident that in distinct variance from the formerly prevailing thought, the questions of rotations in the vertical directions are by far of greatest importance in practice.

The instrument consists of a telescope mounted on a platform, at the opposite end of which is a head-rest. The telescope may be made to approach or to recede from the head-rest, and it can be raised or lowered. It rests horizontally on a movable plate, and its objective extremity may be brought directly in front of either eye.

¹ The tropometer was first exhibited and described at the meeting of the American Medical Association at Baltimore, 1894.

The telescope has at the objective end a prism of 45° , or a mirror placed so as to reflect at right angles. By means of a focusing lens in the tube the image of the eye can be made to be clearly defined at the scale in the eye-piece, while by another focusing device the scale may be seen clearly. This scale is represented at Fig. 91, where the lines at the right of the long vertical line are intended to indicate the rotations down, those at the left the rotations up. These horizontal lines are arranged to indicate upon a flat surface the change of position of a point on a spherical body, as the sphere rotates up or down.

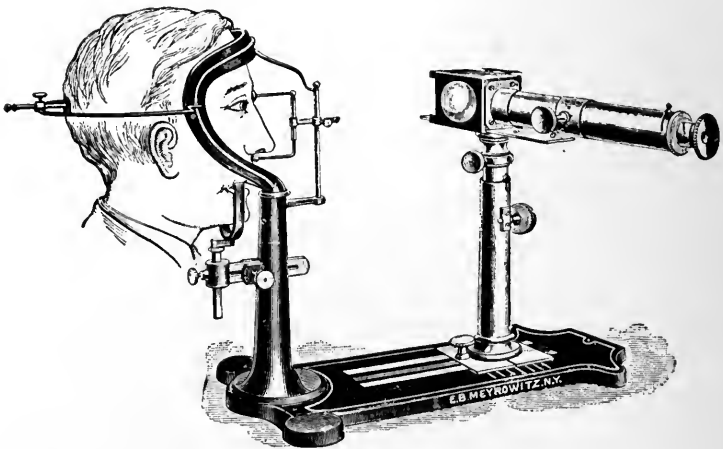

Fig. 90.—Stevens's Tropometer.

Giving the scale a half rotation, the horizontal lines become vertical and the long vertical line becomes horizontal. Then, the upper scale measures the excursion of the right eye out, the lower its rotation in. The lower scale measures the excursion of the left eye out and the upper its rotation in.

The head-rest, which is designed to hold the head exactly in the primary position, is furnished with certain accessories. They are, an exchangeable wooden tooth-rest, to be used but once and then destroyed. It slips into a bronze stirrup, which is movable up and down, forward and back. There is also a pair of button indicators, also movable, for exactly determining the primary position. The two buttons are exactly vertical to each other.

EXAMINATION BY THE TROPOMETER.

The person, the rotation of whose eyes is to be examined, seizes the strip of wood between the teeth, the forehead being caused to press against the arc of the head-rest and the face so adjusted that the two buttons press, the upper firmly against the elevation of bone which is found between the two superciliary ridges (the glabella), the lower against the upper lip by firm pressure at the depression of the upper jaw just below the nose and above the roots of the teeth. Both but-

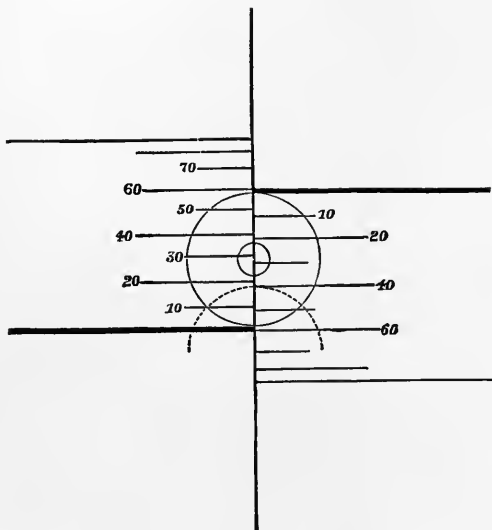

Fig. 91.—The Tropometer Scale.

tons must be in the median sagittal plane. The head thus brought into position, it is to be made secure by the hand of the examiner, the thumb against the arc of the head-rest, the fingers at the back of the head, or by the device shown in the figure. The hand is most serviceable, since the examiner can by it detect even a very slight movement of the head.

The head being thus secured in position, the telescope is brought to the proper height and a focus upon the cornea is arranged. The telescope should stand at such a distance from the eye that the cornea exactly fills the space between the heavy lines of the scale. (Fig. 91). This can be best accomplished by first turning the scale so that its

main lines run vertically, when it will be easy to adjust for the horizontal diameter of the cornea. As the horizontal and vertical diameters of the cornea are not always equal, the slight difference can be adjusted by a movement of the standard. The examined person directs the regard exactly at the center of the circular opening of the telescope. (If there is squint, the eye not under examination should be covered.)

If it is proposed first to examine the rotation of the eye upward,¹ the scale is turned to permit the lines to run horizontally. The operator, with the thumb of the left hand on the upright branch of the head-rest and the fingers of that hand pressed firmly against the back of the head of the observed, both for the prevention of any movement and for its detection if it occurs, uses the tip of the index finger of the right hand to depress very slightly the lower lid of the eye to be examined.

The lower (apparently upper) strong line of the scale is then, by means of the lifting screw at the side of the upright standard, made to coincide exactly with the lower (apparently upper) border of the cornea, while the examined eye is directed toward the small object in the center of the objective end of the telescope. Then, while the head is held in perfect immobility, the observed is directed to look upward with all his force. To the beginner the movement may not be at first as free as possible, but several repetitions will generally result in an effort which is approximately the limit.

As the eye moves up (apparently down) the observer reads on the scale the extent through which the border of the cornea passes. (See Fig. 91.)

In examining the downward rotation it is usually necessary to hold the upper lid slightly up by the end of the thumb, taking care to bring no pressure on the eye and to cause no resistance to its free movements.

In the lateral rotations it is essential to know that the median line of the head is at right angles to the direction of the telescope.

¹ Fick speaks of the rotation of the eyes in the horizontal plane as *longitudinal* and those in the vertical plane as *latitudinal* directions. Applying this we might express the rotation toward the median plane as longitude $-x^\circ$, and for a rotation toward the temple, $+x^\circ$. Also for a rotation above the plane of the horizon as latitude $+x^\circ$, and for a rotation below that plane as latitude $-x^\circ$. In a typical case of rotations the record would read about as follows: Long., -45° ; $+40^\circ$. Lat., $+35^\circ$; -40° . The more readily comprehended terms, up, down, in, out, are, however, to be preferred, the position of departure being understood.

To this end the teeth are fixed as nearly as possible midway between the upright branches of the stirrup, then the large adjustable hoop is attached to the head-rest and the button is made to press against the scalp exactly over the apex of the occipital protuberance. (When this is absent the examiner must locate the central point to the best of his judgment.) Care is to be observed that this adjustment is not changed during the examination of lateral rotations. When the vertical rotations of the two eyes are unequal, there is often a corresponding inequality in the lateral rotations. This latter inequality is not necessarily due to any disproportion in the laterally acting muscles, since from the very mechanism of the muscles, if there is a disproportion in the tensions of the vertically acting muscles of the two eyes, the inward and outward rotations will be affected. This is not a hypothetical statement only, it is easy to observe the effects of such unequal tensions of the vertically acting muscles. For example, a pronounced diverging strabismus may be quickly converted into as conspicuous a converging strabismus by an advancement of a superior or an inferior rectus, and this with a restriction of a lateral movement which was before excessive.

Also, if the upward rotations, though equal, are quite excessive, with a corresponding restriction of the opposite movement, or if the downward rotations are too great while the upward are too small, in the act of directing the eyes in the horizontal plane there may be a strong tendency of the visual lines to deviate laterally, and thus, for example, the inward rotations may be much in excess of those toward the temples; and again, this does not depend on a normally faulty condition of the converging muscles, but upon the tendency of the eyes to turn to the nasal side independently of any disproportionate influence of the converging muscles, and upon a restriction of the outward movement solely due to the tension of the vertically acting muscles.

Even to this rule there are occasional exceptions, for, as it is known that the insertion of the tendons of the eye muscles into the surface of the eyeball is not always uniform; that the insertion of the vertically acting muscles, for example, is in exceptional cases placed more nearly to correspond with the central sagittal meridian of the eye than usual, and that in extremely exceptional cases the greater part of the insertion line of these same tendons may be on the outside of that meridian, it will be seen that the mechanical rules which

would govern in the ordinary insertions must fail in these rare exceptional instances.

While, as it has been shown, the rotations in various directions differ in different individuals, the following may be stated as those found under most favorable conditions of the adjustments:—

Upward— 33° to 37° .

Downward— 45° to 50° .

Inward—about 50° .

Outward—about, or rather less than, 50° (generally 45°).

Notwithstanding the greater excursions of the eyes in the horizontal than in the vertical directions, the variations from a given standard of rotations are greatest in the vertical direction.

Even in converging or diverging strabismus, the departure from the standard of rotations in and out are generally, almost invariably, less than the departure in the same cases from the standard of upward and downward rotations. Thus, it may happen that in a case of conspicuous converging squint the lateral rotations may be changed from 50° in and 45° out to 60° in and 40° out. Only in extreme cases is there, as a rule, a greater change than this, and the change in the orbital tissues about the inner canthus, from the habitual pressure of the eyeball at this point, would fully account for this. Yet, in the same case the upward rotation may exceed the standard of 33° by 15° or more. And what is of great practical importance in this connection is that, if the tension of the elevator muscles is so far relaxed as to reduce the combined tension of the elevator and depressor muscles to a degree approximating the proper standard, the inward rotations of the eyes become notably less and the outer excursion is equally increased. It thus appears that even in marked converging squint there may be no important disproportion between the rotating ability of the laterally acting muscles, and that the variation of the excursions from the standard may arise largely, if not wholly, from the influence of the vertically acting forces and the modifications of the cushion of the eye from habitual pressure.

TREATMENT OF ANOPHORIA AND KATOPHORIA.

The treatment of tendencies and of deviations of this class must of course depend on the importance of their effects and on the nature of the associated anomalous conditions when they exist.

Experience has shown that a certain degree of anophoria may be quite consistent with freedom from practical disturbances in the form of asthenopia or other nervous reactions if there is no complication of an important degree of declination. Thus, one may have an upward rotation of 38° , or even 40° , without marked symptoms. But if with this there should exist declination of 3° or 4° in one eye, or divided between the two eyes, the probability of nervous reactions would be greatly increased.

With katophoria the case is somewhat different, for, owing to the tension on the muscles at the back of the head and neck, there is, with a moderate depression of the normal visual plane, a strong provocation to pain in that region and to other nervous symptoms.

In my earlier experience with this class of defects I operated many times by simple tenotomy of the superior or inferior recti, as the case might be. Very important relief followed the greater proportion of these operations, but I soon discovered that these direct operations did not always accomplish all that could be desired, and that even unfavorable results sometimes followed. When the influence of declinations was recognized, a very marked advance in the character of the results was observed. It is now my custom, in case of anophoria, to do the operation which will be described as extendo-contraction¹ when declination exists—and I rarely operate for this condition when it does not—permitting at the same time the muscle insertion on the whole to fall back slightly.

In cases of katophoria it is much the wisest plan to avoid any interference with the inferior recti muscles, since a very slight irregularity in the insertion of those muscles may induce a meridional leaning in such adjustments as are made in reading and other close work. It is much better, if the plane of regard is to be raised by operation, to do tendon contractions, having in view the state of the vertical meridians.

¹ Section XLVII, page 341.

As a tentative means of relief, prisms, with the bases down for both eyes, serve in cases of anophoria, and, with their bases up, are useful in katophoria, but strong prisms cannot in such cases prove anything but a disadvantage, since in the act of convergence with depression of the plane of regard, as in reading, strong prisms, of necessity, induce a leaning of the images, and hence dispose to one of the most unpleasant sources of asthenopia.

The two adjoining figures will illustrate the habitual pose in a case of katophoria and after a change in the mobility of the eyes induced by operative means.



Fig. 92.



Fig. 93.

The figure (92) is not in any way an exaggeration; in fact, the patient had at neither sitting any intimation of the purpose of the photographs, and in each case assumed the pose which was habitual with her at the times of the sittings, which were about three weeks apart. The second figure (93) represents as fairly the pose after a relaxation of 7° of each inferior rectus.

It will not be out of place to add that the patient, who was an epileptic with extremely frequent and severe attacks, was free from her malady for more than a year after the operations. Of her later condition I have no knowledge.

SECTION XXVIII.

Class II.—Declinations or the Normal Declinations of the Retinal Meridians.¹

DECLINATIONS.

With the advance in practical knowledge of the subject of declination which arises from continued observation and experience, the importance of the subject is seen to be increased in proportion as acquaintance with it becomes more accurate and more extensive. It is not necessary to compare the science of declination with heterophoria, but it is important to know that the subjects are so intimately associated and that they are so mutually interdependent that the study of one cannot be successfully pursued except by the help of the other.

In my earlier contributions to the subject I have emphasized many of the disturbances, both visual and general, which may arise from anomalous declinations. A larger experience and more adequately devised measures for the correction of such anomalies have served to confirm the view that these conditions are of vital importance, not only in local ophthalmology, but in the realm of general affections of the body.

Experience has also shown that a practical exercise of a knowledge of this subject has a wider field of application than could have been shown at an earlier stage of the investigation.

In the case of certain persons when diplopia is induced by a prism, certain phenomena other than the simple displacement of one image by the prism are revealed. One of these is a leaning of one of the images, or of both, independent of and generally much out of proportion to any leaning which would be induced by the direct action of the prism. This phenomenon, although rarely observed, will serve to introduce us to an interesting and important subject.

Suppose that the diplopia is induced by placing a prism with its base in before the right eye. If, now, the object used in the experiment is a lighted candle situated at twenty feet from the eyes and erect, while the head of the observer is in the primary position, in-

¹ For earliest papers on this subject, see Archives of Ophthalmology, vol. xxvi, No. 2, 1897, and vol. xxviii, No. 1, 1899; Ophthalmic Record, May, 1898; New York Medical Journal, February 16 and 23, 1901.

dependent of whether the two images of the candle are seen in the same horizontal plane, one or both images may appear to lean toward or away from each other at the top. Such leanings are, as a rule, only observed when the meridians of the retina or retinas of the observer deviate to a very pronounced degree, and when the observer has much difficulty in bringing the images to an upright position. Slight conditions of this sort are rarely discovered in this way.

It was by experiments somewhat of this nature, but made with upright adjustable lines, that Volkmann, Helmholtz, Hering, Donders, LeConte, and others, each by experiments different in detail but similar in principle to the others, arrived at the conclusion that for all eyes the vertical meridians normally leaned out. Thus, Donders says¹:—

“Hering (*Beiträge zur Physiologie*, p. 175) has stated that in the primary position his vertical meridians diverge above; and later he has declared that this is true for all eyes.”

That this view, which was, when Donders wrote, accepted by all, is incorrect has been shown elsewhere. Yet, beyond question such a condition did exist in the cases of these observers. Leanings had been therefore recognized, but their nature was not understood until it was shown by myself² in 1897. The condition believed by these observers to be a physiological characteristic was shown to be in their cases personal peculiarities.

The purpose here is to examine the phenomenon. Let us assume that in our experiment the image of the right eye, that before which the prism is placed, is erect, while the image of the left eye leans with the top toward the right (in). We conclude that, as a matter of fact, the vertical meridian of that eye leans out above. For the apparent leaning will be exactly opposite the real leaning. This is readily explained on principles of physiological optics and may be easily demonstrated by tilting the candle toward the left when the left eye image will appear erect. In our experiment we are ignoring both the movement and deflection of the image which might arise from the use of a prism. Of course, such a deflection might induce the phenomenon of which we speak.

This phenomenon, as just remarked, is not, as was formerly supposed, the result of a condition common to all eyes. It is the

¹ *Archiv für Ophth.*, xxi, 3, 103.

² *Archives of Ophthalmology*, vol. xxvi, November 2, 1897.

result of an anomalous condition in the same way that hypermetropia is anomalous, and the anomaly is not, as was supposed, confined to one direction; it may be a leaning out of the meridians of each eye or in of each eye, or a leaning in of one eye and out of the other, or the vertical meridian of one eye may be exactly erect while that of the other leans.

Leaving the rude and imperfect illustration drawn from the double images of the candle, we are prepared to define the terms at the head of this section and to examine into the nature of the phenomena which they designate.

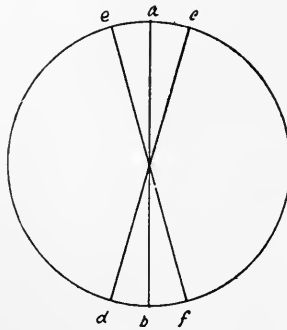

Fig. 94.

DEFINITION.

By Declination, or Normal Declination of the Retinal Meridians, is meant the deviation of the vertical, horizontal, or any given meridian of the eye from the corresponding meridian of external space when the line of regard is directed parallel to the median plane and in the plane of the horizon, the head being exactly erect or, more technically, in the primary position.

To make the definition clear we may refer to the diagram. (Fig. 94.)

Suppose the circle *eac, fbd* to represent the equator of the eyeball, and the line *ab* to represent the normal position of the vertical meridian of the eye, the line of regard being directed as stated. If this line corresponds with the vertical meridian of surrounding space there is no declination of it, and consequently none of any meridian.¹

¹ But Helmholtz believed that the horizontal meridian might be coincident

But should the eye be rolled upon its antero-posterior axis so that this vertical meridian would correspond with the position *cd* or *ef*, it is evident that in either case the vertical meridian and all other meridians of the eye would no longer correspond in position with meridians of the same name in surrounding space. In either case there would result what I have called a *declination*. If in such a case the top of the meridian line *cd* leans toward the temple, it is termed a *positive* (+) declination, while if the line *ef* leans toward the nose, it represents a *negative* (—) declination.

There are normal declinations and declinations from disease or injury. It is therefore necessary to know what a normal declination is not. It is not the tilting of the meridians which results from any paralysis, paresis, or insufficiency of any eye muscle or set of muscles. In other words, it is not a disease. It is a normal, though unfavorable, condition. It should be called an *anomalous* in contradistinction to a *pathological* declination. Hypermetropia was, before the era of Donders, regarded as a "weakness" of the eyes; now it is known that the condition has no dependent relation to weakness or strength of any part of the eyes. No more are the declinations which we are to consider dependent upon the strength or weakness of any structure. They are anomalies in the sense that they are deviations from a rule which should prevail where the typical conditions are present. They are anatomical peculiarities which vary from the ideal state, but are probably much more commonly found than is the typical state. Since anomalous declinations are frequent, although not generally to be detected by such an experiment as we have mentioned, and since pathological declinations are rare, the term "declination," when used alone, should apply to the first class only, while to designate the tiltings from disease or injury the limiting term "pathological" should be added. Nor should the term "declination" be confounded with the term *torsion*, which has long been applied to the rotations of the meridians when the eye passes from the primary and horizontal position to some position in which the line of regard is directed to some point not in the primary position or horizontal plane. Nor does the term declination apply to the conditions reported to have been found by means of prisms when the eyes were in convergence and the plane of regard in some undefined plane. Nat-

with the horizon, while the vertical meridian was only an "apparent" one, and deviated.

urally, such conditions when not directly induced by the prisms might belong to the class of torsions or to some other undetermined condition.

INSTRUMENTS FOR DETERMINING DECLINATIONS.

The crude, indefinite, and inaccurate methods which were in vogue for determining the approximate directions of the tiltings of images in cases of paralysis or injury of the eye muscles previous to the introduction of the clinoscope find no place in the examinations necessary to a correct determination and valuation of normal declinations.

The visual act must be confined to the test line alone, and all view of objects outside the tubes of the instrument must be excluded, in order that the eyes may be free from the instinctive, or automatic, effort to adjust themselves with reference to the position of external objects. The lines of sight of the two eyes must be absolutely in the same horizontal plane, and these sight lines are to be neither in convergence nor divergence, except to meet certain special contingencies.

These and other important conditions are met in the use of the clinoscope.

The clinoscope (Fig. 95) is composed essentially of two hollow tubes, each of which has at one end a minute pinhole opening through which the eye can look, and at the other end a translucent disc on which is drawn a line, in the case of one tube from the center straight up, and in that of the other tube straight down.

These tubes are so adjusted on a standard that they can be placed and maintained in the same horizontal plane, which is indicated by a spirit level, but from end to end they can be directed horizontally or up or down. They can, as above intimated, be made to converge or diverge to meet certain contingencies.

The tubes rotate on their long axes, and a pointer attached to each tube indicates on a scale the extent to which the tube is rotated. The small sight openings are so adjustable that the distance between them may be suited to the interpupillary distance of different persons. For the accommodation of those who, on account of presbyopia, myopia, or any high degree of refractive error, cannot see at the distance of the test objects from the eyes, there are clips in which refracting glasses may be placed. The sight openings being very small and exactly in the same horizontal plane, there can be no doubt

as to the erect position of the median plane of the head when the two eyes are seeing, each through its appropriate sight opening, any existing hyperphoria being corrected.

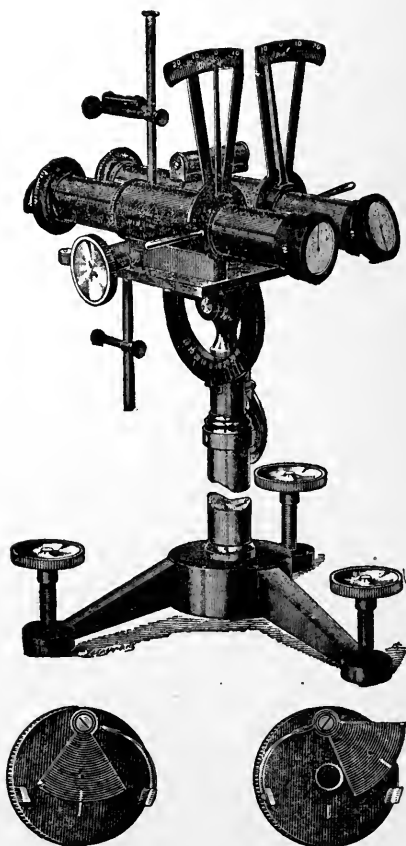

Fig. 95.—The Clinoscope.

Any device for testing declination which does not provide for the exclusion of surrounding objects from the field of view and which does not also secure an absolutely erect position of the head is worse than worthless, since it must be misleading.

To meet the exigencies of cases of greater or less degrees of amblyopia, as in squint or extreme myopia, it was found necessary to devise what I have called the "lens clinoscope," an indispensable

instrument, but one which cannot take the place, in ordinary cases, of the clinoscope.

Method of Using the Clinoscope.—The instrument is to be so adjusted in respect to height that the sight-holes will be on a level

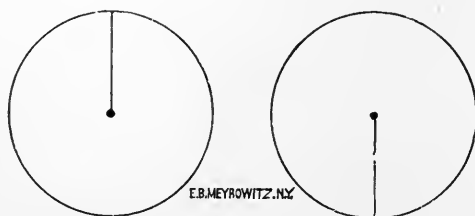

Fig. 96.—Objective Lines for the Clinoscope.¹

with the eyes of the examined person when sitting erect. This is best accomplished by the use of an adjustable table. The tubes may be exactly parallel or they may, in certain cases, be made to converge

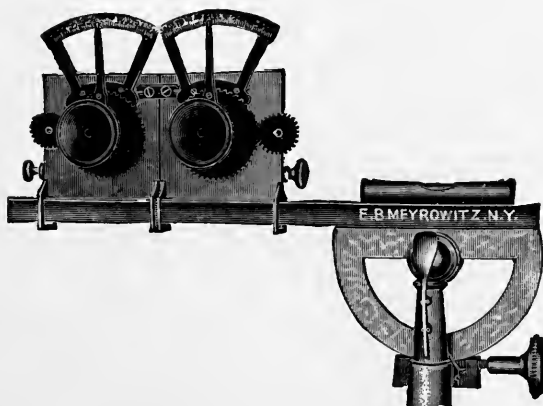

Fig. 97.—The Lens Clinoscope.

very slightly, thus making the distant point at 8 or 10 feet instead of infinite distance. Under other exceptional circumstances they may be made to diverge. The tubes must be brought to an exact level with each other as shown by the spirit level.

Unless the subject of the examination is unable to see the test

¹For purposes of physiological research objective diagrams of many designs may be connected with the clinoscope, but for practical purposes the above is sufficient, and it is important not to disarrange the working objectives.

lines of the tubes, on account of presbyopia or high refractive error, no glasses should be used, and when glasses are necessary the weakest that will enable the person to see the lines clearly should be placed *in the clips*. A prism for the correction of hyperphoria may also be required. *The glasses should not be worn*, since, if a strong glass should not be held exactly at a right angle with the axis of the tube, the lens would itself induce a deflection of the image.

The examiner must be sure that the examined person sees through both openings simultaneously and that the view of both images is maintained throughout the examination, otherwise there can be no certainty that the head is precisely erect.

When the examined person has secured a good view of both the test lines he should endeavor, if they do not at once unite, to induce them to do so as in a stereoscope. Some people do not succeed in

To Test the Clinoscope.—Before using the clinoscope the test lines should be adjusted with great care, and it should be positively known that when the pointers are at the zero mark on the scale the lines on the objectives are absolutely vertical.

To adjust the objectives the following method may be adopted:—

Place the clinoscope on a narrow table which will allow the examiner to look through the eyepiece at one end and permit a plumb line to swing free at the objective end. Let a very fine thread, to which is attached a weight

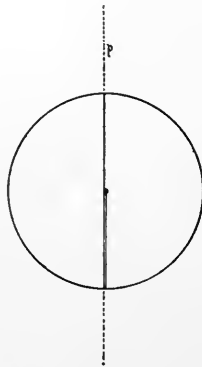

Method of Testing the Clinoscope. *P*, The plumb line.

sufficient to render it tense, fall in front of the objective and almost in contact with it. The thread should be at least two feet in length. Open the shutter at the eyepiece so as to give a free view, bring the instrument to an exact level as shown by the spirit level, set the pointers exactly at zero, then, the screws of the objectives being somewhat loosened, adjust the line exactly parallel with the image of the plumb line thread. Do not let the line and thread image come in contact. Leave a slight space so as to observe exact parallelism. When the line is exactly upright make the screws tight and examine again to see that the objective has not been disarranged.

this, in which cases the examination may go on with the images separated, but it is less satisfactory.

When the apparent vertical position of the lines has been attained, the examiner should move them more or less backward and forward, in order that the true position may be more positively located. Few people can arrive at a satisfactory conclusion regarding the position of the lines at the first trial, but after a day or two the tests become, for nearly all intelligent people, remarkably uniform.

In a former section (Section XXVI) it has been shown that the plane of least leaning of the meridians depends upon the presence or absence of anophoria or katophoria. For very precise investigations the clinoscope should be adjusted with reference to the normal plane of vision. In practice, when the extent of deviation of the plane of vision from the horizon is not great, a slight adjustment of the head while the tubes remain horizontal will serve to avoid material torsions.

Results of Examinations.—Previous to the investigations by the clinoscope a belief had prevailed among physiologists that there was, in healthy eyes, a fixed and definite position for the meridians of the eye, a physiological characteristic of the construction of the retina, and that this position was general, if not universal. Helmholtz, Donders, Volkmann, Meissner, and others had devised means for the investigation of the facts, all of which means were imperfect and most of which were misleading, and most of these investigators agreed that normally there existed, for the vertical meridian, a leaning out of about $1\frac{1}{4}^{\circ}$, while the horizontal meridian was supposed to coincide exactly with the real horizon. These leanings were not supposed to be personal peculiarities, but essential elements in the physiology of the retina.

One of the first results of the investigations by the clinoscope was the demonstration that the positions of the vertical and horizontal meridians leaned, when either leaned, in corresponding directions and to an equal extent. What was of far greater importance, it was found that the leanings of the meridians were as varied and as characteristic of the individual as the refraction of the eyes.

The clinoscope shows that in some persons the vertical meridian of one eye corresponds with an exact vertical line, while that of the other eye leans from one degree to many degrees. In other cases the vertical meridian of each eye leans in the same direction, that is, each to the right or each to the left, and this leaning is nearly equal in the two eyes. In still other cases the meridians lean in opposite

directions, that of one eye to the right, that of the other eye to the left. In extent there is great variation, some cases showing the meridian of each eye very nearly erect, while others will show the meridians in both eyes leaning as much as six or even ten degrees.

It is these leanings which I have called declinations. *They are not, as has already been said, torsions, which term has a well-established meaning, the phenomena to which it refers being widely different from those under discussion.* Torsion results from an active adjustment of the eye and corresponds to the position to which the eye is moved. Declinations, on the other hand, are purely passive states to be determined when the lines of regard are fixed in the primary position.

In normally healthy eyes the leaning of a meridian may vary according to the automatic tension which may be exerted. Hence it is found that very high degrees of declination are more frequently manifest in persons who have passed fifty years of age than in those who are younger. Hence also there is sometimes a variation which appears to depend on the physical condition of an individual at different times.

I have compared these anomalies of declination to those of refraction. As there are few eyes without some error of refraction, so there are few in which the insertions of the muscles are so ideal that there is no declination; and, as slight refractive errors may be disregarded, so slight declinations may have little practical significance. Even high degrees of declination seem in certain instances, like certain cases of high-grade hypermetropia, to exert no appreciable injurious influence. Yet, as a rule, as in refraction, the higher the grade of the anomaly the greater the resulting nervous disturbance.

SOME OF THE RELATIONS BETWEEN DECLINATIONS AND HETEROPHORIA.

Long before the principles of declination were recognized I became impressed with the belief that many of the phenomena of heterophoria and heterotropia were secondary to some other condition than the condition which was most manifest. Thus, for several years I had often expressed in my writings the thought that there were few, if any, cases of original exophoria, and I diligently endeavored to learn the true nature of the anomaly. Certain cases, too, of hyperphoria seemed to me not to be essentially such, and many cases of

esophoria were so contradictory in their phenomena that there seemed to be demanded a further element to account for them.

The clinoscope has thrown a remarkable light upon these questions. A few of them are answered with ease, since the relations between the revelations by the clinoscope and those of the phorometer appear to be quite simple. In other cases these relations are much more complicated, yet, in general, quite susceptible of explanation.

The relationship between declination and exophoria is perhaps the most easy to comprehend, and a study of these relations is most interesting. In exophoria there is, as a rule, positive (+) declination of both eyes, and the extent is nearly equal in each. The exceptions to this rule are rare, and even these apparent exceptions are, after close investigation, usually found not to be exceptions at all. Still the fact is to be recognized that in some instances there may be a high degree of + declination for one eye with little or none or even slight — declination for the other. Conversely to the general proposition, positive (+) declinations of both eyes is strongly suggestive of exophoria.

In the rotation of the eyes upon their long axes, in the effort to effect parallelism of the vertical meridians, each eye is forced downward and outward. The downward movements, if they are equal, have little influence in inducing heterophoria, but when the declination to be corrected is considerable, the effect upon the outward swing of the eyes may be very considerable. As each line of regard is forced outward the parallelism of the lines of regard is sacrificed to that of the vertical meridians and exophoria results.

It will be seen also that, if the leanings of the meridians are each positive but unequal, one eye would be forced outward and downward more than the other, and hyperphoria might result. These theoretical views of the adjustments correspond exactly with the results of practical experience when the phorometer and the clinoscope are used together. The manifestations of heterophoria are not always present when the inducing causes exist.

When operating for exophoria by slight tenotomies before the use of the clinoscope, I observed that, as a rule, the tendon of the externus was rarely, if ever, found tense. It was hard to believe that the exophoria could be the result of the predominance of force of this muscle, which was so often found much relaxed. Later, when the tropometer was brought to the attempted solution of these questions, it was found that there was, in most cases, no excess of rotating power

in the externi or any deficiency of rotating ability in the interni. It was noticeable also that it was no uncommon thing that what was apparently a successful correction of the exophoria was only a temporary one, and that the defect was apt to return in a few weeks or even after a few days in almost as high degree as before the operation. It was in many cases deemed better to leave uncorrected a marked degree of exophoria than to reduce the rotating ability of the externi, either by tenotomy or by a contraction of the interni, to an extent sufficient to permanently abolish the exophoria. With the advent of the clinoscope much light was thrown upon this whole subject. With a knowledge of the declinations and their effects we may now look for a relief from exophoria without restricting the action of any muscle and with a reasonable expectation of permanency of result.

The hyperphoria which may result when there is somewhat unequal leaning of the meridians in the two eyes has been referred to above. In many cases of hyperphoria a declination of several degrees may be found for one eye while the other will be either without declination or with very much less than the first and usually of the same sign. An example of this will not be out of place here.

In a case of long-standing vertical diplopia there was, during four successive days' testings: Right hypertropia 10° in the primary position with increased hypertropia looking down 30° or up 20° . In alternate exclusion the deviation appeared even greater than that shown by the phorometer. The rotation up, as shown by the tropometer, was, for the right eye 40° and for the left 36° . It would seem that this was pre-eminently a case for a tenotomy of the superior rectus of the right eye. Yet, as there was declination $+ 6^{\circ}$ of the left eye and only $+ 1^{\circ}$ of the right, I determined to do an operation on the *internus* of the left eye with only the declination in view, for there was no marked exophoria or esophoria. The operation was successful in correcting the declination to within 2° , and on the following day I had the satisfaction of finding that there was easy single vision with less than 2° hyperphoria and with no esophoria or exophoria. After many weeks had passed the hypertropia had not again manifested itself.

Such a case is of much interest in illustrating the dominating influence of declination even in extreme hypertropia. It is also interesting as an illustration of the daily experience in removing the conditions of heterophoria and even strabismus by the simple correction of declination. The example also shows how even the upward rota-

tion may be influenced by the declination, for after the operation on the internus the upward rotation of the two eyes was nearly equal. This case is stated not as an exceptional instance, but as an illustration of daily experience.

In esophoria declination is almost uniformly found in both eyes, and the leanings of the meridians are conjugate. If the declination is plus for the right eye, it is minus for the left, and most frequently the leanings are approximately of nearly the same extent. The greater the extent of declination, usually, the greater the degree of esophoria. If, however, there is positive declination of one eye of a considerable degree and of the other of a very slight degree, or only a very slight negative declination, the images, in examining by the phorometer, may swing from a high to a low degree of esophoria or from esophoria to exophoria, the position of the images depending in such a case on the effort to make vertical the vertical meridian of one or of the other eye.

Thus it appears that the different forms of heterophoria are associated with different forms of declination, and experience has shown that in a large proportion of cases a relief to the declination is followed at once by a relief to the heterophoria. In certain unusual cases it will be found that each eye will rise many degrees when a screen is placed before it. Even when any excess of upward rotation has been corrected the phenomenon remains. Here the upward turning is due to the declination of the opposite eye and it will remain even after the eyes are both too low, unless the declination is corrected.

EMPIRICAL SCHEME FOR SOME OF THE RELATIONS OF DECLINATION AND HETEROPHORIA.

The following diagrams with the assumed action of the muscles in correcting the declinations will suggest some of the forms of heterophoria which may result from declinations. It is, however, to be remembered that the comparative action of the various muscles may so modify the results that these rules may not apply in an individual case. The scheme is therefore *suggestive* rather than *absolute*, and it also often happens that in cases of marked declination where no heterophoric conditions are manifest a slight change of the equation may modify the result to an important extent.

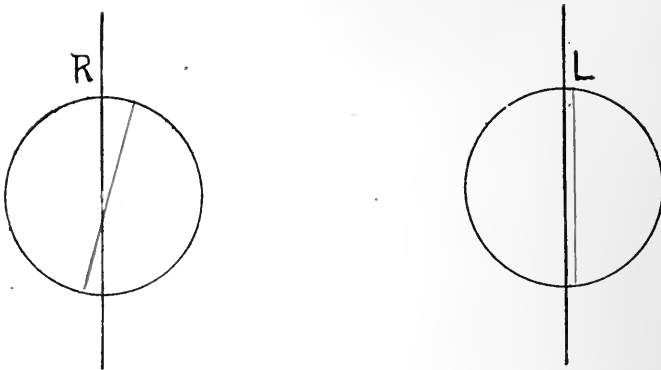

Fig. 98.

Right Eye—The muscles brought into action are:—

The inferior oblique, rotates the eye out and up and rolls it to the right.

The inferior rectus, which draws the eye downward and rolls it to the right.

Result: Exophoria, unless the internus is brought into action to overcome the outward rotation, in which case the synergic action of the left internus may induce esophoria.

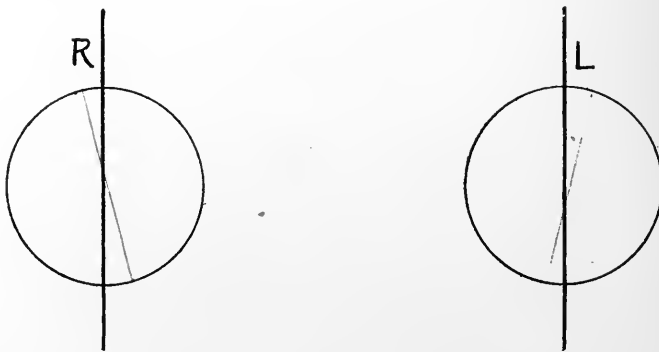

Fig. 99.

Right Eye—Muscles brought into service are:—

The superior oblique, which rotates the eye down and out and rolls it to the left.

Left Eye—The superior rectus, which rotates the eye down and out and rolls it to the right.

Results: Except when the inferior recti are brought into action to overcome a marked anophoria, the result is exophoria.

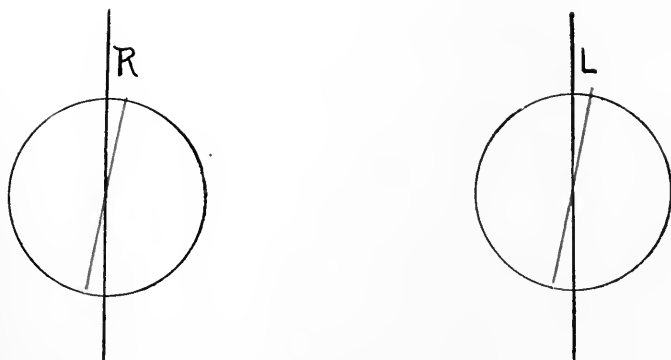

Fig. 100.

Right Eye—Muscles involved:—

Inferior oblique, rotates eye up and out and rolls eye to right.

Inferior rectus, rotates eye down and rolls it slightly to right.

Left Eye—Muscles involved:—

Superior oblique, rotates eye down and out and rolls it to right.

Results often in right hyperphoria, but if the negative declination of the right is less than the positive of the left, the result is esophoria.

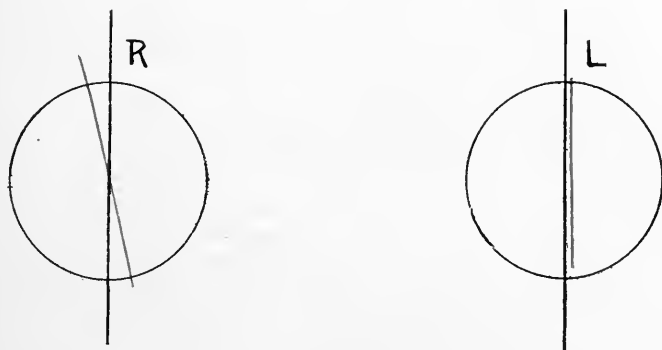

Fig. 101.

Right Eye—Muscles involved:—

Superior oblique, rotating eye down and out and rolling it to left.

Superior rectus, rotating eye up and slightly in and rolling eye to left.

The internal rectus may act to neutralize the outward action of the oblique, which may be in excess of what is neutralized by the superior rectus.

Result: Esophoria and, if left superior rectus acts synergically with the right, left hyperphoria.

HETEROTROPIA OR STRABISMUS AND DECLINATION.

The principles which apply to the relations between heterophoria and declinations apply also to strabismus. The conditions differ in respect to the degree of declinations and also, in general, in respect to the vertical rotations. The causative conditions of heterotropia are usually, not only exaggerations of those of heterophoria, but the conditions are also more complicated.

After some experience in the use of the tropometer I found that in nearly every case of converging strabismus there was not only excessive upward rotation of the eyes, but that this rotation was, in fact, in most cases extravagant. For example, instead of a rotation up of about 33° , which investigation and experience had shown was the most favorable, in cases of converging strabismus it was not uncommon to find the upward rotation as much as 50° or even 55° . A reduction of this excessive upward rotation, this anophoria, served, in a number of cases of marked squint, to relieve the defect without interference with the laterally acting muscles, and there seemed to have been found a condition a modification of which promised a relief in strabismus without an unfavorable restriction in the action of any muscle. A larger experience showed that, while there was in this thought an important truth, there remained an element of uncertainty with respect to results which was of great practical importance.

With the introduction of the clinoscope new observations were made, and it was soon found that in nearly all cases in which there was a very excessive range of rotations in the vertical direction there were also unusual degrees of declinations. Applying these new facts to those which had been previously observed, there arose the reasonable hypothesis that the excessive declinations combined their influence with the excessive vertical rotations to induce the strabismus.

Close observation and added experience have confirmed this hypothesis, which, in the light of abundant practical facts, has now become a demonstrated proposition. It will be seen as we proceed that it supplies a rational method for the cure of converging or diverging strabismus without the disability which has invariably resulted to the tenotomized (or contracted) muscles in the older methods of operating for squint.

It may be said that, as a rule, to which rule, however, there are

exceptions in respect to the upward rotations, there is in convergent squint excessive upward rotation with extreme conjugate declination, that is, with positive declination for one eye and negative for the other, or, rarely, the declination for both may be of one sign but differing greatly in degree. In some of the cases of the latter class there is alternating squint. If the eye with the extreme positive declination is fixed upon the object, there will be converging squint, while when that with the less declination is in fixation a divergence occurs.

If also, as it sometimes happens, there is little or no declination for one eye with great declination for the other, we have the important elements of intermittent strabismus. If the eye with little or no declination is in fixation, there may be no deviation of the eyes, but if that with the extreme declination is the fixing eye, strabismus occurs.

These principles will be more fully developed in the sections on strabismus.

We have thus for the first time a logical and a uniformly applicable explanation for all the various forms of so-called concomitant strabismus. With a good understanding of the principles of rotation and of declination there is no longer a necessity for a new theory for each form of strabismus.

Without entering upon the details of all the elements inducing diverging squint, it may be stated that there will be found the same class of declinations in exotropia as are found in exophoria, but in high degrees. So in hypertropia the conditions are similar to those of hyperphoria, but, as in the cases of esotropia and exotropia, these conditions are extreme and usually combined with anomalies of the vertical rotations.

It is not to be assumed from the foregoing remarks that all the problems of heterotropia are to be solved by any single class of phenomena or by any single rule.

LOCAL SYMPTOMS OF DECLINATIONS.

Many of the symptoms of declinations are similar to or the same as those which are attributed to heterophoria. But since the study of the former class of anomalies has placed the whole subject of heterophoria in a new light a considerable number of the symptoms which appeared to result from heterophoria can now be directly asso-

ciated with the definite disturbing cause as it was not possible to do before.

One of the most common and persistent of the local symptoms is dryness of the eyelids with smarting of the eyes and a sensation of grit in them. The chronic hyperæmia of the lids which is so annoying to many patients and so difficult to cure is in most cases the direct result of the pressure of the lids against the eyeball, a pressure exerted to hold the eyes steady in resisting the tendency to roll incident to the inclination of the meridians. The hyperæmia disappears without direct treatment when the declination is corrected. I have elsewhere¹ shown the importance of the condition of anophoria as an ætiological element of trachoma, and this condition is the more important in its ætiological effects in proportion as it is complicated with pronounced leanings of the meridians.

Another symptom, less local, is the habitual pain in and over the brow of one eye or those of both eyes. If the brows are carefully observed, it does not require minute inspection to see that one or both brows are strongly arched, or that one brow is flattened against the eye while the other is arched. Above the arching brow there are to be seen in many cases folds in the skin showing the tension of muscles beneath.

The pain above the brow in these cases is not a reflex disturbance, but the immediate and legitimate suffering of the muscles acting to elevate or depress the brow. This is shown when the declination is relieved, for the brows then at once assume a gentle curve and the pain vanishes in a day.

It will be found that with myopia there is uniformly a high degree of declination and when the pressure of the torsional muscles about the eyeball is considered it is evident that with such pressure combined with a plastic state of the sclera, a state which may easily result from the disturbed nutrition of the eyeball when heterophoria exists, the globe from ordinary mechanical laws might become elongated. One of the strong expressional signs of a high degree of declination is a prominence of the eyeball, a more or less goggled appearance, and it is well known that this is a condition largely characteristic of myopia. It arises from the forward pull of the obliques.

¹ "British Medical Association, 1897." Published in *Ophthalmic Review*, September, 1897.

Quite in contrast with this, but from corresponding but not identical conditions of declination, is the state of the eyes in which they appear to be placed in very close proximity to each other. This closeness of the eyes to each other is, like the contrasting condition of prominence, a result of certain forms of declination, and often exists even when there is a high grade of exophoria.

ASTIGMATISM AND MYOPIA.

It not infrequently happens that after a correction of declination a preëxisting astigmatism disappears or is modified in degree or direction. So frequently have such modifications been observed from a correction of declination that for a number of years, in cases in which I am treating declinations, I reserve the prescription for cylindrical glasses in astigmatic cases until after the declination treatment is finished. I called attention to the fact that *a loss of the normal sphericity of the globe* (astigmatism) is a legitimate result of adjustments, in which the muscles which surround the eye like a band are held at abnormal tension, in an article on declination in *Archives of Ophthalmology*, No. 1, 1899. The statement was based, not only on theoretical but on practical grounds, for I had not infrequently seen the astigmatism greatly modified by declination operations previous to the publication of that article.

In the same article I also spoke of the elongation of the eyeball in myopia as the result of similar but more uniform pressure of these encircling muscles. I added: "It may well be thought that the constant pressure brought to bear by both the oblique and straight muscles in marked cases of declination may influence the form of the globe, but there must be a combination of circumstances to induce such a result.

"In the first place the scleral walls must be in a plastic condition. Such a condition may be one of the reactions from the tensions of heterophoria. A reddening of the conjunctiva or of the borders of the lids very frequently tells of the tensions of heterophoria, and the sclera may suffer a change of nutrition in the same way. When the eye is in this plastic state and the tension of the muscles which encircle it is too great, there is every reason to expect the eye to yield to the pressure. Myopia is a progressive disease. If with the first indications of the elongation of the globe, the conditions which induce hyperæmia and which cause unfavorable pressure

are removed, a very rational expectation may be entertained that the further progress of the elongation of the globe may be arrested.

“One of the most characteristic local effects of declinations is the amblyopia which is in many cases associated with it. Such amblyopias are found in high degrees of heterophoria, in strabismus, and in high grades of astigmatism. It is probable that even in these states the defective vision is to be attributed in large degree to the declinations.”

Under the heading “Unconscious Conclusions” (Section XVIII) attention has already been called to the interesting phenomena of aberration of the color sense and of the muscular and locomotive sense resulting from heterophoria, but principally from declinations. It is usually the eye in which the declination is most pronounced that attributes the deepest color to an identical object, and it is with extremely high degrees of declination which, however, the person is able in great measure to control, that the uncertainty of locomotion occurs.

DECLINATIONS, THE CONTOUR OF THE BROWS AND THE RELATIVE POSITIONS OF THE EYES.

This leads to a part of the subject which, while in the line of the discussion, passes from the domain of painful affections to that of facial expressions. From that point of view it will be more fully discussed in the section devoted to that subject. So important, however, are these expressions in their practical relations to declinations that a brief summary of the most conspicuous should find a place here. The scope of this section does not permit of more than a mention of a few of the peculiarities in the contour and the symmetry or asymmetry of the two brows. The subject when considered in all its bearings is most interesting, but it will serve the present purpose to mention three of the most conspicuous forms of expression about the brows which are in direct relation to the declinations of the meridians. So characteristic are these that when either is conspicuously present it is easy, not only to recognize the class of declinations, but to tell the direction of the leaning of each eye.

In the form in which both brows slant or arch upward from the temples toward the median line, the internal extremity ending almost in the general direction of the line of slant or suddenly curving down at the inner end as it is seen in the diagram (Fig. 117, page 321), we may look for positive declinations for both eyes and of

nearly the same extent. It is an expression which, some years ago, I associated with exophoria, but the more recent observations show that not only the expression but the exophoria itself has its cause in the direction of the meridians.

A second form of direction of the brows which is also most frequently associated with exophoria, but which is sometimes found with esophoria, is that in which each of the brows ascends from the inner extremity outward, forming what I have called "the bird's wings" eyebrows (Fig. 118, page 322). Here the declination is positive for each eye, but the extent of the declination differs materially in the two eyes. Such a declination may, when the positive declination is quite moderate in one eye and is more decided in the other, give rise to esophoria, but the nearer the approach to equality of declination in the two eyes the greater the probability of exophoria resulting.

Again, the position of the brows assumes the directions shown in the diagram (Fig. 114, page 319). The diagram here appears somewhat extravagant, but it is a common form of expression, and a close observer will soon find that it is by no means exaggerated. It is a form of expression which indicates homonymous declination with the positive leaning at the side with the compressed brow and the negative leaning at the side on which the brow rises toward the temple. One of the common modifications of this form is that in which both brows curve strongly, but one is drawn much farther upward than the other.

Associated with these asymmetrical or anomalous positions of the brows are frequently found asymmetrical positions of the eyeballs. Thus, for example, with a marked depression of one of the brows there is frequently found a depression of the position of the whole eyeball, and in some cases of double pressure of the brows both eyes are dislodged downward. (See Figs. 115 and 116, page 321.)

It is interesting to remark that it is, in the great majority of cases, the left brow that is depressed, and this is in accord with the fact that in practice a great majority of cases of positive (+) declinations are found on the left side. So emphatically is this the rule that in my earlier experience with the clinoscope, I was led to very frequent verifications of the position of the test lines of the instrument, since the preponderance of such cases seemed quite improbable. Several years of constant use of the clinoscope, however, has left no

doubt that positive declination is by far most frequently found in the left eye.

What may be the essential reason for this I do not attempt to explain, but a suggestion may not be inappropriate. The great majority of people are not only right-handed, but they have inherited right-handedness. It is known that the left cerebral lobe is usually, almost invariably, larger than the right. May it not happen that with the unequal development of the brain the bony walls of the orbits are molded in conformity with this unequal cerebral development? And if this be true, is it not a forcible argument against forcing children to use one hand to the neglect of the other? The inheritance may not fail in the first generation, but at least some approach to symmetrical brains and symmetrical orbits may be hoped for even in one generation.

POSE OF THE HEAD FROM DECLINATION.

The habitual pose of the head and, indeed, that of the body are in a large measure influenced, it might be said controlled, by peculiarities in the normal adjustments of the eyes. Independent of the position of the normal plane of vision, which has an important controlling influence upon the pose of the head and body, when there exists a positive (+) declination for each eye the head is, in many cases, thrown backward as it is when the plane of vision is low. This high carriage of the head is commonly associated with chronic pains at the base of the skull, at a point over the spine of the seventh cervical vertebra and at points between the shoulder-blades or just below each scapular angle, with habitual aching in the lumbar region. If, in these cases, the plane of vision is raised where it was originally low, or if the positive declination, when it exists, is corrected, the head is no longer habitually thrown backward, the back no longer bends in, the tension is removed from the muscles, and relief from the pain is experienced.

When the declination is toward one side or confined to one eye it assumes, in extreme cases, a cause of drawing of the head toward that side, and where the drawing of the head to the side is great, chronic spasm of the muscles of the neck may result. A number of extreme and long-continued cases of torticollis have yielded to the treatment directed exclusively to these anomalies of declinations.

OTHER SYMPTOMS.

Vertigo is one of the symptoms so closely related to declinations that it may be said that, in general, vertigo is the direct, not the reflex, effect of the declinations. Carried to its extreme manifestation, the vertiginous attack becomes epileptoid, and without doubt the underlying principle in both vertigo and true epilepsy is the same.

The more recent experiences with ocular causes of epilepsy—and beyond a doubt a great proportion of idiopathic cases of epilepsy have for their cause ocular conditions—show that when we arrive at the root of the matter the declinations are the most important if not the essential of these ocular elements. The relief which often follows correction of the refractive errors or the anomalies of heterophoria may probably be due largely to the fact that with the greater freedom of action of the adjustments of the eyes and the consequent relief from fatigue the management of the declinations becomes less difficult and disturbing. If we proceed directly to correct the anomalous declinations, the results upon the epileptic state are much more certain and more quickly and permanently marked than when the heterophoric conditions are alone treated. Whatever the theory may be, the fact is that in many cases in which the correction of refractive and heterophoric anomalies only modifies the epileptic state a correction of declinations serves to arrest the epileptic seizures.¹

Space does not allow of any extended mention of insomnia, dyspepsia, mental disturbances, and many other forms of nervous reactions which in very frequent instances have their origin in the class of defects under consideration, and it is needless to attempt to introduce a catalogue of reactions which may be induced by this defect, but it may be said, in a general way, that many of the nervous reactions which result from heterophoria may also have their origin in the normal tiltings of the meridians. Enough has been said to indicate that declinations are important elements of nervous irregularities, and if that is established it follows that the forms of manifestations may be numerous and varied.

¹ The so-called "Jacksonian Epilepsy" is, in fact, not epilepsy—it is a convulsive disease dependent upon gross lesions of the nervous centers and should not be classed with an affection which is conceded to have no recognizable pathology.

TREATMENT OF DECLINATIONS.

While, under certain circumstances, glasses, spherical, cylindrical, or prismatic, may and doubtless do have an influence in inducing or in correcting declinations of the images of objects, no practical and systematic use of lenses can be made in the treatment of this class of anomalies. It is only important in this connection to remark that declination of the images (not of the eyes) is easily induced by a bad adjustment of strong lenses, and that the greater care which is observed in the adjustment of glasses in recent over not very remote times is even more important than it is generally supposed.

There is little doubt that the influence of strong convex glasses in temporarily modifying or even apparently correcting some cases of converging strabismus while the glasses are before the eyes, is due to the fact that with such glasses the eyes are able to find a position in which the deflection of the *image* induced by the glass in some measure neutralizes the declination of the *eye*. When this important function is added to the prismatic action which may also be selected by the eyes in the interest of a correction of hyperphoria we have perhaps found a full explanation of the effect of convex glasses on strabismus. The effect of such glasses is certainly not in the relief to the ciliary muscles.

Naturally, when the subject of declination is exercising the functions of adjustment of the eyes excessively, or when the nervous energy is insufficient for the demand upon it, there is liable to result more of the local or more general unpleasant effects of declination than when the subject of the defect is under more favorable conditions. Hence rest, abundance of fresh air, relief from work demanding continued and difficult adjustments of the eyes with agreeable environments are means by which some or possibly all the injurious effects of declination may be for the time modified, and if to these means we add a correction of refractive errors by glasses and the use of tonics, we have summed up the principle, if not all the means at our disposal, for the relief from the effect of declination short of a radical removal of the defect itself, which can only be accomplished by surgical interference. In another place reference to gymnastic exercises in cases of declination will be made. Naturally, such gymnastics are not in any sense curative.

As it will be found most convenient to devote a section to the subject of surgical operations on the ocular muscles, the reader is referred to that section for the "Surgical Treatment of Declinations."

SECTION XXIX.

ACCOMMODATIVE AXIAL ADJUSTMENTS.

Class III.

The affections of the ocular muscles included in this are physiological peculiarities rather than affections arising from pathological conditions.

It is unquestionable that the conditions of Classes I and II have much to do in inducing some if not most of the affections of this class, and the three classes cannot therefore be regarded as independent of each other. For while the conditions in Class I or Class II are perhaps always primary, it has been shown that at least a part of those now to be discussed are secondary.

In the normal adjustments of the eyes of most persons in early life in the act of vision, two distinct classes of muscles perform each its distinct and separate office. The muscle of accommodation, situated within the eyeball, acts as the focal adjuster for each eye, while the long muscles within the orbit direct the eyeballs in such a way as to bring the visual axes of the two eyes to bear upon the point for which the focal adjustment is made.

These two classes of muscles, although independent of each other, are, during at least some periods of life, in somewhat close synergic relation. In a discussion of the anomalies of the ocular muscles, therefore, the relations between these two classes should be considered.

This is the more necessary since, according to the view which has been almost universally entertained by ophthalmologists since the notable series of articles, commencing in 1860,¹ culminated in the monumental work of Donders on the refraction and accommodation of the eye, these relations have been regarded as the cause of the principal forms of strabismus.

The view that the association of these two functions is so essen-

¹ Arch. für. Ophthal., Bd. 6, 1, 1860.

tial and so commanding that from the excess of the action of one should arise an excess in the function of the other, and that thereby an anomaly in the functions of accommodation becomes logically the essential ætiological factor of the deviation in converging strabismus, has become too generally accepted to be overlooked.

It is some years since I have expressed my dissent from this accepted view,¹ and I am sure that we shall find that it is not only unnecessary, but illogical. For the line of thought that leads to this conclusion the reader is referred to the section on Converging Strabismus.

That the associations of the accommodative and adjusting muscles are those arising from custom, and that they may be interrupted at any time, is a matter of daily observation.

If we examine stereoscopic diagrams in which the effect of relief is induced, we have the effects of different degrees of convergence, while the accommodation remains stationary. This very simple illustration of the ease with which the two functions are disassociated is but one of a great number.

The affections of the ciliary muscles, therefore, are not essential factors of the anomalies of the motor muscles, and need not be considered in this connection beyond the reciprocal influences which may arise from habitual associations.

SECTION XXX.

DIFFERENCE OF DEGREE OF ANOMALOUS CONDITIONS OF THE MOTOR MUSCLES.

In the classification adopted it appears that the anomalies of the directing muscular apparatus of the eyes are divided into two main groups: first, those which permit of habitual binocular vision; second, those in which a blending of the images of the two eyes is so difficult as to be, in most instances, impossible. In the first of these groups binocular vision is maintained by the expenditure of a greater amount of force than is demanded in perfect equilibrium of the ocular muscles; in the second the amount of force demanded is

¹ British Medical Association, 1894; International Ophthalmological Congress, 1894.

usually greater than can be continuously supplied. There are, however, cases belonging to this class (and it is probable that they constitute the majority) in which it is not so much a question of amount of force as a question of ability to arrange the elements of force so as to act with each other in producing the desired end—binocular vision. Such cases may occur with extravagantly high rotations or with important declinations.

The two classes are therefore, in general, different degrees of similar affections, the classification depending upon the psychical presence or absence of the phenomenon of fusion of images. Under certain circumstances the conditions of one of these groups may pass into the other. One who in robust health blends images habitually and without conscious difficulty, may, in a condition of impaired nervous energy, be quite unable to maintain a fusion of the images of the two eyes.

Even the presence of or the absence of binocular vision, then, does not constitute an absolute and sharply defined line of classification.

It happens also that, with gross departure from the standard of equilibrium of the eye muscles, habitual binocular vision is sometimes maintained. It depends largely upon the combinations of anomalous conditions. One might, in case of a tendency of the eyes to deviate in, for example, under circumstances of moderate leaning of the meridians, maintain the fusion of the images, but should this be accompanied by a tilting of the vertical meridian of a more considerable extent, the fusion might no longer be possible. Hence, it could not be said that at n degrees of deviating tendency esophoria must become esotropia.

With an increased difficulty in adjusting a declination, a very slight degree of esophoria might become esotropia.

The boundary lines for the sustained pressure of single vision are then, like many other boundaries of classification in science, somewhat extensible, yet they will be found, on the whole, practical and satisfactory.

As we direct our attention to the first group of anomalies, that in which single vision is habitually maintained, we find a field of observation rich in interest and of preëminent importance in its practical bearing.

SECTION XXXI.

EQUILIBRIUM.

In a system like this the term equilibrium should signify a condition in which all the muscles of the two eyes are so proportioned and adjusted in respect to their dynamic conditions that with the least expenditure of nervous energy, when the gaze is directed to an object in the median plane at the level of the eye and at infinite distance while the head is in the primary position, the visual lines should be parallel and in the same horizontal plane. In turning from this position to any other they should come to the new position in exact conformity with the Law of Listing.

This, when the normal plane of vision is too high or too low or when marked declination exists, does not automatically occur. The tersions are disproportioned to the extent of the ascensional (or decensional) angle and the lateral displacements, and hence the visual lines do not under such circumstances unite at the point intended without an impulse of the will, which is beyond what we may for convenience term the automatic effort. A condition of positive equilibrium then would involve the most favorable normal plane of vision, an absence of declination and parallelism of the visual lines under the conditions stated.

The terminology to be employed in the discussion of the conditions in the second division of this classification do not relate exclusively to this condition of absolute equilibrium, but to that equilibrium which may be found when associated with various adjustments of the plane of vision or of the meridians. Thus, orthophoria may exist, notwithstanding the presence of anophoria or declination.

SECTION XXXII.

Class III.

FIRST DIVISION.

Adjustments of the Directing Muscles of the Two Eyes by Which the Two Visual Lines May Be and Are so Controlled that Binocular Vision is Habitually Maintained.

I. ORTHOPHORIA.

The term is applied to the visual lines, and means that these lines are, for a given plane, in a state of typical adjustment for that plane. They neither have a tendency to approach nor to recede from each other, nor does one have a tendency to rise above or to fall below the other.

All this, however, is only when the minimum impulse is sent along the nerves governing these movements.

Orthophoria, then, while indicating the best adjustment in the plane in which we find the eyes, may not be the ideal adjustment when the question of anophoria, katophoria, or declination is taken into consideration.

SECTION XXXIII.

HETEROPHORIA.

From what has been said in the section devoted to "Declination" it is evident that various conditions of heterophoria may manifest themselves as the result of the automatic effort to adjust the retinal meridians for the field of view. *As a matter of fact, heterophoria may be regarded as in general a resultant of declination and of adjustments of the eyes above or below a certain plane relative to the cranium.*

Accepting this view, it is apparent that the various forms of heterophoria are not such independent states as to demand unqualified consideration separate from their causative conditions.

Yet, so individualized are some of the phenomena of the different forms of heterophoria, that it is convenient and advisable to study these phenomena in relation with each form. Hence, if these forms are isolated for convenience of study, it must be borne in mind that they are always, in practice, to be associated with the underlying conditions.

The term heterophoria, indicating an absence of the ideal adjustments in a given plane, is naturally antithetical to the term orthophoria. In heterophoria there exists a tendency or tendencies unfavorable to the adjustments of the eyes in perfect accord. There is power to hold the two eyes in such relation that single vision is habitually maintained, but the tendency is for the visual lines to

drift out of their proper relations. It is therefore by an effort of the will, conscious or unconscious, that they are forbidden thus to drift. Even at the expense of a good deal of automatic effort, single vision may be maintained. This tendency on the part of the visual lines to deviate from the legitimate path, but which can be restrained, must not be confounded with the unrestrained deviation which results in actual strabismus.

There is in the tendencies of heterophoria no actual turning of one or other of the visual lines in directions not corresponding with the point of fixation. In gazing directly forward at a distant object parallelism is supposed.

There is, however, on the part of one or more muscles a tendency to disturb this balance, and should the nervous control be removed so as to permit of the consummation of this tendency, an actual deviation would result.

Such irregular tendencies may exist in as many directions as there are forces to induce irregular tension—that is, not only in as many directions as there are muscles to act, but in as many directions as the muscles may combine to act. In short, the tendencies of heterophoria may exist in all directions.

Without stopping here to discuss the question whether it is important to discover all these tendencies and to determine as far as possible their extent—a subject which will occupy our attention as we advance—we may here assume that all are important, and that no just appreciation of the conditions which induce asthenopic or kindred troubles can be acquired which does not take them all into account.

It becomes necessary, then, to establish some methodical course of investigating and of recording such anomalies.

As long as “insufficiency of the interni” was the objective end of the investigation there was no uniform custom or rule for examining in relation to that condition either as to the distance at which the test object should be placed or as to the exact character of the condition which might be found, unless the dot and line test of von Graefe should be so considered. Beside the dot and line test, von Graefe used a prism held in the hand while the patient looked at an object six feet distant, or he caused the patient to look at a pencil, his finger, etc., and as the object approached the eyes he observed the distance at which one eye deviated out while the other remained in fixation.

Still another method was that of passing a screen from one eye to the other, concealing the image alternately of one and the other eye, while the examiner observed whether the eye released from the screen was forced to move in for fixation.

When, by the prism and dot and line test, the degree of "insufficiency" was determined, it was advised to examine the abduction at a greater distance. Von Graefe did not specify the distance, but mentions his experience in abduction and adduction at a distance of six feet.

SECTION XXXIV.

PRINCIPLES OF EXAMINATIONS IN HETEROPHORIA.

The manner in which the faulty conditions of heterophoria may be detected was shown by myself in connection with the classification above mentioned.¹

In order that in what is to follow there be no confusion from the use of instruments in which there are any complications, the simplest possible methods will in this introductory section be employed. The imperfection of such methods may for the time be overlooked until the principles are mastered, when more accurate practical methods must take the place of those used here tentatively.

Position of the Person Examined.—The head is to be in the primary position, the body, sitting or standing, preferably the former, erect, without crossing of the knees or any bodily restraint. The body should be perfectly free. The test object, which may be the flame of a candle or other bright point not too large, should be not less than twenty feet in front of the observer in the median line and at the height of the eyes.

Tests by Diplopia.—Whatever objections there may be to the use of the diplopia tests they are practically the only tests upon which reliance can be placed.

The theory of the tests by diplopia rests upon the ground that when single vision becomes impossible the voluntary efforts for adjustment will be abandoned, and it is assumed that the visual lines will adjust themselves in the directions and mutual relations which would exist if the minimum of nervous impulse were acting upon them.

¹ Page 215.

This theory is not entirely correct and, indeed, may under certain circumstances be very far from correct. The means of guarding against errors from the method will engage our attention as we proceed.

The test object (flame of candle, bright spot, etc.) should be seen against a dark background and one on which are *no marks or figures* by which the eyes are helped to form a judgment concerning the vertical or horizontal planes. Such lines as oculists have sometimes introduced about the test object, in order that the patient may answer positively, defeat the object of the test.

Diplopia may be caused by a prism which will be so strong that the effort to unite images will be abandoned but not so strong as to remove the images too far.

Let diplopia be first induced in the vertical direction. If the prism is placed with its base down before the right eye the image of

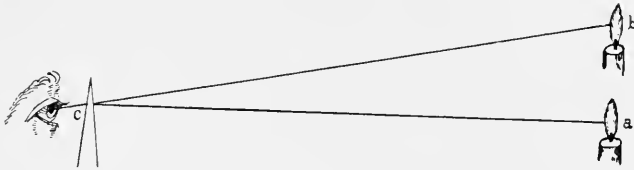

Fig. 102.

the candle flame seen by that eye will be elevated above the other, since the action of the prism will be to deflect the beam of light downward toward the base of the prism and the image will consequently appear at a position higher than that which it really occupies, while the image of the other candle will remain as before.

If the eye fixes the candle flame through the prism at *c* (Fig. 102), the ray *ac* is deflected downward as it traverses the prism at *c*, and the image of the flame is not seen in the direction *ac*, but in the direction of the deflected ray, and will appear in the direction *cb*.

If, the eyes being released from the necessity of holding the visual lines in parallel directions, the visual lines now take the direction which is most easy and natural, one of three things will happen: The image of the right eye will appear exactly in a vertical line above the other, or it will deviate to the right or deviate to the left of the other. It may indeed do more than this. If the object is an erect one, like a candle, it may appear to lean, or it may appear in advance of the lower flame or beyond it.

What are the indications of these various phenomena? The inquiry will for the present be limited to the first three bearings above mentioned.

When the image of the upper flame is seen exactly above the other it means that the impression is received at a point of the retina lower than that at which the impression of the left flame is received, but in the corresponding vertical meridian of each eye. In other words, although the eye has been given an opportunity to swing to the right or to the left, it has not improved that opportunity. Had we placed behind the flame a vertical white line by which the judgment would have been corrected, the act of the will would, to some extent at least, have exerted an influence to bring the upper flame into line. As no such mental aid has been rendered, we may assume that, owing to the fact that the laterally acting muscles of the two eyes are closely in equilibrium, the nervous impulse which directs the

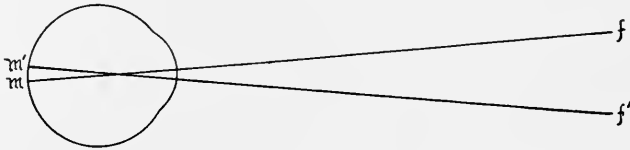

Fig. 103.

left eye to a given point in the horizontal plane is exactly sufficient to direct the right to a precisely corresponding point in its horizon. There is found no tendency on the part of the eyes to vary from parallelism.

Next, suppose that the image of the right eye has deviated to the right. In this case some relative change in the position of the eye has taken place. If the image is seen at the right of the other its impression is received at a vertical meridian at the left of the macula of the right eye, assuming that the left image continues to be seen at the macula of that eye. If in the figure (Fig. 103) the image of f falls at the macula m , the image seen at the point m' at the left of the macula would appear at f' or at the right of the image f . Diplopia when it occurs in this relation, that is, when the image seen by the right eye is seen at the right side and that seen by the left eye is located at the left side, is known as *homonymous* diplopia (*homonymous*—having the same name). Whether, in our experiment, the left eye continues to fix the image at the macula while the image of the right

is received at a different meridian, or whether both images are somewhat displaced, is not, in this connection, a question of any practical importance, but for the sake of the illustration we say assume that the right image drifts. This homonymous diplopia then would mean, on this assumption, that the point m of the figure had slipped to the left to occupy the position of the point m' . The eye has rotated *in* or toward the left.

Hence, when the double images are homonymous under the circumstances of our examination, the visual lines are no longer parallel, but approach each other.

This deviation of the visual lines toward each other can be measured. If a prism is placed before either the left eye, which is supposed to be directed to the exact position of the flame, or before the right, which has already the vertical prism before it, the image may be deflected to the right or left if the prism has its base at the side. To measure the deviation of homonymous images the measuring prism must have its base out, or in the direction of the temple.

By trying one prism after another, the one which brings the two images to an exact vertical line is chosen as that which measures the deviation inward, for it is this prism which causes the beam of light to deflect to the right just far enough to reach the meridian of the macula. Hence the deviation under these circumstances may be said to be 2° , 4° , etc., of prism. As a degree (or diopter) of prism causes a deflection of about $\frac{1}{2}^\circ$ of arc, the actual deviation of the lines then in the case of 4° would be about 2° of arc.

Such a deviation is not to be recorded, as it has often been in print, as 2° or 4° of homonymous diplopia. The diplopia was first formed by the vertical prism, and the deviation under the circumstances represents the *deviating tendency* and not an actual diplopia when no prism is interposed.

Had the image seen by the right eye, the higher, in the original experiment, appeared at the left, there would have been a crossing of the images, and heteronymous deviation would have been present.

This would have signified that the image of the flame caused an impression on the right retina at a vertical meridian at the right of the macula. Turning to Fig. 103 it will be seen that in order to do this the eye would have to turn to the right, that is, the visual axis of this eye would deviate outward from the left. As in the first instance, it is unnecessary to inquire whether, as a fact, the right

eye only deviates, or whether the deviation is divided. Our attention is directed for the present to the right eye.

As the point at which the impression is made is at the right of the macula, the amount of turning out of the axis may, as before, be measured by a prism which will deflect the light toward the left. That is, by a prism with its base in.

This, in regard to the three conditions mentioned, is what may be learned by causing diplopia in the vertical direction.

Let the experiment be varied by placing before the right eye a prism with its base exactly at right angles to the horizon. If it is with the base out or toward the temple the eyes will in most cases make such an adjustment as to unite the images, unless the prism is of very high refracting power, and so many elements of error may result that it is better to try the other way. Placing it with the base toward the nose, in, a prism of moderate degree will in the majority of cases overcome the efforts to unite and diplopia will result.

This time, if the prism is held correctly and the ocular adjustments are perfect, the images will appear in a horizontal line. The prism deflects the light toward the nasal side of the retina and homonymous diplopia is induced.

Recurring to the theory that, the necessity for maintaining parallelism having been interrupted, the eye will drift where it is most agreeable, that is, to the place of minimum tension, if the images remain horizontal, it is because the image of the right eye has been deflected outward directly along the horizontal meridian of the retina, which passes through the macula. Had there been a tendency on the part of one eye to permit the visual line to drift above or below the other visual line, evidence would have been present that in respect to directing the eyes horizontally there was a want of equilibrium. It would mean that the tensions of the vertically acting muscles of the two eyes are unequal, but it would not prove that the eye which remains the highest is really too high, nor would it even suggest that the superior or the inferior rectus of one or the other eye is "insufficient" to perform its function perfectly. It may be entirely a question of declination.

It will be found as we advance that as a matter of fact when there is paresis or weakness of one of the elevating muscles or depressing muscles diplopia will usually be accompanied by the phenomenon of images at unequal heights, but the question of paresis or of weakness must be determined in quite another manner.

If, in the experiment, the image of the right eye (which in this case would be the right image) appears lower than the other, it is because the impression is made at a point in the retina situated on a horizontal meridian higher than the macula (we are adhering to the supposition, no matter whether correct or not, that the image changes position only in the eye before which the prism is placed). If we examine the same diagram (Fig. 103) it will appear why the image of the right is below.

If the image is at f , but is seen at f' or below, then the image does not fall upon the macula, but at a point in a horizontal plane above the macula. But, since the line connecting the object, the nodal point and the macula must be a straight line (the deflection caused by the prism being here neglected), the point m must occupy the position m' . Hence, the axis of this eye will in fact be directed upward.

From this it may be concluded that, in the experiment, the lowest image belongs to the eye whose axis points highest. When the image of the right eye is above, the axis of this eye points below the other; when lowest, it points above the other.

The measurement of this deviation may be made as in case of the previous experiment. If the image is low (and the impression high) the prism which will just correct the position of the impression by bringing it down to the meridian of the macula will be the measure of the deviation.

By these two experiments may be found the tendencies of the visual lines to drift toward each other, away from each other, or to assume different relations to the horizontal plane, and by combining the results, the different elements of an oblique tendency may be determined.

It remains to make brief mention of two other classes of phenomena which may be found by inducing diplopia in this manner.

When the two images are separated either in the horizontal or vertical direction, if they are the images of an erect linear object, they may not be parallel. If, for example, a candle is used for the object, and if diplopia is induced by the horizontal prism, the images may appear to lean toward each other at the top or to lean away from each other. In the first instance there is evidence that the vertical meridian of one or of both eyes leans *out* at the top, for the apparent leaning of the image will be exactly opposite to the real leaning of the meridian of the eye.

This phenomenon belongs to the subject of declinations, and the reader is referred to the section devoted to that topic for more detailed discussion. Still another phenomenon requires attention. The images in case of such diplopia as is made in our experiment with the prism (page 264) do not always appear at equal distances. Suppose that the image of the right eye appears more distant than the other and more distant than it is in reality.

This brings us somewhat beyond the realm of physiological optics in which we have thus far found the answer to our inquiries, into that of physiological psychology.

The distance of the object in this case is measured mentally by the muscular effort demanded in the adjustment, and this leads to the fact that, notwithstanding the theoretical passiveness of adjustments of the eyes in the experiments, there remains an element of muscular tension. The consciousness of where an image ought to be is extremely potent and does not surrender on slight inducement. The ordinary experience of the individual is here brought into requisition. In general, when we look at near objects the plane of regard is depressed. This is not, of course, always so. If we look at the faces of our friends they are in the plane of our eyes. But, in general, it is not the case that a near object is at the level of the eye. If we walk upon the seashore we look down upon the breaker which rolls in from the sea. But we elevate the gaze to see the ship at the horizon. Hence the sensation of lifting the eyes becomes associated with the idea of distance. Now in the experiment, if the observer, in the instinctive effort to bring the images to a horizontal plane exerts some force to raise one of the eyes while none or comparatively less is exerted in that direction by the other, the image of this eye appears more distant than the other. Beyond this is the effect of torsions, which occur in looking down with convergence, but which may in certain cases of hyperphoria be so modified as to become an important element in the illusion of apparent comparative distance.

SECTION XXXV.

SIGNIFICANCE OF HETEROPHORIC CONDITIONS.¹

We have already seen that the ideas of space, of form, and of depth as acquired through the visual sense are derived from the muscular sense, and therefore from the actions almost exclusively of the muscles which move the eyes. We have also seen (Section XXIV) that the retinal spaces which may become the measures of these movements are not only often minute and never large, but that corresponding retinal spaces must mark corresponding movements of the two eyes.

In order to see clearly, a perfect horopter must be formed, and to form a perfect horopter, perfect adjustments of the two eyes, not only in respect to the directions of the visual lines, but in respect to the relative positions of the meridians, must be induced and maintained.

When it is considered that this marvelous accuracy of estimation of the muscular movements of the two eyes must be brought into continuous requisition so long as the mind takes cognizance of objects through the visual sense, and that these infinitely nice adjustments must be made in numberless directions and positions with a rapidity which is, paradoxical as the expression may appear, quicker than thought, it must become evident that the question of the comparative ease and perfection with which these movements can be made, and, in fact, are made, assumes a position of great practical importance. If, with every glance and during all the hours that the visual function is exercised, this demand for exact estimations of energy expended and this nice comparison of the relative energy directed to each eye is never for an instant relinquished, it is evident that it cannot require very gross impediments in the way of the free action of these delicate muscles nor very considerable faults in the associations of movements to induce disturbance of nervous actions which may reach to the highest degree.

We may not be able to assume that, with a certain degree of fault in the associated movements, a certain form or degree of nervous disturbance must follow.

¹The principles applying to heterophoria in this section are equally applicable to declinations and anomalies of the adjustments of the eyes for the plane of vision.

The native force at the disposal of the individual, the environments in which he may be placed, the character of the demands made upon the adjusting and measuring faculties of the eyes, the demands made upon the nervous forces in other directions, are some of the elements to determine the reactions which must follow the disadvantageous use of the eyes when any of the anomalous conditions of heterophoria are present.

Hence, it must happen that conditions of heterophoria which are apparently little disturbing in one person may induce most important disturbances in another person. The same individual who, if occupied in the open air and engaged only in looking at objects in a very general way, may be quite free from any reactions from heterophoria, will perhaps become the victim of some severe neurosis if he is obliged to remain in-doors and devote himself to steady work requiring exact and continuous use of the eyes. The fact, then, that one may have experienced no inconvenience from the use of the eyes may not signify that there is a well balanced adjustment of the muscles.

A difference in surroundings, the demands for unusual hours of work, as in attending upon the sick, or the depressed state of the nervous forces after an illness, may reveal the fault which was not before recognized.

SECTION XXXVI.

THE TIME FOR ATTENDING TO THE ANOMALIES OF HETEROPHORIA.

The question when the anomalous conditions of heterophoria should receive attention is one of importance. Should one wait until some special form of suffering leads to the conclusion that the eyes are at fault before giving them relief?¹

Even in the conditions which have been mentioned in which by virtue of surplus energy and favorable environments the effects of heterophoria are not observed, it is evident that the cost to the nervous system of adjusting the eyes when heterophoria exists is greater than it would be with orthophoria. Other things being equal, the person with orthophoria would be able to accomplish more work demanding the expenditure of nervous energy than the person with some form of heterophoria. That a vast number of children fall

¹As in the last section, the principles applied to heterophoria are also applicable to declinations, anophoria and katophoria.

behind in studies because of such faults, although there may be no local manifestation of discomfort from the use of the eyes, cannot be doubted. In the race for precedence in which all at the present time are so earnestly engaged, the necessity for the removal of every handicap is evident.

Of two boys or of two girls of equal native abilities, of equal physical force and of equal advantages, the boy or the girl with orthophoria is destined to outstrip his or her companion who is the subject of heterophoria.

This being the case, is it best to wait until the mischief is accomplished?

There is no more important principle in medicine than that it is better to prevent than to heal a disease.

Hence, the self-evident answer is that every boy or girl on entering school is fairly entitled to be examined in this respect, and that if any fault is found, such provision as is best calculated to reduce the disadvantage to its lowest degree should be made.

SECTION XXXVII.

SPECIFIC METHODS AND INSTRUMENTS FOR EXAMINATIONS IN HETEROPHORIA.

In the discussion of the general principles of examinations in heterophoria it was found that the deviating tendencies might be shown by inducing diplopia by means of a prism.

This method is subject to several objections, some of them of great importance. It is only necessary to mention that it is difficult to determine when the head is exactly in the primary position and when the prism is held exactly so as to refract in a certain direction. Most important is the fact that when a prism or any instrument for determining heterophoria is held near the eye there is a strong tendency on the part of the eyes to neutralize the effect by adjustments of abduction, adduction, or sursumduction.¹

In view of these and other sources of error, I devised, in 1888,

¹This subject has been discussed by the author somewhat at length in the *Ophthalmic Record*, January, 1892.

the *phorometer*, in which the aim was to combine the greatest simplicity with the greatest attainable accuracy.

By means of this instrument may be made the most reliable tests which at present we are able to make, and the information gained is more uniform and the different facts obtained are more in harmony with each other than when examinations are made by other methods.

THE PHOROMETER.

The phorometer consists of a standard and adjustable arm and a slide with rotating prisms.¹ (Figs. 104 and 105.)

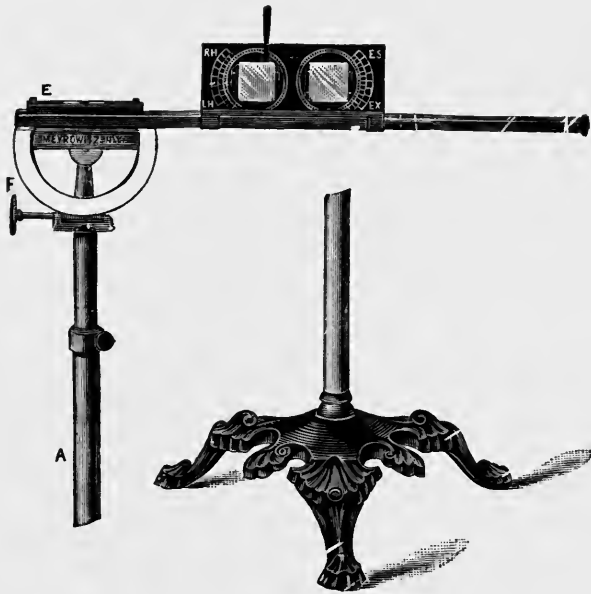

Fig. 104.—Author's Phorometer.

The standard is supported by a tripod and is extensible. At the upper extremity is an endless screw locking an arc by which motion is communicated to the arm. The arm, directly over the standard,

¹ The phorometer was described in the *Medical Record*, May 5, 1888. It had, however, been publicly used and exhibited several months prior to this publication.

is furnished with a spirit level. A slide containing two cells (Fig. 105) is so attached to the arm that it can be moved to any part of it. In each cell rotates a disc and each disc carries a prism of 5° . Each disc is furnished with a border of cogs, and a small gear wheel placed between the two discs communicates movement from one disc to the other. A raised band around the outer border of each cell has a scale of degrees or diopters increasing from the center each way from 0° to 8° , the numbers representing the refracting power of prisms in diopters. The scale represents a greater degree of accuracy and uniformity in the refraction of prisms than is found in

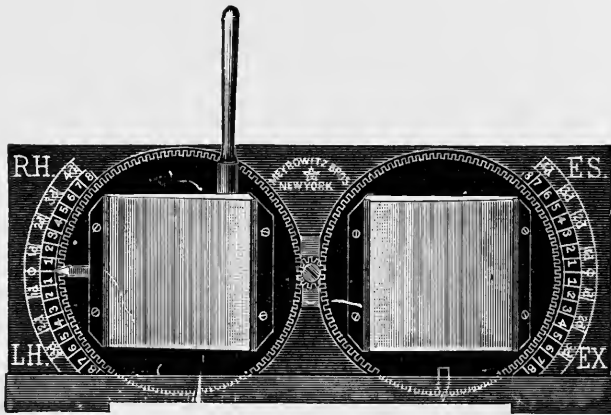

Fig. 105.—Author's Improved Rotating Prism Slide.

most of the trial cases in common use. By working the handle which is attached to one of the cells the two prisms are rotated in different directions; that is, if the edge of the right prism is caused to turn down, the edge of the left turns up, etc. The letters, R.H., L.H., Es., and Ex. indicate the direction of the pointer when right or left hyperphoria, esophoria, or exophoria is found.

Directions for Using the Phorometer.—In using the phorometer the instrument is placed before the patient to be examined and always somewhat removed from the eyes. A distance of from four to six inches between the eyes and the slide is sufficient to permit of some freedom in respect to the movements of the head, and to insure against the natural inclination to neutralize the indications of hetero-

phoria which is always present when the instrument for testing is held close to the eyes.

By raising or lowering the upper part of the standard the arm is brought to such a height that the patient, with the head as nearly as is convenient in the primary position, can look through the glasses toward an object, preferably the flame of a candle, situated at a distance of twenty feet and at the height of the eyes. The slide with the prisms will then be so placed that the side on which are the letters and the scales will be *from* the patient. The end of the slide marked R.H. and L.H. will then be before the right eye of the patient, and that marked Es. and Ex. will be before the left eye.

Before making the examination the arm should be brought to a perfect level by means of the screw, as shown by the spirit level.

If the examination is to be made with reference to the horizontal position of the images, the handle of the slide is brought to the upright position and the pointer to the 0° mark at the right side. The prisms are then absolutely level with their bases in, and homonymous diplopia is induced unless the eyes are able by abduction to overcome the prisms. This may be done in cases of rather high degree of exophoria, and it then becomes necessary to supplement the refracting power of the prisms by the addition of another prism.

The slide with the prisms (Fig. 105) is provided with a little shelf or with a slot behind the prisms, and an extra prism, cut square and very exact as to its axis, may be slipped behind one of the rotating prisms. It is well to be provided with about three such square prisms, one each of 4° , of 6° , and of 8° . These will serve for almost any emergency for one or two of these additional prisms will prevent the union of images. If they still unite we are dealing with a rather high degree of strabismus and not with heterophoria.

Having then induced homonymous diplopia, the next step is to ascertain whether the two images are absolutely in the same horizontal plane.

If the candle is in a part of the room otherwise only feebly lighted, it is an advantage and all casings, shelves, or other objects which may assist the patient in correcting his notions as to the horizon should, as far as possible, be absent. The practice which some have adopted, of drawing horizontal and vertical lines behind the object (the candle), is thoroughly bad, since the impulse to correct a difference in height of the images or a difference laterally becomes

so much greater when such aids are present that the test is largely and often completely neutralized.

If it is found that one image is higher than the other the prisms are rotated until the images are level. By making the last part of the rotation quite slow a higher degree of correction may possibly be made than if the adjustment is quickly made.

The pointer now marks the amount of deviation of the images from the horizontal plane. If the pointer is above the 0° point, it indicates n° of *right hyperphoria*, but if below the 0° mark, n° of *left hyperphoria*. It is well, after the test has been made, to throw the prisms out of position in order to verify the correctness of the result.

This test being made the lever is next brought down rotating

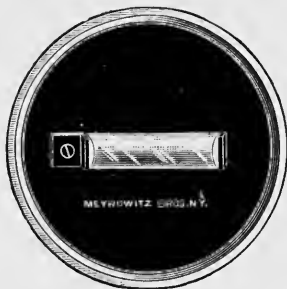

Fig. 106.—Maddox Rod.

the prisms, so that they are adjusted one with base down, the other with base up. It is now ascertained whether the two images are in a vertical line. If the upper image is deflected to the right the pointer (on the left end of the slide) will be moved toward the letters Ex., that is, downward; if toward the left the pointer will move upward toward the letters Es. The figures on the margin will indicate the degree of exophoria or esophoria.

*Rod Test for Heterophoria.*¹—A form of test for heterophoria which has the advantage of being convenient, portable, and inexpensive is the “rod test,” which consists of a disc of metal or hard rubber having the size of a lens of the trial case and which holds in the center a glass rod (see Fig. 106). The effect of the rod is to transform the flame of a candle into a long streak of light. The

¹ E. H. Maddox: *Ophthalmic Review*, May, 1890.

theory of the rod test is, the image of the eye before which the rod is placed being so dissimilar to that of the other eye, no effort will be made to bring these strongly contrasting images into union by the exercise of force in overcoming heterophoric tendencies.

If the line deviates from the flame the prism which brings it to pass through the flame gives the measure of the heterophoria. Prisms from the trial case are used for these measurements as in the case of the prism held in the hand.

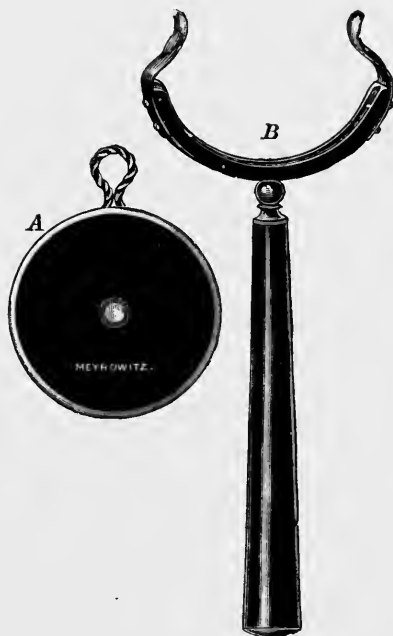

Fig. 107.—Author's Stenopaic Lens.

*Stevens's Stenopaic Lens.*¹—This is another test based upon the principle of contrasting images. (Figs. 107 and 108.) Using this lens, the flame of a candle is transformed into a large and perfectly defined disc of diffused light. The principle of the test is in the fact that if a distant flame or point of light is seen through a very strong convex glass the flame becomes a confused mass of light, and that if the lens is then covered except a very small opening, the mass

¹G. T. Stevens: *Annales d'Oculistique*, 1892, and *New York Medical Journal*, January 16, 1892.

of light becomes a well-defined disc, and the prismatic effort which would be induced by looking through a point even 1 millimeter from the center is eliminated.

The lens as constructed is a disc of hard rubber of the size of the glasses of the trial case. In the center is set a lens of 13 diopters refraction which is seen only through an opening less than 1 millimeter in diameter. As this is smaller than the pupil it does not permit of any deflections of the image by prismatic effect.

In orthophoria, the flame of the candle which is not transformed is seen exactly in the center of the disc of light as is shown in Fig. 108 D. In heterophoria the flame passes to one side, above or below the center or in a direction between these, and may remain within the limits of the disc of light or may pass beyond it.

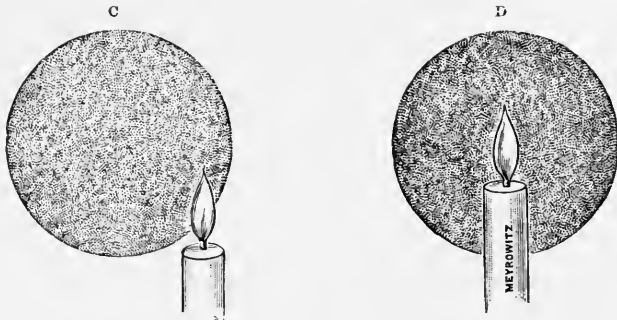

Fig. 108.—Form of Images by the Author's Stenopaic Lens.

If the flame passes to one side and also rises above the center or falls below it, we have all the elements of the compound tendency revealed. (Fig. 108 C.) The prism which forces the flame back to the center of the disc is the measure of the deviating tendency.

The disadvantages of the instrument are those common to every instrument held close to the eye for making these examinations.

The theory that there is an absence of the impulse to force images which are contrasting to the macula of each eye is not founded on facts. Even the greatest contrasts of form or of character of the images impressed upon the two retinas do not cause a suppression of the fusion impulse. If one eye is directed toward a strong point of light, the other eye will seek to place the image of the point, however great its change, upon the macula. Hence the tests of this character are unsatisfactory. Within very narrow limits the stenopaic

lens is perhaps one of the most exact. So long as the flame of the candle remains within the limits of the halo there is probably no effort at abduction, adduction, or sursumduction. This appears clearly in some cases of anisometropia; where one eye is emetropic and the other very myopic it will be seen that the well-defined image will swing up to the very border of the diffused one, but will not pass beyond it. This is because the eye cannot select between different parts of the diffused image, and so long as the outer border is impressed at the macula, the demand for adjustment here is satisfied. The stenopaic lens serves exactly this purpose, and its registration is correct within this narrow limit, that which cannot be said of any other test held near the eye.

There are many other important elements of error than those mentioned in all the instruments used for inducing contrasting images.

Tests of Heterophoria Auxiliary to the Phorometer.—The tests by the phorometer are not absolute. There are other conditions which must be known in order fully to understand the relative actions of the muscles which direct the movements of the eyes.

It therefore becomes necessary to avail ourselves of every other means of ascertaining their actual relations.

One of these means is to determine the ability of the eyes to overcome difficulties in the fusion of images. This we do by the processes known as abduction, adduction, and sursumduction. In each case the process is measured by the strength of prism which the eyes can overcome.

Von Graefe called the effort to unite images which have been separated by a prism by rotating the eyes outward, *abduction*.¹ He called the effort to overcome the diplopia caused by prisms with the bases out, and which is accomplished by rotating the eyes in, *adduction*.²

The ability to overcome a prism with its base up or down before one eye, has been called by myself *sursumduction*.³

A prism with the base down before one eye is equivalent to an equal prism with its base up before the other. The effort made in overcoming a prism with its base down before the right eye is known as *right sursumduction*. A similar effort to overcome a prism with

¹ Von Graefe: *Archiv für Ophthalmologie*, Bd. viii, 2.

² Von Graefe: *Op. cit.*

³ Stevens: *Archives d'Ophthalmologie*, November, 1886.

its base down before the left eye is *left sursumduction*.¹ Naturally the same terms apply if the prism is reversed before the opposite eye.

The standard for abduction which I adopted many years ago is 8° of prism.

With orthophoria the great majority of persons will accomplish this either on the first trial or after a few trials on different days. This standard has been confirmed by many thousands of examinations, and great experience has shown that the ability to overcome a prism with its base in of considerably more than this, or the want of ability to overcome one of nearly this grade, is accompanied generally with other indications of heterophoria, and always with important declination.

We cannot assume that because there is ability only to overcome a prism of 6° that there is esophoria of 2° , nor can we say that there is exophoria of 4° because the abduction is 12° . It happens not unfrequently that with an abduction of only 5° there is, as shown by the phorometer, exophoria of one or more diopters, and with the excessive abduction of 12° , the phorometer may register 5° or 6° esophoria. While the ability to overcome a very strong prism with its base in may be associated with actual converging strabismus, and while the failure to overcome a comparatively weak prism in the same direction may be associated with an outward balance, these irregular forms of abduction always indicate a complicating tendency which may be and often is in the condition of hyperphoria, or more often it is dependent upon a physiological declination or leaning of the vertical meridians of one or of both eyes away from the actual vertical position.

The ability to overcome prisms by the act of convergence, that is, uniting the images when the bases of the prisms are out, is known as *adduction*. The ability in cases of orthophoria is about 50° , but may be considerably higher in some cases. The ability may be so greatly modified by practice that an exact standard of adduction cannot be stated. There is something in acquiring a "knack" of doing this which enables a person who has acquired it to do more than he otherwise would, and there is also a skill which the surgeon may acquire by which he can induce a given person to do very much more than a surgeon who has not learned how to do it.

In overcoming prisms with the base in, the grade of prism which

¹ Stevens: *Op. cit.*

can in most cases be overcome is such that it makes little practical difference whether the whole prismatic effect is before one eye or is divided between the two eyes. In adduction, however, the conditions are entirely different, and the prisms must be as nearly as practicable placed equally before the two eyes. Otherwise, the free eye would be directed exactly toward the object while the other would be forced to turn in to the full extent of the value of the prism.

The prism also loses its effect long before it reaches the full ability of the eyes to converge, since a prism passing 45° has a refracting character quite different from one of less angle.

Many points of a similar character may be misapprehended by one who attempts to make investigations in this field, unless all the elements, not only of a physiological, but of an optical nature are well considered.

Should the ability to overcome by adduction after a reasonable amount of practice fail to reach 50° of prism, it is likely to be associated with either a considerable degree of exophoria or an important condition of hyperphoria, or the images tilt as the eyes converge.

As a practical test I many years ago abandoned the adducting ability except in a few cases. The value of the practice of overcoming prisms is not here in question.

The ability to overcome prisms with the bases up or down, sursumduction, is in most cases about 2° of prism, but in myopia with high declination it is sometimes as high as 9° , or even more.

Sursumduction is, in many cases, a valuable test. Thus, one who may show little or no hyperphoria by the phorometer may show a sursumduction ability materially greater in one direction than in the other. When this is associated with a corresponding difference in the upward rotations, as shown by the tropometer, it is evident that the muscular adjustment is less satisfactory than is indicated by the phorometer.

An excess of sursumduction leads to the presumption that unusual demands have been imposed on the vertically acting muscles in maintaining a freedom from the effects of hyperphoria.

Sursumduction ability may be tested by placing a prism before each eye alternately with its base in the same direction or by placing it before the same eye with its base alternately up and down. The effect of overcoming a prism with its base down before one eye is identical with that for uniting with the base up before the other. Hence,

sursumduction for both eyes may be made with the prism before either eye by simply reversing it.

After testing sursumduction in one direction, a rest of a few minutes should be permitted before the trial in the opposite direction.

Since the introduction of the elinoscope into practical use non-conformity of the abduction, adduction, and sursumduction with the findings by the phorometer are in a large measure explained, and these collateral tests are less in demand than formerly, though they are not to be ignored.

Tests at Near Points.—The test which von Graefe employed in his cases of “insufficiency of the interni” was made at the near point—the point of reading of the person examined. By a prism of 15° held in the hand he caused the image of the dot seen by one eye to rise above that seen by the other. If the upper dot continued in the line there was no insufficiency. If it deviated from the line so that there were not only two dots but two lines, there was “insufficiency” equal to the value of the prism which would put both dots in the same line. Several points are to be considered in respect to such a test.

The great majority of von Graefe’s cases of “insufficiency of the interni” were extremely myopic and had a condition which he characterized as “latent strabismus,” but which at the present time would, in most instances, be regarded as actual diverging strabismus. Diverging strabismus is less conspicuous to an observer than a converging squint of the same degree.

A person looking at an object like the dot situated upon a vertical line would, if vertical diplopia were induced, make an effort similar to the effort of abduction or adduction to hold the dot where the line would suggest that it should be. The association of ideas and of muscular action is of the same character as that which induces the effort to overcome prisms.

In von Graefe’s cases of moderate diverging strabismus with extreme myopia, the effort to converge at the very near reading point was one which could not be sustained. The internal recti muscles were, as he said, quite “insufficient” for this task. He did not say that they were weak, as some have used that term; they were insufficient to do a thing which muscles of normal power could not well do.

Such a test would have no significance in the cases known at present as exophoria or esophoria; for the impulse to hold the dot in

its proper line is sufficiently great to accomplish its purpose in a great number of anomalous cases short of actual strabismus.

An exophoria of 5° or 6° or an esophoria of like extent would not necessarily affect such a test at all.

If on the other hand we remove, as far as possible, every suggestion of the necessity for associating the two images with any particular direction we get quite different results.

In general, with, for example, a simple dot in the center of a pretty broad page held at the distance of fifteen inches, the induction of vertical diplopia will be accompanied by a deviation of the dots from the vertical line. There is in fact no reason except the association of ideas why they should not deviate to the extent of permitting the visual lines to be in the most easy and natural position. If the page and dot should be carried, for example, to the right so that the right visual line would have a direction parallel with the median plane, and if the prism were then placed base down before the left eye, the images might and would, except so far as the psychological association might have an influence, deviate so that the two visual lines would be parallel.

As a matter of fact, the psychological element is rarely entirely eliminated, and a certain amount of adjustment almost always occurs. But of the exact amount in any individual case we are unable to predicate.

Hence it must be seen that a test by vertical diplopia at the reading distance can have no absolute value. It may become a useful collateral test, for should it act in a manner not in harmony with the general facts it might be, and often is, suggestive of certain conditions which may not be very apparent by other tests.

Suppose, for example, that the person examined should manifest by the phorometer at the distance a slight exophoria and only a fraction of a degree of hyperphoria. If this person were to show a marked convergence by the test with vertical diplopia at the near point, it would be legitimate to suppose that a complication of muscular tensions might result from declination.

In practice, a person with nearly the adjustment of orthophoria will in general show at the near point by such a test (freed from all suggestive lines and marks) a failure of convergence for the distance of the object of about from 4° to 6° of prism.

It will be seen then that as a test of the state of the ocular muscles diplopia of the near point has no direct value.

But it will also be seen, from what has preceded, that it may have a certain value as a collateral test.

Exophoria and Esophoria in Accommodation.—In my earlier writings¹ I attempted to make clear the facts above stated and to emphasize the truth that diplopia tests at a distance induced by prisms and those induced near the eyes had not the same meaning. In order to distinguish the results of examinations made at the two points I included in my classification of conditions which might be found, “esophoria in accommodation,” and “exophoria in accommodation,” the latter of which was somewhat similar to the “insufficiency of the interni” of von Graefe.

Generally, I think that the radical distinction between “exophoria” and “exophoria in accommodation” was understood. Yet some writers have interpreted the terms as meaning the same thing discovered in different places.

In view of such misunderstanding it may be a question whether the terms “exophoria in accommodation,” etc., were not unfortunate.

In any case it is proper here to emphasize the fact that these conditions found at near points do not represent the adjustments of the eye muscles. They may vary from one examination to another to a marked extent. I have seen reports of *cure* of exophoria by exercises because the operator has found less deviation one day than another.

Deviation in Exclusion.—In certain cases of heterophoria important information may be gained by the method which I have called *Deviation in Exclusion*. The method is one which has long been used in strabismus, but the technique has not until recently been sufficiently refined to be suited to conditions of heterophoria. In the text-books the process has been described as passing the hand of the surgeon before the eyes alternately.

The following is the method adopted by myself more than twenty years ago and which I have found useful in many cases:—

The patient, seated so that a good light falls upon the eyes, looks at the flame of a candle or, better, a spot on the glass of a window which he faces, at twenty feet distance or somewhat less.

The examiner sits in such a position as to be able to observe even the slightest perceptible movement of either eye. Taking in his hand a small visiting card, the most convenient form of a screen

¹ See Archives of Ophthalmology, 1887, etc.

which will serve the purpose of excluding the distant object from the eye while permitting the surgeon to watch every movement, and a screen which can be passed so quickly that there is no practical interval, he holds it before one of the eyes, charging the patient to look intently at the distant object and to keep it clearly in sight at every instant. The card is then passed quickly before the other eye and the movement of both eyes is closely observed. It is passed backward and forward from one eye to the other, not too rapidly for the patient to fix the uncovered eye each time upon the object nor to prevent an intelligent observation on the part of the surgeon.

If the eye lately covered must make a slight movement outward as the card leaves it for the other eye, it is evident that behind the screen it deviated inward. So if it moves downward on being uncovered it is evident that when excluded it deviated up.

We may measure this deviation with a prism. Suppose that the movement on removing the screen from each of the eyes is outward. A prism is taken from the trial case and held before one eye with its base out. When the right prism is reached the movement ceases and the measure of the apparent deviation in exclusion is found.

But there may be a movement of adjustment of the eyes under these circumstances which is so slight that it may escape the notice of the surgeon. If the patient is quick in recognizing his own visual perceptions, he may furnish the information which the surgeon could not obtain by his own eyes.

This test, which is quite delicate and often important, has been called by Dr. Alexander Duane the *parallax test*.

It is made in the manner described, but the information is given by the patient who observes the movement of the object. If the patient observes that the object moves to the right when the right eye is uncovered and the left is excluded, and to the left when the left eye is uncovered, it is an indication of esophoria. The neutralization is made by prisms until no movement of the object can be detected by the patient. When the movement is in an oblique direction, downward or upward as well as in a lateral direction, the prism is held obliquely.

This "deviation in exclusion" does not prove that the rotation of the visual lines when both eyes are used is the same as it is by this test. In fact, some quite pronounced cases of converging strabismus, strabismus up to 20° , will show marked exophoria by the test of deviation in exclusion. In such cases, and in many cases less con-

spicuously contradictory in this respect, the phenomena of the deviating tendency when both lines of regard are directed toward the object are the results of existing declinations of high degree.

SECTION XXXVIII.

ESOPHORIA.

The condition of esophoria is that heterophoric manifestation which is most frequently encountered.¹

It is that condition in which, while single binocular vision is habitually maintained, yet with the nearest approach to the passive condition which the muscular system of the eyes is accustomed to maintain, the balance of energy is such that were the will power completely removed while all other conditions remained the same, the visual lines would converge, and the degree of esophoria would depend upon the extent of the approach of the visual lines toward each other.

Esophoria, as it will be seen when the nature of the condition is discussed, is not to be regarded as a disease or as a weakness, nor yet as a spasm, although either of these conditions may exist with esophoria. Esophoria is a physiological state depending upon anatomical peculiarities of the course and of the insertions of the motor muscles by which, directly or more generally indirectly, the balance of tension is normally toward the median plane.

The method of determining esophoria has been indicated at Section XXXV, but will be here stated more specifically.

The phorometer being placed at the distance of about five or six inches in advance of the eyes and the prisms brought to the vertical position, the examined person directs the gaze toward a lighted candle situated at a distance of twenty feet and exactly in front. Two images will appear, one of which is higher than the other. If, with the phorometer, the higher image appears at the left of the lower, the lever causes the prisms to rotate so that the pointer at the left is raised toward the symbol of esophoria and until the higher image stands exactly above the other. The pointer, when the images have at length settled in their relative positions, indicates the degree of

¹ Stevens: *Functional Nervous Diseases*, p. 267, 1887. Previous to this publication insufficiency of the interni had been regarded as the most frequent even by those who had come to regard the opposite condition as important.

manifest esophoria as shown by the figures at the border of the cell.

If the diplopia has been induced otherwise than by the phorometer, and the right image is found at the right of the other and the left at the left, the prism that brings one image directly above the other is the measure of the esophoria.

Such tests, with the phorometer, a vertical prism, or other device, having been made, the abducting ability is then to be determined. The standard of normal abduction has been found to be about 8° of prism. While a failure to overcome a prism of 8° with its base toward the nose does not prove that the axes of the eyes are actually balanced inward, any more than the ability to overcome a prism of a higher grade than 8° proves that they are balanced outward, the abducting ability taken in relation with the findings of the phorometer are of importance.

The restriction of the abducting ability, if exactly in proportion with the degree of esophoria found, goes far to exclude complicating conditions in the esophoric tendency, while an excess of abducting power associated with esophoria, as shown by the phorometer, would go far to indicate either an element of hyperphoria or an important declination, or both. The same may be said of a restriction of the abduction to an extent considerably out of proportion to the manifest esophoria. A high degree of declination, mostly in one eye, not unfrequently gives rise to these irregularities of abduction.¹

Such facts indicate the importance of comparing the abducting power and the showings of the phorometer. They also indicate that when one enters upon his record the isolated fact that his patient has an abduction, he has stated nothing which is by itself alone of practical value.

A pair of eyes, either of which will deviate in 5° or more behind a screen, may show an abducting ability of 12° or more, while another pair, either of which will deviate out 5° or more under similar circumstances, will overcome less than 8° prism.

These facts do not prove that there is no value in the test for abduction. They show that in order to interpret the record of the phorometer it is necessary to take into account all the actions of the eye muscles as far as it is practicable to learn them.

Such precaution is especially necessary if an operation for the

¹See page 245 for explanation of the swing from a less to a greater degree of esophoria or even from esophoria to exophoria.

correction of esophoria is contemplated. A surgeon who determines upon and performs a tenotomy of an internal rectus, or any operation which might effect a direct change in the normal relations of the visual lines, upon the evidence simply that a certain degree of esophoria is found, might learn at a somewhat later time that he has committed an error. These cases of esophoria with high abducting ability are not unfrequently changeable. The same case which will at one time show esophoria of a number of degrees may at another time show an equal extent of exophoria. The choice of the eye for most active fixation often determines the direction in which the visual lines tend. The automatic correction of a positive declination may induce exophoria and of a negative declination, esophoria. Esophoria then must be studied in all its relations in order to lead to appropriate procedures for its correction.

SECTION XXXIX.

EXOPHORIA.

The term *Exophoria* signifies, according to the definition at page 215, "a tending of the visual lines outward."

The condition, like that of esophoria, is supposed to be ascertained when all the muscular tensions are at their minimum, and especially when the exertions made necessary in convergence are, as nearly as possible, absent.

As in esophoria, in order to arrive at a knowledge of the condition the test object must be so far removed from the eyes that a full relaxation may be obtained. Such relaxation demands, not that the test object should be at an infinite distance when the distance between the eyeballs is considered, for practically a distance of not less than twenty feet will serve to place all the ocular muscles in a condition essentially of minimum innervation, and will make due allowance for what is known as the "muscular mesopter." At this distance, then, if diplopia is induced by means of a prism placed exactly vertically before one eye, or by prisms vertically placed before each eye, the base of one exactly up, of the other exactly down, the deviation heteronymously of the two images of an object situated in the same horizontal plane with the eyes is the indication of exophoria, except so far as the deviation is corrected by the efforts governed by the will.

As in the case of esophoria, the phorometer affords the most satisfactory aid in making such an examination; for, being placed at a sufficient distance from the eyes, it, to a practical extent, neutralizes the efforts to correct the deviation by abduction, permitting the test to be made under conditions more nearly approaching perfect relaxation of muscular tensions than any other aid, and thereby avoiding many inaccuracies which are unavoidable by other means. It at the same time reveals other complicating anomalous tendencies. The number of degrees indicated, required for the correction of the heteronymous deviation as shown by the rotating prisms, marks the extent of exophoria.

In exophoria, as in esophoria, the habitual visual state is the union of the images of the two eyes. When diplopia occurs, the deviating tendency has passed to actual deviation and is then exotropia. In cases of exophoria of moderate extent we may discover by the exclusion test that the excluded eye deviates outward, showing that when the necessity for blending the images no longer exists, the normal direction of the visual lines is in divergence.

A degree of exophoria can be maintained without passing to exotropia, which, in case of a deviating tendency in, would result in esotropia, the converging muscles being able to overcome a greater deviating tendency than the diverging muscles. Notwithstanding this, an exophoria rarely reaches 10° , for the condition is so generally associated with hyperphoria, as will be seen, that there usually is something more than the simple outward deviating tendency to overcome. Hence, after about 10° , exophoria commonly becomes exotropia.

There is usually, as shown by the tropometer, a power of rotation out somewhat greater with exophoria than with orthophoria, and the inward rotations are slightly reduced. Yet, this is not always the case, and in some instances of exophoria the rotation in is even greater than is common in orthophoria, while the outer rotation does not exceed that in the latter condition. Hence, while in certain cases exophoria might be considered as the expression of an actual diverging position of the eyes, it cannot in all cases be thus regarded. The percentage of exceptions is so large that the rule cannot by any means be considered general.

Another fact that deserves attention in this connection is, that while in a certain proportion of cases the nearest point of convergence is somewhat less near than it is in orthophoria, the angle of conver-

gence in another very large class of cases of exophoria is greater than is usual in orthophoria.

Still another fact in this connection, and one of much importance, is that exophoria is somewhat rarely found in quite young subjects, but occurs in greater frequency as adult age is approached. When it has once become established, it is generally progressive. Esophoria presents itself as a noticeable condition in general at an earlier age than does exophoria. From facts of this kind it is a logical conclusion that exophoria is not generally, if ever, a manifestation of a native divergence of the visual lines, but is a sequence of other conditions.

With exophoria there is commonly an increased abduction and, generally, in proportion to the extent of exophoria.

Such regular and proportionate increase of abduction is not always present. It is not rare to find exophoria with even less abduction than is usually found with orthophoria. The interpupillary space is not, in the majority of cases of exophoria, noticeably broadened. When exophoria passes to exotropia this broadening is, as a rule, clearly seen. In most cases in which the eyes appear to spread, a condition of strabismus may be demonstrated. On the other hand, the eyes, even with high degrees of exophoria, are sometimes placed in such unusual proximity as to suggest converging strabismus. For example, in the case of a lad who had, by the phorometer, exophoria 8° , by deviation in exclusion 8° , and who had excessive abduction, the pupillary distance measured only two inches.

The peculiarity varies from the pressure of the eyes toward the medial walls of the orbit consequent upon the act of adjusting for the declination.

It is important here to repeat to some extent what has been indicated more at length in a preceding section (XXXVII), that what I have called *exophoria in accommodation*, which is a condition analogous to that called by von Graefe "insufficiency of the interni," does not of necessity indicate a condition of true exophoria. Exophoria in accommodation may be associated with esophoria, hyperphoria, or orthophoria. It is, of itself, a condition without definite significance in respect to heterophoric conditions, but may in some instances serve as an auxiliary indication by which one may be aided in arriving at a solution of an intricate problem in diagnosis of the true deviating tendencies. It would be absolutely inadmissible to regard the con-

dition of "exophoria in accommodation" as so much exophoria. The conditions are absolutely different.

It may not, in this connection, be foreign to the subject to speak of the "insufficiency of convergence," which has, in the writings of some continental authorities, taken the place of von Graefe's "insufficiency of the interni."

If we select indiscriminately a number of cases of simple exophoria and an equal number of cases of hyperphoria, we shall find that the average converging ability in the cases of exophoria is considerably greater than that of the series of cases of hyperphoria, notwithstanding the fact that in some of these cases there may be esophoria in accommodation. The ability to converge is often much more considerable in cases where there is actual divergence of the optic axes than in some cases in which there is positive convergence. It will thus be seen that insufficiency of convergence is by no means a sure indication that there is any tendency on the part of the visual lines to deviate outward when in a state of repose. In other words, insufficiency of convergence is in no way synonymous with exophoria. Like insufficiency of the interni, it may be a manifestation of the effect of hyperphoria or of declination.

SECTION XL.

HYPERPHORIA.¹

By hyperphoria is meant the condition of the ocular muscles in which, with a minimum of tension, a deviation of one visual line above the other would result. Habitual binocular vision is assumed, although we shall see that it is probable that in a considerable proportion of cases in which hyperphoria of more than a single degree exists, the tendency to diplopia is so great that the subjects of the affection often surrender to it—a fact confirmed by the marked amblyopia often found associated with this muscular condition.

The term hyperphoria does not signify that the visual line which tends above is too high nor that the other is too low. It is absolutely limited in signification to the fact stated. The whole visual plane of the individual may,

¹This chapter on "Hyperphoria" has been reproduced, with few changes, from the first of a series of papers on the "Anomalies of the Ocular Muscles," in the Archives of Ophthalmology, commencing in 1887.

as shown in Section XXV be too high or too low and in this plane hyperphoria may or may not be present.

The introduction then of a new term to indicate that one visual line is lower than the other is evidently superfluous.

The first published recognitions of a tending of one visual line above the other, less than strabismus, the condition now known as hyperphoria, were in my Essay for the Royal Academy of Medicine of Belgium, 1883, and in my classification of 1886.

Among the varieties of heterophoria none exerts a more disturbing or injurious influence than hyperphoria. It is not only a condition giving rise in itself to great fatigue and perplexity, but it complicates and exaggerates all other faulty tendencies. When we recall the fact that with a fair adducting power one may overcome prisms of 50° , with the base to the temples, and that with a good abducting ability a prism of 7° or 8° is easily overcome in the opposite direction, it will be apparent that muscles which do not ordinarily overcome more than a prism of 3° , as is the case when the prism is placed with its base up and down, must be in a condition of great disadvantage when hyperphoria of 1° or 2° exists. If we might compare the relative nervous impulse demanded by the grade of the prism, which can be overcome in the different directions, then a deviating tendency of one visual line above the other (hyperphoria) of 1° would be equal to a deviating tendency outward (exophoria) of more than 15° . A number of important conditions are quite commonly found associated with hyperphoria. These conditions are local and remote. The local relate directly to the function of vision, to the adjustments of the eyes in the performance of the visual function, and to nervous disturbances of a functional or trophic nature in and immediately about the eyes.

The remote conditions relate to a great variety of disturbances of a nervous character in parts more or less removed from the eyes.

Hyperphoria of a low grade, as determined by a correcting prism, is very frequently attended by amblyopia. It is no unusual occurrence to find, in a case of hyperphoria which may be measured by a prism of 1° or 2° , vision of only $\frac{20}{40}$ or even less, while the refractive conditions are not far removed from emmetropia, and the ophthalmoscope reveals either no pathological state or only a slight tendency to the hyperæmia about the disc which is characteristic of irritability of the eyes from muscular irregularities. The relative number of cases in which such defective visual power exists will, to one who has

not well considered the subject, appear to be out of proportion to the muscular defect. The surprise will, however, give place to conviction if we bring clearly to mind the actual effects from the standpoint of physiological optics, of a very slight faulty tendency in the vertical direction. An actual deviation of a single degree would result in a separation of images at a distance of one-half meter, approximately of 6.4 millimeters. A patient, then, with this amount of deviating tendency, who would bring the letters of the type in which this page is printed even in contact, the lower border of the upper image touching the upper border of the lower, would be required to exert a force upon the superior and inferior muscles greater than von Graefe was able to exercise. If, however, by long practice, the muscles engaged in overcoming this fault acquire unusual strength, as is actually the case, still, when the tension has been continued for a considerable time, or when the general nervous tone is diminished from fatigue or ill health, an almost irresistible tendency to diplopia will occur. The remedy for the confusion thus induced is a renewal of the inordinate muscular tension or the suppression of the image of one of the eyes. This latter really takes place, and the image suppressed is liable to be that of the eye in which the greatest refractive anomaly is found, if a difference exists, or if the eyes are equally well adapted for clear vision, the suppression depends on other circumstances among which the degree and direction of declination are preëminent. In cases with myopia as the ametropic condition, the myopic eye may be employed at the near point, while the more perfect eye is used for distant seeing.

The extent to which amblyopia exists in connection with hyperphoria is illustrated in the following tables. One hundred consecutive cases in which there existed hyperphoria, and in which no dis-

Table I.

Refractive error	1.00 D or less.	More than 1.00 D; not exceeding 2.50 D.	More than 2.50 D to 4.00 D.	More than 4.00 D to 5.00 D.	Total.
Emmetropia . . .					45
Myopia	9	19	7	7	42
Hypermetropia . . .	37	24	12		73
Astigmatism . . .	28	7	5		40
	74	50	24	7	200

Table II.

Acuteness of vision.	Refractive error.						Total.
	1.00 D or less		More than 1.00 D · not exceeding 2.00 D.		More than 2.50 D ; not exceeding 5.00 D.		
	Best eye.	Worst eye.	Best eye.	Worst eye.	Best eye.	Worst eye.	
20	38	21	7	7	4	4	81
30							
40	22	15	8	8	1	5	59
50	6	8	3	7	3	4	31
60							
70	1	2	2	5	1	2	13
80							
90	1	1	1	2	2	2	9
100		3					5
200		1				1	2
Total	68	51	21	29	11	20	200

case or injury of the eyes was found, and in which the refractive errors were not sufficient to account for any considerable defect of vision when correcting glasses were used, are included in the tables, excluding cases of high grades of refractive errors. The highest grade of astigmatism not exceeding 3.00 D, the highest of hyperopia not exceeding 4.00 D, and the highest of myopia not exceeding 5.00 D.

In the first table the proportion of eyes affected with different grades of refractive errors is shown; in the second, the acuteness of vision according to the refractive condition.

The vision of the best and worst-seeing eyes in each grade is given; but for convenience, in the estimate of the comparative value of the best and worst, in all cases where vision is equal in the two eyes one is reckoned as best and the other worst. If anisometropia exists to the extent of bringing the refractive conditions of two eyes in different columns, the vision of one eye only is placed in each column.

From the above tables we obtain the following approximate results:—

AVERAGE VISION OF BEST EYES.

Sixty-eight with less than 1.00 D refractive error, $\frac{16}{20}$.

Twenty-one with more than 1.00 D and less than 2.50 refractive error, $\frac{13}{20}$.

Eleven with more than 2.50 D and less than 5.50 D refractive error, $^{13}/_{20}$.

General average of vision of 100 best eyes, $^{20}/_{30}$.

AVERAGE VISION OF WORST EYES.

Fifty-one with less than 1.00 D refractive error, $^{14}/_{20}$.

Twenty-nine with more than 1.00 D and less than 2.50 D refractive error, $^{12}/_{20}$.

Twenty with more than 2.50 D and less than 5.50 D refractive error, $^{11}/_{20}$.

General average of vision of 100 worst eyes, $^{20}/_{50}$.

It will be seen from the above table that defective vision is rather the rule than the exception in moderate degrees of hyperphoria. It is a fact that must have occurred to every experienced oculist, that in anisometropia a material difference in the visual power of the two eyes is exceedingly common. But it is also true that in anisometropia a difference in the form of the orbits may exist, a fact which would tend to a failure of equilibrium in the length or strength of the motor muscles of the eyes. Experience confirms this reasoning, and I have found that instances of even approximate balancing of the eye muscles in anisometropia is rather exceptional.

From the facts thus ascertained it becomes evident that amblyopia is not only very commonly associated with hyperphoria, but that it is not uncommonly a result of that anomalous condition.

A peculiar and interesting visual disturbance, related to yet differing from amblyopia, is the inability of the subject to see small objects clearly, although for larger objects, at the distance of some feet, the visual power is fair or even good. Thus, one may be able to read No. XXX, or even No. XX of Snellen's scale, and may have no special fault of accommodation, yet when No. I is presented at the distance of one foot, the patient is quite unable to read. Small objects or characters are seen indistinctly or not at all. The fault in these cases appears to consist in an inability completely to fuse the images of the two eyes, while the separation is not sufficiently great to enable the patient to easily suppress one of them. This phenomenon is illustrated in the confusion which appears when one reads the word here doubly printed: *Accommodation* If we cover with a card the lower range of type, the word is perfectly clear. A corresponding result may be effected in a considerable degree of

hyperphoria by the mental suppression of the upper or lower rank of letters. If, however, the separation is less complete, as in this instance: *Accommodation* we are quite unable to exclude either of the confusing ranks, as in the former experiment with the card, and the difficulty of a mental exclusion on the part of the subject of hyperphoria in this latter case is likewise greater than in one of more complete displacement. That only a comparatively small proportion of hyperphoric persons experience in marked degree this inability to see small objects well, is probably to be accounted for on the principle that in the great majority of instances the subject of hyperphoria is able either to fuse the images completely, or to displace them to such an extent as to enable a mental exclusion of one image to take place.¹

The conditions of hyperphoria relating to the adjustments of the eyes through the influence of the motor muscles are extremely interesting and important. The disturbing effect upon the lateral equilibrium is especially noticeable, and is a source of great perplexity to the oculist in his examinations of the muscular relations. In hyperphoria the tests for lateral deviations are very often contradictory, and in a very considerable proportion of cases unsatisfactory unless the examiner is on his guard against the anomaly under consideration.

This principle of apparent contradiction is well illustrated in such a case as the following:—

A gentleman was found to have so strong a tendency of the visual axes to deviate inward that at distances of twenty feet or more much difficulty was experienced in maintaining single vision. A relaxation of the force of the external recti muscles habitually resulted in homonymous diplopia. The esophoria as measured by prisms was, however, not more than 4° . On the contrary, if the gentleman held a pencil or his finger before him at the distance of fifteen or eighteen inches from the eyes, crossed diplopia occurred from "insufficiency of convergence."

A pencil held at fifteen inches from the eyes was doubled to an extent that the two images appeared about an inch separated. By the test of the dot and line the insufficiency was only about 6° or 7° .

This gentleman was found to have hyperphoria of 5° . Opera-

¹ While the above paragraph is allowed to stand as published in 1887, it is now evident that the element of declination is to be considered as of importance in the conditions above described.

tive correction of the hyperphoria resulted in permanent removal of all annoyance from the double images both near and far.

Instances of this class are frequently encountered by one engaged in this field of research. It is evident, therefore, that an examination which deals simply with "insufficiency of convergence," exophoria, or esophoria falls far short of revealing the true condition of the muscular balance of the eyes.

Cases of heterophoria arising from high degrees of hyperphoria are, not unfrequently, of alternating character. It may happen that a condition of esophoria of important degree at one time may prove to be exophoria of corresponding importance at a subsequent time. This is not because one set of muscles at one time weak are to become, at a later period, too strong, while the former strong ones are to become weak. It is because the patient has for some reason chosen to employ at one time for the most definite fixation one eye and at a later time has selected the other eye for this office. In this way a different automatic correction of declination is effected at different times, resulting in varying degrees of hyperphoria. As a result of the different tensions induced by the declinations underlying the hyperphoria, there is the effect of esophoria at one time and of exophoria at another time. In such cases the test by abduction may reveal the possible inconsistency of the tendencies.

SECTION XLI.

NATURE AND CAUSES OF HETEROPHORIA.

The tropometer effectually disposes of the traditional "weakness" of certain muscles as causes of the different forms of heterophoria. The sum of the rotations temporalward and medialward is, in many cases of esophoria, greater than in orthophoria, and the temporal rotations in such cases may exceed the outward rotations of the ordinary cases of orthophoria. So also the inward rotations in exophoria may be excessive. Clinical experience proves that attention properly directed in quite other directions may correct the tendencies of heterophoria without direct interference with any of the muscles formerly supposed to be primarily affected in these anomalous states.

The question of the dependence of "insufficiency of the interni" upon the angle of the orbital axes was made the subject of an ex-

tended study by Dr. Emil Emmert, to which reference has already been made.¹

Dr. Emmert's work is illustrated with carefully executed diagrams of the orbital angles and directions of the walls of the orbits of 64 crania.

Interesting and valuable as are these researches they throw little if any light upon this question, the relation of divergence of the eyes and divergence of the optic axes.

The following facts seem to be established:—

1. That a certain excess of divergence of the orbital axes may, in some instances, be found and a diminished divergence in others, is quite possible, although between the clinical facts and such anatomical investigations no relations have thus far been established.

2. That a condition of anophoria or of katophoria may influence the directions of the visual lines is evident when the associated actions of the various muscles are considered. It is easy to explain, for example, how esophoria may be induced by the contending forces of the superior and inferior recti in a case of anophoria. When, however, these conditions are associated with important declinations the elements of the problem may be materially changed and different results may be found.

Bearing in mind the course and the insertions of the superior and inferior recti it will be seen that in a case where, by reason, for example, of a normal tendency for the eye to be directed high, the effort at depression must induce a tension on both the superior and inferior recti simultaneously which would tend to swing the optic axes toward the medial plane. (See Fig. 13, page 49.)

3. That heterophoria may also be the manifestation of the irregular insertions of the tendons into the sclera appears to be indicated from a study of the results of the investigations of Fuchs, already referred to.²

It will be seen from an examination of the diagram which I have drawn with the view of representing the insertions of the tendons as he found them, that in this variety of positions for the insertions may be found one cause for various anomalies in the tendencies of the visual lines.

No estimate can be made of the proportion of cases of hetero-

¹See page 41.

²See page 59.

phoria dependent on these irregularities of insertions, but it would seem reasonable to assign to this class of insertions at least some part in the problem of heterophoria.

4. The most conspicuous demonstrable cause known at present is found in the directions of the vertical meridians of the retina. That these *declinations* depend upon orbital peculiarities and are peculiarities of tendon insertion is also most probable, hence, this cause is in a way related to the others already mentioned.

The conditions of declination in exophoria and other tendencies have been already referred to, but in order to bring the influence of declinations on all the forms of heterophoria into a general view they will be restated here.

Experience shows that, in general, the declinations of both eyes are alike in exophoria. That is, if that of one eye is positive, the other is also of the same sign. The sum of declinations for the two eyes is, in exophoria, usually considerable. It is rarely less than 3° to 5° .

While the declination is not always nearly equal for the two eyes it is found to be so in most cases of uncomplicated exophoria.

In order to illustrate the principle we may now assume that we have to deal with a case of simple exophoria, the normal visual plane being not much above or below the standard plane for the best adjustments, and with a positive (+) declination of about equal degree for each eye.

What is the relation between the declinations and the exophoria? It can be stated only in general terms.

One of the strongest of visual instincts is that relating to the idea of verticality. If the vertical meridian of the eye leans, all objects also lean. A person looking directly forward with head erect, to whom erect images appear to lean, makes an automatic effort to place the meridian of the eye in an exactly erect position in order partly that the vertical meridians of the two eyes shall be corresponding meridians. This, in our case, demands an effort on the part of the superior oblique muscles out of proportion to that of the recti. As a result the axis of each eye is depressed and directed outward. Stress must now be brought upon the elevating muscles to bring the plane of regard to the level of the point of regard, and upon the internal recti to bring the visual lines to unite at that point. If diplopia is induced by a prism, the automatic effort to maintain the erect position of images continues, and exophoria is manifest.

This, of course, is the proposition in its simplest form. That no other elements are introduced into the problem is not to be assumed. As a matter of fact, other elements are usually involved.

Hyperphoria commonly results from less symmetrical states of declination. If, for example, there is a high degree of + declination for the left eye and a low degree or no declination for the right, we have the elements of right hyperphoria, for in the torsional act of correcting the declination of the left eye, its visual line may be thrown below the other. This does not always happen, since other forces may be brought to bear to prevent hyperphoria.

The explanation of the influence of declinations in inducing esophoria is much more involved than that in case of exophoria or hyperphoria.

Daily observation for several years has shown that, *as a rule, the declinations of exophoria are both positive, that in hyperphoria they are unsymmetrical, and that with esophoria they are conjugate but unequal.*

These are the clinical facts. These efforts to explain them are, as has already been stated, only tentative.

Taking for an illustrative case one in which there is pronounced positive declination for the left eye and slight negative declination for the right, the resulting tensions on the adjusting muscles which will be called into action are these:—

To correct the positive declination of the left eye the superior oblique rotates the eye upon its axis and directs that axis down and out. The inferior oblique, to rotate the meridian of the right eye, directs its axis out and up, but to a less extent. The superior rectus of the left eye and the inferior of the right now come into action, the former with more force than the latter, but both acting, in proportion to the force exerted, to rotate the eyes inward. There remains now the diverging effect upon the left eye induced by the greater action of the superior oblique, and the internus of that eye takes up the burden of neutralizing that deviation. Synergically, the internus of the right eye also acts, and having little to restrain it, it induces an esophoria.

In detail, the effects which the various forms of declination may have upon the directions of the visual axes where the effects are uncomplicated and manifest may be in part summarized as follows:—

Symmetrical positive declination tends to cause a depression of each visual line with exophoria.

Unilateral positive declination tends to hyperphoria, right, if the declination is left, and left, if the declination is right. If the eye adjusted for verticality is the principal fixing eye, there will be exophoria, but if the eye subject to the declination is the principal fixing eye, there will be esophoria.

Symmetrical negative declination tends to the presence of an elevation of the visual lines. In this case, as well as in the case of positive declination, the actual direction of the visual lines may be contrary to that which the declination would give, since there may be in the case of positive declination a marked condition of anophoria and with negative declination as marked katophoria, conditions too pronounced to be overcome by the effects of declination.

With this elevation of the visual axes there is also a tendency to exophoria.

With unilateral negative declination there is the tendency to hyperphoria, right, if the declination is right, and left, if the declination is left. As in the case of positive unilateral declination, exophoria results if the eye with adjustment for verticality is the fixation eye; esophoria, if the eye with the declination is in fixation.

If there is conjugate declination of equal extent there should be esophoria with hyperphoria, but the effects upon the lateral tendencies may be neutralized, or there may even result an exophoria.

It is impracticable to enter here upon all the shades of variation which may occur when the declination is divided unequally between the eyes. The rules governing the resultant actions of the muscles as shown at page 245, will enable the investigator to determine approximately the effect in individual cases.

It is to be remembered that rules just stated apply only in cases not complicated. In some instances the effects of declination are apparently in opposition to these rules, and only the including of the complicating-element will enable a correct judgment to be formed as to the heterophoric tendency which should be the result in a given case.

In extreme declination, strabismus is a frequent expression of the surrender of the muscles to this condition. The effort to maintain verticality of the apparent positions of images, and at the same time to regulate the collateral tensions, is a task which cannot be maintained after the patient has reached an age of critical examination of objects.

That such anomalous adjustments of the eyes as are indicated

by important grades of declination should influence the pose, not only of the head, but of the body, is no more than might be reasonably expected. These induced carriage of the head and body are of great practical consequence. In my earlier observations¹ I saw only the tilting of the head to one side, but at length I discovered that the influence of the adjustments of the eyes extended to the pose of the whole body. The subject has been treated at some length in the section devoted to the relations of the pose of the body and the normal plane of vision. I have there attempted to give only the general principles. The intelligent observer will soon see that the principles extend to many details, concerning which space has not been sufficient to permit of specific mention.

SECTION XLIII.

SUMMARY OF PROCEDURE IN EXAMINATIONS FOR HETEROPHORIA, ANOPHORIA, KATOPHORIA AND DECLINATIONS.

Having at such length reviewed the general principles of examinations of the muscular adjustments of the eyes, it may aid in a practical understanding of the subject to present a summary of it in a briefer manner.

¹Previous to my own observations there had been in the literature of science no mention of these faulty positions of the head or body on account of the normal adjustment of the eyes except a remark by von Graefe that patients with a high degree of insufficiency of the interni sometimes turn the face to one side *in order to avoid fixing the object* with the deviating eye. A few observations had been made in regard to the pose of the head in case of paralysis of the eye muscles, but the conditions known as heterophoria, declination, and other anomalies of adjustment or of refraction, had received no attention in this relation. I first showed the tilting of the head toward the shoulder in cases of hyperphoria, and I then believed that the tilting was the result of hyperphoria only. Subsequent investigation, when the principles of declination were understood, convinced me that the direction of the vertical meridians is also a most important element, not only of this particular pose, but of others, such as the elevation or depression of the chin with or without oblique deviations. That such carriage of the head should also influence the lines of direction of tensions of the muscles of the trunk, and even of the extremities, is only the result of mechanical laws. As early as 1885 I operated for the condition since known as hyperphoria in cases of chronic spasm of the muscles of the neck, torticollis, with partial success and in many cases since then similar operations for the same conditions have been done by me, always with encouraging but not with complete success, until the relation of declination to these cases was recognized. Since then several extreme cases have yielded entirely to treatment of the ocular adjustments.

So far as the actual ascertainment of the facts is concerned, it may matter little in what succession they are obtained. Yet in the interest of an orderly examination, which shall gradually develop the subject, there is a natural sequence of the different procedures.

First of all, it is best to be informed of the refraction and the state of the accommodation as well as the ophthalmoscopic appearances. The use of glasses may at some subsequent stage of the examination be absolutely essential, and a knowledge of the condition of the interior of the eye may be essential to the examiner in order to interpret what he may find later.

The next stage of the examination is with the phorometer.

In case, for example, of the existence of an important degree of hyperphoria, the findings by the clinoscope might be vitiated were not means taken to neutralize in some measure its effect. Various circumstances of this order make it desirable to know the results of the examination by the phorometer before proceeding to the other stages.

While using the phorometer it should be placed about five inches in advance of the eyes of the patient, and no refracting glasses should be used when the patient can clearly distinguish the test object at the proper distance without glasses. Spherical glasses are prismatic in all directions; cylinders in some directions. All such glasses are liable to cause a leaning of the image when the line of regard is not exactly through the point of least refraction of the glass. If the reader will hold a + spherical glass of 3 or 4 diopters sufficiently far in front of his eye that he will be able to see the upright casing of a window several feet distant partly through and partly above and below the glass, he will see that if the glass is moved slightly to one side and the other, that part of the casing seen through the glass will lean, now in one direction, then in the other, while the casing not seen through the glass will of course remain upright. These leanings of the image may in some degree neutralize an existing declination of the eye and thereby modify the heterophoria test, or it may induce an effort corresponding to that for correcting declination, and thus also induce a heterophoric condition. There are several objections to the use of lenses with the phorometer, and there are no reasons, except inability to see, for their use.

The test object, a lighted candle, should be removed twenty feet from the patient.

A record of the phorometric conditions having been made, the

abduction and sursumduction may be tested at the same distance. The simplest and easiest and, indeed, the most effective way of making these tests is by the help of prisms taken from the trial case. Numerous devices, modifications of the Cretes prism, have been suggested. They are clumsy and impracticable.

For abduction, take a prism, for example, of 5° from the box. Place it with its base toward the nose close to one eye of the patient, and ask him to unite the images, if two result. If this can be done, proceed to the next grade or pass over one or two grades and try again. In a very few trials the limit will be reached. On the other hand, if the 5° prism cannot be overcome, a lesser grade is tried, and, if necessary, other lesser ones, until a union of images can be found. The strongest prism that can be overcome is the measure of abduction. If there is an actual convergence it may require a prism with the base out to enable the patient to unite. Then there is homonymous diplopia of the degree of the weakest prism that will unite the images. Prisms of much less grade are usually required for sursumduction. A prism of 1° , 2° , or 3° is usually sufficient.

Place the prism with its base down before one eye. If this can be overcome, present a stronger until with no stronger will the images unite. In most cases a prism of not more than 3° may be overcome. In myopic cases with high declinations, prisms of 9° or 10° may be overcome. After determining the sursumduction in one direction, the examination in the other should be deferred for some minutes until the effect of the first efforts has passed off. Then the prism may be placed before the second eye with its base in the same direction as before, or before the same eye with its base reversed. The result will be the same in either case. These tests being completed satisfactorily, the tropometer is brought into use. A knowledge of the rotations up and down is of more importance than that of the lateral rotations, since the latter are very frequently modified by the former.

The patient seizes the wooden tooth-rest firmly by the teeth and presses the forehead against the arch of the head-rest. Then the examiner sees that the head is so adjusted that the upper button of the guards presses at the glabella and the lower button presses equally at the depression of the jaw below the nasal spine. The eye is directed to the objective point on the instrument and the surgeon adjusts the scale to the border of the cornea. After careful attention to these details, the examiner, holding the patient's head with his hand to

prevent or detect any movements, directs the patient to direct the eyes as far up as possible. The effort is repeated until the patient is able to bring all the force at his command to the action. The highest point of rotation as shown by the scale is noted, and the upward rotation of the opposite eye is determined in the same manner.

The downward rotations are also noted, and then, if the examiner desires, the scale is turned and the lateral movements are examined.

The final stage is with the clinoscope. The tubes are brought to a level with the eyes and the instrument is brought to an exact level as shown by the upper spirit level. The finer sight-holes are adjusted for the interpupillary distance and the tubes are adjusted in parallelism. The patient, looking through the sight-holes, must see both test objects at the same time, and continue to do so during the whole examination. The examiner brings one, then the other test line to an exact vertical position *as seen by the patient*. No suggestion should be made which will aid the patient as to the direction. No refracting glass except such as is positively demanded to enable the patient to see the test lines or a prism for correcting hyperphoria should be used, and, in order to avoid false leanings induced by a glass, it should be placed in the clip when the line of regard will not pass through it obliquely. The pointer should be moved backward and forward until the examiner is sure that the patient is exact in his impression as to its verticality. The second pointer is then

FORM OF BLANK FOR DAILY MEMORANDUM, SIZE 3½ x 5 INCHES.

Mr.
..... 189
Hyperphoria, R.,.....	L.,.....
Esophoria.....	Exophoria.....
Abduct.....	Adduct.....
Sursumduct. R.,.....	L.,.....
Dev. in Excl.	Conv. at.....
Rotation, {	R.
	L.
V = {	R.
	L.
Declination, R.,.....	L.,.....
<hr/>	
Operat., Prescrip., Clinical Notes, etc.	

adjusted with equal care. Then the position of the first is revised and time enough is given to permit the eyes to relax from the habitual adjustments which are required in their ordinary use.

By these various processes the examiner has put himself in possession of a considerable number of important and correlative facts upon which he is able to base his conclusion in regard to the actual state of the muscular adjustments. All are necessary elements in the problem, and no examination can be said to afford the means for a correct determination of the adjustment relations which does not include the refraction, the results by the phorometer, those by the tropometer, and those by the clinoscope. In order to be able to see the results at a glance as well as to have a temporary record which may be transferred to the case book after the work of the day is over, I have for many years used a small slip containing a form, filling it for each case as examinations are made, destroying them when the results are entered in the case book.

SECTION XLIII.

CLINICAL FEATURES OF THE NON-STRABISMIC ANOMALIES OF THE OCULAR MUSCLES.

HETEROPHORIA.

While mindful of the fact that a very important proportion of cases of heterophoria have their origin in declinations or in the unfavorable location of the normal plane of vision, and that hence the general symptoms of heterophoria may in large measure represent conditions arising from the original causes, still there are such special clinical features associated with the different forms of heterophoria that it is desirable to examine these features in connection with the more immediate muscular anomalies.

In respect to the clinical importance of esophoria,¹ which occurs in the proportion of more than three to one of exophoria, it plays a much more important rôle than the latter as a predisposing cause to a variety of neuroses; and, as the immediate cause of asthenopia and kindred affections about the eyes, it is an element of great disturb-

¹ This section is largely reproduced from my "Second Paper" in the series in Archives of Ophthalmology, 1888, page 177 *et seq.*, with such modifications as more recent observations have rendered necessary.

ance. It is true that in individual cases of exophoria the strain in adjusting the eyes, especially in reading and other close work, may be more immediately expressed in the orbit in the form of localized pain of the muscles, than in an average case of esophoria of equal extent. The reactions of esophoria are likely to be more distant. Thus, a patient affected with exophoria may, after an hour spent in reading, suffer from pain in and immediately about the orbit. On the other hand, a patient affected with esophoria, after attending church or the opera or after visiting a picture gallery, where the eyes have been directed during a considerable time at a distant point, and in such a position as to make it necessary to hold the visual lines in parallelism, is quite likely to experience a universal malaise, with pain at the back of the head and in the upper part of the neck, and possibly, if the patient is not strong, a sense of illness all the following day.

Reviewing a large experience in comparing these two conditions, I find that the general or distant reactions from esophoria are far more frequent and significant than those of exophoria, and that the local pains, while possibly absent in a greater proportion of cases, are still of great prevalence and of a more persistent character where existing.

The grade of the deviating tendency does not always mark the extent of irritation resulting from it. Indeed, it often happens that less serious reactions result when the anomalous conditions are extreme than when they are moderate. Thus, in a case of esophoria or exophoria of 2° or 3° , the defect is sometimes a source of greater irritation than one on the verge of strabismus, of 8° or 9° , because, in the first instance, binocular vision is constant, or nearly so, although effected by a strenuous effort. In the second case the image of one eye is often suppressed, for very short or longer periods of time, and one of the eyes is permitted to drift away from the physiological companionship of its fellow, thus affording a rest of one kind at the expense of another sort of nervous perplexity.

It is not to be supposed that because esophoria is more often than exophoria the predisposing cause of distant disturbances, it is therefore not a notable cause of asthenopia. Of a large class of cases which go from one oculist to another in the hope of relief from some new treatment, and submit to an almost endless change of spectacles with little if any advantage, a very considerable number are victims of very slight grades of esophoria. They gain no relief until this too

much neglected anomaly receives due attention, when their asthenopic symptoms disappear. These very moderate cases of esophoria may represent important declinations, and it is these latter conditions which induce the nervous perplexity rather than the slight resulting esophoria.

To the ordinary phenomena of asthenopia may be added the following symptoms which are prominent among the local indications of esophoria.

In a certain proportion of cases, especially those in which esophoria approaches the extreme limits to which binocular vision can be maintained, the accommodation is feeble and the pupil is sluggish and dilated. It is quite certain that in such cases there is a failure to accommodate quickly, for some other reason than the suppression of the habitual relation between the convergence and the accommodation, since even after entirely successful operations for the relief of esophoria, the accommodation remains enfeebled and the pupil sluggish and expanded, with a continuance of the symptoms of asthenopia and headache. Attention to the declination which may induce the esophoria usually restores the accommodation to full vigor, with quick reactions of the pupil.

In esophoria, especially when combined with hyperphoria, one of the very unpleasant symptoms not unfrequently met with is the annoyance experienced by the patient in constantly seeing the nose. This may appear a trivial symptom, yet it is described by those subject to it as a most vexatious phenomenon. Many patients declare that they can bear the pain of the head and back resulting from the muscular conditions better than they can endure the never-ceasing annoyance of seeing the nose.

In similar conditions patients not unfrequently complain of seeing a black spot in the center of the field of vision. Thus, while reading, the black spot will appear at or near the part of the page at which the reader is looking, causing annoyance and confusion. There may be different explanations for the appearance of this scotoma. In some instances it is probable that the dark spot represents the shadow of a vessel of the retina, while in more rare cases it is possible that the scotoma is caused by the intrusion of the blind spot into the line of regard.

The effect of esophoria on vision, while in the lesser degrees it is not so pronounced as that which has been shown to result from

slight grades of hyperphoria, is, in moderately high degrees, of a most unequivocal character.

Amblyopia has been shown (Section XL) to be rather the rule than the exception in cases of hyperphoria. In esophoria, amblyopia of at least one eye is quite common when the deviating tendency exceeds 3° .

In one of my early contributions to the subject of esophoria¹ I have shown the relation between uncomplicated cases of esophoria and amblyopia. From a table of 100 such cases it appears that there is an average loss of visual power in cases of esophoria of more than 3° of about one-third in one or other eye.

It is only reasonable to suppose that a condition which must of necessity act as a constant cause of nervous perplexity and irritation, should result in inducing a state of hyperæmia or of altered nutrition of the parts supplied to a certain extent by branches of the same nerves which supply the imperfectly balanced muscles. It could scarcely happen that an irritative cause so prolonged in its existence and so efficient in inducing functional disturbances should fail to be a frequent cause of such perverted nervous influences upon the eyes themselves or their immediate surroundings as to promote pathological changes of diverse forms.

Hence, for instance, it is not a surprising fact that one who, during a lifetime, has contended with the irritating influences of heterophoria, should at length find that the nutrition of the crystalline lens has suffered degenerative changes, or that even the tunics of the eye should be affected unfavorably.

This view of the possible or probable origin of many affections of the eye is not one to be regarded with neglect or disdain or treated as the outgrowth of extreme views. Diseases do not occur spontaneously. They are the result of laws, and it is idle to speak of cataract or corneal ulcer or of various other affections simply as accidental or Providential visitations; and a fallacy to talk of "constitutional causes" when we simply mean that we do not know. A known cause which may induce perverted nerves is of more practical consequence than a volume of profound ambiguity.

Many years ago I called attention to the influence of refractive anomalies as predisposing causes of corneal ulcers² and to other

¹"Anomalies of the Ocular Muscles, Second Paper," *Archives of Ophthalmology*, 1888.

²"Transactions, International Congress," Philadelphia, 1876.

chronic diseases of the eyes and lids, and I have since had the satisfaction of noticing that several close observers have arrived at similar conclusions. There is no reasonable doubt that refractive and muscular lesions are very largely effective in the causation of various eye affections, both internal and external. True, there are certain well-known general physical taints and impairments which are manifested as local affections; but even in the presence of these sources of evil we may learn that the localizing of the virulence is favored by a damaged or enfeebled state of the nerves supplying the affected part.

Hence in many chronic and obdurate affections of the eye we may look upon the conditions of anomalies of refraction and of the adjustments as possible or probable sources of mischief.

Should a case of incipient idiopathic cataract present itself, and should it be found associated with pronounced anomalies of the eye muscles, and should these anomalies be properly treated and corrected, would the cataract stop? Perhaps not. But in many cases within my experience it has stopped. It would be doing an intelligent act to relieve the patient from a source of irritation which might affect the nutrition of the lens unfavorably. The arrest of the complaint might not follow, but the surgeon has made no mistake if he performs his work well, and he has a reasonable expectation that the pathological process may be arrested.

I have reproduced this whole section as it was published in 1888, with two or three verbal corrections in order to present these views exactly as they were then written. Long before this I had recognized this class of causes as extremely influential in the ætiology of many forms of eye diseases. In the paragraph above, more particularly, reference is made to cataract, not because it was then supposed to be more than many other forms of eye affections, a manifestation of the evil influences of the class of anomalies under discussion, but as a common and representative form of nutritive disturbances. That diseases of the retina, of the choroid, of the cornea, and of the optic nerves, as well as other structures of the eyes, not only frequently but commonly have one or other of the anomalous states of the eye muscles as an important and sometimes almost exclusive factor in their ætiology, I did not then doubt nor do I now, after the lapse of many years. This book is not intended to enter upon the different forms of diseases of the eyes, and it is not necessary to specify how or when muscular anomalies may induce special forms of eye troubles. The principle that they are ætiological factors is all that need be here stated.

Blepharitis, with its redness of the eyelids and chronic redness of the ocular conjunctiva, is a frequent result of esophoria. As to more distant effects a large class of people who from year to year

are supposed to suffer from "malaria," "biliousness," "nervous prostration," "dyspepsia," "constipation," and similar neurasthenic conditions are simply paying the penalty of uncorrected heterophoria. The effects of one or other forms of heterophoria are frequently seen in their influence upon the physical functions. Chronic constipation, dysuria, and dysmenorrhœa are not infrequent results of the heterophoria.

The reactions from exophoria are in many respects similar to those of esophoria, though, as above stated, those of exophoria are more frequently of a local character.

Still, pains in distant parts, nausea, dizziness, and other neuroses are frequent responses to the difficulties of adjustments arising from exophoria. In general, the remarks applied to esophoria may apply also to exophoria. The head is frequently thrown backward as a habitual pose with exophoria, a pose due to the double + declination, resulting in habitual pain at the back of the head and neck.

The more remote results of hyperphoria are similar to other anomalies of the ocular muscles, but with certain special characteristics. Neuralgia, neurasthenia, insomnia, chorea, and epilepsy are among the manifestations of hyperphoria, as they are, indeed, of the other forms of heterophoria, but to a greater extent than the other forms is this one associated with chronic vertigo and pure epilepsy. The nervous disturbance arising from this cause is more perplexing, both from the difficulty of overcoming it by ordinary effort and from the complications arising from it in respect to the converging and diverging efforts, than moderate grades of deviating tendencies in the lateral direction. Beyond all, the markedly unsymmetrical declinations which are associated with and are doubtless the cause of most cases of hyperphoria are conducive to such conditions as vertigo and epilepsy as well as to a great variety of nervous irregularities.

The carriage of the head to one side which is a pose characteristic of hyperphoria, and which is also one of the effects of conjugate or of quite unequal declination, is often a source of much discomfort by reason of the contraction of one set of muscles and the extension of another. It is not uncommon for persons with hyperphoria to experience much pain in the back of one side of the neck, pain which is habitual during many years, and chronic spasmodic affections of the neck muscles sometimes result. Such cases are often relieved fully and at once by an appropriate operation for the correction of the ocular muscle anomaly.

In concluding these pages devoted to pointing out some of the clinical features of the different forms of heterophoria, I must revert to Section XXXIII, where it is stated that "*as a matter of fact heterophoria may be regarded as, in general, a resultant of declinations and of adjustments of the eyes above or below a certain plane relative to the cranium.*" *The different clinical features of the forms of heterophoria are in fact the expression of the different combinations of declinations and adjustments for an unfavorable plane.* Thus, the head is often carried high in exophoria although the rotations may be high, because of the existence of positive declination of both eyes. So also pain in one or both sides of the neck may arise in esophoria because, resulting from a high degree of conjugate declinations, the head is carried far to one side. Many illustrations might be adduced to show the principle, but it is needless to point out in detail all the relations of this kind.

What is most important is to remember that, while for convenience, with the different forms of heterophoria various clinical features have been associated, it is to the underlying conditions of heterophoria that we must look for the explanation of these clinical features, and that in the practical management we are to look to these inducing causes of heterophoria rather than directly to the heterophoric manifestations themselves for the most effective and enduring relief.

ANOPHORIA, KATOPHORIA, AND DECLINATION.

Of the more local affections to which anophoria or declination may give rise, hyperæmia of the palpebral conjunctiva is perhaps the most frequent. I mention anophoria and declination together, since they may give rise to similar phenomena. Thus, in anophoria the axes of the eyes being inclined to rise above the most favorable plane, the eyelids aid the depressor muscles by bringing pressure upon the upper surface of the eyeball. Very nearly the same thing happens with certain forms of declination in which the lids clasp the eyes to aid in maintaining satisfactory adjustments.

In both cases the pressure upon the eyeballs may and often does give rise to hyperæmia of the lids, which may be relieved by treatment, but which returns soon after treatment is discontinued.

With anophoria of high degree associated with important declinations, there exist the conditions favorable to the development of

trachoma, and I have shown¹ that it is in connection with these conditions that trachoma occurs. I am able to add that I have seen most luxuriant follicular hypertrophy of the conjunctiva of the lids melt away with surprising rapidity when the tensions for anophoria and declination have been relieved.

I have, in illustration of this proposition, used in one or more of my contributions to this subject mentioned, the following interesting facts:—

A few years since a distinguished oculist of one of our Southern cities announced that trachoma, that form of eye trouble commonly known as granular lids, and which is one of the prolific sources of blindness, is unknown among pure negroes. The discussion of this proposition, after occupying the attention of oculists for some time, was at length taken up in a different way by a distinguished colleague in Constantinople.

This gentleman wrote to oculists in all parts of the world asking for the results of their observations in their own countries in regard to all classes of people. He at length published a symposium of the answers showing the prevalence of trachoma in different countries and among the different classes of people. As given in this contribution there seemed to be a confused accumulation of facts which had, on the whole, apparently little meaning. Peoples of contiguous countries, of the same color and not very different in habits of life, were reported as differing widely in respect to the prevalence of the affection. No reasons were assigned and none seemed to be suggested by the varying facts. An analysis which I made of this report showed that among peoples with the 'medium' or tall heads, like the Irish and the Italians, trachoma is rife; while among peoples with the broad head, like the Bavarians, or with the long head, like the negroes whose ancestors were from the West or Guinea coast of Africa, trachoma did not prevail; but it is interesting to note that descendants of the negroes of the northern part of Africa, where the heads of the natives are often tall, are subject to trachoma equally with the whites among whom they live. I have in another connection discussed this question at more length.

A glance at Fig. 109 will show that the negro, as he is known in our Southern States, not only throws the head backward in the

¹ Paper read at British Medical Association, August, 1897. Published in *Ophthalmic Review*, September, 1897.

manner characteristic of the long head, the strong facial angle and the depressed visual plane, but that the eyebrows are characteristically elevated. This drawing up of the brow is accompanied with a drawing upon the lids, and hence no pressure is brought upon the surface of the eyes by the upper lids. In the case of the tall head with the high plane of vision the brows are strongly compressed and the lids bind upon the eyeball, and thus in the midst of dust and filth or even in good sanitary surroundings disease of the lids may be promoted.

The carriage of the head too far in advance or too far backward is directly governed by the state of the muscular adjustment of the eyes, and from one or other of these habitual carriages may arise a



Fig. 109.—The Long Head with Prognathous Face. Facial angle $+ 15^{\circ}$.

variety of unpleasant or injurious effects. In another section the tendency to restrict the respiration by the carriage of the head in advance has been already dwelt upon. The fact is of so great importance that it may well be restated here and cannot be too earnestly insisted upon. The peculiar carriage of the head, the result of anophoria or of declination, is beyond question a most important element in the predisposition to tubercular disease of the lungs. The bacillus of consumption finds no rest and no encouragement to indefinite multiplication in the chests of persons whose heads are habitually thrown backward, nor, indeed, in the lungs of those whose heads are not habitually thrown too far forward. The advantages of the so-called fresh air treatment and a great deal more beside can be secured by the proper carriage of the head which follows at once on a successful

correction of the declination or of the anophoria. In such corrections, important in themselves, are to be found the most effective means, not only of prevention, but of relief from the most general single cause of destruction of human life. I am quite aware that these statements will be regarded as extreme and as the outgrowth of too restricted attention to a single class of phenomena. The statements are neither extreme nor the expression of narrow views. They are well considered and based, not only on correct principles, but upon carefully observed facts in a large experience continued through many years.

With the opposite carriage of the head, which results from katophoria or from declination, are often found chronic pains in the back of the head about the occipital origin of the trapezius muscle, at the spine of the seventh cervical vertebra, and between the shoulder-blades. They are the expressions of the too constant tension on muscles of the back demanded in the adjustment of the eyes.

The position of the head in katophoria is well illustrated by Fig. 92. This is from a photograph of a case which came under my observation before the introduction of the tropometer. The position of the eyes was determined (if the term is appropriate where no exact measurements were made) by the apparent rotations as seen without the aid of an instrument.

The pose as shown is not in any respect exaggerated, and it was this pose which led to the observation of the position of the eyes.

An operation for relaxation of each inferior rectus was done, and the second photograph (Fig. 93) shows the habitual pose a week later. The change was so remarkable that it led to the immediate completion of the tropometer, which had been previously commenced, but which, on account of some difficulties in arranging the details, had been left unfinished.

It is interesting to add that the woman, who had been subject to very frequent and very severe attacks of epilepsy, had no more attacks during the two years that I knew of her condition. Since then I have had no information regarding her.

So far, indeed, does this effect of tension extend that chronic spasmodic conditions arise, as in torticollis, which have the initial cause in declination and which are in some cases quickly relieved by appropriate treatment of the ocular condition, and in other cases, where the declinations are extreme, the relief comes, but only as a result of much patience and skillful management.

That these difficulties of adjustments also affect distant organs by the reduction of the general nervous supply is no less true. Hence, many forms of nervous manifestations, which are the signs of a lack of nervous force sufficient to perform the offices of a special organ and at the same time answer the demands of the rest of the organism, are not in general local diseases, but local expressions of nervous fatigue. If anophoria predisposes to imperfect respiration, dyspepsia is a besetting penalty of katophoria.¹ A single suggestion in addition is appropriate.

A class of causes so prolific of nervous disturbances may extend



Fig. 110.



Fig. 111.

its effects beyond the mere functional manifestations. That nutrition may be disturbed is evident, and that the nutrition of nerve centers may be so modified that organic changes may result, it is reasonable to assume.

It will be seen that the person represented at Fig. 110, with the long head (from before backward) and the strong angle of the face, carries the forehead quite far back and the chin well up, not from any affectation of attitude, but because it is less wearisome to the eyes to assume this position. As a matter of fact this person's eyes were normally adjusted 10° below the plane which has been found to be the best and which may be called the standard plane. On the contrary

¹See, for a suggestive explanation, page 193.

the young girl whose pose is represented at Fig. 111, whose head is high compared to its transverse and horizontal diameters, a head which is neither of the long nor broad type, but of the medium (tall) type with the absence of a strong angle of the face, had the plane of vision very high. Such a person prefers to throw the forehead in advance and the chin into the breast, rather than make a continual and somewhat tiresome effort to draw the eyes to the proper plane by direct tension upon the depressor muscles of the eyes.

It is not difficult to see that this selection of the easiest method of adjusting the lines of sight to surrounding objects exercises a commanding influence on the whole pose of the body.



Fig. 112.



Fig. 113.

Attention has been directed to the fact that the excessive upward direction of the plane of vision is found principally with the tall or, more technically, the mesocephalic head. Not only is the pose of the head and body modified by this adjustment of the eyes, there are marked characteristics of facial expression due to the same cause. In cases of these high adjustments the brows are compressed and the expression is one of intensity. The chin is not elevated as in the other class, but the forehead is advanced and the body leans forward. The shoulders bend forward and the chest is often compressed. With the noblest form of the head often comes a stoop of the body. Fortunately for the world these people do not all have consumption, for if they did one of the highest forms of development of humanity would be wiped out. Unfortunately, however, it is from this class of people that consumption finds the great majority of its victims. Glance at

the position of the air passages in these two portraits, in each of which the habitual pose of the body and head is fairly represented.

In the case of the one with the broad head and difficult upward rotations of the eyes (Fig. 112), swarm of tubercle bacilli would pass in and out of the respiratory passages with much the same effect as any other minute particles of dust, while in the case of the tall headed boy (Fig. 113) who has, by actual measurement, the visual plane adjusted more than twenty degrees above the horizon, the larynx forms a hinge-like valve and in the quiet eddies of a lung under these circumstances the tubercle bacilli can easily hold high carnival. If the direction of the large branches of the air tubes is considered it is evident that the circulation of the air in the very upper portions of the lungs of one with such a habitual pose would naturally be even less active than in the lower parts, and it is interesting to remember that it is in the upper lobes that the bacilli usually commence their inroads. The modern treatment of consumption is fresh air. It is evident that the amount of air admitted to the lungs of a person with the habitual attitude of this boy must be very materially modified by this position of the head; and could the normal pose be improved he would by that means be automatically subjected to the fresh-air treatment. It will be seen that this is entirely practicable.

SECTION XLIV.

FACIAL EXPRESSIONS RESULTING FROM THE CONDITIONS OF THE EYE MUSCLES.

Among the obvious phenomena of heterophoria and of declination are certain forms of facial expression which are so characteristic as to reveal to the expert at a glance the general facts in regard to the existence and kind of the anomaly. Even the general observer when once his attention has been called to these characteristic forms of expression is able to make a fairly accurate estimate of the underlying conditions of adjustments of the eyes.

The fact that such habitual and normal facial expressions are in any way related to the state of the eye muscles in health was first shown by myself in a paper published in *Science*, May 6, 1892. The subject was more fully discussed in an article in *Annales d'Oculistique*, October, 1892. In these papers only the expressions incident to the different forms of heterophoria were discussed. Later those from

declinations were pointed out in my contributions to the subject of declinations.¹

Space in this work does not permit of a full discussion of the important phenomena and principles involved in this subject, and only a summary of the facts can be here given.

As it is elsewhere stated that heterophoria is in general the expression of the efforts of adjustments from declinations, it is obvious that declinations must play an important rôle in the expressions of heterophoria. So far is this true that some of the characteristic expressions at first attributed to certain forms of heterophoria are in fact those of declination modified by the heterophoric state.

Thus, for example, hyperphoria is generally characterized by a group of tensions of the facial muscles which is often very striking. But some of the principal elements of the group arise directly from the declination which is the cause of the hyperphoria, while others are either the direct results of the latter anomaly, each set of elements

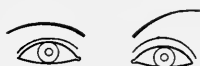

Fig. 114.

being modified as the result of the two conditions, the original and the secondary.

Some of the characteristic expressions of declination have been already referred to in Section XXVIII. They will be recalled here in order to associate them with those of heterophoria.

The contour of the brows is very strongly marked with most cases of important declination. Three very distinct and suggestive forms are observed with three as distinct associated forms of declinations.

These are, first, and perhaps the most common, the form in which one brow is compressed while the other is elevated at the outer extremity. The diagram (Fig. 114) is not at all exaggerated. It indicates homonymous declinations, the compressed brow being over

¹The extreme peculiarities of the actions of the facial muscles resulting from paralysis of the muscles controlling the upper eyelids had been observed and described. The expressions arising from the peculiarities of expression from normal adjustments had not, previous to the appearance of the articles referred to, received attention in any publication.

the eye with the positive leaning of the vertical meridian, the slanting one over that with negative declination. There is often associated with such a combination of declinations marked hyperphoria, and since the eye with the positive declination is that the visual line of which tends to rise above the other, the expression becomes a part of that of hyperphoria. To this we shall return.

Independently, however, of any manifest hyperphoria, there is often associated with this form of expression a depression of the position of the whole eyeball. This expression has been observed by others and has been incorrectly attributed to asymmetry of the bony structures of the face or cranium. Text-books on the eye have published reproductions of photographs of such asymmetrical faces and anatomists have recognized the phenomenon. Thus, O. Zoth writes to this effect:¹

“When the head is in the primary position and parallel lines of regard are directed toward the horizon, it will usually happen that the centers of the two pupils will be in the same horizon. This is not, however, always the case, *since variations in the height to the extent of some millimeters occur through the asymmetry of the cranial bones or perhaps also of the soft parts.* Still more important differences are found in the asymmetry of the (sagittal) planes of the skull, so that the left eye *usually lies several millimeters nearer to the central (sagittal) plane than does the right.*” The author quotes, in this connection, Hasse, *Arch. für Anat. und Phys. Anat.*, 1887.

Practical experience with great numbers of these cases has shown me that, beyond question, the false location of the depressed eye when it is associated with the depression of the brow, is the direct result of the muscular tensions brought to bear in the automatic correction of the tendency of the meridians to tilt in the positive direction. With a corresponding tendency to negative declination, the eye is elevated.

If the declination is corrected by suitable operative measures the depressed eye rises to the plane of the other and no longer presses toward the median plane. The illustrations (Figs. 115 and 116) show two of these cases of asymmetrical position of the eyes in which the + declination of the left eye was in each case pronounced, while the negative declination of the right was nearly as great.

As a matter of fact the depression of the eyeball is less than appears, for in nearly all these cases there is a tendency of the head

¹ In Nagel's "Handbuch der Physiologie des Menschen," 1905, iii, p. 291.

to lean to the side of the positive declination, while it is also somewhat rotated so that the median plane is directed somewhat to the right. In both the cases shown, if the head had been confined exactly in the primary position, the asymmetry in the position of the eye-ball would have been less conspicuous, while the difference in the curve of the brows would have been shown to be no less, but rather more in contrast.



Fig. 115.

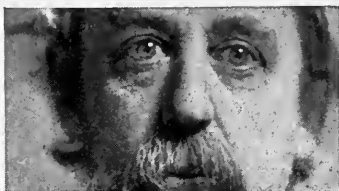

Fig. 116.

There are many modifications of this form of arrangement of the brows depending upon the degree of declination for each eye, and the proportion between the positive and negative form of leaning of the meridian. It is with this form of declination that we have esophoria, but there are cases in which there is slight positive declination for one eye and much more decided declination of the same form for the other, or in which there is no apparent declination for one and pronounced declination for the other, that esophoria is also to be found. If there is distinct anophoria, the expression will be distinctly modified by this fact.

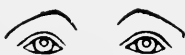

Fig. 117.

A second form of expression about the brows from declination is that in which each brow slants up from the temporal extremity and terminates almost in the general line of slant at the median extremity. Two deep ridges usually pass from the inner extremities of the brows downward in adults. This form is seen at Fig. 117.

It is associated with double positive declinations, the degree of tilting being nearly equal for the two eyes. As such double declinations are conducive to exophoria, this form of brow adjustment is also suggestive of exophoria, but since exophoria does not always

result from such declinations as usually induce the expression alone, it does not prove exophoria.

A third form of brow contour which is characteristic is that in which the brows are each elevated toward the temple and each has a curve similar but not always equal to its fellow. It is shown at Fig. 118. It is, like the form shown at Fig. 117, indicative of positive declinations of each eye, but of quite unequal degrees. Exophoria is more commonly found with this expression, but when the degree of positive declination of one eye is greatly out of proportion to the other, esophoria results, hence the expression may sometimes be found with esophoria.

It is evident from what has preceded that since esophoria or exophoria may depend on the proportional degree of declinations of the two eyes, there may be certain modifications of facial expressions in each of these forms of heterophoria.

There are, notwithstanding this, certain forms of expression which are typical for each of these anomalies.



Fig. 118.

Several forms of expression are shown at pages 323 and 324, where the diagrams represent the typical adjustments of the facial muscles with orthophoria, esophoria, exophoria, and hyperphoria.

With cases of permanent orthophoria there is, as a rule, only slight declination of either eye; there is therefore no heterophoric tendency and no anomalous tension of any of the facial muscles in the effort to correct such defects. The typical expression is indicated at Fig. 119.

The brows are neither strongly curved nor are they straight. They do not point upward toward the temples nor toward the nose. The curve is slight and equal for the two sides of the face. The line of the mouth is horizontal, being neither arched toward the nose nor downward. It is usually considerably shorter than the mouth of an exophoric person. The lines from the alæ of the nose are neither strongly downward nor do they approach too much the horizontal. The cheeks are neither extended nor drawn in, hence the face is oval and regular.

Taking the face in all its elements, there is an expression of dis-

tinged muscular repose compared with the expression of any form of heterophoria. This, however, does not prevent, but rather encourages, a free play of the facial muscles, and the expression is not only vivacious but agreeable.

The most characteristic expression of esophoria is that shown at Fig. 120. Esophoria is very frequently associated with anophoria, in which condition, as shown in the figure, the brows are generally compressed. With this depression there is the unequal direction of the brows characteristic of declination. The eyes are not fully open and the upper lid is nearly hidden. The mouth generally curves upward at the middle, the cheeks are protruding, the lines from the

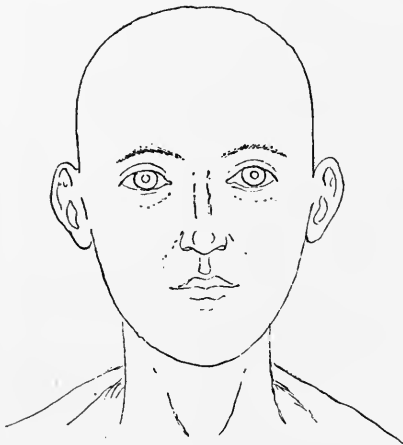

Fig. 119.

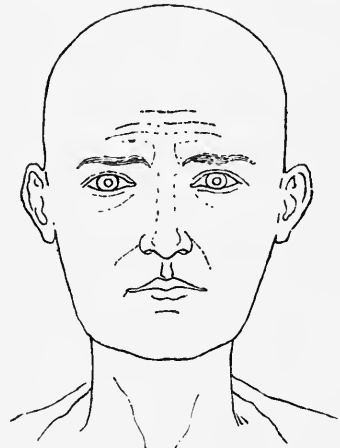

Fig. 120.

alæ are more horizontal than they are in orthophoria. On the whole, there is in this expression a suggestion of tension of the muscles of the face, with partly closed eyes, full cheeks, and horizontal lines. The deep vertical lines which occur just above the root of the nose and the horizontal lines low on the forehead add special features to the picture.

With exophoria we have a marked contrast to the ensemble of expressions of esophoria.

The most typical form of exophoric expression is that shown at Fig. 121.

Exophoria is often associated with katophoria, and hence we have more frequently the elevated brows.

The brows may have the form shown in the diagram at Fig. 117,

high at the center and sloping slightly each way, or either of the forms seen at Figs. 118 or 121. That shown in the diagram (Fig. 121) is perhaps most common. The eyelids are conspicuous, not because they droop, but because the tissues above are drawn away from them. The mouth curves downward at the middle and is long, the frenum of the upper lid is long. The lines from the alæ of the nose descend abruptly, and the cheeks are drawn in, giving the face an appearance of length. With the form of eyebrows seen at Fig. 117 the face is broader and the lines less vertical. In the typical form as seen at Fig. 121, the horizontal lines of the forehead are higher



Fig. 121.

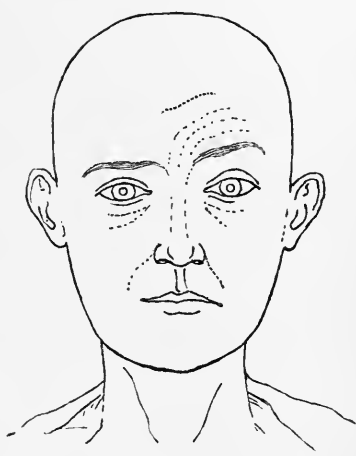

Fig. 122.

than those of esophoria. In adult age, and especially in advanced age, the exophoric expression, or more exactly the double + declination expression, becomes so pronounced that the elevation of the brows and the depression of the eyelids, as they press against the eyes to aid in holding the eyes in position, leads to the supposition that a condition of ptosis exists. Quite on the contrary, the eyelids were performing unusual duty.

The typical expression from hyperphoria is even more characteristic than the others. The fact of the existence of very pronounced declination aids in the peculiarities of the muscular tensions. The unsymmetrical features shown at Fig. 122 are the normal results of the conditions leading to hyperphoria and the fact of hyperphoria itself. The diagram shows the compressed brow on one side

and the elevated one on the other. By compression the brow aids in preventing the deviation of the visual line of that eye above the other. The elevation of the other brow removes pressure, permitting the lower inclined visual line to be raised. Thus, the expression of declination and that of hyperphoria coincide so far as the brows are concerned. But the whole face enters into the effort to avoid diplopia. On the side of the compressed brow the corner of the mouth is raised and on the side of the elevated brow the mouth is depressed. Thus one side of the face appears longer than the other. A curved ridge in the skin or a series of ridges is shown above the elevated brow, and the frenum of the upper lip is drawn toward the depressed end of the mouth. Thus there is a marked appearance of a want of symmetry of the two sides of the face. The head is generally held on one side, leaning toward the shoulder of the side on which the brow is compressed and compensating leanings of the body. This form of expression has more than once, in scientific works, been figured as an example of unsymmetrical formation of the brows, of the head and face. It is interesting to note, however, that immediately on a successful correction of the declination, and consequently of the hyperphoria, the whole face becomes symmetrical.

A study of the muscular causes of these peculiarities of expression is extremely interesting, but I must refer the reader to my essay "Les Muscles Moteurs de l'Oeil et l'Expression du Visage" in *Annales d'Oculistique*, October, 1892, for a full discussion of the causes of each form which I have here mentioned.

A single question remains to be answered here. Will a correction of the existing heterophoria or the declination serve to modify the expression, rendering it more regular in repose and more agreeable? The most positive affirmative reply can be given to this question. This work is not intended as a medium for reporting cases, but with a view of illustrating the satisfactory and often even surprising results which may be expected, a few contrasting pictures are here introduced. It should be said that in each instance the photograph indicates, not some momentarily strained expression either for better or worse, but shows the passive and customary expression without suggestion and without special posing. Also, it should be said that in no instance has the negative been in any sense retouched or improved. The portraits are from the negatives as they came from the camera and the developing bath. If one should suggest that the same person may at one time show greater repose of features than at another, I

reply that these contrasting portraits show, not occasional and accidental improvements, they simply illustrate a rule—a rule which, when the conditions of relief to the declination and heterophoria are fulfilled, is as uniform in its action as any in physiology.

Figs. 123 and 124 represent a young girl with epilepsy who had a high degree of esophoria. It will be seen at Fig. 123 that the entire expression of the face agrees with the diagram (Fig. 120).



Fig. 123.



Fig. 124.

There are the compressed brows, but it is easy to see that the right is compressed much more than the left. The two creases between the brows, the shortened lip, the fullness of the cheeks, the compression above the eyelids, nearly concealing them, all go to make a picture of esophoria.

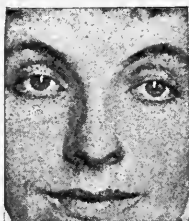

Fig. 125.

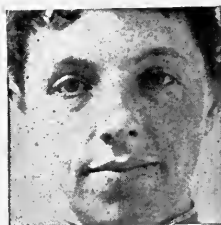

Fig. 126.

Three weeks later, when the esophoria had been relieved by operation, the second photograph was taken (Fig. 124). Here there is an absence of tension of the face; the brows are raised equally, the overhanging tissues no longer conceal the lids, the eyes are more open, the lip is not contracted, and the lines between the brows are gone. It is pleasant to add that the girl has been well of epilepsy since these photographs were taken, ten years ago.

Figs. 125 and 126 show the typical expression of exophoria in a

lady. It is easy to see in Fig. 125 the elevated brows, the exposed eyelids, the long mouth depressed at the center, the drawing in of the cheeks, in fact, a picture of exophoria. The exophoria was relieved by operation before the conditions of declination had been studied. The second photograph (Fig. 126), taken some months later, shows the modifying influence of the correction, although subsequent examinations have shown important declinations, the existence of which could well be assumed by one accustomed to observe these expressions.

Figs. 127 and 128 represent a lad with hyperexophoria. Fig. 127 shows the habitual expression of the boy before the defect was



Fig. 127.



Fig. 128.

corrected. Fig. 128 shows equally the habitual expression after the correction of the hyperphoria only.

These contrasts are not unusual or exceptional; they are, as has already been said, the rule. They illustrate the influence of the tensions of the eye muscles on all the muscles of the face.

SECTION XLV.

TREATMENT OF NON-STRABISMIC ANOMALIES (ANOPHORIA, KATOPHORIA, HETEROPHORIA AND DECLINATION).

GENERAL TREATMENT.

The treatment which may be called "general treatment," that is, treatment directed to the general physical condition of the patient, need not be considered separately for the different anomalies thus far discussed, since it is the same for all.

It will not be supposed by any one who has duly considered the subject that the conditions described are essentially amenable to any

“general” treatment. They are all conditions depending directly upon anatomical peculiarities, and cannot be changed by medical or other treatment directed to general physical conditions.

Notwithstanding this, much temporary benefit may result from well-considered treatment of this nature.

These conditions, anatomical as they are, are nevertheless such as may be supported, often without marked suffering or even conscious inconvenience, provided the general forces of the system are ample and the parts engaged in overcoming the defect are not disabled by fatigue. In childhood and early youth the effects of most of the conditions of these classes are unobserved. The great elasticity of tissues, the affluence of surplus energy, and the comparatively moderate demand upon the adjusting powers of the eyes, all contribute to a comparative degree of immunity from the unpleasant effects which may be experienced after the more severe duties of school or of active life have made greater demands, or after sickness has reduced the surplus of nervous capital.

Such facts are eminently suggestive in regard to the relief which may be hoped for when the local or general effects of these unfavorable eye adjustments are present.

• The child whose face or whose shoulders exhibit the convulsive movements of chorea, the mother who suffers from oft-recurring headaches, and the student who suffers from asthenopia are all, most frequently, examples of the fact that in the case of each the expense of ocular adjustments is greater than the victim is able to afford. The natural and logical course would be in each case the institution of a greater economy, first in the employment of the parts directly employed in these adjustments, and then in the general expenditure of nervous energy.

In short, the remedy which suggests itself first and most forcibly is rest.

The choreic child removed from school, the tired mother relieved of her duties, and the student sent on a vacation may each get better of the nervous complaint. In each case the trouble may return when the abandoned duties are resumed, but at least there is temporary relief in a great many cases. During such temporary relief the general physical tone may so greatly improve that freedom from the disturbances to health may be gained for a certain time. Rest will not remove the anomaly nor will it render the demand upon the nervous forces in adjustment any less. It will permit the nervous

energies to be renewed and thus enable the patient to overcome his defect.

Something more than this may be required. The general "tone" of the individual may have become so low that treatment directed to its reestablishment may be required. Among the instrumentalities to this end are tonic medicines, a change of air, and, better than either, a change of surroundings. Tonics, fresh air, wholesome and abundant food, and travel constitute the principal means for reestablishing the general vigor of the nervous organism.

Even the abstinence from accustomed labor and the use of the tonics above mentioned may fail to bring relief, because the muscles of adjustment, having become irritable and exhausted, are unable to return to their normal state, notwithstanding all these things.

As a local stimulant electricity, judiciously applied, may serve a good purpose. There is much fallacy in vogue popularly, and even among physicians, in regard to the rôle played by electricity in such cases. It is a delusion to suppose that electricity and nerve energy are here convertible forces, that by passing the current of one through a portion of the body a supply of the other is furnished. Electricity, the faradic current, stimulates the action of the nerves, bringing into active and unusual movement the forces which are already prepared. This active and unusual movement may induce a change of nutrition, of metabolism, or establish a new way for the action of the nervous powers possessed by the individual.

The passing of a weak faradic current through the orbits three or four minutes daily for a few days may prove a decided relief to many cases of nervous disturbance arising from the difficulties of ocular adjustments.

Before leaving the consideration of these constitutional or general methods of treatment, it is important to mention some of the things which should not be done.

Among the symptoms induced by the anomalies under consideration, the most common perhaps are headaches, neuralgia, insomnia, and asthenopia. All these are painful or distressing, and in the case of all it is relief for which the patient asks. It has been of late years customary to obtain such relief by the administration of certain coal-tar preparations, such as sulphonal, chloral, etc. An immediate relief is often gained and sleep is induced, hence, there appears to the patient no reason why the remedy should not be repeated whenever the pain returns.

It should, however, be borne in mind that these drugs are all paralyzers. The relief gained is unlike the relief gained from an opiate, and the muscles which have been the origin of the trouble are, following a dose of sulphonal or chloral, less able to accomplish their function than before. From the clinical point of view, the effect of this class of drugs appears to be that of paralyzers of the nuclear region supplying the nerves of the eye muscles. This being the case, the administration of medicines of this class, while possibly affording immediate relief, lays the foundation for more frequent and more serious manifestations of the nervous trouble, and temporary relief is given at the expense of more lasting injury.

More than twenty years ago I observed that after using drugs of this class (chloral was the representative of the class at that time) the eye muscles were in a state of mild paresis and that the tests for heterophoric conditions were unreliable. Abundant observation has shown that these drugs are most pernicious in their action in all cases of nervous disturbance arising from anomalous states of the eye muscles.¹

THE USE OF PRISMS.

Coming to the more direct agencies through which relief from the functional disturbances arising from the action of the eye muscles may be gained, the use of prisms will be first mentioned. They may be used either as instrumentalities by means of which certain exercises of a gymnastic character can be accomplished, or they can, by virtue of their refractive character, be used as spectacles to be worn habitually.

The employment of prisms as a means of gymnastic exercise was suggested by von Graefe, but was little used by him. Von Graefe's pupil and disciple, Soelburg Wells, in his admirable work on the diseases of the eye, recommended exercises by prisms, advising that the patient look at a wand or other object six feet in front of him and try to overcome prisms. No very systematic method, however, was adopted.

¹ Dr. Arthur A. Boyer, who was for a number of years my assistant, published a valuable study of the effects of these drugs under the title, "A Study of Some of the Drugs Used in Functional Nervous Disorders" (*Journal of Nervous and Mental Diseases*, February, 1893).

In my own practice I gave, many years ago,¹ much attention to this kind of exercise and reduced it to a more orderly procedure. It was one of the means by which many of my earlier reported cases of neuroses treated for ocular defects were relieved.

I reproduce here, in substance, the method described in one of my publications as practiced in the early stages of my work in this field.²

"The patient looking at the flame of a candle at twenty feet distance, a weak prism is placed, base out, before one of the eyes. As soon as the images unite, an equal prism, with its base also out, is placed before the other eye. As fast as images are united this alternate addition of prisms is continued, until it is no longer convenient to add to them or until the patient fails to unite. Then, if union cannot take place, the prisms are removed and the same process is repeated until more can be accomplished, if possible.

"If the patient is able to unite these weak prisms the surgeon begins with those of higher grade, adding alternately until the images are no longer united. This is also repeated several times.

"By this means the adducting ability may be raised, after a few exercises, to a much greater degree than at first existed.

"The exercise should not be continued more than five or six minutes.

"A similar method can be used in overcoming by abduction, the prisms being placed with their bases in. In this case it is rarely required to add one prism above another before both eyes, a single prism before one eye serving the purpose."

GYMNASTICS FOR DECLINATION.

In connection with the subject of gymnastics with prisms, exercises of an analogous character may be described, which can be done in cases of anomalous declinations by means of small glass rods, such as Maddox has suggested for testing in heterophoria.

Placing in the trial frames one of the disks carrying a rod for each eye, the patient unites the images of a candle flame. The rods are then rotated out and in, the patient holding the union as long as possible as it rotates each way. A little instrument, which I de-

¹ In papers published in 1878 and 1879 these exercises were described.

² "Mémoire Addressé à l'Académie Royale de Médecine de Belgique," par George T. Stevens, 1883.

scribed,¹ and which I called the *rod clinoscope*, serves very well for this purpose, and permits of determining the extent of the adjustments which can be made.

The instrument is not of practical value for determination of the degree of declination. In use it is hung from the arm of the phorometer.

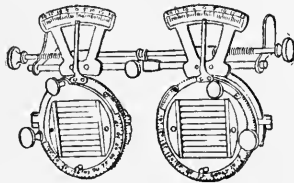

Fig. 129.—The Rod Clinoscope.

The measurements of the rotations by this means are not altogether satisfactory, partly because the length and illly-defined borders of the lines of light render it difficult to form a correct judgment as to the perfect union.

By far the best means of arriving at a satisfactory knowledge of the rotations around the line of regard is that afforded by the tubular clinoscope.

Removing the haploscopic fractional diagrams which are essen-

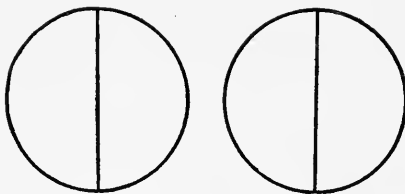

Fig. 130.—Objectives for Clinoscope.

tial in the primary use of the instrument, a disk with a single straight line extending from top to bottom is placed in each tube. (Fig. 130.) The sharpness of definition of the line and the fact that it does not extend too far in the field of regard enable the observer to determine very closely the extent of the revolution. For purposes of scientific examination this method is essential, that by the streak of

¹ Ophthalmic Record, May, 1898.

light being altogether too vague. As in the case of the rods, the clinoscope tubes may be rotated, first in one, then in the other direction as long as the vertical lines are held in union. Only a few minutes should be allowed to such an exercise. It need not be said that such exercises do not in any degree correct any of the actual declination, but they may possibly in some instances afford a temporary relief to some of the symptomatic manifestations.

PRISMS WORN AS SPECTACLES.

Prisms may be used as spectacles for the correction of the tension induced by the different forms of heterophoria or for ano- or katophoria.

For heterophoria, prisms which together correct rather less than the degree of the defect should be used, and a prism exceeding 3° before one eye is rarely of any service. The instances in which persons use very strong prisms with supposed benefit are generally those in whom, when the attention is withdrawn from the efforts to unite, images are thrown even farther apart than they would be without the glasses.

It is a safe rule to say that a prism exceeding 3° is, for the purpose of spectacles, worse than useless.

Many years since I introduced the method of using temporary prisms in the progress of investigating the latent heterophoria. I had prisms of 1° , 2° , 3° , and 4° made by the gross and frames to match. In these frames any prism could be adjusted in a moment. It was my custom to loan these glasses to patients, some of whom used them for many weeks. My experience, in watching from week to week a great number of persons thus using prisms which were carefully adjusted and never sufficient to correct the manifest trouble within one or two degrees, convinced me that the cases in which any important relief is derived from the wearing of prisms is extremely rare. That a few persons do find temporary relief, and a smaller number somewhat permanent relief, is true, but the proportion, compared with those who gain no relief is small. This statement is made from an experience doubtless greater than has been presented to any other observer, and is made without reservation.

In anophoria and katophoria I have found a larger proportion of cases in which comparative relief has been afforded than in hetero-

phoria. In these conditions the prisms may be of equal strength up to 3° with their bases up for katophoria or down for anophoria. Next in the order of proportional relief are cases of moderate hyperphoria, 1° or $1\frac{1}{2}^\circ$.

In the employment of prisms for hyperphoria care should be exercised to place the prism in conformity with the normal direction of the optic axes in respect to the horizon. If the hyperphoria is associated with anophoria the base of the prism should be down before the eye whose visual line tends to rise above the other. If there is right hyperphoria with anophoria, place the prism before the right eye with the base down, or, if the relief is to extend to the anophoria, place a prism before each eye with the base down, but with the prism before the right eye stronger than that before the left. The same principle holds in katophoria; the base of the prism should in this case be up, and if the hyperphoria is right, the strongest prism should be before the left eye.

DECENTERING OF SPHERICAL AND CYLINDRICAL GLASSES FOR OBTAINING PRISMATIC EFFECT.

Every spherical and cylindrical glass consists essentially of an infinite number of prisms. In the case of the cylinder the prisms only extend in the direction at right angles to the axis, but in that of the spherical lens the prism influence extends in every direction from the optical center.

NOTE.—According to the suggestion of Mr. Charles F. Prentice the unit for the measurement of prisms is a tangential deviation of one centimeter measured in a plane situated at one meter distance from the prism, without considering the angle of the glass or the index of refraction. This unit he calls a prismatic diopter or dioptric prism. According to this calculation:

One diopter prism corresponds to a tangential deviation of 1 centimeter at a distance of 1 meter.

Two diopter prism corresponds to a tangential deviation of 2 centimeters at a distance of 1 meter.

Five diopter prism corresponds to a tangential deviation of 5 centimeters at 1 meter distance, etc.

This method of graduation of prisms has many advantages, among which are that the unit corresponds with the unit of spherical and cylindrical glasses as now numbered and that the prismatic power to be obtained by decentering spherical glasses numbered in diopters is perfectly easy to determine.

For example, a spherical convex lens of 1 diopter has its focal distance at 1 meter. That is, rays passing through any part of the lens pass either

without deflection or with such deflection as is necessary to unite all at the distance of 1 meter in the plane of the axis of the lens. If the ray passes parallel to the axis of the lens of 1 diopter, at a distance of 1 centimeter from the optical center it will be deflected to the extent of meeting the axial line of the lens at a distance of 1 meter, hence the decentering of a lens of 1 D spherical 1 centimeter is equal to producing an effect of 1 D prism.¹

In practice the most convenient and most satisfactory manner for determining the distances between the optical centers of spectacles of spherical lenses in order that they shall have the desired effect as prisms, or in order that they shall have no prismatic effect,

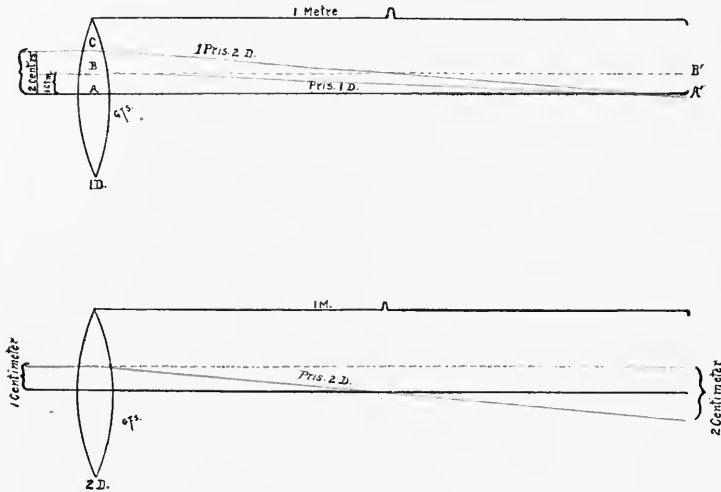

Fig. 131.—Diagram Illustrating Decentering of Lens for Prismatic Effect.

is that of adjusting the trial glasses by the aid of the phorometer. This is accomplished as follows:—

Having determined the character and strength of the refracting glass for each eye for distance, these glasses are placed in the trial frames and put before the eyes of the patient so that the optical centers will be at the level of the pupils. Then placing the phorometer in position, its prisms are rotated to the vertical position indi-

¹ For a full discussion of the subject of the prism diopter, see a paper by Mr. Charles F. Prentice and a note on the application of the metric system to numbering of prisms by George T. Stevens, in *Annales d'Oculistique*, July, 1892.

eating O^o . The patient looks at the candle flame, seeing the two images. If one image is not vertically over the other the phorometer maintains the same adjustment, but, by means of the screw connected with the trial frame, the glasses are to be moved out or in until the two images of the flame are exactly in the same vertical line. Of course, if the glasses are of strength insufficient to do this without such decentering as to give to a spherical lens a different character, the object can only be accomplished by combining a prism with the spherical lens.

When the exact point is reached at which there is neither esophoria nor exophoria, the distance between the centers of the lenses is measured and this distance becomes a part of the prescription to the optician which is to be observed in making the spectacles.

If the glasses are for reading only, a modification of this method is required, for glasses which at near points would bring the images in line at the reading point would, in some instances, cause a practical esophoria.

In this case, after choosing the glasses, they are to be placed as before in the trial frame and in the proper relation to the eyes. Then the phorometer is to be brought *close to the eyes* and set at about 5^o exophoria. By turning the screw of the trial frames the images of a dot or small cross on a card, which is held at reading distance, are brought to the vertical position, and the distances between the optical centers measured as before. In making this test the *line* of von Graefe through the dot is to be avoided, since, except in cases of moderate squint, the patient will hold the images in position when there is a line for guidance.

SECTION XLVI.

SURGICAL TREATMENT.

While it is to be admitted that medicines which promote the general vigor of the individual must be of value, that a change of air and of environment exert influences which are favorable, and that pleasing emotions and hopeful encouragements serve to promote the well-being of patients suffering from neuroses which have their origin in ocular disabilities, it is evident that the conditions which have served to induce the neuroses are not removed by any of these means.

The teaching of von Graefe in this connection is extremely ap-

propriate. In speaking of the treatment of asthenopia by means which are not radical, he says:—

“In these cases of temporary asthenopia, fresh air, cold water, tonic medicines, and electricity are indicated. What disappears under such treatment is only the symptom of asthenopia, while the disturbance of the equilibrium of the antagonistic muscles remains and the least sinking of energy recalls the former difficulties.”¹

Just as the local symptom asthenopia may disappear for the time under the influence of rest and tonics, the more distant nervous reactions arising from the class of causes, neuralgia, chorea, “neurasthenia,” dyspepsia, may also temporarily disappear, only to return when the environments or the circumstances of the patient become slightly less favorable.

The patient suffering from neurasthenia, a term indefinitely signifying a state of nervous irregularity or exhaustion, may find the pleasurable experiences of travel in foreign countries highly beneficial, and the aching back, the painful brow, and the reduced energy may give place to freedom from pain and greater nervous activity. The same patient, returning home to the accustomed duties of life, brings back the same physical disadvantages that were taken abroad, and soon finds that these disadvantages produce results of the same general class as those suffered before.

It is not always that the nervous symptoms resulting from ocular disturbance are specifically the same after such a rest, for neuroses are changeable by reason of many sorts of influence. It is safe, however, to say that the person who has once been the subject of neurasthenia in any of its forms is quite likely to be again subject to it in one or another form whenever a special demand upon the energies is continued for a considerable time.

Only in one direction can the sufferer from the neuroses from ocular irregularities look for permanent and complete relief. That direction is toward the radical and permanent removal of the cause of the disturbance.

The question may fairly be raised whether it is practicable to remove these anomalous conditions, and also whether the risk of creating new defects is not so great as to render the undertaking undesirable, even admitting that under the most favorable circumstances they may be remedied.

¹ Archiv für Ophthalmologie, Bd. 8, ii, 346.

To the first part of this question it may be replied in the most emphatic manner that these anomalous relations of the eye muscles are in the vast majority of cases removable. To the second part of the question it may be said that while much depends upon the skill of the operator and his judgment in respect to what should be done, the risk of inducing new anomalies worse than the first is, in the hands of one fully qualified to treat such cases, incomparable to the benefits to be derived from a proper and permanent relief from the defects.

Allowances are always to be made for the unavoidable and universal imperfections of pioneer work. The system which has been presented in this work and the surgical practice based upon it have been recognized during a comparatively few years, and it is true that, failing to recognize some of the basic conditions which have been revealed by more recent research, the earlier results, however satisfactory, on the whole, were far less certain and much less radical than may now be obtained when advantage may be taken of these later observations.

The success of later efforts to correct these anomalies has advanced proportionately to the advance in knowledge of the essential nature of the defects. It may now be said that with the knowledge at present possessed of the principles and phenomena of heterophoria and the kindred conditions, given the requisite skill, judgment, and experience, the risks of surgical treatment for these defects is positively insignificant.

The question whether a patient is to be subjected year after year to the disadvantages of a defect which is removable because it may be thought more safe to trust to temporary means of relief is one involving more than the momentary suspension of symptoms.

In early years the course for the future of the individual is often greatly modified by the presence of some physical feature which may act as a handicap in the race of life.

The great principle which should guide in all the surgical treatment of the muscles of the eyes is that all the functions of movement should be made more perfect and more harmonious after the treatment than before. Such a principle is absolutely antagonistic to the empirical practice of severing a muscle with its accessories from the eyeball, permitting its tendon to fall back within its sheath, disqualifying it for its rotary function, for the purpose of a cosmetic improvement or the neutralization of a supposed "insufficiency" by the

creation of another insufficiency. Still more is it opposed to the infinitely more rude practice, at present somewhat in vogue, of *tuck-ing* the tendon, capsule and other tissues into a knot. Such an operation must of necessity remain an enduring blemish and as surely induces a permanent impediment to the proper motility of the eye as it accomplishes its illy considered purpose. A tendon which has been drawn back into the capsule or orbital tissue and disabled may sometimes, by good fortune, be found and replaced, restoring passable motility; but a tendon which has been folded and cicatrized is hopelessly disabled.

The correction of heterophoria does not demand a disabling of any muscle for the relief of another muscle. The purpose of the surgical treatment is to render all the muscular actions as nearly as possible normal, meaning by normal in this connection the best that is found in the most perfect cases.

To arrive at such a desirable end, it is necessary to consider all the elements in any given case. If the case, for example, is one of esophoria, it does not follow that the inner muscles are too tense nor that the outer muscles are relaxed. The cause of the esophoria may lie in the fact that the optic axes are normally directed above the plane of the horizon or, much more frequently, in the fact that there are such declinations as to make a nervous impulse toward convergence a part of the adjustment for parallelism of the vertical meridians. Esophoria and exophoria are rarely primary conditions.

These and other important considerations are to be carefully weighed in every instance and the treatment directed, not necessarily nor generally immediately against the most conspicuous heterophoric tendency, but against the inducing conditions from which the conspicuous tendency arises.

Eye muscle tendons should never be cut off and allowed to fall back in operations for tenotomy. Their insertions may be so modified as to produce important changes in the relations of the eyes while remaining largely in their original position. The slight change of direction in the insertion of a tendon necessary to change the position of the vertical meridian from an important declination to an actual verticality does not or should not limit its rotating function, but often increases it.

Instead then of proceeding to an immediate discussion of the surgical means for the direct correction of the different forms of

heterophoria, it is better to consider the means of correcting the conditions which are most liable to induce them.

Of these, by far the most influential, as has been repeatedly said already, are declinations. We may therefore first study methods for the correction of declinations.

OPERATIVE TREATMENT OF DECLINATIONS.

While the *effects* of declinations may, under certain circumstances, be modified by glasses, spherical, cylindrical, or prismatic, and while such tonic measures as have already (p. 327) been suggested may be of temporary use, practically, the correction can only be effected by surgical interference.

There can be no absolutely direct method of reaching these anomalies of declination, a modification of the tension of the obliques being the only exception, and it would be a bold and probably a most imprudent surgeon who should undertake to change the actions of these muscles.

There is left, then, only such indirect influence upon the position of the eyeball as can be brought about by changing the direction of the action of the recti muscles.

If, with declination, there coexists the condition of anophoria or of katophoria, somewhat important modifications of the declinations may be accomplished, while at the same time the plane of vision is depressed or raised. To these contingencies we shall return. At present only the direct operations for declination are to be considered.

With the view of preserving, as nearly as possible, the full and equal rotation action of the lateral muscles and at the same time avoiding any raising or lowering of the direction of the visual line of either eye, I have resorted to several methods of procedure, each progressively more effective than the other, until at present only one of these methods is employed, except in cases such as will later be described. Although the earlier methods have been superseded, it will be well to pass in review the process of evolution to the more effective operation for declination.

Earlier Operations.—The first of these was the operation, a description of which I published several years since and called *peritenotomy*. It consisted, essentially, in relaxing a part of the insertion of opposing muscles at diagonally opposite points. Thus, if the lateral muscles were selected for operation for positive (+) declina-

tion, the upper half of the externus insertion and the lower half of the insertion of the internus were relaxed. By this means about 1° or possibly 2° declination could be corrected, but the change of direction of the meridian of more than $1\frac{1}{2}^\circ$ required an extent of relaxation of the tendon insertion which threatened impairment of the action of the muscles. Practically, then, a correction of 1° or a little more was all that could be hoped for with a conservative operation. This gain was reached by some sacrifice, even if small, of the normal tensions of the muscles, and the operation was soon abandoned.

The second step in the evolution was the operation which I called circumtraction (vertical or lateral). In this procedure a part of the insertion of opposing muscles was separated from the sclera, and this separated part was carried forward into a previously prepared pocket, thus advancing, for example, the upper half or two-thirds of the insertion of the internus and the lower half or two-thirds of the insertion of the externus. By this method a correction of a larger degree of declination could be effected, but here again there was danger of inducing a disproportionate action among the various muscles.

The third step in the evolution of an operation for directly affecting declination is what I have termed *extendo-contraction*. It is the operation which I find the most practical and efficient of all the methods which have suggested themselves.

Extendo-contraction.—By this operation the full rotation action of the muscle is preserved, no heterophoria is induced, eyes which were parallel before the operation remaining so after it, while by its means a greater degree of correction of the leaning of the meridians can be brought about than by either of the preceding measures. Even by this process a change of the direction of the meridians of 2° or 3° must be considered a favorable result, although occasionally a much more important change is effected by a single operation.

In cases of high degree of declination the operation may be done on one muscle at one time and on another at another time. The selected muscles are the internus, the superior, and less desirably the externus.

Of course it may be done on the inferior, but it has been found prudent to avoid operations on this muscle as far as possible. As the declination operation is not an easy or simple process, I shall describe it in detail, premising that it is of the highest importance

that the various steps should be taken exactly in the order and in the manner described. Let it be assumed that the internal rectus of the left eye has been selected for the operation on account of a + declination 4° . The surgeon, standing on the right-hand side of the patient, the lids being separated by a speculum, the patient is told to direct the eyes to the left and down. Then the surgeon, seizing a very small fold of the conjunctiva ($\frac{1}{2}$ millimeter) by the fine forceps (Fig. 135), makes an opening with the fine-pointed scissors (Fig. 136) just over the upper border of the insertion of the muscle, and, pushing the blades of the scissors forward while avoiding, so far as possible, enlargement of the small opening in the conjunctiva, he forms a pocket nearly up to the border of the cornea and extending more than half-way down the length of the tendon insertion. (By skillful manipulation the very small opening in the conjunctiva may, by the elasticity

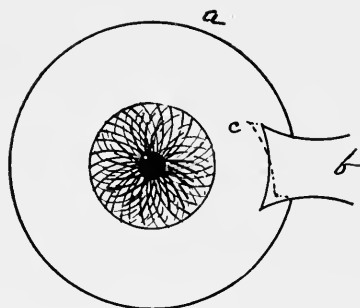

Fig. 132.—Diagram Illustrating the Change of the Line of Insertion of the Tendon of the Internus.

of the tissue, escape any enlargement, so that at the close of the operation it returns to its original small extent of $\frac{1}{2}$ a millimeter.)

The pocket being made, the operator next passes to the left side of the patient. He now seizes the insertion of the tendon at its upper part in the fine blades of the forceps and separates it to the extent of a few millimeters only, working carefully under the conjunctiva, observing care not to enlarge the small conjunctival opening, which will stretch without tearing. He then introduces the delicate sharp hook (Fig. 137) between this separated part and the sclera and when it has been carried back to the desired extent, presses the sharp point against the inner surface of the tendon and draws it forward. The hook should engage itself sufficiently below the border of the tendon



Fig. 133.—Flexible Eye Speculum.



Fig. 134.—Lid Retractor.



Fig. 135.—Fine Forceps.



Fig. 136.—Scissors.



Fig. 137.—Fine, Sharp Hook.



Fig. 138.—Small Tendon Hook.



Fig. 139.—Grooved Director.



Fig. 140.—Needle-holder.



Fig. 141.—Lance Probe.



Fig. 142.—Catch Forceps.

and sufficiently back to insure the drawing forward of that part of the tendon. The part of the tendon engaged by the hook is now forced through the little opening in the conjunctiva, when a small curved needle, one of two attached to a very fine thread, is carried twice through the protruding portion of the tendon, which is then allowed to retreat within the conjunctiva. An assistant takes the two needles, holding the thread out of the way of the operator, who now, using the small tenotomy hook (Fig. 138), dissects from the sclera the remainder of the insertion still with care not to enlarge the original conjunctival wound. If the tendon is unusually broad, a counter-opening near the lower border of the tendon is made, and the division of the tendon is completed from this point. The extent of the division may be ascertained by the phorometer before the next step is entered upon. If 10° or 12° exophoria has been induced the lower border of the tendon is free.

(One who has done the operation many times will be able to judge of the sufficiency of the division of the insertion without the use of the phorometer.)

The assistant now inserts a director through the conjunctival wound into the pocket, carrying it somewhat above the border of the cornea. One needle is carried in the direction of the probe, making its exit above and near the border of the cornea. The second needle is then carried through, 3 or 4 millimeters below, and the thread is drawn and tied in a slip-knot. An esophoria of about 7° to 9° should be induced. If more than this has been brought about, the thread must be loosened until the amount does not exceed the desired extent. Then the knot is made fast and the thread is cut. The thread should be extremely fine, of silk. No catgut is sufficiently delicate for this operation.

On the following day there should be neither esophoria nor exophoria (assuming that there was none before), and there will, if the operation has been skillfully done, be no apparent wound of the conjunctiva, though there will, of course, be redness and some slight thickening.

By referring to the diagram (Fig. 132) an idea may be acquired of what is to be accomplished by the operation. The equator of the eyeball is indicated by *a*, and the tendon of the internal rectus by *b*. The solid line represents the direction of the insertion of the tendon before the operation, while the dotted line represents the position of the insertion afterward.

It will be seen that the extremity of the tendon at *c* has been advanced toward the cornea, while the lower extremity has fallen somewhat back, giving the insertion an oblique direction. The result of this oblique direction should be to influence the vertical meridian to lean from the left farther toward the right.

In order to insure a proper amount of pulling back of the lower half of the tendon and no more, and to maintain the fan-like expansion of the insertion, it is best before finally releasing the lower half of the insertion to insert, through a minute conjunctival opening, a second suture at the lower border of the tendon, and, drawing only sufficiently to hold the expanse in position, avoid a too narrow insertion.

By means of this operation, even with no contraction or relaxation of the tendon, a preëxisting exophoria or esophoria may be found to disappear.

PROCEDURE IN ANOPHORIA AND KATOPHORIA.

A careful consideration of the principles of torsions, as shown in Section XIV, will show that if the normal direction of the visual plane is at an angle above the horizon when the head is in the primary position, there must result a certain extent of torsion in depressing the plane of regard to the horizon when convergence occurs. The irregular torsion increases as the plane of regard is depressed with convergence. In case of normal declinations, then, these torsions may add materially to the native anomaly or they may neutralize it.

As a matter of experience it is found that with very high rotations of the eyes, whether associated or not with restricted rotations downward, the normal declinations are, as a rule, marked features of the ocular adjustments. It will be seen then that anophoria is not only liable to be complicated by important declinations, but that the resulting torsions may increase the effect of these declinations in most of the ordinary adjustments of the eyes.

Were it desirable that the anophoric condition should be modified directly by a reduction of the upward rotations, the operation might be that for graduated tenotomy of each superior rectus, as described below. But since a high grade of anophoria is nearly always accompanied by important declinations, the correction of the defect should not generally be attempted in this simple manner.

Should the operation have for its objective purpose, not only a

depression of the visual plane, but a correction of declination, the procedure must be modified accordingly.

Should it be required, for example, to reduce the plane of vision 5° and to correct a $+$ declination of the right eye, and a negative declination of the left, the most simple, but not necessarily the most effectual, way would be to dissect the insertion of the superior rectus of the right from the medial toward the temporal border, leaving so much of the temporal border as may be required to graduate the depression of the plane of vision, while for the left eye the dissection of the insertion of the superior rectus would proceed from the temporal toward the medial side, leaving the graduating band at the medial border.

This was my earlier method of procedure in these cases, but experience soon showed that it is better even in these cases to do the operation for extendo-contraction, but permitting of a slight setting back of the superior rectus. This is best accomplished by two sutures, as described above, thus controlling the situation and direction of the new insertion.

It is, even in cases of the remarkably high rotations sometimes found in converging strabismus, not safe to carry the effects of a tenotomy of the superior rectus more than 4° or 5° prism, since beyond that point the restraining fibers at the borders of the insertions are severed, and in the subsequent acts of adjustment of the eyes irregular torsions are almost sure to result. Hence, it is always in these extreme cases necessary to control the form and obliquity of the new insertion.

For the correction of katophoria the graduated tenotomy is even less advisable. Indeed, operations on the inferior recti are to be strictly avoided. There may arise contingencies in which it may become necessary to interfere with the normal insertions of the inferior rectus, but in such case the two extreme borders of the insertion should be secured (as in the operation for extendo-contraction) and replaced in such a manner as to give the full expanse to the insertion, which should not be transferred so much in the lateral direction as to induce torsion in the act of depressing the plane of regard.

As this demands extreme caution, and may, even when great skill is exercised, prove unfortunate, it is a safe rule generally to refrain from any interference with this tendon.

To increase, then, the elevating action of the superior recti, contraction may be done so as to augment their upward pull.

The operation for tendon contraction is accomplished according to the method described in another part of this section. As in the case of anophoria it may be, and generally is, required to vary the procedure with reference to an existing declination. With this in view, with a + declination the main suture will be inserted to the temporal side of the center of the tendon, the graduating suture at the nasal side. With negative declination the main suture would be carried to the nasal side.

OPERATIVE TREATMENT FOR HETEROPHORIA.

The truth which should be uppermost in the mind of every one who undertakes an operation for the correction of heterophoria is that every disability of the rotating function of a muscle is to be avoided, and that the purpose of surgical treatment is to enable the eyes to move with greater, not with less freedom, and not irregularly. The object of operations for heterophoria should be to establish exactly equal and favorable movements of the eyes, and there is no justification, under any circumstances, for disabling any one muscle. Especially is there never an excuse for disabling one muscle because its opponent is disabled.

Although it might be possible, for example, to bring the images in line in a case of exophoria by an extensive relaxation of one external rectus while the other remained intact, the unequal rotations thus induced would be a permanent source of evil.

Again, since the conditions of heterophoria are very frequently the results of declinations or of unfavorable plane of vision, operations for heterophoria should remain secondary to these original conditions. If, for example, correcting a positive declination for each eye the previously existing exophoria will disappear. It is surely more philosophic to attend to the declinations first. In the same way a suitable correction of anotropia may remove an esophoric tendency. As a matter of practice during the past few years *I find it very rarely necessary to operate directly for heterophoria*. A large majority of all operations having these conditions in view are such as are primarily directed against declinations, katophoria, or anophoria. The direct operations for heterophoria are graduated tenotomies and tendon contractions. They are the operations which were described by myself many years ago.¹

¹"Prize Essay," Royal Acad. Med., Belgium, 1883.

It is true that graduated tenotomies have been most successful in bringing pronounced relief in great numbers of cases, and it is safe to say that the results have been on the whole eminently serviceable. Some disadvantages must, however, be conceded. Even in the hands of the most skillful it is not always possible to determine the exact point beyond which a relaxation cannot be safely carried. The result, although in experienced hands rare, is an occasional overcorrection which becomes most annoying. Again, even with much care, the rotations of the two eyes are not always preserved equal, and, of more consequence than all, by even a millimeter of relaxation of a rectus muscle the normal tension of the muscles which hold the eyes in place is somewhat modified.

For these reasons, since an even more effective method and one not subject to either of the disadvantages mentioned has been found in the operation for extendo-contraction, it is better to choose the procedure which, though somewhat more complicated and requiring greater skill, offers the greater advantages.

Bearing this in mind, a minutely detailed description of the operation for graduated tenotomy will still be in place. There are occasions when it is the only advisable mode of procedure.

GRADUATED TENOTOMY.

The description of an operation for graduated tenotomy for heterophoria of either of the recti muscles will serve sufficiently well for all. We may therefore suppose that a graduated tenotomy is to be done for the internal rectus of the right eye.

The speculum being in place, the patient directs both eyes well to the right. The surgeon takes with his fine forceps (Fig. 135) a minute fold of conjunctiva at the center of the insertion of the tendon. Drawing the little fold of conjunctiva slightly away from the eyeball, with the extreme points of his tenotomy scissors (Fig. 136) he snips the fold transversely so that an opening about half a millimeter in extent is made through the membrane. Now the forceps, the points being closed, are pressed into the little opening and slightly backward, when the points are permitted to spring apart, after which they are again closed, this time holding a small fold of the tendon just behind the insertion. This little fold of tendon being put on the stretch, the fine-pointed scissors, by little snips, dissect the tendon from the eyeball between the layers of the capsule (which should remain intact) toward one border of the insertion. The sense of feel-

ing of the fingers against the rings of the scissors will, in the hands of one skilled in the operation, inform him of his approach to the border and warn him against its destruction.

The dissection and the knowledge of the distance to which it should be carried will often be facilitated by introducing the slender blunt hook (Fig. 138), by the feeling of which the amount of tension remaining as the dissection approaches the border of the tendon can be estimated and the extent of the border to remain can be graduated. (In extreme cases, like strabismus, the surgeon may determine to continue the dissection to the extreme border, *but that should never be divided*, and as far as possible both the anterior and posterior layers of the capsule must be preserved. In fact, there should be such connections, both along the course of the dissected part of the insertion and at the borders, that there can be no doubt that the muscle will be held in its proper relation to the eye. Such an extreme meas-

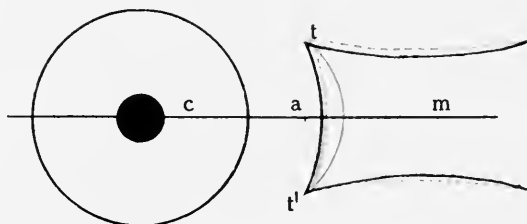

Fig. 143.—Stevens's Operation for Tenotomy. *c*, The cornea. *m*, The muscle. *t t'*, The tendon at its insertion.

ure as permitting the tendon to withdraw into the sheath will never be required, even in strabismus.

Having made the dissection toward one border the scissors are turned toward the other and this portion of the insertion is dissected with equal care.

The diagram (Fig. 143) shows the position and extent of the dissection.

The black outline of muscle and tendon represents the original form and position. The larger red dot indicates the position and size of the conjunctival opening.

The dotted red line just behind the insertion represents the position and approximate extent of the dissection of the tendon. The solid curved red line behind this is the new position taken by the insertion after the operation, which is permitted, less by the exten-

sion of the uncut fibers at the borders than by the change in the form of the tendinous end of the muscle as shown by the dotted lines at the sides.

The dot at the center of the line of dissection is the position of and the relative size of the opening through the conjunctiva.

[The dotted line at *a* (Fig. 144) shows the extent and position of the conjunctival opening in the von Graefe operation. The red line at *b* the section of the tendon, extending beyond the border to include the capsule. *d* indicates the position taken after a moderate "setting back" ($1\frac{3}{4}$ "). The settings back are, according to von Graefe, as much as 3", which would carry the line *d* back to *d'*. In extreme cases he sets the tendon back from 4" to 6", which would be well toward *m*.

Whether the insertion is set back to *d* or to *d'* it is drawn into the

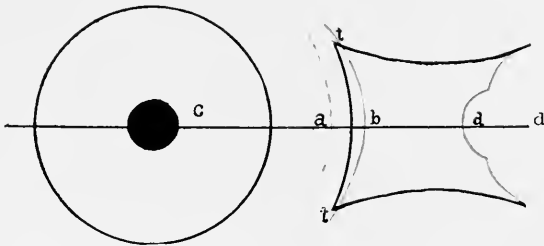

Fig. 144.—Diagrammatic Representation of von Graefe's Operation for Tenotomy. Scale, 3×1 . *c*, The cornea. *m*, The muscle. *t, t*, The tendon at its insertion.

folds of the capsule and becomes contracted in breadth and, of course, separated from the surface of the sclera.

Except for the line of division of the conjunctiva, this diagram will serve for the operations of Critchett, Lebreich, and others more recently suggested.]

With as little delay as possible the patient is to be placed in the examination chair where the tests by the phorometer and by prisms by abduction are to be made.

It is safe in moderate cases to carry the correction to 1° of exophoria, if the operation is for esophoria, and the abduction to 10° , for at the moment of the operation there is likely to be a greater abduction than will be found half an hour later, and with this record by the phorometer and prism it may be expected that within the next

twenty-four hours there will be still slight esophoria and a somewhat restricted abduction, conditions permitting the completion of the change in the relations of the visual lines by an operation of the same kind and as nearly as possible of the same extent on the opposite internus.

If the operation is on the externus for exophoria the record of the phorometer should be 0° , but the abduction may be reduced to 5° at the moment of the operation. In either case the conditions of abduction and of rotation are to be considered. If in the case of esophoria the abduction was, before the operation, greater in proportion to the standard of 8° than it should have been to correspond with the degree of esophoria, the abduction immediately after the operation may be very little above 10° ; and should it have been less in proportion, as, for example, abduction 2° , esophoria 3° , it will be prudent not to carry the immediate effect of the operation to an abduction as high as 10° . So, also, if there is little to be lost in rotation, the greatest care is to be observed not to restrict it unnecessarily. These exceptional cases should, in fact, rarely be treated for simple heterophoria, as they belong to the class of declinations.

Should the surgeon be so unfortunate as to find that by an error of judgment he has, in operating for esophoria, gained an exophoria of even a few degrees he should at once introduce, at the exact center of the free end of the tendon,¹ a very delicate suture, carrying it through the cut edge of the conjunctiva at the corneal side. Occasionally, but rarely, there is an exception to the rule that the overcorrection must be neutralized at once. For if in these exceptional cases the patient is permitted to wait an hour or less, the exophoria and the excessive abduction may disappear and the rotation may be found quite sufficient. The suture when used is to include as little as possible of the tissue of the tendon and of the conjunctiva. It is to be drawn with care until the exophoria has been overcome, as shown by the phorometer; then the knot is to be made fast.

This procedure, although sometimes demanded in the practice of the most skillful, is always unfortunate.

The old teaching, that after an operation on a rectus muscle a restraining suture should be introduced in the conjunctival wound,

¹ In all these details it is assumed that the operation is only for heterophoria, not for declination and heterophoria. Should it be desired to do tenotomy with a view to both conditions these principles are to be borne in mind, but modified according to the circumstances.

originated before the doctrine of heterophoria was known, and when an extensive wound of the conjunctiva needed to be united in order to avoid the large cicatrix. No such procedure is now required and no suture even as delicately introduced as has been directed is less than a misfortune.

The error of hoping that because an excess of correction, especially in exophoria, even when resulting in diplopia, is sometimes followed by single vision and even esophoria, the overcorrection may correct itself, is a serious one. These apparent corrections are accompanied by disabled rotation on the part of the eye operated on, and if the wound is permitted to heal, a perfect equilibrium can only with much difficulty be re-established.

One of the most serious errors in operations for heterophoria is the attempt to atone for an overcorrection of one muscle by an operation on another.

For example, if, as the result of a tenotomy of an internus of one eye an exophoria is induced, it is inexcusable to cut the externus in order to relax that muscle equally with the excess of relaxation of the other.

No overcorrection should be corrected by a new tenotomy.

TENDON CONTRACTION.

It may be desirable instead of doing a graduated tenotomy, thus relaxing a muscle, to contract the opponent. Thus, there would in most cases of exophoria result a less degree of restriction in the lateral rotations were we to contract the tendons of the interni rather than relax those of the externi. In other cases both graduated tenotomy and contractions may be desirable.

The operation for tendon contraction is commenced as is that for graduated tenotomy by making a transverse slit of half a millimeter in extent over the point of insertion of the tendon. (As the operation proceeds this slit is considerably extended, but if the tissues are not torn the slit will return to its original size after a few hours.)

Lifting the border of the conjunctiva nearest the cornea by the fine forceps (Fig. 135), a little pocket is made by the points of the scissors or by the lance probe (Fig. 141) extending under the conjunctiva more or less toward the cornea in proportion to the greater or less effect which it is proposed to induce. The pocket having been made, the forceps seize the central portion of the tendon and it is dissected from the eyeball as in the operation for tenotomy.

By means of the scissors or by that of the lance probe the tendon is to be freed from any attachment to the surrounding tissues, especially from any adhesions to the sclera.

The fine tendon crotchet (Fig. 137) now catches it at the center and a little behind the section and draws it forward, or, if the hook proves to be ineffectual to hold it during the next stages of the operation, the fine fixation forceps with catch may be used. (Fig. 142). The tendon is drawn forward through the little conjunctival opening, when one of the needles from a thread of silk armed at each end with a needle is passed through the central part from a half to a full millimeter or even more behind the cut extremity and then turned back, thus passing twice through the tendon. Bringing the needle forward until the two extremities of this thread are about equal in length, an assistant carries the small grooved director (Fig. 139¹) into the pocket already made, and one of the needles, passing by the side of this probe, which acts as a guide, is made to penetrate the conjunctiva at the extreme end of the pocket and the thread is drawn through. The other needle and its thread are managed in like manner, the second needle penetrating a little to one side of the first in order to allow between the two threads a little bridge of tissue. Now, the assistant holding the conjunctiva at the border of the wound by means of fine forceps, the surgeon draws upon the ends of the thread, forcing the cut end of the tendon into the little pocket, and when he has thus advanced it to his satisfaction he fastens the threads by tying them across the little bridge.

If the effect to be produced is considerable, two sutures may be introduced, one at each border of the tendon. Two small openings in the conjunctiva may be made, but by skillful manipulation, the one small opening at the center may serve for the introduction of both sutures.

No dressing or cover and no especial care is required beyond that needed for perfect cleanliness, and from the fourth to the sixth day the suture may be removed. The greatest danger in these cases arises from the use by the patient of a soiled handkerchief with which he rubs the eye. Against this danger the strictest injunctions are to be enforced.

¹ Devised by Dr. Charles W. Stevens.

SECTION XLVII.

Class IV.

HETEROTROPIA—STRABISMUS.

Adjustments of the Directing Muscles of the Eyes in Which the Two Visual Lines Are so Related that Binocular Vision is Habitually Absent.

Under normal conditions when an eye is directed to a given point, the point of fixation, the visual line connects this point of fixation and the macula, passing through the nodal point.

The direction of the visual line to the point of fixation is effected practically through the influence of the various muscles which are connected with the external portion of the eyeball. Muscles in the vicinity of the orbit may serve in some measure as auxiliaries to these directing muscles.

Under ordinary circumstances the two visual lines unite at the point of fixation, when binocular vision results.

There are limits to the field of ordinary binocular vision. For example, there is a limit to the ability of the directing muscles to bring both visual lines to a point of fixation very near to the eyes or far to either side or for a very high point.

The fact that normally adjusted eyes cannot fix for binocular vision every point in space does not mean that such eyes are not suited to binocular vision. But there is a varying range for the fixation of the eyes in unison for different persons.

It is only when, under normal conditions, there is an inability to thus direct the two eyes so that within the ordinary field of fixation the visual lines are not so directed as to meet at the point of regard that the relations of the visual lines are considered as anomalous.

It may then be said that when, within this ordinary range of fixation and under normal circumstances the visual lines of the two eyes do not meet at the given fixed point there is a condition known as *strabismus*.

The word strabismus is derived from the Greek word *στραβισμός*, a squinting. Other terms used to express the deviation of the eyes explain themselves. They are, *lucitas* (Lat.), squint; *vue louche* (Fr.), *distorio oculorum*, *visus obliquus*, *yeux a travers*, Scheil, etc.

In order to differentiate the strabismus which occurs with the normal rotations of the eyes from the forms which occur when the motile apparatus is disabled, it is customary to apply to the first class of cases the term "concomitant," and to the other "paralytic."

The term heterotropia is used as a part of a systematic classification. Inasmuch as the generally received idea of strabismus is that of the *apparent* turning of one eye away from the direction of its fellow, it is desirable to associate the idea of such a failure of the visual lines to cross at the point of fixation, even although no deviation is conspicuous to another person, with some term intended from the beginning to indicate such a deviation as will induce double vision, conscious or unconscious, independently of the appearance of the eyes.

The question of the appearance of turning of the eyes has in the literature of the subject been so prominently brought to the attention that it is not easy to divest the mind of the idea that with strabismus a noticeable turning of one eye is essential to the condition. Thus, Donders, in his discussions of strabismus,¹ gives many pages to the appearances which may be mistaken for strabismus. The extent of the angle a and the liability to mistake it for a diverging or converging strabismus occupies a very large space in the discussion.

As such slight appearances should not be reckoned as essential elements in the investigation of squinting and as the determination of the existence, kind, and degree of strabismus should be questions of a purely optical character, it is well, even beyond the necessity of suitable terms for classification of muscular anomalies, to employ a term to which false notions of the character of the condition discussed are not associated. Heterotropia is the term therefore here employed, not only a convenient term for classification, but a useful substitute for a word to which too vague meanings are attached.

Strabismus may exist when to all appearances the motor muscles of each eye are all, so far as contractile ability is concerned, in a normal state. The power of each muscle to rotate the eye to which it is attached may be complete, and each eye may turn in all ordinary directions, yet the visual axes may deviate to the extent that double vision may be present, and even to such a degree that the deviation of one of the eyes may be a conspicuous defect. On the other hand, strabismus occurs because one or more of the muscles of

¹ Anom. of Accom. and Refract., p. 244.

the eyes is disabled or because there is some mechanical obstruction to the free movement of one or both eyes in certain directions. It is evident that these two classes of conditions divide the cases of strabismus into two distinct classes. In the first class the motility of the eyes is complete, while in the other class the movements are more or less restricted. The first class has, since the writings of von Graefe on the subject of strabismus, been known, as already stated, under the designation of *concomitant strabismus*. In the present classification it is called *heterotropia*. The other form, usually known as *paralytic strabismus*, is here known as *colytopia*.

Each class of strabismic deviations is manifest under different forms.

Concomitant strabismus (heterotropia) has the forms of converging, diverging, sursumvergent, and deorsumvergent strabismus—or, according to the present classification, the class *heterotropia*, in which, if the visual line of one eye is fixed upon a given point within the ordinary range, the other visual line fails to meet it at the point of regard and is therefore directed to some other point, is divided into specific forms, as is the case with heterophoria described in Section XXXIII.

Buffon and others considered strabismus cases as divided into three degrees of intensity, according to what was believed to be the visual force of the retina. Thus, for Buffon, a difference of what he considered three-tenths of the force of the eyes constituted the first degree. This slight degree was called by this author *faux trait de la vue*. This slight form is probably the same as the “insufficiency of the interni” of von Graefe.

In the second degree the strabismus is more manifest and is the most frequent form.

The third degree is characterized by an entire deviation of the cornea behind the inner canthus.

In all forms of concomitant strabismus, with possible exceptions in anotropia and katotropia, there is diplopia which may or may not be consciously recognized by the subject of the defect. This diplopia can, however, in nearly all cases, be recognized by the strabismic person after repeated trials under proper circumstances. After recognition has been once accomplished, it is usually very easy to be observed, and requires only the volition of the squinting subject to present the double images to the consciousness.

In the condition in which it is not recognized there is a mental suppression of the image of the deviating eye which through long

habit becomes a fixed mental characteristic.¹ So complete may be the failure of the squinting eye to recognize its image that, even when the usually fixing eye is covered, it fails to locate the position of objects in the field of vision or even to acknowledge the sensation of vision to a degree sufficient to perceive even bright objects. Such extreme amblyopia may be present in eyes in which the ophthalmoscope fails to reveal the slightest indication of disease and, as we shall see as we advance, in eyes which are in fact in perfect physical health.

In its effects upon the physiognomy strabismus varies from a slight defect which may only add piquancy to the expression to a conspicuous deformity which is disagreeable or repugnant according to its form and degree. In the form known in the last century under the name of *strabismus horrible*, in which one eye deviated up and the other down, the expression is extremely repellant.

That such a defect should seriously compromise the prospects of the possessor is too evident. For not only is the physical effect unfavorable, but the mental and moral state of the strabismic person is often unfavorably influenced.

The effect of the deformity upon the health of the subject has been discussed elsewhere. That some strabismics who acquire the art of effectually suppressing the mental appreciation of the image of the squinting eye remain in good health until a somewhat advanced period in life does not invalidate the general rule that strabismus leads to early exhaustion of the powers of the patient, and that but a small proportion of strabismic persons reach the age known as middle life. Strabismic children are seen in much greater numbers than adults who squint, and the difference is only in part due to the results of corrective operations.

The effect on the quality of vision is also manifest. The visual sense of relief (projection) such as is obtained by binocular vision is largely absent.

The power of vision of the deviating eye is usually seriously impaired and sometimes practically lost, while the visual acuteness of the apparently healthy eye is generally reduced.

¹More properly, it is a failure to interpret the muscular actions which direct the position of the eye.

The eye not trained to interpret these muscular actions has no ability to determine the form or even the location of objects in the field of vision.

This view of the "amblyopia" of strabismus will be developed further on in this Section.

The effect upon the carriage and gait of the strabismic is sometimes notable, although in some cases no striking peculiarity is observed.

In the early stages of either form of heterotropia there may be a variation of the degree to which the defect is manifested, and in some instances the eyes appear normal at times and converging or diverging at other times. In general, squinting disappears during sleep or during the narcosis induced by chloroform or ether. In fact, even in very pronounced and persistent cases of strabismus the defect usually disappears entirely when the subject of the strabismus is under the influence of these anæsthetics.

In a proportion of cases the defect alternates between the two eyes. One eye will deviate a part of the time, to be succeeded in its strabismic position presently by the other. These alternations may occur from day to day or from minute to minute.

In those cases in which the deviation is confined mostly or wholly to one eye, it is not because the defect is confined to that eye, for that is common to the two eyes.¹

In all cases of concomitant squint, if circumstances render it more convenient for the squinting eye to become the eye for fixation, its fellow, which was before the "straight" eye, at once assumes the rôle of the strabismus.

Thus if the usually fixing eye is covered, the habitually deviating eye at once becomes the fixing eye and the other deviates in a direction and to an extent exactly corresponding to that of the lately deviating eye. If, for example, the fixing eye is emmetropic, or nearly so, placing before it a strong cylinder or a strong concave glass will often change it from the fixing to the deviating eye, providing that the adjustment of the glass reduces the power of vision below that of the deviating eye.

In a great majority of cases one eye is selected for habitual fixation, while the other is as habitually permitted to deviate. The

¹ At the time when I first urged this principle (see Archives Ophthalmology, 1889, etc.), it was accepted, so far as I am aware, by no one. It has now come to be an accepted doctrine with many, yet in the writings of those who have come to its acceptance its teachings are largely if not wholly ignored. For example, it is of little consequence that the view that the strabismic defect is divided between the two eyes is held, if all the treatment to the lateral muscles is bestowed upon one eye. Some authors who concede that strabismus is common to the two eyes insist on treating the defect by a setting back of the muscle toward which the eye deviates and advancing that from which it turns. Such treatment is, of course, absolutely inconsistent with the view that the affection is not confined to the squinting eye.

choice is usually made with regard to the comparative fitness of the eyes for distinct vision or with reference to the comparative facility of adjustment of the declination. Moreover, one eye may be so adjusted that with the minimum of nervous energy it is directed in the horizontal plane, while the other is so adjusted that under like circumstances it would be directed at an angle materially above or below that plane. Then, if there is no notable difference in the visual powers of the two eyes or in the difficulty of adjusting the meridians, it will be the eye best adjusted for fixing the objects within the field of regard, that is, it will be the eye adjusted to the horizontal plane which becomes the habitually fixing eye. It thus happens not very rarely, that an eye with nearly the normal refraction will be the deviating eye, while one with a pronounced astigmatism or other refractive defect will be habitually used in fixation. It is in such cases a question between clear vision and easy vision, and clearness may be sacrificed to ease. Even in such a case the direction of the vertical meridian of the squinting eye may be the essential reason for its deviation.

If in the case of the most usual forms of strabismus, the turning in or the rolling out of one of the eyes, each eye is caused to look far in and far out, it will be seen that it is difficult, if not impossible, to determine which has the fullest and easiest excursion. In fact, except where secondary changes have occurred, there is, even in extreme cases of deviation, no indication of a cause for it in any perceptible difference in these in and out excursions.

From the time that attention was especially directed to strabismus after the discovery of its surgical treatment by Strohmeyer and Dieffenbach, it has been observed that in a large part of the cases of strabismus the deviating eye does not turn in a simple and direct manner, but very often obliquely. The descriptions of Boyer¹ and his figures emphasize this observation. Later von Graefe announced as the result of close observation of great numbers of strabismic cases that it is the rule in converging concomitant strabismus that the deviating eye deviates not only in but also up. This later deviation he believed to be abolished when by a relaxation of the internus the eye no longer turned in.

Some form of vertical deviation of the squinting eye was recognized by von Graefe, who declared that "as a rule in high grades of converging strabis-

¹ "Recherches sur l'Operation du Strabisme." Lucien A. H. Boyer, 1842.

mus, there is, at the same time, a deviation upward of the cornea, so that, at its position in the inner angle, its upper part is brought under the superior lid.¹

Lawrence ("Diseases of the Eye," 1844) also thought that in converging strabismus the squinting eye might also be directed a little up or down.

Von Graefe believed that all this tendency of the eye to rise was abolished as soon as tenotomy of the internus permitted the eye to assume a more natural position.

Much later the author² of this work insisted that these vertical deviations were not sympathetic, but that the relation of the convergent strabismus to the vertical deviation was that of effect, and that the vertical deviation was the cause of the lateral one. In a later paper³ the principle was still further developed.

But not only is the deviation complex in the direction indicated by von Graefe, but in the opposite sense, for it not infrequently happens that the deviating eye is also turned downward as well as inward. This fact was known to observers who preceded von Graefe.

There is still another class of deviations to which attention was first called by myself. In this class there is, associated with the deviation in or out, a well-defined tendency to a deviation of both the squinting and the non-squinting eye in the vertical direction, either up or down, such deviation vertically when present is almost invariably up in converging, sometimes down in diverging squint.

This form of deviation is extremely common. It is easy in most cases of converging strabismus to observe this double deviation upward, and it is common to find one or other of the vertical forms of deviation with diverging strabismus. If a patient with converging strabismus looks at a distant object, and if the observer slips a visiting card before the fixing eye while he watches the other closely, he will, in most cases, see the deviating eye move, not only toward the temple, but downward as the eye fixes the distant object, while the sound eye will turn to the nose and will rise under the upper lid. Then, if the card is suddenly changed to the eye which has become the fixing eye, the other will resume its position by moving outward and also downward. A similar phenomenon, but with the movement of the excluded eye upward as it comes into fixation, is less frequent.

In cases of strabismus which are not of the alternating variety the deviating eye is usually a poor seeing eye. It is said to be am-

¹ Archiv für Ophthalmologie, Bd. ii, 2, 289.

² Stevens: "Anomalies of the Ocular Muscles," Archives of Ophthalmology, 1889.

³ Archives of Ophthalmology, 1891.

blyopic. This reduction of the visual power is often very considerable. In a pronounced case of habitual converging deviation of one eye in a youth of about 15 years, the visual ability of the deviating eye is usually less than $\frac{6}{15}$. There is, however, no fixed rule for the amount of reduction of vision. In some instances in which the deviation appears constant for a single eye, the vision of that eye remains good, while in other cases, otherwise apparently similar, vision appears to be almost abolished. That it is not abolished will appear later, but the subjects of the defect, if asked to tell whether they are able to see the flame of a gas jet at two feet while the "sound" eye is closed, will declare that no light is seen.

Others will suspect that the light is perceived, but in some remote and indefinite part of what should be the field of vision.

A series of trainings will teach these patients that they can not only perceive the light, but that they can locate it. The question has been much discussed whether the failure of sight is congenital or a result of the deviation. Each side of the question has had its earnest advocates.

While in some forms of strabismus there is a failure of the visual lines to meet at any fixed point of regard under all circumstances, in others there may occur a union of these lines at the point of regard under certain very limited circumstances. Thus in the converging form, if it is but slight, the visual lines may meet at the point of regard if this is very near to the eyes. In extreme cases of inward deviation this is not practicable even at a near point. In the vertical forms of strabismus also there may be a union of the lines of vision at a near point, although at all points more remote there is a separation. In respect to the faculty of convergence, it is an interesting fact that while in a considerable proportion of cases in which the deviation is markedly in, and all the optical phenomena are distinctly those of converging strabismus, when a very near point is reached the visual lines diverge, and the extreme point of convergence of the optic axes is more remote from the eyes than the normal or usual converging point of non-strabismic eyes. On the other hand, there is a certain proportion of those cases where the squint is of a marked diverging character, in which the ability, under the impulse of a momentary effort at convergence, the visual lines can be forced to meet at a point very near to the eyes.

Thus it would appear that, at least in these cases, the strabismus is not, as some have characterized it, a manifestation of excess of

positive or negative convergence. It has been said above that in strabismus there is always diplopia.¹ This is true of all cases in which there is vision in both eyes, whether the person subject to the defect is conscious of it or not. The custom established from the earliest years of life of disregarding the impressions made upon the squinting eye render the fact no less real that impressions are received by the retina of that eye and are duly transmitted to the nervous centers at which such impressions are perceived. That these impressions may in some instances convey no clear idea of the object seen is also true. In most cases, by some practice, the double images are perceived. In those in which the perception of the image of the squinting eye simultaneously with the other eye is extremely difficult, if not impossible, the squint is notably of the complicated form, that is, it is not only in or out, but markedly up or down. Notwithstanding the difficulties in recognizing diplopia, it is to the presence of these double images that we must resort for the most accurate information respecting the character and degree of strabismus.

As a rule the location of these images is an accurate index to the direction of the squint. Yet, as will be seen as we proceed, the location of the images may be entirely inconsistent with the rule.

If the deviation of the strabismic eye is in, toward the other eye, the double images are *homonymous*, that is, each image is seen on the same side as the eye which perceives it. The right image is seen by the right eye, the left by the left eye. If the deviating eye turns away from its fellow, the diplopia is *heteronymous*. The images are crossed. That seen by the right eye is on the left side and that seen by the left eye is at the right.

If the optic axis of the deviating eye turns above that of the other, the image seen by the upward deviating eye is directed below that of the fixing eye. If the axis is directed below that of the fixing eye, its image is higher than the eye which is engaged in fixation.

A moment's consideration of the optical principles involved in these various positions of the eyes and their images will render the reasons clear.

Let it be first supposed that the images of objects fall upon the retina of a single eye. The objects are first supposed to be at the same height, one at the right, the other at the left of a point at which

¹ Of course, this proposition assumes that visual faculty is present in both eyes. There are cases of very marked strabismus in which one eye is entirely blind. Of course, in such cases there can be no binocular diplopia.

the eye is fixed. Let a (Fig. 145) be the point of fixation and b and c the two objects in the horizontal plane. The image of b , the left hand image, is perceived at b' , which is at the right of the macula lutea, and the image of c , the right hand object, is perceived at the point of c' , which is at the left of the macula. The image of c , the right hand object, is perceived by a point of the retina at the left of the point where the left hand object is perceived. Hence, if an image is impressed at a point in the retina which is at the right of the point at which another image is impressed, that which forms its impression at the right is mentally attributed to the left, and the object is, in the judgment of the person to whom the eye belongs, located at the left of the other object.

According to the law of corresponding points, the point c' in one retina will be removed in the horizontal meridian of the retina as

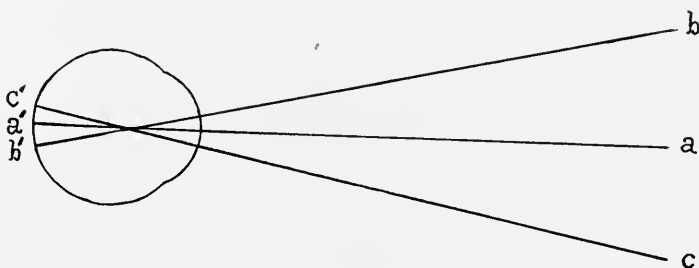

Fig. 145.

far to the left as its corresponding point in the other retina. Accordingly, if the point c' in one eye is at the temporal side of the macula, the point c' in the other eye will be at the nasal side of the macula, and they will be equally removed. A corresponding rule would hold if the images of both objects were perceived at the nasal or temporal side of the retinas. If the distance bc is represented by the distance $b'c'$ in the retina, then if the images were received upon the two retinas, the distances of b' and c' from the macula on the temporal side of one eye would equal the distance of b' and c' from the macula on the nasal side of the other. Applying this principle let a , Fig. 146, be an object seen by both eyes. If one eye, the right, fixes the object, the image will be perceived at the macula m . Suppose the other eye, the left, to deviate inward. Then the image of a will not be produced at m , but at n , which is at the right of the macula. Ac-

According to the principle already shown the image of a perceived at the retina at n will be mentally located, not at the right, but far at the left of a , at a' .

Thus it appears that although a projection of the optical axes inward would result in a crossing of these imaginary lines the position of the images is in fact not crossed and the image seen by the deviating eye never even reaches to the image seen by the fixing eye, but remains on the same side as the deviating eye. That is, the images are seen *homonymously* ($\delta\mu\acute{o}\varsigma$, common; $\delta\upsilon\nu\mu\alpha$ name, the same side).

Quite different is it when the deviation of the strabismic eye is divergent, for then, although the optic axes point away from each

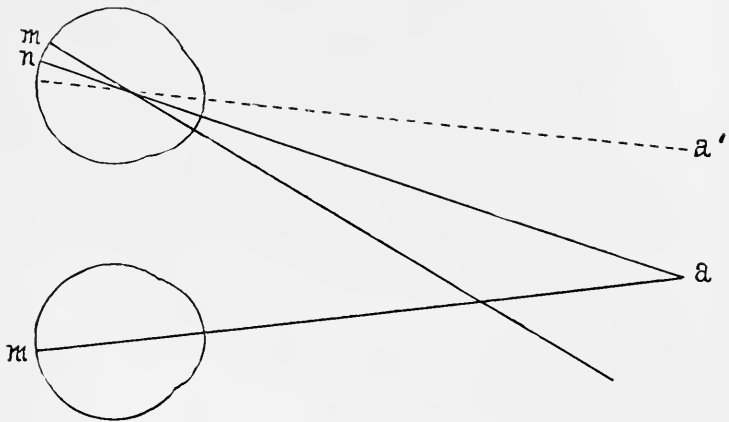

Fig. 146.

other, the images are crossed and are said to be seen heteronymously ($\epsilon\tau\epsilon\rho\omicron\varsigma$, different).

Bearing in mind the phenomena shown in Fig. 145, it will be seen that if the right eye is in fixation while the left deviates outwardly, the impression from the object a will fall, in the left eye, at a point of the retina situated at the temporal side of the macula lutea. It will be seen then, not at the left hand side, but at the right of the image of the eye in fixation, and the distance will be, as in the figures measured by the distance of the point c' from the macula of the left eye.

We may also apply the principle shown in Fig. 145 to the loca-

tion of images in cases of deviation of the images in a vertical direction. Let the diagram (Fig. 145) represent a section of the eye in a vertical direction, and let the objects a , c be no longer in the horizontal, but in a vertical plane with each other—and suppose a is in the primary plane while b is above this plane and c below it. Then will the impression of a be received at the macula, that of b at a point in the retina situated below the macula, and that of c at a point above the macula.

Returning to the appearances of an object as seen by the two eyes when the axis of one deviates above or below the other, suppose that the image a is seen by the fixing right eye, the image being perceived at the macula. and that the object \hat{a} is seen by the left eye, the optic axis of which deviates above that of the right. Then will the impression of the object a fall, not upon the macula of the left eye, but above it. The image seen by the left eye then will be seen not above that of the fixed eye as might be imagined, but below it as is shown at c , c' (Fig. 145). On the same principle, if the optic axis of the left eye should deviate below the line of the optic axis of the fixing right eye, the image will be seen above as at b , b' .

It need hardly be added that if the deviations are in compound directions, as, for example, upward and outward or downward and inward, the position of the images will be influenced by each of the elements of the compound deviation.

Although the principles which have just been mentioned govern in the great majority of cases and are the rule, there are certain anomalous positions of the images which demand attention and to which false interpretations have sometimes been given.

It sometimes happens that a person having an actual diverging strabismus will, if caused to recognize his diplopia, insist that he sees the images homonymously, and, on the other hand, while a converging strabismus is actually present, the patient will describe the positions of the images as crossed, as though the phenomena arose from a diverging squint. These phenomena appear perplexing, especially when the axes of the two eyes have not the appearance of great divergence or convergence. The anomaly only presents itself in cases in which there is not only the lateral, but a distinct vertical deviation, as well as an extreme declination. and as a general rule, to which there are some exceptions, is observed after an operation for the correction of the lateral deviation, in which the difference of height of the images or the extreme declination has been ignored.

A second anomaly in the position of the images is the appearance of more than one image in one of the eyes. Then it may happen that while the usually fixing eye will see the image normally, the deviating eye will see two and, in rare cases, even three images of the object. This class of cases of monocular diplopia has no relation to the monocular multiplicity of images which may be induced by notable errors of refraction, the doubling or tripling of images in cases of astigmatism or the multiple images of presbyopia. The multiple images under consideration are independent of any fault of refraction or accommodation, and may occur in perfectly emmetropic eyes.

In every case in which multiple images of this class occur there is a vertical as well as a horizontal deviation of the eyes. In the majority of cases also, if not in all cases, the strabismus is to a certain extent alternative.

In explanation of the phenomena it has been said of the first that the macula lutea is located in a false position, or that, from long custom, a new point has assumed the function of the macula; of the other phenomenon that, while the original macula retains its functions, a second or even a third point has become developed as a new center for vision. Both these hypotheses are alike unsupported by any facts which can be learned by any physical examinations or by any evidence of either a physiological or psychological character. Both are assumptions to the establishment of which no attempt appears to have been made to reconcile them to any doctrine of mental or physical science.

Without doubt these eyes are anatomically normal. The conditions are not metamorphoses which arise from disease. The most careful scrutiny of my own cases has failed to detect the slightest defect in the fundus of the eyes of those subject to either of the anomalies. And this has been the testimony of others.

Our inquiry into the character of the cases and into the visual phenomena will, I think, classify each of these anomalous conditions as the normal manifestations of abnormal physical relations.

In order to understand the reasons for these conditions it is necessary to recall the theory of spatial sight—ideas with reference to the location of visual impression, and their reciprocal relations of direction and distance. The phenomena of vision teach that these spatial ideas have for their basis the energy which is applied to the motor impulses of the eyes. Relative distances and directions in the

field of vision are the expressions of the motion required to pass the retinal space separating the point at which two impressions are formed. The ideas then of relative distances become intimately associated with certain motor impulses. If the two eyes are in equilibrium, if they can move in such a manner that the image of an object may be perceived at corresponding points of the two eyes, there is binocular vision. But if, as a result of strabismus, especially of an alternating character, a new faculty of estimating spatial relations has been acquired, an image may be "projected" in a direction which will be essentially different from the usual and normal projection, and when, by introducing at the same moment the estimation formed by the normal movements and that formed by the acquired experience two different space ideas are presented to the mind simultaneously, the mental projection corresponds with the two forms of experience.

An eye adjusted so that it is able at times to assume the faculty of fixation and ready at other times to abandon it to the other eye, maintains on the one hand an ability to estimate correctly distances and directions by the position of the impression on the retina relatively to the position of the macula. It may also acquire during its exclusion from fixation an ability to make somewhat similar estimates, starting from fixed points outside the macula, but which in the position of deviation may occupy positions corresponding to those of the macula of the fixing eye. Under certain circumstances, when the images of the two eyes are brought strongly to the consciousness, both these estimates are taken into account, and the image of the eye which has acquired the new faculty is consequently located in two positions. If the eye which has but one image is excluded from the act of vision, the second image of the eye having monocular diplopia disappears.

The phenomenon is analogous to that in the familiar experiment of crossing two fingers of one hand and passing between the fingers thus crossed a small body like a playing marble, when the object is felt like two bodies, the spatial position of each being attributed to the point from which the sensation is usually experienced.

The following is a typical case of monocular diplopia:—

Bessie —, aged 13 (1882), emmetropia. Under influence of atropine $H=\frac{1}{30}$. Is weak, nervous and has headache. Moderately marked converging strabismus with vertical diplopia (right hypertropia 15°). The converging squint alternates between the two eyes.

If a red glass is placed before the right eye three images are seen, two of which are red and are nearly horizontal with each other, the other white,

which is much above the red images. If a prism of 1° with its base down is now placed before the right eye, thus only partly correcting the height of the images, the white is between the red images, but still somewhat above them.

Tenotomies of the superior rectus, right eye, and of the internus of each eye corrected the strabismus so that, while the patient gazed at a distant object directly in front of her, a card slipped alternately before each eye gave rise to no deviation in exclusion and all the movements of the eyes were free and normal.

Still with the red glass before one eye, there remained a second image faintly seen at one side, but no longer a third, as before. Thus, the images apprehended at the macula of the two eyes were perfectly blended, but there remained the second image of the right eye. If, by means of a strong prism placed with its base up or down before either eye so as to cause the images seen at the macula to separate, the right eye again saw two images and the left one. *But if the left eye was covered, only a single image was seen by the right eye.* After some months the supernumerary image of the right eye disappeared.

The entire disappearance of the second image of the right eye (which appeared before the correction of the strabismus as well as after it) when the left eye was excluded from vision, shows that the second image was entirely relative to the position of the image of the left eye. In fact, it was an unconscious conclusion that the object should appear in a certain direction, since a certain movement of the eye would be required to place the point of the retina at which the visual sensation was felt in correspondence with the macula of the left eye.

And here we may return to the question of the amblyopia in strabismus, of which mention has already been made at page 361. The same principles prevail, but in the case of entire abandonment of efforts to direct one eye, especially if the abandonment occurs at a very early period, the consciousness has taken no account of the movements of the eye, and the relations between space and motion, so far as they have ever existed by native and inherent intuition or by very early acquired experience, have been so completely lost that the mind forms no conception of form or space from their movements. This extreme condition, although rare, is occasionally met with.¹

If occasion demands that the movements of the amblyopic eye should be observed and estimated, the experience gained by the other eye is brought into service and the amblyopic eye soon acquires the

¹ This discussion should be read in connection with the section on "Visual Perception of Space," page 124.

faculty of estimating form and space. A most striking example illustrating this statement is found in the remarkable case reported¹ by Dr. Walter B. Johnson. In this case the eyes of the patient had been examined by Dr. Johnson a few days previous to an injury when it was found that the vision of the right eye was $\frac{20}{15}$, and of the left, only ability to count fingers at six inches. No glass improved vision. Ten days later, the right eye was destroyed by an accident. Six months later the amblyopic left eye had $\frac{20}{15}$ vision without glasses.

Certain authors have assumed that the amblyopia of squint is congenital, and that it is a predisposing element of the latter.

In adopting this assumption one must take the ground that the visual sense of space is wholly and always a connate possession of the visual organs—that it is an inborn characteristic inseparable from healthful eyes. Those who have assumed this dogma have perhaps neglected to examine the problem of spatial discrimination by the eyes and its development.

In the amblyopic eye, from strabismus, we have all the physical possibilities of space perception without the mental process of discrimination. So completely may the mental process be in abeyance that no borders of objects, even very conspicuous ones, may be recognized. Such an eye, as in the case of Dr. Johnson, fails to recognize any object and in many instances even the location of the illuminating flame of a candle in a darkened room, yet it has suffered from no disease and is anatomically fully developed. It is not a weak eye, or an imperfect one. It is undoubtedly the fact that in such a case as has been mentioned, the local signs of space ideation have always been present, but without the mental interpretations of those signs they are not operative, and they remain a chaos of light impressions destitute of significance.

In order to properly appreciate the absence of visual sense in amblyopia *ex anopsia* one must divest himself of the idea so commonly entertained, that the visual sense is simply the consciousness of a picture painted on the retina. As a matter of fact the consciousness of the form and position of objects derived from the visual sense is formed by the expenditure of force in the movements of the eye or in the recognition of the force and direction of the force which would be necessary to effect the required movements of the eye in order to follow the boundaries of the object seen or to pass from one object

¹“Transactions of the American Ophthalmological Society,” 1893.

to another. These mental measurements are possible only as the result of experience, and the eye, between which and the mind no system of precise estimation of such movements has been established, is to all intents a blind eye, notwithstanding the fact that its parts are in perfect health and the rods and cones of its retina are as susceptible to the influence of light waves as the eye which is able to appreciate all the stimuli of light. In this respect we make a somewhat rude comparison with another form of muscular movement, with the condition that we must reverse the course of the influence of cause and effect.

One who may be a facile penman, able not only to write but to write with speed and elegance, suddenly loses the ability to use the right hand. This person can in the mind form images of letters and words, and his remaining left hand is in all respects physically capable of performing all the movements of writing, yet he finds that he is now unable even to form his own signature except perhaps in ungraceful and unaccustomed characters.

In what lies the disability of this left hand to form the characters which were so easily formed by the right hand?

It lies in the absence of experimental relations between the mind and the muscles of that hand. A week of practice may render this uneducated hand facile with the pen.

In this case we have the absence of the ability on the part of the mind to direct the movements of the hand through absence of experience in sending messages to the organ; in the other we have the absence of ability to interpret the movements by reason of inexperience in such interpretations, a fact which leads to inability to direct the movements.

Even the most amblyopic eyes may attain to at least an approximate estimation of form and space even although the strabismus is uncorrected. The following case will serve as an illustration of this:—

Mr. V., aged 59, consulted me in 1893 on account of a moderate diverging strabismus. It was evident that the deviating eye turned upward more than outward. The strabismic eye was totally amblyopic. There was a vague perception of light, but no sense of form or space. A lighted candle held within four feet of the eye when the other was covered gave an impression of a strong, yellowish, diffused light, but suggested no form of a flame nor direction from which the light came. The eye was to all appearances, when examined by the

ophthalmoscope, perfectly healthy, and its refraction nearly emmetropic. I determined to educate the eye to the perception of space. Commencing by blindfolding the well eye and allowing the patient to touch the candlestick, I succeeded after two days in obtaining a vague recognition of the indistinct form of the candle flame, which appeared like a large ball of light in some undetermined part of the visual field, generally far to one side, but never in its proper location. After several days more I was able to obtain rather unsatisfactory tests with prisms, and before two weeks had passed the patient could make somewhat unsatisfactory tests with the phorometer, the image of the candle flame of the deviating eye appearing nearly as distinct as the other, but changing in position from one relation to another with the best image.

The patient left with the promise to return for more tests and finally for treatment, but I did not see him again.

When it happens that by any means the non-squinting eye is rendered useless or its usefulness is materially reduced, the habitually squinting eye may assume the usual functions of vision and the other may become amblyopic.¹

The means of determining the presence of strabismus, and its direction and extent include:—

The general appearance of marked deviation of one eye.

The tests by deviation in exclusion.

The tests by diplopia and the use of prisms, and the tests of the various rotations of the eyes.

In marked cases of lateral strabismus the deflection of one eye is so apparent to an observer that a single glance is sufficient to establish the general fact of a deviation, and when it is in or out the general direction, but in cases of vertical strabismus which, quite contrary to the statements of some well-known text-books which state that it is rare, is, in fact, quite common, the deviation is not so readily detected, and it is not rare that in cases of vertical strabismus in which single vision with the two eyes is quite out of the question, not only is the defect overlooked by the friends of the subject of it, but even ophthalmologists not rarely fail to observe the fact of its existence.

In cases of lateral deviation also in which the strabismic character of the direction of the eyes is plainly seen, yet when there is

¹ See case reported by Dr. D. W. Hunter, American Ophthalmological Society, 1905.

associated with it, as there nearly always is, a deviation in the vertical direction, this latter deflection is almost invariably overlooked. Much has been said of the angle a or *alpha* in connection with the diagnosis of strabismus, yet this angle can have no important place in the question of squint, for in all cases of so slight deviation that there might be any possibility of a question between the angle a or *alpha* and a strabismus, the distinction could be instantly made by the test of deviation in exclusion, or if by any chance a doubt could still remain, a single test by the phorometer would determine the question.

Reference has therefore been made to this supposed question of diagnosis only to assure the student of the subject that the angle a is a subject having no relation to the question of the presence or absence of strabismus.

DEVIATION IN EXCLUSION.

If the subject of a strabismus is directed to fix his gaze on an object, preferably the flame of a candle, situated in the median and primary planes and at a distance of about twenty feet, the examiner will be able to detect any considerable deviation of the visual axes by passing a visiting card from in front of one eye to the front of the other. (The use of the hand for such a purpose is far too clumsy and could only serve in cases of very marked turnings.)

If the eyes are closely observed as the patient looks at the candle, one of the eyes may appear to deviate. The examiner slips his card suddenly in front of the apparently fixing eye, when, if the other has in reality not been in fixation, it may be seen to move in order to bring the optic axis in line with the object. If, however, the movement is not observed, the other eye may be treated in the same manner, or several trials may be made on the same eye.

If the card is passed in front of one eye and then in front of the other alternately there may be observed a decided movement of adjustment of the eye last released from exclusion in order to bring it into fixation. This deviation from alternate exclusion, one eye being covered while the other is free, does not prove a strabismic condition, for it may happen that with a deviation which is plainly perceptible there may exist the power and the habit of binocular vision. In the first case, however, when with both eyes free, if one is suddenly excluded, the other must move in order to fix the object, there was no union of the images of the two eyes, and there existed

an actual strabismic deviation, even if the movement was extremely slight.

If the deviation is detected, its direction in or out, up or down is to be carefully observed. It may be approximately measured by neutralizing the movement by prisms. (In very high grades of deviations measurement in this manner is either unsatisfactory or impractical.)

Observing the direction, a prism is held in front of one of the eyes while the card is pressed alternately before each, and the prism, if not strong enough to neutralize the movement, is gradually increased until the eyes remain fixed as the card is moved backward and forward. If very strong prismatic effect is required, it may, of course, be divided between the two eyes. If the direction of the squint is compound, the position of the prism may be adjusted to it or, better still, one prism may be used to neutralize the lateral and another the vertical deviation.

Even a degree of deviation of a less extent than is readily seen by an observer may cause diplopia, especially if the deviation is vertical. In such a case, if the patient himself is able to detect a slight apparent movement of the object and its direction the prism may be used as before until the patient can no longer detect the movement. This slight movement, which is not observed by the examiner, can be detected by the patient, and its measurement by a prism has been called the *parallax test* by Dr. Alexander Duane. As a rule it is not necessary to divide the test, and a record of *deviation in exclusion* should include all that can be learned by this method.

TESTS BY DIPLOPIA.

A much more important and, when practical, a much more exact class of testings of strabismus is that depending upon the double images. In all cases of concomitant strabismus in which the visual faculty exists in both eyes there exists also diplopia. That a patient declares that he does not see double, and that he persists in the declaration in spite of the most ingenious methods of wringing the confession from him, does not alter the case. There is double vision nevertheless.

The fact that, as we shall see further on, the squinting eye has squinted up even long before it was observed to squint in or out, means that as an almost invariable rule one of the eyes in strabismus has deviated from a very early period of life. It is easy then to under-

stand that the image which from earliest experience has been neglected is not always easy to present to the consciousness.

Notwithstanding the difficulty that sometimes presents itself in inducing the patient to realize the presence and position of the second image, no attempt should be made to make a *final* correction of strabismus until the two images are located. Contemporary literature shows that there is a very prevalent belief that no measurement beyond the linear can or need be made. This is a radical error and no correction worthy the name of a correction of strabismus can be made which does not have for its basis the position of the double images and the leanings of those images.

The proportion of cases in which, with sufficient patience and skill, the diplopia cannot be made out before any step is taken toward correction is small, but if the examiner is unwilling to sacrifice time and labor to the investigation he may be often disappointed.

It is not an infrequent experience that a strabismic patient is required to make long continued trials, day after day, for a whole week, and in some instances for even a longer period of time, for the single purpose of learning the position of the double images. If the patient insists that he does not see double and is inclined to become angry when kindly assured that nevertheless he does, he is to be encouraged and to be told how and where to look for the second image. The lesson should be practiced in a darkened room and the object should be a lighted candle. In order to give contrasting colors to the images a red glass should be used, generally before the fixing eye. By using strong prisms, alternately before the two eyes and changing in various manners, the lost image may be moved to one or other side or up or down, and of each change of position the patient should be informed and his attention directed to the point in space at which the image is supposed to appear.

When once the second image has been brought to the consciousness of the patient there is rarely any difficulty in later trials. The images are usually then located quickly.

So far as this examination is concerned the cases of strabismus may be divided into two very general but not well-defined classes—the moderate cases and the extreme cases. In moderate cases the presence of diplopia can in most instances be made out and utilized. In cases of extreme deviation the difficulties are sometimes so great and the time required to demonstrate the diplopia so considerable that some means of simplifying the process is required. Fortunately by the

more recent revelations of the rotations in strabismus, as shown by the tropometer, very important advances toward the adjustments of the visual lines may be made before the diplopia is revealed to the patient, and then when the images are more nearly approximated and the eye has learned to make more accurate estimates of its own relative position, the diplopia tests can be brought into practical application.

In the moderate cases, as soon as the double images are discovered their relative positions are to be noted. If the usually fixing eye has before it a red glass it is easy to determine the image belonging to each eye and its position. If the images do not appear in the same horizontal plane it should be the first object of the examiner to learn the strength of a prism which will bring both to the same level. Suppose that the right eye has before it the red glass and the patient sees the yellow flame to the left and below the red flame. There is homonymous and vertical diplopia—left hyperesotropia. Taking a prism from the box of trial glasses, the examiner places it with its base down before the left eye, or up before the right eye, and learns whether the glass is sufficient to correct the difference of level or if it overcorrects it. When the proper glass is found to bring the two images to the same horizontal plane, the degree of this prism measures in prism degrees, or diopters, the degree of left hypertropia. It is then required in a similar manner to learn the prism diopters demanded to bring the two images to a vertical line. If the deviation is considerable, prismatic corrections may be divided by placing glasses before each eye. As in the other case, the prism strength required to bring the images to the same vertical line measures the diopters of esotropia. If, in the first instance, the prism was 12° and in the second 20° , the record is, left hypertropia, 12° ; esotropia, 20° . If now these prismatic effects are combined, the two images usually unite as one. In higher degrees of deviation the measurements are less uniform, and the prisms which measure the different elements of deviation do not always unite the images.

In low degrees of deviation and with a readiness to locate the images, the phorometer is by far the most convenient and accurate means for estimating the various displacements of the images.

So far as possible the various tests which were suggested for heterophoria should be called into requisition in heterotropia.

In the class of cases which will be considered farther on and which are known as anotropia or katotropia, the images may vary

materially in their deviation, according to the eye which is used for fixation.

In a case of anotropia, for example, if a red glass is placed before the left eye, the right eye may and (in cases where there is no great difference in refraction or visual power and in which there is no great lateral deviation of one eye) usually does become the fixing eye. In this case the left eye, that covered by the red glass, may deviate above the other; but if the red glass is changed and the left eye becomes the fixing eye, the right eye then deviates above the other. Thus there may be right or left hypertropia, depending upon the eye which is in fixation.

The examination of the various rotations by the tropometer will generally bring to light facts of the greatest importance, not only in regard to the nature of the deviations, but to their ætiology.

In converging strabismus it is generally the case that the nasal rotations are rather excessive and that the temporal rotations are rather less than usual. They are usually very nearly or quite equal for the two eyes. But it is in the vertical rotations that the most notable departure from the ordinary standards is found. In some of the cases of converging strabismus the rotations of both eyes in the upward direction are astonishingly great, and in nearly all cases they are unequal. It is not unusual to see the eyes of a squinter with converging displacement rotate one of the eyes as high as 50° or 52° of arc, or nearly 20° above the highest rotation in the best adjustments. In other cases, much more rare, the upward rotation is extremely restricted. These latter cases are much more rare in converging than in diverging squint.

In the case of the extravagantly high rotations there is generally a corresponding failure to rotate downward, although, where there is a considerable difference in the degree of upward rotation of the two eyes, there is sometimes a disproportionate rotation down, so that, with a rotation up of 50° or an excess of more than 15° , there may be a rotation down of 40° or a deficiency of only 10° .

The stereoscope has been largely employed, or at least recommended, for the purpose of ascertaining the ability to see singly. It has, however, when used, been employed principally to prove the presence of single vision after squint operations.

That a mildly strabismic subject should at a near point be able, when using 24° of prism (the usual strength of the prisms of the Brewster stereoscope) and a magnifying glass, to combine, or think

that he combines, momentarily, the figures on the stereoscopic card is no proof, indeed no suggestion that he sees singly except under such abnormal circumstances. Even cases in the category characterized by von Graefe as cases of "incompatibility to single vision," may unite these figures.

As a matter of fact, while the stereoscope is an instrument of value in certain experiments of physiological optics, it has absolutely no value in the determination of the question of habitual binocular vision or habitual diplopia.

A test sometimes employed for the determination of the presence or absence of binocular vision is that of Hering, which is based upon the principle that the visual perception of depth depends upon binocular vision, and that without it the comparative distance of objects can only be judged by their surroundings. This test is the *experiment with falling bodies*. If a person having binocular vision looks through a long tube, fixing the gaze upon a slender thread stretched in front of it, and if then little balls, glass beads, and like objects are let fall now beyond the thread and now nearer the tube than the thread, the person experimented with will instantly detect whether the body falls in front of the thread or behind it. If, on the other hand, the person examined has not binocular vision he can only tell by accident whether the ball falls less or more remote than the thread.

While the principle upon which this test is based is in general correct, it is not by any means always so, and it is far from being a practical test of binocular vision.

The perimeter has also been suggested as a means of measuring the deviations of squint. The method of its use will be described under the discussion of paralytic strabismus. As a means of determining the deviations of concomitant strabismus it has little if any value.

When all the tests of diplopia and the relative displacements of the images have been made at a distance it is well to make somewhat similar tests for binocular vision or for the deviation of the optic axes at near points. The tests for deviation in exclusion and for diplopia already mentioned have been supposed to be made at the distance of not less than twenty feet. For near tests the distance may be selected according to circumstances within the range of from a few inches to one or two feet in advance of the eyes. These tests at near points should always be regarded simply as checks upon the

tests at a distance. They may call attention to certain conditions which might otherwise be overlooked. Tests at near points should never be made the basis of treatment, nor are such tests to be taken into consideration as indicating directly the displacements of the visual lines.

After the patient has been trained in the recognition of diplopia, a bright point—for instance, a small opening in a dark-colored card which is held between the eyes of the patient and a strong light—will in general serve the purpose of a test object at a near point.

SECTION XLV.

The specific divisions of heterotropia are:—

1. *Esotropia*.—A deviation of the visual lines inward.
2. *Exotropia*.—A deviation of the visual lines outward.
3. *Hypertropia*.—A deviation of one of the visual lines above the other.

The term hypertropia does not imply that the visual line which rises above the other is too high. Both may be too low.

The excess of upward or downward direction of the visual lines is designated by other terms.

4. *Hyperesotropia* and *hyperexotropia* are compound terms applied to the conditions in which lateral and vertical deviations are combined.

ESOTROPIA.

That form of strabismus which is principally characterized by excessive convergence of the eyes is, to appearances, by far the most common. When, however, the less conspicuous cases of exophoria are taken into consideration the proportion of each is about the same.

It commences in the great majority of cases in the early period of childhood. It is first observed by the parents of the child at an age varying from two years to six years. Although in a less number of cases there is observed periodical squint, which is probably more than the usual vague infantile wandering of the eyes, even during the first year.

In many of the cases the mother associates the origin of the squint with some critical event, such as an infantile disease; measles and whooping-cough being the troubles to which the defect is

most commonly attributed. Accidents, such as falling downstairs, a slight blow about the head, and fright are often assigned as causes.

In general, the deviation is at first only periodical, occurring especially when the child's attention is specially exerted or when looking to one side. After its first appearance it sometimes disappears to return again after a few days or weeks. At length the defect seems to settle in one eye. If the eyes are unlike in refraction the eye most nearly emmetropic may remain the fixing eye. If there is a high degree of declination, especially a negative declination of one eye and a moderate declination of the other, it is likely to be the eye with least declination that habitually fixes; or if one eye is nearly emmetropic, the other myopic, the emmetropic or slightly hyperopic eye may be employed for fixation at a distance, while the myopic eye may be used for fixing at near points, as in reading.

If one eye habitually deviates, that eye loses to a greater or less extent its keenness of visual sense. It becomes progressively more and more amblyopic in nearly all cases, the loss of visual acuity extending to such a degree in some instances that the forms of objects are not made out. The condition is generally known in ophthalmic literature under the designation of *amblyopia ex anopsia*.

A converging strabismus for distance may become a divergent squint when the object seen is at the distance of reading, a fact of great importance when the causes of the deviations are under consideration.

A subject of slight esotropia who is not myopic will sometimes hold the book or the article upon which he works quite near to the eyes in order to take advantage of the crossing of the visual lines at the near point, preferring to exercise the accommodation to an extreme degree rather than suffer the confusion of the double images which results if the work is held at the usual distance. This peculiarity I have found in a few persons who, as the result of hyperphoria, squint in at near points only, and who, although normally hyperopic to a high degree and also presbyopic, are accustomed to bring the paper which they wish to examine, as, for example, a check or a short note, close to the eyes to read it. Two of these persons, one of whom is a physician, have normal hypermetropia of 3.00 D and each is over 60 years of age. With one eye only neither of these people sees at near points differently from others with similar refraction and presbyopia.

The power of the lateral excursions of the two eyes in converg-

ing strabismus is very nearly uniform for each direction. In many cases the nasal rotation is considerably increased, so that the border of the cornea is carried well into the inner canthus or is even buried behind the caruncle.

On the other hand the temporal rotations are often reduced in about the same proportion. Measured by the tropometer the nasal rotation ranges from 55° to 60° or 65° , while the nasal rotation in well-balanced eyes is found to be about 50° .

To the temporal side the rotations are about 35° to 40° , which is less than in well-balanced eyes.

The upward rotations in esotropia are, in a very large proportion of cases, extreme, ranging from 50° to 55° while the normal



Fig. 147.

Fig. 148.

Fig. 149.

Two Cases of Convergent Strabismus and One of Paralysis.

rotation up is 33° , or a little more. The downward rotation is restricted, but to a less extent than the upward is increased. And the upward rotations are generally nearly equal.

Esotropia, although in appearance a direct turning in of the deviating eye, is rarely a simple condition. There is nearly always a certain extent of deviation of one of the eyes in the vertical direction. As it will be seen when the aetiology of strabismus is under consideration, there is, in fact, always a maladjustment of one or both eyes in the vertical direction in converging strabismus, but it is the purpose here to call attention only to the inequality of vertical tensions of the directing muscles which is very common in all lateral forms of squints.

If the patient is able to locate the double images it will generally be easy to detect the difference in height of the images when a red glass is placed in front of one eye. In esotropia the diplopia is, according to the rule, homonymous, and the prism, with its base out, which either brings one of the images directly in the vertical line with the other or which unites the images, is the measure of the deflection—the degree of esotropia. If hypertropia is associated with esotropia, as it usually is, the prism with its base down before the eye, with the lower image, completes the measure of the two elements of the deflection.

As it has been said in the discussion of the general conditions of strabismus (page 365), there are exceptions to the rule that the images are homonymous in esotropia. The exceptions are rare and are always associated with hypertropia. Instances of this unusual position of the double images will be mentioned in the section on "Exotropia."

By the tests of deviation in exclusion this oblique direction of the deviation can be observed if sufficient care is exercised in the examination.

The axes of the two eyes do not, in esotropia, always maintain the same relative positions; for while within a certain range the deviating eye will deviate in more and more in proportion as the object is brought nearer the eyes and the fixing eye becomes more convergent, within that range the relative convergence may become more nearly equal and the squinting consequently less, until, as has been already stated, in certain cases the visual lines may meet at the object. In the more extreme cases the deviation of the strabismic eye continues, that eye deviating in more and more as the object approaches the visual lines crossing between the eyes and the object as long as the fixing eye continues to converge.

In other cases this same deviation when the convergence of the fixing eye reaches a certain extent becomes suddenly even much more extreme than before, and the deviating eye appears to be drawn spasmodically into the inner canthus. In still other cases, when the convergence of the fixing eye has reached a certain stage the deviating eye suddenly turns out, and diverging strabismus results.

Converging strabismus is more frequently associated with hypermetropia than with other refractive states of the eyes. This fact has led to the supposition that the refractive state of hypermetropia is causative of the squint. This subject will receive attention in a

special section and need be referred to here only as one of the phenomena often attending this form of strabismus. But the refractive conditions attending converging strabismus are various, being in some cases emmetropia, in other cases astigmatism, in a considerable number hyperopia, and in a less number myopia.

Subjects of converging strabismus are usually fatigued from slight causes. They have, in general, little physical endurance, and are more than the average persons, subject to various illnesses which may happen to prevail. Hence the proportion of persons with converging strabismus who reach adult age is less, independent of the results of operations, than it is among other children. They have, as a rule, much headache, the pain of which is experienced especially in the forehead and temples. Women with converging squint are apt to be hysterical and men are likely to be nervous and often morose. Dyspepsia, despondency, and eccentricity are rather characteristic associated conditions. Neuralgia about the temples and face and pains in the dorsal region are also common symptoms with converging strabismus. The subjects of the defect often start out well in the morning, but become nervously exhausted before night.

They are also subject, to an extent greater than the average persons, to chronic diseases of various organs, as, for example, the lungs or kidneys. When Bright's disease exists associated with converging strabismus, paresis of the externi with diplopia becomes one of the frequent complications.

EXOTROPIA—DIVERGING STRABISMUS.

In exotropia or diverging strabismus the defect is usually very plain to be seen and constitutes a feature of facial expression more striking than a deviation of equal extent in the opposite direction. If the usually fixing eye in exotropia is covered, the deviating eye moves from the temporal direction inward in order to place itself in fixation, and the previously fixing eye moves outward toward the temple to an extent equal to the moving in of the usually deviating eye.

If the subject of the strabismus is able to recognize diplopia, a red glass before the right eye will show a red image at the left of the image of the left eye, and if the colored glass is placed before the left eye the red image is seen at the right of the other. If a change in the vertical relations of the images is required in order to obtain the notion of diplopia, a change such as may be made by

the phorometer or by a prism with its base up or down before one eye, the image seen by the right eye will appear at the left of that seen by the left eye.

The defect is rarely observed during the first two or three years of life, and frequently not before the eighth or tenth year.

It is less frequently periodical than the converging form of squint, and rarely, after being once established, disappears, as does the form of esotropia.

The very general belief that divergent strabismus is usually associated with myopia does not appear to be borne out by a long series of examinations carefully made, and while myopia prevails to a greater degree in diverging squint than in the converging form, the two conditions cannot be said to be generally associated. According to my own records myopia is found in about 25 per cent. of cases of



Fig. 150.



Fig. 151.

Indicating the Compound Direction of the Deviating Eye
in Diverging Strabismus.

exotropia with or without hypertropia, which is about the per cent. of emmetropia, while hypermetropia has been found in very nearly 50 per cent. of all my cases of exotropia. (See table, page 409.)

If the deviation of esotropia, converging strabismus, is often associated with hypertropia, even more pronounced is the association of exotropia with the deviation in the vertical direction. It is indeed rare to find the images in the crossed diplopia of divergent strabismus in the same plane, and the degree of hypertropia is usually considerable.

As in converging strabismus there is often a somewhat increased medial rotation of both eyes, so there is with diverging squint frequently a moderate restriction of the nasal with a somewhat increased temporal rotation. The extent of the restriction of the nasal and of the increase of the temporal rotations do not, however, bear any proportionate relation to the extent of divergence, and the extent of

inward rotation is generally about equal for the two eyes. This rule does not hold good when with a considerable degree of hypertropia one eye is adjusted nearly in what, for convenience, may be called the normal plane. In that case the eye which is adjusted for a plane neither too high nor too low will have a greater freedom of rotation in the nasal direction than its fellow, which will be held back by the action of the vertically acting muscles.

With such exceptions, which are of a purely mechanical nature and always depending on the vertically acting muscles or the character of the declination, the nasal rotations in diverging strabismus are equal and usually sufficient.

That in exotropia, the function of associated convergence of the two eyes is insufficiently performed is too evident. Indeed, this insufficiency of the converging function is the conspicuous symptom of this form of strabismus. Such failure in this function is not associated with an actual absence of the ordinary power of moving each eye to the nasal side when acting alone. This may be shown either by the use of the tropometer, in which case the degree of rotations can be accurately established, or by causing the exotropic persons to move the eyes from side to side while the observer notes the extent of movements both out and in.

Exotropic persons are, much more than esotropic subjects, accustomed to close one eye when reading or working. They are often subject to constant dull pains about the eyes and to dizziness. They generally have frequent and severe headaches and pains in the back of the head and neck. Pains in this locality are more characteristic than those in the forehead so common with esotropia. There is often confusion of ideas and mental exhaustion.

HYPERTROPIA—STRABISMUS SURSUMVERGENS.

This form of strabismus which has been regarded as rare is, in fact, the most common of all the forms. Not only does it constitute a very considerable proportion of the cases of squint in which it is either the only or the most conspicuous element of the defect, but it is associated with a great proportion of the two forms which have received from authorities on the subject almost exclusive attention.

A deviation of one eye above or below its fellow, unless to an extravagant extent, is so much less than a lateral deviation noticeable that the friends of patients and patients themselves are frequently not aware of the defect, and those who have examined squint

from the point of view of cosmetics have overlooked a great many cases belonging to this class while carefully recording those in which moderate converging or diverging deviations have appeared. That during the last few years, especially in America, these cases have been more frequently recognized than previously, is clearly to be seen by the literature. Yet the fact remains that even now and in America many cases of hypertropia appear to fail of recognition.

One may be subject to a degree of vertical squint which is sufficient to prevent the possibility of binocular single vision and to result in a high degree of amblyopia while the defect does not attract much attention. The fact that the individual has not an agreeable expression of the eyes is regarded simply as a personal peculiarity which is not clearly classified. The defect shows mostly when the subject of it is looking at a considerable distance, but in many cases it manifests itself by an inward or outward squint when the hypertropic person looks at a near point, as in reading. This inward or outward deviation at near points has been supposed to arise from some disturbance between the function of accommodation and that of convergence, and has been ascribed to hypermetropia. We have here to call attention, not to the cause, but to the phenomenon, and this is an important phenomenon, which has been absolutely ignored by all the writers on the subject of squint. In all cases in which a converging squint, not observable when the patient looks at a distance, occurs when he looks at a near object, either an actual vertical squint or at least a high degree of hyperphoria exists.

The case with which vertical squint of a high degree may escape attention is illustrated in the following case:—

C. F., age 40, is a gentleman of means and education who has lived a life of leisure, but has been all his life a valetudinarian. Application to any employment which has demanded the concentration of vision at any one point for a considerable time has been always distasteful to him, and although a man of much general culture he has never been a reader. He has known since boyhood that one of his eyes was much "stronger" than the other and he has since his early boyhood been subject to frequent and severe attacks of headaches. He has consulted many physicians on account of his nervous troubles and, as his eyes have annoyed him, he has seen a number of distinguished oculists, who have prescribed glasses, some of which he has with him at present.

The vision of the right eye is $\frac{6}{6}$ and of the left $\frac{6}{15}$, and no glass improves the sight of either eye at 6 meters. There is no indication of disease of either eye. He has never been told that he has strabismus, and his wife, a very intelligent lady, is astonished to hear that he is strabismic.

When the patient is directed to look at the flame of a candle on the opposite side of the room, if a visiting card is slipped in front of the right eye, the candle is not seen for a second or two, but the left eye can be seen to turn from below upward until it has the candle in fixation. If a prism of from 12° to 15° with its base down is placed before the right eye so that in the first fixation the right eye is obliged to look up to that extent, but little movement can be detected on the part of the left eye when the right is excluded. It was at the first and second examinations impossible for him to recognize diplopia without aid or by the help of colored glasses and prisms or by any device.

By the table on page 409 it will be seen that hypertropia occurs as the principal element of squint in $24\frac{1}{2}$ per cent. of all the cases of strabismus, and that it is an important element in more than 50 per cent., while it is also present in nearly all, if not all, cases of concomitant squint.

In the cases included in the table it does not follow that there is always an absence of hypertropia where it is not recorded, for in some cases the difficulty of obtaining exact information respecting the relative positions of images is so great that such an element may, even where care is exercised, not be revealed.

The disabilities of the eyes and the general neurasthenic symptoms which are commonly associated with esotropia are also frequently found with hypertropia. Thus, headache is one of the most common of the associated symptoms. In the case of simple hypertropia, however, the pain is often located in the upper part of the forehead or even back of this over the eye, the visual line of which is directed lowest and directly over the brow of the eye deviating upward. While this is so frequently the case as to be characteristic, it is not always so, and there are cases with hypertropia who rarely if ever have headache.

In many cases the headache is of the character of migraine with vomiting or excessive nausea. Dizziness is very common with hypertropia, and the cases in which vertigo is a prominent symptom are so common that vertigo may be regarded as a characteristic symptom with vertical squint. In moderate cases the patient is able to unite the images of the two eyes when looking at points quite near to the eyes, and not unfrequently it will be observed that such patients hold their book or their work very close to the eyes, suggesting a high degree of myopia, although an actual hypermetropia may exist. In such cases the greater effort at adjustment is preferred to the confusion of diplopia.

Excessive lachrymation is also a frequent associated condition with vertical strabismus, as it is also with decided hyperphoria.

Mental confusion occurs in a very considerable percentage of cases.

Amblyopia of the squinting eye is even much more pronounced than in converging squint, and it may be said that in this latter form of strabismus the extent of amblyopia is largely in proportion to the degree of hypertropia which exists as an element in the case.

In many cases of hypertropia with moderate lateral deviation it is quite impossible for the patient to locate the light from the flame of a candle in any part of the field of vision. Hence, the eye cannot by any effort of the will be directed toward a given object. In cases in which conscious diplopia can be induced, the latter is sometimes homonymous for distant objects and crossed for near; in other cases the diplopia remains homonymous for a length of time, perhaps for years, then changes to crossed diplopia. Such a case may remain for years as a converging strabismus, and at a later period become a pronounced diverging squint. Such cases belong to the class of spontaneous cures or cures from convex glasses. The convergence or divergence in these cases represents only the swing inward and outward of an eye held suspended above or below its fellow.

In a proportion of these cases there is also an apparent contradiction in the indications from diplopia and from the apparent deviations and the deviations in exclusion. The apparent deviation may be convergent, the eyes appearing crossed, but if a card is slipped alternately before one and then the other eye each eye will be seen to move distinctly in toward the nose when changing from exclusion to fixation, thus showing that the excluded eye drifted, not in, but out in exclusion. Again, the appearance may be that of divergent squint and the deviation may correspond with this appearance, yet the double images may be homonymous. These and some other seemingly contradictory phenomena are the result of high degrees of declination which attend these cases of hypertropia.

In cases of comparatively simple hypertropia the diagnosis is easy, since even when double images are not recognized, the test of deviation in exclusion quickly reveals the defect.

SECTION XLIX.

ANOTROPIA AND KATOTROPIA—THE TWO FORMS OF DOUBLE VERTICAL STRABISMUS.¹

These more or less symmetrical forms of deviation of the two eyes vertically, either up or down, and those comparatively symmetrical unfavorable adjustments in the vertical direction which are of less extent than strabismus, were not recognized by former writers. Attention was called to them by myself at the meeting of the British Medical Association² held in Bristol in 1894, and at the International Ophthalmological Congress at Edinburgh³ of the same year.

There is a clearly dividing line between the strabismic forms of deviations of this type and the forms which I have called anophoria and katophoria. In the more extreme form the two eyes *may be seen alternately to deviate vertically* and in the same direction when a screen is passed from before one to the other and back again.

Notwithstanding the fact that these are the least conspicuous forms of strabismus, they are so far from being of the least importance that they may be regarded as ranking before all other forms as of paramount significance.

A careful consideration of these deviations is of primary moment in the study of converging and diverging strabismus.

These double vertical deviations are not to be regarded as being the same conditions as those formerly known and described in the text-books as strabismus sursumvergens or strabismus deorsumvergens, for in these later conditions one eye is supposed to be correctly adjusted in respect to the horizon, while the other eye deviates above or below this well-adjusted eye. Such conditions are in this work described under the terms hypertropia, right or left. As a matter of fact many cases which have been regarded as simple hypertropia, strabismus sursum- or deorsumvergens, in reality belong to the class now under consideration, and the choice of one eye to be used in fixation while the other is permitted to deviate above it or below it is

¹For the conditions of symmetrical forms of vertically deviating tendencies of degrees less than strabismus, see page 217.

²"On Double Vertical Strabismus," a paper read before the Section of Ophthalmology of the British Association, July, 1894, and published in *Annales d'Oculistique*, April-June, 1895.

³"Transactions of the Eighth International Ophthalmological Congress," page 226.

similar to the condition in converging strabismus where one eye is selected for habitual fixation, although there may be as great a tendency toward deviation in one as in the other eye.

The forms of adjustment in this class are:—

1. Anotropia, a deviation of the visual line of either eye upward when the other eye is in fixation.

2. Katotropia, a deviation of the visual line of either eye downward when the other is in fixation.

The simplest form of double vertical squint, that in which *either eye* deviates directly upward or downward when the other is in fixation, has not, I believe, been described previously to the description contained in my paper above alluded to. In these cases the patient, in most instances, selects one eye for habitual fixation, while the other is permitted to diverge upward or downward. In the first instance, if, while the habitually fixing eye is directed toward an object, a visiting card is slipped between the eye and the object, the squinting eye is seen to move directly downward, while the eye behind the card rises in a direction as exactly vertical as that through which the originally squinting eye descended, and to an extent approximately equal to the original squint. In some of these cases the patient is able to exchange the fixation from one eye to the other at will. In these cases the action of the two eyes is identical with that which is shown when the card is used. If the left eye, for example, squints upward, and the patient is directed to fix with that eye, the observer can see the eye move directly downward while the other rises as directly.

If, while the patient fixes a lighted candle, a red glass is slipped before one eye, in many cases conscious diplopia results with, for example, the red image below. Changing the red glass to the other eye, the image of that eye at once becomes the lower. This is the case in anotropia. In katotropia the red image will in each instance be above.

In nearly all these cases, by close observation, the deviating eye can be seen, as it comes down to the position of fixation when the other is covered, to come into position with a twist. Sometimes this twist is very conspicuous. A better way to observe this is, after putting one eye under the influence of cocaine (or even better, without cocaine), to place one or two very small squares of black paper, one on each side of the cornea, but on the conjunctiva, or two minute white points may be placed on the cornea, the lower lid being held away from the eye. Then by changing the card from one side to the

other as this eye comes into fixation, the little back or white points are seen to change direction, one going up, the other down, many degrees.

It is thus seen that with such double vertical squints there is also extreme declination, and it is this feature which, unquestionably, forms one of the two causative elements in the case, the other being the fact that in anotropia the plane of vision is remarkably high.¹

The simple lowering of such eyes does not correct the tendency to squint up, but a correction of declination does.

Persons with this double form of strabismus usually have a sort of uncertain gaze with a goggled appearance of the eyes.

There is not, in the more simple cases of double vertical deviation, the unpleasant appearance characteristic of convergence or divergence, for so long as the cornea of each eye does not deviate laterally from its fellow, a very important deviation upward or downward either escapes observation altogether or causes a much less conspicuous defect.

Even in the least complicated cases there will be a frequent, though transitory, cast of one or other eye inward or outward, and if the patient becomes fatigued the cast is more persistent. Visual confusion, vertigo, headache, are among the symptoms commonly attending this anomaly, and epileptic seizures and intellectual dullness are also among the unpleasant attendants upon anotropia and katotropia.

As an illustration of the condition in which there is actual deviation of the eyes almost directly upward the following case is introduced. It should be said, however, that this case was examined and treated before the introduction of the tropometer or clinoscope, a fact which accounts for the absence of any exact measurements of the rotations or declinations. It is, however, a remarkably conspicuous case, and the elements not recorded may be readily substituted.

Miss E. M.—, aged 14, seen in July, 1894, had been subject to constant headache as long as she could remember, often accompanied with dizziness. The persistent and intense pain in the head at length compelled her to abandon school, yet even when she was not engaged in study there was great distress.

She was found to be a robust girl, with no organ diseased, and with no apparent cause of disturbance except the eyes. Examination of these organs shows: vision of right eye, $\frac{6}{18}$; of left eye, $\frac{6}{2}$; each with + 1.50 spherical.

Excluding either eye, the other deviates directly up 4 to 6 millimeters,

¹ Since writing the above paragraph I have been led to doubt the statement that an extremely high plane of vision is in all cases an essential element. It certainly is found in most cases of anotropia.

but it is the right eye which generally deviates, or, as her friends state it, "rolls up into her head," while the left eye is usually chosen for fixation. She can, however, fix either eye at will; then its fellow deviates up. When she is fatigued the deviating eye rolls further up than when she is fresh. There is no indication of paresis; indeed, there is ability to rotate the eyes freely in all directions, except that the upward rotation is greater than the downward.

If a red glass is placed before the right eye and she fixes the left, there is vertical diplopia, right hypertropia, 5° to 12° . If the red glass is changed to the left eye and she fixes the right eye, there is left hypertropia, 3° to 8° . In both instances it is easy to see that only a portion of the vertical distance between the images is measured, for the patient can be seen to balance the eyes up and down, and it is evident that to a large extent the location of the images is modified by these movements.

The deviations upward are, in fact, more than would require a prism of 20° for correction, for, even when such a prism is placed with its base down before the deviating eye, and the other eye is excluded, the deviating eye is seen to move down for fixation. It is, therefore, impossible, from the statements of the patient, to form a correct judgment of the actual amount of deviation of the images.



Fig. 152.—Left Eye in Fixation,
Right Deviating up.



Fig. 153.—Right Eye in Fixation,
Left Deviating up.

In moving from deviation to fixation each eye moves down almost in a vertical line, and in returning from fixation to deviation each moves directly up.

The figures 152 and 153 show the position of the eyes: 152, when the left eye is fixed; and 153, when the right is directed to the object.

After examinations, made on four or five successive days, graduated tenotomy was done on the superior rectus of the right eye, and a week later a similar operation was done on the left eye. These relaxations were found to be insufficient to prevent the upward deviations of the eyes, and other careful tenotomies have been done on each of these superior recti since then.

The result has been to correct the deviations to the extent that they can only be perceived when the observer passes a card from one to the other eye and watches carefully for the movement. Each eye, under these circumstances, may be seen to move up very slightly in exclusion, but it has been thought best to permit considerable time to elapse before resorting to attempts at a more perfect correction.

From the first relaxations the pains in the head became less intense and

very much less constant, and the girl was able to resume her place in school; she was no longer dizzy.

Since the above records were made the examinations have been aided by the clinoscope and the tropometer, and it is found that while the vertical rotations are nearly normal there exist enormous declinations. Further treatment has been reserved since the girl appears so well that further operations may wait.

Figs. 154, 155, 156, and 157 illustrate two cases reported by me in *Annales d'Oculistique*, 1895, in each of which there was marked converging strabismus. As there was also double vertical strabismus, anotropia, relaxations of the superior rectus of each eye was done with the result of relieving the convergence in each case.

The cases mentioned above indicate the methods which were employed at the time that they were first under observation. Recent advances have



Fig. 154.



Fig. 155.



Fig. 156.



Fig. 157.

Cases of Converging Strabismus Depending on Vertical Deviations and after Treatment Directed to the Superior Recti only.

placed the diagnosis, the estimation of the degree of vertical strabismus and its nature upon a much more definite basis. It is no longer necessary to rely upon the subjective phenomena as experienced by the patient, nor upon the observation of the surgeon as an eye passes from exclusion to fixation.

The tropometer affords a means of determining with accuracy the relation of the adjustment of either eye in respect to the plane of the horizon.

The clinoscope, the lens clinoscope, or the rude method by the black or white bits of paper placed on the eye, will aid in determining

the declination, and by these means much more satisfactory results may be expected than in the cases mentioned.

SECTION I.

PERIODIC OR INTERCURRENT STRABISMUS.

The class of cases included in this category is made up from the classes already described. It is a class in which the strabismic deviation is not constant, yet appears under certain circumstances, and is perhaps at times quite noticeable. Von Graefe, in his elaborate treatise (*Arch. für Ophthal.*, Bd. iii), devotes much space to these recurring varieties, describing the individual phenomena with some minuteness while apparently overlooking in general the most essential elements.

These intercurrent forms include a very important proportion of all strabismic cases in the early stage. Most strabismic children when they begin to squint do so only periodically.¹ Not all cases, however, pass to the state of permanent squint, a certain number continuing to squint periodically.

The periodical forms include:—

1. That variety in which no decided deviation is manifest when the eyes are in perfect repose, but immediately, when the gaze and the attention are definitely fixed upon a given object, whether at near or remote distance, a squint occurs.

Many persons subject to this form of strabismus habitually avoid, as far as possible, fixed attention with the eyes upon any subject for a considerable time. In conversation they glance at the person addressed in a furtive manner and at once turn their gaze away. They belong to the class of which it is said "they cannot look one straight in the eye."

If these cases are examined by the phorometer, tropometer, and clinoscope, they are found to have greater or less degrees of hyperphoria, generally associated with anotropia, or nearly always very marked declinations, generally of a conjugate character. When the gaze is directed listlessly upon the ground or into vague distance the visual line of one eye often rises above the other. There is either

¹ Von Graefe, following Böhm, regarded the periodic form as the expression of a preliminary period of the "disease." The permanent form he regarded as the secondary stage of the "disease."—*Arch. für Ophthal.*, Bd. iii, 1, p. 277 *et seq.*

vertical diplopia or such incomplete union of the images of the two eyes that confusion results when they are both directed toward the point of attention. The slight vertical deviation is not conspicuous, but as soon as the attempt is made to direct the eyes in close fixation, the vertical diplopia or the confusion from the imperfectly united images makes it necessary that the axis of one eye should turn away from the direction of the other in order that, by a more considerable removal of the double images, the visual confusion may be relieved.

2. In another class the eyes do not appear to abandon their normal relations to each other until a certain point of proximity is passed, perhaps at one or two feet, or more. Within the limits of this distance no squint is observed, but beyond it strabismus becomes manifest.

Here, too, with the phorometer and the tropometer it will be found that the images do not lie in the same horizontal plane, but that within certain limits the inequality in height may be overcome. Beyond this the images persist in remaining vertically separated, and a convergence or divergence follows.

3. In still another class the strabismus occurs only at near points. Such a person may not appear to squint until he takes a book or work in hand, then squinting at once occurs.

Like the two forms already mentioned, there is a difference in the height of the images, in this case, however, becoming uncontrollable only when the gaze is depressed and convergence exercised. These features can be studied and located when we are careful to examine all the actions of the eyes in their relations at various distances and in various planes of elevation or depression.

There is no exception to the rule in these cases that there is an unfavorable adjustment of the eyes in relation to the horizontal plane, affecting the direction of one or both the visual lines. There is generally hyperphoria and often there is anotropia. Declination here, as in the other forms, is at the root of the whole matter, inducing the hyperphoria which in turn induces the convergence. Von Graefe believed that a cure for these cases of periodical squint could seldom be obtained. And very natural was such a belief when he regarded the lateral deviations as the essential defects.

Taking the more philosophical view resulting from investigations which we are now able to make, and regarding periodical deviations as the expressions of unfavorable adjustments, there is no longer any occasion for this gloomy view of the situation, and we

may with a reasonable degree of confidence expect not only to be able to remove the unpleasant appearance of squinting, but to bring about an easy and normal community of action of the muscles in all positions of the eyes.

SECTION LI.

CAUSES OF STRABISMUS.

Of the causes assigned for the deviations of concomitant strabismus in early times, many appear to us at present to be trivial. The habit of placing a child in its bed often in the same position, the imitation of a nurse, the careless neglect to use one eye and thereby permitting it to squint, these and many other such supposed influences may be dismissed without discussion.

A small number of cases of squint occur as a sequel to corneal scars, lenticular opacities, and other obstructions to direct vision of one eye. Thus, a person subject to central blindness of one eye, as from a choroidal atrophy, occupying the vicinity of the macula lutea, may cause the affected eye to squint in order to bring the unaffected portion of the fundus in line with the object and the pupil.

These various incidental causes, however, operate in only a small percentage of cases, and, indeed, the cases cannot in general be regarded as belonging to the class of concomitant strabismus. In some of them, as in certain cases of corneal or lenticular obstruction there may have been an underlying tendency to squint¹ which, so long as binocular vision remained was held under restraint.

Passing then to cases of clearly defined concomitant strabismus, we find certain phenomena which have been explained on many hypotheses, nearly all of which have been assumptions not based upon natural laws or upon anatomical research.

There is, for example, the hypothesis that the inner muscle of the squinting eye in converging strabismus is short in proportion to the other muscles, but no confirmation of this hypothesis has been found by dissection of strabismic eyes, and the action of squinting eyes when the patient is under the influence of anæsthetics is not consistent with the theory. Again, the external muscle of the same eye in the same form of squint is often called "the weak muscle,"

¹ In case of marked declination of one eye, if the other becomes aphakic (operation for cataract, etc.), the aphakic eye generally swings out or in, depending on the direction of declination of the sound eye.

yet there is no evidence of any such "weakness." Indeed, it is very easy to show that neither the "short muscle" hypothesis nor the assumption of "weakness" has any part in the etiology of concomitant strabismus except as will be shown as we proceed.¹

If the strabismic eye and the non-strabismic eye are both subjected to the test of the tropometer, the power of the muscles and the excursion of the eye will be as great in the case of the squinting as in the non-squinting eye. Such exceptions as are found to this rule can be explained upon ordinary mechanical principles and do not constitute an objection to the statement. For example, the cushion of connective and fatty tissue forming the bed in which the eye rests may become so modified by the habitual rolling of the eye in toward the nasal side as to present less obstruction than exists in the normal state to the inward rotation. So also this same connective tissue and fat cushion may, from the habitual position of the eye, become a mechanical obstruction to the free rotation inward.

We have then the hypothesis of "cerebral or central nervous troubles." These are supposed to be cerebral troubles developed in infancy and causing some modification in the function of convergence. When we inquire as to the nature or location of the supposed cerebral trouble or its action, when we attempt any practical application of the hypothesis, we find it vague, confused, and as empty of meaning as it is of scientific basis. It is a phrase which can only serve to excuse the absence of definite knowledge which it is supposed to cover. There has not, in any case of concomitant strabismus, been observed the cerebral condition which can support the hypothesis of a cerebral disease as a cause of the deviation. The fact that in some instances strabismus and infantile convulsions have been coincident does not sustain the doctrine, nor are there any facts that do.

We come now to an assigned cause of strabismus which has been so universally accepted that it is necessary here either to conform to the almost universal belief or to show why that belief is not well founded.

¹ Von Graefe says that squint is sometimes the expression of disease of innervation, sometimes of disease of the muscle structure, sometimes of external causes of immobility, and sometimes of anomalies of vision. In these cases, however, he includes those of the different kinds of strabismus, concomitant, paralytic, etc. ("Beiträge zur Lehre von Schielen." *Arch. für Ophthalmologie*, iii, 1, 177.) But von Graefe did not regard a disease of innervation as the cause of concomitant squint. He says (*loc. cit.*, p. 184) that "the symptoms of concomitant squint are independent of any disease of innervation." According to his view concomitant strabismus is a disproportion between the lengths of the antagonizing muscles.

SECTION LII.

THE RELATION OF THE FUNCTION OF ACCOMMODATION TO THAT OF CONVERGENCE.¹

The views of no man have been more universally and more unreservedly accepted than those of Donders, the revered investigator and pioneer in modern ophthalmology. Personal devotion to the man has been added to professional admiration for the scholar. Nevertheless, as new facts are added to our knowledge, it is certain that some of the doctrines taught by this close and candid observer may be fairly investigated anew in the same spirit of candor which he originally brought to their consideration.

Donders, as the result of his observations, announced two important propositions in regard to strabismus which he formulated thus:—

“1. Strabismus convergens almost always depends upon hypermetropia.

“2. Strabismus divergens is usually the result of myopia.”

The argument in support of the first proposition is based upon the necessity for extraordinary tension of the accommodation in hyperopia, and therefore of the necessity for a corresponding excessive tension of convergence, a tension which at length results in permanent contracture of the converging muscles.

Donders did not teach that this connection was absolute and necessary, that the excess of tension of accommodation in hypermetropia must inexorably induce an excess of convergence, as had some of his predecessors in the same field of inquiry. He recognized the fact that under certain circumstances the relation between the two functions can be “at least partially overcome.”

As a matter of fact, is there any such physiological connection between these two functions as to warrant the assertion of Donders that, “so far as the range of accommodation for both eyes extends, the state of the accommodation of the eye corresponds to a definite convergence of the visual lines?”

A number of very conspicuous facts are in conflict both with the main proposition and the statement just quoted.

¹The substance of this section is taken from a paper read by the author at the International Ophthalmological Congress, Edinburgh, August 10, 1894.

It is well known that in case of complete paralysis of accommodation occurring suddenly in young persons the function of convergence remains undisturbed. Cases which have come under my observation have, when examined by the phorometer both during the continuance of the accommodative paralysis and after complete recovery, shown not even a degree of excess of convergence during any stage of the paralysis.

Every one is familiar with the case of the gradual loss of accommodation from presbyopia with no excess of convergence.

The converse condition, that is, the loss of the converging power with perfect immunity to the accommodation, while of rare occurrence and while presenting difficulties in the examination, does not lead to the conclusion that there is any organic relation between the two functions.¹

Cases long since reported by von Graefe, and many cases reported by others since then, clearly show that accommodation is retained in paralysis of the interni and in ophthalmoplegia externa.

These are but a few of the facts from the point of view of the separate performance of these functions.

Turning to the anatomical side of the question we find nothing to sustain the propositions of Donders. The more recent investigations of the anatomy of the nerve centers controlling these functions show not only that the nucleus controlling the function of accommodation is distinctly separated from that governing the convergence, but that the nerve fibers from each root pass separately out from the brain, and that they are only united within a common sheath after they have traversed a considerable space as separated fasciulae.

Such considerations suggest that these two functions, which usually act in close agreement, so act as a result of habitual, not of organic association.

Training or a necessity which interposes important obstacles to the habitual association of action quickly enables the individual to disassociate the two functions absolutely.

Donders supports his theoretical view, that "strabismus convergens almost always depends upon hypermetropia," by the statistical results of his investigations concerning the refractive condition

¹ In a valuable paper by Prof. C. Hess, of Marburg, at the International Congress of Ophthalmology, Utrecht, 1899, he arrives from technical considerations at conclusions similar to those which I expressed at the Edinburgh Congress in 1894.

of strabismic persons. In 172 cases of strabismus convergens investigated by him hypermetropia was 133 times proved to exist in the undeviated eye.¹ Thus hypermetropia was present in 77 per cent. of his cases. In many of these cases the H. was completely latent.² These results would certainly suggest an important relation between the condition of squinting and the condition of hypermetropia if we take no other phase of the investigation into consideration. When we remember that in the extensive examinations of pupils in schools which have been reported during the last few years the percentage of hypermetropia is stated by the examiners to be from 66, by some examiners, to more than 80 per cent., by others, of all the pupils, it appears at once that the percentage of hypermetropia found by Donders in converging strabismus is in no material respect different from that which others have found in young persons in general. In other words, the fact that Donders found 77 per cent. of cases of converging strabismus associated with hypermetropia, manifest or latent, corresponds with the fact that others have found even a greater proportion of hypermetropic cases in non-strabismic people.³

The fact of greatest interest in this connection and that which has lent more support to the theory of Donders than all other facts, is that, by the use of convex glasses, converging strabismus, in a certain proportion of cases, disappears, at least in some measure, while the glasses are in front of the eyes. The strabismus in these cases returns immediately upon removal of the glasses.

Such a striking fact cannot be ignored nor regarded as a coincidence. The deduction is natural that by relieving the accommodation, the result in correcting the squint must be, in consequence of such relief, to the accommodation.

This would be good logic if the convex glasses could perform no other office than that of relieving the accommodation. This is not

¹“Accommodation and Refraction of the Eye.” p. 292.

²*Loc. cit.*, p. 193.

³In Donders's cases and in the cases of some of the examiners of schools mydriatics have been employed. Practitioners who have been in ophthalmic practice for several years must have observed that in many cases in which during the period of life while accommodation was active atropine has revealed a supposed “latent hypermetropia.” there has been no indication of hypermetropia when, as the result of presbyopia, years later, the accommodation has been practically abolished. It thus appears that mydriatics may cause a condition of apparent hypermetropia, which is not the normal refractive condition of the eye. This is by no means the only error into which the practitioner may be led by the practice of paralyzing the ciliary muscle with the view of ascertaining the refractive state of the eyes.

the fact. Hence the deduction does not follow until the other offices performed by the glasses are examined to learn whether by these the same result may be reached. Convex glasses may act as prisms and serve to relieve a hyperphoria.

We have already seen that hyperphoria plays an important rôle in inducing strabismus. It is quite possible for the eyes to seek such level of each glass as to find such a prismatic correction of hyperphoria as to relieve the strabismus.

The example shown in Figs. 158 and 159 will illustrate this proposition.

The young girl here represented had used 3.50 D spherical glasses for the correction of her strabismus. The eyes looked fairly



Fig. 158.



Fig. 159.

Showing the Correction of a Converging Strabismus by a Weak Prism with its Base Down.

straight when her glasses were on, but the right turned in when the glasses were off. If, however, I substituted a prism of 4 diopters with its base down before the left eye (or up before the right) exactly the same effect, or rather a better one, resulted.

The two pictures were taken at the same sitting within one minute of each other. In that at the left the right eye squints in. Immediately on placing the prism before the left eye the eyes appear, as in the figure at the right, parallel.

It is an advantage of the spherical glass that the patient may adjust the eyes to a certain degree of prism, since the glass is a prism

of increasing strength as the visual line passes further from the center. Concave glasses sometimes serve the same purpose as convex in causing a temporary relief to strabismus.

The strong convex glasses may serve another and a more important office. Acting as prisms, but not in the direct manner of a plane prism, the image seen through a strong spherical glass may be subject to a tilting which may serve to neutralize an important declination.

Beyond question the deviations of strabismus are in close relation to declinations. If then the eye can find a point in these strong glasses where such a neutralization can be found the strabismus may disappear. This fact is excellently illustrated in the case represented by the three following figures:—

The young woman here represented had had, previously to my

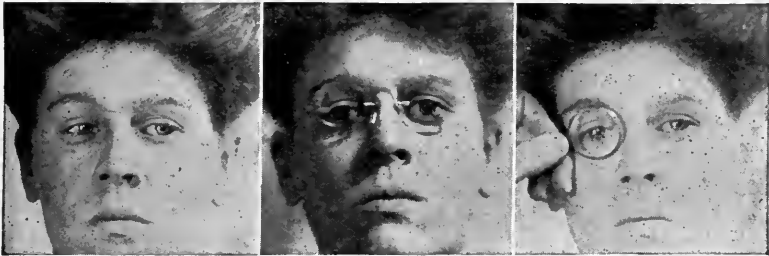

Fig. 160.

Fig. 161.

Fig. 162.

Influence of a Convex Glass in Correcting an Inward Deviation.

knowledge of her case, three very free tenotomies for converging strabismus.

The squinting was not relieved as may be seen by the first figure. (Fig. 160.)

Yet the medial rotation of the left eye was nearly destroyed. By the strongest effort, after some practice, she was able to rotate that eye in only 30° , while the medial rotation of the other eye was 60° .

She was using + spherical glasses of 4.00 D. With these the eyes appeared *not to squint in but out*. The left (disabled) eye was invariably in fixation. If, while she looked at a distant object a visiting card was slipped in front of the left eye the right eye could be seen to move distinctly toward the nose and occupy the position

of fixation, while the other wandered out. Thus, although the convergence was corrected, a divergence of nearly equal extent, as shown in the second figure (Fig. 161) was induced.

Again, if a + 5 D. spherical glass was placed before the right eye (which was generally in fixation without her glasses) the left at once moved out and up with a very distinctly marked twist (Fig. 162), the upper end of the vertical meridian moving *out*. If placed before the left eye, the action was less emphatic and sometimes failed.

It is evident that in this case the neutralization of accommodation is not the means through which the strabismus is influenced. Each eye finds a point in the lens where the image is most erect and the esotropia is changed to the state of exotropia, which represents the actual adjustment, since one of the interni has been largely disabled.

Another class of facts may be shown to have as little bearing upon the relation of accommodation and deviation. The cases which, by the use of mydriatics and myotics, are temporarily relieved, are not relieved because of the effect upon the accommodation, but on account of the effect upon vision.

When the borders of objects are indistinctly seen there is less effort to correct an existing declination, and hence, generally, less tendency on the part of the eyes to deviate in.

The action of mydriatics is not, however, entirely uniform in this respect. I have observed a number of cases in which converging strabismus of a pronounced character has been induced by the action of mydriatics. An excellent illustration of this class of cases may be seen at pages 431 and 432, where Figs. 172 and 173 show the adjustments of the eyes when in their normal state and when under the influence of atropine. As shown at Fig. 172 there is a marked exophoria or, perhaps more correctly, a slight diverging squint. When the eyes of the patient are thoroughly under the influence of atropine there is a strongly marked converging strabismus. The patient whose eyes are thus represented had in childhood marked converging squint which she "outgrew." As a matter of fact she has marked declinations, and when she, for some reason, acquired the habit of fixing with the left instead of the right eye, the strabismus changed from converging to diverging on the basis of mechanical laws.

Thus, of all the facts which have been employed to sustain the doctrine of the dependence of squint upon hypermetropia, not one can be regarded as proof of the doctrine.

Much space has been devoted here to the discussion of this doctrine, since it has taken so firm a hold upon the minds of ophthalmologists who have accepted it on the authority of a great leader.

It would be even less difficult to show that the doctrine of Donders's second proposition is not founded on a clear conception of facts, but what has been said respecting the first proposition must serve to show that there is not sufficient evidence to sustain the doctrine of a necessary relation between accommodation and squint.

Having thus discussed in the negative some of the causes which have been very generally accepted, we are in position to take up the subject from the positive side.

Converging strabismus is, in not a few instances, largely the result of the instinctive effort to force the visual lines into the same horizontal plane in case of a normal tendency of one of these lines to rise above the other. This condition of hyperphoria or perhaps of hypertropia, in which the image of one eye tends to appear above the other or actually rises above, is a state of the vision for the relief of which the most strenuous efforts will be made.

That this is in many cases true is shown by the fact that a tenotomy properly done on a superior rectus, if the upward rotation of that eye is excessive, will, in an important proportion of strabismic cases, at once and without further procedure relieve the convergent squint.

In a much greater number of cases there is marked anotropia. The rotation upward of a very large percentage of cases of convergent squint exceeds 45° and often exceeds 50° of arc. Here the extreme upward tendency of the eyes imposes upon the inferior recti an excessive tension in the effort to bring the visual lines to the ordinary planes of direction, and this tension is against the normal tension of the superior recti. Owing to the peculiar insertion of the superior and inferior recti muscles this excessive tension constitutes a balance of force, in a majority of cases, against the external recti which is not easy to resist.

But with excessive anophoria there are generally, or at least very often, extreme declinations, and to these extreme declinations, declinations which are materially emphasized and increased by the normal torsions in looking down with any degree of convergence, more than to any other one cause the strabismic deviations are due. If the eyes were not set too high, or if no hyperphoria existed, the patient might control the declinations, and, conversely, if there were

no excessive declinations, the state of anophoria would not induce a squint. Cases already mentioned (Section LI) clearly show that the squint may sometimes be relieved by reducing the plane of vision equally, and much experience shows that if we are able to detect and to reduce to a moderate degree the extreme declinations, while at the same time the anophoria is also reduced, the squint always disappears.

Strabismic eyes cease to be strabismic during sleep, but with converging squint they usually roll far up, directing the axis toward the brows. Surgeons who have frequently operated for strabismus while their patients have been under the influence of chloroform are



Fig. 163.

Fig. 164.

Fig. 165.

Various Forms of Deviation, Depending on the Choice of Fixation.

familiar with the fact that as soon as the anæsthetic influence is established the squint disappears. It has, however, escaped general observation that the eyes roll far up, under the upper lids. The observation of von Graefe, to which reference has already been made at page 359, that with convergent strabismus the squinting eye deviates also upward, while not expressing the whole truth and while not correctly interpreted by him, is of much importance in this connection.

In Figs. 163, 164, and 165 are seen illustrated the adjustments of a pair of strabismic eyes, the directions of the squint depending on whether the left or the right eye is in fixation or whether the patient attempts to fix with both eyes. In each instance the eyes deviate

in respect to the demand for the correction of the peculiar declination. Thus, in the first figure the left eye is in fixation, and the right, with its extreme negative declination, turns in. In the next figure the right eye is brought into difficult fixation, the head being turned somewhat to aid in the effort, while the left eye (with its positive declination) is really (though not in the picture apparently) in a state of divergence when the axes of vision are considered. This can be shown in this case by slipping a visiting card before the right eye, when at once the left eye *moves in* toward the nose, but the head turns to the right.

If the patient looks vaguely, seeing nothing very distinctly, she is able to direct both eyes approximately toward the same object (as in Fig. 165).

In general, if the squinting eye in either case is made to assume the position of fixation, the other eye, when it takes the position known as "secondary squint," also squints up. Thus, not only does the deviating eye squint up, but the "sound" eye, when it becomes the deviating eye, also squints up.

This phenomenon can in most cases be observed if a visiting card is passed alternately before one and the other eye.

In the smaller number of cases in which the adjustment of the axis of one eye is nearly coincident with the plane of the horizon while the other eye deviates above it, in other words, in the cases in which there is simply hypertropia with the converging squint, the vertical deviations of the two eyes will be in opposite directions, as in the case above, when each is in turn behind the little screen. In diverging squint the deviating eye is more likely to deviate down as well as out.

One or other of these forms of vertical deviation exists in all, and may be observed in this simple manner in nearly all cases of lateral squint, whether diverging or converging, but care and patience are sometimes required for the observation, and in exceptional instances other methods must be resorted to if we would demonstrate the character of the vertical deviation.

In Figs. 147, 148, and 149 are seen illustrations of the principle above mentioned. Figs. 147 and 148 are from photographs of patients with concomitant strabismus. In each case the squinting eye is seen to deviate not only inward, but strongly upward. In Fig. 149 is represented a case of paralysis of the externus of the right eye.

Here it is easy to observe that the deviation is not in an oblique direction as in the other cases, but directly in.

These phenomena in concomitant strabismus are not, as von Graefe supposed the upward turning to be, simply associated phenomena, depending in some undefined manner upon the inward deviation; they are essential elements of the squint, depending upon the direction of the declination and the hyperphoria, which is usually itself the effect of the declinations.

It is not difficult to find the reason for the declinations. Examinations of carefully made dissections suggest at once the probability

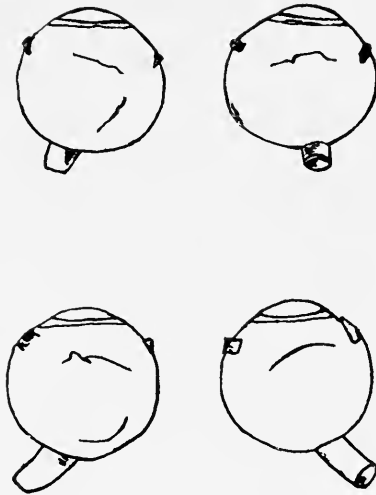

Fig. 166.—Insertion of Tendons.

that the meridians of eyes cannot be uniformly directed in all cases. If we select any individual muscle and examine its attachments to the sclera in different cases we are sure to find variations.

The diagrams, Fig. 166, representing the upper and under surfaces of two eyes and indicating the insertions of the superior and inferior recti muscles in these two cases serve as illustrations of the possible variations of the insertions of all the motor muscles in different eyes. But these diagrams were not made to show this fact; they are copied from the interesting monograph by Leopold Weiss,

“Über das Wachstum des Menschlichen Auges,”¹ etc., and which are here inserted by his kind permission.

If we compare the insertions of corresponding muscles in these two eyes, and if the remaining insertions are no more uniform than the two pairs shown, it must be assumed that both pairs of eyes cannot be adjusted with the same relation of the vertical meridian to an actual vertical position. But it is extremely probable also that the development of the bony walls of the orbits are even more instrumental in the aetiology of declinations.²

Undoubtedly the form of the orbit has a great and, in many cases, a prevailing influence, as has been suggested in Section XXIV.

Katoporia is much less frequently the cause of strabismus convergens among Anglo-Saxons than anophoria.

On the contrary, katoporia is frequently associated with diverging strabismus.

Diverging, like converging strabismus, may have its origin in anotropia, when the combination of declinations is favorable to induce divergence.

SECTION LIII.

HEREDITY OF STRABISMUS.

Strabismus often prevails in families. It is not uncommon to see several members of a family with about the same form of squint.

Among the reports of numerous instances of squint in the same family may be mentioned that of Stratfield,³ who examined seven cases of converging squint in the same family, yet the parents of these children did not squint. I have reported a family⁴ in which were five children, all of whom squinted. In another family which I have seen, more recently, all the five children had converging strabismus, and I am informed that the father had strabismus as a child, but had an operation for it.

It should be added that neither of these children had any very marked refractive error and some of them had none.

From what has been said of the inherited form of the orbits, with resulting anophoria and declinations, the line of this hereditary defect is clearly indicated.

¹“Referate und Entwickelungs Geschichte.” Weisbaden.

² See page 299.

³ Ophthalmic Hospital Reports, vol. i, 1859.

⁴ “Functional Nervous Diseases,” p. 154.

SECTION LIV.

A TABLE OF STRABISMUS CASES.

In a number of works on the subject of strabismus statements appear in regard to the proportion of certain forms of refractive anomalies to each of the generally recognized forms of strabismus, the converging and the diverging.

In these statements, however, there appear no details or very imperfect details of the various conditions, and from these indefinite data important and erroneous conclusions have been drawn.

It has been thought advisable, even at the expense of considerable space, to place before the reader a series of consecutive cases sufficiently extensive to furnish grounds for reasonable deductions, in which a more detailed statement than has heretofore appeared may permit of a closer analysis of the various conditions which may be found coexisting with strabismus. The table consists of immediately consecutive cases in the order in which they appear on the case-books, with a few exceptions in cases of infants in which the examinations have, of necessity, been too imperfect to be of value in this connection. In the great majority the record is the outcome of a number of examinations resulting generally in the ability of the patients to locate the double images and therefore to permit of more or less accurate measurements of the various deviations. In a few cases other methods have been resorted to. While in this small group the results are necessarily less perfect than in the other, they do not vary so essentially from true results as to detract materially from the value of the table.

No cases of paralysis or of deviations from other pathological conditions have been admitted to the list.

As the table was at first prepared it contained 400 cases, but on examination it was found that the summary of results did not vary materially whether the whole number or only the number retained was used.

An important omission of this table is found in the absence of statement in each case of the vertical and horizontal rotations as they may be determined by the tropometer. This omission arises from the fact that the table includes some cases which were examined either before the tropometer was introduced or before it was brought to its present state of perfection. A statement of results of examination by the tropometer in strabismic cases will be found elsewhere.

It is to be remembered that this table does not deal with cases of simple heterophoria, cases in which single vision may exist notwithstanding some hindrances. Every case is one in which single vision was unattainable by the patient. In looking over the cases the numbers representing the degrees of deviation may appear small. In such cases by means of prisms which have served to bring the images into proximity the impulse toward binocular vision has been sufficient to unite images at the expense of effort on the part of the directing muscles of the eyes. With a deviation in the vertical direction represented by a very small number of degrees, it is in many cases impossible to maintain or even temporarily to achieve single binocular vision.

Table Giving in Degrees the Elements, Exotropia, Esotropia, and Hypertropia, with the Refraction in Two Hundred Immediately Consecutive Cases of Strabismus Seen in Private Practice.

No.	Esotropia.	Exotropia.	Hypertropia.	Myopia.	Hyperopia.	Emmetropia.
1			10°			//
2			12°			//
3			20°			//
4		20°	2°	4.50		
5			7°	15.00		
6		20°	14°	6.00		
7		8°	3°			//
8		13°	2°			//
9		14°	4°	4.50		
10	18°		6°	22.00		
11	45°		10°			//
12			9°			//
13			15°		5.50	
14	30°		8°			//
15*		10°	7°			//
16	16°					//
17		28°	7°	50		
18			15°			//
19		11°	3°			//
20*		15°	20°		4.00	
21			10°			//
22	12°			3.50		
23*	37°		3°			//
24			17°			//
25	45°		7°	1.75		
26			18°	6.00		
27		35°	8°	6.00		
28			7°			//
29*		17°	19°			//
30	35°		12°		1.00	
31			10°	1.00		
32	40°		10°		4.00	
33		20°				//
34	40°		10°			//
35	18°		6°	22.00		
36	35°		7°			//
37	40°		15°			//
38*			9°			//
39	18°		1°		.50	
40			8°	1.00		
41	16°				1.50	
42		28°	7°	1.00		
43	35°		5°	19.00		
44		14°			.50	
45	6°		3°			//
46	5°		4°	11.00		
47	8°		2°		.50	
48		9°	2°		.75	
49			6°			//
50		18°			5.00	
51		11°	2°	2.00		

Cases marked by an asterisk (*) had been operated on for strabismus before consulting me.

No.	Esotropia.	Exotropia.	Hypertropia.	Myopia.	Hyperopia.	Emmetropia.
52	8°			2.75		
53		20°	4°	6.00		
54		20°	4°		.20	
55		8°	2°		2.00	
56	12°		2°		2.75	
57		14°	4°	10.00		
58		10°	2°		.50	
59		16°	8°	3.00		
60		20°	4°		2.00	
61		27°	15°			//
62		9°	20°		1.50	
63			10°		1.50	
64		7°	2°		5.00	
65		15°	2°	.50		
66		6°	20°		1.50	//
67		11°				
68	7°		2°	4.50		
69	7°		2°	.50		
70		16°	2°			
71		15°	8°	4.00		//
72	7°	10°			1.75	
73			1°	8.00		
74*			20°			//
75		14°	3°		.50	
76	50°				3.00	
77	30°			18.00		
78	20°		6°			//
79		8°	10°	8.00		
80	20°			1.25		
81		6°	12°			//
82		12°	4°			//
83	30°		8°			//
84			20°			//
85	30°		8°			//
86	12°		2°			//
87*	2°		7°	.50		
88		15°			.75	
89		16°			1.50	
90		15°			.75	
91*			15°		1.00	
92	7°		7°			//
93	16°		3°		.75	
94	19°		10°		5.00	
95*	40°		12°			//
96		20°	7°	4.00		
97	20°		3°		4.00	
98*	15°					//
99		10°			.50	
100			7°	8.00		
101		5°	6°	5.00		
102		16°	5°	2.00		
103	16°					//
104		40°			2.50	
105	40°		8°			//
106		12°			.50	
107	59°		10°		3.00	
108*		13°	8°		1.50	

Cases marked by an asterisk (*) had been operated on for strabismus before consulting me.

No.	Esotropia.	Exotropia.	Hypertropia.	Myopia.	Hyperopia.	Emmetropia.
109	26°		6°			
110		15°				//
111*		30°	10°		1.00	//
112		5°	4°			
113		45°	10°			//
114			10°	2.00		
115		6°	2°		.75	
116			8°		2.75	
117*			10°			//
118	32°		10°			//
119*			4°			//
120		30°	4°		1.00	
121	8°					//
122			6°			//
123		25°	13°		.50	
124		20°				//
125		30°		3.50		
126		28°	4°			//
127*		13°	3°		1.00	
128		20°		1.75		
129		10°	4°		1.00	
130	40°					//
131		8°	3°	14.60		
132	50°					//
133	20°		6°			//
134		20°	10°			//
135		14°		2.50		
136*		8°			2.00	
137		20°	12°			//
138		12°		3.00		
139*	15°		3°			//
140			5°	5.00		
141		13°	5°		1.00	
142*		15°			2.00	
143	35°					//
144*	18°		12°		.50	
145		17°			3.00	
146*		12°	3°			//
147		14°	2°		.50	
148		15°	12°			//
149	20°		6°		2.00	
150		12°			.50	
151		16°		1.00		
152	10°		2°			//
153		35°	12°		1.00	
154	7°		5°			//
155		25°	12°			//
156			17°	25.00		
157	35°				3.00	
158	15°				3.00	
159			11°		2.50	
160		20°	12°			//
161		4°	5°	5.00		
162	24°			13.00		
163	6°		4°		2.50	
164	35°			6.00		
165		12°	9°		.50	

Cases marked by an asterisk (*) had been operated on for strabismus before consulting me.

No.	Esotropia.	Exotropia.	Hypertropia.	Myopia.	Hyperopia.	Emmetropia.
166		16°			4.50	
167			15°		.50	
168		15°	5°		.50	
169			6°	3.00		
170		35°	8°			"
171	30°		18°	6.00		
172	40°		7°	1.75		
173		17°				"
174	37°		3°			"
175	12°		2°	2.00		
176		16°	1°		.50	
177		15°	2°	1.00		
				9.00		
178			15°		2.50	
179	50°		1°		4.50	
180		11°	4°		.50	
181		30°				"
182	15°		4°			"
183			10°			"
184			20°			"
185		20°	5°			"
186			12°		1.25	
187	25°		4°	1.25		
188*		20°	4°	4.50		
189			12°		1.00	
190		35°	10°	11.00		
191			15°			"
192	16°			.50		
193		12°			1.00	
194		12°	6°		3.50	
195*	16°				1.00	
196*			20°			"
197	45°		5°		1.00	
198		25*			4.00	
199	19°		10°			"
200			15°		.75	

NOTE.—126 has diverging strabismus, or converging, since operation, some years since. Cases marked by an asterisk (*) had been operated on for strabismus before consulting me.

Of this whole number, 200, there are 86 in which, by the numbers representing degrees, the condition of exotropia or outward turning is the predominating element of the deviation.

There are 68 cases in which, by the same indication, the condition of esotropia or inward turning is the principal element of the deviation.

In 46 cases hypertropia or strabismus sursumvergens constitutes the principal deviating element.

It is thus seen that of these consecutive cases 42 per cent. are cases of exotropia, 33½ per cent. esotropia, and 24½ per cent. are hypertropia.

Judging simply by the figures indicating the degrees of the dif-

ferent elements of the deviations, it would appear that the condition of hypertropia occurs with less frequency than either esotropia or exotropia. This would be entirely a superficial view, for a large percentage of those which, by this method of calculation, are placed in the lists of lateral deviations, is in fact made up of cases in which the element of hypertropia is most important, and, indeed, one accustomed to observe the relations between these conditions will recognize in the hypertropic condition one of the essential, if not the most essential, of the deviating elements.

For example, No. 6, with a vertical deviation of 14° , is classed with exotropia because there is a lateral deviation of 20° , but who can doubt that the latter is a swing caused by the former? In such a case, if the vertical deviation were to be fully and exactly corrected while at the same time the vertical meridians were to be made to assume a true vertical position, exotropia would at once disappear and single vision would be completely established (as was actually the case in this instance). Taking this view we should include in the list of hypertropic cases Nos. 6, 10, 11, 14, 17, 27, 30, and many others. I have, in the summary of exotropic and esotropic cases above stated, included in the numbers cases of hypertropia which, were they removed to the list of hypertropic cases, would bring the list to not less than 101 cases, or more than one-half in which hypertropia is the essential element of the deviation.

Experience has shown that in the great majority of these actual cases a correction of the hypertropia has been the only treatment required to relieve the lateral deviation, not only to appearances, but largely as shown by careful phorometric tests.

The fact of the existence of hypertropia in so many of these cases which had already been operated on by tenotomy of the interni before coming into this list is of great importance.

The table also shows the refraction of these cases, from which it appears that of the cases of exotropia, 23 are myopic, 38 hypermetropic, and 23 emmetropic. In cases of ametropia the eye having the greatest defect has been chosen as that representing the refraction.

Of the esotropia cases, 18 are myopic, 20 are hyperopic, and 29 are emmetropic.

Among the cases of hypertropia, 14 are myopic, 13 are hyperopic, and 21 are emmetropic.

These cases, therefore, do not sustain the view that converging

strabismus is caused principally by hypermetropia, nor that diverging strabismus is almost always caused by myopia. Among the cases of converging deviation, hypermetropia and myopia are almost equally frequent, while of the cases of diverging strabismus, 23 only are myopic, while 38 are hypermetropic, and 23 emmetropic. The hypermetropic cases that accord with converging squint are in a less percentage than has been found among the pupils of schools by some examiners.

SECTION IV.

TREATMENT OF STRABISMUS.

In the introduction devoted to the history of the knowledge of strabismus it has been shown how, after the trial of many unsuccessful devices, the treatment by tenotomy was introduced, first, perhaps by Taylor, of whose methods we know very little, and then by Strohmeier and Dieffenbach, who gave to the world the benefit of their researches and experiences.

From this point the investigation of the phenomena and nature of the defect proceeded rapidly, with the introduction of many advances and some retrograde movements in the treatment.

The earlier operations of Dieffenbach consisted of a section of the tendon of the rectus muscle, internal or external, not far from the sclera. The details of the procedures were complicated and imperfect, yet in many moderate cases a marked improvement in the appearance of the patient was gained. Cunier, Lucien Boyer, Liston, Bonnet, and, in America, Dix, were among the many who adopted and in some respects simplified the operations. The "cure" of strabismus quickly became a show operation, and was performed before wondering crowds. As might have been expected, the results became less and less favorable. In order to "cure" the more extravagant cases the muscle was cut farther and farther back until a "myotomy" was equivalent to a paralysis. Even worse, for the straightened eye, if it did not turn in the opposite direction during the operation, lost little time in so doing after it, and the last state of the patient was infinitely worse than the first.

The zeal in completely severing, not only the muscle itself, but all its connective tissue surroundings, so increased that it was not unusual to completely myotomize all the four recti in a single case.

Thus, Baudens¹ says that about once in twenty or thirty cases it is necessary to cut the internal, superior, and inferior recti, and he also adds that not unfrequently is it necessary to divide not only all the four recti muscles, but that the superior or inferior oblique should be divided as well.

To such extremities had these myotomies reached that at length many of the more reputable surgeons declined to operate for strabismus. Considerable reaction had already taken place when von Graefe gave the influence of his great authority to a more moderate and reasonable treatment. It was fortunate that so many had abandoned the operation, for there was no practical opposition to the method advised by von Graefe and a return to the original principles of the operation with the improved methods completely succeeded to the wild rage for myotomies.

Coincident with the return to more moderate surgical treatment, prophylactic and what were regarded as curative measures without operations were introduced, based upon the refractive or accommodative state of the eyes. Cases of intercurrent strabismus were carefully watched in the beginning in the hope of avoiding the almost inevitable permanent squint. Some of these methods are still extant, and are, at least under certain circumstances, useful. To some of these we will first direct attention.

Of these prophylactic measures, the most important, in the very early years of childhood, is restraint from the use of the eyes for close attention to any occupation demanding accurate visual adjustments at near points. It is certainly better, taking whatever view we may of the ætiology of strabismus, that the strabismic habit should not be established. Also, taking any of the more modern views, a strabismic condition being once established, it is difficult to restore the eyes to a state of perfect cöordination.

Hence, if intercurrent strabismus, even of a slight degree or of somewhat rare occurrence, is observed, the child should be discouraged from close occupations demanding the use of the eyes until it is of such an age that suitable examinations and more definite prophylactic measures can be brought to bear.

Attendance at school or kindergarten, the learning to read and write and games in which the eyes are brought into close use should be deferred, and when it is not practicable absolutely to prevent such

¹Gazette des Hôpitaux, 1841.

uses of the eyes, the hours of study or of play with near objects should be limited to the minimum.

Children subject to periodic strabismus are often, if not usually, wanting in physical force; they are known as "delicate" children, often extremely nervous and active, but rarely strong to resist unfavorable physical influences.

Such children should be sustained by a systematic regimen in regard to food, which should be nourishing and easy of digestion, and the use of tonic medicines may be required in addition to other hygienic measures. By such precautions the fixed strabismic habit may often be somewhat delayed, and thus time may be gained for more radical measures.

The views of Donders, that the hypermetropic state of the eyes is usually the cause of converging strabismus naturally led to the use of convex glasses, not only as a prophylactic means, but as a cure. We have already seen that the doctrine is not based on sufficient data; yet, without accepting the dogma of the relation between hypermetropia and converging strabismus, we may still regard the adjustment of suitable glasses for the correction of important refractive anomalies as among the most important and essential of preventive measures.

By means of the ophthalmoscope, especially by skiascopic examinations, at least conspicuous refractive anomalies may be correctly diagnosed in very young children.

The correction of such important anomalies by suitable glasses may serve several purposes. The child may, by the relief afforded by the glasses, be rendered less nervous and more vigorous. This is important, as it enables the patient to apply a greater amount of surplus energy to the muscles of the eyes. But glasses, whether convex or concave, act as prisms which may correct hyperphoria and also neutralize declinations, and it is quite possible that the prismatic influence of a pair of glasses may be sufficient to delay the permanent deviation of the eyes until a more important correction of the muscular anomaly may be instituted. Referring to page 400, the effect of a weak prism with its base down is seen to be of the most striking character. The use of such a prism after the strabismic habit has been once permanently established affords only temporary relief to the lateral deviation, the eyes returning to their incongruous relations as soon as the prism is removed. But if the prism could be used at a sufficiently early period, the occurrence of the permanent form of

deviation might often be avoided. It is evidently impossible to determine the character of the prism to be used in the cases of very young children, but if a convex spherical glass of considerable strength is required to correct a hypermetropia, the eyes themselves will soon, in a certain proportion of cases, make such a selection of the positions through which the lines of regard are to pass that effective prisms are found, not only for the correction or partial correction of hyperphoria, but for the correction of the position of the image of a vertical line upon the retina; and the effects of such corrections will go far to arrest the squinting habit.

Of late simple stereoscopic figures have been much in use to prevent the permanent deviation of the eyes of those showing signs of squint. A number of instruments on the principle of the stereoscope are made, and some practitioners believe that they have permanently prevented the threatened defect. However this may be, there can be no objection to such a method, and it may serve at least to prevent amblyopia.

Children who have reached the age of 5 or 6 years are often remarkably quick and exact in their replies to the tests for heterotropia, hence it is not difficult to introduce rational treatment at an early age. Intelligent and tractable children are, of course, able to receive earlier and better attention than those who are less under control.

We have already seen that, in general, strabismus is the surrender to the difficulties of adjustments of the vertical meridians or of the plane of vision.

The conditions are in close relation to the form and direction of the orbit, and this is itself in relation to the type of the cranium.

To suppose that by any stimulus to the nerves governing the movements of the eyes a permanent relief to this condition could be expected, would be to assume that the anatomical relations of the intra-orbital parts could be changed by such a process.

No treatment by which the development of permanent squint can be delayed can relieve the conditions on which it depends.

By one means and by one only can the unfavorable directions of the visual axes or of the vertical meridians which lead to squint be effectually prevented from inducing one or another form of injury, and that is by radically changing the anatomical relations of the muscles which give direction to the axes of the eyes or to the position of the meridians. But such radical change cannot be effectually ob-

tained by the long-established methods of severing the connections between the eyeball and the tendon of the muscle toward which the eye appears to swing, leaving the tendon to fall back in its sheath. It is only by the strict observance of the principles which have been set forth in this volume, principles based upon the mechanical tensions, not of one, but of all the muscles, not of one, but of both eyes, that the strabismic tendency can be expected to yield. It is the failure to look at strabismus from this broad view that has made it an operation for a comparative, and only comparative, cosmetic relief to an unpleasant deformity.

The object aimed at, complete binocular vision at all ordinary points, combined with the freedom from the tensions which initiate the deviations, can only be obtained by surgical means.

If it is objected that the original conditions, declinations, anophoria, katophoria, or hyperphoria, those conditions from which strabismus usually has its genesis, are normal conditions, and that surgical interference with normal though unfavorable conditions, which are very common, involves risk and is therefore unwarranted, it may be replied that the dangers attending properly executed surgical corrections of strabismus involve no more, indeed much less, risk than attends the continued existence of the defects.

SURGICAL TREATMENT OF STRABISMUS.

The location and extent of surgical means must depend on the nature and degree of the unfavorable adjustments which give rise to the deviations. The idea that a deviation toward the nose makes a lengthening of an internus or the shortening of an externus necessary, or that similar direct measures are demanded in case of an outward deviation, must, if we are to proceed by rational rather than by empirical methods, be at the outset abandoned.

The rule which should, as far as possible, govern all operations for strabismus is to dispose of the normal anomalies on which the squint depends.

These anomalies are declinations, anophoria, katophoria, and hyperphoria, the last usually depending on the first. Among the people of Anglo-Saxon lineage katophoria is rarely and perhaps never associated with converging strabismus.

These then are, in the order of their importance in a given case, the conditions to be met. Of these, declination stands first, yet, un-

fortunately, it is the only element demanding first attention which cannot always be determined or which can be determined only approximately. Strabismics, even when the extent of deviation is small, often, indeed generally, bring one and then the other eye into position for fixation, and in so doing correct, with the last fixing eye, every trace of declination. Even those who think that they see the images simultaneously in fact bring one and then the other eye to bear in rapid succession, concealing the declination. In such a case the declination is clearly seen if the small black points of soft paper, mentioned in a former section, be applied, one at the inner side of the cornea on the conjunctiva, the other at the temporal side, or two



Fig. 167.



Fig. 168.

white points on the surface of the cornea, and the two eyes are made alternately to come into fixation.

The principle which should govern in a case may be thus stated:—

The rational treatment in a case of strabismus includes only such surgical changes as would have been justifiable in the same case could the conditions have been discovered before the period when the squint became established.

An example will make this statement more clear.

Above are seen two likenesses from photographs of the same child at different periods of her life. Fig. 167 represents the child at the age of two years. In this figure no indication of squinting appears, yet each of the brows, especially the left brow, indicates the

effort to correct anophoria and positive declination of the left eye. Soon after this photograph was taken permanent squint was established as it continued and is seen at Fig. 168, which represents the child at the age of 13, when she came under treatment.

At this time there was an extremely pronounced converging squint, to appearances consisting of a deviation directly in of the right eye.

There were, however, found, on careful examination, enormous upward rotations, and poor downward rotations. If a card were interposed alternately between the object and the right and left eye, either eye, when directing the line of regard to the distant object after being excluded, moved downward as well as outward. This downward movement, when either eye came from the passive state of deviation to the active condition of fixation, was equal to about 20° of prism. The right eye deviated upward more than the left. Both eyes went up behind the card with a twist, returning to fixation with an equal torsion.

This upward tendency of both eyes was then an original condition. It did not commence with the establishment of the strabismus. It was in itself a congenital anomaly.

The treatment was directed, not to the conspicuous defect, but to an anomaly which actually existed when the first photograph (Fig. 167) was taken at the age of 2 years. That is to say, the tension of the superior rectus of each eye was somewhat relaxed, but with a view to the correction of the twisting at the same time. If the reader will turn to page 400 a copy from a photograph of the same child will be seen at Fig. 158, showing the apparent result during the progress of this treatment while yet the axes of the two eyes had not been brought quite to the same plane. A slight squint persisted which, as seen by the companion figure (Fig. 159), was relieved by a prism with its base down. A further stage in the same case after a further tenotomy of the right superior rectus, there was single binocular vision at all ordinary points of regard and a perfect freedom of movement of both eyes in every direction, a slight hyperphoria with an associated esophoria remaining.

The details of this case have been thus extensively related with the view of illustrating and emphasizing the principle stated, that the rational treatment of strabismus should deal with original causes, causes which existed before the development of the squint.

Since the study of the influence of declinations has been carried

beyond the point to which it had been brought at the time of the treatment of this case, it has become evident that the treatment of anophoria simply is not in most cases sufficient, and in such a case as that just related much may now be accomplished in the way of correction of declinations.

Tenotomies of the superior recti of sufficient extent to fully correct a very high anotropia are operations involving great risk of inducing a tilting of the meridians and are, therefore, notwithstanding the satisfactory result of some such cases, to be avoided. Slight relaxations of the superior recti, involving generally not more than 5° or 6° , may be done in these extreme cases, provided the surgeon is sure of the pre-existing declinations, and is careful to work toward their elimination. The same precaution is needed in cases of hyperphoria. In exophoria with katophoria tenotomy of the inferior recti is an operation involving great risk, and is better avoided, since a contraction of the superior recti can be done instead.

When all has been accomplished by the rational method that seems practicable, or when, in the absence of evidence in regard to the declinations it is impossible to proceed in this direction, the empirical method may be resorted to for a part of the work only.

The principle governing all the operations should be those which are described for heterophoria and declination. *In no case should a tendon be severed* from the eyeball and permitted to fall back without restraint.

THE EMPIRICAL METHOD.

In a considerable proportion of cases of strabismus no tests except those which can be made by the tropometer or by that of deviation in exclusion are practical.

In such cases, after such measures as may be demanded in case of anotropia or hypertropia have been taken, it may be necessary to bring the eyes into closer relation before any further steps in what we have called the rational method can be taken. It is then necessary to accept the empirical method, not with the view to final work, but in the hope of obtaining data on which to complete the work according to the rational method.

In a case of converging squint, for example, with amblyopia of one eye and a persistent refusal to recognize diplopia, we may do a moderate tenotomy equally for each internus, not by any means sufficient to correct the deviation and especially not to the extent of

impairing the inward rotations of either eye, maintaining at least a rotation of 50° to the medial side. Even this empirical operation may be modified to a certain degree by observing the roll of the eye when the bits of black paper are applied to the conjunctiva.

By such means the strabismus may be to such an extent modified that proper tests can be made and the further correction may be carried on by rational methods.

Again, if time presses and a correction by the rational method has been well advanced, it may be excusable to adopt the empirical method for a completion of the case, care being observed to divide the relaxations equally between the eyes and to preserve full rotation for each.

Of course, a contraction of an externus for converging strabismus may be done in place of a relaxation of an internus, and conversely, for exotropia, contraction of the internus is in almost all cases preferable to tenotomy of the externus. In exotropia, moreover, it is generally safe to assume a positive declination of each eye, and in contracting the tendon the contraction may be done at the superior part of the tendon, thus relieving an assumed declination while the eyes are caused to approach.

If sufficient time is given to the treatment of a case of converging strabismus it will be rare that occasion will require a tenotomy of either internus or a contraction of the externus beyond a very slight modification, which may be required for finishing the correction. This element of time should always, when possible, be respected. It is better to devote several months to the rational treatment of such a defect than to give only apparent relief by adopting an empirical method.

SECTION LVI.

RESULTS OF TREATMENT OF STRABISMUS.

The first element of reliability in regard to the reported results of strabismus must depend upon exact methods of measuring the conditions with which we are dealing. Many authors who have written on strabismus have reported results which could scarcely be repeated by the same methods if the exact conditions before and after such treatment were to be taken fully into consideration, as they might now be by precise methods of examination.

To assume that a strabismus is cured because the patient looks

less "cross-eyed" to friends is, of course, wide of the mark. Scarcely less crude, however, is the method which has been prevalent of asking the patient to look at a finger, a pencil, etc., and tell whether one or two images of the object can be seen.

The stereoscope has been used to learn whether the patient can unite the pictures. If, for example, a figure representing the letter F on one side and the letter L on the other can be so united as to form the letter E it has been supposed that the presence of single vision is proved. This is far from being the case. The stereoscope in its usual form contains a prism of about 7° in each side, in all 14° , and this, with a convergence equal to more than 20° of prism, might represent a converging strabismus still remaining, which, measured at twenty feet, would require prisms equal to 30° to correct. But this is not all. Many persons, especially those who have a moderate strabismus, acquire a faculty of uniting mentally the results of movements of the eyes which are not exactly simultaneous. Estimates of position and of the third dimension can be made by these people, and the fact that they see two such figures as above referred to as a complete letter, of which these two are elements, is no proof under these circumstances that the images are seen simultaneously.

Hering's test in case of persons who have had strabismus may have little value even with many trials, and at best can only determine the fact of binocular vision without indicating its difficulties. It has no significance when the questions of rotation, heterophoria, or other moderate disabilities are concerned.

Tests made in the same manner as in cases of heterophoria are by far more reliable than all others. If the patient cannot locate the images with the phorometer it may as well be conceded that he has not binocular single vision.

SECTION LVII.

RESUMÉ OF THE OPERATIVE TREATMENT OF STRABISMUS.

We may arrange and condense what has been said in regard to operative treatment so as to present a comprehensive view in a few paragraphs.

Let it be assumed that the case in hand is one of converging strabismus of rather more than a moderate extent, and that there is

ability on the part of the more amblyopic eye to see and to form a judgment as to the form and direction of a well-defined object, as, for example, the flame of a candle.

After obtaining a general history, examining with the ophthalmoscope and determining the refraction, the tests by exclusion are employed as those most likely to give a general impression of the elements of the defects.

The tropometer is then brought into requisition to determine the extent of the rotations in different directions. The upward rotation is likely to be very great and the inward rather greater than usual, while the outward rotation is somewhat less than usual.

An attempt is then to be made to determine the elements of the heterotropia by means of a red glass and, if necessary, prisms. If the patient persists in his opinion that he can see only one image after a reasonable trial under any circumstances, it is best, after the next step in the examination, to wait a day for further examination. The next step is to examine by the clinoscope. Some patients who absolutely refuse to acknowledge diplopia will recognize the two pointers of the lens clinoscope. When this can be done an important step in advance has been taken. Yet it is to be remembered (Section LV) that such patients often appear to present a record in respect to declination much more correct than the average non-strabismic person. This apparent correction is the result of alternate, though perhaps very rapidly alternate, fixation, the vertical meridian of the eye in each instance adjusting itself accurately to the vertical position. Such records cannot be true. And whether the patient sees in this way or fails to recognize the two images it is necessary beyond all things to form at least an approximate estimate of the directions of the declinations, for it must be assumed, not only that there are declinations, but very important ones. If the clinoscope or lens clinoscope gives no information, resort may be had to the bits of black paper on the surface of the eye. By causing the eye to alternately fix and pass into the squinting position the direction of the leaning of the meridian may be determined.

In about four cases out of five with converging strabismus, the right meridian will be found to lean in and the left out at the top.

These examinations should always be repeated, if possible, on several successive days.

Assuming that a high rotation for both eyes has been found, that the images are nearly in the same plane and that there is a nega-

tive declination of one eye and a positive declination of the other, the first step in the operative correction may be taken by a careful reduction of the anophoria by a graduated tenotomy of the superior rectus of each eye, the dissection of the insertion of the tendon being carried to the nasal side of the tendon of the eye with the positive declination, while the outer border is carefully preserved. The inner border of the insertion is preserved on the eye with negative declination. Both may be done at one sitting or on different days.

If this step has been taken with sufficient care some modification of the strabismus may be hoped for, but if there is still doubt as to the elements of the defect, a carefully graduated tenotomy of each internus may be resorted to, but not to the extent of a correction of the squint. Such tenotomies are only intended to enable the operator to obtain more correct data by which to complete his operations without injury to the rotating ability of any muscle, and with the final result of a removal of the underlying conditions which induced the esotropia.

This procedure is not as easy as it is to look at a squinting eye, see that it turns in, and sever an internus or contract an externus muscle.

Detail of procedure must be varied according to the judgment of the surgeon. The important principle never to be lost sight of is to induce only such corrections as would have been legitimate had the squint never occurred.

It is a complicated and difficult procedure, demanding patience, time, and good judgment. But it has its reward in a result which is more than a cosmetic improvement of rather doubtful quality. It is the correct procedure if it is not the rapid one.

I venture to introduce two illustrations from photographs of persons who have been subjected to the standard operations for converging squint, an operation in which the principles which I have urged are disregarded. These are fair representations of a very large class, not necessarily of those who have fallen into incompetent hands, for both of these cases were patients of most distinguished surgeons, and the unfortunate results such as those here represented are found about as often as the sequelæ of operations by highly trained and justly respected surgeons, as of operations by the itinerant oculist. Such results are the legitimate consequences of the standard operation for squint, and the only cause of surprise at the effects here shown is that they are not much more frequent than they actually are. Many

cases, however, by reason of the enormous declination, retain the tendency to squint in, as the case shown at page 401, notwithstanding the great disability induced in one or both internal recti.



Fig. 169.



Fig. 170.

Results of Over-correction of Converging Strabismus.

SECTION LVIII.

“ANTIPATHY TO SINGLE VISION.”

In von Graefe's classical description of the condition to which he applies the term “Antipathy to Single Vision,” he says: “It has sometimes happened to me that after squint operations with apparently correctly adjusted visual axes, there have resulted double images only slightly removed from each other. The visual power of each eye has been quite good, *alternating strabismus having previously existed*, and the accommodative power has been similar in the two eyes; nevertheless, it has been in no way possible to bring about single vision.”¹

¹“Es ist mir nämlich einige Male nach Schieloperationen vorgekommen, dass bei ziemlich richtiger Einstellung der Sehachsen sich eine Diplopie mit wenig distanten Doppelbildern zeigte. Das Sehvermögen war beiderseits gleich gut, wie auch alternirendes Schielen vorangegangen war, auch in den akkomodativen Verhältnissen war kein Unterschied zwischen beiden Augen nachweisbar, dennoch gelang es auf keine Weise, Einfachsehen herbeizuführen.” (Archiv-für Ophthalmologie, i, 1, 117.)

He remarks that this condition of double seeing persists notwithstanding the interposition of prisms in various positions, and that every effort of the patient to unite the images results only in removing them to still greater distances.

He adds: "The tendency appears to be a direct physiological contradiction, for while in sound eyes some approach, especially in case of large retinal pictures, is sufficient to induce arbitrary muscle contraction in the interest of single vision, in these cases, on the other hand, it is found that exactly the opposite condition prevails, there being an absolute incompatibility to single vision."¹

In a still later article² he describes the condition more at length, pointing out the fact that the double images, although not far removed, pass from one side to the other above and below or one behind the other, always on the point of uniting, but never united. Von Graefe explains the anomaly on the theory, first, of injury to the nervous centers, and second, of the supposed difficulty of obtaining regular associated action between muscles which have long been unused to association.

A careful examination of these cases of "antipathy to single vision" leads me to conclusions widely different from those arrived at by von Graefe.

In a paper read before the American Medical Association, June, 1889, I expressed my disbelief in the generally accepted view of the existence of a physiological antipathy to single vision and my conviction that, by properly selected and properly executed proceedings, this unpleasant condition may usually be eliminated.

The condition of antipathy to single vision, as described by von Graefe and by subsequent authors, depends not upon lesion of the brain or faulty projection of the images of the retina, but upon non-corresponding actions of the muscles under the influence of corresponding nerve impulses directed to them. The condition *is entirely one induced by the operation*, and in most individual cases it can be so studied that the reasons for the loss of harmony can be discovered.

Without giving too much space to the subject it may be briefly

¹"Die Tendenz schien hier wirklich eine der physiologischen diametral entgegengesetzte: während bei gesunden Augen nur eine Annäherung besonders bei grossem Netzhautbilde genügt, um willkürliche Muskelkontraktion in Dienste des Einfachsehens hervorzurufen, fand in diesen Fällen, als wenn die Augen für das Einfachsehen platterdings mit einander unverträgliche waren gerade das umgekehrte Verhältniss statt. (Archiv für Ophthalmologie, i, 1, 118).

² Arch. für Ophthalmol., iii, 1.

stated that such antipathy to single vision rarely occurs except when the rotations of the two eyes have been made very unequal for the two eyes; and again, unless by the operation a high degree of acquired declination has been induced, no such antipathy to single vision will result. It follows that, in order to relieve the patient of the great annoyance of diplopia, it will be necessary to restore comparative equality of action for the two interni (or externi if they are the disabled muscles), and at the same time any leaning of the images must be corrected.

An example of this defect and a study of its elements with the progress in treatment will better serve to point out the principles governing the existence of the conditions, the examinations required, and the course of treatment than a long discussion of these conditions. (Page 401.)

The portraits shown at Figs. 160, 161, and 162 show the condition of the eyes of Miss W. when she consulted me in January, 1903.

She had been operated on some years before for converging strabismus and had suffered much from chorea and general nervousness ever since.

Examinations showed that she was using glasses $s + 3.50$, $cyl + .75$, axis: R. 180, L. 70, and that with these there was diverging strabismus, the right eye turning out, the left habitually in fixation. Removing her glasses, converging strabismus at once occurred, as shown at Fig. 160, with the left in fixation, the right turning in. The eyes were disagreeably goggled and expressionless. On causing the eyes to move from side to side it was seen that the right cornea rotated well into the inner canthus, while the left nasal rotation showed very marked restriction. The tropometer showed rotations: Right, in 60° , out 40° ; left, in 28° , out 60° ; up, each 43° ; down, 40° .

She had diplopia with or without glasses, homonymous without, crossed with them on, but if she fixed the right eye when the glasses were off the diplopia was *crossed*, while if the same eye was fixed when the glasses were in place, the diplopia was homonymous. Thus exactly the reverse form of diplopia occurred, depending on whether the glasses were on or off.

Looking at a distant point of light, if a card were slipped in front of the fixing eye (either right or left) the other eye moved distinctly down and out for fixation, the downward motion being as

pronounced as the other. No prisms brought the images into closer relation than existed without. If prisms up to 25° base out were placed before the eyes, half the prisms before each eye, the images remained homonymous, apparently fifteen inches apart, then suddenly passed over to crossed positions. An increase or decrease of the prism induced only the modification in the character, not in the degree of diplopia. At one time 10° left hypertropia was shown, the next moment an equal right hypertropia was manifest.

The tests by the lens clinoscope were not satisfactory, but appeared to show an important negative declination of each eye.

With certain prisms the in and out and up and down movements could be considerably neutralized in the test for deviation in exclusion; then an axial rotation was much more apparent than at other times.

In order to bring about a relation of the eyes in which some more definite tests could be made, on the third visit an advancement of the internus of the left eye (the tendon which had been severed) was done. After a few days the nasal rotation of that eye had greatly improved. It then appeared that there was decided negative declination (5° or more or less) of the right eye and slight positive declination of the left. These tests were too uncertain to be fully relied on, but a moderate change in the direction of the insertion of the superior rectus, right eye, brought about a marked improvement in the appearance of the eyes and images could be for a short time united.

After a few days still further correction for declination was obtained, after which the images could be held indefinitely in union.

The experience related above is not exceptional; indeed, it is common, and the results may be summed up in the statement that the lateral rotations have been rendered disproportionate and the effects of declination increased as a result of operations. The remedy consists in equalizing the rotations and in reducing the declinations.

In concluding this section it seems desirable to add some paragraphs taken from an article contributed by me to *Archives of Ophthalmology* in 1891.¹ Although the views of the causes of the antipathy to single vision have been materially modified during the fourteen years since the appearance of that article, since they have

¹ *Archives of Ophthalmology*, vol. xx, No. 3, 1891.

been studied in connection with declinations and the conditions revealed by the tropometer, as well as with those conditions recognized at the time of writing, the facts exhibited are so interesting that I am induced to transcribe them without change. The reader who has become familiar with the principles discussed in the preceding sections will be prepared to modify the conclusions according to the more recent observations of facts.

A causative influence, and one which acts as an element in nearly all of these cases, is the difference in relative tension of muscles which act in the vertical direction.

We have seen that the influence inducing hyperphoria is often, if not always, in the character of declinations, and where in the following few pages to hyperphoria are attributed certain peculiarities of action, it will be observed that the condition underlying the hyperphoria may even more effectually explain these peculiarities.

"The instinct of bringing images to the same horizontal plane appears to be very great and only second, if indeed it is second, to that of union of images. In case of double images, whatever the difficulty of blending may be, the patient instinctively exerts his best endeavors to place the images in the same horizontal plane. It thus happens, that in certain cases in which, either with or without slight lateral inequality of tension, the effort to bring images to the same plane induces a lateral squint,—a squint which may be variable; that is, such a squint may at one period of life be converging, and at another diverging. Thus, in a case now under my observation, the patient was, during her childhood, subject to a very pronounced converging squint. During the past twenty years she has had conspicuous diverging squint, although no operation has been done. Such a condition may properly be called *variable strabismus*, its character of divergence or convergence changing from time to time, remaining possibly in one direction during several years, then changing to the opposite direction.

"If in such a case one or both interni or externi are cut, double vision of an intractable form is likely to result. In such cases we must make diligent search for the vertical deviation, a condition often obscure or not at all manifest, before we can succeed in establishing binocular vision.

"I have had the good fortune to obtain a daguerreotype portrait of the lady whose case has just been mentioned, taken during her childhood. (Fig. 171.) The picture shows converging

squint, so pronounced that few ophthalmic surgeons even at the present day would hesitate in regarding it as a proper case for a free division of the internus of one, if not of both eyes. Had such an operation been performed upon this patient in early life, intractable diplopia would doubtless have resulted, and eventually extreme



Fig. 171.—A Case of Converging Strabismus which Changed to Diverging Strabismus in Later Life.

diverging strabismus. In another, photographic, portrait of this lady, made by myself a few years ago (Fig. 172), a moderate appearance of diverging strabismus is seen. In fact a divergence of more than 12° with corresponding crossed diplopia existed. But the most striking

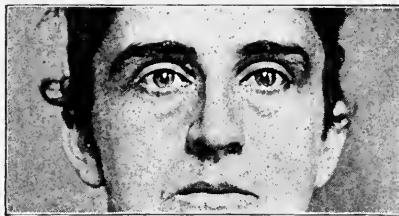

Fig. 172.—Slight Diverging Strabismus Succeeding the Convergence Seen at Fig. 171.

feature suggested by this photograph is the left hypertropia, well defined in the position of the eyes and of the brows. The question at once arises whether the change from converging to diverging strabismus is not the result of some radical change in the static condition of the eye-muscles. That this is not the case will be seen by

the most cursory glance at the third portrait (Fig. 173), in which the old converging squint has returned. This condition of convergence can be induced at any time by the application of a solution of atropine to the eyes. At the time of taking this third portrait, atropine had been applied twice a day for three successive days, and its effects were complete. A week after that time the diverging squint had returned and has continued during the year. The transformation from divergence to convergence occurs within an hour after the first application of the atropine, and the present habitual condition of divergence returns as soon as the effect of the drug passes off. This variableness is, without doubt, due to the action of the muscles in the effort to overcome the unequal height of the images, and until



Fig. 173.—Diverging Strabismus Converted into the Converging Form by the Instillation of Atropine.

the condition of the hypertropia is eliminated such changes of the lateral relations are liable to occur.¹ In passing, a single thought may be given to the adverse testimony of such cases to the well-known doctrine of the relations between the excessive efforts at accommodation and converging strabismus; for here the converging strabismus occurs only when accommodation is neutralized. The present interest in the case centers in the fact that had a free tenotomy of an internus been practiced during childhood, the almost certain result would have been an "antipathy to single vision." Even at the present time, when the conditions of hyperphoria and hypertropia are carefully sought for, this patient is able, under many circumstances, to conceal completely the evidence of hyperphoria as shown by the phorometer.

"A curious fact in connection with the inequality of tension of

¹The reader must remember that at the time at which this was written the influence of declinations had not been studied, and what is here attributed to hyperphoria might better be explained by considering that in one condition of deviation a + and in the other a - declination was being corrected.

the lateral muscles associated with hyperphoria is that a condition which in a passive state of the muscles of either eye or of both eyes is a marked divergence, becomes, as soon as all the muscles are engaged in the act of adjustment, pronounced convergence attended by homonymous diplopia. Conversely, a like change may occur when the tendency is, in the passive state, to converge.

“A very practical illustration of what has been stated may be found in an actual history which I condense for this purpose. In a child with left hyperphoria (or hypertropia) the left eye drifted outward during the first few years of life. (Such a diverging squint is rarely observed by parents unless it is extreme.) At length, pre-

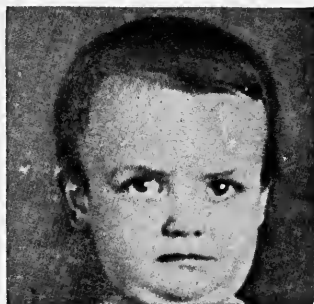

Fig. 174.—Diverging Strabismus which in Youth Became Marked Converging Squint.

sumably as the result of a change in the methods of making the efforts to adjust for the horizontal plane, the squint became convergent. The appearance of the eyes of this patient in early childhood is represented in Fig. 174, which is copied and enlarged from a daguerreotype picture of him taken at the age of about three years.

“About three or four years later, and after the divergence had given place to convergence, a surgeon performed tenotomies of the two recti interni, presumably severing both tendons completely. The result proving an over-correction, the effect of the operation on one eye was modified by the insertion of a (conjunctival?) suture. The result, in view of what has been stated above, was such as we might anticipate. Double vision of the most annoying character was always present. The efforts of many distinguished surgeons to induce these twin images to unite by means of prisms, even for an instant, were fruitless after trials repeated during many years. The case found a

prominent place in ophthalmological literature, endorsed by several distinguished surgeons, as one of the class now under discussion. No case could therefore afford us a better model for our study.

“It proved easier for this patient to fix objects with the left eye. That being the case, we may suppose that he would make a certain effort of adjustment with the weakened internus of that eye, which would be associated with a corresponding excessive effort of the opposite internus. But these unequal efforts would also be combined with the effort to adjust for the difference in the positions of the images with reference to the horizontal plane. The result would be an excessive rotation of the right eye to the nasal side with homonymous double images. If, on the other hand, a patient with this combination of defects should look at an object which is isolated from other objects which may serve to aid the disabled eye in active adjustment, as, for instance, at a church spire, or at the moon, or a bright star, in which cases only the clear sky is in immediate relation to the object, the most disabled eye would at once drift outward, and crossed diplopia would result. So also, if a small screen were to be interposed between either eye and the object looked at, thus shutting it out from active participation in the effort of adjustment, the covered eye would diverge in a marked manner and would move inward, perhaps to the extent of one-third the diameter of the cornea, as soon as the screen should be removed, and then homonymous diplopia would be observed. Or again, if the subject of such defect were to look through a grating, as, for instance, through the palings of a picket fence, an object seen beyond the fence would be seen doubled, and the diplopia would be crossed; while an object seen between the person and the fence would be double also, but the double images would be homonymous. In the first instance, looking beyond the fence, the adjusting energy of one eye becomes passive, as in the case of looking at the object against the clear sky, with resulting crossed diplopia. In the other instance, looking at the object nearer than the fence, active adjustment of both eyes occurs with excessive convergence and homonymous double images. All these suppositions and conclusions have been fully justified in the actual treatment of these cases.

“In certain cases in which this intractable diplopia exists, the patient has the extraordinary faculty of selecting at will which eye shall fix the object, and the diplopia becomes homonymous or crossed, according as the one or the other eye is engaged in direct fixation.

Thus, in the case of a lady patient, if I direct her to look with the right eye, I can see that the eyes are strongly converged, and she reports the presence of homonymous double images. If I then direct her to look with the left eye, the change may require a few seconds or it may take place very quickly. Then the eyes are plainly seen to diverge, and the diplopia is crossed. In such a case, the nervous impulse directed to the right internus is greater than the normal during fixation with that eye, and when a corresponding impulse is sent to the left internus, the eye is caused to swing in excessively and too great convergence results. On the contrary, when the left eye is fixed, there is no such excess of nervous impulse sent to the left internus, and as no excessive impulse is therefore sent to the right internus, that eye swings outward passively, and crossing of images results. But in this explanation we must not lose sight of the important, probably the most important, element in the causation of the inward swing in many if not in the majority of cases. This is the influence of the difference of tension of the muscles which move the eyes in the vertical direction. This influence is often sufficient, even though the moving power of the corresponding lateral muscles should be equal, to cause a swing beyond that which would result from a given impulse to a lateral muscle. I have rarely met with a case of the so-called "antipathy to single vision" in which this element did not play an important rôle.

"It needs no argument to show that the defect which causes the patient to have homonymous diplopia when looking at an object, say at twenty feet distance, and heteronymous diplopia when looking at the same object, if a grating, like the fence of which we have spoken, is interposed between the eyes and the object, or which causes the same patient to have homonymous images when looking at an object isolated from visible surroundings, lies neither in the brain nor in faulty projection from the retina, but in peculiar, although perhaps obscure, defects in the adjusting apparatus.

"Homonymous diplopia caused by a brain defect or a retinal defect would remain homonymous under all the circumstances which have just been mentioned. Activity or passivity of certain efforts of adjustment could and would be modified by the circumstances mentioned, and the phenomena resulting, which at first appear confused and irregular, are in reality uniform and in accordance with fixed laws."

SECTION LIX.

THIRD DIVISION.

*Class IV.*NYSTAGMUS.¹ TALANTROPIA.²

The term nystagmus, as used in ophthalmology, is applied not only to the involuntary oscillations of the globe of the eye which are habitual and, in waking hours, constant with some persons in health, and which continue in most cases for a lifetime, but to the spasmodic twitchings which are the result of disease of the brain cortex. Neither the nature of the affections nor their manifestations are alike, yet the same term has been applied to both.

Considering this fact, and in view of the advantage of placing each of these forms of ocular affection in its own appropriate relations to other motile irregularities, no excuse would seem to be required for the introduction of a new term for one of the affections. Since the system of classification adopted in this work is best served by applying the new term to the functional form, I have suggested one which is at least as appropriate as the one in common use.

The term talantropia, then, is proposed to be applied to involuntary oscillations of the globe of the eye not depending on cortical lesions, whether from side to side, in a vertical direction or about the antero-posterior axis of the eye.

The term *talantropia*, according to this suggestion, signifies an oscillating turning of the eye as distinguished from the twitching side to side movements of the eyes from cortical disease or pressure.

In certain particulars these talantropic oscillations are alike. They are generally constant when the eyes are in fixation, they increase with an increase of the effort at fixation, and they are greater when the eyes are turned in certain directions than when they are directed in others. In sleep they disappear.

While talantropic nystagmus is not in itself a disease, it is often the result of disease, and in almost every instance of long standing is associated with marked reduction of visual power.

The oscillatory movements are, the to and fro movements from

¹ From *νευστάζειν*, to nod in sleep.

² From *τάλαντῶδης*, an oscillating.

side to side, the *horizontal nystagmus* or *horizontal talantropia*; the rotatory movements about the optic axis, *rotatory nystagmus*; and the movements nearly in a vertical direction, *vertical nystagmus*, a less common form than the others, but especially noticeable among miners.

There are also many cases in which the vertical or the horizontal oscillations are mixed with the rotatory movements, and occasionally the horizontal and vertical forms combine as an oblique form.

Neither the vertical nor the horizontal varieties are often seen as pure forms, cases being much more frequently of a mixed character. In both of these mixed forms, however, the horizontal or the vertical oscillations are often so conspicuously predominant that the rotatory movement, which complicates many cases, is with difficulty recognized.

The movements are usually quite rhythmic, though not for considerable periods of time uniformly so. If the gaze is indifferently fixed, the rapidity of the oscillations and their extent may be much less than when the attention is definitely fixed upon an object. On the whole, the rapidity of movements is, within limits, in some degree uniform in the same individual. If the excursions are long and the oscillations comparatively slow they do not often in this individual case rise to extremely short and rapid movements.

However slow the movements may appear or however slight by ordinary inspection, when the eye is examined by the ophthalmoscope it appears to move with immense rapidity and to a great extent.

The oscillations are, in by far the greatest number of cases, common to the two eyes, yet cases occur in which only one eye is affected.

Nettleship¹ mentions three brothers (children) all of whom had unilateral nystagmus, and of whom two had fits and strabismus.

In another case, an infant, there was unilateral nystagmus with rhythmical movements of the head and the corresponding arm.

Soelberg Wells² also mentions a case of vertical nystagmus ("the only case of vertical oscillation with which he had ever met"), which was confined to one eye.

While objects are seen in their appropriate form by those who have binocular single vision, the form of the object appears to un-

¹ Ophthalmic Hospital Reports, xi, p. 75.

² "Treatise on the Diseases of the Eye," p. 569. Zehender also describes a case of unilateral nystagmus in a child (Klinische Monatsblätter, 1870, p. 112).

dergo a change when the images are separated, as they may be with a prism. In that case the image of a candle flame, for example, is with the horizontal variety, very markedly broadened, while in the rotatory form it is enlarged in all directions. This fact is sometimes helpful in determining the special form of the oscillation in the two eyes, and Alfred Graefe has reported a case in which by this means he was able to demonstrate the existence of the vertical form in one eye and the horizontal in the other.¹

Other cases have been reported in which quite anomalous forms of oscillation have been observed.²

The affection may commence very early in life, so early as to be observed as soon as the child begins to look about. Such cases are usually, though it appears to me with too little reason, regarded as congenital. Other cases are acquired later in life. This is especially the case with the nystagmus of miners, with the nystagmus of paralysis, and with some cases of the nystagmus of disseminated myelitis.

The case of Nettleship, in which there was, associated with the movements of the eyes, rhythmic movements of the head and arm, is an example of a form of the affection not very rare. The association also of epileptic and other important nervous troubles is not uncommon.

Apparent movement of objects corresponding to the movements of the eyes, while not common, have been observed from time to time.

A. V. Reuss³ reports two such instances, both in young children, in which the subjective movements of objects corresponded closely with the swing of the eyes. Snell⁴ also mentions the case of an acquired nystagmus, to which reference will again be made, in which objects appeared to move up and down. Such subjective movements are also sometimes observed in the nystagmus of miners.

I have met with a number of cases of albinism associated with talantropia, and, indeed, nystagmus may be regarded as a nearly constant attendant on albinism. The affection is often associated with microphthalmus and other degenerate forms of the eyes.

Talantropia is not unfrequently found in connection with con-

¹ Graefe und Saemisch: "Handbuch." vi, 1.

² In the *British Medical Journal*, 1892, J. D. Bell, W. T. Conkling, J. Court, H. B. Hewitson, Simeon Snell, and G. W. Thomson discuss nystagmus, their contributions indicating a considerable diversity of opinion.

³ *Centralblatt für Prak. Augenheilkunde*, March, 1881.

⁴ "Transactions of the Ophthalmological Society of the United Kingdom," 1891.

genital cataract, leucoma from early life, pigmentary retinitis with central scotoma, and other lesions of the media occurring at a very early age.

In most cases of paralysis of the eye muscles there exists a temporary oscillation when the attempt is made to turn the eye in the direction of the affected muscle.

Conspicuous among the diseases of the nervous centers in which nystagmus plays an important rôle is the disease known as *disseminated nodular sclerosis (sclérose en plaques)*. This disease, which is peculiar to young persons, was first described by Charcôt and Vulpian in 1866. It is characterized by a tremor which comes on with an intended movement and increases as the movement, for example, of the arm or hand, becomes more and more specialized.

A tremor of the eyes, a nystagmus, increasing with efforts at fixation, is one of the conspicuous and almost constant symptoms of the disease, although cases have occurred in which the tremor of the eyes has been absent. It is also sometimes an accompaniment of hysteria.¹

Talantropia may occur in several members of one family. In 1880 three members of one family, a brother and two sisters, who were under my care, were subjects of the affection, and I saw two young cousins of these, a boy and a girl, who were also affected in like manner. In all these five cases there was a high degree of astigmatism, but the oscillation of the eyes is in only a moderate per cent. of cases associated with pronounced astigmatism.

Cases of talantropia acquired in adult age are more instructive in respect to the origin and nature of the affection than those which occur in the first years of life.

In the most of these acquired cases the trouble has arisen as the result of prolonged and strenuous effort directed to the elevator muscles of the eyes.

Dr. Simeon Snell reports² an interesting case of acquired nystagmus in the person of a compositor. The trouble had only been observed a few days when the patient first consulted Dr. Snell. He had retired at night apparently well, and on rising in the morning saw all surrounding objects moving vertically. The movements of oscillation were, like the subjective movements, vertical and extremely rapid.

¹ Dr. J. Santos Fernandio, Havana.

² "Ophthalmic Society of the United Kingdom Report for 1891."

Dr. Snell visited the rooms where the patient was accustomed to work and found them well lighted. He observed that the man was accustomed to look strongly upward at his copy instead of raising the head.

There was improvement after a few days of rest.

Among the various avocations probably none in which large numbers of men are employed demand from the men so great strain on the elevator muscles of the eyes, under unfavorable conditions, as does that of operating in coal mines. Hence, in recent years much interest has been aroused in what is known as the "nystagmus of miners."

Nieden¹ stated in 1881 that he had examined 7416 miners and that he had found nystagmus 299 times or 4.3 per cent. of the whole. This large per cent. he had found only in certain mines where the conditions of light and space were extremely bad.

Decodé was the first to mention the affection in connection with miners,² but he mentioned only two cases. Alfred Graefe,³ in 1875, mentions three cases, and Neiden,⁴ Noel,⁵ and others soon added to the lists.

Dr. Dransart⁶ was able to collect 12 cases from the miners of Anzin, and he has given an excellent account of the affection.

He concludes that the nystagmus of miners is the result of a myopathy of the elevator muscles of the eyes (the superior recti, the inferior oblique, and he adds, the internal rectus), being related more or less intimately with the anemia induced by the environments of the miners, and with the paresis of accommodation.

The motions of this nystagmus are both horizontal and vertical.

According to Dransart, when the eyes are directed down the oscillations disappear and the eyes seem normal.

The nystagmus only occurs when the line of regard is directed above the horizontal plane.

The introduction then, according to this author, into the field of action of the group of elevators of the eyes, is the efficient cause of the oscillations. Other conditions cease to act as soon as this direction of the eyes above the plane of the horizon is discontinued.

¹ "Proceedings of the International Medical Congress," London, 1881, vol. iii, p. 89.

² Decodé, in Arch. Belg. de Med. Mil., 1861. T. 27, p. 337.

³ Graefe und Saemisch: "Handbuch."

⁴ Berlin. Klin. Wochens., 1874.

⁵ An. d'Oculist., 1874.

⁶ An. d'Oculist., September, 1887.

Alfred Graefe also speaks of the increase of the oscillations when his patients looked up.

If the circumstances under which the miners work are considered, the facts related by these authors are explained.

Walking in the mines often requires the miners to stoop, as the walls are low. This causes them to look up from the brows. At their work also they are forced not only to look up as far as possible, but to look into an obscure place. The passages in which the men work are often very low and the light given by the Davy lamp very feeble. Thus the line of regard is directed up with much force and all the adjustments are made under marked disadvantages.

The state of the air, the absence of sunlight, and other unsanitary conditions of the mines tend to reduce the strength of the men, and they therefore become easy victims of the nervous spasm of the eye muscles.

Dransart says that he has seen a number of these cases who have had paresis of the superior recti or inferior obliques.

Men who work in the mines, but who do not use the pick, and who are therefore not obliged to strain the eyes upward to such an extent as do the others, are not peculiarly subject to the affection.

The affection as it occurs among miners has been dwelt upon at some length here inasmuch as the history and phenomena of these acquired cases appear to throw much light upon the ætiology of the class of cases which occur in very early life and which continue under ordinary circumstances.

These persons are not, as a rule, forced by their occupations to look far above the horizontal plane; they direct the eyes like the majority of people, mostly below the plane of the horizon.

Although nystagmus is probably in all cases acquired, it may be convenient to speak of those cases which occur very early in life as idiopathic, while those which do not occur until adult years and those which arise from pathological conditions are spoken of as acquired.

Investigations in my own cases have shown that there exist in the idiopathic cases very unusual tensions of the vertically acting muscles always combined with high degrees of declination. Thus, in the cases which have existed from the early periods of life the subjects of the affection are required to make the most strenuous efforts in the adjustments of the eyes.

Since it has been practicable to examine these cases by the aid of the tropometer and the clinoscope, it has been possible in quite a

number of instances to bring about a very notable reduction of the oscillations.

In the case of a lad, for example, who had nystagmus in an extreme form the upward rotations of each eye exceeded 50° , while the rotation downward did not exceed 35° . A careful relaxation of each of the superior recti reducing the upward rotation to 45° and increasing the downward rotation to 40° , the oscillations were so greatly reduced that the parents of the lad regarded him as cured, although in steady fixation there could still be seen a slight oscillation.

On the other hand, in a case under the care of my son, Dr. Charles W. Stevens, the upward rotation was less than 25° for each eye with marked declination. A relaxation of the inferior recti permitting of a rotation upward of 29° , each eye, relieved the nystagmus permanently except when the gaze is directed considerably above the horizon. In both these instances, with the modification of the rotations, the declination was also modified.

These are cases which are fairly representative of a considerable number, but it has not in any of the cases seemed practicable to carry the correction of the rotations to the typical extent, and as the declinations in all these cases have been too extreme to yield fully to the efforts at correction, there has, as yet, resulted in no instance an absolute cure of the oscillations.

I am confident that the hope for relief in these so-called idiopathic cases must be based on the result of efforts to improve the rotations of the eyes and to remove, so far as practicable, the declination.

In cases of congenital cataract, of leucoma, and of pigmentary retinitis, scotoma, etc., there would appear to be only slight hope for any permanent relief. Treatment applied directly to the oscillatory affection would, of course, be useless.

In miners' nystagmus, with which I have had no personal experience, the advice of Dr. Simeon Snell that the patient should rest, or find some new form of occupation, appears to be the rational course; yet in these cases it would appear that an investigation by the tropometer and the clinoscope might lead to a relief to the conditions on which the affection is based.

In a case of Bernheimer's,¹ in which the patient was hypermetropic and in which the oscillation occurred after continued close eye

¹Bericht über die 29 "Versammlung der Ophthalmologischen Gesellschaft," 1901.

work, the trouble disappeared when the patient used an appropriate glass. In another of the same author's cases, in which there was catarrhal affection of the conjunctiva with burning of the lids, it sufficed to draw the upper lid upward or the lower lid down to relieve the oscillation.

PART IV.

ANOMALOUS CONDITIONS OF THE MOTOR APPARATUS OF THE EYES NOT CONSISTENT WITH THE PHYSIOLOGICAL STATE.

Class V.

SECTION LX.

COLYTROPIA.—SPASM, PARALYSIS, OBSTRUCTION, ETC.

Deviations of the visual lines not consistent with the physiological state of the motor muscles and nerves.

The conditions of this class are usually the result of paralytic or mechanical causes. Such deviations may be classified as colyotropic or paralytic esotropia, colyotropic or paralytic exotropia, etc.

It has been the custom of authors to include under the head of paralysis the various forms of hindrance to the movements of the eyes which may arise from different causes. This, while convenient, cannot be regarded as always strictly correct. For example, Mauthner mentions at considerable length as one of the causes of paralysis of the abducens a congenital absence of that muscle. It cannot be considered quite consistent to speak of a paralysis of a muscle which never had an existence. The obstructions to movement also which occur from the presence of tumors in the orbit are classified under paralysis, yet, as a matter of fact, the muscles of the eyes may be in perfect health. It is not then too much to require in any system which professes to classify the various anomalies and affections of the ocular muscles, a more comprehensive term than paralysis to express the different hindrances to motion to which these muscles are subjected.

Several classifications of the motor disturbances of the eyes are extant, all somewhat involved and all more or less defective. I shall therefore venture no apology for the introduction of a new one.

These motor disturbances may therefore be classified as follows:—

COLYTROPIA.

A hindrance or obstruction to the movements of the eyes (Greek, κωλύειν, to hinder, to prevent).

Divisions.

1. (a) *Spasm.* (b) *Word blindness.*
2. *Paralysis.*—Failure of the nerve influence to affect contractions of muscles.
3. *Obstruction.*—A mechanical hindrance to the movements of the eyes through the influence of the muscles, not of necessity involving any disease or disability of the muscles themselves.
4. *Trauma.*—Injuries to the eye muscles by which their action is restricted or abolished.
5. *Arrest or absence of development or degeneration of the muscles.*

Mauthner divides the ætiological causes of paralysis of the eye muscles (which includes the various divisions of this classification) into several categories. Thus the proximate cause he calls the *ætiological moment* (factor, acting cause) *of the first category*. For example, if a right-sided oculo-motor paralysis is conditional upon compression of the nerve roots at the base of the cranium, the *compression* is the ætiological moment of the first category. If the compression results, for example, from the presence of a tumor which interferes with the conductivity of nerve influence, then the tumor, which is the cause of the compression, is the ætiological moment of the second category.

Finally, following out the example, should the tumor prove to be of syphilitic origin, then the disease which has given rise to the tumor is the ætiological moment of the third category.

We have then, in their order, the proximate cause, compression, the intermediate cause, the tumor and the ultimate cause, the constitutional disease, constituting the etiologi- cal moments of the first, second, and third categories.

There is abundant reason for such an arrangement, for should compression be assigned as the cause of paralysis in one case, a tumor in the second and a constitutional disease in a third, all three cases

may, in fact, be of the same nature, but each may be assigned to a different class.

If we have passed to the diagnosis of the ultimate cause, that is, to the ætiological moment of the third category, the indication for rational treatment is clear. If we have passed no further than the proximate cause, the ætiological moment of the first category, we know not whether the pressure is caused by a tumor, an enlarged artery, or an abscess; the line of procedure in treatment is by no means clear.

While in the following pages neither the order nor the terminology of Mauthner is to be followed, it will be the aim to lead to a clear understanding of the causes which may determine the various forms of disability by tracing, as far as it is possible, each causative influence from the proximate to the intermediate, and finally to the ultimate conditions upon which the hindrance of motion may depend.

As to the seat of the proximate condition in any particular form of colytropia, it may be found in the brain cortex, in the white substance, in the nucleus for the oculo-motor nerves, along the fibers which pass between the nucleus and the nerve stem, in the course of the nerve at the base of the cranium, and finally within the orbit.

SECTION LXI.

SPASM. SPASMODIC COLYTROPIA.

The subdivisions of this division are:—

1. Tonic spasm.
2. Clonic spasm.
3. Incoördinate movements.
4. Nystagmus (from cortical disease).

As the causes, proximate, intermediate, or ultimate, of the first three of these subdivisional conditions of spasm are usually situated in the cortex of the cerebrum, and the fourth, in a limited acceptance of the term nystagmus is also in certain cases a manifestation from cortical disease, it will be necessary only to examine the relations between these phenomena and cortical lesions.

The subject of nystagmus, in the more general sense of the term, the functional form, has already been discussed.

Although cortical lesions as direct causes of oculo-motor *paralysis* are at present only hypothetical, the relation between certain forms of spasmodic disturbances of the eye muscles and cortical

lesions is in a definite way established. There occur cases in which, from pressure or injury of the cortex, certain reactions upon the eye muscles are observed, yet the location of the pressure and the especial form of the muscular reaction are not so closely associated, so far as the present state of knowledge extends, as to permit of the prediction that, under certain circumstances of cortical change, certain muscular phenomena will, of necessity, follow. For example, with suppurative meningitis, in which there is pressure upon the anterior and parietal lobes of the cerebrum, there may occur a conjugate deviation of the eyes or a spasm of convergence, but the region over which this pressure must be made is not clearly defined, nor does the deviation of the eyes always occur under what appear to be practically similar circumstances.

From the discoveries of Hitzig, Ferrier, Horsley, Beevor, and others it seems reasonable to suppose that there is a cortical region which in some way influences the impulse directed to the eye muscles; the nuclear region at the floor of the third ventricle and the aqueduct of Sylvius being the immediate and direct station from which the specific influence is passed to the nerves supplying the muscles. The assumed association is shown in Bernheimer's diagram at page 82.

While it is known that disease or pressure upon definite parts of the nuclear region will invariably induce paralysis of certain of the eye muscles, and the precise muscle can be predicated from an approximate point of lesion of the nucleus, at least so far as certain nuclear groups are concerned, no such prediction can be made in regard to the effect of cortical lesions in inducing spasm.

The number of different forms of ocular muscular disturbances arising from cortical lesions thus far clearly made out is quite small, and may be said to include only conjugate deviation, spasmodic convergence, falling of the upper lid (ptosis), contraction of the pupil, and some clonic convulsive movements, which are sometimes spoken of as nystagmus. This term is hardly appropriate to these movements, which differ materially from those of the ordinary forms of nystagmus. To this list of irregular phenomena may be added a condition of absence of ability to regulate the movements of the eyes, although the power of movement may remain intact. Thus, while each eye may retain the power to rotate inward separately, the faculty of combined convergence may be absent. (Parinaud.)

Beyond these occasional and apparently not always uniform

phenomena, neither anatomical research nor pathological observations have thus far so definitely located a given portion of the cortex as the region from which spasm of special ocular muscles must originate that it can be said that a lesion of an exact region will be followed by a definite phenomenon of the muscles.

The discoveries and discussions bearing upon this subject are of much physiological interest and cannot be profitably overlooked by the student of the ocular muscles, even though up to the present time the practical results are meager and unsatisfactory. A knowledge of what has already been observed may fortunately lead to new observations which may place the whole subject in better light.

The once accepted doctrine of Flourens¹ that a single part of the brain could assume the function of any or of all other parts, was, at least in some measure, overturned by the discovery of the localized lesion in relation to aphasia.

That, however, nervous influence may be transmitted, either afferently or efferently, through one cortical center to another has been demonstrated in a number of instances.²

A revolution in all the preconceived notions on the subject followed the notable discoveries of Fritsch and Hitzig³ and the epoch-making works of Ferrier,⁴ of Horsley and Schäfer,⁵ Beever,⁶ Golz,⁷ Munk,⁸ and Exner.⁹ With the appearance of these and other works arose a new physiology of the nervous system.

While the doctrine of cerebral localization has been generally accepted, it is to be conceded that there remains, especially in respect to a cortical center controlling the movements of the eyes, much to be discovered.

Among the earliest of these localizations was that by Bouillaud,¹⁰ who recorded clinical facts which pointed to a connection between lesions of the anterior portion of the cerebrum and loss of speech.

It remained, however, for Broca, in 1861, to establish the definite relations between lesions of the base of the third convolution, more particularly of the left hemisphere, and the condition of aphasia.¹ Later, Hughlings Jackson²

¹ "Recherches Expérimentales sur les Propriétés et les Fonctions du System Nerveux."

² For a recent and very interesting case see that of Dr. Harvey Cushing, reported by Professor Geo. T. Ladd in *Popular Science Monthly*, August, 1905.

³ Reichert and DuBois-Raymond's *Archiv.*, 1870. "Untersuchungen über das Gehirn," 1874.

⁴ David Ferrier: "Cerebral Localization."

⁵ Horsley and Schäfer: "Philosophical Transactions," 1888.

⁶ Horsley and Beever: "Philosophical Transactions," 1890.

⁷ Frederic Golz (Strasburg): Six memoirs entitled "Verrichtungen des Grosshirns," in Pfluger's *Archives*, 1876 to 1888.

⁸ "Über die Functionen der Grosshirnrinde," 1880.

⁹ "Localization der Functionen in der Grosshirnrinde des Menschen," 1881.

¹⁰ *Archives de Médecine*, 1825.

¹¹ Ferrier: "Cerebral Localization."

¹² "Clinical and Pathological Researches on the Nervous System."

found that there was a relation between lesions situated in regions near and related to the corpus striatum and general or localized convulsions.¹ To these convulsions was given the name "Jacksonian epilepsy."

It is extremely unfortunate that the convulsive disease thus known should be included, even in terms, with epilepsy. The two conditions, if they do not differ as widely as blindness and deafness, are surely no more the same than are typhoid fever and smallpox. Each of these later diseases is characterized by cutaneous eruption and fever; so epilepsy and "Jacksonian epilepsy" are characterized by convulsions and generally loss of consciousness, but neither the aetiology nor the nature of the diseases have any further relation. Why should not the convulsive disease dependent upon gross manifest cerebral lesions and having symptoms peculiar to itself have a name which will not confound it with a disease not dependent upon any such lesion?

The doctrine of cerebral localizations was, however, established by the

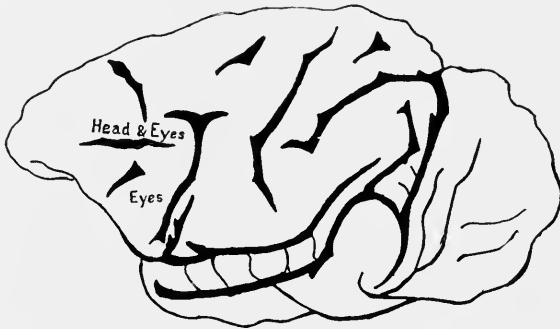

Fig. 175.—Motor Area for the Eyes, according to Beevor and Horsley.

discovery of Fritsch and Hitzig,² who, in 1870, showed that by the direct application of electrical stimulant to pretty definite cortical regions certain rather definite movements could be excited.

The subject was then taken up by Ferrier and others, especially by Beevor and Horsley, who located the region of the movements of the eyes just behind the prefrontal lobe or between the prefrontal and precentral sulcus in a space continued upward to the longitudinal fissure.³ In this region stimulation "causes opening of the eyes, dilatation of the pupils, and movements of the head and eyes to the opposite side."

The accompanying diagram (Fig. 175), copied from Beevor and Horsley,⁴ but indicating only the centers for the eye movements, shows the location of this region as made out by them.

As a matter of fact, others found that the region in which such move-

¹ Ferrier: *Loc. cit.*

² *Loc. cit.*

³ Ferrier: "Cerebral Localization," p. 27.

⁴ Philosophical Transactions, 1890.

ments can be induced is much more extensive, including, besides the frontal, much of the parietal lobe.

Ferrier suggests that the movements of the eyes are "the signs of aroused subjective visual sensation and due to the associated action of the frontal or subcortical oculomotor centers."¹

The movements of the eyes cannot be abolished without the removal of the whole of the frontal lobe.

In regard to the intermediate and ultimate causes of the disturbed action of the oculo-motor muscles from cortical lesions there is as little variety as in the phenomena themselves.

With acute inflammation of the meninges, inflammation with suppuration, the presence of purulent deposit may cause pressure upon the region of the cortex influencing the motor muscles of the eyes. The same is true of cerebro-spinal meningitis. With tubercular meningitis the pressure may arise from tubercular deposits. With each of these forms of meningeal inflammation may occur contraction of the pupils, spasm of convergence, conjugate turning of the eyes, incoördinate movements, clonic twitchings, and ptosis. Osteoplasms and other tumors, by pressure upon the cortex, may induce similar results.

All of these conditions may at length give way to paralysis of the eye muscles, when it is probable that the disease has extended to the nuclear region.

The pupil is then enlarged, the spasm of the long muscles gives place to inability to contract, and complete or incomplete ophthalmoplegia is established.

WORD BLINDNESS. PSYCHIC COLYTROPIA.

In this connection should be mentioned a most interesting condition resulting from lesion of the anterior lobe which takes the form of "word blindness."

In this singular trouble, first described by Kussmaul, there is the ability to write, but not to read. In some cases the inability to read extends only to words, while in other cases the ability to distinguish individual letters is wanting. The ability to *see* the letters is not wanting, but the interpretation of the sign is absent.

This curious affection has not, up to this, been regarded as having any relation to the muscles of the eyes, yet it appears to me that it should be classed among the affections of the eye muscles.

¹Ferrier: *Loc. cit.*, p. 39.

If we refer to the discussion of the physiology of the visual sense of space dimensions (p. 124 to 137), it will be seen that the conception of the form of objects is not derived directly from the traditional retinal picture, but from the sense of movements made by the eyes. But that these movements of the eyes are coördinated and interpreted within the cortical portion of the brain is most probable, a view corresponding to that of Ferrier above quoted. If by a lesion of a certain portion of the cortex it becomes impossible to interpret these small muscular movements required in obtaining the concept of the word, then the signs can have no meaning. In the absence of the power to coördinate these movements of the eyes, there may remain a power to coördinate the movements of the arm and hand, and hence the act of writing may be accomplished with little if any difficulty.

Some of these patients, indeed, who can recognize individual letters but do not recognize words, resort to the device of writing the word, the motion of the hand serving to interpret the combination of letter signs.

As to the locality of the lesion, Charcot found it situated in the inferior parietal lobe, and Dejernine and Serieux have more exactly placed it at the fold at the posterior part of the inferior lobe.

Word blindness, then, may be regarded as the effect of a loss of power to coördinate and to interpret the movements made by the eye muscles when these movements are slight, as in the act of seeing letters, and when the objects seen are conventional signs.

In the larger movements, such as are required of the eyes in walking or in separating and counting the spots on the blocks in the game of dominos, the coördinating faculty is sufficient, but in the case of the succession of letters of a word it is insufficient for the purpose of interpretation and possibly for the purpose of determining upon the movements to be executed through the influence of the nuclear centers.

This view is in harmony with the hypothesis of Nothnagel,¹ that the parietal lobe is the seat of the centers for the muscular sense.

This muscular sense, which is too much overlooked, is in fact the sense on which the act of reading is based. The mere visual impression of letters upon a retina the movements of which could not be felt at the center for such movement sense would fail to convey the idea of words and sentences.

¹Neurolog. Centralblatt, p. 213, 1887.

Ferrier quotes Chareot as writing: "Cases may be seen in which the sense position of the limbs was entirely abolished, and yet the patients were able to move the affected members freely even when the eyes were closed."

Hence, with a failure to direct or to experience the sense of movements, there may be an ability to move the eyes, and they may move in a spasmodic, irregular, and incoördinate manner. This is what happens in certain cases of meningitis, of abscess of the brain at the anterior and parietal region, and of bony hypertrophy of the skull at the location of the cortex assigned as that for the movements of the eyes.

Mention is made in text-books of ophthalmology of other spasms of the eyes not associated with cerebral disease. Most, if not all the conditions described are somewhat unusual forms of heterophoric anomalies. A condition of pronounced hyperphoria, for example, which had escaped observation suddenly becomes so manifest as to become troublesome. The case is set down to the account of spasm without further investigation. In a general way facts of this order may be said to cover the cases of hysterical and other supposed spasms which occupy some space in the literature.

When definite and exact observations of the eye movements are made such spasms are rarely if ever found.

SECTION LXII.

PARALYSIS. PARALYTIC COLYTROPIA.

(a) SINGLE. (b) MULTIPLE.

According to the location of the proximate cause paralysis may be subdivided into:—

Central (intercranial, Mauthner).

Intermediate.

Peripheral.

Central paralysis may be again subdivided into *nuclear* and *fascicular*.

Intermediate paralysis has no subdivisions.

Peripheral paralysis is subdivided according to the individual muscles affected; *e.g.*, failure of action of the abducens nerve induces paralysis of the external rectus, etc.

Paralytic affections of the motor eye muscles arising from vari-

ous causes and from causes situated in the various locations above mentioned have certain manifestations in common by means of which a diagnosis of the affected muscle or muscles may be arrived at.

Before entering, therefore, upon a discussion of the special classes of the affection as they depend upon the location of the cause of the disturbance, it will be convenient to examine the symptoms of paralysis common to all the classes, and present in greater or less degree in all cases.

Certain of these symptoms are more pronounced, or at least more conspicuously present to the attention of the individual affected, in recent than in old cases. This is especially true of visual confusion, of vertigo, and of a false sense of orientation; for while all these conditions persist, custom, after a greater or less period of time, modifies the intensity of these symptoms even to the extent that in some instances they may not be observed by the patient except as attention is especially directed to them.

Diplopia also, which is, in pronounced cases of recent paralysis, often a most annoying symptom, largely disappears in advanced cases of nuclear paralysis.

Among the earliest and the most persistent of the subjective symptoms of eye muscle paralysis is the erroneous localization of objects in the visual field. This false localization is for the most part in the direction of the action of the affected muscle. If, for example, the person with paralysis of the external rectus of the right eye attempts quickly to seize with the hand an object at his right side, he is liable to miss it by extending the hand beyond the object. If he points quickly with the finger to an object on that side he also points beyond to the right of the object. If he takes a longer time he may correct the error by the help of the other eye, but, except by the aid of the well eye or by the correcting sense of touch, the object at the right will persist in appearing in a false position.

The reason for this false projection is evident. Experience with the unaffected eye or with both eyes during the years of freedom from the affection, as well as native consciousness, have taught the patient the relation between the nervous impulse and the effect upon the direction of the eye. But if now a greater impulse is demanded to place the eye in the given position, or if the impulse fails, the position of the object is estimated by the force of the nervous impulse directed to the effort to move the eye. Hence, the greater the dis-

ability of the muscle, the greater the apparent displacement of the object toward the side of the affected muscle.

This erroneous localization of objects in the field of vision often becomes a matter of serious consequence to the patient in walking. He is liable to collide with the furniture of a room or objects in the street.

A patient complained that, as he was obliged to go to his business early in the morning, before the barrels of ashes were removed from the sidewalk, he almost invariably ran against the ash barrels although he was constantly on his guard to avoid them.

In cases in which the vertically acting muscles are affected, the act of going up and down stairs becomes perplexing.

This false orientation induces another manifestation of paralytic disturbance, the *visual vertigo*, which is often a most troublesome symptom. This symptom is intensified when the patient attempts visual acts which demand quick and especially complicated movements of the eyes, the visual aid, for example, which is required in going up and down stairs, especially the latter, the watching of the landscape from a window of a moving railroad train, etc. The vertigo often induces nausea and all the symptoms of seasickness. That the symptom depends entirely upon the false orientation is easily shown, since, if the paralyzed eye is covered, the confusion, vertigo, and nausea disappear.

A characteristic adjustment of the head in relation to the body is often a conspicuous symptom of paralysis of an eye muscle. This is especially true of paralysis of the superior recti muscles. In this case the chin is raised and the forehead thrown back. In paralysis of an externus the head turns toward the side of the unaffected muscle. The pose of the head in anomalous states of the muscles has already been discussed in the chapter on the expressions of the face, and the principles there laid down apply in conditions of paralysis but the manifestations are usually greatly intensified.

The subjective phenomenon most noticeable to the patient and most valuable to the physician in the direction of diagnosis is the diplopia which is present in fresh cases, and usually in old cases, in some part of the field of regard.

A careful examination of the phenomena of diplopia will generally determine the muscle or muscles whose actions are limited, but further considerations are necessary in locating the seat of the limiting cause.

In order then to interpret the meaning of the double images it will be necessary to study first, the effects of restrictions of movements of individual muscles.

The peculiarities of diplopia will vary according to the muscle or the pair affected.

PARALYSIS OF THE EXTERNAL RECTUS.

The diplopia will occur when the gaze is turned in the direction of the action of the paralyzed muscle. For example, if the affected muscle is the external rectus of the right eye, the diplopia will manifest itself as the gaze is directed toward the right.

The double images will, if the head is in the primary position and the gaze is in the plane of the horizon, be exactly level, and the image of the right eye will appear further to the right than that of the left, that is, the diplopia will be one in which the image is on the side of the eye which sees it, and it will be homonymous diplopia. Moreover, if the affection is confined to the muscle named and there is no marked anomaly in the normal position of the retinal meridians, each image will be exactly erect.

In the case of paralysis of the external rectus of the right eye the left eye is so directed, when looking at an object at the right, that the image falls at the macula. Therefore, this eye projects the image in the direction of the object; but since there is a limitation of movement of the right eye toward the right side, this eye lags behind and the image of the object is impressed at the left of the macula, and by the rule (Section XXXIV) the image is displaced to the right in proportion to the extent of the displacement of the impression toward the nasal side of the retina. If the object is moved further and further to the right while the head remains in the primary position, the images will separate more and more, the image of the right eye being thrown further and further to the right of that of the left eye. So, also, the distance between the images will be augmented in proportion to the degree of paralysis.

In a small class of cases in which there is a marked limitation of movement in the direction of the external rectus muscle, there is neither vertigo, nausea, false projection, secondary deviation, nor, in the median field of regard, converging strabismus. There may, indeed, be slight exophoria or even exotropia.

Such a case is represented in Figs. 176 and 177. This is a case

of limitation of rotation of the left eye outward, such as is classed with paralysis of the abducens. It is easy to see in the first of these two figures that there is no converging strabismus, and it is equally plain, in examining the second figure, that when the attempt is made to carry the regard to the left the right eye turns freely in that direction while the left remains stationary. Had another picture been taken to show the position of the eyes when the regard was carried

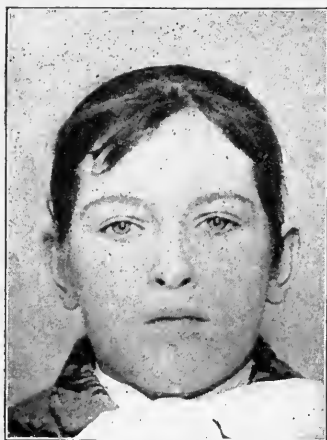

Fig. 176.

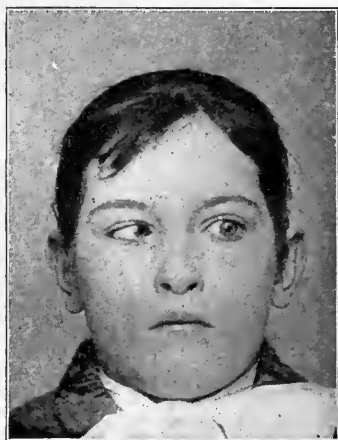

Fig. 177.

Paralysis of External Rectus, Left Eye. In Fig. 176 the child looks straight forward without squinting. In Fig. 177 the gaze is turned toward the left, but the left eye does not move outward.

to the right it would be seen that both eyes followed in the usual harmonious relation.

The affection dates from early childhood and the mother thinks that it was not observed until after an attack of whooping-cough at the age of 2 years and more. I suspect that it really dates earlier.

The rotations as shown by the tropometer are as follows:—

R. E., up, 30° ; down, 60° ; in, 50° ; out, 60° .

L. E., up, 30° ; down, 60° ; in, 40° ; out, 10° .

The rotation out of 10° is common in nearly all cases of paralysis of the abducens and is probably, in general, induced, as it is said by Mauthner, by the action of the obliques.

The patient, an extremely bright girl of 11, had, in looking straight through the phorometer, exophoria 3° , and by abduction she could overcome 10° of prism. The deviation in exclusion was for exophoria and right hyperphoria (of which the phorometer showed 1°). *There was no secondary devia-*

tion with gaze in the primary position. Looking about 10° to the *right* there was *crossed diplopia*, and homonymous diplopia only manifested itself in looking about 10° to the left. *Looking up or down and straight forward images remained united.*

Her mother has diverging strabismus.

The insertion of the muscle appears to be as sharply marked as its fellow, and where the body of the muscle can be detected it appears fully developed.

Since the muscle is apparently present it cannot be classed with cases of congenital absence of the muscle, yet it may perhaps belong to the class which has been described by Uhtoff,¹ Baumgarten,² and others, in which the muscular tissue is replaced by connective tissue, with the form and insertion of the muscle, but without its functions. It is also possible that such a case may belong to the class mentioned by Panas,³ in which there may have occurred a basal injury followed by basilar hæmorrhage.

PARALYSIS OF THE INTERNAL RECTUS.

In the case of paralysis of this muscle there is a restriction of the rotation of the eye in the direction of the action of the muscle. The eye may rotate toward the temple freely, but toward the median plane its action is limited. In pronounced paralysis there is diverging strabismus. In this case the relative position of the double images is exactly the reverse of that in the case of paralysis of the externus. The diplopia is heteronymous, the distance between the crossed images increasing as the object seen is removed further to the side of the paralyzed muscle.

The phenomenon of diplopia is explained as before, but with the difference that the image of the object now travels to the outer half of the retina as the object is moved in the direction of the action of the affected muscle, and, as the image now appears further and further toward the affected side, it becomes more and more crossed. As in the case of paralysis of the external rectus the images are, under the same conditions, in the same horizontal plane and each image is upright. The diplopia may be only observed as the gaze is turned toward the unaffected side, and if the paralysis is only partial it may not appear until the direction of the eyes is near the limitation of the field of regard.

PARALYSIS OF THE SUPERIOR RECTUS.

The indications of paralysis as manifested by diplopia in the

¹ Uhtoff: *Jahrbuch für Ophthal.*, 1882.

² *Monatliche. für Augenheilk.*, iii

³ "Transactions International Ophthalmological Congress, 1884."

muscles which rotate the eyes directly in and out have been found to be extremely clear and devoid of any complicating phenomena. With the muscles which elevate and depress the gaze new and complicating elements appear.

The action of the superior rectus muscle in health is not a direct rotation of the cornea vertically, nor is it even a rotation upward and inward only. It is a rotation upward, inward, and around an axis represented by the optic axis.

Again, elevator and depressor muscles have a different action according to whether the position of the line of regard is directly in front or toward one or the other side. If the eye is directed straight



Fig. 178.



Fig. 179.

Paralysis of Superior Rectus of Right Eye. In Fig. 178, looking forward; in Fig. 179, looking up.

forward, the effect of a paralysis of the superior rectus is much more pronounced than when the eye is rotated toward the nose. On the other hand, the effect is augmented as the eye turns outward.

The diplopia of paralysis of one superior rectus is mainly vertical. It may not be present when the patient is walking and looking toward the ground, but becomes apparent when the gaze is directed toward the horizon or upward.

As the eye is turned toward the nose the superior rectus becomes less and less an elevator muscle and more and more a rotator about the optic axis. Hence while the images will be separated by less

distance when the eye is rotated toward the nose, the difference in the positions of the images in respect to their verticality will constantly increase as the eye is more and more in adduction. If the eye is turned outward, the separation of the images becomes steadily greater in proportion to the abduction, but at length, when the abduction has been carried beyond the point where the muscle draws exactly upward and no longer inward, the elevating action is reduced as the abduction becomes greater. The rotation around the optic axis is less up to a certain point, when it is absent, and then begins in the opposite direction. These phenomena are described as they occur in cases in which the adjustments in health are reasonably free from anomalies. It happens, not unfrequently, that anomalies of declinations may so affect the position and verticality of the images that this ideal scheme is no longer applicable.

The diplopia resulting from a paralysis of a single superior rectus will be manifested in the vertical direction with the image of the affected eye *higher* than that of the sound one when the object seen is near the horizon or above it and when the gaze is directed straight forward. In this position, when the gaze is somewhat elevated, the image of the affected eye is also slightly in the direction of the opposite eye, that is, the diplopia is vertical and slightly heteronymous. Also, in an ideal state of adjustments, or a state approximating this, the image of the affected eye, the upper image, should tilt somewhat toward the temple. That this crossing position of the images and this leaning of the upper part of the upper image toward the temple does not always occur has been forcibly held by Mauthner, who has, at much length, reiterated the proposition that "the obliquity of the double images proclaimed from theory has in practice no diagnostic value."¹ A similar view is taken by him in respect to the lateral position of the upper image.

Other authors² question this position and hold that the swing of the upper image toward the opposite side and the tilting of the upper end toward the temple constitute essential elements in the diagnosis of paralysis of the superior rectus.

We shall return to this question when the diagnosis of paralysis of the rectus superior and rectus inferior, on the one hand, and the oblique muscles on the other, is under consideration.

¹ Mauthner: "Augenheilkunde," p. 530.

² Panas: "Maladies des Yeux," ii, p. 44. Fuchs: Duane's Translation, p. 596.

PARALYSIS OF THE INFERIOR RECTUS.

Much that has already been said in reference to the diplopia arising from paralysis of the superior rectus applies to that of the inferior rectus. The depressing power of this muscle, like the lifting power of the superior, diminishes as the eye is brought into the position of adduction, and its depressing influence increases in abduction until the eye has rotated outward about 30° from the sagittal plane of the head, when it again diminishes. Like the superior rectus, it aids, in the condition of health, in adduction, and hence, in paralysis, the eye is somewhat abducted and the images cross. So also the inferior rectus acts as a rotator of the eye upon the optic axis and in paralysis, the theoretical states of the muscles being in other respects correct, the image of the affected eye should lean with its upper part toward the nose.

The diplopia, then, of paralysis of the inferior rectus may be theoretically described as vertical, the images of the affected eye being below, crossed, and with the image leaning to the center. The first of these conditions is always present: the second and third may be present. But the important factor in the diplopia from paralysis of this muscle, as in the case of the superior rectus, is, as Mauthner has shown, the fact that as the eye is rotated toward the nose the separation of the images becomes less extensive, while as the eye is rolled toward the temple the distance between the images increases.

PARALYSIS OF THE SUPERIOR OBLIQUE.

While the oblique muscles act both in the vertical and horizontal directions, their chief office is to rotate the eye on its own axis. The phenomena of diplopia resemble in such measure those found in paralysis of the superior and inferior recti that the diagnosis demands close observation and in some instances the differentiation is somewhat difficult. The action of the superior oblique causes the eye to rotate downward, outward, and around the optic axis. Its vertical and lateral action is diminished as the eye turns outward, while the inclination of the meridian in this position increases. The depressing action of the superior oblique is greater when the eye is directed straight forward than when directed toward the temple. It is still greater when the eye is rotated toward the nose.

From these considerations it will be seen that with paralysis of

the superior oblique the image of the affected eye will be below the other, since the eye will be deprived of the action of one of the depressor muscles, and that the diplopia will occur in the lower part of the field of regard. Not only will the images be vertically separated when looking straight down, but, since the diverging action of this muscle is removed, the images will be more or less homonymous. According to the theory of the action of all the muscles, the image of the affected eye should also be much tilted, with its upper end pointing inward. This apparent tilting inward of the image represents in fact an actual tilting outward of the vertical meridian of the affected eye, and this important fact should not be lost sight of in the examination of cases; for, if the leaning inward of the image should be interpreted as the rolling inward of the meridian, it might lead to a false diagnosis.

Paralysis of the superior oblique is, like that of the abducens, of comparatively frequent occurrence. The great majority of cases of paralysis of the eye muscles is associated with these two muscles.

It will be well in this place to give in detail the indications to be observed in a case of paralysis of the left superior oblique.

The patient complains of diplopia when looking down and to the right. It will be found that the image of the right eye is highest and there may be a slight esophoria (1° or 2°), or there may be no deviation in this direction. As the line of regard is turned to the right and down the images become more and more separated. The image of the affected eye is nearer than the other. The images may both tilt or neither may tilt; generally the latter is the case. (According to the theory of the action of the muscles, there should be marked tilting of the left eye toward the right.) If the line of regard is carried upward the diplopia disappears.

In the table on page 462 are given the average results of examinations in several cases of superior oblique paralysis made by the aid of the tropometer and the clinoscope.

It will thus be seen that while the leaning may not be observed in the ordinary examination, the clinoscope shows about 7° positive leaning in the primary position—a leaning not altogether unusual in sound eyes.

It becomes, in view of this, a question whether, in case of such considerable normal declination, the habitual state of tension of the superior oblique may not be regarded as an important predisposing

element to the affection when it is not the result of nuclear disease dependent upon syphilitic taint.

When a patient presents himself with the symptoms of paralysis of an eye muscle and it is found that there is a vertical diplopia, the question of diagnosis between the two pairs of elevator and depressor muscles of the eyes at once suggests itself. There is vertical diplopia. It can be induced by a vertically acting rectus or by an oblique muscle.

Table of Rotations and Leanings in Superior Oblique Paralysis.

Average Results		Sound Eye	Affected Eye
ROTATIONS	Up	40°	40°
	Down	40°	40°
	In	48°	52°
	Out	40°	30°
LEANING OF IMAGES	Primary Position	0°	+ 7°
	Down 30°	0°	+ 15°
	Up 20°	0°	+ 5°

If we select the inferior rectus and the superior oblique as those between the diplopia of which we would differentiate we find the following points:—

1. There is diplopia in the lower field of regard in each case, and in each, as the gaze is carried directly down, the distance between the images is augmented. There is here therefore a common character to the diplopia.

2. In paralysis of the inferior rectus the eye is supposed to turn slightly out on account of the disability of a muscle which normally acts as a convergent muscle, while, on the other hand, with paralysis of the superior oblique there is supposed to be a slight converging of the eyes due to the suppression of influence of a diverging muscle.

If these conditions were uniform, they would furnish a reliable and constant element of diagnosis; for, should we find paralysis with

vertical diplopia in the lower field only, and with the image of the right eye at the right of the other, homonymous images, we might at once conclude that the superior oblique is the muscle affected, and should the images be crossed, we might with equal certainty conclude that the inferior rectus is the disabled muscle.

Unfortunately for the simplicity of diagnosis these conditions are not always uniform, and the fact is that homonymous diplopia is sometimes found with paralysis of the inferior rectus and crossed diplopia with paralysis of the superior oblique.

3. We have the third element in the tilting of the image of the affected eye.

Should the upper part of the image tilt toward the temple we should theoretically locate the disability with the inferior rectus, while, should the image tilt inward, the trouble would be with the superior oblique.

Here, again, the failure of uniformity may militate against the correctness of the diagnosis.

Mauthner believes that anomalous conditions like a normal divergence or convergence of the eyes, conditions which may not have been recognized previously to the paralysis, so frequently complicate the diagnosis as to render the conditions of No. 2 and No. 3 without diagnostic value.

To a certain extent the distinguished author is correct in this, but we may go farther than this and we are more likely to find the true explanation of the variability of these conditions.

In anomalous leanings we find not only a satisfactory explanation of the want of conformity in respect to the homonymous or crossed position of the images, but also an equally clear reason for the uncertainty respecting the directions of tilting.

The anomalous directions of the vertical meridians which, previous to the introduction of the clinoscope, were not considered, are now known to be common and of great practical consequence. We now know that in exceptional instances a person who may have had fairly comfortable eyes may show a declination of from 5° to 9° , or even more. Such a declination in case of paralysis of a depressor or of an elevating muscle would unquestionably dominate, not only the inclination of the image, but the divergence or convergence as well.

Suppose a case of paralysis of the left inferior rectus with a normal + declination of the right eye of 7° .

In case of diplopia an effort would be made to see the vertical

image in its vertical position by the right eye, which would bring the superior oblique muscle of that eye into active contraction. This would act upon the position of the vertical meridian, but it would give to the eye also a tendency to swing outward. To counteract this the internal rectus would act and in many cases, if not in most, this action of the right internus would be associated with a synergic action of the internus of the left eye; hence, a convergence would be induced. A synergic action of the inferior oblique muscle of the left eye would perhaps result, which would more than counterbalance the tilting of the image resulting directly from the disability of the inferior rectus.

We cannot place this important part of the subject in better light than by quoting from Mauthner the rules in these cases. "In general," says this learned author, "if in paralysis of a muscle acting in a vertical direction, the distance in the height of the double images increases in that diagonal position in which the paralyzed eye is found in the outward position (position of abduction), but decreases in that diagonal position in which the paralyzed eye stands in the inward position (position of adduction), then the rectus superior or rectus inferior is affected by the paralysis, *no matter whether the double images are crossed or homonymous, and independent of the statement of the patient that he sees no obliquity of the images.*"

So on the other hand "the difference in height of the double images in paralysis of an oblique will be greatest" when the paralyzed eye is rotated inward and least when turned outward. "From the different behavior," adds the author, "of the difference in height of the double images in the diagonal position rests the only sure differential diagnostic factor between paralysis of the rectus superior and the inferior oblique, on the one hand, and the rectus inferior and the superior oblique, on the other."

PARALYSIS OF THE INFERIOR OBLIQUE.

Except that the diplopia occurs in the upper part of the field of regard and that the image should tilt with its upper end toward the temple, what has been said in regard to paralysis of the superior oblique may apply to the diplopia arising from paralysis of the inferior oblique. In the case of the latter muscle the image of the affected eye is higher than the other; the image of the right eye is at the right of that of the left eye. The separation of the images increases as the eye is turned inward and the tilting is less.

Paralysis of the inferior oblique as an isolated affection is an extremely rare form of paralysis. Of several published cases which I have examined with care the majority at least must be rejected as not being true examples of the affection. Curiously enough the cases which have been reported in greatest detail and with most intelligence are those which are the most readily rejected. Graefe did not find a case in 40,000 eye cases, and Mauthner, in a still greater number of cases, found no instance of paralysis of the inferior oblique.

It cannot be said, however, that this is never an isolated affection.

The indications are somewhat similar to those of paralysis of the superior oblique. There is the confusion and nausea, the false projection, but only in the upper part of the field of regard, and therefore less constantly present than in paralysis of the superior oblique. In some respects this confusion in the upper part of the visual field is even more troublesome than that in the lower half, for buildings seem to be falling over and the universe appears unsettled. Even some years of experience may not relieve the patient of these unpleasant apprehensions respecting the stability of things. The confusion is in looking up and to the side of the affected eye. The classical leaning of the object may not exist in looking straight forward; indeed, the leaning, owing to a normal declination of one or both eyes, may be exactly opposite that which is shown in the diagrams of the text-books as the leaning from paralysis.

The better to determine the relative position of the image pertaining to each eye it is well to introduce a contrast of color; thus, a red glass placed before one eye while the patient looks at a candle flame will enable the examiner to locate without trouble the position of the image of each eye.

The relative positions of the double images may be summed up in the following analytical key.¹

¹ Modified from an article by the author in the *Ophthalmic Record*, July, 1894.

SECTION LXIII.

RELATIONS OF THE DOUBLE IMAGES IN PARALYSIS OF THE OCULAR MUSCLES.

(A) DIPLOPIA CAUSED BY LATERAL ROTATIONS IN THE HORIZONTAL PLANE.

1. Images *homonymous*, paralysis of the *external rectus* of the eye toward which the rotations cause the greatest separation of the images.

2. Images *crossed*, paralysis of the *internal rectus* of the eye toward which the rotations cause the least separation.

(B) DIPLOPIA INDUCED BY ROTATIONS ABOVE THE HORIZONTAL PLANE.

The higher image belongs to the affected eye.

1. Images separating as the affected eye rotates to the nose, paralysis of an *inferior oblique*.

2. Images separating as the eye rotates toward the temple, paralysis of a *superior rectus*.

(C) DIPLOPIA INDUCED BY VERTICAL ROTATIONS BELOW THE HORIZONTAL PLANE.

The lower image belongs to the affected eye.

1. Images separating when the affected eye turns in, paralysis of the *superior oblique*.

2. Images separating as the affected eye turns out, paralysis of the *inferior rectus*.

According to the rule, in *B1* and *C1* the images should be homonymous, and in *B2* and *C2* they should be crossed. In the first and second instances a normal condition represented by exophoria may render the images crossed, while in the case of *B2* and *C2*, a condition in which esophoria is a manifestation, there may be homonymous diplopia. (See diagrams on next page.)

SECTION LXIV.

OBJECTIVE MANIFESTATIONS OF PARALYSIS OF THE OCULAR MUSCLES.

Beside the subjective manifestations of paralysis of the eye muscles, vertigo, confusion, vitiated orientation, and diplopia, there are certain objective phenomena which demand attention.

The pose of the head, to which reference has already been made, is characteristic for most forms of ocular muscle paralysis. Thus, with paralysis of a lateral muscle, the head is carried to one side in

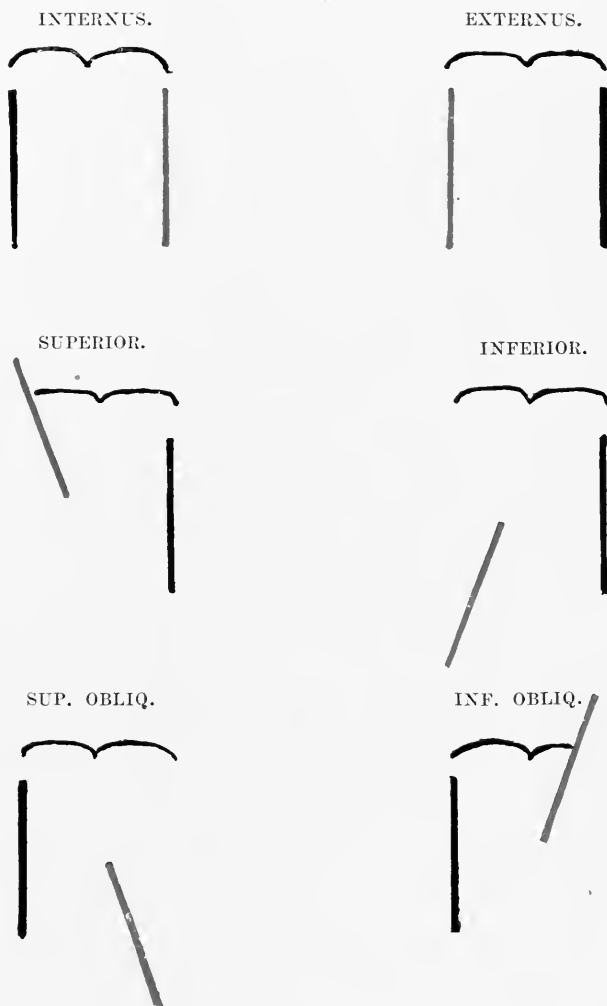

Fig. 180.—Diagram Indicating the Relative Positions of the Images in Paralysis of Individual Muscles of the Right Eye. Image of Right Eye Indicated by the Red Line.

order to relieve, as far as possible, the occasion for bringing into action the affected muscle. In case of paralysis of a superior rectus the chin is elevated, and when both superior recti are disabled, the head is held very far back, turning neither to one side nor the other. With paralysis of a superior oblique, the head is turned downward and in the direction of the sound eye.

Secondary deviation is conspicuous in paralysis of certain muscles, but not very prominently shown in others. For example, in slight cases of paralysis of the superior oblique scarcely any secondary deviation is to be observed, while in even moderate paralysis of an external rectus the secondary deviation is, in most cases, plainly to be seen.

In the case of the ordinary concomitant strabismus, if the patient fixes one eye upon a distant object the other turns in (or out). If, in a case of ordinary concomitant converging strabismus the test for "deviation in exclusion" is made and repeated several times, and the extent of turning of each eye is carefully noted, it will be seen that the turning of the usually fixing eye when behind the card is exactly or very nearly the same in extent as the turning of the usually squinting eye, and that as the card is passed from one side to the other the same amount of deviation is seen, no matter before which eye the card is found. The deviation of the usually squinting eye is called the "primary deviation," while that which occurs when the card is slipped before the usually straight eye is known as the "secondary deviation."

Now this "secondary deviation" in case of paralysis is quite a different matter from that which we have just described as occurring in the common form of squint.

If we place the patient with a paralysis, for example, of the external rectus of the right eye, facing a candle situated at some feet in front, it will be seen that the left eye fixes the flame of the candle while the right turns toward the nose. If now we pass the little card in front of the left eye, the right eye will move by jerks perhaps outward to the sagittal plane of the eye, or a little short of it. At the same time the sound eye will make the excursion inward, but not as in the other case, for it will now go very much further than the right eye turned in. In other words, the "secondary" deviation in case of paralysis exceeds, and generally greatly exceeds, the primary deviation. This is an important element in the diagnosis of a paralytic squint.

SECTION LXV.

LIMITATION OF ACTION OF THE PARALYZED MUSCLE.

If the patient with paralysis of the external rectus of the right eye is asked to look at an object held in front of him, a pencil for example, and directed to follow the object with his eyes as it is moved, it will be seen that as the pencil is moved to the left the two eyes will follow it, the right probably, especially when the pencil is only a little to the left, starting farther to the left, but gradually coming to fix at the same point on the pencil. If, on the other hand, the pencil is moved toward the right, the right eye, while lagging behind the other, will still, as the pencil moves beyond the median plane toward the right, follow until it looks straight forward. Then it stops, and while the left eye will continue to rotate so as to follow the object, the right eye remains fixed in its position. This deviation of the eye while in a state of repose and the sudden arrest of movement when it has reached the point at which the aid of the affected muscle is demanded in order to carry it further, constitute the most striking objective features of fresh cases. There are cases, however, especially of paralysis of the external rectus dating from early infancy, in which the affected eye has no squint when looking straight forward; it is only when the object looked at is at the same side as the affected muscle that any appearance of a want of harmony between the two eyes is observed. Whether these cases can be regarded as cases of true paralysis will be discussed in another section.

SECTION LXVI.

MEASUREMENT OF THE DEVIATIONS OF PARALYSIS.

To determine the extent of the deviations from paralysis of the eye muscles many methods have been suggested. Locating the position of the images as they appear on the surface of a wall divided by lines of latitude and longitude, measurement by an instrument called a strabismometer, etc. It has been customary with writers to advise the use of the perimeter, and in 1886 I devised a method¹ of this

¹ On the arc of the perimeter a rider projecting above the arc is movable, and while one eye is directed across the center of the perimeter toward the distant object, the movable rider can be moved so as to obstruct the deviating image. The perimeter registers the distance in degrees between the images.

kind which I thought less faulty than others. The method is, however, at best clumsy, rather troublesome, and above all, not of great utility. It is, however, as good as any of its kind.

The measurement of diplopia, which is most convenient and most likely to give uniform results when proper conditions are observed, is that which can be made by prisms.

No measurements of the deviations are in fact entirely satisfactory, for these may vary from hour to hour.

The method of estimating the real extent of disability of the affected muscle is that of determining the rotating ability of the

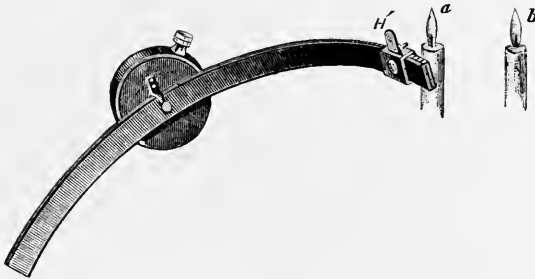

Fig. 181.—Arm of Stevens's Perimeter. The rider at *H*' obscures the flame at *a* and then at *b*, the perimeter registering the angular distance.

muscle. The tropometer affords a perfect means of accomplishing this with no especial difficulty, and by its means it is easy to ascertain, as treatment goes on, whether the muscle is acquiring more rotating ability or is remaining stationary.

SECTION LXVII.

NUCLEAR PARALYSIS.

Paralysis of independent muscles occurs from causes which may affect only the branch of nerve supplying that muscle or the more minute divisions of it which are distributed to its parts; or, again, the cause may be found far behind these more immediate nerve branches. When several muscles are affected at the same time in cases in which no mechanical obstruction exists, we must, in general, look for the seat of trouble at a point so far back that all the nerves affected may be influenced by the same cause.

In the forms of disability known as ophthalmoplegia the nerves

supplying several muscles may be subject to a common disabling influence, and hence the conditions of paralysis are usually not as simple as those which have been discussed.

Ophthalmoplegia, when it involves only the external eye muscles, is known as ophthalmoplegia externa. When it involves only those which are within the eyeball (constrictor of pupil, accommodation, tensor choroidæ) it is called ophthalmoplegia interna, but if both these groups of muscles are involved, it is total ophthalmoplegia.¹

In ophthalmoplegia externa, when more than a single muscle is affected, the limitation of movements is, of course, in the direction of the action of all the muscles affected. Hence, while the principles which have already been announced as applying to the diplopia and restriction of mobility in case of paralysis of individual muscles holds good, the sum of the corresponding phenomena in case of multiple paralysis is more complicated.

In order to arrive at a clear understanding of nuclear paralysis it is important to recall the anatomical facts regarding the nuclear origins of the nerves governing the movements of the eye muscles as they are shown in Section VIII to Section X.

We may here summarize these facts as follows:—

Lying in the mid-brain, in the region of the anterior quadrigeminal bodies, in the floor of the aqueduct of Sylvius at the right and left of the median line, are groups of cells extending backward about 6 millimeters (Bernheimer), which, when cut by a transverse section from above downward, show an oval outline of the section, the two halves of the section looking like two eggs with the small ends down and the upper ends somewhat diverging, the small ends resting upon the posterior longitudinal bundle, and which together constitute the nuclear origin of the different branches of the oculomotor or third nerve. Immediately behind this pair of groups is another pair so closely associated with the first that, according to most of the authorities, it is only by the difference in the size of the cells and the course of its fibers² that the boundary can be well made out, and which has an extent considerably less than the first pair. This posterior pair of cell masses constitutes the origin of the fourth pair of nerves.

¹Jonathan Hutchinson, *Lancet*, 1879, also *Medico-Chirurgical Transactions*, 1879.

²Bernheimer states that the difference in character of the cells does not constitute a mark of distinction, but that the course of the fibers plainly distinguishes the two groups (*Das Wurzelgebiet des Oculomotorius*).

At some distance behind the last is found another pair of cell groups from which arise the fibers which go to make the sixth nerves.

From the mass composing the nucleus of the oculo-motor nerve arise the fibers which, after passing forward and downward, first unite in a number of bands of nervous fibers and finally join in a single trunk as the third cranial nerve to supply the muscle of accommodation and of the sphincter of the iris within the eye, and the elevator muscle of the upper lid, the superior rectus, the internal rectus, the inferior oblique, and inferior rectus, exterior to the eyeball, the fibers for these various nerves being in relation to the various parts of the nuclear mass in the order from before backward as they have been above mentioned.

To summarize the most recent results of investigations upon apes by Bernheimer¹ in regard to the origin of the fibers of the branches of the oculo-motor nerve directed to the exterior muscles, it is found:—

1. The nuclear field of the levator palpebræ superioris lies in the anterior part of the nuclear mass (but behind the part belonging to the ciliary and iris muscles) and in the middle and dorsal portion of that part, its fibers proceeding directly to the nerve on the same side with the origin.

2. Behind this cell group is that belonging to the superior rectus, its fibers also proceeding to the nerve stem of the same side as the origin cells.

3. Somewhat medianward and behind the last group lies the group supplying the fibers for the internal rectus, some of which pass directly to the nerve of the same side and some of which cross to the opposite nerve stem.

4. The cell group for the inferior oblique lies outward and behind that for the internal rectus, and the fibers from this center cross to the opposite nerve.

5. The inferior rectus nerve arises from a group posterior to and somewhat overtopping the inferior oblique group, and its fibers cross to the opposite nerve.

Behind these parts of the mass composing the oculo-motor nucleus is the nucleus of the trochlear (fourth) nerve, whose fibers cross to the opposite side, while the nuclear mass for the sixth nerve is considerably behind these, in the floor of the fourth ventricle, with

¹ Archiv für Ophthalmol., Bd. xliv, 3, 481.

fibers passing directly to the nerve of the same side, no intercrossing having been recognized. Notwithstanding the results of all investigations it is to be borne in mind that the exact boundaries of these nuclear centers are still in suspense.

While bearing in mind the location and relative position of these nuclear masses it is important to note also the peculiarities of the mid-brain, the region in which these nuclear groups are found.

The region receives its nourishing arteries¹ from the basilar trunk of the posterior cerebral artery. [See Fig. 27, page 85.] This arterial trunk lies in the depression at the median line of the pons

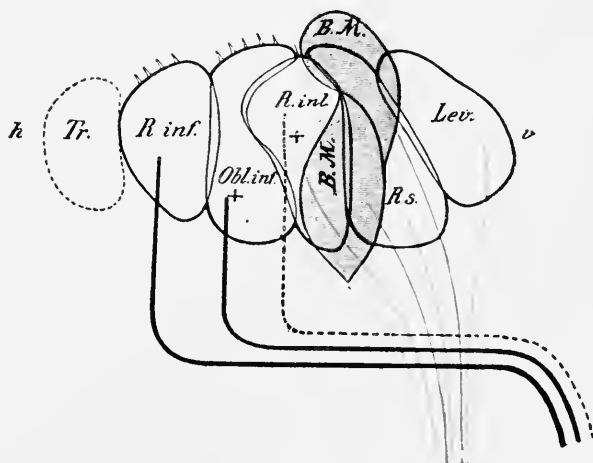

Fig. 182.—Professor Bernheimer's Diagram of the Nucleus of the Oculo-motor and of the Trochlearis Nerve. (By permission of Professor Bernheimer.)

Varolii, extending to the medulla oblongata, where it divides. In its course it sends directly into the deeper structures, in which lie the nuclear centers for the eye muscles as well as some other nuclei, a large number of branches which run in nearly parallel directions and which penetrate to the region of the various nuclear masses for the eye muscles as well as to those for the facial and fifth nerve. These *median arteries* do not, like many small arteries, anastomose freely with each other, but run independently to their destination. It will be seen that

¹ According to D'Astros (Neurol. Centralbl., 1894, Nos. 21, 22) the entire blood supply of the oculo-motor group is from these arteries.

this peculiar arrangement may have an extremely important bearing upon the pathology of the region supplied by them; for since each vessel furnishes the supply of blood to its particular field independent of the other vessels of the series, it follows that an obstruction of any one or two of these small arteries may induce degeneration of the part which it should supply, and hence, too, a pathological process which advances along the course of the basilar artery, even while it may not obstruct the artery itself, may affect progressively one after another of these median arteries so as to induce progressively degeneration of one after another of the nuclei supplied, thus paralysis of one muscle or set of muscles succeeding another in regular order. Hence, the locations of the nuclear masses in the mid-brain furnish the elements of the picture of many affections in which the more general symptoms of central nerve degeneration are associated with paralysis of one or more of the eye muscles.

The question of a nuclear center for the conjugate side movements of the eyes is far from being satisfactorily settled, and it would appear not to be a question of importance in this connection, since a cortical center for coördinating such actions would seem quite to answer the demands. So also the centers which some have assumed on the hypothesis that there should be a controlling region for convergence, and even for divergence, would seem not to be required by physiological or pathological facts. Möbius suggests several connecting media between the cortex, the abducens nucleus, and nuclei of nerves governing convergence, but he has not located these connecting media.

From the foregoing considerations it will be seen that a disease, a pressure, a degeneration, or a failure of nutrition affecting one or more of the regions in which lie these three masses of nuclear cells may be expected to result in a disability of the muscle or muscles respectively dependent upon these groups for the nerve impulse necessary for voluntary motion.

The nuclear mass, disease of which may affect the largest number of muscles, is that which lies most anteriorly and is of itself the largest, the oculo-motor nucleus or nucleus of the third nerve.

NUCLEAR PARALYSIS OF THE OCULO-MOTOR NERVE.

The nucleus may be affected in only a part of the cells or the whole mass may be involved in the disease. In the first condition only one or two muscles or one or two pairs of muscles may be affected. It is rare that a single muscle is disabled, yet such single

paralyses occur from disease in or near this nucleus. In case the whole or a great part of the nuclear mass is involved in the affection, all the muscles controlled by the third nerve will be disabled.

In the latter instance we have a case of *total oculo-motor paralysis*.

TOTAL OCULO-MOTOR PARALYSIS.

The picture of total oculo-motor paralysis is striking and characteristic, since not only four of the muscles which move each eye, but also the elevator of the lid, the muscle of accommodation, and that governing the pupil are involved in the trouble.

The symptom which first attracts the notice of the observer, and that which is frequently the first observed by the patient, is the drooping of the upper lid and the necessity of making a strenuous effort to uncover the eye, or the raising of the chin so as to permit the eye to see under the border of the lid.

Even in complete forms of the levator palpebræ superioris the lid can be to some extent raised, since the frontal muscle above the orbit exerts its influence in raising the brow as well as the lid. By this action of the frontalis the peculiar and characteristic expression of paralysis ("the Hutchinson expression") is given.

The second symptom, that which is greatly troublesome to the patient, is the disability of the muscles which move the eyes up and down and toward the nose. The superior rectus, the inferior rectus, the internal rectus, and the inferior oblique are all disabled. The external rectus and the superior oblique continue to act.

The eye cannot turn in beyond the median line; it can only turn down as it is rotated by the superior oblique and the upward rotation is absent.

The action of the two remaining muscles can be well observed in a case in which the paralysis of the oculo-motor nerve is total. The eye is rotated out and the upper part of the vertical meridian is rotated in.¹

The patient will have diplopia which will occur especially when attempting to read and the images will be crossed. In general the images are not level even when the oculo-motor nerve of each eye is affected, since the degree of paralysis is liable to be unequal. Hence,

¹ Mauthner, p. 297, says that the meridian is rotated out, which is an error.

the images may separate vertically when the attempt is made to look up or down.

Owing to the implication of the nerve governing the contraction of the pupil the pupillary opening is large, although not dilated to the full extent, and it does not respond to the stimulus of light. The accommodation is also suspended.

In a considerable proportion of cases in which, while all the motor muscles governed by the third nerve are disabled, the nerve branches supplying the interior muscles, sphincter of the pupil, tensor choroidæ, and accommodation, may continue to perform their functions normally. hence, when the affection extends to the external

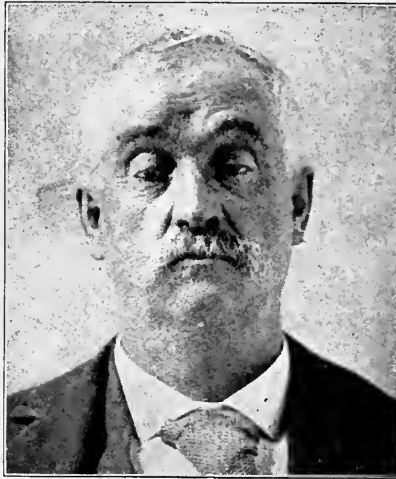

Fig. 183.—Ophthalmoplegia Externa in an Adult.

muscles only it is known as *ophthalmoplegia externa*, when involving only the internal muscles it is *ophthalmoplegia interna*, and when including both the external and internal muscles it is called *total ophthalmoplegia*. So while the accommodation is preserved, the action of the pupil may react to the impulse of accommodation, while it is unaffected by the action of light. In certain cases the pupil is contracted.

Similar considerations also show that with an affection of a part or of all of the branches of the third nerve, the fourth nerve, whose nuclear cells join those of the third nerve, may escape, while

the sixth nerve, whose nuclear group is situated considerably further back, may participate in the affection.

On the other hand the whole line of nuclear masses may be affected as in the following case:—

Dr. B., aged 62, in 1889, had an attack of motor aphasia which followed the extraction of a tooth. The attack lasted thirty-six hours and was followed by weakness and drowsiness. After some weeks he appeared to be well. Early in 1892 he had occasional attacks of diplopia which, after a fatiguing journey, became permanent. With more pronounced symptoms of double vision ptosis of both sides was associated.

He was examined by me in June, when his conditions were as follows:—

Has had no symptoms of mental disturbance, memory good. Is in other respects in fair health. Appears like a robust man, but the patellar reflexes are absent. No history of specific disease.

Vision $\frac{6}{12}$ each eye with sph. + 1.25. Can read with sph. + 3.50 either eye, but can only do so by covering the other eye. Both discs hyperæmic. Field of vision each eye normal. Brows strongly arched (see Fig. 183, p. 476) and the skin of the forehead is in deep folds. Ptosis well marked. The right eye has no rotation outward, but rotates in, down or up about 15° . The left eye has similar restrictions, except that the outer rotation is about 20° . In none of the movements is marked torsion to be observed. Pupil responsive to light. Looking at candle flame at 6 meters there is, in primary position, homonymous diplopia.

Looking at object 15° below horizon right eye image directly above.

Looking at object 15° above horizon right eye image directly below.

Object 15° to left, vertical diplopia, right eye image above.

Object 15° to right, homonymous diplopia, images always erect and parallel; at near points images crossed.

This gentleman after the free use of iodide of potassium for some weeks was able to get single vision at all points within a somewhat restricted field. He died a year later from pneumonia.

Paralysis from disease of the nuclear mass of the sixth nerve manifests itself clearly in contrast to other nuclear disturbances, since this nucleus controls but a single nerve, and that governs the rotation of the eye out. It is not so clearly differentiated from paralysis of the nerve branch within the orbit. The conspicuous symptom then will be a converging squint. Other symptoms, such as the diplopia, the secondary deviation, etc., will readily suggest themselves.

Since the indications of paralysis of the fourth nerve present some exceptions to the general rules, it will not be so easy in every instance to locate the disturbance. In this case there is no deviation of the eye such as to attract attention, and often it is so slight as not

to be clearly made out, even when it is looked for. The diagnostic indications are shown at page 466.

The question of the exact locality of the disease in a case of nuclear paralysis of the fourth nerve is one to which investigators have not always given the same answer.

Not a few cases are on record in which a one-sided paralysis of all of the exterior muscles supplied by the third nerve, with perhaps the addition of the external rectus and the superior oblique, that is, all of the muscles of the same eye, have been affected.

When the crossing of the fibers of the fourth nerve is considered, it is apparent that should such a combination of paralyse be

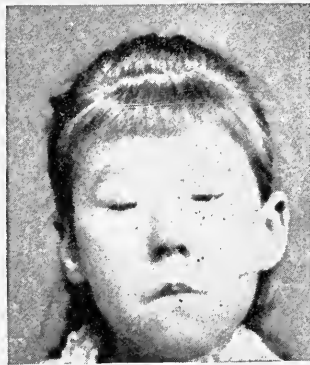

Fig. 184.—Paralysis of the Third Nerve in a Child.

found, either the disease is not nuclear or it must have attacked the opposite side when reaching the posterior boundary of the third nerve group, and then have returned to the first side of that group when reaching that of the sixth nerve, a supposition most improbable; or it must be assumed, contrary to the observations of anatomists, that the fibers of the trochlearis (fourth nerve) arise from the same side as the eye supplied.

Mauthner¹ adopts this conclusion, and declares:—

“On the ground of clinical observations I am of the opinion that the nerves for the eye musculature of each eye all have their nuclei on the same side, and that therefore, the one-sided total ophthalmoplegia is conditioned simply by the progressive disease of the nerve nuclei of the same side.”

¹ “Augenmuscule Lahmungen,” p. 368.

This conclusion of the learned author is opposed to the great body of anatomical facts as they have been presented during recent years and by many clinical facts.

As a most important fact in the diagnosis of the location of the disease in a case involving the fourth nerve and the branches of the third, if the paralysis is all on the same side, the affection is *not* nuclear.

A nuclear origin may be with some certainty assumed under the following circumstances:—

1. Isolated paralysis of the accommodation and of the sphincter of the pupil not induced by drugs applied to the eye.

2. Paralysis of the branches of the third nerve distributed to the external muscles only.

3. Paralysis of some of the branches of the third nerve with paralysis of the fourth nerve of the *opposite* side. This speaks both for the nuclear origin of the third and fourth nerve paralysis.

Paralysis of nuclear origin may affect the fourth or the sixth nerve, or, indeed, either of the nerves supplying an external muscle, but the nuclear origin of the paralysis cannot be proven in the absence of the disability of a branch supplying some other muscle or muscles except as it may be assumed in connection with some disease which is extremely liable to induce it. For example, a paralysis of the abducens nerve occurring in connection with tabes may be assumed to be of nuclear origin. It might, however, even in this case be of peripheral origin, but the well-known fact that such paralysis is a frequent symptom of tabes renders the diagnosis of nuclear origin extremely probable.

SECTION LXVIII.

. CAUSES OF NUCLEAR PARALYSIS.

ÆTIOLOGICAL CAUSES OF THE FIRST CATEGORY.

Turning our attention now to the causative conditions of nuclear paralysis we recur to the categories of Mauthner: the proximate cause being the ætiological factor of the first category. Thus, if a paralysis is conditioned on compression, the compression is the ætiological moment of the first category. The ætiological factor of the second category is the cause of the factor of the first category; thus, if a tumor causes the compression in the case supposed, the tumor is the factor of the second category. Finally the origin of this factor of

the second category is the factor of the third category. Continuing the supposition of pressure and that the pressure is from a tumor, then, if syphilis is the cause of the tumor, it is the factor of the third category.

Thus, if the paralysis is confined to the intra-ocular musculature, it may be assumed that the pressure, hyperæmia, or other factor of the first category is located toward the anterior extremity of the nuclear mass for the third nerve. When the internal rectus, the superior and inferior recti, and the inferior oblique are involved independently of the interior muscles, the pressure or disease is located further back, but in front of the nucleus for the fourth nerve. If all the parts supplied by the third nerve, interior and exterior, are involved, the causative factor affects both the anterior extremity and more or less of the main nuclear mass.

A paralysis of all the exterior muscles supplied by a third nerve, while the interior muscles remain intact, does not necessarily imply that the causative factor of the first category involves the body of the nucleus of the third nerve. Professor Frankl-Hockwart reports a case in which, with a paralysis of all the motor muscles supplied by the third nerve, the accommodation and pupil movements were maintained normally.¹ This, according to the generally accepted view, would indicate an affection or a pressure upon certain and only certain parts of the nuclear mass for the third nerve.

Autopsy showed no affection of the nucleus or ciliary ganglion, but an acute interstitial neuritis of the trunk of the third nerve in its passage at the base of the cranium.

Such exceptional cases are extremely rare, but should caution against too positive diagnosis.

Paralysis of a single muscle from nuclear affection occurs most frequently in the external rectus or superior oblique. Since each of these muscles is supplied from a separate group of cells it is easy to see how an individual muscle may be singled out for disability. When pairs of muscles acting in the same lateral direction are affected, the others remaining intact, there must naturally be difficulty in interpreting the character of the nuclear difficulty, since there must be a region of the nuclear mass which is unaffected while two separated areas must be disabled. When two muscles, however, each acting vertically, are at the same time alone affected, it is less difficult to

¹ "Paralysis of Third Nerve from Interstitial Neuritis." Obersteiners Arbeiten aus den Neurologischen Institute. IX Heft, 1902.

suppose that the disabling factor passes from one to the other side of the nuclear mass. Again, when from nuclear causes muscles of the two eyes acting diagonally, as, for example, the right superior and the left superior oblique, we have again a pathological problem of much intricacy to solve.

ÆTIOLOGICAL FACTORS OF THE SECOND AND THIRD CATEGORIES.

When we turn to this category a very considerable array of causes is to be considered. It is unnecessary to discuss each separately here or even to enumerate all to which such paralyses have been attributed.

It is well known that nuclear paralyses are often associated with tabes. Attention was many years ago called to this by Jonathan Hutchinson and is now commonly observed. It is an important observation that for the majority of the cases it is only the exterior musculature that is affected with tabes, accommodation and pupil reflex remaining generally intact or only partially disabled.

The findings from autopsies have usually been a gray degeneration of the nuclear cells, which in some instances have been almost entirely replaced by connective tissue. Referring to Section LXVII the importance of the blood-supply to the nuclear mass, especially the posterior portion of it, through the median arteries of the basilar trunk of the posterior cerebral artery, is here emphasized.

Conditions which induce atrophy of the optic nerves often also induce atrophy of the nuclear cells.

The following is a typical illustration of paralysis of all the branches of the third nerve with loss of sight from atrophy of the optic nerve:—

January, 1888, Miss K., aged 40, had been subject for many years to headaches of intense character. She had taken drugs of various kinds and had resorted to other expedients with no relief when, five years ago, she became conscious of a drooping of the left upper lid. She soon after noticed that although she could read to herself with no especial difficulty, if she attempted to read *aloud* she saw double. She relinquished her occupation and rested, with the result of a temporary improvement, but two years ago began to lose the sight of the left eye, and its movements became more restricted.

At present she has intense pains in the temples, especially in the left, a sense of stiffness about the left eye and often *attacks of vertigo*. The left eye is sightless and the ophthalmoscope shows atrophy of the nerve.

Patient rests well at night, but as soon as she opens the eyes in the morning pain and vertigo commence and she requires a long time, sometimes an hour or more, for dressing.

The following conditions are observed in respect to the mobility of the eyes and their surroundings:—

Right eye, rotations normal. Left eye, ptosis, complete so far as the special muscle of the lid is concerned, but by the aid of the frontal muscle she can nearly uncover the upper half of the cornea. The pupil is widely dilated.

The eye can be directed toward the left temple, and in this direction it has the full normal excursion. Can carry the pupil inward as far as the median line, but no further. There is no direct upward or downward movement, and when the right eye rotates directly in or out there is very slight torsion. When, on the other hand, the right eye moves down, the left eye performs a very distinct torsion, the upper extremity of the vertical meridian of the cornea moving toward the median plane about 10° of arc, and the eye turns down and out. There is a slight torsion out when the right eye is directed upward. Careful examinations were made of the movements of the cornea by the aid of a narrow strip of white paper attached to the lower half of the cornea.

It is evident that in this case the fourth and sixth nerves remained intact.

Disseminated sclerosis of the brain substance might readily bring about an atrophy of the optic nerve as well as the nucleus of the oculo-motor nerves. Dufour mentions two cases of disseminated sclerosis with oculo-motor paralysis, from the experience of others.

Nuclear paralysis is associated also with syringomyelia.

It is evident that the pressure of tumors in the vicinity of the nuclear mass may be an important factor in the induction of nuclear paralysis. The tumor may have its origin in the white substance, in a nerve or nerve sheath or in the cortex. In 1879¹ I reported a case of tumor of the auditory nerve which induced paralysis of the exterior and interior ocular muscles.

Tubercular tumors are more likely than others to induce paralysis of muscles supplied by fibers from separated areas of the nuclear mass by affecting isolated parts of the nuclear mass.

Gummata from syphilitic affections include perhaps the greatest number of inducing causes of nuclear paralysis.

As these tumors are located in so many parts of the brain substance, and as they are of more frequent occurrence than other brain tumors, it is not surprising that the suggestion of syphilitic origin should at once occur in a case of ophthalmoplegia. Since many other causes contribute to the sum of such cases, it is therefore unjustifiable to accept the suggestion without distinct evidence.

¹ "Tumor of the Auditory Nerve Occupying the Fossa of the Cerebellum." George T. Stevens: Archives of Otolaryngology, vol. viii, p. 171, 1897.

Hæmorrhages in the vicinity of the nuclear mass may, by pressure or by isolating it from the cortex, induce paralysis of ocular muscles with or without hemiplegia. Abscess or tubercle may also be the source of pressure.

Infectious diseases sometimes induce nuclear paralysis. This is especially true of diphtheria. Influenza is also influential in the same way, and exanthematous diseases are said to have induced nuclear paralysis.

Poisons from toxic substances introduced into the system or generated within it must be included among the factors of this category. Nicotine, lead, and other toxins have been shown to be agents in this direction, and illuminating gas¹ has been shown to be another.

Among the deleterious influences from within, Dr. H. Cohn reports nuclear paralysis from diabetes.

The conditions mentioned are only examples of many forms of inducing factors in this category which might be mentioned.

SECTION LXIX.

FASCICULAR PARALYSIS.

Much the same forms of paralysis as those which occur from changes in the nuclear masses may follow injury in the course of the fibers which pass from the nuclear cells to form the trunks of the nerves supplying the eye muscles. Pressure, degeneration, localized hæmorrhage, or inflammatory processes may so impair the conductivity of these fibers, all or a part, that total or partial ophthalmoplegia may result. The view held by Mauthner that all such paralyses as those mentioned in connection with nuclear disability must be traced to that source is shown by such cases as that mentioned at page 480 to be incorrect, for in that case the conditions of paralysis which would naturally direct attention to a nuclear affection were located even further from the nuclear masses than are the connecting fibers, being situated in the trunk of the nerve itself.

It is unnecessary to suggest all the agencies through which this part of the nervous supply of the eye muscles may suffer. The causes already mentioned may in general be similar in both classes. Single

¹ Dr. H. Knapp: Archives of Ophthalmologie, vol. viii, p. 493.

symptoms or the grouping of symptoms in an individual case may perhaps enable a diagnosis to be made.

Some of the ultimate causes for the injury or destruction of the nuclear cells or the connecting fibers have already been suggested. Tuberculosis, tabes, syphilis, meningitis, diphtheria, toxic agencies, atheromatous conditions of the cerebral arteries, trauma, and alcoholism are among these ultimate causes.

The trunks of the third, fourth, and sixth nerves as they pass through the cavernous sinus may be subject to pressure, to inflammation, degeneration, and other influences which may induce paralysis.

Attention was called by Panas, of Paris,¹ to the intimate relation between fracture of the petrous bone and paralysis of the sixth (abducens) nerve. Later, Dr. O. Purtscher, of Klagenfurt, collected reports of a very considerable number of cases in which basilar fracture had been succeeded by paralysis of the abducens.² Later still, Friedenwald collected a number of more recent cases of basal fracture with the same paralysis.³ In several of these cases the nerve had been torn in connection with the fracture. In other cases the nerve was compressed by a clot. In some of these later cases the paralysis was delayed some days after the injury. Panas, at the International Congress of Ophthalmology of 1894, sums up his conclusions respecting basilar fractures and ocular paralyses as follows:—

1. Most traumatic ocular paralyses depend on basal fracture.

2. The absence of fracture of the bones of the vault of the orbit does not exclude fracture at the base.

3. The compression is from the fracture itself or from blood extravasated into the cranium. In the first case the paralysis is more or less immediate; in the second it may show itself only after some time.

Traumatic paralysis or obstruction of other ocular muscles may occur as the result of hæmorrhage within the sheaths of the muscles or of hæmorrhagic pressure upon branches of nerves as well as rupture or injury of the muscle or nerve.

¹ Translated by Dr. Harry Friedenwald, in *Archives of Ophthalmology*, vol. xxiii, No. 4.

² *Archives of Ophthalmology*, 1894, p. 403.

³ *Archives d'Ophthalmologie*, 1881.

PERIPHERAL PARALYSIS.

After reaching the orbit there are still many forms of disease or injury which may interfere with their function.

From pure affections of the nerves we are much more likely to find isolated paralyses from causes within the orbit than from intercranial causes. A paralysis of the externus or of the internus muscle not unfrequently occurs from peripheral nerve disabilities. Yet, it is not generally safe to assume that an isolated paralysis is of peripheral origin.

In three cases under my own observation the patients consulted me in regard to sudden attacks of diplopia, in each of which paralysis of the superior rectus muscle, with no other apparent disability, was found. Each improved while under treatment, but in each case the patients succumbed within a few months, one to abscess of the brain, the other two to cerebral tumor.

There are, however, cases in which the diagnosis of peripheral paralysis is less difficult. A patient takes a long drive in a severe wind and on the following day has diplopia. It may be assumed that the peripheral nerves have experienced a change from the atmospheric conditions. There are many contingencies of this kind, each of which must be judged upon its own special characteristics and antecedents.

SECTION LXX.

OBSTRUCTIVE COLYTROPIA.

The forms of paralysis which Mauthner calls *orbital paralyses*, are mostly of the class of obstructions.

A tumor at the base of the orbit might limit or abolish the movements of the eye. Such a limitation would, except in the most unusual cases, be confined to the movements of a single eye. Extensive hæmorrhage might have a similar restrictive effect, as might also a tenonitis, an abscess, or periostitis. Tumors of the bony wall of the orbit, in a nasal cavity or other neighboring cavities, may also obstruct the ocular movements. In most of the cases of these classes the diagnosis between paralysis and obstruction can be made. The exophthalmos from tumors situated behind the eyeball, the protrusion of the tissues at the side of the eye in periostitis, the œdema accom-

panying hæmorrhage, and the palpation of abscess are among the diagnostic means.

Among the most common sources of obstruction within the orbit may be mentioned periostitic swellings, usually of syphilitic origin, and which occur more frequently than elsewhere in the roof of the orbit. The eye is generally pressed forward and depressed while its movements upward and from side to side are restricted. In many of these cases, by pressing the end of the finger between the eye and the roof of the orbit, the tumor, painful to the patient, may be felt by the surgeon.

Gummosus tumors may also occupy the connective tissues of the orbit. Walter¹ reports a case in which such gummata occupied both orbits and so completely invaded the muscles themselves that these could not be seen.

So also these syphilitic periostitic affections may at length affect the bony walls, inducing caries and necrosis. Gummata sometimes force their way through the superior orbital fissure and involve the muscles as though originating in the orbital cavity.

SECTION LXXI.

TRAUMATIC COLYTROPIA.

These follow various forms of injury. A fracture of the border of the orbit, penetrating wounds and more frequently than other traumatic causes, the unskillful severance of a tendon in operations for strabismus, are examples of this form of obstruction, without paralysis of the nerves.

Among the reported cases of paralysis of the inferior oblique is one of injury of the lower border of the orbit in which the reported conditions would indicate that the inferior oblique was quite intact, the injury being to the insertion of the inferior rectus.

¹ *Klin. Monatsbl. für Augenheilkunde*, xxxiii, p. 8.

SECTION LXXII.

ARRESTED DEVELOPMENT OF OCULAR MUSCLES.

Cases are occasionally met with in which anatomical examinations have shown that there has been, to a greater or less extent, an arrest of development.

Conditions of limitations of the rotations of both abducens muscles of congenital origin, in which each of the external recti have been incapable of inducing rotation beyond the median plane, have been reported by a number of authors. In the reports of the great majority of these cases there is such an absence of essential data that no conclusion can be drawn from them as to the nature of the defect, except in a few instances where post-mortem examinations have shown absence or arrested development of a greater or less number of the eye muscles.

The conditions associated with or which may be the causes of most of the cases of congenital paralysis of both abducentes or of these and other muscles, or indeed of either of the eye muscles, may be summed up nearly as follows:—

In a certain group there is a general rachitic state in which the muscles or the nerve centers or both participate.

In a second there may be such anomalous insertions of the tendons that with well-developed and healthy muscles there may be found mechanical obstructions to movement in certain directions.

In a third group the origin is to be found in injuries suffered at birth.

In yet a fourth group the muscle body is formed, not of true muscle fiber, but of connective tissue.¹

¹ Leszinski reports "*congenital absence of the outward movements of both eyes,*" with a valuable resumé of the bibliography (New York Medical Journal, February 27, 1897). Lawford mentions a case of a man who had congenital deviation of each eye to the right. Post-mortem examination showed that the internus of the right eye was absent and the external rectus of the left was imperfectly developed (Ophthalmologic Review, 1887). Uhtoff, a case of congenital squint in which the external rectus was replaced by a connective cord with normal insertion (Jahrb. für Ophthal., 1882). Harles: "Absence of Obliques." Archiv. für Physiol., Bd. iv, 23. Dr. Edward Stieren reports (American Medicine, April 11, 1903) the case of a child, aged 6, with inability to direct the eyes downward. Under the influence of local anæsthetics the lower ocular conjunctiva of one eye was freely incised. Careful examination aided by a small strabismus hook failed to reveal "the slightest rudiments of an inferior muscle."

SECTION LXXIII.

TREATMENT OF COLYTROPIA.

The treatment of ophthalmoplegia should depend on the nature of the ultimate cause. A syphilitic gumma may be reduced by appropriate treatment, and similar indications must govern in other cases, though there may not be in all cases equally favorable prognosis. In fact, the prognosis is generally bad.

Cases of peripheral paralysis often recover spontaneously.

Strychnine, electricity, potassium iodide, and a variety of remedies have been used with probably about equal results. The purely peripheral cases get better, the others usually do not. It is self-evident that circumstances and environments which tend to a betterment of the general health offer greater encouragement than more depressing circumstances.

In cases of alcohol or nicotine poisoning, strychnine is especially indicated.

In slightly parietic cases a prism may afford material relief, and such exercises by prisms as those mentioned at Section XLV may be of service.

Surgical treatment can only be available as an aid for cosmetic purposes. A very considerable contraction of a paralyzed internus may help to conceal an unpleasant deformity. It will not restore single binocular vision except within very narrow limits. The practice which is sometimes adopted of performing a complete tenotomy of an opposing muscle is of course to be unqualifiedly condemned. The surgeon is not warranted in disabling an external rectus because the internal rectus is already disabled.

A ground glass before the disabled eye furnishes the most effective means of relief to the diplopia in the least conspicuous manner.

INDEX.

- Abducens nerve, 75
Abduction, 279
Accidental images, 115
Accommodation and axial adjustments, 257
 and convergence, 397
Action of paralyzed muscles, limitation of, 469
Adduction, 279
Ailerons, ligamentous, 67
Amblyopia of strabismus, 361
 ex anopsia, 369
Amphibious reptiles, eye muscles, 31
Anatomy of ocular muscles, 28
Angle, alpha, 372
 ascensional, 92
 facial, 211
 lateral, 93
Anomalous conditions, degrees of, 258
 less than strabismus, 14, 214
 not consistent with physiological state, 444
 of strabismus, 354
Anophoria, 215
 and carriage of head, 314
 and consumption, 221
 and declination, 312
 and trachoma, 313
 definition of, 215
 exposition of, 219
 operations for, 345
 treatment of, 231
Anotropia, 388
 declination with, 390
 definition of, 215
 determination of, 392
 deviations from, 389
 esotropia from, 392
 illustrations of, 391
Antipathy to single vision, 426
Apparent vertical and horizontal meridians, 194
 determination of, 196
Arteries, basilar and branches, 85
 of the muscles, 69
 of pons Varolii and mid brain, 85
Asthenopia, muscular, 18
Astigmatism and myopia, 251
Asymmetry of face, 320
Attention controlled by practice, 128
Axial adjustments, accommodative, 257
Bell's experiments on animals, 7
Birds, eye muscles, 32
Brachycephalic skull, 205
Bridles, 67
Calipers, Broca's, 206
Capsule of Tenon, 61
 in strabismus operation, 63
Carriage of head with anomalous conditions, 191, 221, 254, 302, 311, 314
Carriage of body, see carriage of head.
Categories of paralysis, 445
Center of rotation, 87
Center of similitude, 86
Cephalic index, 43, 205
Cerebral localization, 448
Choanoideus muscle in batrachians, 30
 in mammals, 33
 in sheep, 34
Classification of anomalous conditions, 214
 of crania, 205
Clinical features of non-strabismic anomalies, 306
Clinoscope, description of, 237
 lens, 238
 method of testing, 240
 method of using, 239
 objectives for, 197
 suggestion of, 21
Colytropia, 444
 treatment of, 488
Comparative anatomy of eye muscles, 29
Consumption and adjustment of eyes, 25, 191
Convergence, absence of, 447
 and accommodation, 397
 in estimating distance, 129
Convex glasses as prisms, 400
Corresponding points, 166
Cortex, lesions in oculo-motor paralysis, 446
 and nuclei of oculo-motor nerve, 83
Cortical region for impulse to eye muscles, 447

- Craniostat, Stevens's, 45, 208
 Crania, types of, 42, 205
- Declinations, 233
 and heterophoria, 23, 243
 and strabismus, 248
 and torsions, 108, 237
 classification of, 215
 definition of, 235
 doctrine of, 22
 expression of face from, 252
 instruments for determining, 237
 local symptoms of, 249
 operative treatment for, 340
 pose of head from, 254
 results of examinations, 241
 scheme of relations, 245
- Development, arrest of, 445, 487
- Deviations, determination of, 196
 in exclusion, 285, 371
 measurements of, 469
 of horizontal meridians, 194
 of paralysis, 469
- Diplopia, analytical key to, 466
 caused by prisms, 264
 heteronymous, 364
 homonymous, 364
 monocular, 366
 tests by, 376
 vertical, 365, 375, 385
- Diameters of eyeball, 89
- Direction of influence of ocular muscles, 93
- Directions of planes of vision, 203
- Divergence of retinal meridians, 235
- Dolichocephalic cranium, 205
- Equilibrium, 21, 260
- Esophoria, 215, 286
 and abduction, 287
 and anophoria, 298
 and blepharitis, 310
 and declinations, 288, 300
 and distant disturbances, 301
 facial expression of, 323
 first recognition of, 19
 in accommodation, 284
- Esotropia, 378
 and hypertropia, 381
 associated symptoms, 386
 definition of, 116
 oblique deviations, 380
- Estimation of size of objects, 131
- Euthyphoria, 214
- Exophoria, 215
 and declination, 243, 299
 and insufficiency of interni, 19
 discussion of, 286
 facial expression of, 323
 in accommodation, 284, 290
- Exotropia, 216
 compound deviations in, 383
 description of, 288
 rotations in, 383
- Expositions of classes, 217
- Expressions, facial, from conditions of
 eye muscles, 318
 from declinations, 252
- Extendo-contraction, 241
- External capsule, 65
- External rectus muscle, 51
 paralysis of, 455
- Eye muscles of amphibious animals,
 30
 of birds, 32
 of fishes, 29
 of mammals, 33
- Facial angle, 207
- Facial expression, 252, 318
- Field of binocular vision, 165
- Fishes, eye muscles of, 29
- French Academy of Sciences, 10
- Goniometer, Stevens's, 207
- Gyrus angularis, 83
- Heterophoria, 215, 261
 and insufficiency of the interni, 20
 development of system of, 18
 historical notes of, 14
 methods of examination in, 272
 nature and causes of, 297
 operative treatment of, 347
 relation to declinations, 245
 time for attending to, 271
- Heterotropia, 216
 relation to declinations, 248
 divisions of, 378
- Horo-pter, 178
 subjective, 181
- Hypersophoria, 216
- Hyperesotropia, 216
- Hyperexophoria, 216
- Hyperexotropia, 216
- Hyperphoria, 215
 general description, 291
 not previously described, 19
 vision in, 293
- Hypertropia, 216, 378, 384
 amblyopia of, 387
 associated with esotropia, 381
 not always noticeable, 385
 percentage of cases, 386
 symptoms, 386
- Illusions, visual, 131
 Hering's, 133
 Lehmann's, 136

- Illusions, Müller-Lyer, 132
 of height and breadth, 132
 Poggendorff's, 137
 Wundt's, 132
 Zöllner's, 133
 Images, accidental, 115
 multiple, 366
 Incoördinate movements, 446
 Index, cephalic, 43
 orbital, 40
 Inferior oblique muscle, 53
 paralysis of, 464
 Inferior rectus muscle, 51
 paralysis of, 464
 Insufficiency of the externi, 19
 Insufficiency of the interni, 14, 283
 Instruments, Stevens's, 343
 Internal capsule, 64
 Internal rectus muscle, 50
 paralysis of, 457
 Interorbital distance, 42, 46
 Irradiation, 136

 Katoporia, 215, 222
 and carriage of head, 315
 and declinations, 312
 operations for, 345
 treatment of, 231
 Katotropia, 215, 223, 388
 and declinations, 390
 deviations in, 389

 Law of Listing, 111, 183, 195, 260
 Law of torsions, 113, 115, 185
 Law of unconscious conclusions, 176
 Leaning of corneal meridians, 123
 Lens, stenopaic, 227
 Limitation of action of paralyzed
 muscles, 469
 Line, visual, 92
 median, 92
 base, 92

 Mammals, eye muscles of, 33
 Memorandum, blank for, 305
 Mesocephalic cranium, 205
 Method of determining axes of orbit,
 208
 Motor areas for eye movements, 448
 Movements of the eyes, 28
 associated, 103
 Movements of globe, center of, 86
 Muscles, motor, of the eyes, 48
 Muscular consciousness, 125
 Mydriatics and apparent hyperme-
 tropia, 399
 influence of in correcting deviations,
 402
 Myopia and declination, 250

 Nerves of the ocular muscles, 71
 abducens, 75
 distribution of, 72
 nuclear origin of, 76
 oculo-motor, 72
 trochlear, 74
 Normal directions of planes of vision,
 203
 Nuclear cell groups, 79
 circulation to, 84
 connection with cortex, 82
 Nuclear paralysis, 470
 Nystagmus, 436
 in cortical disease, 439
 of hysteria, 439
 of miners, 440
 treatment of, 442

 Obstruction, 445, 485
 Oculo-motor nerve, 71
 Ophthalmic artery, 70
 vein, 70
 Ophthalmometer of Helmholtz, 88
 Ophthalmotrope, Stevens's, 114
 Ophthalmoplegia externa, 476
 interna, 476
 locality of lesion, 478
 total, 476
 Optic axes, 44
 in ethnology, 46
 method of ascertaining, 45
 plane of, 44
 Orbital angle in comparative anat-
 omy, 47
 in man, 42
 Orbital muscles, 67
 Orbito-ocular aponeurosis, 61
 Orbits, 35
 axes of, 41
 bases of, 46
 borders of, 39
 characteristic forms of, 44
 comparative index of, 46
 determination of axes, 208
 external wall of, 37
 form of in relation to cranium, 209
 influence on declinations, 407
 measurements of, 39
 Orthophoria, 215, 261

 Paralysis, 445, 452
 aetiology of nuclear, 479
 cases of, 456, 458
 causes of nuclear, 479
 diplopia of, 453
 forms of, 452
 key to relations of double images,
 466
 nuclear, 470

- Paralysis, objective manifestations
 of, 466
 of external rectus, 455
 of inferior oblique, 464
 of inferior rectus, 460
 of internal rectus, 457
 of oculo-motor nerve, 474
 of superior oblique, 460
 of superior rectus, 457
 rotations and leanings in, 462
- Perception of space, visual, 125
- Perspective, 137
- Phorometer, 273
- Physiology, 86
- Plagiotropia, 120
- Planes of head, 90
 of action of muscles, 94
 of vision, normal, 200
- Position of eyes in animals, 28
- Prism, vertical, in strabismus, 400
- Procedure in examinations, 302
- Pseudoscope, 151
- Psychic colytopia, 450
- Psychical elements in vision, 130
- Psychological laboratories, investigations in, 127
- Ptosis, 447
- Raddrehungswinkel, 93
- Regard, field, line, plane and point of, 92
- Relation of plane of vision to cranium, 214
 of visual lines to each other, 215
- Rod test of Maddox, 276
- Rotations of the eyes, 225
 center of, 87
 determination of extent, 225
 in converging strabismus, 403
 in relation to adjustments of eyes, 221
 in relation to plane of vision, 210
 standards of, 230
- Sections of cranium, 91
- Size of objects, visual perception of, 131
- Space, visual perception of, 124
- Spasm, division of colytopia, 445
- Squint, secondary, 405, 469
- Stereoscope, 143
 of Brewster, 145
 of Helmholtz, 145
 of Landolt, 149
 of Wheatstone, 143
- Stereostroboscope, 151
- Strabismus, 354
 amblyopia of, 361, 368
 and hypermetropia, 397
- Strabismus and myopia, 397
 Bell's experiments on, 7
 causes of, 395
 concomitant, 356
 deviations of, 371, 404
 diplopia of, 362
 disappearance of during sleep, 404
 diverging converted to converging, 432
 doctrine of Donders, 13, 397
 double vertical, 388
 early operations for, 9
 effect on carriage of body, 358
 effect on health, 357
 effect on vision, 357
 glasses used for, 416
 heredity of, 407
 historical notes of, 1
 multiple images in, 366
 object of operations, 418
 oblique deviations, 359
 one eye selected for fixation, 358
 operations by Dieffenbach, 10
 operations by Graefe, 12, 350
 operations by Liston, 11
 operations by Lucas, 10
 operations by Taylor, 4
 paralytic, 356
 periodic or intercurrent, 393
 prophylactic methods against, 415
 results of treatment, 422
 resumé of treatment, 423
 table of cases, 408
 tests by diplopia, 373
 tests by exclusion, 372
 tests by Hering's method, 377
 tests by stereoscope, 376
 treatise by Taylor, 4
 treatment of, 414
 treatment of by empirical method, 421
 treatment of by rational method, 419
 views concerning, 1
- Subjective horopter, 181
- Superior oblique muscle, 52
 paralysis of, 460
- Superior rectus muscle, 51
 paralysis of, 457
- Sursumduction, 279
- Synopsis of classification, 214
- Talantropia, 437
 of miners, 440
 treatment of, 442
- Tendons, breadth of insertions, 54
 design indicating insertions, 59
 distances from corneal border, 57
 Fuch's study of, 55

- Tendons, insertions and declinations, 406
 variations of insertions, 58
 Tendon contraction, 352
 Tenotomies, graduated, 348
 by Graefe, 350
 by Guerin, 9
 Terms, definition of, 90
 Test letters of Snellen, 129
 Tests, auxiliary in heterophoria, 278
 Torsions, definition of, 93
 law of, 113, 115
 law of adjustments, 120
 method of testing, 201
 not to be confounded with declinations, 108, 218
 phenomena, causes and laws of, 106
 positive and negative, 108
 stereoscopic diagram indicating, 123
 voluntary, 200
 well defined meaning of, 242
 Torticollis from hyperphoria and declinations, 302
 Trauma, division of colytopia, 445, 486
 Treatment of non-strabismic anomalies, 327
 by decentering glasses, 334
 by gymnastics by prisms, 330
 by prisms as spectacles, 333
 by tonics and change, 328
 surgical, 321, 338
 Trochlear nerve, 74
 Tropometer, 225
 examination by, 227
 influence on doctrine of anomalies, 24
 scale for, 227
 Types of crania, 209
 Unconscious conclusions, 153
 Veins of the muscles, 70
 Vessels supplying muscles of the eye, 69
 Vertical meridians, apparent, 194
 determination of positions, 197
 positions with different adjustments of eye, 99
 Vertical tensions and declinations in strabismus, 61
 Visual angle, 129
 Visual perception of space, 124
 binocular vision in, 142
 conditions according to Helmholtz, 125
 illumination an element in, 140
 mental process in, 138
 rôle of convergence in, 129
 Word blindness, division of colytopia, 445, 450

INDEX OF AUTHORS.

- Ægineta (Paulus). Mask for strabismus, 2
- Allen. On fourth nerve, 75. On sixth nerve, 76
- Arata. Drawing of sheep's eye, 76
- d'Astros. Blood supply of nuclei of motor nerves, 473
- Barrow. Center of motion of eye, 86
- Baudens. Operation for strabismus, 415
- Baudrus. Capsule of Tenon, 63
- Baumgarten. Muscle replaced by connective tissue, 457
- Beavor. Cerebral localization, 447, 448
- Bell (Sir Charles). Experiments on ocular muscles of animals, 7
- Bell (J. D.). Nystagmus, 438
- Benedikt. Measurement of crania, 211
- Bernheimer. Nucleus of third nerve, 77, 83, 472. Nystagmus, 442. Motor nerve supply, 447
- Böhm. Periodic strabismus, 393
- Bonnet. Capsule of Tenon, 63. Operation for strabismus, 414
- Bouillaud. Cerebral localization, 448
- Bourdon. Visual perception of space, 129
- Boyer (Arthur A.). Drugs in functional nervous disorders, 330
- Boyer (Lucien). Quotation from *Le Cat*, 5. Muscles and capsule, 63. Strabismus, 359, 414
- Brewster. Stereoscope, 145
- Broca. Measurements of orbits, 40. Method of finding orbital axis, 44. Head calipers, 207. Cerebral localization, 448
- Bruce. Origin of third nerve, 72, 78, 84
- Brück. Unconscious conclusions, 153
- Buffon. Strabismus, 356
- Cameron. Illusion, 135
- Celsus. References to strabismus, 2
- Charcot. Disseminated nodular sclerosis, 439. Lesion in word blindness, 451
- Cohn. Nuclear paralysis, 483
- Columbus (Realdus). Description of Tenon's capsule, 62
- Conkling. Nystagmus, 438
- Court. Nystagmus, 438
- Crété. Prism, 304
- Critchett. Operation for tenotomy, 350
- Cruveilhier. Axes of orbits, 35
- Cunier. Operation for strabismus, 414
- Cushing. Transmission of nerve energy, 448
- Darwin (Erasmus). Views on strabismus, 3
- Decodé. Nystagmus, 440
- Dejernine. Lesion in word blindness, 451
- Desmarres. Operation for strabismus, 12
- Dieffenbach. Operation for strabismus, 9, 359, 414
- Dix. Operation for strabismus, 414
- Donders. Doctrine of strabismus, 13, 355. Center of motion, 86, 89. Action of muscles, 100. Torsions, 113. Accidental images, 116. Corresponding points, 167. Leaning of retinal meridians, 234. Accommodation, 257. Accommodation and convergence, 397, 399. Hypermetropia and converging strabismus, 416
- Dove. Experiment with electric spark, 124, 153, 181, 183
- Doyer. Center of motion, 87
- Dransart. Nystagmus, 440
- Duane. Parallax test, 283, 373
- Dufour. Nuclear paralysis, 482
- Duret. Circulation to the nuclei, 85
- Duval. Oculo-motor nerve, 72
- Edinger. Origin of third nerve, 73
- Elschnig. Circulation of the eye, 70
- Emmert. Measurements of crania, 41. Orbital angle, 47. Insufficiency of interni and orbital axes, 298
- Euclid. Ideas of binocular vision, 143
- Exner. Cerebral localization, 448
- Fernandio. Nystagmus, 439
- Ferrier. Cerebral localization, 447, 448
- Fick. Terminology of rotations, 228
- Flourens. Cerebral localization, 448
- Frankl-Hockwart. Paralysis of third nerve, 480
- Fritsch. Cerebral localization, 448
- Fuchs. Insertions of eye muscles, 50, 59. Paralysis of superior rectus, 459

- Galen. Tunica sexta, 62. Views of binocular vision, 143
- Galezowski. Latent divergent strabismus, 18
- van Gehuchten. On sixth nerve, 84
- Giraud-Teulon. Center of motion, 89. The horopter, 177
- Golz. Cerebral localization, 448.
- von Graefe. Strabismus, 12. Insufficiency of the interni, 14, 282, 284, 290, 291, 302, 356. Insufficiency of the externi, 19. Equilibrium, 21. Abduction and Adduction, 279. Gymnastics with prisms, 330. Treatment of asthenopia, 337. Operation for tenotomy, 350. Deviation in strabismus, 359, 360, 404. Antipathy to single vision, 377, 426. Periodic strabismus, 393. Squint and expression of disease, 396. Accommodation in paralysis, 398. Treatment of strabismus, 415. Nystagmus, 438, 440, 441
- Grossman. Accidental images, 119
- van Gudden. Oculo-motor nerve, 72
- Guerin. Tenotomies, 9
- Harles. Absence of obliques, 487
- Hasse. Asymmetry of skull, 320
- Helmholtz. Retinal meridians, 22, 194, 199, 202, 234, 235. Center of motion, 86. Divisions of the head, 90, 93. Torsions, 99, 100, 107, 115. Accidental images, 117, 122. Muscular consciousness, 125. Illusions, 134, 135. Stereoscope, 145, 148. Corresponding points, 167, 169, 176. The horopter, 177, 180, 184
- Henly. Divisions of the head, 90
- Hensen. On third nerve, 74, 79
- Hering. Action of muscles, 94. Illusion, 133, 134. Corresponding points, 166. The horopter, 180. Retinal meridians, 195, 198, 234. Experiment with falling bodies, 377. Test of strabismus, 423
- Hess. Accommodation and convergence, 398
- Heurman. Claims of John Taylor, 5
- Hewitson. Nystagmus, 438
- Hippocrates. Distortion of eyes from epilepsy, 1
- Hitzig. Cerebral localization, 447, 448
- Hook. Visual angle, 128
- Horsley. Cerebral localization, 447, 448
- Hunter. Amblyopia in strabismus, 371
- Hutchinson. Total ophthalmoplegia, 471
- Jackson. Cerebral localization, 449
- Johnson. Amblyopia in strabismus, 369
- Judd. Illusion, 135
- Kahler. On third nerve, 80
- Knapp. Causes of paralysis, 483
- Kolliker. Measurements of cones, 129
- Krause. Fibers in third nerve, 71
- Kussmaul. Word blindness, 450
- Laborde. Oculo-motor nerve, 72
- Ladd. Transmission of nerve energy, 448
- Landolt. Insufficiency of the interni, 18. Stereoscope, 149
- Lawford. Congenital absence of muscles, 487
- Lawrence. Deviation in strabismus, 360
- Lebreich. Operation for tenotomy, 350
- Le Cat. Description of John Taylor, 5
- Le Conte. Torsions, 114. Accidental images, 119. Retinal meridians, 195, 234
- Lehman. Illusion, 136
- Leszinski. Congenital absence of muscles, 487
- Liston. Operation for strabismus, 11, 414
- Listing. Action of muscles, 100. Law of, 111, 112, 183, 195, 260
- Lucas. Operation for strabismus, 10
- Luschka. Origin of fourth nerve, 75
- McAllister. The visual field, 135
- McKenzie. Strabismus operation, 11
- Maddox. Rod test, 276
- Maitre-Jan. Views of strabismus, 2
- Malgaigne. Capsule of Tenon, 63
- Marina. Nucleus of third nerve, 83
- Mauthner. Nuclei of ocular nerves, 80, 478. Center of motion, 89. Action of muscles, 97, 100. Torsions, 106, 114. Paralysis of ocular muscles, 444, 446, 459, 463. Nuclear paralysis, 483. Orbital paralysis, 485
- Meisner. Retinal meridians, 195.
- Merkel. Fibers in fourth nerve.
- Meyer. Ophthalmic artery, 69.
- Mobius. Nuclear centers, 474.
- Van Moll. Corresponding points, 167.
- Motais. Origin of Choanoides muscle, 33. Capsule of Tenon, 64. Ligamentous ailerons, 67.
- Müller (H.). Orbital muscle, 69.
- Müller (J. J.). Center of motion, 86. Subjective images, 166.

- Müller-Lyer. Illusion, 132, 135.
 Munk. Cerebral localization, 448.
 Münsterberg. Stereostroscope, 150.
 Nagel. Voluntary torsions, 201.
 Nettleship. Nystagmus, 437.
 Niden. Nystagmus, 440.
 Noel. Nystagmus, 440.
 Notlmagel. Cerebral localization, 451.
 Nussbaum. On third nerve, 72.
 Obersteiner. On third nerve, 80.
 Panas. Paralysis of superior rectus, 455, 459. Fascicular paralysis, 484.
 Paré (Ambroise). Etiology of strabismus, 2.
 Parinaud. Spasm, 447.
 Perlia. Nucleus of third nerve, 77, 80.
 Pick. On third nerve, 80.
 Pogendorff. Illusion, 135.
 Prentice. Prism diopter, 334.
 Purkinje. Subjective images, 166.
 Purtscher. Fascicular paralysis, 484.
 Reuss. Nystagmus, 438.
 Reute. Accidental images, 115. Action of muscles, 97, 100.
 Rossi. Strabismus, 4.
 Sappey. Axes of orbits, 35. Origin of external rectus, 51. Ligamentous alarons, 67.
 Schäfer. Cerebral localization, 448.
 Schröder. Perspective illusion, 139.
 Schwabe. Origin of eye-muscles, 49. Capsule of Tenon, 64.
 Schweigger. Muscular asthenopia, 18.
 Serieux. Lesion in word blindness, 451.
 Snell. Nystagmus, 438, 439.
 Snellen. Test letters, 129.
 Steel. Illusion, 135.
 Stelwag. Insufficiency of interni, 18.
 Stevens. Terminology of heterophoria, 18. Operations for insufficiency of externi, 20. Anomalies of vertical directions of optic axes, 21. Insertions of eye-muscles in sheep, 35. Craniostat, 45. The horopter, 177. Retinal meridians, 194. Voluntary torsion, 201. Planes of vision, 203. Facial goniometer, 207. Method of determining axis of orbit, 208. Classification and terminology, 214, 444. The tropometer, 225. Standards of rotation, 230. The clinoscope, 237. The lens clinoscope, 240. Astigmatism, myopia, and declination, 251. Facial expression and bodily pose, 252, 254, 313, 318. The phorometer, 273. The stenopaic lens, 277. Gymnastics with prisms, 331. Gymnastics for declination, 331. The rod clinoscope, 332. Accommodation and convergence, 397. Antipathy to single vision, 427.
 Stevens (Charles W.). Grooved director, 353. Nystagmus, 442.
 Stieren. Absence of inferior rectus, 487.
 Stilling. Theory of compression, 49. On fourth nerve, 75.
 Stratfield. Heredity of strabismus, 407.
 Strohmeier. Operation for strabismus, 9, 359, 414.
 Taylor (John). Strabismus operation, 4, 414. Portrait, 27.
 Tenon. Anatomy of orbit, 3. Capsule of, 62.
 Thompson. Nystagmus, 438.
 Toldt. Diameters of orbit, 40.
 Topinard. Measurements of orbits, 40.
 Ulthoff. Muscle replaced by connective tissue, 457, 487.
 Valentin. On sixth nerve, 76. Center of motion, 86.
 Da Vinci (Leonardo). Binocular vision, 143.
 Virchow. Measurements of orbits, 40.
 Volckers. On third nerve, 74, 79.
 Volkmann. Weight of internal rectus, 50. Center of motion, 86. Action of muscles, 94, 100. Visual angle, 128. Stereoscopic images, 147. Corresponding points, 167, 169, 170. The horopter, 180. Retinal meridians, 194, 202, 234.
 Vulpien. Disseminated nodular sclerosis, 439.
 Walter. Gummata of orbit, 486.
 Weber. Visual angle, 128.
 Weiss. Measurements of orbits, 40, 46, 90. Insertions of muscles, 53, 54, 57, 406.
 Wells. Muscular asthenopia, 18. Gymnastics with prisms, 330. Nystagmus, 437.
 Wheatstone. Stereoscope, 143, 145. Pseudoscope, 151. Corresponding points, 176.
 Wood. Pseudoscope, 152.
 Wundt. Visual perception of space, 124, 129. Illusion, 133, 134.
 Zöllner. Illusion, 134.
 Zoth. Asymmetry of skull, 320.

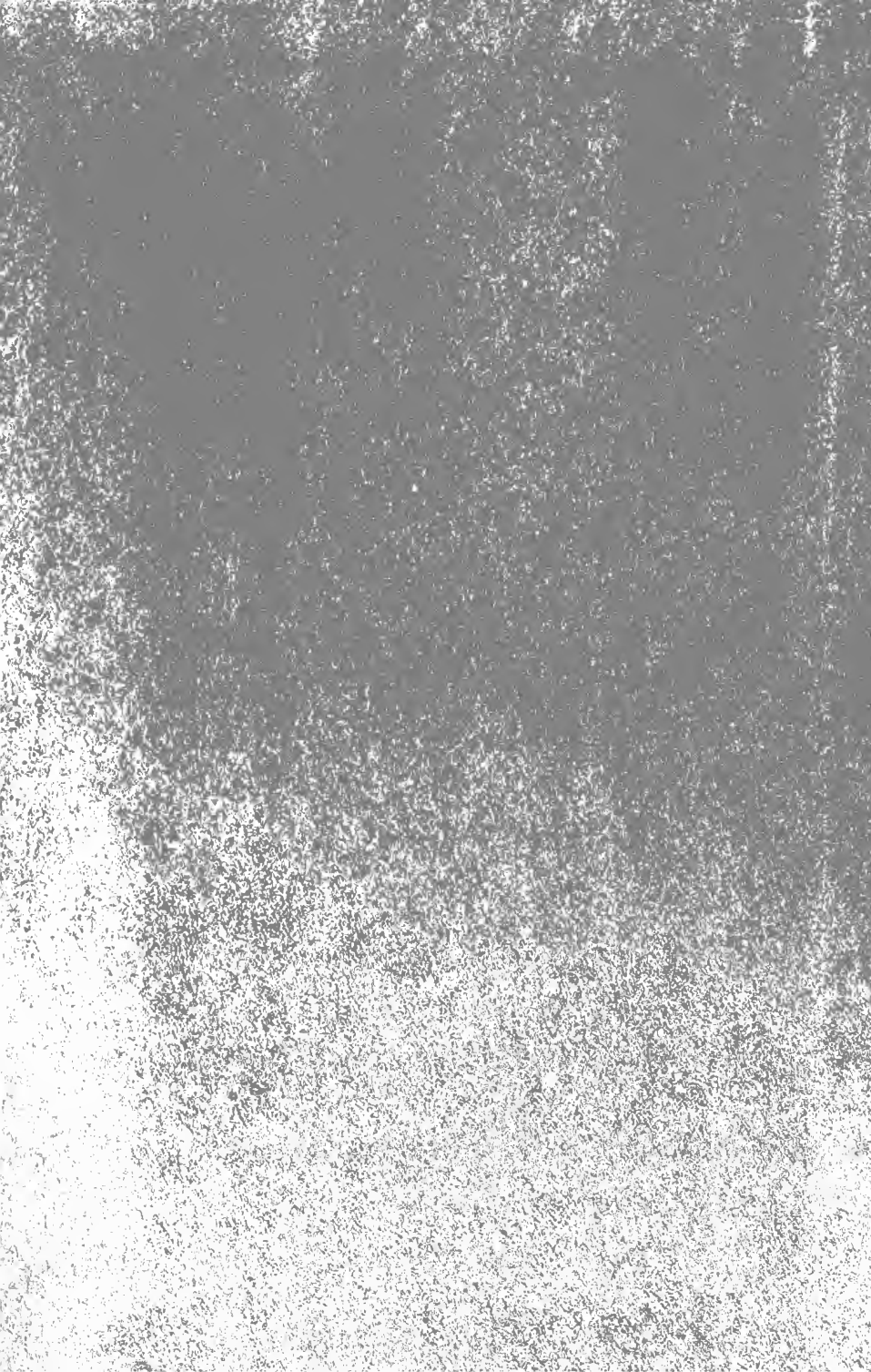

UNIVERSITY OF CALIFORNIA LIBRARY
Los Angeles

This book is DUE on the last date stamped below.

FEB 18 1955

MAY 2 - 1958

MAY 2 - RECD

AUG 29 1958

MAY 2 RECD

DEC 2 1958

DEC

JUN 5 1961

JAN 27 1964

~~BIOMED LIB~~ JAN 14 1972
~~BIOMED LIB~~

JAN 16 RECD

JAN 27 1972

~~BIOMED LIB~~ MAR 22 1982

APR 5 RECD

BIOMED LIB 17 1982

BIOMED LIB

JUN 2 RECD

BIOMED LIB

BIOMED DEC 21 '87

BIOMED 9 1987

JUN 16 1988

JUN 14 1988

REC'D

W
00
844t
706

3 1158 00758 7404

SOUTHERN REGIONAL LIBRARY FACILITY

A 000 414 470 5



