



ALLEN COUNTY PUBLIC LIBRARY



3 1833 00035 6722

ALLEN COUNTY PUBLIC LIBRARY
SERIALS ACQUISITION
UNIVERSITY OF CINCINNATI
CINCINNATI, OH 45221-0016
FERNALD LIBRARY

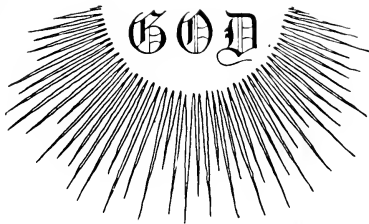

TO WHOM WE APPEAL AGAINST CORRUPT AND CORRUPTED EARTHLY JUDGES



UNIVERSAL INTERNATIONAL GENEALOGY AND OF THE ANCIENT FERNALD FAMILIES

WITH CRONOLOGY FROM CREATION FOUND IN THE DISCOVERED LOST

Rolls **PRIMITIVE BIBLE** **Squares**

HEBREW, ÆGYPTIAN, and OTHER LANGUAGES, FROM A STUDY OF THIRTY-FOUR LANGUAGES, ALPHABETS OF THREE HUNDRED, RECORDS FROM ONE HUNDRED and FORTY CEMETERIES, ANCIENT and MODERN COINS, INSCRIPTIONS, THIRTY THOUSAND BOOKS, MEDALS, MONUMENTS, MOUND, MOABITE GENEALOGY STONE, OBELISKS, MANUSCRIPTS, PAPHYRUS PRISSE, PYRAMIDS, RELICTS, SACKED RECORDS, FOR MONUMENTAL PURPOSES, HONORING
God, COUNTRIES, STATES, and FAMILIES In Truth

By **CHARLES AUGUSTUS FERNALD, M. D.**

(PIKE-JOHNSON-SAVAGE-ROGERS-HINCKS-SPYNE-WASHINGTON-WARBURTON-AMAND-COLIGNY-COMMENIUS-LULLIER)

Principal of G. U. S. & F. A., Physician and Surgeon of Peoples' Palace Salvation Army Corps; Fellow of the Massachusetts and Suffolk Medical Societies; Member of the Harvard Medical Alumni; Member of the American Medical Association for the Suppression of Quackery; P. Member Webster Historical Society; Member of the Maine Genealogical Society; P. M. Andover House As-



Station No. Five; P. Surgeon of the United Order of Pilgrim Fathers; Honorary Member of the Antiquarian Society; Third Vice President, a Descendant, of Those Who Fought Upon Breed's (not Bunker) Hill, Charlestown, Mass.; Free and Accepted Mason of Morning Star Lodge, Wolfborough, N. H.; Discoverer of Method for Quick Removal of Needle from Human Body; Bone Union of Pat-

association; P. Physician and Surgeon of St. Joseph's Home; Lecturer in Thirteen Languages; Hereditary Member of the Society of Colonial Wars; P. Chaplain Knight of Pythias; P. Physician and Surgeon of the Nickerson Home; Author of a Biographical Sketch and the Downfall of Rome or History Repeating Itself; P. Surgeon of the Providence Railroad Company; P. Police Surgeon many years, Boston Police

lla: P. Visitor of the Providence Association; Son of the American Revolution; Volunteer for Spanish American War; Knight of Pythias; A Common Sense Moral and Physical Temperance Reformer by Constitutions, Removing the Cause of the Down-fall of Nations, States, by Enactment, Enforced; Discoverer of Safe Cures for Alcoholic Habit and Phthisis Pulmonalis; For Justice, Purity and Right.

Monogrammic Alphabetical Flag

Sent to American Delegates for the Bague Banner

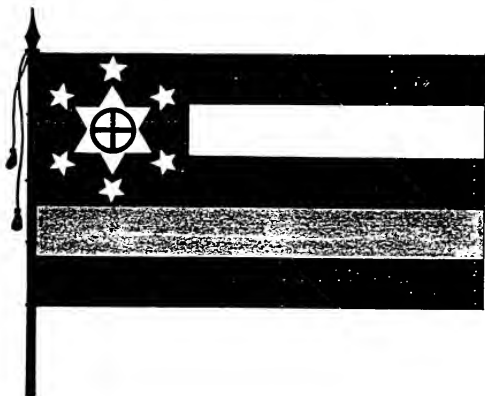

Fernald Coat of Arms



Motto: True to God, Country, State, and Family

Applied for
Copyright 1909,
Charles A. Fernald, M. D.,
Boston, Mass.
Copyright 1910
as per Act of Congress 4 March 1909.

All rights reserved for Hague and God's United States and Foreign Alliance.

DIEU DES ENFANTS

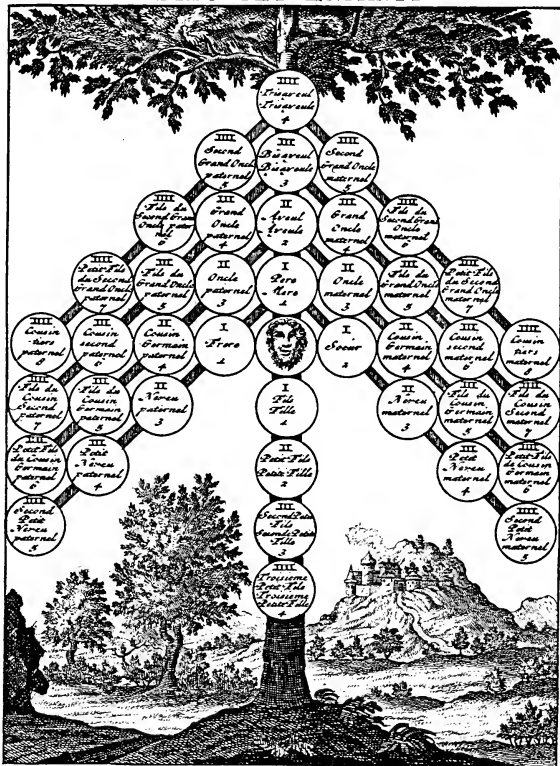

ARBRE GENEALIQUE.



_____ day

_____ of _____

_____ in the Year of our Lord _____

_____ of _____

and _____

of _____

were by me united in
MARRIAGE

at _____

Conformatory to the Laws of Nations, Hague
of God's United States and Foreign Alliances
according to the laws of God, and the State of



Marriages



GOD BLESSED NOAH & FAMILY: COMMANDED ALL TO MARRY.



Births



○ K I X S P E I C L Y T O Y E T E N O T O O Y A . N I C O O O I N N O O O A T I O O R E T I M M A S H N O O O P O O O O J A R N H O O O 4 4 L N

T.W.E

U. S. A. History Coin Inscription of Temperance Washington, widow Thomas Fernald





Deaths



—Sail of Thecla, da. Mary and Joseph
Widow of C. Furnius, Martyr Roman Senate



Memoranda



Count by Lines and Leaves of Pike Genesis

בראשית - 50 אסס



Pike and C. Furnius Lampes →
Dated 200 B. C.



TO GRATEFULLY HONOR A FEW AMONG MANY APPRECIATIVE FRIENDS OF
"GOD'S UNITED STATES AND FOREIGN ALLIANCE"

The President.
With hearty thanks
for your congratulations

THEODORE ROOSEVELT

June 13th 1896
BENJAMIN HARRISON,
674 NORTH DELAWARE STREET,
INDIANAPOLIS, IND.

C. A. Fernald,

(See letter further on)

Amey Harrison

Ex-President, a descendant of Author's ancestor,
General Zebulon Pike.

N^o: 2001

Department of Printed Books
British Museum
London W.C.
Oct. 5th 1890.

Sir,

I beg to acknowledge with thanks
the receipt of "Genealogy of the
Ancient Fernald Family

which you have been so good as to
present to the Trustees of the
British Museum

I am,

Sir,

Your obedient servant,

W. H. Miller
Secretary

VIC-CONSULATE OF SWEDEN
AT BOSTON

BOSTON February 11th 1896.

Charles A. Fernald, U.S.,
Principal of God's United States and Foreign Alliance,
Boston, Mass.

By graceful orders, I have hereby the honor to deliver to you his
Sovereign Majesty King Gustaf's thanks for the sympathy extended to him.



Carte postale
DE BOSTON

Madrid, le 13 juin 1896

Monsieur.....

Le Majesté le Roi mon
Auguste Souverain, a daigné m'ordonner de
vous remercier en Son nom de la respectue-
use présentation que vous Lui
avez adressée à l'occasion de
Son serment à la couronne.

Agreez Monsieur l'assurance de
ma reconnaissance distinguée.

W. Fernald

M^r Charles A. Fernald, U.S.
Boston.

CONSOLATO GENERALE
di
S. M. S. ITALIA

New York, December 5th 1900.

1016

F. C. Augustus, M. D.,
1405 Washington St.,
Boston, Mass.

Dear Sir,

R. E. the Italian Ambassador directs me to acknowledge the receipt of a letter you kindly addressed to S. M. the King, and to thank you for the part you have taken to the great loss which our country has experienced through the untimely death of S. M. King Humbert.

Yours truly

G. Prandi

Consul General of Italy.



BUCKINGHAM PALACE

The Private Secretary is commanded by The King to express His Majesty's thanks to you for your kind and loyal letter of sympathy

T. M. J. C. Augustus

5-February 1901

SORROW DEEP AND SINCERE FOR THE UNTIMELY DEPARTURE OF GOOD KING HUMBERT—HONOR THE KINGS

FOR THE GOOD OF THE HAGUE, NATIONS; BE IT KNOWN! Reported, Published, at Boston, three months before, Publicly; the intent to slay President WILLIAM McKINLEY, slain by a R. C. Ex-Saloonist, the son of a R. C. and an ex-Saloonist, notwithstanding he forgave the storage of fire-arms to use against State and U. S.; saying "keep them till

The Viscount de Valle da Costa,
Consul of Portugal for New England, requests the honor of your presence at the funeral services to be held on the Twenty-seventh day of February, A. D. one thousand nine hundred and eight at ten A. M. at the Portuguese Church of St. John the Baptist, North Brant Street, Boston, in memory of His Majesty King Carlos I of Portugal, and his Royal Highness the Crown Prince Louis Philippe.

Mrs. McKeely

ACKNOWLEDGES WITH GRATEFUL APPRECIATION THE VALUED EXPRESSIONS OF SYMPATHY EXTENDED TO HER IN HER MOURN

SEPTEMBER 1901

CANTON OHIO

I call for them." A beloved wife, only daughter, four sisters; thirty-seven witnesses all die mysteriously: Thirty-nine attempts on one life. DANGER PUBLISHED AND SENT TO THE LAWFUL RULERS OF EARTH THAT GOD HATH GIVEN UNTO THEM TO COMMAND THE INHABITANTS AND PROTECT THEM.



Boston
July 25-1901

My dear Sir

I should be pleased
to have
you for your letter
of the 23 last - with
records expressing
your sympathy in
this great bereavement,
which has befallen
your Mother, and
your good wishes
for her happiness

and prosperity of
King Edward VII and
Queen Alexandra -

Be very sure they
and family are at this
time of sorrow ^{to be given} just
penned messages
of sympathy and
good will -

Believe me
Yours sincerely
and fraternally

J. C. Fernald
Boston

Mrs. Hay

and her family

gratefully acknowledge the kind expression

of your sympathy

EXECUTIVE MANSION
WASHINGTON
September 20, 1901.

My dear Sir:

The President has requested me to
thank you for your kind letter of recent
date, which he sincerely appreciates.
Very truly yours,

Geo. H. Stanton
Secretary to the President

J. C. Fernald,
1683 Washington Street,
Boston, Mass.

At Huntington Avenue evidence was found and reported showing intent against life of the great and honorable John Hay.

THIS DEDICATION IN MEMORY OF

SISTER SOPHRONIA CHASE FERNALD



Asserting Best Characteristics; Defender of Every Faithful, Generous Cause:
HEAVENLY IN JUSTICE, Kind, Loving Mercy: Noblest Of Pure:
Qualified Righteously, Sisterlike, To Unite Virtuous Wisdom;
XIPHIAS, Yarely, ZEALOUS IN ALL GOOD ACTS;
GAVE HER LIFE FOR THE CAUSE OF RIGHT
July 28th. 1906. AND PATRIOTICALLY
REMEMBERED HER NATIVE STATE
NEW HAMPSHIRE IN VERITY

THIS TOKEN
By Brother Charles A. Fernald

PREFACE

For honorable peace and not war is written this brief work condensed to give the generations a field of labor to honor themselves and me by perfecting these discoveries to aid in conferring greater happiness on the lines of universal brotherhood of all mankind and more closely unite all those created in the likeness of God who loved and honored with perfect gifts Ava and Adam our parents that with us know not all the wisdom of omnipotent Creator whose Commandments and Laws obeyed and enforced is the highest ideal of our best conceptions.

A vast mine stored within the granary of good and evil opens up with the search and research, richly stored with the wisdom of the ages, badly encumbered by the errors that the evil attempts for unworthy motives and purposes to force upon the honest and unwary gleaners, which is only to be with almost infinite labor excluded from the pen of the pure laborer who must work fearlessly, boldly, impartially to prevent those evils we combat for its hydra venomous heads and fangs are to be found in the most unexpected places destroying the innocent to finally, if successful, to destroy itself.

Three principal sections are to comprise this work that should stand for all time and people. The First to be the Holy Universal Bible which God gave to us. The Second to comprise the Ancestors of the People that God commanded each to honor. The Third to contain some facts in Philology that may prove an aid for the gleaner.

The construction of the ancient Mounds conforming to the language of picture symbols and the primitive ALPHABET which religious significance and military and defensive arrangements, historical and sacred uses typical of primeval and ancient requirements.

Special relations are set forth in all the languages which are evolved from one which have continued changing every twenty years till the world has 360 dialects with each containing traces of the one with a trend to return to the common mother tongue that never had any sudden confusion, but gradually lapsed into new sounds and words as may be observed on the monuments and oldest MSS. Moabite Stone, reveals the primitive.

When but few letters enter into an alphabet the value of those letters show an increase. Nor is it strange that the first three letters have in each the name of God. 1st Trinity, =2nd and 3rd Trinity, with Wo-Man Kind; all anatomical parts for we were all made in the likeness of God our Father.

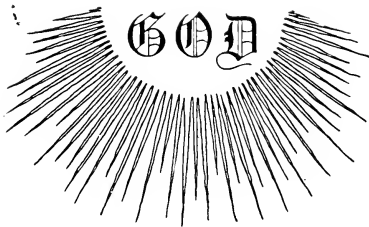

TO WHOM WE APPEAL AGAINST CORRUPT AND CORRUPTED EARTHLY JUDGES

CHAPTER I

PLATE 3—TRANSLATION OF FIRST WORD, CHAPER 1 OF GENESIS

בְּרֵאשִׁית = אֱלֹהִים

God, three in one and one in three, Creator of Heaven and Earth, Created Woman and Man, Ava and Adam, Form of God, that they should be one, a line of beauty, pure and holy, like unto God. Their bodies made of the earth and waters, given the Soul, Spirit, Breath of God. Their bodies shall return to earth and waters, and Souls, Spirits, Life unto God and dwell in God when pure. In accordance with the deeds committed in their bodies they shall be Judged by a Righteous Judge, God, who will reward them and punish in exact Justice. Finally they shall go to God and dwell in God for they are part of God and the children of God, who destroys not them for the sake of Christ the Messiah, our brother, Son of God, Mary and Joseph. His only perfect line of beauty that came to us and went to his Father God without sin. Give to God's line of beauty, man and woman that which is God's own and for Churches.

WORLD, God Created 5810 before Christ: LIGHTS 5397 B. C. and Animated Lives
 O MAN KIND Fa Created 4376 B. C. Theos Son to be born of Mari and Josef in
 worldly and heavenly wedlock the like unto Deus and form of his earthly Parents $\varphi = \gamma = \text{Fa}$
 $= \text{God}$ that promised Ava and Adam in Adan = Eden.

GENESIS Translated from Hebrew to Egyptian has one of many true translations as follows, as
 was known to Moses that was conversant with all the mysteries of Egypt and faithfully copied:— that

“Fa = God, the Trinity, Creator of Heaven, Earth and Waters, Created Woman, Man, Ava and
 Adam that they two should be one, pure and holy like Theos their Creator: their bodies made of the
 the earth and waters: their soul and spirit of JEHOVAH who giveth the breath of all life. Their
 bodies shall return to earth and waters and soul spirit into Dia who gave it. For the good deeds done
 within the body and mind they shall be rewarded. For evils deeds punished by the Just Judge Dios in
 exactness proportioned to acts. Finally they shall go to Dieu and dwell in Deus when pure! For
 they are the children of the great spirit Manitou who does not destroy Gott. The Supreme Being.”

AMERICA'S Tenn. from Brakeville Mound has crudely sculptured on a shell far
 advanced into stages of decay a crude engraving of the process of creation
 ancient Egyptians corroborate it, by Air, Earth, Electricity, Fire and Waters: plates here
 shown co-

Ethnology, 1881, p. 276

Creation of Earth and

Sun, Moon and Stars:

Life designated by the

showing revolution of

in most ancient times

indicating the powerful

Fa which name is pre-

and the Japanese lan-

keeping it on their

of the circle in spelling

center circle and for the

that in these two we

outer Fa Fo Fa =



pieced from Bureau of
 Pl. LV, illustrating the
 seasons: Light from
 Animal and Human
 small circles and lines
 the centre orbit, which
 is the round O symbol
 name of God and called
 served in the Chinese
 gauges with Japan
 banner and using part
 it. As Sun the larger
 Moon the small Centre
 have with the next
 Trinity.

Plate 2 Above the eight names of God are found in languages that exist to-day among the 170 different spellings. This shows the earth as revolving.
 It was obtained from a stone grave in Kane's Field.



SECOND Shell from a stone grave in Kane's Field is Order from Chaos. SUNDAY, December 7th, God completed the Creation of Ava and Adam and AW "HIS work and it was IT HOLY, SACRED.

purity, Truth. Unto your long line I Christ to be born of Māri and Josf. Dogs I give to guard, watch and Sabbath Worship me." Said God:— Male. Inanimate life the earth and w- not abuse, kindly treat, honor and

blessed labor I teach you for your delight, joy, happiness" as "The bird of song rejoiceth at the rising Sun, which symbol is my name on the Tablets I give to thee Ava Ad(a)m loving teachings thou all for my honor and they choose wrong and suffer, darkness, good." "Do right—JOY: Do not disease, sorrow, misery, death, judg- as follows. From a snow-ball sent of moistened snow it augments in of dusty water heated or cold will as may be seen from a meteorlite, or through space coming into collision stones containing Iron, nickle and other constituents at an immense speed will not only cause great heat, but give the agglutinated mass rotatory movements and other motions, as illustrated by the planets which were best known to the ancients in most primitive times, for the Creator was their teacher. Afterward much knowledge was lost from ignorance resulting from sin, the choice of Adam, Cain, sons of men.

⌒⌒=NH =Noah (Pl. 6) whose choice was evil. Adam, Abel, Seth were the first astronomers whose science was possessed by Noah, and its celestial language as found in part on the (Pl. 1337) map, foretold events that have come to pass and are fulfilling till earthly time ceases. Probably Chaldeans were to a great extent familiar with this, possibly fully. Earth thrown off from the SUN.

On Pl. 4 the 14 ovals represent days and nights of 24 hours each inclusive of TWO SUNDAYS. The four curved lines and two circles indicate six labor days for Wo-Man-Kind: eight Circles with circle and geminal spot inside represents=8x3=24 hours in a day, also 8 planets inhabited: the ovum with geminal spot and vesicle: seed of animate and inanimate life: reptiles by curved lines, that God created 2nd. hence the great honor paid by Ægyptians to Serpents: Dogs created first (Pl. LV) of United States Government work at centre. (Also Pl. 68) to protect and honored by God's name spelt backwards. Birds, beasts, reptiles & Fish created 441 B. C. date is to be read from 4 Circles x by 4 curved lines=4000 & diminished by ○ centre circle equal 400 equalizing by multiple 4 lines x 10=40 plus 1=God's 441 lines of beauty labors, 14 outer ovals X by 26 inner circles=364 days, circle of sun for one day and the inner next with curved the hours with centre two minutes and seconds of our year that a very perfect calendar is kept in the flag of Fna Apries=Æfrias the Pharaoh of Ægypt of the long line proved by Sacred History; 8 circles is a count of Roman Star points; 6 of the Hebrew Star derived from Ægyptian 5 points and seal on Star.



HERE is found in the line and cipher long lost languages that the Dove was the first bird created: the Crow, second: Aegle third whose eye may face the sun uninjured, which corresponds with the Aegyptian. Three regions in North America only could support a large number of people without cultivation of the land which was began early by Abel, son of Ava. Columbia valley was the first and chief. Forests abounded with game and rivers with salmon, shellfish on the coast, and roots, and berries.

Minnesota lake regions the second, and home of the Dakotas, which, translated symbols into the Aegyptian primitive language declares;—"The earth of Noah King, that God the Father taught and brought from Araat." The third! The south shore of Lake Superior the home of the Ojibways translated has—"The Great Spirit is I, and one with Trinity, Ham, line of God whose son Adam fell, or literally turned upside down from God that gave of Ava and Adam his son Christ to come and go! The many Indian tribes from translation give statements of primitive language as descendants keeping in part the primitive religion, believing in the Great Spirit which is only another name for God that remotely was called Fa and the symbol that spelt his name was a picture of the SUN which the Persians and Natchez worshiped keeping the sacred fire burning in their temples in honor of God one of whose other names was Allah worshiped by Mohammedans who practice what they preach. In South America, the Mississippi Valley, North and South through the interior of the Continent, 1200 miles in width: flows its River more than 4000 miles from head to outlet of its longest branch. It receives 57 other rivers from the east and west corresponding to the description of those rivers that flowed from the Garden of Eden described by Moses in Genesis, Chap. II Pl. 50. Pl. 7

This plate translated:—"God of Adam, two with Trinity, a STAR with Creator: give the garden of ting Cain and Ka Na Fa Ta Far "Cain killed Abel (7 2 8) and Anona, OMO, AMA," (ancient counted by feathers on head of Ava,



Plate 7

heads, serpentine Cain is represented in left hand of Ava, and sister pure projecting from boat part circle, right hand, godly Abel who m. Zana, Seth, long line of God, the son of Adam and Ava, m. Sana, da. of Abel & Zana." "Messiah=Christ is here foretold to be born of Mary and Joseph from God the Fr. & God the Holy One." Pl. 5. Shell from Nashville, Tenn., gives part of this. Under boat:—Trans. "Fallen man and women driven forth from Eden—the long line to people the world, God commands build the serpent Mound of God's promise of coming Christ, of heavenly and earthly parentage; on the water, Christ to Annona, Christ taught women, and men, and children, from

the God written promised at build-Mound, tablets, pure loving words for inhabitants of 8.) Adams sin is here told and it the acts that dis-theory. "Ava was ever

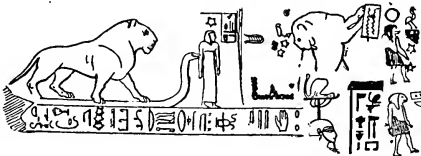

Plate 8. Ever Pure "Eve" tempted. Sins of Adam and Noah shown,

sacred two rolls as ing of serpent engraved, God's of Heaven's Christ earth." etc. (Pl. with same of Noah actually illustrates prove Darwin's pure and holy." etc.

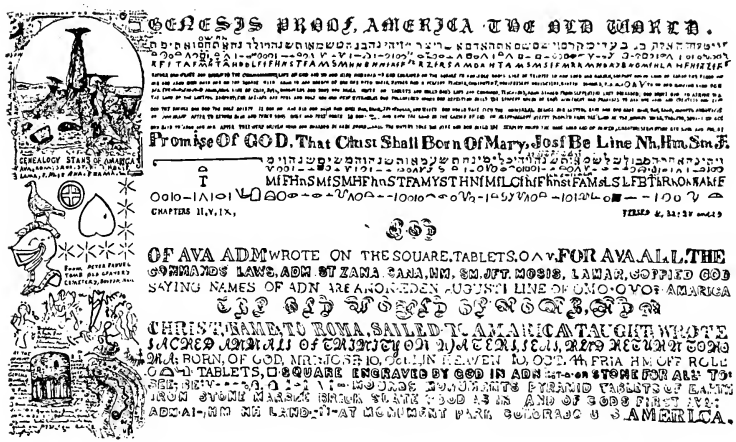
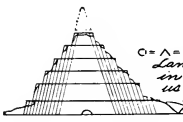

Plate 9. Showing historical chain from Hebrew and Egyptian Bibles; Serpent Mounds in Adams County, Ohio; Dighton Rock inscriptions; Newport, R. I. tower; Monument Park; and Peter Faneuil Fernalid tomb; Rock Writings, Monhegan Island, Maine.

IN THE MOUNDS OF THE ANTEDELUVIANS, aborigines no longer; in the primitive languages: In Genesis by translation into original Hebrew, and that into Aegyptian with this INTO ENGLISH of which it is nearest kin of all the languages of this Earth UPON. It is most richly supplied from all as is demonstrated by fifty-three years search. THAT the earnest, honest gleaner from the inexhaustless granery for facts and the TRUTH may fill to overflowing the repository; of MSS. for the honor and glory of God and the universal relationship of Wo Man Kind, as is designated the two sexes by the ancients.



LINE NAMES OF THE GREAT PYRAMID

Q = Λ = Π = Υ = Ta which is the name of God in Egyptian Chinese & Japanese Languages The rays of God was found in sixty of three hundred alphabets in first and last letters (monograms). The construction of pyramid gives us the primitive letters in first age of the world. The following names are thus recorded: AVA = Eve. Q = Adam. Λ = LAMIA = Abraham, son of MIZAFALIA = Myraim, son of Q = Adam, son of Q = LAMIA = Noah, son of [Λ - Λ].

It is always to be remembered that the Aegyptian Language is to be read from right to left and left to right: top to bottom and bottom to top: then a general reading not unlike to the study and description of a landscape scenery or a marine view. Chinese has all of these modes of reading except the last two. The Hebrew should be read as in Primitive without points that are a modern interpolation obscuring history, as it originally read from right to left and from left to right. "It was not lost," said the scholars, truthfully. Abundant proof exists of the change every 20 years of language.

MOUND HISTORY OF CREATION FROM ONE OF FIVE TRANSLATIONS ALL TRUE. INTO THE PRIMITIVE PICTURE SYMBOLS AND LANGUAGE OF THE ÆGYPTIANS AND THIS PRIMITIVE LANGUAGE INTO THE ENGLISH.

"GOD, the Trinity, Creator of heaven and earth and waters. Created woman and man (and children) that they two should be one in and on the square and circle, pure and holy like unto God, and Christ, and Trinity, that from the earth and waters made their bodies to which the Lord giveth, breath, spirit, or soul, mind or intellect with power to beget children pure whose line shall be honored by begetting Christ the Messiah & son of God, woman and man. Adam and Cain sinned and God cast them from the garden of Eden. For Cain slew Abel his brother, being drunken. God slew not but did curse Cain and alcoholics. Commanded Adam and Ava, and descendants to build the Serpent mound, with Egg of Promise that the Messiah Christ, horn should be of the line of Noah, Ham, Shem and Japeth.

Opposite the Serpent Mound is Wisconsin indicating the strong unchangeable, perfect laws of God, and below 10 parts made after the 1st three alphabet symbols & picture hieroglyphics: 1 & O = in Ægyptian, One God: a picture of the name of God, God the Holy One, & God the Messiah & God the Christ is spelt the same, and from two lines which two constitute all lines of earth and waters, viz: A STRAIGHT & A CURVED LINE: also signifies heaven, earth, sun, moon, stars, square of a circle. Thus built the Antedeluvians and left history, we in lack of wisdom do not so faithfully record for our posterity.

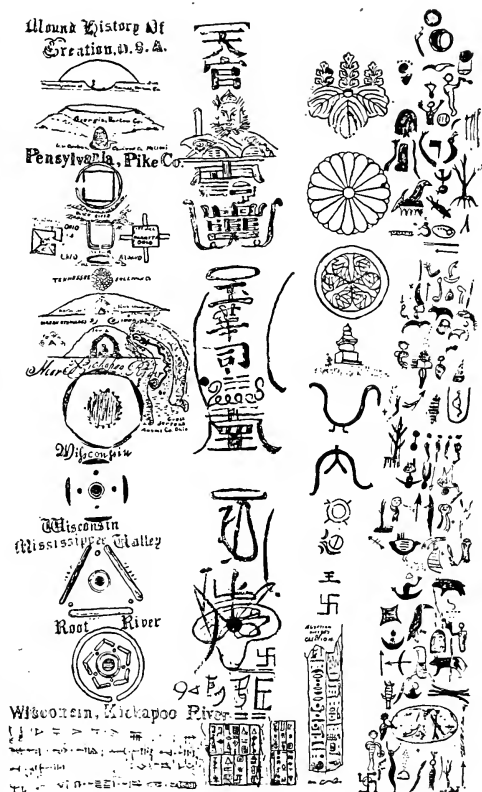

Plate 10 ALL RELIGIONS FROM FIRST

Confirming History of Creation by translation into symbols of Primitive language viz:—Mounds of Antedeluvians and descendants: Chinese: Japanese: Ægyptian: Babylonish and our Indian symbols that give much more than those.

THE NAME OF GOD

Ægyptian=Fa-O, I
 American Indian=◎
 American=Supreme Being
 Arabic=Allah
 Assyrian=Elesh
 Armosian= Tauti
 Æolian and Doric=Ilos
 Chaldaic=Eliah
 Celtic and Gaelic=Diu
 Cretan= Fhios
 Coromandel=Brana
 Chinese=Fa
 Dutch=Gode
 Danish and Swedish=Giet
 English and Old Saxon
 =God
 French=Dieu
 Flemish=Goed
 Finch=Jumala
 Greek=Theos
 German and Swiss=Gott
 Hebrew=Elohim, Eluha
 Hindostanee=Kain
 Italian=Dio
 Irish=Dia
 India=Great Spirit
 Japanese=J=Fa
 Last Rum Ring=Crimes,
 Indulgences, Lust,
 Money and Power



IN 52 LANGUAGES

Latin=Deus
 Low Latin=Deus
 Low Breton=Doue
 Lapp=Jubnal
 Malay=Alla
 Modern Egyptian=Teun
 Madagascar=Zannar
 Norwegian=Grid
 Old Egyptian=Teut
 Old German=Diet
 Olalo Tongue=Deu
 Portuguese=Deo
 Provençal=Diou
 Polish=Bog
 Pollacca=Bung
 Persian=Sira=O
 Peruvian=Prcheccamae
 Primitive=△=O
 " =Fa Fo Fa=J
 =O=O=O
 Runic=Aa
 Spanish=Dios
 Slav=Buch
 Teutonic=Goth
 Tartar=Magstal
 Zemblain=Fezio

PLATE 11 The Holy Bible from the discovered said to have been lost language, gives the twelve lineal first descendants, first Ava, their sculptured form; and at base of tallest Monument the two GOLDEN SQUARE TABLETS OF GOD'S COMMANDMENTS.

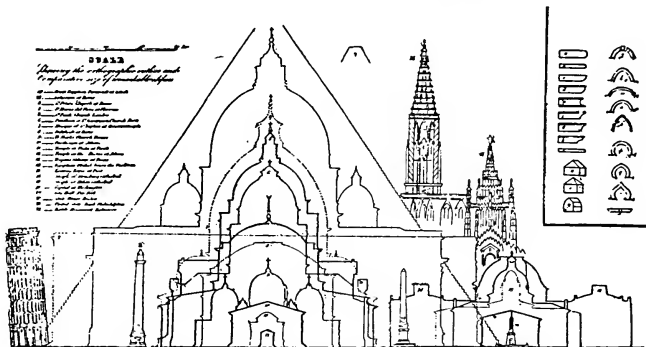
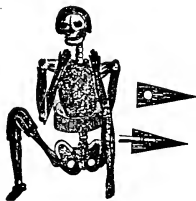

PLATE 12 Comparison of the Churches with the Pyramid: Monuments, etc. Which Stand?



NOT now obscured by those who joined with Napoleon that said "History is what we agree to make it." But the truth can never die or be destroyed the one that Deity protects. Facing page of this thirteenth plate in lower left hand corner will be seen Marcus Agrippa Lucius Furnius the great Naval Commander of the Emperor Augustus the Emperor of Rome with his features in obscurity and name was found written over C. Furnius, also, again written by engraving in the primitive language of lines by himself 29 B. C. who engraves:—"I Marcus Agrippa Lucius Furnius sail with five ships from Roma here XXIX to the land of Annona, which I name Augustii and raise on this Rock the Sea Green Flag, (given to me by the Emperor Augustus,) in this land of Omo, Ama, Amo, where God in the garden of Adn=Eden first created woman and man, Ava (Eve) Adm (Adam) and seed; return from Omo 28 B. C. with three ships or vessels, wife, son & daughter: I left Daughter and son Graecianus Julius Caius Furnius and da. Isabel, they commenced the Tower before I left for defence, Temple and Monument, with the name of O (=Fa) to be built over it. This I do in the land where the sun first shone on my fore-parents, Ava and Adam."

GRAECIANUS J. Calba F., "I, do not complete the Tower, Temple, Fort but return to Roma, B. C. with one ship and 50 men." His and F'rs. name on Me. Rock Inscription. "I Fnr Chia and Bahman Generation CV (105) sail with two vessels or ships from Fars (Persia) with chart Log of forefather M. Agrippa and compass, finished the Tower Temple and here buried a son, Marcus Lucius, that was born here. The people were fierce and blood-thirsty, did slay F. Bahman, who saved my life, and many people of us and they were slayne; at the mouth of the river I buried him: my oldest son was sorely wounded: My husband died June 8th 223: my oldest son F. his spear and his father's and River Mouth (Taunton now the long line, I visited the serpent Anona where the Sun, first name Light, shone on my fore-mother My heart was sad for under the under the arch of the tower the mouth of River Tseon or Ts their Spears, I lay away my be-God Labor, and with my living



Sassan, Died Dec. 10 and with mace I buried him near the called) TSEON; with my son, of Mound of F. Adam in the land of of God and first symbol letter of Ava and Father, earthly Adam. arch I buried my husband slain, I buried my baby son and near On with his armor on, his sword, loved and girt me up for pure son went forth." *

THEOS, I Christ, the son of my Heavenly Father God come up from the waters and write my name ** within that of God on this Rock and Engrave hereon for men and the sons of all women and men for I am sent by the Father to teach that all who believe in me shall have Eternal Light for I AM HE THAT I AM: I the son of God the Father and God the Holy One of Israel, sail from Roma XV to Anona the land of Omo, Ama where God from Air, Earth, Electricity, Radium, Water made woman and man, Ava, Adam in his glorious form and image to be children of the Light and Multiply for the glory of God. I Christ the son of God to teach you to do the works of my God who gave to you his symbolic letters O Δ Ψ here shown. Returned 10 plus 10 plus III=23 to Roma", etc. Translated from Dighton Rock Inscription.

*Notes : **Much left unwritten: See the letters on Dighton Rock, at Taunton River, Mass.





ON Pl. 13 of Marcus Agrippa are imperfectly delineated by plate maker an enormous mass of immutable history from his stolen coin, forefathers and descendants—therewith may be observed his son beneath him: the sea green flag: the two golden squares of God's Commandments, being taught: colony of Augustus: New Port Tower marked S. C. that was at the Vatican, Roma: sections of Tower, Temple, Fort: Good Queen Bess-traced autograph signature: grave of Miantonomi, bearing the name of Deity line and, 1643, with the primitive America's name Omo land and at the right and below the names of the Great Spirit, Trinity, and below this the Primitive Alphabet, F. A. M. which God gave to Ava and Adam in the garden of Eden which is the key of all ancient and modern, over 300 alphabets that are found from the primitive languages to be religious, anatomical, historic: sections drawn from the spot of New Port Tower that show forth the TRUTH which can never die: the coin that shows forth the completed Temple Tower is enlarged at bottom centre showing the barricading or rushing to Arms for warding off the Indian attack that cost F. Bahman his life and Fnr. Chia's great sorrow: the stars and stripes of the shield of America in centre, makers are gone (to Trinity united in one) with the coats of arms of the thirty-six states are all written on the Square and the 36th beareth the face of Washington. Three of the four lines are A Constitution United America (symbols) with the world of God, (letters) For Three Laws: Chinese Coins, of which I have a more valuable one not shown here, contain the two golden squares of God's Commandments, Laws, etc. Sanscrit bears the name of God, and the date, 4376, of creation of Ava and Adam and descendants, as chiseled on Colorado stones, the ROLL OF GOD'S LAWS, etc. Chinese Compass bearing the names of God, King Solomon, Hiram of Tyre and date 1010 B. C.: Chinese pillars bearing Hieroglyphically primitive truth emblems, etc.: primitive erroneously called Sun worship beareth the symbols of human beings going to God and dwelling in God when pure: Picture of Vishnu bringing Sacred Scriptures written by God from the Serpent Mound: Map, Chart, Foretold Events God gave to Ham and Noah after the Deluge on which is prophecy that came true July 28, 1906, in part, it has many readings all confirmatory and no contradictions from the line, star, cipher, sacred, anatomical, primitive alphabetical, numerous languages of primitive times, more of this herein and Book of second Edition which to do full justice to all the discoveries would require 20,000 pages of closely written Mss. Dr. Webb of Providence, acct. of plate 15, found at Fall River, near mouth of Taunton River leading past Dighton Rock Inscription that is exposed and covered at every ebb and flow of the tide. See Sears American History published 1846, pp. 15 & 16. I have made 16 Photographs of Rock fast crumbling into decay.



NOW standing picturesque are the Colorado stones, beautiful and sublime, as may be observed in plate eleven, which Moses describes in Genesis. NEW OLD history from plate nine that has and will come to stand till the Last Great Day when all shall be changed in the twinkling of an eye, emerging from the shell of mortality into immortality, to be justly remunerated by our Heavenly Father and KING OF KINGS in the Realm God Created to gloriously stand forever dazzling bright, gloriously beautiful with perfect Light and Love, unchangeable by the Celestial Perfect Lord of Universal Creations, that the greatest best conception of mortals can but faintly delineate its glory, honor, justice, love, mercy, peace, potency, righteousness, rewards, satisfactions, usefulness, wisdom, all united in ONE GOD OF TRINITY and Wo Man Kind His Children Honored by HIS MOST GLORIOUS SPIRIT FORM!



CHAPTER II

THAT AMERICA was well known to the ancients even unto the wise Egyptians that drank no wine from the gr. fr. of Fna, Apries or Afries to Noah, and were so wise that ambassadors were sent from all nations most learned to gather facts from their religion and laws to give their own nation the good that they might enjoy like blessings from practised wisdom.

Plate 16 is typical of America's origin from the Indians, Ava and Adam illustrated in Chap. I, in accord with the Map given to Ham and Noah. In Plate 17th held up that the world might see and be convinced is the letter symbol A three lines before his face forms M his eye called by Hebrews Ayin=A, staff and part of right arm the Hebrew R, staff I, top of flower C, sharp long point in corner A, directed toward first A, giving the same spelling as in Genesis of America, and also AMA using the first three along his head that bears the long two feathers indicative of first parents Ava and

Adam, which point to the Serpent Mound Egg of promise of God to Ava, Adam and Seth. (See pl. No. 10)

HEAVEN'S God, the Trinity, came to Earth, Theos engraved: "I, FA, three in one: Create the Heavens, earth, valleys, mountains, land, waters, rivers and seas. Wo man Kind from myself, elements, earth, waters, air, purity, electricity, radium, soul and spirit, Ava, Adam that they two unite in one, beget children to all bow and in purity worship me their Omniscent, Omnipotent, Omnipresent. Theos, honor, love all my creations.



PLATE 16

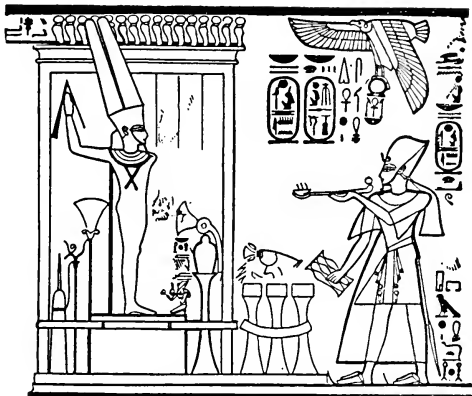

PLATE 17

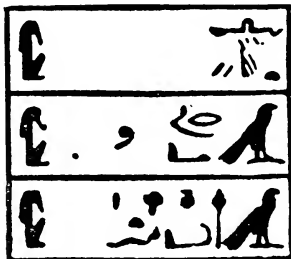

PLATE 18

ETERNAL God I oo the pure white square place thee—ova—of my creation one with, from, me, thy omnipotent Lord say:—
LOVE ye one another as I Lord loveth and giveth power, joy to you, woman, man, singing-birds, animated creations, of air, seas and land. My son Christ shall be born of the long line of Ava and Adam to teach my holy truths of harmony, praise, give the bread of life everlasting, a sword against powers of evil, by sea and land, to destroy; even the young unborn, then my son will return unto me, Father God.

FIRST SEVEN COMMANDMENTS: LAWS THAT I TRINITY GIVE UNTO ALL MY CHILDREN OF EARTH: I. Live in on the square with Theos=God=FA, Just, Holy, Pure and Upright. II. Worship God in purity and truthfully. III. Labor six days, rest, keep holy Sabbath, in praise and honor of God. IV. Unite (marry) and chastely beget children Godly. V. Do not drink alcoholics e-vile, fall to earth mire: die cut off by God. VI. God giveth, protecteth, life, seed kill not; love wo man kind. VII. War for God, holiness, purity, country, family, love, nations, states, Theos.

Note—Translation one in five all true—are 1st, left; 2nd, right; lower third of plate, bottom.

FORTH from the dark tempestuous Ocean cometh the Mariner's Light, a gleam that banishes of that night all fear for God has heard his prayers and safely they glide into the haven of peaceful rest for the long voyage is successfully ended.

Plate 20 is part of a Book said to have been found, (from a vision of Joseph Smith, b. 1805, kil. 1844) at Manchester, N. Y., 1837, Ill. 1843: that has with its work been the cause of much evil and we hope may be prolific of some great good if the original find is genuine duplicate of these two pages engraved on gold plates replete with ancient data and history of Anona, Omo, U. S. A. They denuded of the trash of untruths and selfish desires of bigots, supply proof of ancient history supposed to have been lost, now coming to light of immutable history that will aid in the discovered said to be lost of Hebrew and Ægyptian languages that either fully proves every allegation, or by continued research, throws out incorrect statements, which have thus far been substantiated by geographical facts and the wonderful mounds of the Antedelvians and their descendants.

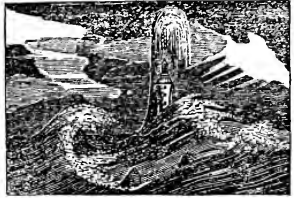

PLATE 19—EDDY STONE LIGHT HOUSE

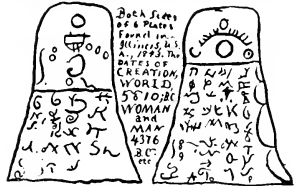

PLATE 20

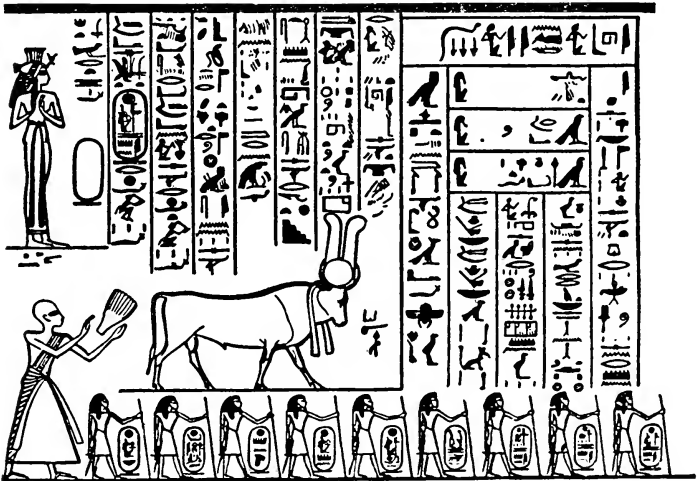

PLATE 21—God wrote the Commandments on golden 2 tablets and roll mentions Serpent Mound, Laws: shows honor given to Apis or Ox in garden of Eden by bearing \circ Δ ψ .

A SYMBOLIC NAME OF GOD, Monogrammic, the Roll, feathers indicating Ava and Adam's gifts at the garden of Eden, their fall, expulsion; promise of Christ; teachings to build the Serpent Mound with the Egg of Promise (of God in Genesis proof pl. 9) the sorrow of Eve for Adam's serpentine sin:—the book of six golden leaves conforming typically to pl. 20, as caught by the hands of priest from serpentine man above ox and Trinity connected with above the serpent after the sin of Adam; AVA PURE.



PLATE 22

THE ANCIENT ÆGYPTIAN WORSHIP OF THE SUPREME BEING NOW KNOWN BY 170 NAMES. THE ONE GOD WITHOUT BLOOD SACRIFICES, THAT MARK THE AGES OF CHANGE BY MAN OF GOD'S COMMANDMENTS AND LAWS.



EGYPTIAN. JEW. CHRISTIAN. MAHOMED. Pagan. PERSIAN

PLATE 23

HEAVENLY COMMANDMENTS AND LAWS BROKEN; THAT HAVE DESTROYED 150,000,000 OF MARTYRS, reduced from alleged 250,000,000 by search and research of the Author. .

F

ARTHLY men's wisdom
Plate XXIV is a marvelous
history derived from Ægypt
wisdom. Translation from
Mound builders the grace-

lotus flower bloometh, pointeth its
where Creator of the
Sabbath in 7 days, one
Noah inclusive, counting
ed spaces are their number
to the pyramid altar that
in the the land of Ægypt
Serpent Mound, across
Ava wore the six feathers
the Mound shell of six
of Nations (See pl. 7)
tail of the large centre
number the 12 Tribes of
kept on Peter Faneuil

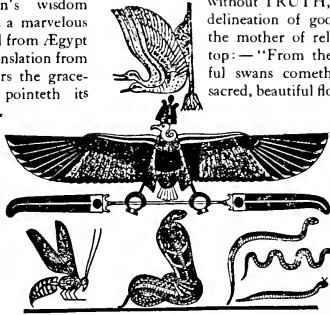

PLATE 24

Rings keep the names of Seth and Noah long lines between the two great plume feathers in the claws
of this wonderful Sacred Bird that bears on rings the two Golden Tablets with the names included
therein and thereof of Trinity. The round sun-shaped symbol at base is the name of Fa= as we spell
it God: it was the seal of Fnr Lamar the wife of Noah: IT is the first letter of the primitive Alphabet
and called F and reads from right to left is the second A surrounded both sides by hieroglyphic letter
M which has a religious reading of names of Trinity: Mary and Joseph pictured, as parents of Christ,
and again in the Ring the Hebrew terminal letter M: likewise reading from left to right gives F, A, M,
from which the 360 alphabets emanate. The Honey Bee shows the great loss to our common fore-
parents with their fall from Eden (see squares in rings) from the lusts of Adam the father of the long
serpentine line that serpentine like in
of lust with inferior creation and was
suffer; but through Christ and God
Mound Serpent in Omo where arose
the sun, whose bright light gladden

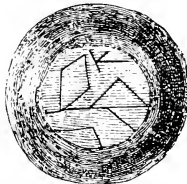

Plate 25. Marble Globe, Miss

R

ECORDED found in one
issippi Valley this Marble
circumference with in-
that NOAH Son of LA-
HAM to Ægypt and re-
Flood. Ava wrote, copied Adam,

Annals of God: Seth, ZANA da. of Cain & wife Ka Na Fa Ta Far of Ava and Adam wrote all.

Note. Here is recorded the first Queen and King Ava & Adam the first pyramid of Oregon and
second letter of the alphabet, and first the globe, the third the diamond-shaped—turned on side—
Hebrew terminal M and the Y-shaped lines show its origin, from M=∇=□.

without TRUTH, is vanity, vexation of spirit!
delineation of good SACRED and profane
the mother of religion and knowledge with
top:—"From the land of the Antedeluvian
ful swans cometh to the Nileus where the
sacred, beautiful flower, points East to the land

earth, time, 7 days, one
Sabbath: and the line to
Adam, Abel, eleven shad-
and 11th child son point
was built unto the Lord
from the pyramid, the
the great waters, where
of honorable promise and
ovals giveth the number
Six more give from the
monogramic bird that
Israel; with the count
Tomb. The two Seal

second partook of the forbidden apple
spotted with disease and his chn.
as promised by him at building of
and set, beyond the earth and waters,
the heart, mind, redeemed.

of the smaller Mounds of the Miss-
Globe four and five-tenths inches in
scriptions in line symbolic language
MECH from Mt. Araat went with
turned to OMO=Annona after the
copied from God's Hand Tablet An-



 F these helisks on pl. 28 is found much line writing several Indian characters of their also ever changing languages that throughout the whole world is gaining and lost in parts every twenty years with a trend toward the primitive speech.

Top triangle is the name of God, white, pleased, darkened angry; 3 lines, Trinity counted by the three headless sacred birds on one neck a line that there indicates Wo Man Kind; 3 lambs sheweth forth the love of God: Christ Hebrew, teachings and first, laws, Commandments of God. In catouches Indian Pipe, Tomahawk, Great Spirit, etc. Below is a mixture of Celtic, Hebrew, Sanscrit, Indian arrows, spear pointing to Mound for knowledge.

IN Catouche is the promise of the Great Spirit that Christ Cometh.



PLATE 29

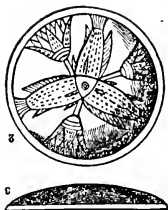

PLATE 26

At Berlin Museum is the saucer obtained in Ægypt and its hieroglyphics record it as the compass of Noah and Ham used on the Ark at time of deluge, which, when placed on Map at Gulf of Mexico points to Mount Araat. Communications from Berlin Museum showing it is a present from a French Gentleman.

ON PLATE 26—Translation "I Fna Noah, obedient to God's commands with my family go with God, by compass, chart, map, from Omo, Ama, Annona, to Araat over the waters from the land Adam where I arrive safe with God the Father and God the holy one." The central part is similar to that on Ark of Antedeluvians by Fnr Lamar's history of Creation.



PLATE 27

PLATE 27, used after Donnelly records bringing the body of Misraim from Ægypt to Anon the land of Mounds and Ava and Adam's Land.

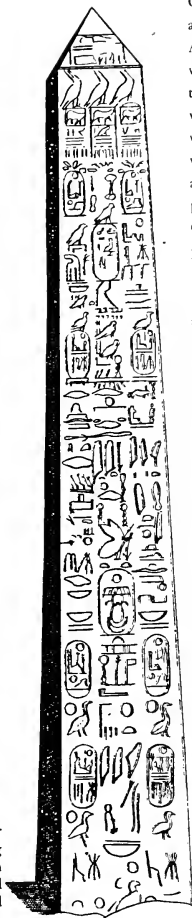

PLATE 28

On left below are plumes of Adm, a tent with two in it, the garden world and world, line of waters, earth and Catouche pyramid of Oregon, primitive letters, Seal of Adm & Ava, and Mt. Araat. In open space, Christ the way or ladder. God over mankind Serpent Mound Egg of promise Tree, count of Trinity and man line to earth, Flag over the waters casting lines of holiness, Justice The Pipe of Peace, etc. Last inner Catouche reading from one above is Atto's son & is Fna Ohio a great Chief whose 3 sons had sons and das., who had many sons.

FROM base of first Monument (pl. 30) to C Translation:—
 “When the waters over the earth had abated and God’s long line of Noah and family with animated creatures had arrived, from Anon the land and waters of the serpent Mound of the Egg of promise of Christ to pure white, Ava and Adam; AT Araat with his wife Fna Lamar and his sons pure wives arrived; God said, “my eye seeth that my son Christ shall be horn of your descendants coming from ME and you my children, and the earth that I have cleared by the waters of sinful mankind for pure women sake, men are dark and sinful and disobeyed me for which I told them they should surely die and for your disobedience and sin within thee, dark evil that will kill my son Christ, who is to come from the line of the 1st of Anona Mounds, so sorrowful that he will weep and the angels of heaven sorrow; for I will hold my hand when I see his heart pierced, but my face shall be darkened and men shall fall, for with my hook I will draw them to their fall, till my measure of Justice is filled, though for the pure, I will forgive them and my anger shall become less after they have been punished; a banner shall be raised; and I will raise my son Christ higher above the heavens for women, pure women, even Mary, like a birdling of the earth and Heaven, shall be of the long line of Ava Adam and their hearts shall rejoice for my son’s sake who I gave to earthly children that from disobedience left the garden of Eden after Adam’s fall by lust sin which the Mound shows in Anana. Upright man shall again enter the garden of Eden at the Millenium which shall be ushered in by holy Trinity, peaceful swan-like, fallen men will disport,—” etc.



"I

T is the glory of God to conceal a thing; but the honor of Kings to search out a matter."

PLATE 33

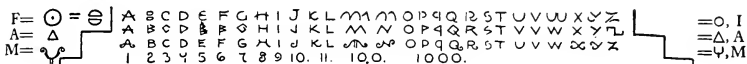

The Primitive Alphabet Universal Showing Its Construction Into English With Origin Of Numerals.

PLATE 34

ALPHABET OF EGYPTIAN HIEROGLYPHICS. <i>From The Monuments of Egypt. Hawks.</i> 1849		 Discovered by CA Perrot M.D. 1899. ALEXANDRIAN CODEX. A.D. 72 CODEX CLAROMONTANUS (Greek & Latin) 6th Century
A. E. E. O. O.		
B.		
K.		
SK.		
T. TH. D.		
L. R.		
M.		
N.		
P. PS.		
S.		
G. D ^a . S ^a .		
PH. F. U.		
H. KH. SH.		
SH.		
H.		

MONOGRAM EGYPTIAN STANDARD ALPHABET OF APRIES (or VAPRIES or AFRAS)		F. O. I. O. C. X. V. A. (<) < F. U. U. W. O. W. W.
A.		
N.M.		
S.		
T. DB.		
H. RL.		
K.		

C	O
I	E
T	F
O	T
E	E
Z	N
Y	Y
M	M
S	S
P	P
C	C
Z	Z
T	T
I	I
X	X
V	V
F	F
A	A
K	K

It is found that the Banner of Fna Apries was constructed to represent the Primitive Alphabet with Numerals and a perfected Calendar of minute fractions of Seconds, Minutes, Hours, Days, Months, Seasons, Years, Centuries, and is wonderfully Religious,—with Anatomical lines shown. Thus demonstrating an extent of knowledge that has been hidden from modern experts. English letters at left of large plate are not correct.

SACRED MOUNDS were built unto the Lord in the Land of Omo, "So shall knowledge of wisdom be unto thy soul: when thou

hast found it, then shall be a reward, and thy expectation shall not be cut off." It is noted that in left hand of top plate are 10 openings, and 10 in primitive language is the symbol for One God, the letters \circ Δ Ψ are here built to stand for Trinity and eight O with an oval of Roman descent, as is indicated by an eight pointed Star. On plate 35 of old Washington Fernel is to be found the same alphabet with the spelling in his autograph signature, Fernel by reading the top part of his name. The 23 five pointed stars on shield show the number of states admitted into union when plate was engraved. The apex of Light House is in form of Greek triangular letter Delta that was the A in primitive languages and Hebrew terminal square $\square = M$ in first light, second for garden of Eden and the other two lights represent the engraved golden squares that God wrote, Commandments, Laws on.

$\square - \square$

"This above all, to thine own self be true, And it must follow, as the night the day, Thou canst not be then false to any man."—Hamlet.

However brilliant an action may be, it ought not to pass for a great one when it is not the result of a great design.

The virtues are lost in interest, as rivers are lost in the sea.

The world more often rewards the appearance of merit than it does the merit itself.

The vices enter into the composition of the virtues as poisons into that of medicines. Prudence collects and arranges them, and uses them beneficially against the ills of life.

PLATE 36

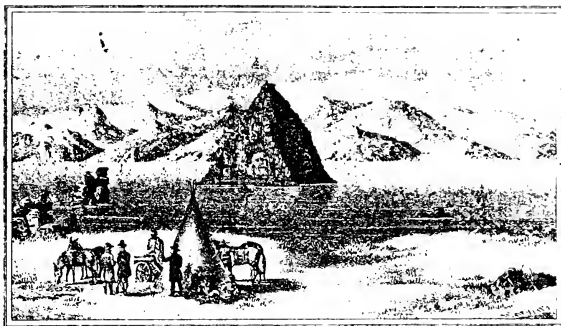

PLATE 35



“CONFIDENCE in an unfaithful man in time of trouble is like a broken Tooth and a Foot out of joint.”
 COPIED by the ancient Egyptians was the Pyramid built by God at Oregon.”

PLATE 37



PYRAMID AND LAKE AT OREGON, UNITED STATES OF AMERICA.
 “LINE HAS NEVER SOUNDED IT NOR ANY VISIBLE
 OUTLET OF ITS PURE WATERS.”

PLATE 38

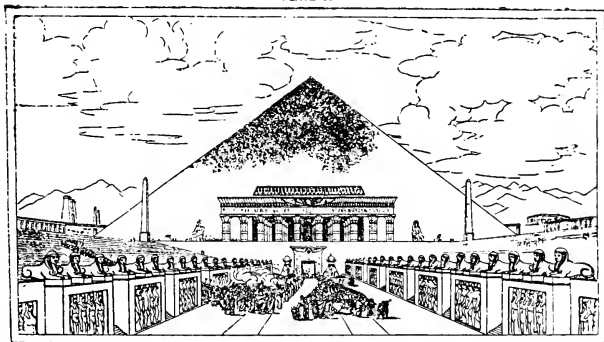

RESTORATION OF EGYPTIAN PYRAMID—BIBLE PROPHECY

GOD IN HIS 170 NAMES BE WITH US: GO UP AND BUILD MONUMENTS
 WITH HEROIC BUSTS OF THE LAWFUL RULERS OF THE NATIONS
 REPRESENTED BY HONORABLE CONSULATE SIGNATURES OF
 OVER 1,160,000,000 PEOPLE IN FAVOR THEREIN FOR PEACE
 ON EARTH AND GOOD WILL TO ALL!!!



By translating the Holy Hebrew Bible into the primitive Egyptian letters symbols which is the key of the "lost" Hebrew Language. We have Gen. Part Ch. II, v. 7: $\odot \ominus \triangle < \Gamma$
 $\Gamma \ominus \ominus \ominus \ominus \ominus$
 $\Gamma \Psi \ominus \ominus \triangle \ominus \ominus$
 $\Gamma \ominus \square \ominus \square \ominus \ominus$
 $\odot \ominus \ominus \ominus \ominus \ominus \ominus$
 Trans. God said, "The date of thy creation woman, man before my son, Christ in thy features shall be kept as long as you inhabit the earth. The opening of the ears. \ominus of eyes, \odot = 4000 $\odot \odot =$

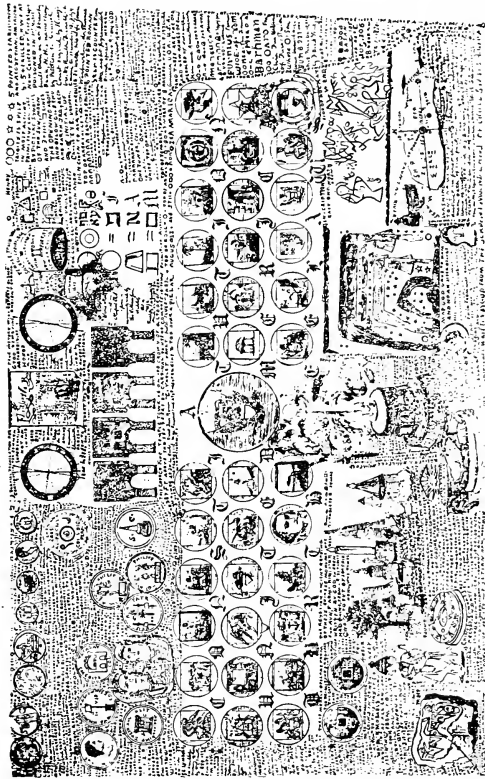

3000 (Nostrils & mouth) Count ears opening, eyes, nose, mouth, 7X10=70 : Again count organs, ears, eyes, nose, and we have as the mouth sayeth the first woman and man created 4376 B. C.; my son to be born of Mary and Joseph.

Constitutions. United America. Our Three Laws!!! Historic Items: Left to Right, Top. Partial Translation For True History. Will Experts Please Continue It For Common Good Removing Ancient Errata, Superstitions, Absurdities, Not An Honor In This Age! 1, Marcus A. L. Furnius. 2, Antj Fonei. 3, C. Fonei, fr. & son. 4, Cesar Augustus. 5, Sections of Monogramic Newport Tower. 6, Grave of Indian, Minantown Ohio. 7, Sea Green Flag of Dighton Rock, Gift Emp. Augustus to M. Agrippa L. Furnius pictured over waters on Copan Monument. 8, God's Golden Sqs. and Roll taught from by Philip, afterwards by Christ the pure God son shown on Coins. 9, Serpent Mound, Tail of Serpent, Adams Co., Ohio. 10, Coin Newport Tower on Roman Coin. 11, Primitive Alphabet. 12, Faustina, features bear date of Creation, 4376 B. C., & on Map Chart, also, World 5810. 13, States Arms, U. S. A. 14, Chinese Coins, God's Sars. 15, sanscrit date 4376. 16, "Adam & Ava, Seth & Sana as copied from Colorado Monuments." 17, Chinese Structures Bearing Name Fa, prim. language. 18, Sun, name Fa, Temple. 19, N. Port Tower enlarged. 20, Buddists obtain Roll GOD wrote, Serpent Mound Land. 21, Coin of Pike & Furnius. 22, Map Chart dates of Creation. 23, Inscriptions on Dighton Rock (24) Recording the coming of Christ XV, Ret. 23 to Roma. Much More—a study.

CHAPTER III



“**I**NTIMENT and perfume rejoice the heart: so does the sweetness of a man's friend by hearty counsel.”

Only a few of the Symbolic 30,000 Mounds of Antedeluvian, Descendants, in U. S.

PLATE 39

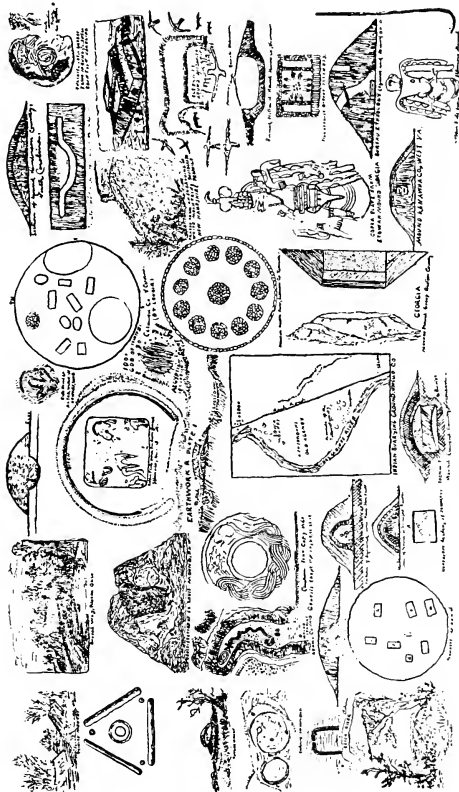

Notes on Plate 39. See Bureau of Ethnology : J. W. Powell, Director

Annual Report : 1883-4 pp 14, 15, 17, 18, 20, 24, 27, 31, 33;—6-7, 40, 1, 3, 6, 54, 7, 8, 62, 3, 7, 9, 72, 4, 5, 6, '96, 7, 8, 100, 2, 3, 4, 5, 6, and Plates History of Crexion

“**U**NTO you, O the sons of fully seen. Pl. Priesthood of and Genesis

Noah and Lamar which trans- were wicked and destroyed them survivors that I would not I gave Rainbow as token of count of Noah's family, head, ken, and F sepa- a week, one Sun- count tribes of Israel: shoulder the Ægypt power of God over nels copied on Tomb Noah's Map Chart: 13 stars of Map. Mound of Promise with another, white, of serpent represents mid Lake & the Nile, by Step Pyramid in Sacred animal indi- Mound. And Spears Noah. Name of God God's pair of like. foot power of Man women. Two larger of Ava and Lamar: the Trinity with and killed by the

Plate 41 lines place of Noah and Mounds of Graded, Ohio.

Plate 42 records returned to Heaven, free moral Agents, rather than good :” Brother Abel. Line, etc., etc.

PLATE 40



PLATE 41



PLATE 42

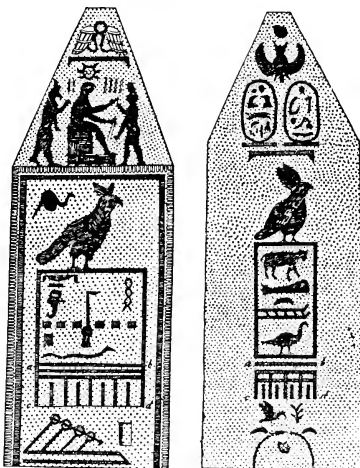

men, I call: and my voice is to man” that these matters may be 40, called “the shield of the the Bow” is shown Ægyptian with the primitive tongue from later: “I God saw mankind with water and Covenanted with destroy them again by water. promise” etc. Step Pyramid two Tablets of Gold, laws bro-

rated by 7 days day: 12 panels five squares from Star: wings the life and death: 12 pa- of Peter Funal and 13 circles, dots; Serpent, egg, is the (Adams Co., Ohio) at Colorado and body pure waters of Pyra- further represented Ægypt. Oval egg on cates egg of Serpent the sin of Adam and on animal and dot Small Diamond the trying to crush pure Diamonds the purity the Three signify Christ persecuted wicked.

read: “The burial Ham.” It is the Way, Picketown,

that “God thar came, sorrowful that Men, wilfully chose evil and destroyed his Trinity cursed Cain

PLATE 43

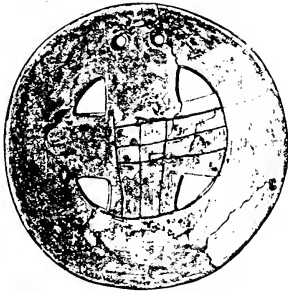
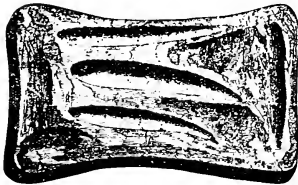
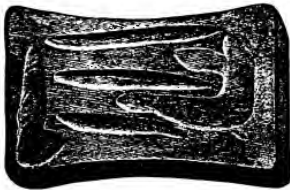

PLATE 44



CINCINNATI TABLET REPRESENTING TRINITY AND A PROCESS OF CREATION

PLATE 45



THIS CINCINNATI TABLET AFTER SHORT DISPLAYS CREATION OF SUPERIOR AND INFERIOR ANIMATED LIFE BY TRINITY

“NOW is she without, now in the streets, and lieth in wait at every corner.” From Washington Government Printing Office 1883 this wonderful Relic was issued that was found from a Mound, Union County, Illinois, U. S. A.

Trans. “Large circle THE GREAT SPIRIT and two small ones complete count of Trinity. Long perpendicular line points it out and is an I, J, F, or H. Four squares represent two Tablets of God’s Commandments: Garden of Eden and Hebrew terminal M=U=I. Inner lines the points of the Compass. The six lines count labor days, and inner cross the death of Messiah. Four large triangular openings, and largest spell ANONA, Greek V and Egyptian A & O. The whole Arm form of Greek C or G and promises coming of Christ the Son of God. It is similar, without the engraved lines, to the Seal on Peter Faneuil’s tomb. White triangles represent Pyramids of Colorado, Mexico and Egypt built, also found crudely built by Nations to represent Trinity.

Plate 44 shown in left hand center the egg of promise sign and lines represent blood vessels, waters or rivers and electricity. Trinity in middle portions and creation lines above.

The health of the soul is no more secure than that of the body; though we may appear clear from passions, we are in quite as much danger of being carried away with them as we are of falling sick when we are in health.

For the credit of virtue it must be admitted that the greatest evil which befall mankind are caused by their crimes.

The name of virtue is as serviceable to interest as vice is.

On hallowed or unhallowed ground,
Seek and embrace the truth,
Where'er 'tis found.

A truly virtuous man is he who prides himself upon nothing.

It is to be a truly virtuous man to wish to be always exposed to the view of virtuous people.



“THE wicked are overthrown, and are not: but the house of the righteous shall stand.”

THE GENESIS RELIGIOUS AND NATIONAL MOUND AT MISSISSIPPI

Plate 46. This ancient Mounds outer circle 1200 ft. in circumference, walls 3 to 5 ft. high, width 12 to 16 ft. Walls of pentagon 4 to 6 ft. high: inner circle slightly elevated: central mound 36 ft. in diameter.

Plate 47. Length of embankment the same, height 3, 4, 5 ft. addition of this gives height 12 ft. of Central Mound and the Square of 12, 144 ft. the length of the Embankments. THE AMERICAN INDIAN WITHOUT A KNOWN EXCEPTION WORSHIPED GOD BY HIS PRIMITIVE NAME SYMBOL THE SUN. In works of this kind the same accurate, nice proportions are observed, in the length but vary in height. The sum of the heights equal height of Central Mound showing great engineering skill. In Missouri mound works a large settlement near New Madrid, large and small mounds are very numerous and countless residence sites. One was enclosed by earthen walls. In the forest height 3 to 5 ft. width 15 ft. Near the Lake in 1811 with a clear sandy bottom that is now a swamp, where remotely flowed the Mississippi River, the Town of 50 Acres stood on its embankments, it is now 18 miles away. THE Pl. 49, also discovered by Mr. Pidgeon, with nineteen rays of ancient Ægyptian T's and D's surrounding the Central Son line seal of the names of Deity and the primitive symbol of the name of GOD, retains in outer Circle.

The rays of Ægyptian Star count of Trinity, Woman and Mankind.

Pl. 48 carries on the History of plate thirteen.

○—○

Love of glory, fear of shame, the design of making a fortune, the desire of rendering our lives easy and agreeable, and the envious wish of lowering the fame of others that are often the causes of that valor so celebrated among men.

Hypocrisy is the homage which virtue receives from vice.

The good we have received from any man should make us respect noble traits and give us much weight in the balance against the evil that he does us.

Right is true equity and impartial justice.

PLATE 46



PLATE 47

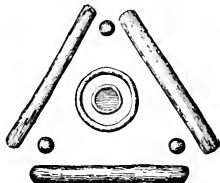

PLATE 48

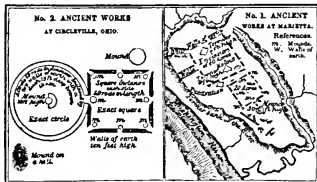
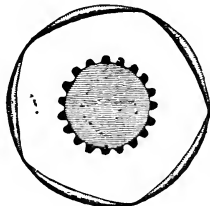

PLATE 49



“RIGHTEOUSNESS EXALTETH A NATION: BUT SIN IS A REPROACH TO ANY PEOPLE.”

Partial Translation of Plate 50. “God, the Trinity Creator of heaven and earth, created woman, man, that they two should be one pure and holy like unto God their creator. Their bodies made of the earth and waters. Given the breath spirit of God there was violence on the earth, it was broken with contention, Blood was shed by the knife. God saw it. One He found pure and holy—Fnr Lmr the wife of Noah. Noah sinned, he drank wine and was

PLATE 50
HISTORY OF CREATION



PLATE 52



PLATE 53



PLATE 51—ALPHABET

A to Z



PLATE 54—CHINESE COMPASS



PLATE 55



PLATE 56



PLATE 57



PLATE 58



Vol. 1. Fig. 1.

ark, birds, beasts, & creatures; 3 Sons, Wives and sons, a bundle united, strong, chn. of God, He would save and did at Mt. Araat. This was written by Fnr Lamar, the wife of Noah. On the Ark at Mt. Araat.” She affixed her name and seal. (In the right of left column of Plate 50 at the bottom, and is found to be true.) Pl. 52 and 53—Chinese History, Creation, Commands, laws & their descent from Fut=Phut=Phuth. Pl. 58—Babylonish History of Creation. The same. Pl. 50 from the Tablet of Abydus at the British Museum, enlarged from the plate by a careful maker of plates that gives a clear statement of facts and truths that can never die, although they have been hid from the light for about 2000 years. Map, Genesis proof Rivers of the Garden of Eden. Pl. 51 is a Monogram from A to Z the Initial letters of Ava and Zana the wives of Adam and Seth. Plates 52 and 53 have thereon the ancient picture symbols of China founded by Phut=Fut=Fo. Plate 54 is the Chinese Mariner Compass dated 1010 B. C. with primitive name of God, King Solomon, Hiram of Tyre, and numerals 1 to 24. Plate 55, Babylonish fish figure has in it, top and back the names of Noah, Ham, Shem, Japheth in line and Hebrew language. Plates 56-7-8 also have a not conflicting creation history.

THESE IMPORTANT HISTORIC PLATES TRANSLATED INTO THE DISCOVERED PRIMITIVE LANGUAGE AND THEN INTO THE ENGLISH GIVES A VERY CLEAR STATEMENT OF CREATION WHICH CHANGES SOME OF THE MINOR AND MAJOR PARTS OF GENESIS THAT THE SEVENTY HAD SO MUCH TROUBLE IN EXTRACTING THE PARTLY TRUE MATTERS FROM SUCH MSS. AND AIDS THAT THEY COULD GLEAN AFTER THE BURNING OF THE CHINESE DOCUMENTS AND DESTRUCTION OF ALEXANDRIAN LIBRARY BY UNGODLY.

drunken, did bestiality. For the sins of men,—He destroyed the world with water, saving Lmr, family and Noah. (right hand column) It rained forty days and nights: the windows of heaven were opened and the fountains of the deep were broken up. Adam had sinned as did Noah. God told Noah to build a house three stories high, to save the seed of mankind, his wife, sons, wives. He took into



PLATE 59

Plate 59—Man Noah Mound at Wisconsin that has the God name over the Y signifying

ET A LITTLE SLEEP, A LITTLE SLUMBER, A LITTLE FOLDING OF THE HANDS TO SLEEP: SO SHALL THY POVERTY COME AS ONE THAT TRAVAILETH : AND THY WANT AS AN ARMED MAN."



PLATE 60

Noah's sin when drunken and he turned upside down from or broke God's laws though made in His most glorious image. It gives the letters F A M and records Noah's land in Ormo and the point of the inverted A Spear that he was buried at Picketon: THUS— | =Noah | — =Ham, dark shaded left line and top of first circle death. P I K E T O v v Greek N, name foretold by Prophet recorded, IS this symbolic mound.

Plate 60 Sculptured on Rock at Independence, Ohio, on shores of Lake Erie with 44 inscriptions inclusive of dots elaborately done and a link in the endless chain of truth. Stone was found under earth and trees: a maple 18 to 20 in. stood the stump over this portion: some of figures an inch deep beautifully cut. Two men figures

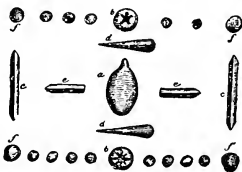

PLATE 61 Compare with map of NH, HM.

were destroyed before a good description could be obtained of them, when taken from the sand stone grit quarry. Life serpentine line about 6 feet long. It tells of the two expeditions of Marcus Agrippa Lucius Furnius with 5 ships, and Fna Bahman with wife Chia: commencement of New Port Tower: birth of a son: pyramid at Colorado: Egg of promise at Serpent Mound: birth of Chia's son: death of Sassan, etc. THIS WAS CUT BY CHIA AFTER COMPLETION OF TOWER. Plate 61—Ham and Noah return to Anona, and Ham to Ægypt. Ægyptians, Hebrews and Greeks co-existent. Time of writing this—Ægypt, 1700; Greeks, 2000 of Woman and Mankind. Plate 62—At page 75 of Divine Legation of Moses by relative Warburton is illustrated part of North side Ramessaen monument from Kircher on which is recorded: "(—| =) Noah's, son (| —) Ham took his wife Fnr Anr back to the land after the flood, whereon



PLATE 62

GOD saw the sins, of mankind and their dead bodies, fell to the earth inhabited. In the Ark saved Noah, Ham, Shem, Japeth and their families, from land to the land where Ava and Adam's descendants had fallen from God and saw God's pyramid stand in the Lake Oregon, the Universal King ruled, near the garden of Eden, God sent to build the Mound of the Serpent, that Ana and Ham visited, the promise of God the Father and God the Holy Spirit that his Christ upright line should be born on the square (plumb) upright from heaven a son, Christ the great from sinful Noah and Lamar line pure his wife. The Lord's hand engraved the Commandments of Trinity and Christ will teach, and China shall have the great spirit of Trinity who is King of Kings and Lord of Lords. "On Golden Squares I Fa engrave, write, on Tablets, on Roll, that Christ shall, the Bow, come and teach and his feet go forth to my children of earth line that fell from my Commands." etc.

"A SOFT answer turneth a way wrath,

but grievous words stir up anger." L'homme furieux excite la querelle: mais l'homme tardif a la colere apaise la dispute." THIS pl. 63 also from Cousin Rev. Wm. Warburton's Works, 1811 Vol. IV, p. 199 gives 70 Generations from F. Apries to Ava & F. Adam their wives, sons and daughters, in cypher languages with stars and lines. The line is proved on the Tablet of Abydus at British Museum, by Holy Bible, Coins, Records, Wills, Monuments, Tombs, Sacred and Profane Histories Fig. 1. is Natatas=Nietatis offering religious rites to her God of Father Afras=Apries; thus to keep her vows and Honor her Father's religious instructions and the Commands of God that the child should worship God only by song, acts, words, for Father God gave earthly Father Afras that worshipped God, gone to dwell with God the great



Fig. 3.



Fig. 1.

Fig. 1. from the Bembine Table.

Fig. 2. An Mummy from Kircher's Oedipus.

This Mummy Fig. 2. shows what sort of Idol it is we see worshipped Figs.

Fig. 3. The Victrol Cloth of Mummy Fig. 2. on which is depicted the style and manner of embalming from Kircher's Oedipus.



Fig. 2.

PLATE 63 Jesuit Kircher attempt to write a universal genealogy prevented by persecution This is not idol worship. Purity against sins. See seal=O

one Spirit, who made woman, Man whose mouths shall Honor Mother and Father & labor for Christ one with Trinity As she presents the 5 glasses of Air, Water, Milk, Honey, and wine glass broken—"I thank God for the gift of a good father and I again come here to pray and say:—I have kept my vows I have loved, kept God's Laws". The names of Alexander the Great & Atilla of line at base of Apries: and their generations are counted to Ava and Adam the children of the heavenly father God.

“**V**IRTUOUS NATATAS PRAISING THE GREAT SPIRIT ONE ONLY GOD OF THE LIVING, UNIVERSAL LIVING, CREATOR WHO COMMANDED LOVE AND HONOR THY EARTHLY PARENTS THAT THY DAYS MAY BE LONG UPON THE EARTH WHICH I GAVETH.”

Counting the 13 eight-pointed Roman Stars of Generations of the great Indian King, Oratota she said “I am of the line, and wife of Fna Cambyzes born June 9th: 3767, mourn my father’s death, 3784, give thanks that from my gt. gt. gr. father not a Pharaoh drank a drop of wine to fr. Noah.” Am comforted by Cambyzes who said “my love is for Thee, throw off unseemly animal human grief. Thy father is with Trinity God whose two golden square commandments we have not small but large for God who built the pyramid in Annona, where father Noah and Ham came, as a fish up from the waters, and the singing bird that they brought from the Serpent moundland; believe in the God one of heaven the Trinity for in thy hands thou mayest hold the symbol of God



PLATE 64



PLATE 65

that yours may have built at Noah and Lamar’s land that symbol which thou holdest so precious, that God the Great Trinity, Omnipotent, Omnipresent, Omniscient, who hath created the Dog, the Sheep, the Lion, and the wonders of heaven, waters, earth and life: the Thirteen Solar months, Seasons for earth. His beloved line of beauty, God the Christ who is to come and go across the waters and as a bird of meekness and song gladden the heart.” This is translation of left hand Obelisk without some of the names, etc. reading from top to bottom Plate 65—Afras is represented in top Catouche and two golden squares of Trinity, etc. Below at right on plate but left in print is the name of Cambyzas and next Cyrus the Great. Below Mandane and CYRUS THE GREAT, etc.

“**E**XALT HER: AND SHE SHALL PROMOTE THEE: SHE SHALL BRING THEE TO HONOR: WHEN THOU DOST EMBRACE HER. I HAVE TAUGHT THEE IN THE WAY OF WISDOM: I HAVE LED THEE IN RIGHT PATHS.” “SAPIENS MULIER ÆDIFICAT DOMUM SUAM: INSIPIENS EXTRUCTAM QUOQUE MANIBUS DESTRUCT.”

“At a point called by the Indians Wa-bi-Se-Gon near the entrance of Nemakan or Sturgeon Lake, is an exposure of Mica Slate, with Felspar Veins, which from resemblance to a Serpent, is regarded by the Indians as a Manitou or God. See plate 66. It has some resemblance to the Mound Serpent, more to the primitive letter M that has within its construction the names of Trinity, Mary and Joseph that from the elapse of ages has escaped the recollection of the Indians. Plate 66 from D. D. Owen. Plate 67 is a Stone that has on it the readings or records which state that to the long line of Ava and Adam, Mary and Joseph that there shall be born the Son of God Christ and this is engraved to record God’s promise that Christ would be born of the Line of Noah “Ham, Shem and Japeth” “One With Trinity One.”

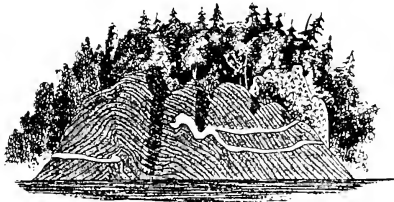

PLATE 66

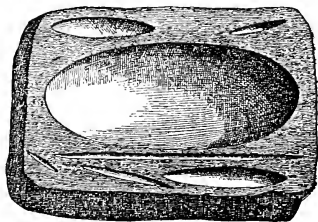

PLATE 67

Plate 68 taken from a grave stone or grave Tablet in Ægypt is a most valuable find of creation and prayer with prophecy. Earth, Villages, Architecture, Arts, Sciences, Alphabets, Habits, Sacrificers of the World.

Principal Parts Of Six All True Translations Of Plate LXVIII Off An Ægyptian Tomb At Eileithyas Of First Laws Commandments Of God From Which 370 Religions, Each Containing Parts Of The Truth Which By Comparison With The Most Ancient Mound Histories And Chinese, Japanese, Indian, Babylonish, Greek, Hebrew; Pyramids, Obelisks, Papyrus, Books Of The Dead, Inscriptions On Metals, Rocks, Ivories, Horns, Shells, Roman Mss., Coins, Copper, Silver And Gold, Bronzes, Medals, Dighton Rock, Newport Tower, Peter Faneuil Tomb, Steel, Wills, Deeds, Books, Tablets, Grave Stones, Engravings, Sculptured Materials, Hieroglyphics, Monograms, Rings, Seals, Coats Of Arms, Animated and Inanimated Creation, Of Waters And Heavens, Nations, States, Towns; Cemeteries, Catacombs; Spires. Of Mankind and Womenkind—The Self Obeying Best God’s Holy Laws.

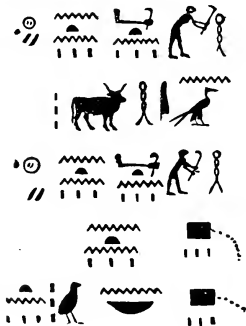

PLATE 68—GOD’S GIVEN PRAYER

□-□



HOLY GOD TRINITY GIFT PRAYER TO AVA AND ADAM, DAUGHTERS
AND SONS OF GOD ! TRANSLATION !

“God, Our Mother And Father, Omnipotent, Omniscient, Omnipresent: We Bow Before THEE in adoration to thank and Worship Thee for the gifts of Thy Glorious Form, Souls, Senses, Spirit; Air, Waters, Love, Planets Inhabited, Sun, Stars, Moon, Light and Darkness, Blessed Labor and Rest: For the Creation of Mother Ava from THEE pure and holy, Honoring the loving line of Beauty, Mother of the first and all human beings born on earth, Foremother of Christ the Messiah completing Trinity with Mankind to overcome evil with Good Works in War for God: We thank THEE for Creation of Adam to be companion and protector of Ava: Our foreparents in THY IMAGE, Most Perfect, Greatest Gift of Love: Authority, Power to Ava with Written First Roll and Two Tablets that THOU taught and Commanded to Copy, Chisel, Engrave Write: For the Dog named for Faithfulness, (Spell backwards) Cow named for meekness and bearing in form and features the symbolic primitive Alphabet: For the Birds, bearing in form honored with quilled Pen to write, Sing Enchanting Melodious Songs of Praise and Worship of TRINITY, gladdening God's Creatures for gifts to Ava and Descendants from Adam: For the (Primitive) Alphabet, F. A. M.: Commands: Instructions, Laws for all of us in kind loving kind with Godly Love in Purity Preferring Unselfish One the Other: All For Thee For Thine Is Ever The Bright Glory, Honor, Power, Wisdom, For All Time And Eternity Beginning And Never Ending As Thou Hast Decreed And Written.

. A-M-EN.

SECOND TRANSLATION AT SENATOR'S ROOM
STATE HOUSE
1906
AFTER LEAVE TO WITHDRAW THREE LAWS
ELEVENTH YEAR

God, Our Father, Omnipotent, Omniscient, Omnipresent: Universal Creator: We Worship Thee Glorious Trinity: Thou Upright And Holy God: We Thy Children Bow In Reverence And In Adoration Thanking Thee For Creation Of More Light, Purity, Pure Air And Waters: Sun, Moon, Stars, Planets Inhabited: Forcing From Air, Earth, Soul, Spirit, Vital Force, Waters, Our Mother Ava After Thy Most Glorious Form By Thy Perfect Handiwork To Be The Mother Of Mankind Endowed With The Greatest Gifts Of Thy Holy Spirit Vital Soul, Staff Of Authority Line Of Power, Skill Greater Than Man To Copy Thy Chiseled, Engraved, Written Rolls, Squares, Tablets; And Blessed Labor: For protection by Dogs honored in name for faithfulness: Cows, cattle, honored in name for meekness, prophetic, aid in labors: Birds honored by THEE, for bearing the quilled Pen, that THOU wrote the Rolls with, and to copy THY SACRED ROLLS, Songstresses whose melody gladdens: Fish of pure waters: Animated Creation of Air, Earth and Waters, that THOU gave less potions of THY Spirit, Soul to, than AVA and Companion.



“**T**HOU HOLY communion one with Adam that THOU taught blessed labor too, and in Eden planted and gave to them!! GOD GLORIOUS GREAT BRIGHT AS THE SUN!!! We thank Thee that THOU madest Lamar and Noah, F. Anna and Ham, F. Rabaka, and Shem, F. Talimar and Japeth, for F. Mary and Joseph to be the Lawful United Earthly parents of Christ the Messiah and SON OF GOD UNITED WITH WOMAN KIND!!!! As Laws, Letters, Songs, Symbols and Words declare on Land and Waters. A-MAN

Champollion's translation was:—"Thresh for yourselves (twice, a) 2. O Oxen, 3. Thresh for yourselves (twice, b) 4. Measures for yourselves, 5. Measures for your Masters'" "(From Sir J. G. Wilkinson)." He repeats measures and threshings, probably a sarcasm, not daring to publish ALL THE TRUTH which we do that it may stand!

THE THIRD TRUE TRANSLATION

"GOD TRIUNE OUR MOTHER FATHER LINE OMNIPOTENT, OMNISCIENT, OMNIPRESENT, UNIVERSAL INSTRUCTOR AND CREATOR. In adoration we bow to thank THEE for THY perfect gifts and our forefather Adam unto Mother AVA who were made of Air, Earth, Water, Vital Force, and THY Holy Spirit Soul to be the parents of Wo Man Kind and Children that one on the Square with TRINITY, go forth from the garden of Eden To Build The Serpent Mound, Adams Co., Ohio, Symbolic of their fall and God's promise of Christ To Be Born From TRINITY, man and woman of the line of Noah, Ham, Shem and Japeth: To carry Two Sacred Rolls, Two Golden Squares, Six Tablets, Eight Commandments: Seven Laws for All : NINE Commandments for China (Founded by Fu=Phuth and named for son Ching Hong) whose banner shall bear the Dragon, GOD written thereon. Of HIS gift; GOD Songs: Laws: Commandments: Alphabet: for Noah Lines prayers, pure, Clear, Bright as the Sun, Moon, and Stars, Pure Sparkling WATERS: Birds of Song whose resplendent gifts gladden the inhabitants of Eden, Earth, Planets of TRIUNE. A-MAN-A

A FOURTH TRUE TRANSLATION

EIGHT PRIMITIVE RELIGION COMMANDMENTS FROM GOD FROM WHICH 370

1 GOD THE TRINITY! WORSHIP ONLY THY GOD.

2 Labor Six Days: keep holy the 7th. Sacred Sabbath: Live upright for God Creator Instructor, Universal: Protect, Love one another: Honor house, Love God's animals, made for God, woman and man to help, protect, and sing for God and US:

3 AVA, ADAM, Children, line Write, Engrave, Chisel, Copy ALL GOD Written Rolls, GOLDEN SQUARES, TABLETS SACRED:

4 Do not abortions, kill children, destroy seed of human life: Unite (marry) chastely heget children Godly:

5 Alcoholics do not drink, even vini evil vile and die degraded diseased fall in dirt, mire, a more unclean spot: Drink Milk, Bright pure sparkling WATERS that the SWORD OF GOD SHALL BE with thy swords and conqueror the vile destroyers of Happiness, Home, Justice, Laws, Mercy, Order, Purity: WAR FOR GOD, Country State and Family, Self, ON Land and Waters: Honor and obey Heavenly and Earthly Parents, Commanders, Rulers,





SOBER LAWS OF BEAUTY, DUTY, GOD, HEALTH, JUSTICE, LIFE: BUILD ALTARS, FORTIFICATIONS, FORTS, MANSIONS, MOUNDS, TEMPLES, Tombs, Vessels, Warships. Guard Land and Water: God's Noah Line, Men, Women, Children, Young Vital Forces!

6 GOD the Trinity with Be One on the Square, Godlike, just, holy, pure, true! Do not Covet, Deceive, Lie, Steal, Vilify.

7 ONE GOD seek from knowledge, power, strength, wisdom: create.

8 Do Abstain from All Evil: Keep inviolate the Commandments and Laws: Love God with thy whole being, heart, mind, strength. Love one another unselfish in honor preferring, Universal Brotherhood Concord, at impartial Justice, uprightness as God loves you:

God said:—"Cut, Engrave, Write This for My Children of Earth and Planets and I will send to you My Son Christ the Messiah and God Spiritual King of the Earth."

THE FIFTH TRANSLATION HISTORICAL CORRESPONDING WITH INSCRIPTIONS
ON DIGHTON ROCK, TAUNTON RIVER, MASSACHUSETTS,
UNITED STATES OF AMERICA
BEAUTIFUL HIEROGLYPHICS AND LINES STRANGE

God the Eternal Mother and Father of Christ the Son to be Born from Mary and Joseph:—"XV, I, Christ the Messiah, came by Ship from Roma, to be known Dighton Rock, Taunton River, Massachusetts: and say I, the Great Spirit, Chisel My Name in the Rock in My Father Fa(O=Fa=God name) * On the Rock East of where Marcus Agrippa Lucius Furnius, Driller of the Names of God the Holy One and God the Father, and from former raised the Sea Green Flag: by Chart and Compass * * I came bringing to the Land of Omo, Ama=Annona=Augustii=Amarica, foretold by Moses, the Serpent Mound Land, bringing the Sacred Rolls, Squares and Tablets given to Ava and Adam and Seven Laws, where Cain was born, given: I taught the Antedeluvians from the Squares to be One with Trinity, that willed all United in Brotherly Filial Love a Branch of Triune the Manitou God: I taught: 10 and 10 and 3 years returned to Roma: Thus my Father God ordered and made most perfect, His children, Female and Male, Daughters and Sons line to count by the Stars, Completed in Messiah Christ and Saviour." This and much more is read in the inscription from Dighton Rock, that the tide conceals and reveals twice in twenty-four hours; fast disappearing, without (till this hundreds of years past) correct translation lost, which, is honestly, carefully presented for Justice, verity.

PART HISTORY OF REBELLION IN HEAVEN OF SATAN, LUCIFER,
WIFE OF THE DEVIL
SIXTH TRUE ABBREVIATED TRANSLATION
COMPARE PLATES



S

HUN EVIL COMMUNICATIONS FOR LIKE WINES THEY STINGETH LIKE

an adder and biteth like a serpent: Virtue and Wisdom are the lawful parents of Happiness. "Ambitious to fill, equal and excel the God Head, Lucifer and the Devil united in Satan, created by God, rebelled and waged war with Omnipotent in Heaven and Air six thousand years before Christ came, after in planets, seas, oceans, waters, children; men and women;

animals, birds, dragons, living creatures, fish and serpents, inanimate, mineral, granite kingdoms, for supremacy in heaven, planets, earth, waters and air, against God, innocence; to destroy wisdom, truth, peace, happiness and themselves from alcoholics, diseases, gold, hell fire, evil, vile lusts, mal-practice, power Satanical over all good joys, acts, deeds, to change the golden squares of God's perfect commandments and divine laws, celestial resplendent forever harmonious as the music of the waters, forests, spheres in perfect accord and union perfected by Omniscient Father of all good and perfect model transcendent pure, loving Creation.



PLATE 64—Reversed to show one mode of reading of prayer God gave, etc.

PLATES ITEMS FOR STUDY

7 upright lines days of week, one Sunday, seven laws for the people on waters and earth: 9 lines the Chinese commandments, and these lines arranged form Greek letter C, and wavy lines symbolic of serpent, dragon, alligator, also Serpent Mound: 5 points on wavy lines point of Egyptian Star: under center half circle



PLATE 69—The inscription on Dighton Rock, Taunton River, Massachusetts, U. S. A. From U. S. History 1853. Plate is reversed to show one of six readings. Coin, dug up by Indian at Mackinac, of Imp. Trojano Augusto Ger., b. 18 Sept., 52 A. D., son Consul Trajano.

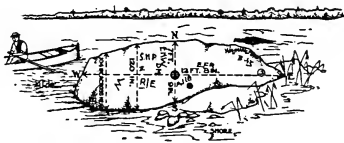

PLATE 70—Top and South of Dighton Rock Inscriptions.

by bringing two ends to a pyramid point we have the Roman 8 pointed star and eight God's commandments and each point is the name Fa and A by Gks. shown in their ancient Alpha, banner point shape symbol: Square is a monogram of Trinity and Wo Man Kind, etc. Thirteen dots at next square correspond to Plate 14. God gave to Noah historic of Christ and United States of America which is spelt fully out there so clear no intelligent person can fail to read by one minute instruction! Reversed mounds are prophetic of evils, alcoholics, inebriations.

NOTE:—Plates 69, 70 and Three Os unconnected after Christ came, two before, two squares on each plate placed cornerwise on Rock with a line showing them returned: 3 Os were ancient names of Trinity—2 before Christ came and 3rd. left lower corner middle plate added by Christ that gives the time he taught at that locality, C in the O, his initial. It has on Rock the names of M. Agrippa. L. F., Christ, Chia and Fna Bahman.

“WISDOM REACHETH FROM ONE END TO ANOTHER MIGHTILY: AND sweetly doth she order all things.” “For there is no king that had any other beginning of birth.” “Wherefore I prayed and understanding was given me. I called upon God, and the spirit of wisdom came to me.” “For she is more beautiful than the sun, and above all the order of stars: being compared with the light. She is found before it.” “I learned diligently, and do communicate her liberally: I do not hide her riches.”

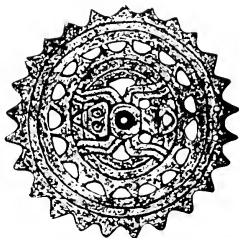

PLATE 71

Plate 71 from plate 61 Bureau of Ethnology by J. W. Powell 1880-1, Washington Printing Office, 1883, page 288, gives from a mound in Fain's Island, Tennessee: 2 1-2 in. in diameter Busycon. With the great Shoshone family, according to Professor Powell, the spider was the first weaver, and taught the fathers, etc. Translated: "God at Edentaughtitto Ava and Adam weaving in the land of the pyramid in lake of waters and said: 'I made the spider whose web thou canst imitate but not his venomous ways, etc.'" Plate 72 of Universal Alphabet was an attempt of a scholar unknown to me for finding the primitive alphabet by the modern grammar that obscures true history and its laws and rules must be laid aside if any satisfactory progress is made in the search for most ancient truths that were lost during the dark ages of men. Plate 73 is one of my continued research for the primitive now found alphabet and key to true knowledge and properly used will give great happiness to the world's inhabitants, as on the plate of 72 are two squares I have thought he had; then, as below, he shows religious traits; may have found that they remotely contained the commandments of God. Plate 73 has at top the name of God the Father and Holy Spirit, B. C. I, is the letter F in 26 languages or different symbols in same. It was not then proved that all the symbols were of a religious meaning, but since discovered that there is no name but is a Godly term. Before degeneration.

The Universal Alphabet.

The Table of Consonants						
1	2	3	4	5	6	7
1	ʎ b	ʎ d	ʎ j	ʎ g	ʎ =	ʎ = P L
2	ʎ p	ʎ t	ʎ ch	ʎ k	ʎ =	ʎ =
3	ʎ m	ʎ n	ʎ gn	ʎ ng	ʎ =	ʎ =
4	ʎ =	ʎ dh	ʎ j	ʎ g	ʎ v	ʎ z B L h
5	ʎ =	ʎ th	ʎ sh	ʎ ch	ʎ f	ʎ s
6	ʎ =	ʎ n				
8	ʎ h	ʎ y	ʎ r	ʎ w	ʎ s	

The Table of Vowels											
14	13	12	11	10	9	8	7	6	5	4	3
>	>	>	>	>	>	>	>	>	>	>	>
10	9	8	7	6	5	4	3	2	1	0	0

The Lords Prayer in English.

PLATE 72. An attempt to find the primitive alphabet. See chapter VIII and Indian language—Mik-Mac. Canada Indians' language. Lord's prayer has primitive alphabet symbols. Thanks are due Germany for its truth.

EGYPTIAN ☉					
1	F	☐	☐	☐	☐
		☐	☐	☐	☐
		☐	☐	☐	☐
2	K	☐	☐	☐	☐
3	R	☐	☐	☐	☐
4	A	☐	☐	☐	☐
5	Z	☐	☐	☐	☐
6	N	☐	☐	☐	☐
7	O	☐	☐	☐	☐
8	T	☐	☐	☐	☐
9	H	☐	☐	☐	☐
			PHENICIAN	GREEK	LATIN · HEBREW

Plate 73. Result of one of Author's search for the primitive alphabet, now found

“**W**INE IS A MOCKER, STRONG DRINK (Opium) IS RAGING: AND WHOSEVER IS DECEIVED THEREBY IS NOT WISE.”

Chapter IV

The Nine Great Commandments of the Chinese translated into the Ancient Ægyptian Language, gives, 5810 B. C. creation of our world, Lights 5397, and date 4376 coming of promised Christ.

Generation F. Noah

& Gen. F. Fut, the founder

& Gen. F. Confucius

Secret Name, U. S. A.
Plate 74

of China
Secret Name
Plate 75

Secret Name
Plate 76



I.
GLORIFY, Honor, Worship, Omnipotent, Omnipresent, Omniscient Just GOD thy FATHER.

II.
LABOR six days, Honor the Sacred Sabbath: Do NOT EVIL: Partake NOT of Alcoholic, VILE POISONS and fall from GOD and Heavenly Mansions: Be HOLY, PURE, Worship GOD only.

III.
ALL GOD'S daughters and sons from Fnr Ava and Fna Adam marry chasteily line begetting in unison holy Children on broad lines of land and waters for peopling Earth for Heaven GOD the FATHER GOD the HOLY SPIRIT ONE IS complete Creator of Messiah, Mri and Just to whom HIS SON CHRIST is given the Brother and Saviour of all Mankind ONE with TRINITY, Angels, Woman and Mankind Honor: Chisel, Engrave, Write the COMMANDMENTS, LAWS of TRINITY GOD on the Square, Rolls, Leaves, and Shells of Oceans: PRAISE GOD with dignified speech, voice, music, instruments, acts, deeds in spirit, truth, thought, mind, heart, and in all thy members plously preparing for THE JUST Judgment with rewards proportionate to Merits: punishment from exact JUSTICE for the evil practices done by, in and from the earthly body THAT GOD ENDOWED WITH FREE MORAL AGENCY FOR CHOOSING AND REFUSING GOOD. TO THE WAR FOR GOD, HEAVEN, Mansions, Paradise, TRUTH, HOLINESS, RULER, COUNTRY, STATE, EARTHLY PARENTS, LONG LINE OF BEAUTY, LIFE, LAWS, ORDERS, COMMANDMENTS OF THY FATHER GOD WHOSE SWORD WILL BE WITH THY SWORD TO TRIUMPH AGAINST THE VILE DESTROYERS OF HAPPINESS, HOME, MERCY AND PURITY: FINALLY when PURE to GO TO GOD and dwell in God for you are the Children from God and part of God that destroys not GOD.

III.
DO LOVE one another with Godly Love: GOD is PURITY LOVE.

V.
THOU shalt NOT KILL ANY MADE IN God's Likeness: GOD only GIVETH LIFE and THE SEED OF LIFE and GOD alone has THE RIGHT TO TAKE LIFE, and destroy THE SEED OF LIFE ETERNAL: LIVING bury thy dead, MARK their graves with Tablets: Returning their Bodies to Earth and the Waters, GO Soul and Spirit to GOD that GAVE IT PERFECT.

VI.
HOLY IS TRINITY, all possessing Creator gave to the Womankind LIGHT: the Sun, Moon, Stars, Planets, Inhabited Land, Waters, Earth Food, Animated Life, Power, Dominion, and Possessions: DO NOT STEAL from any, Do not LIE, Do NOT DECEIVE: Be TRUTHFUL, PURE, HOLY, CHASTE: ALL belongs to God of Heaven who IS JUSTICE GOD OMNIPOTENT.

VII.
IN A SQUARE thou art ONE WITH TRINITY, LOVE, HONOR and OBEY thy FATHER IN Heaven: HONOR, Love, Obey, Respect THY MOTHER AND FATHER, OF GOD, on Earth and Land and the Waters.

VIII.
SEEK for Justice WISDOM FROM GOD: Heaven, Air, Waters, Earth, Planets and all things pure and clean, THEREIN thy CREATOR GOD IS OMNIPOTENT AND OMNISCIENT.

IX.
God's Commandments, Honor, Justice, Labor Laws: Love, Mercy, Obedience, Probity, Respect, Righteousness, Truth, Wisdom from unchangeable OMNIPRESENT GOD: To do unto all others that which you would have them do unto you, the children made by the merciful Creator, image of purty TRINITY GOD.

See Plates No. 10, 52 and 53

The O=Fa which was the primitive name God the Benign Father of all Wo Man Kind on Earth.





IN EARTH THERE SHOULD BE LOVE AND PEACE TO MANKIND: IN HEAVEN THERE will be impartial justice, punishment for the wicked: rewards for the righteous!!

Fut, the son of Ham, and brother of Cush, Mizraim, and Canaan, was the founder of China and his monogrammic name is in the center pl. 75, p. 35, Vide Genesis X, 6. & 1, Chronicles I, 8: also 8 on Dighton Rock and the monogram C of New Port Tower & seal on Peter Fancuil Tomb: Put, or more correct of many spellings, Fut, that wrote a tablet Fa, Fo, Foe, Fohi claiming his line as the son of God, Adam, Noah, Ham, and China was named after his son, Chin Hong, and it was said to have been destroyed by Ching Hong, but that is very doubtful, for plate 10th, page 5th, translated into primitive languages, gives that as the tablets of Fut which he copied from the tablets of Noah that God gave to them.

The secret name of China is called by Chinese "the Secret Eye" and is monogrammic of every ancestor of Ching Hong's ancestors, female and male, to Adam and God.

Fnr Chia, wife of Fna Bahman, was a blood descendant of Chin Hong, that mud was thrown at in allegation that he was the first to discover the making of wine from rice that was first made by Cain and spelt "Vino." Cain drank serpentine evil & God's purity went from him and he cut and slew body of upright Abel whose soul went to God," "body fell."
1st Generation, Noah; 2nd, Ham; 3rd, Fut; 4th, Ching Hong; 5th, Hwang Ti; 6th, Ti Ku; 7th, Yan; 8th, Shim. Fa na, Fa Fo, was another name for Fut and the A is an Arabic letter like unto our I or 1: Nh, Noe, Na, N1, Noa, synonymous with Noah and same before the modern grammars, partly destroyed history which herein are partly disregarded. Pl. X, 2nd row towards right may be observed the "Eye of China" = Morality, before Confucius name, Fa Na Ld which is the Chinese name for Fernald, and under after rivers of first line the Chinese word of four lines=, JUSTICE.

Part 2. Vol. 3. Plate 1. The Roman base out of Marquis Valerius

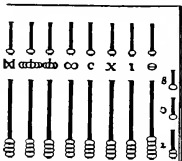

The Chinese base from the Changchuanary Chinese 9 places or Digits

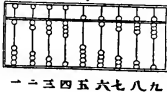

Ten 000

一	二	三	四	五	六	七	八	九	十	十	十	十	十	十	十
一	二	三	四	五	六	七	八	九	十	十	十	十	十	十	十
一	二	三	四	五	六	七	八	九	十	十	十	十	十	十	十

自百二百三百四百五十百七千八千九千
 自十百一千二千三百四百五十百七千八千九千
 自十百一千二千三百四百五十百七千八千九千
 自十百一千二千三百四百五十百七千八千九千

自十百一千二千三百四百五十百七千八千九千
 自十百一千二千三百四百五十百七千八千九千
 自十百一千二千三百四百五十百七千八千九千
 自十百一千二千三百四百五十百七千八千九千

一五八六九九之
 一五八六九九之
 一五八六九九之
 一五八六九九之
 一五八六九九之

PLATE 77

“R

EMOVE NOT THE ANCIENT LANDMARK, WHICH THY FATHERS
HAVE SET. ROB NOT THE POOR BECAUSE HE IS POOR: NEITHER
OPPRESS THE AFFLICTED IN THE GATE.”

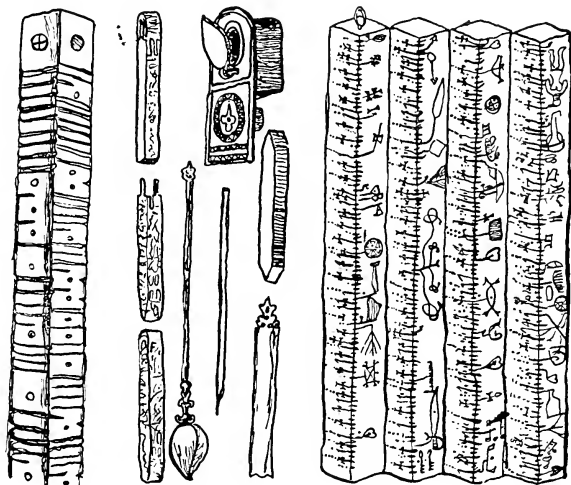

*The Log of Fur Chia and Fria Bahman,
whose names are on Dighton Rock.
Taunton River Mass.*

PLATE 78

Plate 78. This ancient chart log recordeth the sea voyage to Anona of Chia and Bahman. "I, Fnr Chia a descendant of Ching Hong and wife of Fna Bahman of Fars=Persia to the Land of my forefathers, Noah, Ham whose son Fut from the land of the pyramids to, China, so called from name of Fut's son Ching Hong, fr. Hwang Ti, fr. Ti Ku, fr. Yan, fr. Shim, my honored ancestors: I fix my old family seal that of mother Fnr Lamar, wife, fr. Na=Fna Noah and place within seal of my husband Bahman lines * in seal of our Father Noah which I darken as the face of God was dark for wine drink of Noah and his sin. From Fars we sail and row, June Thursday, 221 A. D. to Omo=Ama, Annona=Augustii. Sunday we worship God and his face is no longer darkened and for seven days we sail and worship God the Father and God the Holy One and Christ. With mariner compass made in Ægypt and used by Marcus Agrippa Lucius Furnius and Christ, and Paul, (See Acts XXVIII, 12 & 13) (and above Compass) at right of Coffin, and Seals—one made darker—also two below: 1st, Killed by old foes at Tower; 2nd, Chia's on which she had pictured her grievous sorrows for the great affliction that had taken her beloved Husband's and Son and a Child's





DEPARTURE TO THE GREAT SPIRIT. SUNDAY THEIR THREE SHIPS, 90 DAYS SAIL ARRIVED AT LAND OF PYRAMID LAKE AND WORSHIPPED GOD THE HOLY ONE. TWO DAYS LATER THEIR ARMED FOES ARRIVED from Roma. Chia's son was born Monday A. M. of lawful descent from oldest line of Noah, Antedeluvians line of Pyramids of Anona, Ægypt, Roma, Fars, China, Babylon, Arabia, Furni, (see picture writing on 2nd white space of Almanac Genealogical Chart Log, Pyramid Lake at top, Arrow, Spear, Legal Square Document), squares and pyramid with 16 lines and the son born, Serpent Mound and Egg of promise of God to Ava & Adam of Antedeluvians and Noah, Lamar: Family Rake with ten lines and proved claim at third Letter Symbol in the Hebrew first word of Genesis BRASFT, and the union of these shown in next notch, the Sword of C. Furni which is claimed in secret name of Confucius, (as FANA C. FANEUS=present Chinese as Fa Na) (and in the U. S. is found in Newport Tower, monogrammic construction) and Chia a descendant, (and his Birth June 19, 551 B. C., at Loo Shantung and died 479, Had Son and gr. son Tse-tsi. And in 1671 A. D. 11,000 bore his name

74 generations:) the sword China as son is here marked SON: the Keys below of of 221 with the three ships of and Chia and top of third and good heart of the ancient the Oregon Lake, Mexican ers (and to Confucius secret pyramid' that gives it), four is Peter Funal tomb, variously name" spelt in 125 different a deed, power of Atty., Wm. Firnald, my honored father; on History of Creation, True, Mounds, 46, 47, 49, 50, (54, also, on U S. Coin of features



PLATE 79—Masonic Emblems. Primitive Alphabet, Etc.

New Port Tower, Dighton Rock, and Roman Coins, with many others, even on the Ancient Masonic Tressle Board that is above full of True History: Also Primitive Alphabet, God's Gift to Ava and Adam. Returning to this above True Chart called by those not conversant with it or True knowledge that on it a large volume might be with much profit written. We site the 5 ships of M. Agrippa L. F. Cos. III at 2nd long symbol on space, white, of first four upright on right columns, beneath 5 of Agrippa, the three ships of Chia, their foes two warships: Chia's good loving Hearts one married union to Bahman long line (see B) the New Port Tower work that was commenced by Marcus Agrippa L. F. and son left there who had four descendants and died: Chia's harmonious (harp) construction in building the Tower, which Agrippa and son had not, but she completed for building the Altar that God commanded in Omo where Sun first shone on his son Adam: the letter of Agrippa and Chart of Noah and Ham: 3rd column—the mound copied on tressle board: dates 1533: Masonry formed 335, January 1, when Cain slew Abel, and his children did wrong. (See plate of Noah in 2nd edition) This was done by their foes who did acknowledge their claims to the Egg of Promise for generations complete to Christ 4376 and revolving time to 44 Christ return to God of Annona and Ægypt the Tower and the Rock (read from bottom up to top of Tower being raised) and even their scales of right gave them the original squares, but they claimed the copy of them by Fo: the true right they ceded to Agrippa's line the pure brave heart of Chia who was related, but nearer in Fnr Bahman her well beloved husband whose hearts and minds were in unison of the lines for 22 generations were perfect, even with them from marriage with their line in the eleven lines, the glorious Sabbath they

of males, most of them b. in part of C. Furnius and part of with dot of sun or properly lights bear the ancient date the line, wards, that of Bahman column showeth the union half pike united below with and Ægyptian pyramid build-name I have added the Pike kept to this day in seal on spelt, Fancuil ("Fernald-ways ==) with the said seal on Firnald to Jonathan Poor and after it, Fnr Lamar's seal which is kept in Plates of 55,) 59, 61, and this Chart, of Temperance Washington;



TO WORSHIP CHRIST AND TRINITY: FOR CHRIST THERE HAD COME AND GONE: THE GREAT SPIRIT, MANITOU, with the Indians, whose daughter had married Marcus Agrippa L. F. son, line; and she was born of Oratotta the great king line, and she one of the Egg's, promised line. They raised the steeple together that bore upon it the name of God, the Great Spirit, Fa, that they all unitedly worshiped (see Roman Coin

at, Chapter X, in Vatican, round O with ten lines in it on hieroglyphic 4th column below Pitcher, o, in center of same the arcian name of Omnipotent God.) After the triple union, monument completed, Inscription on Rock =Farenes was killed, a da. was union was purely perfect: a son peared and all again joined to munion and life in their line unison and Chia showed forth M. Agrippa L. F. and true claim universal brotherhood of Christ on the Tower Altar in the land Sarcophagus or coffin is & Sassan their son. Pyramids, 8 towers and 2 and (two dead) coffins of part reading which in for this edition. This very ancient times is on before you for evidence I find that Ezekiel, chap.

to wood
a n d
Nation that
more in
than in the
Solomon
height of
power and
Pl. 80 and
found in
are part of
54 gener-
15 Gen. Fna
Att & Fnr.
of F. Tta,
=Ynm,son
s. F. Hama,
Hebrew,
Noah. Pl.
valuable, as

shown in prim. languages most interesting historical and religious facts and data. "First principals" gives in the primitive language the date 4376 of the creation of Wo-Man-Kind and the date 4376 of the coming of the Son of God the Messiah and Christ pure Son of God. It shows the names of the Trinity, and Woman, Man & Children, to be honored by birth of Christ the Son of God. Babylonish characters give Trinity first letter is the second of the primitive alphabet. At right hand the Egyptian.



PLATE 80
(Plates 80 and 81 are Masonic)



PLATE 81



First principals



White letter style



PLATE 82—Chinese Seals, Symbols, Characters, Egyptian; Babylonish

Sassan was wounded F. Bahman under Tower buried. The of Agrippa L. F. line had appartake of the waters of Com-worship of God their hearts in Bahman's eleventh descent from to Augusta, Egypt, Omo, for all that is recorded in and of Anona, U. S. A. On third

pictured heads of Bahman Chinese head, dotted two showing shapes of arches etc., etc., all confirmatory entirety is too voluminous record in conformity with the Log Chart placed and study. After writing XXXVII, v. 16-20, refers

writings
Hebrew
are now
numbers
day of King
in the
his glory,
wisdom.
81 were
Egypt and
Fna Afras,
ations to
Atta, son of
Mrai, son
F. Animim
F. Mizraim
H a m = i n
Hm, son of
82 is very
thereon is





PENTHY MOUTH
JUDGE RIGHT-
 eously, and plead
 the cause of the poor
 and needy."

On Plate 83, from Bureau of Eth-
 nology, p. 272, 1881, are fifteen plates,
 obtained from mounds, ancient graves
 of Mound Builders: 8 cut in shells:
 one in stone: three painted in pottery,
 and four on copper. Four Pyramids,
 top left Oregon, 10 lines: right, 13
 lines, prophecy of U. S. A., Avon, Map
 Chart of Ham and Noah: two below,
 14 and 12 lines genealogy of family of
 Ægyptian descent surrounded with
 circle seal: cross points of compass from

N. to S., E. to W. Plate 12, the Greek
 Cross, lines signify Ava, Adam, Nh.
 Hm: 6, going forth of Noah and sons
 to people the world. 2nd plate the same
 as first, except it shows that Christ the
 pure was to come from impure menkind.
 3rd. 14, 15 imprisonment, death for early
 Christians after Christ. 7th, Greek, 33
 circles for Roman Star, 8 & 13, Seal on
 Peter Faneuil Tomb. 4 & 9, Garden of
 Eden and four rivers flowing from it and
 that the Mississippi. 9, Anglaise, English
 peopled from here and their Flag Cross
 11, gives this as Land of Raven.
 5, Bahman & Chia and circles 5 pointed
 stars of Ægypt & Annona, center the
 worship of the Son of God. 10 repre-
 sents one God Trinity. Hebrew 12 Tribes:
 the Squares four are the Greek initial for

Christ and 16 lines are four sqs. end sticks Log
 Chart of Chia's and put the eight r together and
 the two golden Squares God wrote commandments
 thereon for Ava, Adam. Pl. 84, Shells from Stone
 graves, Tennessee. Record, 1, Christ here teaching
 the descendents of Marcus Agrippa 21 A. C. and
 M. Agrippa L. F. here 29 B. C. part on Bone from
 New Jersey; the two Square Tablets he taught from
 God's truths. Pl. 85, 222 A. D. Chia Tablet
 found 1841 at Cincinnati: 5 in. x 2 and 6-10 of fine
 grain sandstone it Recordeth—"I, F. Bahman and
 wife F. Chia cometh in three ships from Fars to
 Omo, Anon with my five children and sailed
 Thursday June 22: 11 in descent from my fore-
 father Marcus Agrippa Lucius Furnius who came

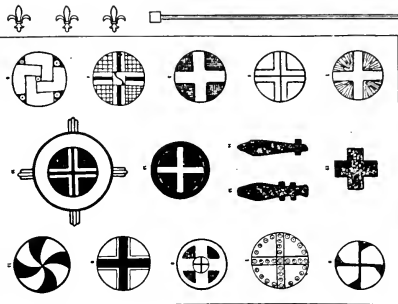

PLATE 83

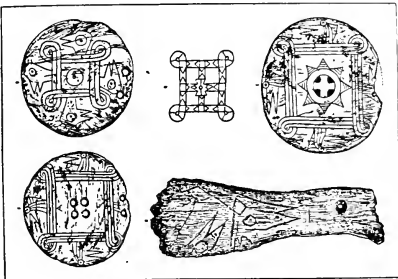

PLATE 84

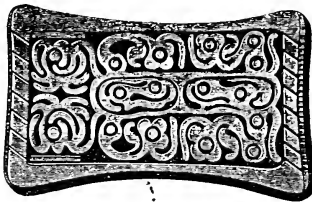

PLATE 85

Wed. B. C. 29 with Five Ships and named it Augusti



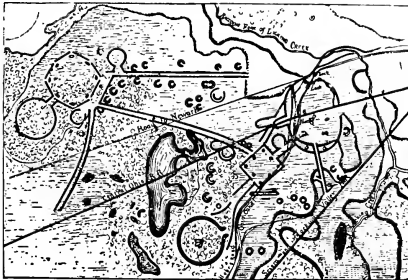

PLATE 88



PLATE 86

“**H**ERE WAS MARRIED MY SON of Roman, Hebrew and Confucius descent to the Queen da. of the Country of Oratotta and begetteth a son. Father Agrippa’s heirs born here are as the Trees of the Forest Numerous and show Roman descent. Am of Thecla and Egyptian forefathers and son of China Fo=Fut. We pursued by two armed ships they, the—” For further translation see Second Edition: —Plate 88, Newark Works: Elliptical enclosure 1250 and 1150 ft. in diameters was formed by embankments 12 ft. high, 50 ft. at base with an interior ditch 7 ft. deep by 30 ft. wide. From this an avenue leads to a square of 20 Acres, with seven mounds, symmetrically disposed. Many other works for religious and military use occupy hundreds of acres with their geometrical configurations. One Octagonal Earthwork over 50 Acres is connected with walls 300 ft. with a true circle 2880 ft., Parallels on opposite sides 100 ft., then midway

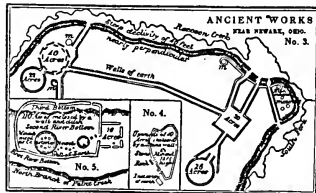

PLATE 87

across this an oblong mound 100 ft., and rises 8 ft. above walls “The Observatory.” “A Relic inscribed with Hebrew characters and called the Ohio Holy Stone”: that I hope later to obtain photograph of it. Plate 87—Peru, Sierra da Onca, right bank Rio Doce was found a drawing in red ochre recording: “Marcus Agrippa came from Roma 28 and 1 B. C. with 5 Vessels to Oma and began to build a spear Uemple and on went to a River Rock and chiseled on it and called the land Augusti, Ananoni and sailed away with two vessels 220 and 1 years came Fna Bahman and finished the Temple Fort and went to the Rock & wrote: three vessels came and landed soldiers and chief with long spear killed in battle long Chief or King of three Ships was killed by the Indians as an Otta stabbed through, they united friends and rejoiced worshiped at Temple, Went out and son of Chia Married Indian of Agrippa line and Chia went away with one Vessel.” “16 armed vessels shall go forth upon the waters,” etc. Pl. 87, No. 3, is to be seen most important symbolic, religious, Military and Historic Works that add a long chapter to the long needed true history that is immutable and can never die:

N. B. Observe name of Trinity: primitive alphabet: and connection of the Y shaped to Square Hebrew M with count of Six a *, also with inscriptions on rocks at Monegan and Damaris Cove Is., Me.

“**WISDOM DWELL WITH PRUDENCE, AND FIND OUT KNOWLEDGE OF WITTY INVENTIONS.**” Plate 89, an earthen ware copy of part of the history foretold by God on the written Map Chart and given to Ham and Noah when he said, “I will make of you a great nation who shall return to Omo form a great Country whose Banner shall be the stars of Egypt and people Anglais and both shall worship Christ the Messiah.” 13 Pyramid points, two

missing, and 13 circles, two missing, represents original thirteen states of U. S. Two pyramids on head that of Oregon and Egypt. Serpent tail the Mound serpent at Adams Co., Ohio, emblematic of God’s promise to Ava

& Adam for his sin and Noah’s thereon shown Plate 90, Confirming truth depicts more clearly the detestable sin, etc. Plate 91, On the northern banks of the Wisconsin rises a group of mounds which have been a true puzzle to explorers. It has one figure 180 ft. long; another 160 ft. arranged horizontally and perpendicular as regards former. A series of mounds. It declareth:— “The II child shall reveal the sin of Adam and Noah to U. S. A. and his name is

F A O the center round body groweth Large from sin” etc. Pl. 94, Group of mounds at Straddle Creek

Ava & all. etc. Pl. 93, Ameghino’s reproduction from Argentine Republic, Rock at Ceara. “A great Nation shall go forth from Hm, Nh, Sm, Jft whose Flag, 5 pointed Star emblem, shall Herald Freedom welcomed



PLATE 90

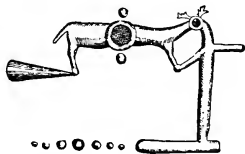

PLATE 91

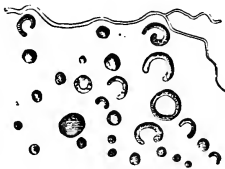

PLATE 94



PLATE 89

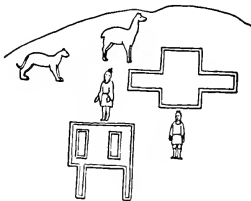

PLATE 92

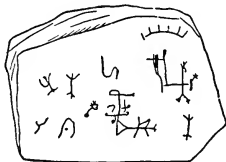

PLATE 93

and Plum b Rivers, Illinois. This mound allegeth worship by Chia and Fna Bahman of God, The Father, God the Holy One and God the Christ; with their families. The great darkening of the face of God for killing Christ and the blood representation He would call to judgment them for their sins, and the churches that slaughtered the pure. Plate 92 recordeth the promise of God to ancestor of Incas of the coming of Christ to be born of the line of Noah, Ham, Shem and Japeth (See Pl. of Adam and Ava) that they should teach from the two Tablets of God’s gift to

“SAY UNTO WISDOM, THOU ART MY SISTER: AND CALL UNDERSTANDING THY KINSWOMAN.” “La 'sagesse ne crie—t—elle pas, et l'intelligence ne fait—elle pas entendre a voix?” Confucius wrote:—“The men of antiquity used knotted cords to convey their orders.” In This Quipo that beareth the ancient sword of Furni, China and Japan on upper border that Fna Bahman, and

Fnr Chia of oldest and Tablets of Purity Japan and Rome By Translation from “After the Flood had the Golden Rolls loosed a Raven Dove that returned branch.” TA VA N A - 1 5 U P N

named Fi Ru = son Atta and Mra Pyramid built by Land, Omo. Ata Nation who wor-rejoiced the six Ala Fu Chathrough and Bahman who

of M. Agrippa L. Furnius B. C. Their names were M Ama Oa L L O who Father of all from His picture of the Sun and Inca & built Cu ZcO His seen on the Rock at F. Bahman from Att, Mexico was peopled by from Marcus Agrippa son land of the Serpent of wife La and a tribe Agrippa were the first to be tribe Chic Ci and wife fragment after reporting hor-to be ever regretted that the were destroyed by fanatical be monuments of Idolatry. peror Fo were said to employ by Quipos and if that is correct conversant with the strange China in the primitive lan-the upright line from Noah's the Pure One in God. Pl. 96. Fort Hill, Ohio. Compare

Tablet of Abydus, 37, 38, 39, 40 and 41. It counts 68 generations of F. Chia's dead husband's ancestors and 1855 years. It was built by Chia and Agrippa's descendants who worshiped God the Father and Christ the Son of God and commenced Dec. 30, 223, 20 days after death of F. Sarssan, finished 7 December, 224.



PLATE 95

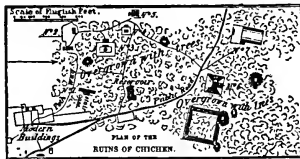

PLATE 96

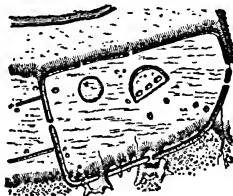

PLATE 97

line with God's Roll with which China, were conversant:— right to left:— Noah and Ham who Squares and written that flew to Omo, a with an olive TISU Y U=AV Peru by Spaniards or F. Ava line Ata, of land of Lake God in Mounds formed a mighty shiped God and Nations: Chili the da. of Fna Chia married a descendant

and Ohrat-Ota 1, b. 628 Man Cocca C. Married worshiped God the Symbolic Name, the Moon. He was the first and their record may be Anona, by Chia and Mrai, peopled Japan.” the line of beauty Chia of Anono the Mounds Promise. Tu and his descended from Chia and

followed by a more warlike F. Macca.” And here this rible barbarities, ceases. It is greatest number of the Quipos Friars that conceived them to The Chinese before the Em-this mode of keeping records Fut's father must have been writing. The meaning of guage is “Christ of Heaven,” God and God's line is Christ Ruins of Chichan. Pl. 97. this with the History given on



“**T**USTODIET RECTORUM SALUTEM, ET PROTEGET GRADIENTES SIMPLICITER,” Coming to generation 37 and Plate 98 we have the fitting out of an expedition by Fna Ramanka against Omo even then known as the land of Anonna, Serpent Mound, where he with his son Fna Usakaf where he got his head injured by a War Club and was Trephined and died 1632 B. C. at a cemetery of the Yucay Valley which Squier speaks of as a Peruvian Skull but is

that of F. Usakaf which in Gen. 38 the The form of Operation is of religious Squares God wrote the Command-inflammation, and some eminent Sur-not hesitated to attribute this to an op-years, May 22. His son lived 222 yrs.

Plate 99. This Ax ploughed up six in. long by three and one-half American Ethnological Society had on two above blade on groove for handle sides of the blade, the appearance con-and no proof to the contrary. Trans-“Cyrus the Great”: from 53rd to Government it is of inestimable value found name of “Washinton” 926 B. C. is on immense Mound on high point country, cone shaped, 131 ft. across ft., 62 ft. high, surrounded by trench hewn steps of stone showing an ad-foot below the surface there was a entire top of the mound: placed in to defy the ravages of time in all com-ft. wide, 11 ins. thick, hollowed in cen-ft., relics in it a broken column

Plate 100. Religious Mounds com-Messiah. Three Pyramidal interior Ramparts the days of Labor Right age of Christ who was born of Mary in Heaven 10th of October 44 A. D. Kind the right hand lower corner and was built by Gnaeus Agricola wife, 4431 M. Furna and the Agrippa L. F. of Egyptian de-where God built the first Pyra-Oregon. Was it named from count the 6 pyramids on Helmet ical of descent, containing on one God, copied on top of New-C around neck of Christ united waters edge of coin, right shoul-branch broken off for T initial of his Taunton, River, 4 dots of o, in more truth from these Mounds; symbols r. cor., bottom one God kind: 5th pyramid two sitting on,



PLATE 98

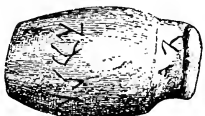

PLATE 99

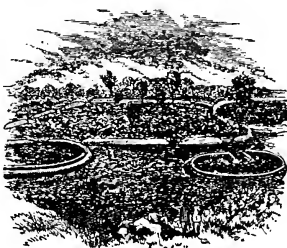

PLATE 100

piece of bone removed is illustrated. origin indicating the form of the ments on. The bones showed ancient geons, such as Nelaton and Broca, have eration during life. He died aged 182 gr. son 224. See Catouches.

at Pemberton, New Jersey, 1859, about broad, reported by Dr. J. C. Evans to it 12 Characters, letters or symbols and the former running around on both sistant with the idea of its genuineness lation: — “Anm=Anamin 2nd” to 71st Generations inclusive. To any and most to U. S. as it records the first Township 31, Greene Co., Missouri, of a hill, 300 ft. above the level of the summit, circumference of base 1,500 except causeway on North; rough vanced state of civilization. About one regular and solid platform covering the position with a precision and firmness ing ages. A flat stone 12 ft. long, 10 tre 6 ins. Margin around it about 1 found with a tooth and pottery.

memorating the coming of Christ the Mounds represent the Trinity: six hand upper Corner the earthly parent and Joseph 10th October, 4376: Born and is ONE in God united to Wo Man left after his death or translation. This

Julius C. Furna-Furnius and his numerous descendants of Marcus scent at Oma land of Anona mid in Lake of Oma, now called these works? See Gen. 96: show-points of Hebrew Star typ-top the round symbol name of port Temple Fort, three o and with Mankind, Pyramid on der, cross points of compass, and mother Thecla, Dighton Rock, cross compass points, etc. Much 6 lines days of labor, M and C with Christ united with man-a claim, the land of Ava & Adam.



Das du nicht gerathest auf den Weg der Hölén, noch unter die verkehrten Schwäher.

N MANUEL OF CLASSICLE LITARATURE by J. J. ESCHENBURG.
ADDITIONS, N. W. FISKE.

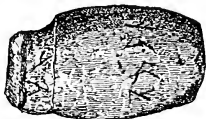

PLATE 102. Stone hammer from Pemberton, N. J.

Pl. 101. We have important facts and data before the learned gentlemen were conversant with the Primitive Alphabet in fact they had arranged it on this plate without knowing the great good they were accomplishing. As it is on pp. XXII & XXIII described we may touch a few of many parts:—'2 top lines 1st Letters symbol, O and @, 1 equal Fa, and in Gk. Omega, which means Trinity in the Ω, that is three is one God, which was meant by Christ when he said "I AM, Alpha and Omega" and even here the three letters I A M. is the alphabet for I is an Arab A—an Egyptian I, J, H, F, and three sides of A represents Trinity, last letter of 1st line is the Egyptian ψ shown (5) in Catouche under sch, the 1st. letter 2nd. line is Greek TH and symbol of THEOS whose English name is GOD and half @ is shown in Fig. H. Δ At C Fig. the right Pyramid represents that at Anon=America. Plate B the first letter is A primitive and earth picture, is pyramid on lake Oregon land, Ohio serpent Mound was built and the mouth of this second letter is form of the terminal M=Y of our alphabet. The terminal N is Hebrew A called Olif=Olive. Left Catouche represents God's Face darkened.

AT THE MODERN OMEGA 2nd letter and 2nd line from right is kept the names of Trinity by first third God the Father—2nd third a Gk. C pointing top to left, God the Christ, 3d part, God the Holy One in Three.

Fig. D, reverse and at right hand upper corner read "God the Trinity Creator of Heaven and all below, created Ava & Adam, that they two should be one pure and upright, like unto God their Father: etc. At 2nd space bottom when reversed see picture of pyramid of Ham, told in 7th space 3rd of last three Hieroglyphics, in Anon that Egypt copied of Trinity and Ava and Adam were fourth from Trinity God their Heavenly Father that came down to Earth. Opposite III is the symbol B. (Pl. H) and first in Hebrew Bible the Churches copied from and the same in Egyptian, which correctly read gives the TRUE and FIRST PRIMITIVE RELIGION before its change by priest craft and orders from those in Authority over Nations. For Satan's sins and the emulation of mankind to equal GOD, The Serpent Mound over the waters of Egypt that hath the promise of Christ the coming Messiah his son who would TEACH FROM THE GOLDEN TABLETS. It gives the name of Animim the son of Mizraim the first, etc. He the son of Hm, s. of Nh, s. of Lmk, s. of ancestry to Ava and Adam the children of God Our Universal Father. (1st mention of Golden Tablets found)

PLATE 10.

3°

PLATE 101

W

Ἰνὰ μέρισσῳ τοῖς ἐμὲ ἀγαπῶσιν ὑπαρξίν, καὶ τοὺς θησαυροὺς αὐτῶν ἐμπλεῖσῳ ἀγαθῶν
 Ἐὰν ἀναγγέλω ἡμῖν τὰ καθ' ἡμέραν γινόμενα, μνημονεύσω τὰ ἐξ αἰῶνος ἀριθμησαί.
 —Proverbs XX, 1

Plate 104. The Babylonish history declareth — "God the Trinity created the Heavens, Earth, Waters, and all therein with Trinity. That they turned obedience God drove them from brought the waters of the flood another and led women and men made in the image of God their ambush for evil and war. They they were fair, they coveted them tivity and would not let them escape of Shem, son of Noah, who led land of Omo where the Sun first Mother World Anon of God, the he by command of God and advice Good, and there abideth to the As the body politic became more the pure were wronged and d pursued. Some were slain and the slaves and worse of their angered God that they choose evil and use every down to their own depth the ing the innocent whose tected them and they were MENE TE KE L U P commanded and decree ALL THE WISE MEN

Plate 103 is the Eight Chinese nine which it adds TRUTH TO ALL MAN-Babylon, Chaldean, and "The confusion of tongues" Babel is untrue. Every change and in all are to be language of primitive times. and he knew the primitive. glyphs were the most change by an ancient Phy-anatomical illustrations very first and all others were in enty were celestial anatomical, of Vegetable and floral, animated Kingdoms both of land and water and all therein and thereon with a sacred meaning.

history declareth — "God the Trinity created the Heavens, Earth, Waters, and all therein with Trinity. That they turned obedience God drove them from brought the waters of the flood another and led women and men made in the image of God their ambush for evil and war. They they were fair, they coveted them tivity and would not let them escape of Shem, son of Noah, who led land of Omo where the Sun first Mother World Anon of God, the he by command of God and advice Good, and there abideth to the As the body politic became more the pure were wronged and d pursued. Some were slain and the slaves and worse of their angered God that they choose evil and use every down to their own depth the ing the innocent whose tected them and they were MENE TE KE L U P commanded and decree ALL THE WISE MEN



PLATE 103

Fig. 1.

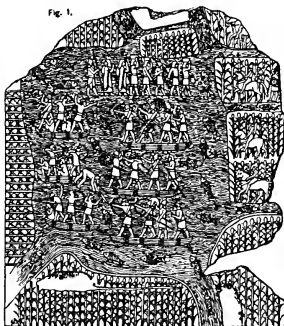

PLATE 104. BABYLONISH HISTORY..

from God and for their dis-the garden and for their sins upon them for they slew one into captivity. Destroying man heavenly Father. Even lurked in looked upon the daughters of men, for wrong, led them away into cap-their evil power. For Asshur, son them from God built Pyramid in shone on Ava & Adam. The One God. Asshur saw the land of Noah led them unto that it was downfall of Babylon the wicked. and more sinful while, evil was, persecuted, as they fled they were others led back captives to become merciless conquerors who their own freewill should effort in their power to drag godly. Thus as ever destroy-prayers answered: God pro-self destroyers. "MENE, HARSIN." "For the king went forth: DESTROY OF BABYLON."

Commandments same as in to the Second: "TEACH KIND." From Assyrian Ancient Greek Languages. at building the Tower of twenty years all languages found a part of the primitive Christ taught in languages Picture symbols and hiero- valuable. The myth of a sician of the alphabet into needs an oblivion for the copied from God's whose



“S

IN QUELLA STESSA NOTTE BELSASAR, RE DE CALDEI, FU UCCISO.”
 “FIGLIUOL MIO SE TU RICEVI I: MICI DETTI, E RIPUONI APPO
 TEI MIEL COMANDAMENTI:”“PERCIOCCHIE IO V’HO DATA BUONA
 DOTTRINA: NON LASCIATE LA MIA LEGGE. PERCIOCCHIE IO
 ANCORA SONO STATO FIGLIUOL DI MIO PADRE: TENERO ED
 UNICO APPRESSO MIA MEDRE.”

PLATE 105. Letter A is the Signet Ring of Marcus Agrippa L. F. Generation 94 which counts his line to 53 Fna Anm on whose Catouche is our ancient Seal that has been carried down through the ages and on gr. fr.'s Deed: both his Coin and Catouche have III on it, marks dome shaped on both, and the Arches in Newport Tower, and on right hand of the Ring, the half curves—Mounds of America, The Catouche show the Serpent Mound in Anona over the waters and many more parts in common proving claim. Ring C is that of Cyrus the Great and has his initials on it and a count of ancestry to generation 37 Fna Ramanka and his wife Fnr Bunala.

PLATE 2. Seal of Cambyses Generation, 71 who married Niatatis da. Afras, king of Ægypt that he conquered. In symbols and letters hereon is the Primitive Alphabet and his son and wife, her Mother Thala, & Sammis and others with symbol of Land of Mounds, Serpent Mound, Lake Pyramid, Serpent of Ægypt from Mound, turn seal upside down the crown or the cap turned back, and a V, and Greek N, of Pyramid and the top triangle is etc. The I is made up of four lines, the waters and Earth: the two lines counts Trinity and Mankind & is I, J, inverted V in hand on right, etc. coin of C. Fonei and Seal O on necks is monogrammic and compriseth the signet of Fna Nachro (see Catouches) gen. 68, 67 where inverted pyramid is righted and the V of last letter is seen, reading from right to left, and 66 gen. of So or Zo (see my coin of Z Zo=Fana Zo showing in the Z two VV or W when arranged in position; the R tail represents serpent, oval, the mound the two united lines as I before & R is initial of Ramsass gen. 65 and C his Mother Camilla, and V is Gk. N, initial of Namrut and Vashatana da. Nasa son of Gen. 57, is seen at Seal I that declareth her to be of Hebrew descent from

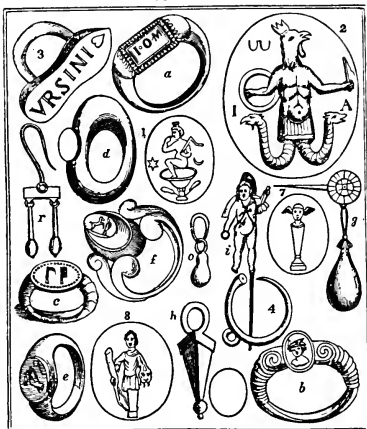

PLATE 105



EGYPTIAN HISTORY OF THE DELUGE CONFORMING TO THE TRUE PRIMITIVE. MULTO IN PARVUM.

on head is the letter M, W, when the A and I were remotely symbolic duplicated by obelisks, count, Trinity top representing Heaven, and bottom upright 11 and 1 is an Arabic A, four F, A, H, etc. A corresponds with the Letter D is Signet of Gen 77, see pyramid coin line, etc. Ring Seal 3



Chapter V

“**I** SAAC, JACOB, AVA AND ADAM THE SONS OF ONE GOD, WHO
 COMMANDETH ALL CREATION AND GIVETH AUTHORITY AND
 Power to Heart Rule unto Wo Man Kind of the Earth and Waters. Jesus Christ,
 Messiah of the line of God's Noah, Ham, Shem, Japeth that came of Anona: Omo,
 Land of Mounds where Adam and Noah sinned across the waters to Araat and Ægypt,

shall be born, of God at Bethlehem, Judea, a Nazarene, Christ, from Mary and Joseph, in a manger,
 whose coming shall be heralded by the bright star guide to the wise, and He to be the Spiritual King
 of Purity for all people of earth, one in Trinity Universal God, 4376: and this is the wonderful seal,
 mighty in history of the Robert Le Fort and his ancestry as per line back to God from Ava=Eve
 and Adam to his wife, F. Alif,
 Born 792 A. D. Oct. 1st, and
 Died June 3rd, 846, and Robert
 whose Ægyptian name is in the
 top and bottom of Seal was born
 10 Oct. 748, died Oct. 10, 867.
 Buried at St. Denis. This seal
 of generation 129 also keeps
 the name of Robert, Duke
 of France. (Gen. 130) It was
 made in form of an oval Egg of
 Promise of Serpent

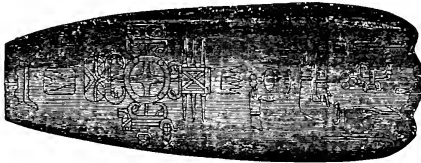

PLATE 106

Mound at Omo=America, and round O with dot in center means son of—and oval at bottom of seal
 is an R=Robert son of (on Crown is the same Ægyptian symbol name) King Robert, of France,
 (Vs. Papa Urban) and in secret cipher records on U. S. Coin was kept Robert as Pike Family
 ancestor (see plate) Generation 155. Cleopatra and Fna Antiochus Seal Ring, marked F on plate, and
 Gen. 90. Gen. 88 and 89:—Seal Ring of Fnr Arsinoe and Fna Antiochus (Theos) Epi Fanous (see
 Coins) B on plate. Generation 53:—Mariner Compass of Fnr Hazzalal and Fna Anm 11, (see
 Catouche lower round body the compass and a Calendar, count lines, etc.) the needle on back side,
 and at base below center pivot the crescent typical of mound and above other mounds built from that
 of Anon which needle represents: by placing the bag shaped body on map at Gulf of Mexico turning
 calendar underneath the needle points North and the other part has the lost head part of beetle on
 catouche restored: therefore in both we have again the knowledge of Ægypt in its crude form giving
 picture illustrations of truth. The lines and dot and circles make a division into six labor days and one
 Sunday, 4 weeks a month, 3 months a quarter, 12 months one year. It beareth the names of Anm
 1st and 2nd and Noah and Ham: etc. On other catouches find parts resembling this relic. At Fig.
 H is Gen. 58 illustrated in part, viz:—Top two circles and line initials of Ava & Adam, shaded parts
 the waters of Flood, two balls on Apex (reversed) of pyramid the two names of God and the deter-
 minative symbol of Arlina and Bocharis. Thus even from jewels we may from work of engraver gain
 facts and data, 3394 is this date and birth of Bocharis. The oval at right is the Egg of Promise and
 it is kept on rings; Peter Faneuil Tomb as also Heart at No. 3. Humboldt in "Vues des Cordilleres
 Plate 106 an Engraved Aztec Hatchet of feldspar passing into true jade obtained from Professor at
 Mexico. This shows true knowledge of ancient history by beginning at left and read to right:—
 "Before the flood in the land of Omo and mounds where the Lake Pyramid off from the Garden of
 Eden was built, and mankind first learned by vessels to go upon the waters: then before Christ was
 born and after the union of Trinity with Wo Man kind vessels were made that sailed N. & S, E. & W.
 that carried the Golden Squares, Seal on Faneuil Tomb, a compass to sail the waters. Disobeying
 God they were driven (Frequent mention of Golden Squares are found from different sources of proof)



“NORTH OFF THE GARDEN OF EDEN GOD’S HAND LED THEM AND BY HIS COMMAND THEY BUILT THE SERPENT MOUND EGG OF PROMISE AND MADE MOUNDS IN THE EARTH AND CENTURIES PASSED: ONE HALF SAILED TO THE WEST: ONE FOURTH TO THE N. W. BUILT MOUNDS AND VESSELS THAT HAD THE HOLY NAME OF GOD ATTACHED, BUILT MOUNDS AND DOTTED. A BRANCH WENT OFF TO GULF: ONE FOURTH WENT N. E. AND THE FINGER OF GOD POINTED THE WAY, AND GOD

directed them, and there they built mounds and obelisks, and were fortified and mighty; before, a branch went to the region of snow like an arrow, had the Lord with them, and their seventh day was Sabbath, and they worshiped true God.” Quipos, some kept these records, others by lines, cyphers, and symbols from the Squares.

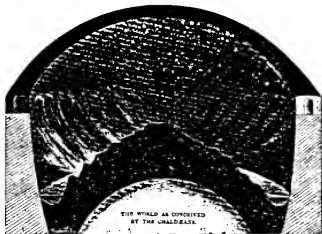

PLATE 107

“Gdy czynil w Egipcie znaki swoje, a cuda swe na polu Soan.”

“CHALDEANS CONCEIVED THE WORLD AS Plate No. 107: That may be briefly described as the Upper abode of Trinity and glorious honored immortals. “The chosen best who improved their talents.” 2nd. The planets and their atmosphere & media. 3rd. Atmosphere of this Planet, Earth, Rocks, Waters surrounding it, crust of earth and its inhabitants, and the molten Center of Earth like unto the rising Sun beyond the Hills and Waters of Mother Ocean to its Inhabitants. “Chwychwi sydd yn barnu yn ol y cnawd; ꝑ nid ydwr fi yn barnu neb.” —John 8:15

“A WISE MAN WILL HEAR AND WILL INCREASE learning, and a man of understanding shall attain unto wise counsels.” Plate 108. Figure 2. The top of obelisk is cut off to indicate the Lake Pyramid at Oregon: remotely ever the Triangle represented Deity and cut off point in Egypt their descent from Anona=Omo=Ama=America as is now known by names. One of several true translations in part of this Obelisk hath:—“After their arrival from Anona that the finger of Ham pointed out to his wife F Anr who desired to go to the East (see Plate 106) (read from top, 2) God was with Anr and Ham to whom He gave authority over the heart and kingly power to religious upright Ham who He made Queen and King of Egypt from Anona and promised saying: Go forth upon the waters and I will make thee ruler of a great Nation for from the Serpent Mound I will lead you: thy children shall multiply and thy people sword shall be one to rule the long line that I giveth thee, build Houses, temples, fortifications, one for Fna Ham family, one for Noah, as I promised thy foreparents Ava & Adam’s long line of World in the land of Anona, saith the Lord, thy God, to beautiful singing women I giveth the long line, sons, daughters, of mine and my children that I will send”

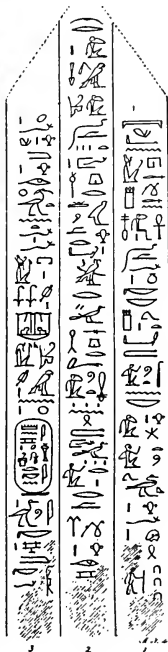

PLATE 108

HURE HEARTS, FROM OMA, ACROSS THE WATERS, FROM F. VASHATANA: *WOMAN, OASAKON, BEAUTY LINES, FROM HEAVEN and Mound Land of Anon they built, and I them, and pyramid, for bird like peace and harmony, to multiply, for honor and glory of Lord, that, to each I give part My Holy Spirit and wisdom to teach, as I them have taught, and to be thankful, and bow down and worship me in words, song, that their spirit may be in unison on land and

waters. Trinity is Lord of Love men unite for greater love and preparing for heavenly joys with point of love, that my eye may laws and commandments on the darkness, hate, misery and death waters destroy the diseased that by evil diseases.***

THA GLILOCAS ANNS NA CUR A chapter I, verse ued from the column, last 6

of Ynm=Anm=Anamim son of =Lamech s. Mtsfsh s Hnk f s. Hebrew terminal M found with s. Kfn son of Anos s. St s. Ava potent Lord God of Heaven, mentioned first in greatest honor Date of Tta death 2000 month from land of Omo first country, forth his name and ancestry and wife Honor and husband right gives Ham and Noah as =Omo by Oratota, I ndia n son also that built the Altar unto Mizraim: Figure C, count 12 in hand of Anm: 13, "the Christ (see letter C) to Ava and of upright lines of Ham, Shem Dight on Rock) and honor Obelisk (see plates of Chinese Hancock Monument, Old (the name of God) I Fna Anm the Serpent Mound and built the my hand I build the Sword Christ to Ava, Adm, Lamar & both I do not Mark for the (the lines declareth) Almighty Universal King that Wo Man the Sword of God and Mankind, Pure to destroy the Satan and gain; worship God and Christ, and land for the Great King of



One! As in love women and more perfect happiness on earth Trinity united, one, a pyramid see, perfectly thee keeping my square; and not fall down to as Figure 1. I mercifully by would worse destroy themselves

AG EIGHEACH A MUGH, FRAIDIBH. THA I A MACH A GUTHA:" Prov. 20. The Plate 109 is continued Plate 108 where in second symbols the death of "Tta son Mizraim s. Hams. Noah s. Lmk Frd (first Greek letter Δ and Egyptian co-existent) s. Mhllal and Adm, children of omniversal. Their mothers are "Holy Eye of God seeth All." Lmk. 11 day in land of Egypt Figure E is Tta who holdeth son Att, gr. s. Atta, gt. gr. s. and Hasafta." and Catouche (F) peopling the country of America son of Ham, and Animim, is the Lord in the land of symbols and the Altar is pictured promise of the coming of C=Adam (3 lines represent) Christ & Japeth (see and feel C in Justice is God, One: the Sword Commandments and Governor Granary Cemetery") (5) "Fa worship as God commanded at Pyramid Altar unto God with Sheath Obelisk to the promised Noah, I chisel the Catouche, Perfection of Christ and God (next Figure) God and Son are Kind united one in four lines: Arrow shall be granted to the his evil workers of Earth to and do good all over the waters Kings is with Us Thee Forever



PLATE 109

*A German V is an English F: here first name of woman VVashatan A=Washington, Anona Land Heb. A=N=O.

**Diseases shown from alcoholics and concomitant lusts more degraded than animals.

“A “PORQUE JEHOVAH SERA TUA ESPERANCA: E GUARDERA TEUS PES DE OS PRENDEREM.”

ABRAHAM, SON ISAAC, SON JACOB, SON JUDAS, SON FARES, SON Esrom, son Aram, s. Aminadab, s. Naason, s. Salmon, s. Booz, s. Obed, s. Jesse,

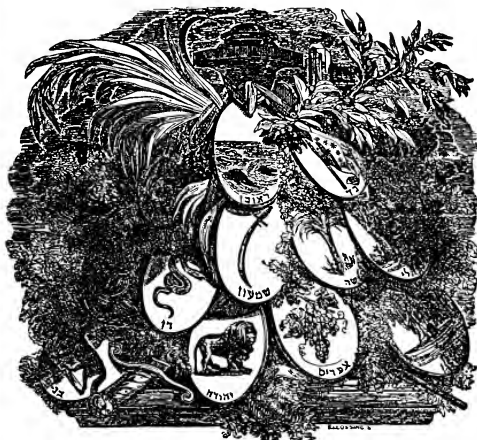

PLATE 110

son David, son Solomon, son Roboam, son Abia, son Asa, son Josafat, son Joram, son Ozias, son Joathan, son Achaz, son Ezekias, son Manasses, son Amon, son Josias, son Jechonias, son Salathiel, son Zerobabel, son Abiud, son Eliakim, son Azor, son Sadoc, son Achim, son Eliud, son Eleazar, son Matthan, son Jacob, son Joseph married Mary of whom was born Jesus called Christ. St. Matthew, chap. I, verses 2 to 16. St. Luke hath chapter III, verses 23 to 38:—Jesus, son of Joseph and Mary (who had:—Jesus Christ the Messiah, born 11 hour, 10th Oct. (= Ham=1ΔΨ') 4376, born in Heaven, Sunday, 10 Oct., 21 hour, 4420; da. Thecla, b. Dec. (=Anm.) 10, 4378; d. 10 June (=Enoch) 4442

Judas:” Jesus mentions John his Brother: Chapter VI, v 3, St. Mark, “James: Joses: Simeon: Simeon and Sisters:” Said Joseph, son Heli, son Matthat, son Levi, son Melchi, son Janna, son Joseph, son Mattathias, son Amos, son Naum, son Esli, son Nagge, son Maath, son Mattathias, son Semei, son Joseph, son Juda, son Joanna, son Rhesa, son Zerobabel, son Salathiel, son Neri, son Melchi, son Addi, son Cosam, son Elmodam, son Er, son Jose, son Eliezer, son Jorim, son Matthat, son Levi, son Simeon, son Juda, son Joseph, son Jonan, son Eliakim, son Melea, son Menan, son Mattatha, son Nathan, son David, son Jesse, son Obed, son Booz, son Salmon, son Naason, son Aminadab, son Aram, son Esrom, son Fares, son Juda, son Jacob, son Isaac, son Abraham, son Thara, son Nachor, son Saruch, son Ragau, son Falec, son Heber, son Sala, son Cainan, son Arphaxad, son Sem, son Noe, son Lamech, son Mathusala, son Enoch, son Jared, son Maleleel, son Cainan, son Enos, son Seth, son of Adam the son of God. (See pl. 320.) Ring of Christ’s genealogy, two, reconciled.

Mari=Mary the mother of Christ was born 22 yrs. B. C. and killed by the sword 51 yrs. after Marriage, of Mary and Joseph 3 Dec. 4375 B. C. Their or Thecla was the daughter of Mary and Joseph and oldest Child born after Jesus. Thacla was the name of a daughter born of C. Furnius that was a Martyr of the Roman Senate A. D. 26 She was the Writer of the Alexandrian Codex. There were two or three more found by the name Thecla. The seal of Thecla photographed may be seen at Gen. 95. Alexandrian Codex at British Museum.

Chap. XXXIV of Numbers. “And the Lord spake unto Moses saying, Command the children of Israel, and say—the border shall fetch a COMPASS from Azmon unto the River of Egypt, and the goings out of it shall be at the SEA.” The old not correct Chronology, 1452. Before Christ.



NOT UNTO US, O LORD, NOT UNTO US, BUT UNTO THY NAME GIVE GLORY FOR THY MERCY, AND FOR THY TRUTH'S SAKE.—Ps. CXV, 1.

From Bureau of Ethnology Plate 111, Fig. 5 is an important and valuable stone, line, circle, star. Primitive Language, religious calendar, Tribal historic plate. Translation:—
 "Before Christ, God the Father and God the Holy One at Anon land and waters of his

first built pyramid, Omo son of Att and Mother Fpr Christ as promised to Ava announced by the Six completing the union of the Kind and Christ too made and Great Spirit One in earthly Parents to be born in Heaven 10 Oct. 44, represent the 12 months of and 12 hours one day of the Hebrew six days of Labor. the D at base of Pyramid, months a quarter of a year, line spaces=12 Months a Seth and his wife Fnr Sana. Ala. that was also listed Gations of the National Munch and about 10 inches in notches represent Trinity, Moon and Sun & two last date of deaths of F. Lyra wife 2300 of Creation of Obtained from Lick Creek It is names of Trinity again

Center cross lines Faneuil Tomb and American Delegates at and South, E. & W. quarters representing Ham, Shem, Japeth; Primitive Alphabet: Lake at Oregon and mids in Mexico, for burial of Pharaan ancient engraving of Denis Pris Du Pont." vast fund of Historical logical data. Figures Etowah Valley Ga. and Ala. Very Valuable. Religious building of carrying: — "F n l= Mr. literally meaning Children all by Creation

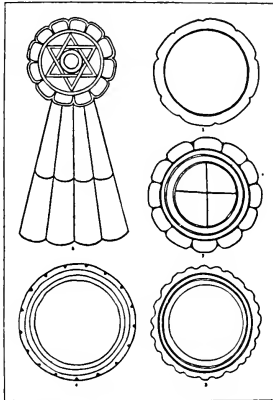

PLATE 111. STONE NAME OF GOD: UXMAL.

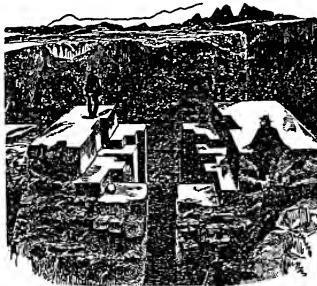

PLATE 112

God promised to Atta the Mrai that the coming of & Adam: 4376 should be pointed Tribal Star thus Holy Trinity with Wo Man of the Earth and Waters God, Mari & Joseph his 10th. Oct., Sat. 4376 and Sunday." Twelve Arches year: 12 Hebrew Tribes light: Six pointed Star Sunday by inner Sun, and triangle and Moon 3 that multiplied by the white year as by the Calendar of Fig. 1A Stone Warrior River In Archaeological Colleeceum. It is nearly one-half diameter: Trans.: "Nine Woman, Man, Da. Son, seen inside two of Trinity: and Fna Tta 2000 and his Ava & Adam. Figure 2. Mound, East Tennessee. and a Calendar see Fig. 5.

deduplicated on Peter and Flag sent to Hague: showeth North dividing the world into the Families of Noah," One of the letters of beareth the Pyramid of the building of PyraÆgypt; one in France mond, that writer has —title "Vue De St. Incorporated in it is a Religious and Genea-3 and 4 from Stone, Stone found Carthage, Pl. 112. Showeth name Fa=God and Miss, Fnr=Mrs., Fna God honored his from Himself Pure.



THIS PLATE, 113, OF DOORWAY OF TOMB AT GIZEH. MOST WONDERFULLY WISE EGYPTIANS KEPT IT AS PART OF THEIR OWN AND INTERNATIONAL HISTORY FROM THE LAND OF OMO WHERE GOD'S FACE WAS FIRST DARK-

ened from Adam's disobedience. See shaded O upper right hand corner which is the monogrammic historic connection with Schoolcraft's excellent 1855 Government Work, U. S. Printing Department. That in this for inability to use the separated symbols it will be less clear to those not conversant with Indian and Egyptian primitive symbols and 34 tongues. Therefore till Second Edition it will be abbreviated as much as possible.

King Powhattan of Virginia was a descendant of Oratota. Five Nations were defeated and incorporated with the other nations descended from sons of Marcus Agrippa Lucius Furnius, and so strong they became that the facial expressions or features resemble the old Romans unto this day. Peace was enjoyed for many suns, or years. Mohawk, from Marcus, is now considered the oldest Indian Language.

Plate 114. A picture of Christ from Mosaic Circle around head count 8=Roman Descent; arrangement of 5 & 6 Circle Star Egyptian & Hebrew lineage; upright part over head means descent from Japheth; note Seals as on Peter Faneuil Tomb. Two of the supporters represent Thecla & Thecl; Thecla, the da. of Mary and Joseph wrote the Alexandrian Codex. (See features, pl. 114)



Plate 113. From my Oxford Bible. Egyptian Tomb Gateway. One of the most important historic plates in the world.

GREAT SPIRIT IS THE NAME OF ONE ONLY GOD, IN 170 WAYS SPELLED.

Upper Right Hand Squares

Translation:—"American Indians" "Yatonwata is Washiton, A. 2500 years before Columbus era.

1. Atatar son F. Bunala and Fna Ramanka, Gen. 37 and 146 yrs. after the Deluge; Had-da. 2. ATARN da. 3. ATORN da. 4. ATIAN s. 5. ATORN da. 6. ATTARNA da. 7. OARTA da. 8. TAROR da. 9. OTR da. RATANO s. 10. ONATA s. 11. ANOTR da. 12. TANO s. 13. MANTO s. 14. AORTANK da. 15. OITAR da. 17. AIO'TAR da. m. Ann 11. Yatonwata. (see compass 53) 17. ANHURY da. Oratota 1 m. 18. YATONWATA b. 1049 B. C. 19. ORATOTA 11 s. Same name 20, 21, 22, 23 Oto Tar Ho s. 24. ORATOTA s. and the same names to Gen. 66 : = XIII. In the reign of King Oratota XIII and s. of 65. Columbus came to America=Omo=Anona=Augusti=Ama-etc. The Keatbakhiehroneh were fighting wth the neighboring tribes and were injurious to the frontier settlement. The Five Nations sends Thoyenogea with an army of 5000 (men) Warriors, defeated and drove them to west side of the Ohio River, laying waste the country, attacking other tribes etc.



THE OLDEST SPIRITUAL KNOWN OF CHRIST IN SE FRAS SEDE, ROMA; HIS SISTER THECLA WROTE THE ALEXANDRIAN CODEX AT THE BRITISH MUSEUM LONDON

PLATE 114



Գրիթի ծագը ընող է, ու ցրի կոխե հանող, և ո՛վ որ առնոյ
 Անճատոր կ'ըլլայ, իմաստուն չըլլա՛ր: [Գրքաբանաց, ԳԼ Ի. Թի 1]

FN YR ARGLWYDD YW DECHREUAD GWYBODAETH : OND
 FFYLIAD A DDIYSTYRANT DDOETHINEB AC ADDYSG. "LLYFR
 Y DIARHEBION. PENNOD I. 7. "WINE IS A MOCKER, STRONG

drink is raging: and whosoever is Plate 115. This bottle of baked Missouri, and the rays of equal red. It has the date of 2300, and Lyra & F. Tta, F. Mra & F. Att, F. Ava & Adam Creation. It is a in worship of the Great Spirit or water bottle, not wine, to be called Fa Oma Wa (God's Pyra- consists of two V's and reversed is represents God built Pyramid and V is a Greek N and this A of Adam and forced from Garden of turned upside down or fall from striped parts find on U. S. Flag and the third letter of Genesis of Holy point, a Pike, the Babylonish A & glish of Turkish name Allah=

Plate 116. A Monogrammic of arrow point, Fa, shaft, of I, J, Mound. Right hand Mound of the initial C of Christ and the and G=Γ, also arrow point, a godly Abel, of Cain that slew him, broken Commandments and life Cain who was drunken; and slew

Plate 117. He counts it back Ramanka Averaging 48 and a small ation who did not live to a very old

He counts ten Queens, Four nine very important Chieftans.

Agrippa Lucius Furnius Bahman Ferenes and that Spirit, ONE GOD, and Mounds. On his neck Pyramid; the dot, a son from the large circles on line language:— "Christ will come again in His "I will establish my cove- shall all flesh be cut off flood: neither shall there destroy the Earth. This nant which I make be-

every living creature that is with you, FOR PERPETUAL GENERATIONS: I do set my Bow in the cloud, and it shall be for a token of a covenant between me and the Earth."



PLATE 115



PLATE 116



Plate 117 Monogrammic of King Powhatan Count his generations

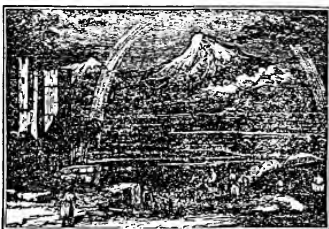

PLATE 118. RAINBOW ON PARAT

deceived thereby is not wise." clay was found in a mound at size are white, brown and bright names of F. Adr & F. Anm, F. Fnfr Mra & F. Atta: date from water bottle used for religious rites God the Holy One. The holy obtained from Pyramid Lake, then mid Lake Water) W at top letter M, the center inverted V a German V is an English F, the Hebrew language. After sin of Eden two VV represented them Pure God Commandments: also Stars points. In Ægyptian Bible, A is an inverted V, an arrow sword point: initial letter in En- God's name.

Bow And Arrow is a picture symbol H, F. Left hand the Serpent Antedeluvians: and remove string string is in form of Greek letter C pyramid, again initial letter of broken lines of Bow typical of line of Ava & Adam's son Abel by his Brother and went to Judgment. 67 generations to 37 F. Bunala & fraction of years, Suns, each gener- age due to warlike habits.

Great Chiefs or Kings and That he is a descendant of Marcus and Fna Chia and they worshiped the Great his Forefathers built Collar is picture of Lake of Great Spirit had come; Chest it states in cipher has come and gone and Great Glory." God said: -nant with you: neither any more by waters of a any more to be a flood to is the token of the cove- tween me and you and

American Indian on Creation of the World

BY FNA ATATAR WRITTEN

A FEW CHINESE SYMBOLS
ANCIENT

Y a n d(=)—Masculine of
Perfection, Heavenly, Light,
Warmth. Yin (=) —Fem-
inine of Imperfection, Terres-
trial, Darkness a n d C o l d.
Combination(=)===. Piety
(=)===. Morality(=)===.
Justice(=)===. Wisdom.

ÆGYPTIAN PRIMITIVE
—(=) Water, Earth, Death,
m, n, l(=) I, J, H, F,
Heaven, Honor, Uprightness,
Fa, or God. O=God. †=Lord



GENERATION 38 FNA ATATAR. PLATE 246.

LINES WRITINGS OF
CHINA.

Double combinations and signs
or symbols of remote, changing
of primitive line languages.
===(=) Heaven. ===(=)
Moisture. ===(=) Fire. ===
(=) Winds. ===(=) Waters.
≡≡(=) E a r t h. ≡≡(=)
Mountains. ≡≡(=) Thunder.

∞=Trinity. ∞=Theos. ∞=
Birth. ∞=Death, Earth, etc.

Plate 247



240



249



250



251



252



253



254



255



256



257



GREAT SPIRIT THE TRINITY CREATED
the Heavens and Earth, Woman and man like
unto God their Creator at Omo, Lake Pyramid
Land, Anonna and the creatures of earth and
waters, like for like in their sq. God had cre-

ated light for them man and woman he gave
dominion, 6 days of blessed labor 7th Worship
of Great Spirit, Fa F=Lord God of earth and
heaven. With God, trinity, Wo Man Kind, one
with God when Christ son of God comes then

united one in four, shall be they in Trinity God
be: HE the universal King in usity when pure
hearted like Theos a small part of mankind

thrown of the earthly and waters body to be
resurrected to God and eternity. For their
Tree of life shall bear fruit meet too Trinity ac-

ceptance, though bent of the straight line.
DEUS in centre of square, a Pyramid of ever-
lasting strength and beauty, one with four, the
stars lasteth 6ve points on the banner to be
U. S. A., with God protection, on four sides, at
Eden=Aden, Lake Pyramid Land, Omo=Oma,
Anonna, saved shall be by pure hearted in war
for God, Country, State, and Family, beareth
Sword. Lord one God Allah uniting the NA-
TIONS, Four Pyramids like unto into one
people THE EGG OF PROMISE OF GOD
to Ava and Adam, recorded at Adams Co., Ohio
to destroy the Serpent of Lust and Greed, evil
pierce and Serpent head crush by Roll, power of
Great Spirit. All primitive religion is purity.

THE SERPENT OF LUST, GREED, ALCO-
HOLICS VILE mankind destructive Evil over
munts the Erth Then trying in hypocrisy using
the name of God to mount the ladder to God
over God to aided by man Serpent Tail the X
to cheat God and of Hell capture Heaven I
Captured, pierced shall he be by Omnipotent
God of Land, Seas, Universe and all therein,
notwithstanding his Devilish bloated Mammoth
body striketh out to devour a vast expanse.

Even God the Superior Trinity that he the
DEVIL hath covered God, Truths, and a great
expanse of the Earth and waters with lines of
darkness and vile serpentine evil by bloody
slaughters of God's pure, even taken the fallen
E to use for innocent victims, whose bow string
is broken and anchor is fouled in their remains:
The Great Spirit seeing, Dieu goeth forth the
Omniscient, one with His Saints and conquereth
the lustful power attempting to hold from evil
even Christ and God in subjection whose pure
Deus saints shall walk over and build hill mounds
to cover his remains and the spark of purity that
remaineth in him shall go to God for judgment
and earthy part corrupt into mother earth for
purification that the Commandments and Laws
written by God and given to Noah and Ham,
Shem and Japeth are literally fulfilled on waters
and land as declared by God in the Mound land
of Omo. A powerful armament cometh up from
the Sea to destroy pure shall not prevail. I
GOD Trinity am a Fort and Fortification in the
land of Lake Pyramid, Omo at Annon, Omni-
present that guardeth my own and lay their foes
deep beneath the waters of the Sea and earth of
the Land, OMO, that I protect. Not idol worship

Plate 250



259



260



261



262



263



263



265



266



267



268



Great Spirit Prayer

GOD GREAT GLORIOUS WRITER, ENGRAVER OF TABLETS, SQUARES, ROLLS, BUILDER OF LAKE PYRAMID, MOUNTAIN, GIFT TO AVA, ADAM. PRAYER TAUGHT US!! OUR CREATOR PURE AND PERFECT OMNIPRESENT. We thank THEE for all THY Blessings, Gifts unto us who bow before and worship with thankful hearts for thy love and mercy and forgiveness of our sins evil serpentine committed that lowers us beneath the serpent that crawls on the earth, and praise thee for blessings making the line of C.S. the line of beauty, Christ Saviour thy promised son to be born of the long line of Ava and Adam by Mary and Joseph and KING of all thy perfect creation which even the turtle by drawing in his extremities doth honor THEE by forming the symbol LORD that Thou taught to Ava, Adam, created Thou them in thy glorious, bright image and taught them wisdom, honor, love, order, worship, to do blessed labor, record days of work, and praise thee on Holy, sacred Sabbath and knowledge of thy planets, Sun, Moon, Stars, thy wonderful gift of Light, Heat, graceful beauties for them and their inhabitants. and THOU the bountiful Giver of Christ, thy Son from thy love, to fall for them and that TRINITY IS JEHOVAH KING SUPREME OF KINGS AND UNIVERSAL CREATION, ON LAND AND WATERS, at the Pyramid Lake, of Oma = America, Oregon to be called, the Mound Land of TRINITY, EGG OF PROMISE CHRIST, THE MESSIAH.

WASHINGTON TO BE OF THIS THE FATHER EARTHLY AND SPIRITUAL OF HIS OMO the Mounds Land, the Wigwam Land of Nh., Hm., the Serpent Mound of AVA and ADAM A. OMO there first this prayer was given and praises; worship of the JEHOVAH by Fna Atatar; the first Nh. document, God gift; worshiped CREATOR OMNIPOTENT GOD OF LOVE AND RIGHTEOUS JUSTICE who here completed most perfect the Creation, giving song birds of praise before the Commandments. Tablets to our foreparents first that goeth forth to have Dominion over the whole earth to make honorable peaceable kind loving gifts to this world of Nh., Hm., Sm., Japeth, our foreparents from God, gift, blessing, obeying God even from the land of Gold spreading broadcast, pure, holy, gifts of love and common relationship to the Uttermost bounds of the Earth, that God here has so bountifully blessed us with, that they too may ever join US from God Made Pyramid O. with pure holy Praises, Worship, Songs, Deeds, Acts, Loving one another as God loves us, Forever and Eternity then God cometh, we pray to forgive us all our sins, and calleth us Home to live without evil in paradises celestial, in the enjoyment of most perfect bliss, giving Glory unto the SUPREME BEING GOD OMNIPOTENT, OMNISCENT, OMNIPRESENT GOD. BE THINE, GLORY, HONOR, PRAISE ETERNAL. AMEN!

ABOUT ONE OF SIX TRANSLATIONS

This Pharaoh Fna Atta is told further about on the right of the Center panel of Plate 113 where is pictured his coming here in vessel: the Indians he is the Chieftan of with Tree of Genealogy: the Pyramid of Egypt built after the Lake Pyramid, Oregon, U. S. A.: the faithful Dog watching pyramid gen. tree line: the Mounds of Antedeluvians and the GOLDEN SQUARES OF GOD'S COMMANDMENTS: the Ægle: Sun darkened time of Flood: the earth as it was pure: as it shall be again pure: the Garden of Eden etc. etc. Also see Plate 113 for much further true history that belongs to all mankind. Especially observe the Mariner Compasses in top center square. Ever it is to be remembered that the picture hieroglyphic symbols are the condensed stenographic writings of the celebrated wise Ægyptians whose wise comprehensive alphabet was the three symbols God gave to Ava and Adam which I here show modern descendants to meet the requirements of these later days: O Δ Ψ that are imperfectly represented in our English Alphabet as F. A. M. G. F. Adye writes on Ohio Mounds, Vontonville, Spencer Co. "One mound covers about three acres, is 20 feet high, and covered by about 12 inches soil on Corn Island, near Troy, under a layer of flat stone skulls of giant: larger than the whole head of man were found. 20 or 30 other mounds filled with large skeletons, relics of copper wedge, etc. Near Petersburg, Pike Co., Indiana, covering 4 acres at base, one at top: 70 feet high, were found immense sized skeletons, hatchets, arrows, etc. marking a race of giants, showing great antiquity. See Henry B. Dawson's Historical Magazine, Morrisana, New York

269



270



271



272



273



274



275



276



277



278



279



280



281



282



283



284



285



286



287



288



289



290



"A JUST WEIGHT AND BALANCE ARE THE LORD'S: ALL THE WEIGHTS THE LORD'S: ALL THE WEIGHTS OF THE BAG ARE HIS WORK." "BUY THE TRUTH AND SELL IT NOT: ALSO WISDOM, AND INSTRUCTION, AND UNDER- standing. Righteous lips are the that speaketh right." The full soul hungry soul every bitter thing is

The symbols on Plate 288 in the double round O the names of God the having been in visible person with a Noah and is leaving it: the two first Lake Pyramid, Oregon, etc.

Plate 289 is a Mexican ancient red hand at serpent Mound, drowning world: the Tree justice in rebuke for evil Bird the promise of Christ Creator God and the trunk is the primitive M and Nh. shape of Heb. terminal M.

Plate 290—A n i m a l men, also letter symbols: the Squares of God's Com-

Plate 291 is a scene Sculptors showing, not "a engravers at work for and Tablets Commands. Truths in History that Tablets are seen at top denoting Trinity and coming Christ at right tools for engraving and nating Ava and Adam separated, and Tablet tool he finishes of God: tail Ham. From now read Eden: right Omo, etc. have remains of mounds and ing traces of ants and migra-



Apamean Medal.
Plate 298

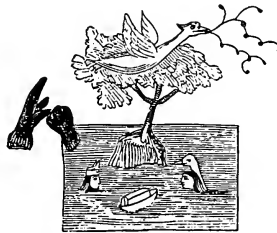

Plate 289. The Flood—Mexican



Monogrammic Plate 290 of Embalming



Plate 291

line primitive language pictures by the Father and God the Holy Spirit as Compass in the Ark with Nh=Noe= pyramids built after or copied from the

illustration of Flood, and the black and Adams Co.: the Ark and of Trinity in giving lawful deeds committed: the flying to Ava line promised by and three branches of Tree family: the water is in

head, traits of degenerated while above is represented mandments, etc.

from the Ægyptian Stone sandal cobbler," but skilled perpetuating the Squares of Deity and remote can never die. Five with three projections Egg of Promise of God's Square. At left long line tool design-line, two Squares not with his mouth and the seal name part line Noali, great Square Garden of the Mounds of Several nations the primitive pyramids show-early inhabit- tion.



Babylonish History

⊙=GOD, Trinity A and Ω=Ψ=∞ Establishes His Temple in Righteousness, Truth, Purity, Holiness, Love, Power, Might, Force, Ram, Church Militant Commanded to send forth all armed to fight the Foe to his destruction with his-spear and battering ram, mace, globe and sword, ax and spear, ⊙⊙ball and shot, horns and dart, with arrow and bow of God, as declared by the mouth of



PLATE 292 Babylon History

Anr that His arm shall shoot the arrow and from His darkened Altar pierce the Serpent lust that tempted mankind from the first of the world Adam to the last who have all sinned to God the Christ =C, to be born of Mary and Josef, Jews, the Tribe Christ singing of peace the pure Son of God, one with the Trinity one GOD FA: CHRIST slain by WINE Imbibers of mammon Serpent lust indulgers which seductive Satan has and will tempt the world till HE be overcome ceasing to then beguile sinful men and women which have rebelled against God and his holy teachings so far that one Church has, the Temple, Ruled over by Satan's the Devil's dominion, under two aided by the Scorpion over two Churches for money and the sinful man and woman have stained with Rivers of Blood, death and evil the name of God, the Holy Altar under which is the pit of destruction. A= >=Fa, the Babylonish name GOD whose High Priest Failed to destroy the Serpent that even there intertwines, enfolds his victims from even Godly Altars, built before Egypt. Tribes of Judah, Assyria, China, Confucius, Buddists, China, founded by Phut=Fut whose son Ching Hong, its name, that it was desired to disgrace by charging him with making Alcoholics from Rice: F. FUT= פוּט and ⊙⊙. The Egyptian, Assyrian spear point pierced, but did not reach the heart of the serpent Lust who defeated them from inherited evil; wine; thus fell Troy, Babylon, Greece, Egypt, Etruria, Rome, and under the sign of the Cross has not fallen the Serpent but overcame in the slaughter of 150,000,000 Protestants and Roman Catholic Martyrs that even the Crescent aided this aggressive slaughter: Although all these hath a part of God's Commandments and Laws of Life, joy, Paradise. That from all of these shall come the Pure Holy ONE Church of God: SWEET and pure is the musical songs of praise by the sacred Bird Blessed by our Creator as She stands on the monogramic universal SYMBOL of Creation that in front the honored faithful Dog Blessed by God guardeth them.



WITH FIDELITY NOT SURPASSED, BOUNDLESS COURAGE FACING THE FOES OF MANKIND THAT HE LOVES AND PROTECTS, UNCHANGEABLE, MUCH LIKE the Ægle who boldly looks at the Sun in its brightness typical of the glorious attributes of Christ and God who will gather all his children in loving care as the bird its young protecting with his powerful arm and strong hand, which will cast the spear and shoot the arrow that will pierce and kill the lustful Serpent, if he will work blessed labors trustingly, believing and obeying our Creator with his 170 names, all One God.

Genesis, chapter IX, enlarge Japeth and he shall and Canaan shall be his Mutenna, 24 generations son of Japeth and 36 from Menophthas son of Fna and brother of Fna Usakaf Ægypt after his brother Mounds, Omo. Proof:— Bible: Catouche Gen. 37 sculptured head, etc. On and right of Tablet which a matter of surprise that this announced for con- that are never idly spoken

These symbols on Plate name of God of day and Fanueil Tomb at Old monogrammic, and the X= God: the exploded worship toward the original pure Sun was taken to spell the Pyramid shape repre- Mexico, Ægypt and the

Plate 295

*Creators
from
Hiam Shabal
&
Sankara, Brooker.*

Plate 296

F=R * 

Plate 297

A-H 

Plate 298

M-Δ 



PLATE 293. GEN. 39. FNA MENOPHTHAS.



Mexican  for day, and  for heaven.
The Egyptian symbol for the latter is .

PLATE 294

in the land of Ægypt. The next represents Suns, Stars the nine pure of heaven and earth 5 plus four in flood, a son of the four watching armed incoming foes from the waters, a sarcophagus, tomb, Ark. Third symbol an emblem of earth, waters 4 boats, heavens above, five pointed Stars, etc.

Plates 295, 296, 297 and 298—These very interesting letters, symbols are a clearly defined bit of religious history to further establish the primitive religion of this planet: first name under the authority at head of this Alphabet Adm of heavens God and earth land pyramid and on right Heb. H, Ægyptian C for Christ: 3, the universal and v: Ψ 4, God's name B. C. Fa Fo: 5, "11, a lamp with flame from which the Ph: 6, an enlargement of aforesaid M and v elongated, names of earth planets, waters, Trinity, etc.

Plates 299, 300 and 301—One of the Primitive Alphabets in fourteen hieroglyphics is Fro, first O name of God, second represents pure Woman, 3rd son: 2nd two pyramids swords points, Greek, Delta, Ava.

verse 27th:—"God shall dwell in the tents of Shem: servant." His wife F n r from Dodanim son of Javan, Ava & Adm, married Fna Bunala and Fna Ramanka Gen. 38 had the Throne of went to the land of the Papyrus Prisse and the Holy and the Monogrammic Papyrus find facts on left are very clearly shown and they were not long before firming the words of God unto men.

294 represent Fa the ancient night, and the Seal on Peter Granary Cemetery is there 10 literally meaning One of the Sun is an advance worship of God when the name of Fa=God. The sends the pyramids of Omo, Altar built unto the Lord

Plate 299

 F-F

Plate 300

 F-U

Plate 301

 M-V

Plate 310

"Hamyaritic characters in hiero- of great Pyramid of Gizeh' in land of Lake Pyramid, O, at the and Japeth with wives, the remnant the great waters from Mississippi Adm line of Nh and Hm from ment line of Ancestors: forth went in the Boat, Ark or Ship over the Mount Araat where unto God Mound Land Omo over the sub- and over our Ship that moved was our Guide, Pilot, His Hand, glided into the safe Harbor of rest again lighted our ways with more THIS BEARETH "THE and Nh, Hm, Sm and wives. pletion of this Pyramid, III Ham Omo." The primitive alphabet is figures. A, at top and M the second points are Modern and the Plate

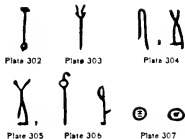

CHERAN-INDICOPLAGESTER.

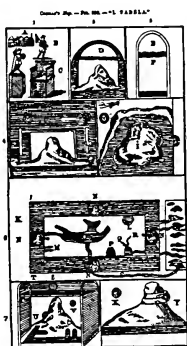

PLATE 308

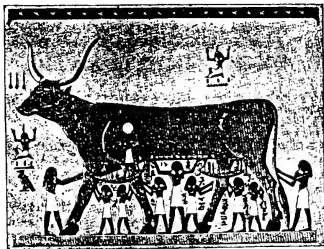

PLATE 309

ABBREVIATED TRUE DES-

"A, B, C, Inhabited Land of Noah. D, the Pyramid Lake, Land=△□□: Deus Tablet and

F, E, Tablets written by Fa=gon Lake Pyramid: Two Golden and God the Holy One, that here the Sun and Moon Light. I, The River, Mass. 2nd Rock back of Ocean where Mankind dwelt be-Eden. L, Gulf of Mexico. M, Euphrates, Hiddekil." N's points proclaim Truths. T, U, V, OMO drank and slew Abl that our Laws tice otherwise: Noah here became Land of Omo were Buried. Z,

overcome and Christ go Mounds. X, Y, and Z: doth see the attempt of to even capture Omo, and all therein by the censed evil to by its poi-year in U. S.

ica the Omo Land is il-stars on the under parts that was honored and American Ægle, waters, Trinity, one only God earth and all therein: tions are here warned coming foes. See His-

No. 310. Correct- this book.

glyphical inscriptions from interior "God the Creator of Ava and Adm Deluge, went with Nh, Hm, Sm of long line of womankind over gulf, M with Lamar of Ava and C(olorado) Adm and Ava monu- they from the Serpent Mound drowned world, God our Pilot, to guided Us, His long line from the merged world: Trinity was with safely onward to Araat. Trinity Voice, Compass, led as we gently and peace, the Sun and Moon light from darkness into Day. GREAT SEALS OF LA M R Dated 1656 was the Flood. Com=Oct., 1700, and this Day sail to sh own. F=the O at bottom symbol. The top three letters and 310 Mystery Plate. I add it.

CRIPITION of COSMAS MAP.

Omo=□□□, by descendants of Oregon, U. S. A., and Mounds Noah's Flood.

God. 4 & 5 OMO Land: Ore-Squares written by God the Father, first created two, Ava and Adam: inscription Rock at Dighton 1st J, Land, Omo, beyond the fore Deluge. K, the Garden of R, S, Q, Rivers "Pison, Gihon, of the Compass that Heralds shall Land, Pyramid Lake where Cain would hang. God meted out Jus-Drunk: Noah and Ham in this Man from God shall see those evils

to the Omo Land of the Trinity one God will, or the Triple Crown Man the Pyramid Lake Land Whiskey, alcoholic li-sons kill 300,000 per

Plate 309. Amer-lustrated by thirteen of the domestic Cow blessed by God: and the worshiping men of of the Heavens and that with all good Na-against your present and tory repeating itself.

ly solve for a present of

“**B**UT TO DO GOOD AND TO COMMUNICATE FORGET NOT: FOR WITH SUCH SACRIFICES GOD IS WELL PLEASED.” “EL QUE VUELVE MALES POR BIENES, NO SE APARTARA EL MAL DE SU CASA.” “LAS SUERTES SE METEN EN EL SENO, MAS EL SENOR DISPONE DE ELLAS.”

Plate 119 appears to have been covered by a mask, but not by any desire of the writer. Is it not the duty of twentieth century inhabitants of earth to remove all the masks of the 360 religions that have in each beauties and much purity a great blessing. Generation 54, 1022 before Christ, is a picture herald of his coming from the Lord, for all lines of earth, and waters, and 55 his union of wo man kind with Trinity, etc.

From Plate 113, 2nd date of 1010 B. C. Fnr Anannaah who Sufis, b. 1074; d. 1022 another rectangle is gauge says Christ man and woman Mary and Joseph, around the world land C: her right her heart, and left genealogy that is in of the long panel the Greek letter C, over the initial of the ship upon the his complete union kind, showing on lets and square gold- mand ements and mouth unto all the (shown in the tall copy from the small pyramid made by Spirit guardeth them thrown the green menced by Marcus Furnius and com- scendants; eleventh Bah man whose the Hebrew Bible their symbols of the both of which were Greeks.”



PLATE 119. Chelsea Photograph of Christ.

hieroglyphics declare:—“Christ, birdlike with the Commandments and Laws, the One of Trinity will be the Spiritual King of All the Earth, earth of God the Father and Holy One from which part Christ to come will bring Peace, Joy, Love unto the Rulers of mankind and to Universal Creation. As seven days is the week the 7th call Sunday for Trinity, Man, Woman and Children for the cycle of Ava and Adam the first man is completed in Holy, pure Christ of God united with them, spake the Lord sweetly like the music of the song bird to cheer Adam at Anon, where I built the Pyramid, and House in the garden for Ava and Adam, with pure sparkling (bottle of) waters for the line that God gave unto His Most Glorious Name for all the Earth and Waters with gift of Christ and the Primitive Alphabet written on the Rolls and Tablets supported by the Arms of Justice upright and Holy.”

rectangular part is with the name of was the wife of Fna and over Mound is a comet and its lan- shall come from God, with the initials of and that he shall sail even unto the golden hand is placed over points to the tree of right hand corner which forms with it and this tree roots Christ and below it waters sailing toward of Trinity with man- bottom row the tab- en of God's Com- Laws that He by inhabitants of Egypt Pyramid made by white inside, Anon God) whose faithful that forth will be Flag and tower com- Agrippa Lucius pleted by son de- generation, Chia & names are given in when translated in Egyptian languages co-existent with

The next four

”

SAID, O MY GOD, TAKE ME NOT AWAY IN THE MIDST OF MY DAYS: THY YEARS ARE THROUGHTOUT ALL GENERATIONS. OF OLD HAST THOU LAID THE FOUNDATIONS OF THE EARTH: AND THE HEAVENS ARE THE WORK OF THY HANDS."

—Psalms, chapter CII, verses 34 and 35.

No. 1 of Part 2 Plate 8 Page 114

תתתת תתתת תתתת תתתת
תתתת תתתת תתתת תתתת

תתתת תתתת תתתת תתתת

TOTYOTU POCUTION MACYACNON
ΘΕΟΤΑΡΖΑ... CIRC-CEDACIARON

APIANON... GECANTIOR
ΘΕΟΤΜΑΝΑ ΥΒΑ... GAC

”

”

”

”

”

PLATE 120

Plate 121—Bas-relief at Copan, Central statue delineated has Chia (Bureau of Eth-shows the primitive mode of worship, and mention her with The date of her death thereon.



PLATE 121. TOMB AT COPAN

See Prehistoric pages 571, 575; date which mentions the Fnr Chia's da Chia who had Zenobia, whose das. descendants were living in descendants in Arabia in 18th century. tioned. Said Zenobia Septima, Queen had Athenodorus Vaballathus who had bia was a very beautiful woman, and nese, Arabic and Latin Languages. She genealogy to Ava and Adam as per line Faraohs by primitive language. It is nobia's written genealogy by herself.

Plate 122—Valuable if not spu-is, or was, truthfully copied from

leif, East Side of Statue America. The first on it the name of Fnr nology). This Plate religion was here their the thirty six symbols much more history. May 6th, 230, is

World by E.A. Allen; upperleft hand corner, Newport Tower, R. I. m. Arab Chief Hucula Queen of Palmyra

Rome the 5th century, and her sons In Robbins' Journal the sons are men- of Palmyra, by her first husband Valabal three sons and three daughters. Zeno-conversant with Ægyptian, Syriac, Chi-was Queen of the East and wrote her through th e Ægyptian Pharaohs or he regretted that I cannot find Zeno-



PLATE 122

rious (?) Therefore is important, if it Ægypt. Errors cost more than truth.

“**S**O SHALL THE KNOWLEDGE OF WISDOM BE UNTO thy soul: when thou hast found it. Then

there shall be a reward, and thy expectation shall not be cut off.” Searching the archives of suppressed truths, attention was called unto the great Oceans, Rivers and Brooks with the Mountains, Mounds, Pyramids, Monuments of God:

This Plate 126 has new features that every school child should be familiar with. And right corner beareth the true history of Creation by Fnr Lamar the sinless wife of Noah and the ancient corner seal which with her name she affixed is the round O with lines on at Mt. Araat containeth the holy name Fa of Deity. At lower left hand corner is the grand almost indestructible stone Colorado, at Monument Park, hard formation that Genesis describes as containing the remote ancestry of all the living people of earth that exist to-day as the progenitors of all coming persons whose very names are told in the Decree of Cyrus the Great for about 800 years from the present era and the same may be seen on (pl.) Envelope attached to the Hancock Monument at old Granary Cemetery built by Massachusetts, Sovereign State of the United States of America, in form of the Sheathed Sword of C. Furnius the Martyred son of Marcus Agrippa Lucius Furnius a lawful descendant of C. Furni, father and son, Orators and Historians, B. C., whose orations and Histories disappeared during the turmoils that were said to have laid “250,000,000 of pure noble Christian

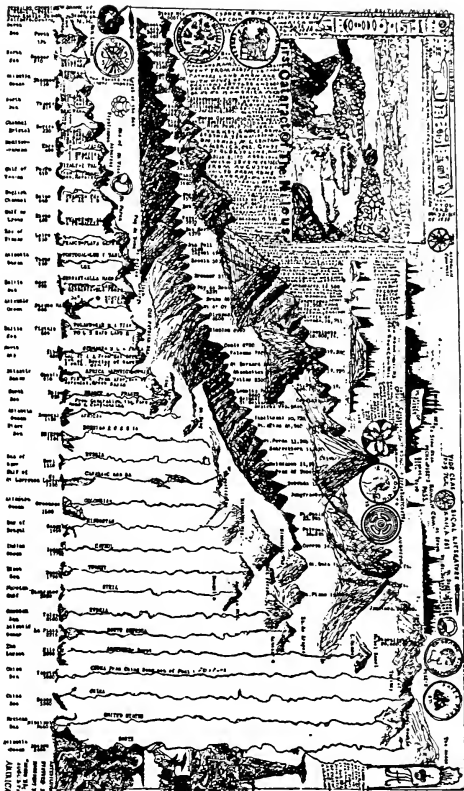

PLATE 125

Martyrs beneath the sod by fanatic anarchists that from much labor continued persecutions infinitely more than Christ suffered: have been reduced to 150,000,000 by the Churches of Roman Catholicism when in power: Protestantism when in power: Mohammedism when in power with the foolish boast that the seeds of the Church are its Martyrs. In primitive religion all worshipped God and no martyrs nor blood sacrifices: why not turn to it? Herein is given the key! The primitive God given religion!!

OR THOU SHALT HEAP COALS OF FIRE UPON HIS HEAD AND THE LORD SHALL REWARD THEE." "Remove not the old Landmark: and enter not into the Fields of the Fatherless: for their Redeemer is mighty; He shall plead their cause with Thee."



Plate 126 is a Stag Horn from Lake Neuchâtel, of Fa Fo name, 20 In. in length, used in worship of God the Holy ONE.

Plate 125—Right hand upper corner is the coat of arms drawn from sword of gift by General George Washington to cousin Captain Tobias Fernald. It hath the ancient Persian crown crest with the Rattle Snake, used on Flag in American Revolution. The Fire Altar and name of God, the Shepherd Staffs or Crooks refer to Faraohs or kings of Egypt, when they reigned. Coming to the lower left hand corner, find recorded the musical Rattle Snake Brook named from preceding: it is 4 miles long and its outlet is beautiful Lake Wentworth, at Fernald's Crossing, Wolfboro Center, New Hampshire. Near this brook is drawn the Rattler and ancient C. Furni sword, typical, and at right a Roman Mariner Compass. Above this the Historic Roman Line Coin. (see Plate 594) Then First Nilus (attract. Right upper corner, an Assyrian Compass. Top right half, is a Roman Compass. A pike head points to the Pike family historic ring and Coin of Kaisa PEAC same PIKE family: he raised higher than the mountains is emblematic of return of his spirit to God, whose justice trials are more perfect than refined GOLD.

The coin of Augustus appointed of God shows his Furnus descent. The Fish Compass on Saucer at Berlin Museum IS THAT OF HAM & NOAH USED ON ARK FROM MISSISSIPPI RIVER TO MT. ARAAT.

Plate 127—The Iron Grave Tablet with features photograph of John Fernald S. Service Am. Rev., & wife Mary Savage, and Colonel Tobias Fernald with Abraham Fernald. It is believed to be the one, with records given by John Fernald to a Boston Society another of his family on which was recorded the death of John Fernald, that beareth his Crest, the high Roman Crown that his forefather, Charles

VIII, King of France, was crowned with; and paid a ransom to Pope Alexander the Sixth for Zizim, who disputed with Brother Bajazet for throne of Mohammed II. See copy of letter sent to Pope, page 173.

Pl. 128. The "Papyrus Prisse" at Paris Nation al Library which is a magazine of Important Historic Genealogical and Religious data, Facts and Truths that may or may not have been known to Cyrus the Great, whose Decree when translated into the primitive Egyptian language gives every name of his ancestry and descendants to A. D. about 2700 and ends. Two generations born since 1877 have the names declared in said Decree.

The Primitive Languages in Papyrus Prisse officially signed by the writers, Fur Afr and her lawful husband, Fna Ramfarka, Generation Number 31, 1900 B. C. The gene-dozy facts are on Marble Stone, decree of Cyrus the Great, and with chronology set correctly forth.



PLATE 127. FERNALD IRON GRAVE TABLET.

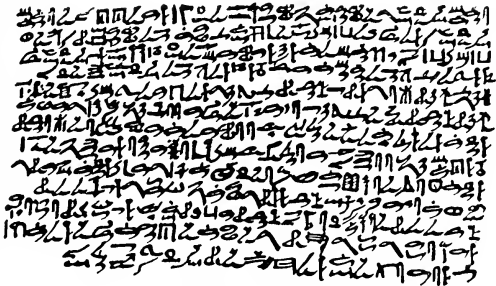

PLATE 128 ANOTHER PROOF



“**E**VEN THE PROPHET JEREMIAH SAID, A-MEN: THE LORD DO SO: JEREMIAH, CHAP. 28, V. 6.” TRANSLATION:—“ONE THOUSAND Nine Hundred Years Before Christ wrote Fnr Afr and Fna Ramfarka under and above our Seals for the Glory of God who commandeth daughters and sons to write off his written Rolls for Ava & Adam: We write for our children, daughter Fnr Tatar da. Noa, son F. Nabka and F. Af Anr: and our son Fna Huni, copyists off Roll of God and writers of Anona long line of God: In the Pyramid land of Ægypt from God built Pyramid over the long waters at Omo Lake Oregon Anm copied in Altar built hereunto God a long way off from Serpent Mound of Oma land where the sun first shone on God created Woman and Man that was built by F. Adam, St, Cain and Godly Abl as wrote F. Saio forefathers of Afr and Ramanka that wrote the promise of the coming of Christ, promise of God of heaven, the Trinity Lord God, gave to Ava and Adam, as wrote Zana daughter Cain and wife of Abl, and his daughter Sana, who married St, who had the God gift of Laws and Commandments, writings of God gift to Ava and Adm. Sana and Zana wrote the record of Cain that was drunken from wine he made and killed Abl that was Godly: that Cain married Ka Na Fata Far his twin sister: mother of Zana: St studied the Stars: God said, A Star of Heaven will show the coming of Christ to be one, with Wo Man Kind the 4th—with Trinity: to be ONE CHRIST line of God Spiritual Commander of the Earth and Waters: all therein and on of which FO should be Lord 1366 from creation of Ava and Adm: as I God made, wrote engraved on the Rolls, two Golden Squares, Tablets whereon are my Commandments, Laws, Instructions for Wo Man and Man and of men to obey, do, by the line of beauty, separate, unite upright, pure, holy for I am thy Creator God to be honored, worshiped, loved singly, but in one, is before Christ arrives, God the Father and God the Holy One, that is one Omnipotent, Omniscient, Omnipresent, Lord God of Ava and Adm that I created in Oma and is Omo land of Lake Pyramid I built which shall be called America that thou camest from the Land of the Serpent Mound that was built by Ava and Adm, Cain Ka Na Fa Ta Far, Abl and Zana, St and Sana: 8 (see fig. 8 on Dighton Rock) write, cut, engrave, chisel this on stones, metal, Silver, Gold for Adm's lion sins I turned you from the garden of Eden= Adam: For Cain murder of Abl: Cain thou shalt be a servant of and thy children servants despised by all generations saith the Lord a spot I put upon you thy guilt is alcoholic accursed Satan's weapon evil ways you willfully embraceth—and my Holy square commandments Laws you shall not or families own or destroy: thou shalt be a marked line for the ages but enlarge and become a head of the power of Evil in the world I will by flood destroy in its height and diseases for man shall surely die as I decreed but as you killed Abl after birth of Zana I will not hold that line to punishment but when yours and others sin the wicked shall be drowned by waters and one family remanent I will save to people the world anew: this I do for the sake of pure Ava that disdained to listen to the lionlike venomous serpent that diseaseth, drunkeneth and killeth, like Cain his brother Abl, venom serpentine even to the fall that will try to bring into darkness even Ynm=Anm=Anamim and Adar, Mizraim and Lazar after their foreparents St and Sana: Mizraim was pure, I God giveth unto him and his line the Golden Square Commandments and Laws: Anm went forth from foreparents the line of beauty Ava and Adm that I united in Cain and Abel line Anm line your parents Saio and Anos, Nasata and Cainan, Lalor and Mahalalal the upright that keepeth my Commandments, Santa and Fa—



“**K**ADA, SARA FANA AND ENOCH, THE LONG LINE FROM PYRAMID LAKE AND SERPENT MOUND, OMO ACROSS THE SEA WATERS, where I the LORD GOD brought safely Noah and Family from Omo to Mt. Araat from the Bay of the long River, that shall be called, Mississippi; NOAH AND FAMILY which I brought with Sea Compass to the land of AGIPT where

I told Noah Family to build an Altar a pyramid unto me the LORD GOD and gave compass in Centre my Eye to Noah Family (See Saucer Plate No. 26 at Berlin Museum) I saved from deluge Lamar & Noah, Anr & Ham, F Talimar & Japeth, F Rabakar & Shem: These the hand of God saved from the land of Omo, the Pyramid Lake line Anon, the Serpent Mound land that their seed people the earth and commandeth, keep my Commandments and Laws descendants of Salah and Matoslah, Ladar & Lamak, seed of Lamah & Noah=Nh long line that begetteth all the inhabitants of the Earth till I thy God cometh to gather Thee into my Hand for my Heavenly Mansions that endureth time everlasting.” Here endeth the 2nd line a part of the careful true reading for all (see 2nd Edition, also part of 8 & 9 hieratic symbols of 3d by count to right and last symbol of third line with two c, a, between.

3. “Pure holy Commandments, Laws of Ava - Adm, Nh, Hm, (spelt here as in Heb.) F. Mizraim, to all the long line: I the LORD give to generations of men, begetters of Christ the pure, every people under the sun my, (God’s) children to Wisdom truth unto Wo Man Kind seed, keep, write, record this and I God will protect it and naught shall prevail against me: my power is supreme and the son seed of M. A. L. F. shall proclaim me and it out of Egypt in the land of Annona, Omo, Mounds, My built Pyramid land in lake waters where the people liveth: there raging deadly wine lust for women pure that upright three men begetteth in a consolidated line of beauty, Lord’s and God’s line in U. S. that the Sun first shone on and chose the line to make in aggregation for heavens line of beauty, God’s Universal People are united with Trinity by Christ, begot by Joseph and Mary Christ complete union of 4th. Earthly parents Mary Joseph, b. Christ¹, Thecla², Anr³, Sarah⁴, Mary⁵, Lucy⁶. Sons were: James⁷, Joses⁸, Juda⁹, Simeon¹⁰, John¹¹, beloved of God, the long line of Noah, see, and it is good, the Lake Pyramid, and records, even of Christ in Rock, Tower, Arch, Temple of Chia & Bahman.” (Thus endeth 3d and commenceth 4th line.) (Read from Left to RIGHT.) “Nothing is concealed but it shall be revealed by the Lord unto all the people of God. Even the thoughts in the inhabited worlds of planets: that in this here the long line from Noah after flood: Ava & Adam before, the begetters, as the Lord told me to record on panel, (pictures as four sides, now read back to it), as Falafar and Afosis (=Apophis=Apofes=Apophes, etc.), Lara and Bianchas, Farada and Mars, Rachar and Mantha, Hanar and Hasaftr, Fnf Mra and Atta, Mrai and Att, Lyra and Tta, (return, read gen. 21.) Fora and Butan, Rafa and Kaka, Rafar and Bainuter, Naomi and Utnas, Muta and Santa, Arta and Tata, Af Anar and Nabka, Maron and Sabas, Aloa and Tata II, Falamar and Satos, the Lords great Afr and Ramfarka, Tatar and Huni, Tatar and Sanafra, Mathar and Khufu, Fammr and Ratataf, Malona and Rashaf, Bunala and Ramanka, and over Sea pyramid first built line copied, where the Golden Square, Marion and Usakaf, Marifu and Rasahu, Farna and Ramisar, (see Catouche gen. 38) the Lord’s Oma line of Musar and Harmanka, Francasa and Ratafka, Hulda and Mnas, Fnr Funar and Tata III, and with line projecting tail in Egypt head and Body at Annona, (Taunton River, Dighton Rock. Thus endeth the fourth line on the right. Fifth line Gen. 45 commenceth on left to right.) Farna and Ramasi, Fafur and Mananra, Frna and Tyrour, Lnar and Satas, Batha and Nafakara, Bithia and Nabkth, (See Catouche, Gen. 49), Noanah and Hana.



"The sovereign ability consists in knowing thoroughly the value of things."



PLATE 311

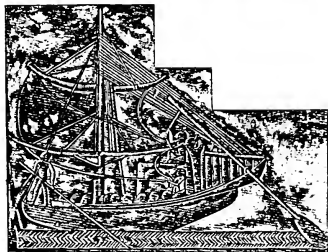

PLATE 314



PLATE 312



PLATE 313

Plate 311—The Pyramids of Ægypt were copied from Lake Pyramid in Oregon, United States of America.

Plate 312—The Old Man of the White Mountains, New Hampshire, was honored by the Indians as the sacred work of God.

Plate 313—Ossipee, Indian Mound, near Lovel's Brook in New Hampshire.

Plate 314—An Ægyptian vessel of great swiftness. Its lines of construction are alleged to be in use to-day among the builders of fast sailing yachts. Phoenicians were the descendants of the Ægyptians and a strong hardy just people.



"CUSTOM IS THE PLAGUE OF WISE MEN, AND THE IDOL OF FOOLS."

—Eng. Theop.

"Most men judge according to their interests, and abound in their own sense. Let two be of a contrary opinion, yet each presume to have right on his side. But reason has always been faithful, and never had two faces."

—Gratian

"The omission of good is the commission of evil."

"The true spirit of religion cheers and calms the soul. It is not the business of virtue to extirpate the affections of the mind, but to regulate them."

"Any sin committed in jest, is greater than when it is done in earnest."

"As antiquity cannot privilege a mistake, so novelty cannot prejudice one."

—Sir T. P. Blount

"Judges ought to be more learned than witty, more reverent than plausible, and more advised than confident. Above all things, integrity is their portion and proper virtue."

—Lord Bacon

"The truly religious person tolerates the honest belief, worship, of all others, in truth."

"The principal point of wisdom is, to know how to value things as they deserve. There is nothing in the world worth being a knave for."

In this Egyptian Pyramid of "Gizeh" was a Record by the Family of Noah and Seals. BUILT at WASHINGTON a wireless telegraph 800 feet high with a heroic bust of the lawful ruler of every nation known. Line busts of 169 generations of our universal forefathers honoring.

* * *

Plate 317.
Generation XLI. Ferna=
Fna Rameses
III taken from
his Tomb at
Thebes: He was
son of Ramisar
II and brother of
Fna Harmanka.
The workman-
ship is mono-
grammic: sails
embroidered in
many colors:
Fra's Vessels.



No. 404.

Boats with embroidered sails of many colors.

PLATE 317

PLATE VII.

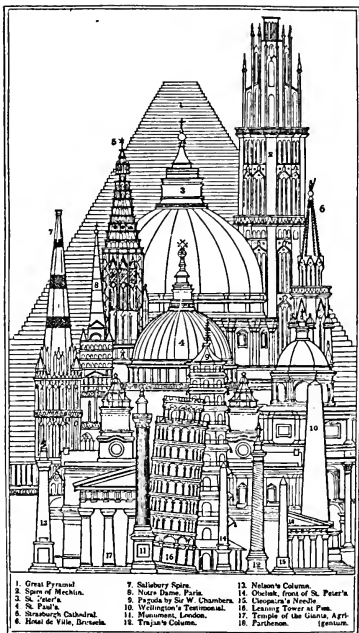

- | | | |
|------------------------------|-------------------------------|--------------------------------------|
| 1. Great Pyramid | 7. Salisbury Spire. | 13. Nelson's Column. |
| 2. Spire of Mecklin. | 8. Notre Dame, Paris. | 14. Obelisk, front of St. Peter's. |
| 3. St. Peter's. | 9. Fane by Sir W. Chambers. | 15. Cleopatra's Needle. |
| 4. St. Paul's. | 10. Wellington's Testimonial. | 16. Leaning Tower at Pisa. |
| 5. Strasbourg Cathedral. | 11. Monument, London. | 17. Temple of the Urania, Agrigento. |
| 6. Hotel de Ville, Brussels. | 12. Trajan's Column. | 18. Parthenon. |

PLATE 316. The comparison of Churches, Temples and Pyramid.

THERE IS ONE GOD AND FATHER OF ALL, WHO IS ABOVE ALL, AND THROUGH ALL, AND IN YOU ALL.

The Lord's Prayer in Micb Mac Indian and German Languages

TRANSLATED INTO ENGLISH:

OUR FATHER which art in heaven, Hallowed be thy name. Thy kingdom come. Thy will be done in earth as it is in heaven. Give us this day our daily bread. And forgive us our debts as we forgive our debtors. And lead us not into temptation, but deliver us from evil: FOR THINE IS THE KINGDOM, AND THE POWER, AND THE GLORY FOREVER.

AMEN.

This is a copy from the excellent book of Prof. CARL FAULMAN: 1880.

It is interesting to note a pleasant surprise in the Micb Mac Indian hieroglyphic Canadian language the kept with only a slight changed primitive Alphabet.

Plate 319 is the ruins of a Temple. It was built to worship the Universal one GOD who was known in primitive language as FA, the

numerous F's designates the Father of all who gave their names Fir and Fna that signifies we are line created of and from, by God. Plate 320 is a valuable RING found by excavating a garden in Etruria, sold to a Florence Museum that became poor and sold it to the honorable and most reputable gentleman that writer purchased it from. It is monogrammic and the Pyramid like projections and hieroglyphics when arranged in sequence as the line language gives the

Genealogy of Christ without the apparent discrepancy as is found in the Holy Hebrew Language of both Old and New Testaments. It says on it count the pyramids 5, and my ancestor's name was Achim, count his 1, Azor, 2, Abiud, 4, Amon: 2, Achaz: =Asa: 1, Abia: 3, Aminadab: Aram: 5, The Great Abraham: 7, Arphaxad: 9, ANFS=Enos=Anos. Egyptian, O Δ - O S: 2, AVA and ADM who were created by God the Father and God the Holy One. 2nd line Reading: by God created.

⊙ Δ Ψ. The Primitive Alphabet, F. A. M, is pre-eminently religious: Every Symbol is the ancient name of God, the Father in 1st Trinity in each of second and third monogrammic beautiful symbols, which was given by GOD to Ava and Adam in the garden of Eden. From these curved and straight lines all Alphabets of the Earth.

SCHRIFT DER MIKMAK-INDIANER.

⊙	⊙	⊙	⊙	⊙	⊙	⊙	⊙	⊙	⊙
Nusinen	wayok	ebin	tsiptuk	delwidzin	megwidemek	wayok	n'telidanen		
Unser Vater im Himmel sitzend es woge dein Name sein geschlecht im Himmel, uns									
⊙	⊙	⊙	⊙	⊙	⊙	⊙	⊙	⊙	⊙
tsiptuk	ignemwiek	ula	nemulek	uleditsinen.	Natel	wayok	deli	skeduk	
moge geschicht sein dich zu sehen unauftaltan. Durt im Himmel sie dir gehorcht seart									
⊙	⊙	⊙	⊙	⊙	⊙	⊙	⊙	⊙	⊙
tsiptuk	deli	skedulek	makinigwek	eimek.	Delamukubeniwal	esemigwel			
moge so dir gehorcht searten auf Erden soo wir sind. Wie da uns gegeben hat in dieser Art									
⊙	⊙	⊙	⊙	⊙	⊙	⊙	⊙	⊙	⊙
apš	negweš	kiskuk	delamukies	penegwunenwu	nilunen.	Delyabikšitakašik			
so auch nun heute gib uns unsere Nahrung uns. Wir vorgebeud jessen									
⊙	⊙	⊙	⊙	⊙	⊙	⊙	⊙	⊙	⊙
wegaivamemetnik	elp	pel	niskam	abikšitwin	elweulik	Melkeninroš			
so haben bešeigt uns, so du o Gott oergib unsere Fehler. Halte uns fest									
⊙	⊙	⊙	⊙	⊙	⊙	⊙	⊙	⊙	⊙
winnšudil	mu	k'igalina	kedzinukamke	winnšigwel	twaktwin.	N'deliet.			
bei der Hand nicht zu fallen, halte fern von uns Leiden, Obel. Amen.									

11
PLATE 318



PLATE 320



PLATE 319



The Egyptian Primitive name of F. Anos truthfully translated. The designation of the names by A was to honor each of them

Universal International Genealogical Tablet

IT WAS CALLED MOABITE STONE

A NEW OLD TRANSLATION.

“AVA, ADAM, OF TRINITY Created: Kanafatafa & Cain, Twins; Abl, b.they for continuation of the long line for earth and waters: Cain m. Kanafatafa: Had Zana, the writer of Sacred Annals with Abel that she married and had Sana, m. St. of the long line, had Cainan, m. Nasata, d a. Stalr a n d Masui, Had : Mhllal, m. Lalar da. Fna & Mri. da. Fna & Far, da. Anos and Saio : Had F.Frd, m. Santa, da. Maris, s. Das, s. Tassa, s. St and Sana: Had: Hnak= Enoch m. Sara, da. St & Sana; of Ava & Adam.” Here endeth the first line, left to right. It mentioned the “long line 12 times” part as repetition I do not continue repeating

THE SECOND LINE : Enoch & Sara Had: Mtoslh, m. F. Salah, da. St & Sana, da. Zana & Abl, da. Cain: Had : Lmk=Lamech, m. Ladar, da. Anos & Saio he s.St bro. Abl, Cain, Canafatafa, children or seed of Ava & Adm of God: Had: Nh m. Lamr, Golden Squares and here on right endeth the second line. And then commenceth the 3rd on left to right where F. Mars m. in Pyramid Lake Land, Fnr. Fardar, da. adopted from the land of Omo, she of the longest upright line son of Noah Hm, of Sm, of Jpith, Atta's son At's da. of Second Family, ancestor of the Oneida Tribe of Second Family in Oma, Had: Bianches, m. Lara, da. Hasaft and Hanor (here as elsewhere often is found the a changed to o), Had: Fna Afosis=Afosis, translated by Greeks Apophis, the giant that had an immense family: one authority said 60 chn. And in the first of these two families of the Five Natidns from Noah was found the first name of Washington and spelt Vashatana and in above “Moabite Phœnician Stone it is spelt Wshinton and that has the G. G.=Washington. Afosis, m. F. Falafar da. F. Mars and F. Fardar, Had Son F. Butan m. F. Fora, da. Mgs and Fardar: Had: Kaka, m. Rafa, da. F. Far and F. Rana, s. Bianchas and Lara: Had Bainutar, m. Rafar, da. Fah and Rala, s. Bianchas and Lara: Had da. Sara m. Abram and son Utmas, m. Noami da, F. Afosis and Falafa: Had: F. Santa, m. Muto, da. of great Afosis and Falafar, Had: Tata and they went forth to the Land of Omo=Oma and here as in Genesis it is spelt America, the land of Zana where she wrote annals of God across the Great Ocean, they went with Compass and returned from this first Inhabited land bringing many Inhabitants.



a, b, c, d, e, Lines showing two fractures.

PLATE 321

1 da. Mtsfsh & Salah, Had: Hm, 2 Sm, Japeth, were in the Flood 3 of Waters and piloted by God 4 the Creator.....dots 10th 5 Generations to Mt. Araat.... 6 sons...G o d Trinity....Saved 7 son G o d line & Cain the 8 Kanafatafa line, Lamr wrote: 9 Anr, da. Saio & Anos: m. 10 Hm, Had: Mzrom=Miz- 11 raim: Laza, da. Mtsfsh=Me- 12 thuselah and of son="dot 13 long line of Ava and Adm, 14 Cain and Abl, Canafatafa and 15 Zana, Sana and St, Mizraim 16 and Laza Had: Ynm=Ana- 17 mim m. Adr, da. Maf o=son 18 Hm, Adr and Ynm=Anm 19 Had Tta m. Lyra, da. Hm 20 and Adr: Tta and Lyra had 21 son of earth Att, m. Mrai da. 22 Fna Mizraim and Laza, Had: 23 Atta, who was with his father 24 a Free Mason, line to Nh and 25 Hm and mother Lamr, m. 26 Mra, da. F. Mah and F. 27 Mri, son of Mizraim, and da. 28 of Tta. Atta m. Fnr Mra 29 and had F. Hasaft m. F. 30 Hanah, da. F. Mizraim and 31 Laza Had: Mantha, m. F. 32 Racha, da. Atta and Mri, s. 33 and da. F. Anm, son of Att: 34 Had: F. Mars, who went with his Father and a compass to Anana, Zana Land of Noah over the Ocean where Zeus=God engraved the

WHO BROUGHT WITH THEM THE GOLDEN SQUARE GIFT OF GOD COMMANDMENTS: LAWS: ANNALS, SACRED GOD WRITTEN ROLLS: ZANA AND SANA'S WRITINGS WITH THOSE FROM AVA AND ADAM. HERE ENDETH

3. (Commenceth 4 line) Gani=Generation 26th. Arta, da Afosis and Falafa, m. Tata, son of Santa, Had: Nabka, m. Af An Ar, da Kaka and Rafa, Had Sabas, m. Maron, da. Vana and Afa, son of F. Kaka. Had: Tata, m. Aloa, da. Ramaf and Ala, s. Utnas and Naomi: Had: Satos, m. Falamar, da. Almo=Alma, s. Tata and Arta; Had: son, Ramfarka, m. Afr, da. F. Mar s. Santa and Muto: Had: Huni, m. F. Tatar, da. Noa, s. Nabka and Af Anr=Af An Ar: Had: Sanafra, m. Fata, da. F. Noa, s. Nabka and Af Anr. Had: Khufu, m. Mathar, da. Mnā, s. Sabas and Maron; Had: Ratataf, m. Fammr, da. Fafar and s. Huni and Tatar; Had: Rashaf, m. Marlona, da. Fna, s. Huni and Tata: Had: Ramanka, m. Bunala, da. Fna, son. Khufu and Matha. (Endeth 4 and commenceth 5th line.)

TRINITY blesseth these women: Had Usakaf, m. Marion, da. F. Sanafra and Fata; Had: Rasahu, m. Marrifu, da. F. Marlan, s. F. Khufu; Had: Ramisar, m. Farna, da. Rashaf and son of Ramanka and Bunala: Had: Harmanka, m. Musar, da. Ramanka s. Marrifu and Rasahu and these generations were from their forefathers great Mariners going to and fro with their families to the land of Zana, Ava and Adm Land where Trinity Blessed His creation: Had: F. Ratafka, m. Francasa da. Usakaf and Marion; Had: Mnas, m. Hulda, da. Rashu, s. F. Rasahu and Marrifu; Had: Tata and $\text{O}\text{N}-\text{A}\text{S}=\text{O}\text{A}\text{M}\text{L}\text{O}=\text{Fanius}=\text{Janius}=\text{O}\text{Q}\text{P}$ and $\text{P}=\text{P}$ Founded Italy, Peru: Peru founded Japan: Tata III m. Funar, da. Ramisar and Farna; Had: Ramasi, m. Farna, da. F. Harmanka and Musar; Had: Mananra, m. Fafur, da. Raratka and Francasa: This Mananra=Mann Ra Founded Germany. Here endeth (6th. line) Mananra and Fafur had F.=I. TYROUS, m. Frna, da. Mnas and Hafr, s. Mnas and Hulda; Had: Satas, m. Lnar, da. Fata and Mara, s. Tata and Funar: Had: Nafakara, m. Batha da. Farna and Fura, s. F. Tyrous and Fnr; Had: Nabkth, m. Bithia, da. F. Tyrous s. F. Mananra and Fafur: Had: Hana: Nabkth was a great Fra, worshiped God the Trinity, a mariner, built Temples in Ægypt and Omo the Mound Land, God showered great blessings upon this numerous and godly family: He and wife Bithia Had F. Hana, m. F. Noanah, da. Tyrous, son F. Satas and F. Lana, Had: Ramankhfa, m. Mahataval, da. Vafra, s. Nafakara and F. Batha. They were mighty in the Land=Had: Anm II, m. Hazzalal, da. Vafra and son Nafakara and F. Batha, Had: Sufis, Anm III, Yatatonwatea b. 1071 B. C. at Oma, Mariner, Indian Chief, Compass (shown here and on Catouche Gen. 53 he was b. Dec.=Anm 23rd: see Schoolcraft's U. S. Government pub. p. 634, Affairs of Indians) He died 829 B. C. Recorded in Genesis 61, buried in Mound of Serpent, Adams Co., Ohio: his son Oratota I was a Mariner, upright and great in Anona, Zana Land: Endeth 6th line and 7th. Son F. Sufis, m. Anannaah, da. A. C. Funis, s. F. Satas and F. Lnar, Had: F. Mizraim, m. Aaglah, da. A. C. Furnius, s. F. Nabkth and F. Bithia: Had: Fna Shishark m. Halarh and da. Hano, b. month May 3rd, m. King Solomon, s. King David, born of Bath Shua, da. Ammiel, (Chron. 3, verse 5.) (See pl. 113, Gold sent to King Solomon formed an alliance and m. his da. Anhury: Acts 28: verse 13 Records the Mariner Compass and Chinese Compass dated 1010 B. C. with names of King Solomon and Hiram of Tyre and numbers 1 to 24, etc. Daedalus and his Nephew made Chip Ax, Saw, Wimble, Perpendicular, Compass, Turning Lathe, Glue and Potters' Wheel, and his father Eupalamus the Anchor: In Chronology of Sir Isaac Newton, page 148, it claims incorrectly those as inventions presumably from incorrect translations. John Jackson in the Chronological Antiquities, 1752 A. D., Printed in London, Vol. 2, pages 436 and 437, declares "Huanm Ti, which name signifies Great Emperor, invented a compass 2438 which showed the four cardinal points of the Heavens, pages 472 and 473 p., Ching Yong began his reign, 1096 B. C. About this time a Magnetic Index pointing North and South, like the Mariner Compass was known in China. Chen Kong presented the Ambassador of the King of Cochinchina, China, one of them to direct them better in their way home. This instrument was called Chinan: Ægyptian name is $\text{I}-\Delta$, a pretty good illustration of it that is drawn on Catouche Generation 18 and 2422 B. C. and on Fnr Lamr's History of Creation with which we may wisely dismiss Compass to its good use. (GK Δ delta and $\text{v}=\text{N}=\text{E}$ gyptian $\text{A}=\text{A}$.)



FNA SHISHARK, M. HALARH, DA. FANA, S. F. HANA AND F. NOANAH: HAD TACHNATIS, M. BARU, DA. FOHI, S. F. ANM. AND F. HAZZALAL: HAD: FNA BOCCHAIS, M. F. ARLINA, DA. F. MIZRAIM AND F. AAGLAHA: HAD: FNA Osarkon, m. Fnr. Riua, da. F. Anm, s. F. Anm and F. Farna: Had: SiHasi, m. F. Saraho, da. F. Shishark and s. F. Shishark and F. Halarh: Had: F. Orsakon, m. Fnr Vashatana, da. Nasa, s. F. Tachnatis and F. Baru: Had: Namrut. Records in Egyptian Showeth the burial of Ataton, and on the ancient Tomb is found Ohratota, former 829 B. C., latter, the name spelt backwards, as Atotarho (See Schoolcraft's Government Work on Ethnology, page 638, volume 1855. The sixth family invades the fifth Nation at Omo. Also this Genealogical Stone essentially the same. Fna Namrut (aforesaid), m. Arkona, da. F. Boccharis and F. Arlina of long line: Had: Takalut, and son Oratota, b. 828, d. 777 B. C. 5 Sept. he went by boat to Annona, Pyramid Land across Ocean. F. Takalut, m. F. Mutta, da. F. Boccharis and F. Arlina: Had: F. Shamkon, m. F. Camilla, da. Karla, s. F. Osarkon and F. Riua, and went across the Ocean to Anona, Omo. Endeth 7th and beginneth 8th line of "Afa and Adm whose son united long line of da. and son F. Shamkon and wife Had F. Ramsass, m. F. Mullah, da. F. SiHasi and F. Saraho, s. Tubal Cain: Had: F. Zo=So (spelled both ways in Holy Bible) m. Fnar Noara, da. Hafana, s. F. Namrut and F. Arkona: Had F. Samiticus, m. Fna Zara, da. Nahi, s. F. Takalut and F. Mutta: Had: F. Nachro, m. Fnar Saio, da. Faconr, s. F. Shamkon and F. Camilla: Had: Fna Sammis, m. F. Srta, da. Samal, s. F. Ramsass and F. Mullah; Had: F. Afras, (Apris) m. Thala, da. Alasandra, s. F. Nachro and F. Saio; Had: Niatatis, da. F. Afras and F. Thala, m. (9th line) F. Cambyssas; Had: FNA CYRUS, m. F. ANAR MANDANE, da. Cyaxaras II who was Darius the Mede, s. Astyages; (Vide Generation 72 for facts) Had: FNA ATTOSAR, da. F. CYRUS the Great King, son of F. Cambyssas and F. Niatatis, m. Fna Darius, s. Hystaspes; Had: F. Arta Ba Zanas, m. F. Amastris, da. Ono=Fnf Fas=Phas=Otanis; Had: F. Hystaspes, m. F. Musar, da. Manada and C. Fanu; Had: Arta Farnas=Anti=Fonos, m. F. Furina, da. C. Furnius and Hranci, da. M. N. Fonos=Fones; Had: C. Fonei, m. Fnr Atthis, da. C. Furnius and Atta; Had: N. C. I. Farna, m. Anagna, da. Hystaspes and Anna Ferenna, da. Phanuel of the Tribe of Asher. Thus endeth three last hieroglyphics of 9th and commenceth two on 10th line, left to right. The Bible and Stone Tablet speaks of her as a Prophetess. Anagna and Farne; Had: Farna Bazus, m. Agraea Fauna, da. Arta Farnas and Fnr Furina; Had: C. A. S. Furna, m. F. Camils Farno, da. Fatnus Faunos and Fauna; Had: F. C. C. Arta Bazus, m. Fnr Cleopatra, da. Cleomenes, and Coma, da. Ptolomy and Builder of Alexandria; Had: Bazine, m. Alexander the Great, son of Phillip and Olympias, Fnr Bazine was the da. of F. C. C. Arta Bazus and Fnr Cleopatra, he claimed descent from mother side Archille and Father line of Fna Sammis. They had: Hercules Selucius A. F., m. Fnr Apama, da. Arta Bazus and Epi Da Fne Antiochia, s. F. C. C. Arta Bazus and Cleopatra, Hercules and Apama had Antiochus Theon, m. F. Stratonice, da. Demetria Polior Cetes and Filia; Had: Antiochus Theos, m. Fnr Laodice, da. M. Lepidus and Alexandria; Had: Seleucus Callinicus, m. F. Laodice, da. Andromarchus and Avah, s. Aches; Had: Antiochus the Great, m. Fnr Laodice, da. Mithradates IV and King of Pontus; Had: Antiochus Epi Farnes, m. F. Arsinoe, da. Phillip the son of Alexander a descendant of Alexander the Great. Here beginneth the 11th with a flag of honor for the Great Alexander who inscribed his record on the Tomb of Afras his ancestor at bottom under the monogrammic Embalmed Fna Apries, F. Arsinoe wife of Antiochus Epi Farnes; Had: Demetria Sotor, m. F. Laodice, da. Antiochus Epi Fanous V and Achia; Had: Fna Antiochus, m. Fnr Cleopatra, da. C. Mernus and Ana; Had: Antiochus Epi Fanous, m. Camila, d. M. Fanis and wife Staor, da. C. Deonusou; Had: C. C. L. Furnius, m. Fnr Scribona, da. General A. L. F. Laucius and E. X. C. Fna; Had: M. M. C. F. Lucius, m. Fnr Farna, da. M. C. N. Stati Libo and Julia; Had: Marcus Agrippa Lucius Furnius, the great Naval Commander of Emperor Augustus. He and son and wife goeth to Oma, and he becometh ancestor of many Indians. He m. Tom Fonia=Pomponia, da. T. P. Atticus and Filia; Had: nine sons and many daughters, 14; He was ancestor of G. Washington Family, went to Land of Oma, Pyramid Lake Land, AMERICA, commenced Tower: 11th and 1st 12th line.





X=TOWER BUILT UNTO GOD THE FATHER AND GOD THE HOLY ONE (NEXT SYMBOLS SAY) AND TEMPLE, FORTIFICATION IN OMO THE WOMAN LAND OF W. MARCUS AGRIPPA & TOM FONIA HAD GRÆCIANUS J. CALB C. Furnius, m. Thecla, da. Mary and Joseph that changed his name to C. Furnius, killed by Roman Senate A. D., 26, Mary was killed by the sword 51 years after marriage, 20 Lmk=Aug. Thacla=THCLR was an Ægyptiān Lady of high rank (Mary's features are on Coin Gen. 95 and da. Thecla =present spelling face on seal, vide.) Thacla wrote the Alexandrian Codex (at the British Museum.) She was of the long blessed line b. after Christ, first, before her brothers, James, Joses, Juda, Simon, John and sisters, Jesus said unto the world: A prophet is not without honor, but in his own country, and among his own kin, and in his own house. Græcianus J. C. Calb Furnarius and Theclr, had: Gnæus Agricola Julius C. Furnius, m. M. Furna, da. Germanicus and Agripina; had (Father named Furna and Son Furna) Scribonius C. Furnius, m. Julia Procilla, da. Thecla the writer of Codex Alexandrian, of God's and Ava and Adm's Annals for all Mankind, and Græcianus J. C. C. F.; had Gnæus Agricola Julius F., m. Demito Decida Ana, da. F. Galba and Æiotarou, da. Deistriou: had Fnr Furna, m. Fnr L. Honar, da. Bonevent Scribonis and Putea; had Thecla, da. L. Honar and Furna, m. C, Fabi C. Furnis. Both Theclas wrote the Alexandrian Codex of Trinity which for purity has withstood the test of time, at Museum British. Fonii=Fodii=Fabij of forefathers from whom descendeth the immortal 306 in battle on the Cremea: said Thecla, gr. gt. d. C. Furniu., and m. C. Fabi C. F.; had S. N. Cornel Leucius C. Furnal L. C. L. Furna, m. Fnr Lælia V. F. da. Strabo, s. Donatus Valens and Far Na; had (endeth 12 and 13 lines except) Flag and dot Star of Oma, which is their son C. F. Fabi J. S. V. L., m. Fnr Livia Octavias, da. Pontus Lepidus and Concordia; had Fna Leonidas F., m. Fnr Marina, da. Marcellus Noninus and Marcia Furnella, whose husband was the Grammarian and helped to turn upside down true history; had C. C. Is Fendear=Fars Fnadl=Fandarl, translated from Persian=Is Fendear as this Stone and Holy Bible unintimidated, declareth m. Fnr M. Farnia, da. Helvidius and Antea and s. of Helvitiu ann Fannia; had Farenēs=Bahman, m. Fnia Chia, da. Chinese Emperor 𐎠𐎢𐎡𐎣 they with family went over the great Ocean to finish the Newport Tower in the Land of Omo, a Temple unto God the Trinity (Commenceth 15 line.) A Lookout: Fort: Tower, was built of stones and a receptacle for golden Squares of God's Commandments; by Marcus Agrippa and son commenced who had Indian help from six families of five nations (of Noah and Ham) that intermarried with the ancient Ægyptians. The Temple was monogrammic: Foundation of Stones and arches and round body and a Pyramid was placed over it of stones and trees fell for the interior work: it was carried up and had the name Fa=God on it, steps or a ladder led up in interior which was finished the whole by eleventh=11 Generation from Marcus Agrippa L. F. to signify the Deity, Christ: Genealogy over the top pyramid covering was erected a tapering obelisk passing up and projecting through the Sun, Globe, Primitive Letter F=Fa the name of mst High Omnipotent God: Pyramidal shapes in stone of its internal construction (Pls.9 & 1040) in it was kept the Rolls Squares and Tablets of God and it was Dedicated with religious services to God for all the people on earth and waters of this planet as was given to our foreparents Ava and Adam, a remnant and one of three sons were left here at Omo, Lake Pyramid Land: battle fought: Fnr Chia and Bahman; had F. Sassan, m. Fur Ennia, da. Macro and Codia; had (16th line) F. Babek Yezdijird, m. Irena, da. I Hostalus and Sarsena; had Arta Xerxes Adishir Babigan, m. F. Tashti Arta Ducta, da. 𐎧𐎡𐎢𐎣 Sarani: had F. Sapor, m. Fnr Furan, da. Arta Bazus; had F. Hormuz, m. F. Arcam, da. Theodosius, fr. Genl. Theodosius; had F. Farenēs=Varanas I (with this name 17 line) m. Purana, da. Atta=Otta=Otto; had F. Fernis, m. Fur Ana Fir UZ, da. 𐎠𐎢𐎡𐎣=Fara Rama, s. Arta Xerxes and F. Tashti; had F. Shapur Zulu Kata m. Fnr Car Zarna, da. Adishir Babigan Arta Xerxes and Fnr Tashti Arta Ducta (Here endeth the 17, line.)





HAD: (18 line) FRA MOND=PHRAMOND, WHO BOWED IN PRAYER UNTO GOD THE TRINITY, M. FNR CONSTANTINA DA. CONSTANTINUS MAGNUS AND MINERVINA; HAD: F. MUND ZUNK, M. C. IRENA COMMENA, DA. ISAAC, S. Lucius, s. F. Fernis and F. Ana. Had Fna Attila, m. F. Hilda, da. Constans Flavius, Attila was the prophesied Scourge of God on land and sea, he yielded the Scythian sword of C. Furnius; had Irnac= Ψ - Δ C F. Rna Clovis, m. F. Aridne, da. Zeno and Ari Ducta; had Joannes Merovoetus, m. F Sarah, da. Constantius and Fausta; had Childerick, m. F. Ala Fenius da. Vasa Al Fenius and Veria, 12 gen. from Petrus Varus Ali Fenius; had F. F. F. Clovis, m. F. Clotilda, da. Chilperic, of Burgundy had F. Clotharius, m. F. Ingonda, da. Justin I, Emp. of Rome. Had (19th line), Fna Siebert, m. Fnr. Brunehilde, da. Athanagildus, k. Visgoths; Had: F. Childebert II, m. F. Failuba, da. Antharis, king of the Goths; had F. Thierry II, m. Fnr Thudachild, da. Tiberius Emperor of the East; had F. Pepin, m. Fnr Ayasha, da. Mahommed and Ayasha; had F. R. Bagi Zadah=Begga, m. Zada Baga, da. Mahommed's da. Fatima and Ali; and sister Ha Fne m. Begga, s. F. Pepin and Ayasha; had F. Pepin De Heristal, m. Fnr Plectitude, da. Arjbert, s. Arbet, s. Clothair; had F. Childebert, m. Clotilda, da. Baggis, son of Bagga, s. Charibert; had Robert Le Fort, m. F. Alif, da. Verimund=Fari Mund I, king of Spain, had Robert, Duke of France, m. Al-satha, da. of Alfred the Great and Elswitha had Edward and Fna=Ina, 3 das.; had Hugh the Great, m. Edgina, da. Otho I and Theo Fania, sister Emp. of Germany; had Hugh Caput (20th), m. Fnr Adelaid, da. William III Tower Head; had Robert the Pious, m. Bertha, annulled by Pope son of earth, m. Constantia, da. William Cut Iron Count of Toulouse; had Henry I, m. Matilda, da. Conrad II the greatest prince that ever sat on the Imperial throne since Charlemagne, m. Anne da. Jaraslaus, king of Russia; had from this last m. Phillip I, m. Bertha, da. Florentius Count of Holland; had Lewis Le Crasus, m. F. Adelaid, da. Humbert Count of Maurremie and Savoy; had Lewis VII, m. Alice da. Thibaud Count of Champagne; had Phillip II Augustus (Endeth 20th line), m. Isabella, da. Baldwin Count of Hainault; had Lewis VIII Heart of Lion, m. Blanche, da. Alfonso, king of Castile; had Lewis IX, St. Lewis m. Margaret, eldest da. Ramond II Count of Province; had Phillip III the Hardy, m. Isabella of Aragon; had Charles of Valois, m. Fnr Jolante, da. Alphonzo X king of Leon and Castile and wife Jolante, da. king of Arragon; had Phillip VI De Valois, m. F. Jane, da. Robert Duke of Burgundy and Agns; had John Le Bon, m. F. Bonne, da. John king of Bohemia; had Charles V Le Sage, m. Joan, da. Duke of Bourbon and Isabella; had Charles VI Bon Ami, m. Isabella, da. Duke Stephen; had Charles VII Victor, m. (22nd line) Mary, da. Lewis II king of Naples; had Lewis XI, m. Charlotte of Savoy, da. Lewis II and Anne of Cyprus; had Charles VIII who was great as the Pyramid of France, Espoused to Margaret, Austria, m. Anne of Britany, da. Francis II Duke of Britany; had Charles Orland, Charles, Francis, Annie, killed; JEAN FERNEL, (after Δ = Δ = Δ =A in Egyptian) m. Magdalene, da. Jean Luillier, Attorney General of France, nine went to their death. Jean Fernal=Fernel (Ψ =death by poison) and Magdalene (L.) Fernal had Francis Junius Fernal, m. 4 wives, Maria Commenius, da. John Amos Commenius, s. Phillip of Savoy; had John Furnal, m. Annetta, da. Gaspard De Coligny Admiral of Ocean Navy of France, and wife Ψ ; had WILLIAM FERNALD, b. Castle (Endeth 22 Line: now commenceth 23 line) of Hiedleberg, Baden, Germany, m. Elizabeth Amand, da. Girard Amand and wife Elizabeth Washington; had (Δ) Dr. Renald Fernald went to the land of Lake Pyramid, Anonna, OMO, m. Joanna Warburton, da. Judge Warburton; had Thomas FFernald, m. Temperance Washington, da. Robert Washington & wife Annie Cotton, da. Sir Robert Bruce Cotton, Va., from Eng.; had John Fernald I in land OMO, m. Mary Spynie, da. Thomas and Margery Spinney; had John Fernald II, m. Sarah, da. Judge John Hincks and wife Elizabeth, da. Nathaniel Fryer, Judge. (End 23, 1.) Captain John Fernald, m. Elizabeth Rogers, da. Rev. John and Martha Rogers; had Mr. John Fernald IV of America, m. Mary Savage, da. Thomas, John and Savage in American War; had William Fernald, m. Elizabeth=Betsy Johnson, da. Phineas and son Col. Samuel, s. of Captqn Timothy, s. Lt. John Johnson; had Jonathan Poor Fernald, m. Mary Cotton Pike, da. Robert and Mary Cotton, da. Col. Wm. Cotton, gr. da. General Zebulon Pike (24 line.)



GENERAL ZEBULON PIKE, FATHER OF BRIGADIER GENERAL ZEBULON MONTGOMERY PIKE THUS ENDETH THE 24TH LINE WITH AT LEFT TO RIGHT ON 25 LINE THE CREST OF THREE SPEARS OF THE PIKES COAT OF Arms, Had: (the next three generations and on mentioned that which is a fac simile of the Decree of Cyrus the Great who mentioned the line for about 800 years from 1900.)

Thus foretold without a change of one jot or tittle these events from God thy Father I have used in my translation the Plate Copy in Book of William Norman Irish, who gives credit to Scribner & Co., N. Y., for Plate that was originally taken in "squeeze paper" by M. Ganneau, and correctness certified by first discoverer, the Rev. Mr. Klein: but Dr. Ginsburg claims it was also curved at bottom.

"The neglecting the study of true wisdom, says an eminent writer, will revenge itself: the despisers of it not being able to do well in their greatest prosperity, and the lovers of it not being willing to do wrong in their adversities. All virtues are in agreement; all vices are at variance. "A good man is influenced by God, himself, and has a kind of divinity with him."—*Seneca*.

"The great philosopher Socrates, on the day of his execution, a little before the draught of poison was brought to him, while entertaining his friends with a discourse on the immortality of the soul, said, Whether God will approve of my actions, I know not; but this I am sure of, that I have at all times made it my endeavor to please him: and I have a good hope, that this my endeavour will be accepted by Him."

Philip III, King of Spain, seriously reflecting upon the life he had led in the world, cried out upon his death bed, "Ah! how happy should I be, had I spent those twenty-three years that I have held my kingdom, in a retirement!" At the same time saying to his Confessor, "My concern is for my soul, not my body."

Cardinal Wolsey, one of the greatest ministers of state that ever was, poured forth his soul in these sad words: "Had I been as diligent to serve my God, as I have been to please my king, He would not have forsaken me now in my gray hairs."

Cardinal Richlieu, after he had given law to all Europe for many years, confessed to Peter du Moulin, that he being forced upon many irregularities in his life time, by that what they call reason of state, could not tell how to satisfy his conscience upon several accounts. And being asked one day by a friend, why he was so sad, he answered: "The soul is a serious thing; it must be sad here for a moment or forever."

Cardinal Mazarine, having made religion wholly subservient to the secular interests, discoursing one day with a Sorbonne doctor, concerning the immortality of the soul, and man's eternal state, said, weeping, "O, my poor soul, whither wilt thou go?" And afterwards seeing the Queen-Mother, said to her, "Madam, your favors undid me; and were I to live my time again, I would be a capuchian rather than a courtier." In ancient times the pope at his inauguration used to have four marble stones presented to him, out of which he would choose one for his tombstone."

Chapter VII

NOW SEE GEN. 53. MAHATAVAL AND RAMANKHFA (AND SEE FOUR symbols the fifth line) Hazzal and Anm II=Anamim 2nd. See Ax found at Pemberton, New Jersey, Gen. 53) Anannaah and Sufis, 24 Gen. Catouche wings the large letter C and Greek C=Γ and G. Aaglah and Mizraim II, Halarh and Shishark, and Catouche Gen. 56 declareth Christ is to come and prayeth unto God the Father and God the Holy One, Baru and Fna Tachnatis, Arlina and Boccharis the line of beauty of Riua (Riva) and Osarkon, Saraho and Si Hasi, VASHATANA and Orsakon the mighty, Arkona, and Namrut, (See Catouche 62,) Mutta and Takalut, Camilla and Shamkon, Mullah and Ramsass, Ncara and Fna Zo, (See Coin) (Catouches) Zara and Samiticus, Saio and Nachro, Srta and Sammis, (Vide C. Gen. 68-9). The Square Tablet on

69 is part copy

Egyptian Chart, gave to Ham contained the stating to East and sailed a new country whose teen Stars and its be the Stars and it to and they shall Wor- of God the Holy bols on line to second Thalia and Afrias= Cambyas, (Pl. 63) who attempted to Genealogy and pre- such an extent he this Plate of Kircher and Adam correct two of the Primitive tom under panel has the Great and Alex- Atilla the S word is on this line of Gen. and Cyrus the Great, Decree Rings forth musical tones that are World in Egyptian

Plate 403 gives man and Mankind beyond the present Christ. See Pl. 129. Fna Darius, Amas- Nas, Musar and F. bottom line project-

Artar=Anti Fonou=Fernes, See e glyphs not connected from right Anagna and C. A. S. Farna, Agraia Farno and C. A. S. Furna II, Fnl Fna Bazine and ALEXANDER Olympias born at Pella and d. killed Mother Archili a nd Father Fna Apries or Afras: Plate 130—a Compass Box at British Museum dated, 2532 B. C., with the name of Fna Atta that declareth the line of Noah went from Omc, Anon, to people the whole world in its hieroglyphic language which remaineth till the last great day with Pyramids of Stone and of Earth.



THIS MEDALLION WAS STUDIED BY WILHELMUS DE GUBERNATIS IN HIS TRAVELS IN THE EAST IN 1687. IT WAS FOUND IN THE TEMPLE OF ALEXANDRIA IN 1687. IT WAS FOUND IN THE TEMPLE OF ALEXANDRIA IN 1687. IT WAS FOUND IN THE TEMPLE OF ALEXANDRIA IN 1687.

A PAIR OF COINS OF OUR PEOPLE COINED FROM THE GREAT PART OF THE TEMPLE OF ALEXANDRIA IN 1687. IT WAS FOUND IN THE TEMPLE OF ALEXANDRIA IN 1687. IT WAS FOUND IN THE TEMPLE OF ALEXANDRIA IN 1687.

from same in the Map, that God and Noah which ments of flood sail- to the West to form flag should have thir- Coat of Arms shall be called U. S. A. ship Christ the Son One etc. Count sym- figure and read:

Apries, Nietatis and from Jesuit Kircher write the World's vented, persecuted to desisted. Count on is from Afras to Ava and he has letters Alphabet and at bot- the names of Cyrus under the Great with Scourge of God, who F. Anr Mandane whose immortal the Golden Silvery heard around the genealogy reading.

Generations of Wo- to about 800 years time, 1909. After "Fnr Attossar and tris and Arta, Ba Za Hystaspes, (Figure 8 ing.) Furina and

Coin, Gen. 76, and 4 and 5 hiero- of 5th line: Atthis and C. Fonei, Fauna and Farna Bazus, Camilo Cleopatra and F. C. C. Arta Bazus, THE GREAT, son of Phillip and at Babylon. He was descendant from Sammis and cut his name under F

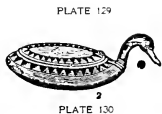

PLATE 129

PLATE 130

A

PLATE OVER ALEXANDER THE GREAT IS HERE THE MOST ANCIENT NAME OF AMERICA: IT SPELLS IN ITS MONOGRAM, OMO, ANONA, OMA, AUGUSTI, ADN=EDEN, AND HATH THE THIRTEEN COUNT of Stars on Map Chart of Ham and on United States Flag. The ancient family kept Sacred Seal down through all the ages and affixed to gr. fr. Deed to Fr. Hercules Selucius

Antiochus Fernes and wife Fnr Apama, (6th whose ancestors came from Omo whose Stars of 5 points each. After Figure 13 see 3 connects two, and where connected, they are Laodice and Antochus Theos whose line is Chia and Bahman: Christ of God foretold of God name cut by Marcus Agrippa L. F. at will raise the Sea Green Flag Seleucus Callinicus, Laodice and Antiochus Epi Fanous, Laodice Camilla and Antiochus Epi Fanous, C. C. L. Furnius, Farna and M. M. M. A. L. Furnius of Roma who Dighton Rock, Flag, Oma Land: of Christ the line of beauty, as God 10 Jun. 4442, married Grecianicus Agricola J. C. F., the line of beauty C. F. Domita, Decida and Meneus, Furna, Thecla, da. Honor and Furna the Alexandrian Codex at British (pl. 551) Laelia V. F. and S. N. 6th line and part of 7th and 8th:) V. L. Marina and Leonidas F., and

Omo, across the great C. C. Is Fendear of the and F. Bahman cut and will finish Temple killed her beloved, one band, an infant died; for help, the Lord send-holy Chia, an avenger, with to right of it:—Irena and F. Babek line left to right) F. Arta Xerxes Adishir Sapor, F. Arcam and and F. Faranes=Vara- and F. Fernis whose footsteps goeth forth: sail: Car Zarna F. Shapur, becometh great in Anon Land he reigneth; Constantina and Fara Mond, Irena Comeni and Fna Mund Zunk, F. Hilda and F. Atilla who here is represented as Sword and Pike or spear of the Lord's vengeance upon the wicked that will be destroyed, Aridne and A. M. Frna Clovis=Innac=Frnac, they remove and carry Golden Square to Mound Land of Serpent Mound this line God Blessed. Part of this chapter is a return to Moabite Stone, Payprus Prisse, Decree Cyrus, Coins, Egyptian Monuments, etc.

Plate 133—Mariner Compass made by Fna Afosis, 2200 B. C., and gives in symbols his ancestry to Noah on this Box of Compass now at British Museum.



Plate 132



PLATE 132

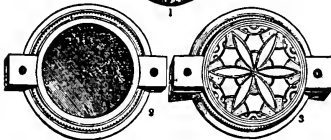

PLATE 133

Line, left to Right) Stratonic and Antiochus Country shall be known by its Flag of 13 lines connected viz:—5, 6, 7 and next symbol to be translated differently in each line oldest from first Adam, Seth and wives to Fnr would cut his name by letter in name letter Oma across the long waters where Agrippa declareth God." "Laodice and Antiochus the Great, Arsinoe and Demetrius, Cleopatra and Antiochus, (son of preceding) Scribona and L. F. Leucius, Tom Fonia and will write and cut his name on Thecla, da. Mary and Joseph, sister promiseth it was done: She was born J. C. C. F., Furna and Gnaeus of Lord, Julia Procilla and Scribonius, Agricola Julius, L. Honor and m. C. Fabi C. Furnius: She wrote Museum, London, Old England. Cornel Leucius C. Furna L. D., Livia Octavius and C. F. Fabi J. S. they went to the Pyramid Land,

waters: M. Farnia and same as Farndal; F. Chia names on Dighton Rock Fort and here was son by Spear and husband Chia prayeth unto God eth her, the beautiful (see end of 7th line) Anna and F. Sassan, Yezdjird, (Read 8th Tashti Arta Ducta and Babigan, Furan and F. F. Hormuz, F. Furana nes, Fna Ana Fir Uz





“LET NO MAN SAY WHEN HE IS TEMPTED, I AM TEMPTED OF GOD: FOR GOD CANNOT BE TEMPTED OF EVIL, NEITHER TEMPTETH HE ANY MAN.” F. SARAH AND JOANNES MEROVEUS, Ala Fenius and F. Childerick, F. Clotilda and F. F. F. Clovis, Ingonda and D. Clotharius, F. Brunechild and Fna Sigebert, and here in book his Shield and Initial

letter of his name appear, with the line above, Sermid, Colorado Adm & monument ancestral: at he goeth forth to pyramid, Salic Law passed is fore women at late time the courteous, women, Childebert II & Failuba, F. Pepin & Ayasha; Coin recordeth on his Pl. 134



PLATE 134

eth on it and connected pent Mound, Lake Pyra-Ava Genesis described right from left same line: mid lake Oregon land; found name of men be-man used. In France, not inherit Government, Thierry and Thudachild, of Alexander the Great some most important facts

and data: count from left O's bring his Gen. 82 to forefather 58 and Seal on Catouche and also right side of this coin. Sword blade thirteen dots representing Stars on Ham Map that foretells U. S. A: as does this sword and 13 on Papyrus Prisse in Chapter V. He had the two Golden Squares and is descendant of foreparents as per proof: The O=Fa or first letter of primitive Alphabet, next Symbol is a Hebrew Ayin called A or Eye, it is also, the letter in Ægyptian M; terminal Heb. M, shape of letter on his sword, Greek L is an Ægyptian A also the Δ, lower eleven O's that a prophecy that child of line shall write the lines as declared above at 11 O on coins means son also child, at end, left is seen the pyramid of Oregon God, made as white spot in it, is name pure God, at left of this 2nd white dot means son of God, also the black line above and below at right is the so-called serpent Line Mound at Adam's County, Ohio, and a line of waters that represents Dighton Rock and River Taunton, while above the T is a fallen pike point carved on said Rock prophesying fall of killed Alexander and Sassan the T is constructed similar to the name of Lamar as seen on Tablet of Abydus and again the pike is 3rd letter in Genesis of the word translated into Ægyptian and on Mss. Papyrus the pike as well as on Rock is to be seen: the T is a monogrammic spelling of Noah and Lamar, Ham, Araat, and turn the coin upside down and T symb. declares Lamar Noah and Hm. went from Araat and next symb. "to Pyramid Lake, Oma" also Anm (other lines declare those who returned Y Agpt[=Egypt] declareth Agypt peopled by OMO and oldest returneth after Anona was purified (dot in tail of Y=M is one of thirteen circles or dots circumscribed on coin.) "The Great Seal O" will be seen to have, as on Dighton Rock, the Initial of "Christ son of God in" it, etc. To be complete some of capital point mentioned would enlarge this work, far beyond the intent to more than bring before all, especially expert linguists, positive evidence to glean, for the granary store house of history, crude sheafs of TRUE unwinnowed perfect grains that if well received—is to be put into 2nd Edition: the opponents will be, are those, set forth in past Encycliæ who profit by ignorance and sin. Papyrus further recordeth:—"Begga and Zada Baga, Pepin de Heristal and Plectitude, Childebert and Clotilda, Robert Le Fort and Alif, ancestors of Pike one line family, Robert Duke of France and Alsatha, Hughe the Great and Edgina, Hughe Caput and Adelaid, Robert the Pious and Constantina, Henry I and (Matilda,) & Anne, Phillip I and Bertha, Louis le Crasus and Adelaid, Lewis VII and Alice, (Adelaid m. Lewis VI s. was VII) Isabella and Phillip II Augustus, Richard VIII Cœur de Lion and Blanche.



“**B**OTH NOT WISDOM CRY? AND UNDERSTANDING PUT FORTH HER VOICE? SHE STANDETH IN THE TOP OF HIGH PLACES, BY THE WAY IN THE PLACES OF THE PATHS. SHE CRIETH AT THE gates, at the entry of the City, at the coming in at the Doors. Unto you, O men, I call: and my voice is to the sons of man.”—Proverbs 8, verses 1, 2, 3 and 4.

“St. Lewis IX and Margaret, (he, canonized by Roman Catholic Church and a day of festivities set apart; celebrating.) Phillip III Le Hardi, & Isabella and on Stone (see sym.) Charles de Valois & Jolante, Phillip VI de Valois and Jane, John le Bon and Bonni, Charles le Sage and Joan, Charles Bon Ami VI and Isabella, Charles VII Victor and Mary, Lewis XI and Charlotte, Charles VIII and Anne of Brittany, da. Francis II Duke: Dr. Jean Fernel and Magdalene Luillieur, Francis Junius Fernel and Mariae Commenius, he a Doctor, 4 wives, Minister, Lawyer and Warrior: See 8th symbol of 10th line and read left to right with Δ Greek over symbol and under duck shaped compass plate) Dr. John Fernel and Annetta de, da. (Gaspard de Coligny Admiral of France to formeth a colony in Anona:) he, J. F. stabbed to heart kil. by Jesuit,) Captain William Fernald and Elizabeth Amand went to Anona, 1630 A. D., the cradle of Cain and Sister, Abl and Zana, St and Sana, Dr. Renald Fernald and Joanna Warburton goeth to Oma July 4, ar. in Warwick, 1631, with sword and seal; Tho. FFernald and Temperance Washington, da. Robert and Anna Cotton, his wife, da. Sir Robert Bruce Cotton. Robert Vashatana=Washington (claimed his) a descendant of Gen. 61 (turn last three lines upside down and then Right three symbols give descent gen.) 6 and 1=61 (on 11th line, which further says:) “Dr. R. F. off to Omo from Bristol, England, Mother Country.” (Last three lines of the thirteen giveth fully the correct line) that was written 1900 B. C. (which it is believed that Cyrus the Great was conversant with before his startling Immortal Decree.) (Continued we have) Fra of Lord 18 Gen. ‘Honor and Hasaftr,’ (before turning upside down) (some marks of it on Catouche) bird line and Seal of Nh and Hm, etc. Honoring Women, Fnr Fardar and Fna Mars and of Ava, Adam, Ladar and Lamech, Fanar Sara and F. Hanok (Enoch) 68 Gen. Fnr Saio and Fna Nachro whose long line from heaven hath the Lord Blessing Promised:” 86 Gen. on “Coin records bearer of God s gift Seal of the Sun and Moon to and from Seleukou pen and Laodice Arrow and Pike and javelin and bow, which with love, honor, justice doeth Godly work for All (See Plate 292) beings destroyed evile Alcoholics, sin, disease, that will with protected and protecting criminals; for God with Christ and pure wagheth war with hook,mace,battle ax, swords and implements against them in battles strong and mighty, far and near, raging till the cycle or circle of God exterminate and Fa is Supreme God Omnipotent to whom all shall bow on their knees worship,even after punishment for their sins.” ‘(It is now a repetition of laws and commandments, see: Read left to right for Omo line here recorded:’) 11th Line:—viz. “Mary Spiny, m:John Fernald, Sara Hincks m. John Fernald, Elizabeth Rogers m ‘(Warrior Ship)’ John F, Mary Savage da. J. S. m. J. F., Btsy Johnson m. Wm F., her fr. and Jno in American Revolution, (see) sword point and a Pike (12th and 11th lines connected) 12th indicate 12 chn. and at connection eleven hieroglyphs with; count 11 chn. of M. C. P. m. J. P. F., chn. M. R. D. kil., M. E. C., kil. H. H., kil.; J. W. F., m. S. H., P. F. m. E. H. P. C. A. F. m. E. A. (M.) A.; da. F. J. F., kil.; the Assassin is P. and tool E. R. of 3.; and there shall arise dreadful wars and the Lord is with the Lord’s line banner F. upright, that hath borne the burdensome yoke and ariseth above all foes, that the Lord leadeth and chooseth to wage war against unholy abomination that under guise of Lord, striveth to destroy God, and this Satan of woman and man beguiled from the 8, and letter to five, hath aroused Omnipotent and Omniscient to their complete destruction. Signed, Sealed. Afr. 1900 B. C. Fna Ramfarka, Jul. 8 da. of Lord God. (Trans. 1908 A. D.) The Papyrus Prisse which is like Moabite Stone, Decree Cyrus Genealogy. This bequest for justice.



“S

AID GOD UNTO MOSES, I AM THAT I AM: —SAY,—I AM HATH SENT ME UNTO YOU.”
HERE IT IS CLEARLY DECLARED TWICE IN THE PRIMITIVE HEBREW AT
EXODUS III, VERSE XIV, CAREFULLY TRANSLATED INTO THE ANCIENT
PRIMITIVE LANGUAGE THAT THE ALPHABET IS F. A. M. AND THE FOURTH
SYMBOL IN EACH IS A PICTURE OF THE MOUTH THAT SPEAKETH: ALSO
IN THE BEAUTIFUL ÆGYPTIAN IT IS GIVEN, EACH SYMBOL, AS THE NAME

of God and its equiv-
=FAM=OCM and ISM
and F are in these few
changeable and equiva-
lology. Genesis, chapter
Joseph's name: —“Fam
Had: Mneh and Afron.”
scription on Ledge of
Monhegan, off coast of
B. C. and 31 of Jared=
riage of Anbury da. of
Fur Hano the mother,
tota a great War Chief,
son of Yatonwater, son
F. who came from Roma

Plate 136. Mexican
Lake Pyramid at Omo.
land valuable inscription
of Kingiktorsok, in Baf-
Copenhagen. Genuine
scendant from the primi-
value. Part of its Rec-
the flood goeth forth Nh,
one family to people
from Araat, to Annon
the River Mi, An-Anon,
where the waters of
fountains of the
where man, woman
the light and received
Squares, Laws, Com-
giver of all perfect gifts
and Man.” It declar-
“Mullah and Ramses:
Hm Map Chart and
Funeral Tomb: descent
F. and Chia and Bah-
Trinity,” etc.
Rock inscription with
D. 1696 paso D M.”
copied after seal of
three bear the com-
mitted by Nh and Fnr
They claim from land
the Mounds: worship
Holy Spirit: the Fnr
cus Agrippa L. F. Bird
Bahman. (11 Gen.)

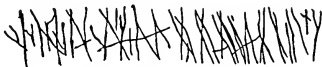

PLATE 135

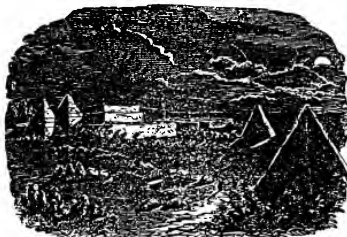

PLATE 136



PLATE 137



PLATE 138

alent is I A M=O A M=
for Trinity, H I O S A
linee with the C, inter-
lents: very valuable Phi-
XLI, 45, 51 and 52.
Fania Fania m. Asnt :

Plate 135—The in-
Hornblende on Island of
Maine, U. S. A. 1013
May, I Oratota and mar-
King Solomon who m.
month of Jarada. Ora-
with Bow, Arrow, Spear,
by m. Marcus Agrippa L.
with five ships,” etc.

Pyramids copied from the
Plate 137. Green-
found 1824 on the Island
fins Bay, preserved at
Norse Runic a direct de-
tative and is of world-wide
ord: —“From the Ark of
Hm, Sm Jlt, and wives
the World. They came
from Lake Pyramid by
the Mounds Land
heaven descended and
Deep were broken up
and children first saw
the pure Golden
mandments of God the
to His Children woman
eth descent from
counts 13 of Nh and
Papyrus: 12 on P.
“from M. Agrippa L
man: the worship of

Plate 138. Moro
a monogram and “A
The D before M is
Papyrus Prisse. All
mon parent Seal trans-
Lamar to descendants.
of Lake Pyramid and
of God one in Fr. and
and Fnr tree of Mar-
symbol of Chia and F.



“S

TRIVE NOT WITH A MAN WITHOUT CAUSE, IF HE HATH DONE THEE NO HARM, FOR THE UPRIGHT SHALL DWELL IN THE LAND, AND THE PERFECT SHALL REMAIN IN IT: BUT THE WICKED SHALL BE CUT OFF FROM THE EARTH, AND THE TRANSGRESSORS SHALL BE-ROOTED OUT OF IT.” Plate 139—Babylonish hath thereon seven pyramids that are representative of one week, the highest is Lake Pyramid at Oregon and right of Egypt prophetic of its coming downfall among seven

nations: Two inner circles coming of the Son of God its inequalities prophetic of from primitive commands grandizement: Egyptian with part of Crescent the hommed and its great they preach: large right Mound in U.S. and the Egg Nations of first Anon, and Cross is symbolic of Mound shall come here and cut his which he did. See symbol C=Creator, Ava and Adm, made: (Abl pure): Gen., Moonday was 8th day: toxicated slew Bro. Abl in driven from Garden of Adu month, said Theos=God=range of four weeks 1 Moon “This is the year of expul-Janu=Fanu 8.” The first built before the Deluge. dated 1650, last, left each symbol four sides upper left corner=16 and is C=Century whole count III and two part a O=50, count 6 sym-1656 Bis C=B. C. The symbol of Ark, waters River under 1=Missipi etc.

Plate 140—One Cal-As on earth the Egyptian, wise, just and tem-



PLATE 139—THE BABYLONISH FACTS

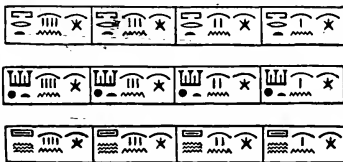

PLATE 140—THE EGYPTIAN CALENDAR

example:—Here read from right to left:—“Star is symbolical 12 months named right to left:—Hebrew, English.

- | | |
|----------------------------|-----------------------------|
| 1. St=Seth=Jan. | 7. Mtfalh=Methuselah, July. |
| 2. Anos=Anfs=Enos=Feb. | 8. Lnk=Lamech, August. |
| 3. Kfn=Cainan, Mar. | 9. Nh=Noah, September. |
| 4. Mhllal=Mahalaleel, Apr. | 10. Hm=Ham, October. |
| 5. Frd=Jared, May. | 11. Mzrfn=Mizraim, Nov. |
| 6. Hnak=Enoch, June. | 12. Anm(om)=Animim, Dec. |

Plate 141. Fna Atta, Gen. 15 writes history of Creation and his wife Fnf Mra hath the Commandments and Golden Square of God's Gift to Ava and Adam; First Flag Gift to Nh and Routes from Mound and Pyramid Land death of wicked from skin bottle of wine. Monogramic names: Egg of Promise an ans. to prayer of Adm and Ava to God, etc. Plate 142. Is after the flood Generation 16th. Fur. Hanar=Honor and Fna Haw Afr of the Land of FENE Bs from that his father Atta received from Att his father that received from fr. Tta from fr. Ynm=Anm=Anamim from fr. Mizraim from fr. Ham who came from the OMO, Anona, Pyramid, Mound Land where fell our fore parents: chn. d. by flood, diseased, wicked, in the land of the Serpent Mound brought and gave to me the Squares and Tablets, Laws for all Wo Man Kind, to teach and give my son F. Mantha.

God B. C., and Cross, b. of Mary and Joseph and the fall of two churches and worship for self ag- and English or Roman T Turkish Religion of Ma-power from practicing what hand oval that of Serpent of Promise is given to Five the large C at the foot of Land, declareth that Christ line on Dighton Rock, is names of Trinity. 1 God, the godly St: Cain, Vini twin of Kanafatafar m.: Kfn=Kon=Kin=Cain in-Mound Land, Omo, after =Eden: St name first Januri. Thus endeth quad=Month of 31 days with sion from Eden. 100 day, eight months show Mounds

Last four the Flood quadrangle by count of and center of figure two part circles=00 and 1600: 50 in 2nd to right, circles=5, last over star bola. right=6, a total of last on right is a picture under M next, is. and River. Correctly Read,

endar of Egypt the wise tians were the most reli-perate we find here a



PLATE 141



PLATE 142

“WHICH IN HIS TIMES HE SHALL SHEW, WHO IS THE BLESSED AND ONLY POTENTATE, THE KING OF KINGS, AND LORD OF LORDS:”—1 Timothy 6:15 “AND HATH MADE OF ONE BLOOD all nations of men for to dwell on all the face of the earth, and hath determined the times before appointed, and the bounds of their habitation;”—Acts 17:26.

The best parts of ever be Supreme Laws framed from God's commands and laws enforced gives safety individuals with happiness unto remote position of Rights and thus practiced by Hampshire, God's

Plate 143—Is to Plate 144—Is the peror, Empress or of earth. A very brief of five is as

“The Trin-created Ava that they Queen and land, earth anointed with oil of given the God perfect who should of the long and Adam, of Omo, ramid Land God and be the spi-

of All the Earth and Habitation in the Garden were driven forth for by the hand of God. ments of sin, went forth Trinity God's face was Woman pure that forgave Woman he gave great earth to be the mother of love and men kind: God the Lord said part of the power I with my hand take from Thee Adm and punish, thy line suffer: Go to and build a mound of Serpent that thy sin may not be forgotten nor the promise to Ava: build it at Adms C., near waters, at mound the Egg of promise of Christ, go with Cain, Abl, St, and wives: Man hath done evil in my sight: IT was done: men grew, multiplied on the earth and sinned: the face of God was dark with anger at their diseases and sin: Noah drank wine and sinned as Adam, but greater for he was drunk: God in his righteous anger told Noah he would destroy all if it was not for pure Lamar and his Promise, but doth destroy, excepting Noah's family, and animal life sufficient to people the earth again from line of first two in one: Rain is to destroy it, save four men and four women and I will be with the women and men on Ark build with the women and thy three sons to ride the waters and I with Compass will be with thee and pilot thee out of the land of Omo on waters of Miss.: take my Sacred Rolls, Golden Squares, Tablets, to Araat from Mound Land and waters for I am thy God the Father and Holy One.”

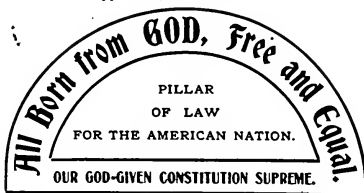

PLATE 143

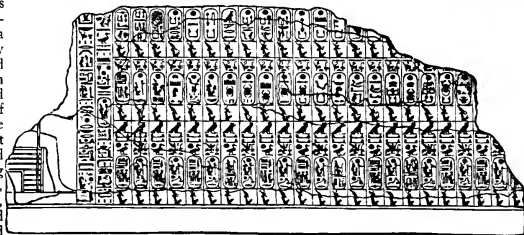

PLATE 144



PLATE 145. The Lines. Combination in Chinese.

all the laws that must are constructed and absolutely perfect which ever when fully unto nations and inness and prosperity terity. Our Decla-Constitutions were my native state, New Bible, its Laws. honor God for his gift. Egyptian Royal Em-King and Queen line partial translation, one

follows:—ity Is God and Adam should be King of the a line one, by the Lord purity and spirit of in Christ come born line of Ava in the land Anon, Py-created of Christ shall ritual King

Waters. From their of Eden man and woman Adam's serpentine sin Adam and Cain, monu-on hills and waters: darkened. He saw him the evil deed: powers on waters and part of the power I with my hand take from Thee Adm and punish, thy line suffer: Go to and build a mound of Serpent that thy sin may not be forgotten nor the promise to Ava: build it at Adms C., near waters, at mound the Egg of promise of Christ, go with Cain, Abl, St, and wives: Man hath done evil in my sight: IT was done: men grew, multiplied on the earth and sinned: the face of God was dark with anger at their diseases and sin: Noah drank wine and sinned as Adam, but greater for he was drunk: God in his righteous anger told Noah he would destroy all if it was not for pure Lamar and his Promise, but doth destroy, excepting Noah's family, and animal life sufficient to people the earth again from line of first two in one: Rain is to destroy it, save four men and four women and I will be with the women and men on Ark build with the women and thy three sons to ride the waters and I with Compass will be with thee and pilot thee out of the land of Omo on waters of Miss.: take my Sacred Rolls, Golden Squares, Tablets, to Araat from Mound Land and waters for I am thy God the Father and Holy One.”





YE SIMPLE, UNDERSTAND WISDOM: AND, YE FOOLS, BE YE OF AN UNDERSTANDING HEART." "OPEN THY MOUTH, JUDGE RIGHTEOUSLY, AND PLEAD THE CAUSE OF THE POOR AND NEEDY."

After closure by the two lines in Plate 144 and from Plate 145 that was found at Egypt and it signifyeth combination in ancient Chinese primitive language—and the four lines Justice, Wisdom. Then appeareth the most remarkable Catouche of Fna Mizraim and the line to the Great F Alexander that includes some of the same ancestors as those on the Tablet of Abydus that a comparison of two Tablets will prove. Translation:—"God gave the seal ring unto Ava, Lamar and Nh in the land of Washn over the waters where Trinity God told Nh to build the vessel=ark with double walls and sloping roof: God's vessel to save God's children in Adan: at the mouth of the River, at the land of Nh and Hm to save his family from flood: To take therein beasts, birds, animated life: them to save for re-peopling the Earth and fulfilling his promise, too, for the birth of the son of God. Water covered the Earth and from Anona the land of Omo, Mounds and Serpent Mound they went forth with compass to Arat=Ararat and God saved them."

FNR LAMR, THE WIFE OF NOAH WRITES THE HISTORY OF CREATION WHICH WAS COPIED BY MOSES IN GENESIS, AND HER DESCENDANTS ARE KEPT ON THE TABLET OF ABYDUS AT THE BRITISH MUSEUM AS IS HEREIN SET FORTH.

A FEW
ABBREVIATED
FACTS:

Plate No. 1 A.



Plate No. 2 A.



Plate No. 3 A.



Plates 4 A, 5 and 6



Plate No. 7.



Plate No. 8 A.



Plate No. 9 A.



GOD THE TRINITY, THREE IN ONE: CREATED FROM EARTH AND WATERS, ELEMENTS, FROM CHAOS, NIGHT; ORDER, LIGHT, PLANETS, AND WO MAN KIND, THREE: HIS PURE, BEAUTIFUL HOLY CHILDREN OF EARTH AND ELEMENTS WITH HIS SOUL SPIRIT, HEAVENLY GOD CREATOR OF HEAVEN, HONOR, JUSTICE, ALL THREE IN OMNIPRESENT, OMNISCIANT AND OMNIPOTENT GOD UNIVERSAL POTENTATE WHOSE GREATNESS IS: EARTH, WATERS AND WORLDS ARE BUT ATOMS, DROPS, IN COMPARISON, MADE ALL. THE CELL, SEED, OVUM, OF NATURAL ANIMATED AND INANIMATE LIFE WITH FNR AVA AND FNA ADAM LINE OF MANKIND IN HIS GLORIOUS IMAGE. WOMAN AND MAN □ IN A SQUARE, TWO TO BE ONE PURE ◊ HOLY: NO WINE, EVIL, LIKE SOUL UNTO FATHER GOD. THEIR BODIES MADE OF THE EARTH AND WATERS TO WHICH THEY SHALL RETURN, SIMILIA SIMILIBUS, AND SPIRITS WITH SOULS UNTO GOD: WHEN PURE, DWELL WITHIN GOD THE RIGHTEOUS EXECUTIVE THERE WAS VIOLENCE UPON THE EARTH, AND THE UNITY OF MANKIND BROKEN BY EVIL DEEDS, BLOOD WAS SHED BY THE SWORD, HARMONY, LOVE DESTROYED.



“**R**EMOVE FAR FROM ME VANITY AND LIES: GIVE ME NEITHER POVERTY NOR RICHES: FEED ME WITH FOOD CONVENIENT FOR ME: THEN I SAW WISDOM EXCELLETH FOLLY,” VANITY. Trinity God’s face was darkened with righteous displeasure as He looked upon His Creation of Woman pure and wicked Man in his likeness that He gave purity,

Plates 10 A and 11.



power, judgment, wise justice and lives. God saw four women pure and holy, the wives of Nh, Hm, Sm and Fna Jfpt: Fnr Lamar most perfect wife, of Nh who drank wine and was drunk and beastly evil, wicked indulgent lioness conceived Apedom confusion. For vile acts God destroyeth creatures of the world by waters: Save family of F. Lamar, eight, and pairs of dogs, birds, apes, animals and living species for procreation and rehabilitation of earth.

Plate No. 12 A.



Plates 13 A and 14.



On 600th year of Nh life, 2nd month] of Anos =Feb. 17, 1655, the windows of

Plates 15 A, 16 and 17.



Heaven were opened and the 9 fountains of the deep were broken open and the rain was

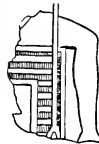

Plate No. 18 A.



upon the earth forty days and forty nights: the waters of the flood were upon the earth at Mississippi River Land of Fna No ah and Lamar Land covereth all the God given land

to Fnr and Fna Ave, and Adm who did evil, copied by Cain, and Nh=Noah, wine both Cfn and Nh drank vile cursed drink, not Adm; whose sin is here told.



Plates 19 A and 20.



FOR WOMEN, MEN, CHILDREN be it told GOD THE HOLY TRINITY said—Nh and family build a house, vessel, ship, ark to sail the waters safely thy family: 1, God, with chart, compass, hand will lead you to save my seed the small remnant of Wo Man Kind while I utterly destroy all: saving thy family: dogs, birds, beasts in pairs take into the vessel. Lamar and Noah family unitedly

Plates 21 A and 22.



Plate No. 23 A.



Strong with Trinity one in purity, that with my protecting arm Lamar family One for the world in me God their Father my child I will guard, guide, watch and keep from destruction

Plate No. 24 A.



of world drowned over which I will lead safely Lamar the upright wife of Noah, and mother of Hm, Sm, Japeth, and wives to Mount Araat off the Serpent Mound, Land of Omo, Anona: 1, as God Commandeth, write, being the wife Fna Noah, born in Mound Land of O ma, where the sun first shone on the Father God’s lines of beauty creation, gift of God. His Name Seal with five lines 1, 27th of Anos=Feb., 1556, prefix it, Fnr Lamr a worshipping Child of GOD, at Mount Ararat.

Plate No. 25 A.



Plate No. 26 A.



“**D**ISCRETION SHALL PRESERVE THEE, UNDERSTANDING SHALL KEEP THEE: BUT THE WICKED SHALL BE CUT OFF FROM THE EARTH, AND THE TRANSGRESSORS SHALL BE ROOTED OUT OF IT.” “THE curse of the Lord is in the house of the wicked: blesseth the godly children of the Just.”

Plate No. 27 A—with data:

Line and circular language in primitive.



Plate 28—Calendar of Lamar.



Plate 29 A—Calendar of Fnr Lamar Salvation



Plate 30 A—Birth of Christ. Literal Fulfilment of God's Promise to F. Ava and Adam is thus hereon and recorded: Our Messiah!

Plates 31 A, 32, 33 and 34 following.



God Created the Universe 5810 Before Christ the Messiah His Son born of Mary and Joseph in lawful wedlock the only one pure man: And the Lights of Sun, Moon and Stars for us: 5397 B. C.

The Lord God Created Wo Man Kind, 4376 B. C.: He gave to them speech, love, power, beauty, intellect, knowledge, skill and wise symbols: Perfect after His most glorious likeness and image He made to be upright, honest and just, like unto God, return in unison, record pure, without blemish or any such thing. He Created Waters 6977 B. C.: fruits, vegetables, milk and waters, for food, beverages and good.

Twelve Months in One Year, Recorded by 12 Hebrew terminal letters (O) square M, initial of Month: The two perpendicular lines are H, I, J, F, A and R, in Ægyptian: terminus fork is an M, and Greed Δ: 12 Hours one light day: 12 Hours one dark night: See (Vandal acts continued in this day:) God permitted it patiently to teach patience to Us. Seven nights and days one week. (Count shaded) Seventh star point is name Fa=God and Sabbath. Four weeks a fraction, one month, Hebrew square M. Seven light days one week and 7th is God's. Square all your works by the commands of God. Fourteen days and nights are two weeks and two Sabbaths are God's and His mankind line for worship and rest with joyful pure songs. Messiah is Christ and he alone stands the upright Son of God, begot of Mary and Joseph His earthly parents and was of the line of Ham, Shem and Japeth. One Saviour for all who so loved all his brothers and sisters that He gave his life, teachings, sufferings, from persecution, that all might be happy and saved."

Translation: "Christ, the son of Mary and Joseph was born Sat. 10th of Oct. 4376, 11 hour; was born in Heaven, Sunday 10th Ham and Oct. 44 A. D., 21st hour: of the line Nh, Hm, Sm, and Jfth: Ægyptian, Hebrew and Roman descent: Thecla the next oldest child and his sister, the Writer of Sacred Scriptures Annals. THE MARRIAGE OF MARY AND JOSEPH was the 3rd of Animim, and December 4275." IT IS PROVED by Hebrew Old and New Testament: Isaiah, chapter 7, verse 14, and St. Luke, chapter 1, verse 26, translated into the Ægyptian and primitive languages, these into English.

“**D**IEU FA, GOTT, THEOS, ALLAH, DEUS, DIOS, DIA, ALHOM, LORD, (ALL ARE ONE) GOD, MADE TWO GREAT LIGHTS: THE GREATER LIGHT TO RULE THE DAY, AND THE LESSER LIGHT TO RULE

the night: he made the stars also. Set them in their orbits above Wo Man King.

This was the fourth day. Every living creature that moveth, Fifth Day. Woman and man, Sixth Day. God made holy the seventh Sacred Sabbath for Worship of God and gave the Great Seal of it and His Bright Holy Name Fa with the five lines of fifth day of Creation with Dominion to Ava and Adam that Fnr Lamr, the wife of Noah affixeth to Honor God, Remembrance

for all descendants lovingly to keep till Son of God Comes, Their Seal.”

F. Lamr, mother of Ham, Shem, and Japeth, wife of Noah wrote the history of the family saved



PLATE 33

PLATE 32

PL 33

from the Waters nals of God's tion, Religious icles, Ham's line, the Bee, Words as honey from na's Annals from Rolls and Tablets Tree copied by wife from the that drank not fr. of F. Apries

Plate 187. “I, scendant of Ava F Lamr, and Nh, the Lotus Land Ægypt, with fathers and Heavenly Father my Minister and Fna Ramisar to of Oma where family worshiped fore fathers in Holy truth to my king pure Chief Anona that he a Christ, honoring that Commanded Serpent Mound it God, whose



ARAAH GIVES SOLEMN ATTENDANCE TO ONE OF HIS MINISTERS

PLATE 178

tail, forth from Waters of Deluge and Brother Fna Oratota sendeth unto Us love and Pike from his Throne to our Pike, Bow of Heaven our Throne his courteous felicitations and by his right hand affixeth Seal (same on Peter Faneuil Tomb, Old Granary Cemetery) with Theos Christ like love. (Right hand Catouche is of Oratota spelt from top 2 symbols and part of upper third of the Catouche, now read proof within Catouche.) On left is an Ægyptian=Ægyptian symbol and record of battle at or near Dighton Rock, Taunton River, Massachusetts, United States of America. There has been found arrow heads and other evidence of a great battle. Only a very small portion of the wonderful and beautiful Ægyptian language is translated. Ama land destroyed by the flood and ark on it with the four families, count on top of it. The envoy ship to and from Serpent and Lake Pyramid land and Scepter an Ota above, M below.

N. B. The Rosetta Stone is in part, if not all, a forgery.

in An- crea- Chron- busby as sweet



PL. 37 Their Seal

F. Za- God, written on with Ancestral Moses and his pure Ægyptians wine from gt. gr. to Noah.

Fna Rasahu, de- and Adm line of Hm and Anr in of F. Agipt = thirty-eight fore- mothers to my God, sent forth Son of Marrifu, Adn, Lake land Nh and Hm, one God as did my pure spirit and Brother Oratota, of Land of Flood Pike to War for Promise of God to be built the of the Great Spir- Hand led us, the



“R

IGHT BEFORE GOD THE TRINITY AND THE KINGS HE HATH APPOINTED TO RULE JUSTLY.” “I, HONORING GOD THAT HAS BOUNTIFULLY BLESSED OUR TREE OF GENEALOGY AND GIVEN TO ME THIS POWERFUL KINGDOM, AGREEABLE TO

Trinity commands say: Go forth Minister, over the waters where my first parents were created and bring to me the Tablets and Laws of God; the Birdlike beautiful songs taught by the Lord in the Garden of Eden, Noah had; the Golden squares, bring over the Great Waters, Fna Nh brought in Ark, Trinity saved and was with on the waters, saving four families from the Deluge, that destroyed the wicked. God’s upright line Roll Squares bring to me in the Land of the Lotus, to save— Let thy feet hasten, take the Duck Compass, and God of Ancestry be with Thee to and from the Lake Pyramid land that fell. Hasten thy step to bring the Square of Trinity pure to teach my people righteousness that may remove the clouds of displeasure from God’s Face in Ægypt.” (Now read five columns over Head of Ambassador.) “Oratota said;— I in the land of Oma, Gods Pyramid Land, Anonna where the Garden of Eden the Lord expelled Ava and Adam for falling from me and my commands; God’s prayer I taught and gave them before the pure land was sullied from sin. I that drowned the world by water save Ark inhabitants I God with Compass, the best parts, with hand guided to Aarat in answer to prayers of Nh and Lamr: one family to Lotus Land whose seal shall be five pointed Star and Circle: A son, five families of Genealogical Tree to Anona and their Seal a Circle and X or four lines inside and hereafter shall be theirs with the Aegle saith Trinity God, that I giveth to Nh, Hm. Sm and Japh’s descendant Christ who will teach here and over the great waters from the Golden Square, the Mound, Lake Pyramid Land where for men sins I destroyed them, the voice of Christ shall teach all, the Faraoh’s line of beauty, Christs songs of Fa Fo and line of Noah at both sides of the waters, from Pyramid Land my son, at Oregon, at Dighton Rock where He cutteth His Holy name within mine and as a sign shall be seen in the clouds ☩ (and was seen) there fell the deluge, and War drenched the earth with blood of slain with one escape, Fna Orata a great Chieftian King fighteth Agrippa’s son Aegle and square banner from over the waters, Roma’s descendant of religious prayerful Ava’s, A’lm, Nh, Hm, Sm, Jpft, upright men that came from the Garden across the Great waters, where built the Serpent mound of Promise had there the Sacred Squares over the waters from Eden, where Anmand Adr, three lines visited Gardens to Saio and Nachro (Gen 68) at land over waters that God built Pyramid. One Chief Fna The Great Bull that bore the Christ Sq. Commandments, Laws went across the waters to Fra of Agipt.” (This Indian Chief Sombol of Bull is still kept built on Cor. High and Congress Sts., Boston.) “Thus Fra of Aigpt had the Genealogy Tree and God’s promise of Christ coming to the land of Misraim, across the three great waters pouring forth Truths like the sparkling waters from reservoir more pure than the River Nile that refresheth and giveth gladly moving wings of Joy from God to His Children the sons of mankind in Ægypt that had in Misraim Land begun to do evil that Fra would prevent from God Tablets Sqrs. a never ceasing Oceans and Rivers, as Lord spake and Hand sent from mound land over the waters musical truths from Oratota to Ægypt; over half who had fallen by battle and evils; that the son of God Christ, Roll=Oratota may send unto me, the strong Bull Roll to Lotus Land by my Envoy across the Great waters where the Lord spake to Ava, Nh and Lamar at the River Miss. before he left in the Ark, the Land that God destroyed for their diseased evils, and remedy like here. I, Thy son, O King of Ægypt bring from Chieftian King Oratota my Uncle His Signet Ring with his prayers God’s Golden Squares, Tablets, Rolls, nine Commandments given to Ava and Adam, made 4376 B. C. which he had from his fathers three generations of the great OrAToTA. Joy: God has Honored with His Blessings and Safely Guided by Thy Duck Compass God Giveth Thee.”



“A T GRAVE CREEK
OHIO RIVER
180 Trans. “After
Hm, Sm, Jit, family
Pyramid, Omo, An-

and found Agypt, China and all the
the family. To Ava and Adam land
people Land build, Mounds, Worship
seals Nh, Stone. Hm, Afix Sun Seal O
“God Trinity created Women, Man to be
one like God; promised Ava a Son Christ.

be born of Trinity, Mri and Josf. (see Catouche Gen. 68) Their Trans. ‘Vigcis M(agnus) D(ottir) Huilir
Her Glede Guth Sal HeNo Hi 8. Higdiz, Magnu, Daughter, rests here; may God gladden her soul.’ (see 2nd Ed.)

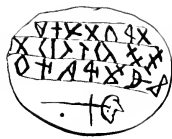

PLATE 180

LARGE MOUND
FOUND.” PL.
fall of Adam Nh,
m. go from lake
ona forth to Araat
earth people with
Nh, Hm returneth
God : sign names,
white on Pl. 179.



PLATE 179

NAMES OF OUR FOREPARENTS IN THE FOLLOWING BIBLE LANGUAGES:

ROMAN CATH- OLIC ENGLISH	PROTESTANT ENGLISH	F. J. A. F. T., 1581 OLD LATIN	1890 MODERN LATIN	1890 GREEK	1819 ITALIAN	1829 SPANISH	1821 PORTUGUESE	1852 IRISH
EVE, ADAM	EVE and ADAM	CHAVAM, ADAM	HEVAM, ADAM	ETAN, ADAM	HEVA, ADAM	HEVA, ADAM	EVA, ADAO	CUBA, ADAM
Seth	Sheth	Setheth	Seth	Σεθ	Set	Seth	Seth	Sec
Enos	Enosh	Enosch	Enos	Ενωθ	Enos	Enos	Enos	Enos
Cainan	Kenan	Kenan	Cainan	Καιναν	Chenan	Kenan	Cainan	Cenan
Mahaleel	Mahaleel	Mahaleel	Mahaleel	Μαχαλεη	Mahaleel	Mahaleel	Malale	Mahaleel
Jared	Jered	Jered	Jared	Ιαρεθ	Iered	Jared	Jared	Iered
Henoch	Henoch	Chanoc	Henoch	Ενωχ	Henoc	Henoch	Agnoch	Henoc
Metusale	Methuselah	Methuschalach	Mathusale	Μαθουσαλα	Metusela	Mathusalem	Mathusale	Metusalah
Lamech	Lamech	Lemec	Lamech	Λαμει	Lamech	Lamech	Lamech	Lamec
Noe	Noah	Noach	Noe	Νωε	Noe	Noe	Noe	Noah
Cham	Ham	Cham	Cham	Χαμ	Cam	Cham	Caio	Ham
Misraim	Mizraim	Mizrajim	Misraim	Μισραιμ	Misraim	Misraim	Misraim	Misraim
Ananiam	Ananiam	Hhauamaeos	Ananiam	Αναναιμ	Anamei	Anameos	Ananiam	Ananiam

1807 GAELIC	1675 FRENCH	1836 GERMAN	1863 POLISH	1899 RUSSIAN	HEBREW LANGUAGE IS FOUND
EUBHA and ADHAMH	EVE, ADAM	HEVA und ADAM	EWE, ADAM	EBY, ADAM'S	יְהוָה אֱלֹהֵינוּ
Set	Seth	Σεθ	Set	СЕТЬ	ישׁוּעָה
Enos	Enos	Ενωθ	Enos	ΕΝΟΣ	יִשְׁמַחֵנוּ
Kenan	Kenan	Καιναν	Kenan	ΚΑΙΝΑΝ	יִצְחָק
Mahaleel	Mahaleel	Μαχαλεη	Mahaleel	ΜΑΧΑΛΕΗΛ	יְהוֹנָתָן
Iered	Jered	Ιαρεθ	Iered	ΙΑΡΕΘ	יִרְרָה
Henoch	Henoch	Ενωχ	Enoch	ΕΝΟΧ	יְחִזְקִיָּה
Metuselah	Methuselah	Μαθουσαλα	Mathusalem	ΜΑΘΟΥΣΑΛ	יִסְתַּחֲשֶׁה
Lamech	Lamech	Λαμει	Lamech	ΛΑΜΕΧ	יִנְבֵךְ
Noah	Noe	Νωε	Noe	ΝΩΕ	יְנֵה
Ham	Cam	Χαμ	Cham	ΧΑΜ	יְחַם
Misraim	Misraim	Μισραιμ	Misraim	ΜΙΣΡΑΙΜ	יְעַצְרֵם
Anamaich	Hananiam	Αναναιμ	Hananima	ΑΝΑΜΕΙΣ	יְעַנְיֵם

OLD ENGLISH	CONSTANTINOPLE	BIBELN	BIBLIA	THE KEY IS FOUND	EGYPTIAN LANGUAGE.
HEUA, ADAM	ΕΒΧ, ΑΛΛΑΜΒ	HEWA, ADAM	HEVA, ADAM	○ - ○	Λ - Δ - Υ
Seth	СЕТЬ	Seth	Seth	- 5 Λ - Α	- 5
Enos	ΕΝΟΣ	Enos	Enos	- 5 ΑΙΟ	- Α - Ο 5
Kenan	ΚΑΙΝΑΝ	Kenan	Kenan	- 5 ΥΑ	- ΙΑ - Ο -
Machalehel	ΜΑΧΑΛΕΗΛ	Mahaleel	Mahaleel	- 5 ΑΣ	- Α - Ο - Α
Jared	ΙΑΡΕΘ	Jared	Jared	- 5 Ο	- Ο - Α - Α
Henoch	ΕΝΟΧ	Henoch	Hanocr	- 5 ΑΟΑ	- Ι - ΟΙ -
Metusalah	ΜΑΘΟΥΣΑΛ	Mathusalah	Mathusalah	- 5 ΟΙ	- Α - Ο - Α - Ο - Α
Lameche	ΛΑΜΕΧ	Lamech	Lamech	- 5 ΑΟ	- Α - Ο - Α
Noah	ΝΩΕ	Noah	Noah	- 5 ΑΥ	- Ι -
Ham	ΧΑΜ	Ham	Ham	- Α - Ο	- Ι -
Misraim	ΜΙΣΡΑΙΜ	Mashaim	Mizraim	- 5 ΑΖΑ	- Α - Ο - Α - Ο - Α
Ananiam	ΑΝΑΜΕΙΣ	Ananiam	Ananiam	- Α - Ο	- Α - Ο - Α - Ο - Α

To keep the Commandments, Laws OF God! Honor our universal parents who cared for us is my pleasant
duty that we may please and benefit truly all posterity; God's Children. Russia fired on our troops at China War.

N. B. IT WAS CLAIMED THAT THE RUSSIAN COPIED FROM A BIBLE WAS NOT CORRECT. I GAVE IT AS I FOUND IT.

“W”HOSE VOICE THEN SHOOK THE EARTH: BUT NOW HE HATH PROMISED, SAYING, YET ONCE MORE I SHAKE NOT THE EARTH ONLY BUT ALSO HEAVEN.” “WISDOM IS TOO HIGH FOR A FOOL: HE OPENS NOT HIS MOUTH IN THE GATE.” “FOLLY IS JOY TO HIM WITHOUT WISDOM:”

THESE ARE PHONETIC NAMES BY THOSE CONVERSANT WITH ÆGYPTIAN.

TABLETS OF ABYDOS	AFRICANUS	SAQQARAH	TURIN PAPYRUS	GREEK	Generation	12, ANM=YNM, married	Fr	Adr	=	⊙-⊙	⊙	⊙	⊙	⊙
Mena	Menes		Mena	Menes										
Teta	Athothia		Atet	Athoth		13,	Tta							
Atota	Kenkenes					14,	Ati							
Ata	Unephes					15,	Atta							
Hesep	Usaphaedus					16,	Hasaftr							
Merba	Miebidia	Merbaipen		Ousarast		17,	Mantha							
Kabeb	Semempes	Kabehu		Miebid		18,	Mars							
	Bieneches					19,	Bianchias							
Butau	Boethus					20,	Afofias							
Kakau	Kaeethos	Kakau		Boeeth		21,	Butan							
Baiouteru	Binothria	Baiouter		Kaioxhos		22,	Kaka							
Utues	Tlas	Utues		Bisoulut		23,	Bainouter							
Senta	Sethenes			Tlas		24,	Utinas							
Tata	Chaeres			Sethes		25,	Sonta							
	Nefercheres	Raneferka				26,	Tata							
	Sesochria	Sekari Neferka	Neferka Sekar	Nefercheres		27,	Nabka							
	Cheneres	Tefa		Sesochrie		28,	Sabas							
		Bubui	Bubu			29,	Tata							
Nebka	Necherophea		Nebka			30,	Satos							
Serbes	Tosorthrus	Ser	Sera			31,	Ranfarka							
Tata	Tyreis	Ser-Teta	Ser-teta	Tyret		32,	Huni							
Setes	Mesochria			Tosop-rasis		33,	Sanafra							
Ranfarka	Soyphis	Ranebka				34,	Khufu							
		Huni	Hu			35,	Rhtataf							
Senefru	Tosertaia			Xhos		36,	Rashaf							
Khufu	Aches, etc.	Khufu				37,	Ramanka							
Ratat-af	Sephuria	Ratatuf		Xhos		38,	Usakaf							
Rashaf	Cerpheres	Rashauf		Mercheros		39,	Rasahu							
Ramanka	Sotis			Mercheros		40,	Ramasar							
Usakaf	Suphis			Serphes		41,	Hamanka							
Rasahu	Suphis II					42,	Rataka							
	Mencheres					43,	Mnas							
	Rbatoeses	Raneferarka		Nefercheres		44,	Tata							
Raenuser	Richeris			Raberes		45,	Ramasi							
	Sebercheres			Mercheros		46,	Mananka							
Harmenka	Taophis		Tat	Tauxhos		47,	Tyrous							
Rataka	Uscheres			Oβrus		48,	Satas							
Unas	Sephres	Unas				49,	Nafakara							
	Nephercheres					50,	Nabhth							
Tata	Suaires	Tota				51,	Hana							
Rameti	Cheres	Pepi		Oβus		52,	Ramankhfs							
Merenta	Rathures			Φιος		53,	Anm							
	Mencheres			Mercheros		54,	Sufis							
	Tancheres			Σ Β.										
	Oonnus, etc.													

THE BEAUTIFUL PERFECT PRIMITIVE LANGUAGE CORRECTS ALL IMPERFECTIONS AND BRINGS THESE VALUABLE RECORDS AND DOCUMENTS INTO UTILITY THAT WE ALL MAY DERIVE THE GREATEST GOOD FROM AND HONOR GOD.

Chapter VII

FOR WE OF THE INTERNATIONAL, UNIVERSAL BROTHERHOOD OF mankind, with grateful hearts, of the Lord and Giver of providence, an liberately and out fraud, vio- of entering into plicit, and solemn each other: and God's United Alliance and Genselves and posteri- imploring His diteresting a design, ordain and estab- ing and following alogy of the NA- Earth: that a been made of honoring the that Deity has He graciously has warded by the eries of long hid- truths, which, or our Creator we bring with

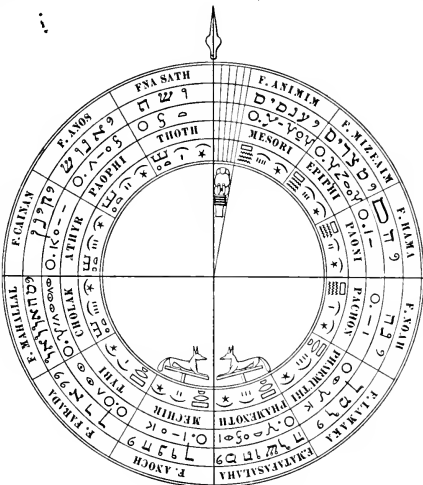

Gen. 45. Calendar of Pna Ramasi, b. 2774, d. 3152: m. Fnr Farna

THIS plate was copied from the Astronomical representations on the ceiling of Ramesseum at Thebes and is Genealogical, Historical, and pre-eminently Religious. The three circular lines are added to the original by the author from one of many careful translations of the fifth line of the circular arranged hieroglyphics showing the symbols that correspond with the Hebrew Letters symbols in Genesis of Hebrew Bible without the points that were a modern interpolation to change and obscure truths. Nine are the remote ancestral names, common forefathers of the 1 411 171 381 Representatives. Most Honorable Consulate of the Lawful Emperors and Empresses, Kings and Queens, Presidents and Governors; by that immense number of people that thus are greatly honored including the Envoys of Russia and Japan to whom was sent the certificate for Peace on Earth and Good Will to all: without bigotry, notwithstanding the Remanent of the World estimated at 138, 128, 619 refused their signatures for the advantage of their people afflicted with the evils that they would not then use their influence to suppress for their great good on earth and blessings in the future immortal Life:—some of that small number in comparison were not represented by Hon. Official Consuls at Boston for extending a helping hand to the union in the greatest good for largest number. The perpendicular pike or spear line at top has the ancient initial letters of God, Ava and Adam: Fig. below monogramic name of Seth and six lines above labor days in a week: large white centre, Sunday: horizontal line dividing into quarters the four seasons and also the Cardinal Points of the Compass, North, South, East and West: and the dogs, two faithful guards for mankind. Nileometre four circle union of men with Trinity.

kind acknowledg- with grateful the goodness perfect Legislat- the universe, in the course of His opportunity, de- peaceably, with- lence, or surprise, an original, ex- compact with of forming a new States and Foreign ealogy for our- ty: and devoutly rection in so in- do agree upon, lish the preced- God given GEN- TIONS of the faithful study has since 1855; for Lawful Rulers, foreordained: and preserved: re- bountiful discov- den, or forgotten herein to hon- and Foreparents, grateful thanks!



R

EMEMBERING ALL WO, MEN, KIND FROM AVA AND ADAM, CREATED BY THEIR FATHER LORD GOD, ARE FREE AND EQUAL, AND HAVE CERTAIN NATURAL, ESSENTIAL, AND UNALIENABLE RIGHTS: AMONG WHICH MAY BE RECKONED THE RIGHT OF ENJOYING AND DEFENDING THEIR LIVES AND LIBERTIES: THAT OF

acquiring, possessing, and protecting property: in fine, that of seeking and obtaining their safety and happiness: free from Cain's beverage, evil acts, that destroyed godly Abel, Adam and Noah's serpentine sins: that Serpent Mound of America and pure religious Ægyptians (Adam with Abel not counted but) recorded Plates 8, 9, 10, 17, 18, 20, 21, 187 chastely delineates national dangers.

- GENERATION No. 2 F. SAJO, da. F. Stalr and F. Masui, son of F. Sana who Wrote the Sacred Scriptures and F. Seth, was b. Sat. 2 Nov. 238, d. Monday 1 July 1201: m. F. ENOS=Anos=Anfs, son of F. St=Seth and F. Sana: b. Tuesday 2 Nov. 235: d. Sat. 5 Apr. 1140: Proof Genesis Chap. V, verse 7, English Bible: They Had Cainan.
- " " 3 FNR NASATA, b. Tu. 25 June 350: d. Wed. 22 May 1229: da. of Fnr Stalr and F. Masui, s. St and Sana: m. FNA CAINAN, s. of Anos, s. St, s. Adam, that was b. Fr. 2 Sept. 325: d. Wed. 1 May 1235: They had as all others have many Synonyms: a few are Fnr Niosiovnnoanaa, Nsyobat, his, Kionn, Sionn, Faonn, Iaonn, etc. (see plates 101-5 from Classic Literature give her name and the proof from Genesis Chap. V, V. 10, Holy Bible, translating Hebrew into Ægyptian language and that into mother tongue; English, which is the one most akin to the ancient primitive language of earth.
- " " 4 Had: Mahallal
FNR LALAR, b. Fr. 1 Oct. 431, da. Fna and Mri, da. Fna and Fah, da. F. Anos and F. Saio: d. Wed. 15 Oct. 1275: m. FNA MAHALLAL=O=F. Mhallal, b. Tu. 10 Dec. 395, son of Fnr Nasata and Fna Cainan, d. Tu. 22 Sept. 1270. This Generation is Proved by the Holy Bible Genesis Chap. V, V. 13 and by Papyrus Prisse, also from Decree of Cyrus the Great of line and Moabite Stone etc.
- " " 5 Had: Farada=Jared
FNR SANTA, da. F. Maris, s F. Das, s. F. Tassa, s. F. Seth and F. Sana, s. F. Ava and F. Adam: b. Fr. 23 July 459 and d. Tu. 21 Oct. 1622: m. FNA JARED=Farada, s. Mahallal, s. Seth, s. Adam: b. Fr. 2 Dec. 460: d. Sun. 11 July 1422: This Generation is proved by The Holy Bible, Gen. Chap. V, V. 16.
- " " 6 Had: Fna Hnok=Enoch:
FNA SARA FAINA, da. F. St and F. Sana; b. Th. 11 Jan. 621, d. Sun. 22 Dec. 1022: m. FNA HNOK, s. Fared=Jared and Santa: This Gen. had prefix Fanar: The Ægyptian symbols of Enoch, b. Sat. 3 Apr. 622: d. Wed. 1 Feb. 987, and Hnok=| - o | < walked with God=⊙ and was not, is fully explanatory. The Holy Bible, Gen. Chap. 1, V. 26.
- " " 7 Had: F. Mtoslh=Merhuselh=Matoslah
FNR SALAH, da. F. St and F. Sana, da. F. Zana and Abal, da. Kanafatatar and Cain, da. F. Ava and F. Adam children of God made from Earth and the waters, was born Sun. 6 Apr. 701: d. Sun. 3 Jan. 1651, m. FNA NIETHUSELAH, b. Tu. 2 Dec. 687: d. Wed. 22 May 1655, he lived 969 years: This proved by Holy Bible, Chap. 1, verse 26 also by the Hebrew and Ægyptian of Genesis Chap. V., verse 22: This Genesis gives her name as Farn Silh; Had: F. Lmk=Lamak=Lamech.
- " " 8 FNR LADAR, da. F. Anos and F. Saio, was b. Fr. 10 Oct. 883; d. Sun. 1 Mar. 1650; m. F. LMK, s. F. Salah and Mtoslh, b. Fr. 21 July 874; d. Tu. 3 Mar. 1651.



GOD GIVETH THE RIGHT TO ALL TO WORSHIP THE SUPREME BEING, THE GREAT CREATOR AND PRESERVER OF UNIVERSAL CREATION IN EVERY ONE OF HIS 170 FOUND NAMES. NO PERSON IN THE

exercise of this duty shall be hurt, molested, or restrained, in his person, liberty, or estate, for worshiping God in the manner and season most agreeable to the dictates of conscience; or for religious profession or sentiments; provided that the public peace is not disturbed, or others are not obstructed in their religious duties and rights, as Deity Commandeth.

FNR LAMR, da. F. Mtosli and F. Salah, b. Th. 1 Dec. 1053; d. Mon. 12 Sept. 1775; m. FNA NOAH = Nh, b. Th. 23 Jan. 1056; d. Th. 13 Oct. 1756. He was the s. of F. Lamech and F. Laalar and progenitor of all mankind.

Plates 192-5-8 of this important era of History were copied from Dr. Samuel G. Morton's types of Mankind, 1855.

Nh, name was erroneously translated Manefru. It is in its Hieroglyphics the Hebrew נח = Nh = Noah and At Royal Berlin Museum, Germany. Plate on right, 193, was copied from Greek, which turned upside down gives F A M, the primitive Alphabet that was written by the hand of God on the Roll He gave to Ava and Adam. This Generation Nine is proved by the Holy Bible, Genesis Chap. V, Verse 30; Papy. Prisse, etc. This Generation Ten had F. HAM, Shem, Japeth, and Daughters and Sons: Nh returned to Omo Land. FNR ANR, da. F. Saio, da. Methuselab, b. 1 May 1535; d. Wed. 15 May 2100; m. FNA HAM = Hm = Hama, s. Nh, b. 12 Sept. 1536; d. Th. 22 March 2010 carried to Omo = Oma, the Country over the Waters far from Egypt, of Beluge, where

Woman and Man first worshiped God the Father and God the Holy One and this Country shall be F. S. A. This is proved by the Holy Bible, Genesis, Chap. V, Verse 32 in last fourteen Hebrew letters, $\Delta \circ \square \square \Delta \circ \square \square \Psi \circ \Delta \circ \square \circ \circ \Delta = \text{א ב ג ד ה ו ז ח ט י כ ל מ נ ס ע פ צ ק ר ש ת}$ when the fourteen are translated into their Egyptian synonymus; had chn.

Plates of 195-6-7 give from symbols on plate the names of Ham, Shem, Japeth and Mizraim with their wives F. SHEM, b. 24 Apr. 1548; m. F. RABAKAR; F. JAPETH, b. 2 May 1530, m. TALAIMAR. GEN. 11th FNR LAZA, da. F. Salah and F. Methuselab, b. Sun 2 May 1635; d. Fr. 6 Jun. 2254; m. FNA MIZRAIM, s. Ham and Anr, b. Th. 3 Jan. 1631; d. Wed. 28 Apr. 2300; These features taken from the Most Ancient Tombs. Copied by author from Dr. S. G. Morton's Type of Mankind; See at Royal Berlin Museum. This Generation is proved by the Holy Bible, Genesis, Chapter X, Verse 6. Papyrus Prisse and Immortal Decree of Cyrus the Great.



PLATE 193



PLATE 192 Fna Noah



Pl. 192A. Noah: House Joseph's Seal?



Gen. No x.

PLATE 194



PLATE 197 Fna Japeth



PLATE 196 Fna Shem



PLATE 195. Fna Ham.



Pl. 195F

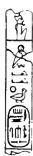

See Chart

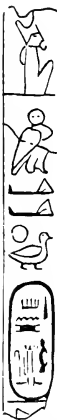

Pl 199 Cap. 9





G F DEITY IS THE HAPPINESS AND PROSPERITY OF NATIONS AND PEOPLE, AND THE GOOD ORDER AND PRESERVATION OF GOVERNMENT ESSENTIALLY DEPENDENT UPON PIETY, RELIGION AND morality: and as these cannot be diffused throughout the world but by worship of God, and instructions, at home, and in public: Therefore THE HAGUE, to promote their

happiness, and to secure the good order and preservation of each individual, should and do have a right to invest their nations with power, and to authorize and require, and the nations shall, from time to time, authorize and require, the towns, cities, governments and nations and other bodies politic, or religious societies, to make suitable provisions, at their own expense for the worship of God, and for

the support and maintenance of teachers of piety, religion, and morality, in all cases where such provisions are not made voluntarily. Every denomination demeaning themselves peaceably, and good subjects of government shall be equally under the protection of the law: nor shall any denomination inflict any punishment except verbal, or written on its members or any other denomination, except by executors of the law in that country, as elected, or appointed, and no subordination of any one sect or denomination, to another, shall ever be established by law.



Plate 203



PLATE 200. ANAMIM FNA.

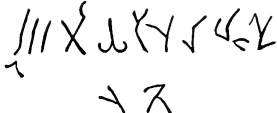

PLATE 201

Plates 199 from Ægypt: 200 at Berlin Museum. 201 was copy of find at New Jersey, U. S. A., and the primitive writing gives Anamim's Genealogy to Ava and Adam the Children of God.

FNR ADR=Adar, da. F. Maf, s. F. Ham, b. Sun. 3 Nov. 1750: d. Wed. 1, Dec.

Plate 202

2160:m.FNA ANM =Ynm=Animim,s. of F. Mizraim and F. Laza, b. Mon. 5 Feb. 1765: d. Tue. 10, Dec. 2175. This Generation is proved by The Holy Bible, Genesis Chapter X, Verse Thirteenth. Inscription says he was named for Lake



PLATE 205. GEN. 13.

GENERATION NO. 12

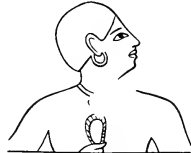

PLATE 204. GEN. 13

Pyramid built by Deity, Oregon, Omo. GEN. 13 FNR. LYRA, da. F. Hm and F. Anr, b. Tu. 13 July 1791: d. Th. 10 June 2300: m. FNA TTA, s. F. Anm and Adr, b. Tu. 1 May 1793: d. Sat. 11 Aug. 2000: This is proved by the Holy Bible, Genesis, Chap. 1, Verse 22: Papyrus Prisse: Decree of Cyrus The Great: He weareth the emblems of the promise of Christ and of God

the Father and God the Holy One whose son is to be born of Mary and Josef as God declared in Anonna, Omo, & She that God promised the great Honor at Omo, Land of Lake Pyramid & Mounds.



DOWN THE FAST FLOWING RIVERS OF TIME, IMMUTABLE, UNCHANGE-
able History to Eternity when mankind shall hunger no more, neither thirst any more: for
the Lord shall feed them, and shall lead them unto bright sparkling living fountains of pure
water.

GEN. 14.



Plate 206. Gen. 14.

FNR MRAI, da. Mizraim and Laza, b. Mon. 6 Jun. 1836; d. Tues. 12 Nov. 2393, C. M., m. FNR ATT, son F. Tra and F. Lyra, b. Tu. 15 Dec. 1829; d. Fr. 1 Oct. 2216; had Atta and sons and das. They engraved the Shell of Creation at 2204, Pl. 2, 4, 5 and both their names are cut on it with Christ coming, time, 4376. See Bureau of Ethnology by U. S. Government on



Plate 207.

"Aborigines" no longer, but American Antedeluvians and descendants; Fur Lamr's name was also found thereon. Tavantisuyu= $\Delta\Delta\Delta$ - Δ SUYU which Spainards call Peru. Its literal meaning is Fur Ava line and Noah, man line after the Flood from Anon, America land of Mounds and Lake Pyramid (See Gens. 13 and 37 with 43.) They peopled Japan: Gens. 14 and 15 father and son were Free Masons

who are mentioned in the Egyptian of first word of Genesis that also Chap. 1, Verse 22, proves these names of Generation No. 14th.

GEN. 15.



Plate 208. Gen. 14.



Plate No. 209. Generation 15

FNR MRA, da. F. Mah and F. Mri, s. F. Mizraim and F. Laza, b. Th. 10 Apr. 1856; d. Th. 21 Aug. 2411; m.



Plate 211.

FNA ATTA, s. F. Att and F. Mrai, b. Th. 3 May 1855; d. Mon. 17 June, 2600; Had Hasafr daughters and sons, At, s. and Fnfr $\Delta\Delta\Delta$ writer of Pentateuch and with $\Delta\Delta$ 2311 date was written by her and $\Delta\Delta$ =Atta that copied from Δ =God's n=Tablet, and their son was a child of God Δ in Δ Lake Land of Pyramid, Oregon, U. S. A., which Government is named on Map Chart that God gave to Ham and Noah: FIVE NATIONS from Noah is recorded with or of Six Families: 1st Fam. TEHAWREHOGEH, now called MOHAWK settled at Shawnatonty, Hudson; they agreed to keep the chain of alliance, and facts, from God,s Tablet of Nh and Lamr and to this day its truth may be seen in the primitive Alphabet of the Mic Mac Indians of Canada; (see pl. 318 of Lord's Prayer in German, Indian and English, from excellent work of Carl Faulman.) They removed travelling toward the Sunset about two days, settled at a creek, (branch of Susquehanna) called CAWNATAW-TERUH, which means, God's written Tablet by Vashatan, it was and is called Pineries. 2nd Fam.



Plate 210. Gen. 15.

CONSTITUTION OF MASSACHUSETTS DECLARETH THAT "GOVERNMENT is instituted for the common good: for the protection, safety, prosperity and happiness of the people; and not for the profit, honor, or private interest of any one man, family, or class of men. Therefore the people alone have an incontestible, unalienable, and indefeasible right to institute government; and to reform, alter, or totally change the same, when their protection, safety, prosperity and happiness require it," which cannot too

quickly be done by placing in each school the Hebrew, Roman Catholic and Protestant Bibles all in one to be read every morning (with Mohammedan for those who want it,) or 39 years continued protection of criminals and alcoholic saloonists unconstitutionally protected in depreciating values of real estates, and all evils vs. citizens, states, governments and lawful Nations.



Plate 213. Gen. 16.



Plate No. 212. Genesis 16.

GEN. 16.

FNR HANAR, b. Sun. 1 Apr. 1883; Th. 10 Jun. 2435, da. F. Mizraim and F. Lada; m. FNA HASAFTR, s. F. Atta and F. Mra, b. Fr. 2 Feb. 1877; d. Sat. 1 May 2429; had chn. Mantha.

This generation is proved by Holy Bible, Genesis Chap. 1, V. 22.

FNA RACHAR, da. Atta and Mrie, b. Th. 3 Aug. 1938; d. Fr. 13 July 2451; m. FNA MANTHA, s. F. Hanar and F. Hasaftr, b. Tu. 6 July 1925; d. Sat. 23 Nov. 2438. Their Tombs at Gizah and a good Pl. 113 in my Oxford Bible. A picture of four Compasses on it for navigation of the waters: Chinese record it as 2634 being used B. C.; had sons and das., Mars.

This is proved by Holy Bible, Gen. I, 22.

FNR FARDAR, da. F. Atta and F. Mra, b. Sat. 2 July 1954; d. Sun. 1 Avg. 2384; m. FNA MARS, s. F. Mantha & F. Rachar, b. Th. 13 Oct. 1954; d. Sat. 11 Dec. 2384. Proof Genesis Chapter 1, Verse 22. Had chn. Fna Bianchus.

Catouche on Pl. restored to No. 215: see Gen. 18, Pl. 218.

FNR LARA, da. F. Hasaftr and Hanar, b. Tu. 29 May 1972; d. Mon. 21 May 2331, m. FNA BIANCHUS, s. F. Mars and F. Farada, b. Fr. 10 Apr. 1980; d. Mon. 19 July 2300. Had chn. Afosis=Aopphis.

This Gen. is proved by the Holy Bible. 2nd INDIAN family, NEHAW-RETAHGO "BIG TREE was directed to make their residence near the Creek:" Egyptian is F. At (t) and F. Mrai came in a boat with his children, hence, ONEIDAS, worshiped (Christ's) Great SPIRIT GOD!



Pl. 215. Gen. 18.



Plate No. 214. Genesis 17.

GEN. 17.



Plate No. 216. Generation 18.

GEN. 18.



Plate No. 219. Generation 19.

GEN. 19.



Pl. 217. Gen. 19.



Plate 218. Gen. 18.



PLATE 221. GEN. 20.

FNR FALAFAR, DA. F. MARS AND F. FARDAR, BORN FR. 3 AUG. 2000; DIED SAT. 5 MAY 2174; m. FNA AFOFSIS=Aphosis s. F. Bianchas and F. Lara, b. Wed. 17 Aug. 2004; d. Sat. 3 Dec. 2200: Had many chn., Fna Butan:

Proved by Tablet of Abydus, Papyrus Prisse, and Genesis, chapter 1, verse 22. His Catouche records the Mariner Compass and Annona, Oma

FNR FORA, da. F. Mars and Fardar, b. 10 May 2038; d. 4 Aug. 2254; m. FNA BUTAN, s. of Afofsis=Aphosis, b. 5 Dec. 2032; d. 1 May 2352: Had das. and sons: Kaka: This Gen. proven by Holy Bible, Gen. 1:

22, etc. FNR RAFA, da. F. Far and Fnr Rana, s. Bianchas and Fnr Lara, b. 7 May 2068; d. 10 May 2404; m. FNA KAKA, s. F. Butan and F. Fora, b. 10 Aug. 2062; d. 2 June 2351: Had chn. F. Bainuter: et als.

This is proved by Genesis 1:22. Tablet of Abydus at British Museum, Papyrus Prisse, Paris National Library and Decree of Cyrus the Great.

FNR RAFAR, da. Fah and wife Rala, s. F. Bianchas and F. Lara, b. 7 May 2086; d. 1 May 2342, m., (the Great Ocean by Compass Navigator,)

FNA BAINUTER, s. F. Kaka and F. Rafa, b. 9 Aug. 2085; d. 6 Sept. 2502: Had chn. numerous and illustrious: Fna Utnas; and FNR SARAH, m. ABRA HAM the progenitor of worthy Hebrews. She was born 2 Dec. 2119. This is

amply proved removing the not nice charges against great and beloved godly Abraham the father of Isaac. See Plate 128. Proof, and from THIS Catouche,

Bible, Papyrus,, etc.- By counting eight symbols or hieroglyphics on third line from top of Payprus Prisse reading from left to right you will find the name of Fna Bainuter and it says in the next four compound monograms that Sarai=Sarah was the daughter of said PHARAOH=HARAN=FARAN, etc. married the great ABRAHAM, and ISAAC born of said wedlock.



Plate 222 Gen. 21



Plate 227. Gen. 23.



PLATE 220
GEN. 20

21



PLATE 223. GEN. 21.

22



PLATE 225. GEN. 22.

23

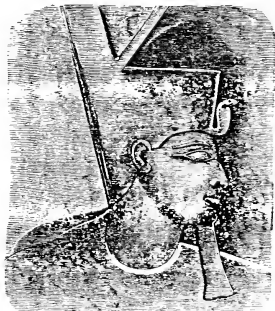

Plate 226 Gen. 23 Names spelled in Primitive Language



PLATE 226
GEN. 22

These Catouches and Monogrammic Faces spell the names of themselves and wives in primitive languages and more.

UNDERSTANDING IS A WELL SPRING OF LIFE UNTO HIM THAT HATH IT: BUT THE INSTRUCTION OF FOOLS IS FOLLY. GET WISDOM, GET UNDERSTANDING: FORGET IT NOT: WISDOM IS THE PRINCIPAL thing: therefore get wisdom: and with all thy getting, get understanding.

GENERATION 24 F. NAO-
 F. Falafa,
 Dec. 2414:
 Bainuter
 May 2114:
 Santa:



Plate 230. Gen. 24.

Much monogrammic history is on these Catouches, & on faces to which the Primitive Alphabet, language is the key.

25 F. N R
 & F. Fal-
 Jun. 2340:
 F. Utnas
 Jan. 2152:
 Fna Tata:

26 F. ARTA,
 Falafa, b.
 2394: m.
 and F.
 4 Dec.
 14 Dec.
 Had chn.

As all this nealogy is am-the Holy Bircree of Cyrus Prisse it is for it is given unlocks the historical "Third FAMILICAN IN- directed to home, by the Heaven, Lord God of mountain daga, which is O-A- $\text{\textcircled{A}}$ A Ac (or F or G) Land of Noah Fnf Anon,

Family was named Seuhnokahthah: their company continued their journey towards the sun setting in the West.

Fourth Family was told to make their residence at Lake Goyogoh $\text{\textcircled{O}}\text{\textcircled{V}}\text{\textcircled{O}}\text{\textcircled{O}}$ that they call a "Mountain rising from the waters," which describes the Pyramid Lake at Oregon. It is now called Cayuja, $\text{\textcircled{C}}\text{\textcircled{A}}\text{\textcircled{Y}}\text{\textcircled{U}}\text{\textcircled{J}}\text{\textcircled{A}}$ which is only a proper philological change in beautiful primitive language. This family called their name SHONEAWETO—WAH= $\text{\textcircled{O}}$ $\text{\textcircled{I}}$ $\text{\textcircled{O}}$ $\text{\textcircled{D}}$ $\text{\textcircled{A}}$ $\text{\textcircled{V}}$ $\text{\textcircled{V}}$ $\text{\textcircled{D}}$ $\text{\textcircled{O}}$ $\text{\textcircled{V}}$ $\text{\textcircled{D}}$ = God's fallen Nh was from wine, Noah was lustful and fell from God of heaven, he the line of beauty from which should come Christ the son of man and woman, and son from God of Heaven.



PLATE 228. GEN. 24.



PLATE 229. GEN. 25.

MI, da. F. Afosis and b. 10 Oct. 2109: d. 20 m. F. UTNAS, s. F. and F. Rafar, b. 22 d. 3 Jan. 2562: Had

MUTO da. F. Afosis afa, b. 9 July 2158: d. 8 m. FNA SANTA, s. and F. Naomi, b. 5 d. 2 May, 2310: Had sons and das.

da. F. Afosis and F. 20 Dec. 2192: d. 3 Jan. F. TATA, s. F. Santa Muto, b. 2184: d. 2494:



Plate 231. Gen. 25

line of Gely proved by ble, and De- and Payprus vain to repeat with key that storehouse of Truths.

ily of AMER- DIANS Was make their Holder of which means All, on a called Onan- in Egyptian translated: At an or Adan Fnf at Eden O mo: the

NOW WISDOM RESTETH IN THE HEART OF HIM THAT HATH UNDERSTANDING, THE KING'S FAVOR IS TOWARD A WISE SERVANT, FOR RIGHTEOUSNESS EXALTETH A NATION: EVIL IS A REPROACH TO ANY PEOPLE THAT CAUSETH SHAME, WHICH BEING KNOWN, FOOLS EMBRACE, THE WISE DO SHUN IT.

GENERATION No. 26.

No. 27.

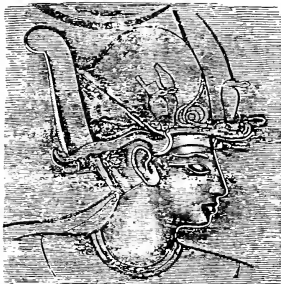

Plate 232. Generation 26. FNA TATA.

No. 28.



Plate 233. Gen. 26.

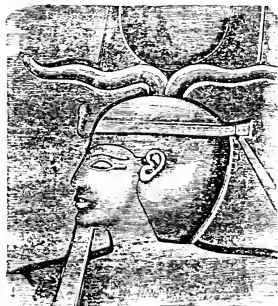

Plate 234. Generation 27. FNA NABKA.

FNR ARTA, da. F. Afosis and Falafa, b. 20 Dec. 2192: d. 3 Jan. 2394: m. FNA TATA, s. F. Santa and F. Muto, b. 4 Dec. 2184: d. 14 Dec. 2494: Had Nabka: das., sons.

FNR AFANAR, da. F. Kaka and F. Rafa, b. 1 Jun. 2214: d. 3 Apr. 2424: m. FNA NABKA s. F. Tata and F. Arta, b. 15 Aug. 2214: d. 12 Sept. 2530: Had Sabas: sons and das.

FNR MARON, d. F. Vana & F. Afra, s. F. Kaka and F. Rafa, b. 23 Apr. 2251: d. 4 Nov. 2384: m. FNASABAS, b. 1 Jan. 2242: d. 1 Jun. 2562: s. F. Nabka and F. Af Anar: Had F. Tata: das. and sons.



Plate 235. Gen. 27.

AMERICAN INDIAN FAMILY. NUMBER FIVE!

Was to make their home near to high Nole Lake Canandaigua 1, that was named TEIMEA-ATAWAKE 2, & the family was named TE-HAWNEAMAHENT 3, = primitive languages: 1. €Δ-Δ-ωΔ | €ωΔ2, ωΔ | ψΔΔΔΔΔΔΔΔ ΔΔ€ 3, ωΔ | ΔΔΔ-ΔΔΔΔ | Δ-ω. Names translated are "God

wrote the Tablet of Heaven: God's women and men wrote and engraved the line of fallen women and men of God's Heaven who fell from God into a pit: God's line that begot children from the first that God created pure and Holy in his likeness that did evil at Anona, Omo that fell after Noah's godly teachings for the line of Earth and waters for Heaven and God taught and meted out equal justice in accordance with the deeds done, blessing and rewarding the pure and good, punishing the evil who by wrong acts also punish in a great degree themselves: but fully it shall at the great day of perfect God judgement be rendered unto each in exact proportion to the merits of their acts.

“THE SEVENTH FROM ADAM, ENOCH PROPHET SAID: BEHOLD, the Lord cometh with ten thousand of his saints, to execute judgement upon all, and to convince all that the ungodly among them of all their ungodly deeds which they have ungodly committed, and of their hard speeches which ungodly sinners have spoken against Him.” Jude, verses 14 in part and 15.

GENERATION 29 FNR ALOA, da. F. Naomi, b. 29 August TATA II s. F. 7 May 2614; Had,



Ramaf and F. Ala, s. F. Utnas and F. 2282; d. 4 Sept. 2652; m. FNA Sabas & F. Maron, b. 8 Dec. 2282; d. Satos, Sons and Daughters.

GENERATION 30 FNR FALAMAR, Anta, b. 1 Feb. 2310; s. F. Tata II and F. Had; Ramfarka;

da. F. Almo, s. F. Tata and F. d. 30 May 2650; m. FNA SATOS, ALA, b. 1 Jan. 2314; d. 1 Feb. 2614; sons and das.

“ American Indians:

and was called KAU toward mid-came to a “O U A U W- the Mississip- discovered a and part went and those who

THE them to The Arrow people is Alphabet in their lan- name of the God is the prim- the inverted A or Δ in the God gave to den of Eden. facts were lost ages when the come by the warlike peo- strength was greatest honor troy the image who He Hon- them His

Plate 237. Gen. 28. F. Sabas

Sixth Family Went toward Sunsetting HAGIVANAHACAP celebrated then

day Sunsetting between, & large River that was named, EYOKA”, that is called now pi. (Tradition). The people grape vine across the River over on it: the vine broke remained became their foes. GREAT SPIRIT taught make Bows and arrows Head of the Babylon copied in their Letter symbols and is guage the which in its A itive was FA & V primitive three symbols Ava in the Gar- Many of these during the dark world was over- fanatic ignorant, ple, that in brute then it, as their and glory to des- of God in those ored by calling Children.



Gen. 29. PLATE 236. F. NATA II.



Gen. 30. PLATE 239. FNA SATOS.



P_A T E 236 Gen. 29



PLATE 230. Gen. 30



PLATE 238. Gen. 28.

“REMEMBER! FOR THE EARTH SHALL BE FILLED WITH THE KNOWLEDGE OF THE GLORY OF THE LORD, AS THE WATERS THAT COVER THE SEA. BEHOLD ME AMONG THE HEATHEN, and regard, and wonder marvelously: for I will work a work in your days, which ye will not believe, though it be told you.”

GENERATION XXXI FNR A-Santa & F. 2340: d. 30 RAMFA-F. Falamar, Jan. 2662:

32 FNR TAF. Nabka Feb. 2383: FNA HUF. Afr, b.1 2644: Had

33 FNR FAF. Nabka& 2400: d. 10 SANAFRA, s. F. Hu-3 Jan. 2404: d. 3 Nov. sons and daughters.

34 FNR MATHAR, da. F. Maron, b. 10, Oct. 2614: m. FNA KH-& F. Tarta, b. 2 Mar. 2694: Had: Ratataf:

AMERICAN Indians (tinued) Part went or Sunrise and touched Great River and were their residence at Cannon called Nuse River Although language eration: the six Fam- language. The Holder The Great Spirit re- and forms a confeder- NEH "A LONG ΔΔΔΔΔ-ΔΔΔΔΔ increasing in (years.) ages in the country. by KONEARAU- of the sixth Family the River when the the Tribe Arau n. serpent came and in- the defeat of first on the waters by foe. Necessitating the Five Families: nology, U.S.A. Hist-



PLATE 231. GEN. 31. FNR AFR.

FR, da. F. Mar, s.F. Muto b. 30 May, May 2674: m. FNA RKA, s. F. Satosand b. 9 Aug. 2340: d. 7 Had Huni: s. & das.

TAR, da. F. Noa, s. and F. Af Anr, b. I d. 1 May 2612: m. NI, s. F. Ramfarka& Oct. 2384:d.21 Sept. Sanafra, sons & das.

TAR, da. F. Noa, s. F. Af Anr, b. 2 Apr. Feb. 2553: m. FNA

n i& F. Tartar. b. 2605: Had: Khufu

Mna, s. F. Sabas & 2442: d. 23 July U'FU, s. F. Sanafra 2432: d. 2 July sons and das.

Sixth Family (con- moved toward the the Banks of the directed to make tanoh=Pine-in-water in North Carolina. changing every gen- lies did not loose their of Heaven, God, turns to the Families PI 235 Gen. 32 acy GONEA-SEAB- HOUSE." = ⚡-ε

Five Families Winters made Vill- They were Invaded NEH The company which failed to cross vine broke formed The (men) Lake vaded them after Hamites, coming boat, a dreadful Fortifications by etc. Bureau of Eth- ory.



PLATE 232 GEN. 31 FNA HUNI



PLATE 237. GEN. 33



PLATE 238. GEN. 34



PI 235 Gen. 32



PI 236 Gen. 34



Plate 232. Gen. 31.



Plate 237. Gen. 33.

UET INDIAN TRADITIONS of America and their value cannot be understood without the Wisdom accumulated from great ancestry who was taught by the only perfect teacher God and environment degenerated: their descendants have kept the indestructible, though hid by growth that are indeed the off the stupendous breasts of fanatic evils.

35 FNR FAMMR, F. Tatar, b. 1 FNR RATAAR, b. 23 Mar. Rashaf: das. and



Plate 239. Gen. 35.

da. F. Tatar and s. F. Huni and July 2456: d. 1 May 2652: m. TAF, s. F. Khufu and F. Math-2452: d. 11 Aug. 2634: Had: sons.

36 FNR MARLO-Tatar, b. 21 May RASHAF, F. Famma, d. 23 Jun. das. Raza who MOSES of her the its mysteries the Serpent of the comthe Mighty ing of the tian Phaevil that kind for The botfigure caise of God Heavenand should be and Japeth, line is recordthe TWO and distinct, with the lanMOSES truthfully the of God, but changes from translation of mankind.



Plate 242 Gen. 35



Plate 244 Gen. 37

37 FNR BUNand F. MarNov. 2774: m. Rashaf and F. 12 Sept. 2744: Atorn. F. RaVide Gen. 14 Dictionary of F. M.



Plate 240. Generation 36

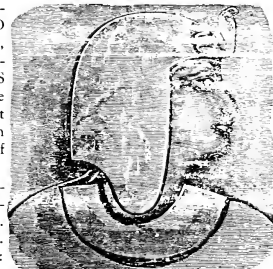

Plate 245. Gen. 37 FNA RAMANKA

NA, da. Fna, s. F. Huni and F. 2472: d. 12 July 2722: m. FNR s. F. Ratafat and b. 6 Jan. 2482: 2662: Had s. & manka: da. Loisaved the great that was learned Annals of Ægypt even the wearing of God's promise ing of CHRIST KING and warnreligious Ægyptroahs against the punished mancom mitting. tom, Gen. 36, touche is a promthat came from said his son born of line Nh, Hm, Sm, and on Papyrus Prisse ninth ed the same before, and on TABLETS that is very clear even to those not conversant guages of the present day. THE HEBREW wrote Sacred Scriptures and Annals from loss of language and points are the lamentable one Christ for one part of



Plate 243 Gen. 36

ALA, da. Fna, s. F. Khufu tha, b. 9 Jun. 2536: d. 17 FNA RAMANKA, s. F. Marlona, b. 23 Dec. 2530: d. Had: Usakaf: Atotar fr. manka: was a Free Mason: & pl. 246 Cyclopedia &

Chapter VIII

SOVEREIGN STATE JUSTICE.

Generation No. 38.

FNR MARION,
Mar. 2560, d. 21
F. Ramanka and
May 2744: Had



Plate 322. Gen. 38. FNA USAKAF.

Bigotry has no head, cannot feel—when she pauses it is in the midst of god is a demon—her is eternity—her decalogue victims—and if she stops infernal flight, it is upon what her vulture fang and replume her wing desolation.



Plate No. 397.
Gen. 38.

39. FNR MARRIFU
Khufu and F. Matha,
Nov. 2814: m. FNA
Aug. 2582: d. 16
Ramisar: sons and



Plate 323. Gen. 39. FNA RASAHU.

The drafts which on posterity, although be honored as soon as to be paid with commend.



Plate No. 325.
Gen. 38.

40. FNR FARNA,
Ramanka and P. Bud.
d. 1 Mar. 2814: m. FNA RAM-
d. 10 July 2834: Had Harmanka:

Even human knowledge is per- in some degree, and on certain oc- pure and primary source: and this more conspicuous than when it means of producing its opposite



Plate 324. Gen. 40. F. RAM ISAR.

EQUALITY, IMPARTIAL

da. F. Sanafra and F. Fata, b. 1 May 2814: m. FNA USAKAF, s. F. Bunala, b. 23 July 2562: d. 22 Rasahu: das. and sons.

and cannot think—no heart, and moves it is in wrath—when she ruin—her prayers are curses—her communion is death—her revenge is written in the blood of her for a moment in her a kindred rock, to for keener rapine, for a more sanguinary

da. F. Marlan, s. F. b. 2 April 2590: d. 3 RASAHU, b. 15 Aug. 2804: Had daughters.

true genius draws up—they may not always they are due, are sure pound interest in the

man, if poor, should spection: for her beauty poverty herself.

da. F. Rashaf, son F. nala, b. 5 Nov. 2616: SAR, b. 9 Aug. 2610: sons and daughters.

mitted to approximate casions, to Deity, its assimilation is never converts evil into the good.



Plate No. 326.
Generation 39.



Plate No. 327.
Gen. 40.

THROUGH DE-
RATED HIM-
MEDDLETH

Gen. 41 FNR MU-
rifu and F.
2900, m. F.
4 Aug. 2882:

The day is past when
antiquity, reverence: or
of the most bold and
in the midst of us, yet
mistake error for truth.



Plate 329. Gen. 41. HARMANKA

SIRE A MAN, HAVING SEPA-
SELF, SEEKETH AND INTER-
WITH ALL WISDOM." Selah!

SAR, da. F. Ramanka, s. F. Mar-
Rasahu, b. 5 Sept. 2652: d. 1 Apr.
HARMANKA, b. 9 Oct. 2642: d.
Had: Ratatka: daughters and sons.

custom could procure acquiescence:
power, obedience to error: and that
dangerous kind, has her worshipers,
is simply and solely because they

Gen. 42 FNR
and F.
d. 26
KA, b.
H a d

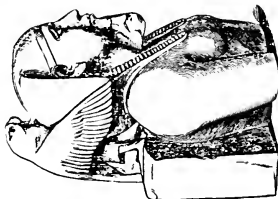

Plate 329. Gen. 42. FNA RATATKA

FRANCASA, da. F. Usakaf
Marion, b. 1 May 2684:
Jun. 2864: m. F. RATAT-
1 Apr. 2684: d. 7 Aug. 2932:
Mnas: sons and daughters.

GOD'S gift ft.
Roll to AVA &
ADAM. Az-
tectes Rec-
ord of one
Gift of God
7 days in a
week, to la-
bor and wor-
ship God, teaching children the
same.

Pl. 330 A



Pl. 330 B

Pl. 332
Gen. 41



Pl. 333
Gen. 42



Pl. 333
Gen. 42



Pl. 334
Gen. 43

Gen. 43 F. HUL-
Rasahu and
2720: d. 10
MNAS, b. 1
3100: Had:
founder of
and founder
names were
O O O - or
! O -. (See
Trans. Noa
God people



Plate 339. Gen. 43.

DA, da. F. Rashu, s.
F. Marrifu, b. 1 Oct.
Aug. 2952: m. FNA
Nov. 2714: d. 1 Jan.
T a t a: O P Δ O - t h e
Germany: Italy: Peru
of Japan whose ancient
Dai Nippon Δ Δ | - |
Dia Nihon = Δ | Δ - |
Gen. No. 14) O P Δ O -
(h) F = Family O = of
of the world. s. & das.



Pl. 335.
Gen. 43

Gen. 44 FNR FU-
and F. Far-
4 Jun. 2900,
b. 4 Feb.
Had: Ra-



Plate 331. Gen. 44.

NAR, da. F. Ramisar
na, b. 1 Jun. 2744: d.
m. FNA TATA III,
2744: d. 22 Dec. 3030:
misi: das. and sons.

selves as they ought,
well disciplined.
passions, is of all con-
ous.
advice, but they can-
make a right use of it.
always the principal

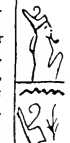

Pl. 336
Gen. 44

Did man govern them-
the world would be
To triumph over our
quests the most glori-
Men may give good
not give the sense to
Men of principle are
men.

Pl. 334
Gen. 43

Pl. 336
Gen. 44

A

DIVINE SENTENCE IS IN THE LIPS OF THE KING HIS MOUTH
TRANSGRESSETH IN JUDGMENT, WRONGING SELF AND PEOPLE!!

Wicked Judge taketh a gift out of the bosom to pervert the ways of judgment. C. Hall, B.

Generation 45 F. FAR-
b. 1 May
MASI, b.
Mananra :



Plate 337A son Gen. 45
Gen. 46 M. G. S. Papph

All fools
Diminish
of force.
God, but



Pl. 337. Gen. 45. F. RAMASI

NA, da. F. Harmanka and F. Musar,
2784: d. 20 May 3152: m. FNR RA-
1 Aug. 2774: d. 20 May 3152: Had:
das. and sons.

are not knaves, but all knaves are fools.
principle, and you increase the need
The beginning of wisdom is to fear
the end of it is to love him.

Gen. 46 F. FAFUR,
Francasa, b. 2
3184, m. FNA
3100: d. 11 Ju-



Plate 341.
Gen. 45.

The spirit of liberty is
imagine, a jealousy of
but a respect for the
unwillingness that any
low, should be wronged
foot.

" 47 F N R
Mnas and
and F.
3120: d. 3
FNA TY
3130: d. 1
Satas das.



Pl. 338. Gen. 46. F. MANANRA

da, F. Ratatka and F.
May 3106: d. 5 May
MANANRA, b. 23 Apr.
ly 3152: Had: Tyrous.

not merely, as multitudes
our own particular rights,
rights of others, and an
man, whether high or
and be trampled under

FRNA, da. F.
F. Hafr, s. F. Mnas
Hulda, b. 30 Aug.
May 3194, m.
ROUS, b. 1 Jan.
July 3204: Had:
and sons.

man is a little heav-
earth, where the
with unrivaled in-

The breast of a good
en commencing on
Deity sits enthroned
fluence.

" 48 F. LNAR,
ra, s. F. Ta-
Aug. 3154:
SATAS, b. 5
3234: Had:



Plate 339. Gen. 47. F. FRNA

da. F. Fata and F. Ma-
ta and F. Funar, b. 1
d. 9 Aug. 3240, m. F.
Jan. 3152: d. 2 Jun.
Nafakara das. and sons.

Bible Scriptures furnish
rules of life. They in-
we came, and where
we may avoid the great-
the greatest happiness;
to annihilation but to
Creator, participating
Woo beauty of mind, not the face.

The holy Primitive
us the most perfect
form us from whence
we are to return, how
est miseries and secure
that we are not destined
immortal life with our
in celestial satisfying eternal joys and inconceivable perfect bliss.



Plate 340. Gen. 48. F. LNAR



Plate 343.
Gen. 47.



Plate 344.
Gen. 48.



Plate 342.
Gen. 46.

in celestial satisfying eternal joys and inconceivable perfect bliss.

“**T**RULY MY SOUL
HIM COMETH
REFUGE FOR
all things for him-
day of evil.”

GENERATION No. 49. F. BATHA,
and Fnr
3 23 2, m.
d. 4 Feb.



Plate No. 350
Generation 49.

Restsatisfied
talk about
with all
among a

GEN. 50. F. BITHIA
anra and F.
3258; m. F.
Sept. 3252:

Hear no
enemy. Be-
you believe.

GEN. 51. F. NAAN-
Satas and
3230; d. 6
HANA, b.
Sept. 3272:

Deliberate
do but once.

GEN. 52. F. MAHA-
fras, s. F.
a, b. 2 July
m. F. RA-
Aug. 3252:
Ann II.
Sell not vir-

Plate No. 351.
Generation 50



Carouche of FNA
ANM. Also spelled
here Anym and Ani-
min.

GEN. 53. F. HAZ-
F. Nafakara
3282; d. 7
ANM, II, b.
3334; Had
Forget othe-
ber thyown.



Plate 345. Generation 49.



Plate 346. Generation 50.



Plate 347. Generation 51.



Plate 348. Generation 52.



Plate 349. Generation 53.

WAITETH UPON GOD: FROM
MY SALVATION. GOD IS A
US. THE LORD HATH MADE
self: yea, even the wicked for the

da. Farnal and Fura, s. F. Tyrous
Frna, b. 3 June 3168; d. 3 Aug.
F. NAFAKARA, b. 8 Sept. 3172:
3362: Had Nabkth: sons and das.

with doing well, and leave others to
you as they please. Live in peace
men: and have but one counsellor
thousand.

da. F. Tyrous and son of F. Man-
Fafur, b. 20 Jun. 3200; d. 30 Mar.
NABKTH, b. 5 Sept. 3202; d. 21
Had Hana: sons and daughters.

ill of a friend, nor speak any of an
lieve not all you hear, nor report all

AH, da. Tyrous, s. F.
F. Lnar, b. 20 Jun.
Nov. 3284, m. FNA
3 Sept. 3232; d. 10
Had Ramankhfa.

long on what you can

TAVAL, da. F. Va-
Nafakara and F. Bath-
3252; d. 1 Mar. 3290:
MANKHFA, b. 9
d. 24 Dec. 3304: Had
tue to purchase wealth.

ZALAL, da. Vafras, s.
and F. Batha, b. 2 July
Oct. 3334; m. FNA
1 Feb. 3280; d. 3 Apr.
Sufis: das. and sons.
er's faults, and remem-

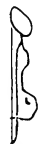

Plate 352.
Generation 51.



Plate 353.
Generation 52



Plate 354
Generation 53.

FVIL MEN UNDERSTAND NOT JUDGMENT: PUT THEY THAT SEEK THE LORD UNDERSTAND ALL THINGS. THE THING THAT HATH BEEN, IT IS THAT WHICH SHALL BE: AND THAT WHICH IS DONE IS THAT WHICH SHALL BE DONE: AND THERE IS NO NEW THING UNDER THE SUN.

GENERATION No. 54. FNA AN-Satas and 3393: m. Apr. 3354:

Approve and win all

Do nothing row. Use



Plate 355. Generation 54

GEN. 55. F. AAG-nius, son F. b. 1 Apr. m. F. MIZ-3322: d. 6 hark: d. a. Solomon, s. da. Ammiel OTA, I. s. of C. (See Pl. Formed an omon and Anhury.



Plate 356. Generation 55.

GEN. 56. F. HAL-ARH, da. Fana, s. F. Hana and F. Noanah, b. 6 Dec. 3350: d. 15 Oct. 3434: m. FNA S H I S - HARK, b. 8 Jan. 3352 d. 2 Oct. 3424: Had Tachnatis.



Plate 357. Gen. 56.

GEN. 57. F. BARU, da. Fohi, s. F. Ann & F. Hazzalal b. 6 Jun. 3370: d. 5 Jan. 3442: m. FNA T A C H - NAT I S , b. 21 Feb. 3375: d. 22 Oct. 3430: Had Bocc-haris: Nasa.



Plate 358. Generation 57.

ANNAAH, da. A. C. Funis, s. F. F. Lnar, b. 11 Oct. 3302: d. 1 July FNA. SUFIS, h. 1 Jan. 3302: d. 22 Had MIZRAM II:

yourself to wise men by your virtue, the rest by your civilities.

to-day that you will repent of to-mor-temporal things, but desire eternal.

LAHA, da. A. C. Fur-Nabkth and F. Bathia, 3320: d. 2 May 3384: RAM II, b. 1 Apr. Oct. 3404: Had Shis-Hano, b. 3337, m. king David, b. of Bath Shua, (Chron. 111, 5: O RAT Yatonwater, b. 1071 B. 113) sent to Solomon: Alliance with king Sol-married his daughter

Proof is here, and Serpent Mound Adams Co., O., and Lake Pyramid, Ore. Indian Anbury. Great O = sun = son = Chief.

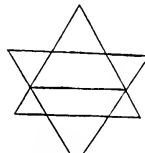

shield of David the seal of Solomon.

It spells OMA and AMARICA.

See ACTS XXVIII for Mariner Compass, at Verse 13, and the Plate of the Chinese Compass, dated 1010 B. C., with the Names of GOD: King Solomon and Hiram of Tyre thereon: With hieroglyphic Chinese letters that they say, after demonstrating that part of their earliest language is lost, or forgotten, contains the numerals from one to twenty-four. The primitive language fully gives the meaning of all the present and future languages of this planet earth. CHRIST spoke and chiselled it on Dighton and Maine Rocks.



Pl. 362. Gen. 55.



Pl. 363. Gen. 56.



Pl. 364. Gen. 57.



Plate 351. Gen. 53.



Plate 360. Geo. 53.



Plate 361. Geo. 54.

“AND SOLOMON THE STRENGTHENED GOD WAS WITH fied him exceedingly. brought out of Ægypt: Tyre, King, for a skilful man to work in purple, crimson, blue, to engrave:— an expert. . . .

Generation 58 FNR AR- F. Aaglaha, b. 7 Aug. FNA BOCCHARIS, b had Osarkon das. and Take heed of whom

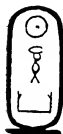

Pl. 370. Gen. 58.

Generation 59 FNR Anm and F. Farna, b. 1 m. FNA OSARKON, b. had Si Hasi das. and sons.



Pl. 371. Gen. 59.

The laws of God are Philip II of Spain, said lenge any other two.

Generation 60 FNR and F. Halarh, b. 5 May FNA SI HASI, b. 1 Jan. Orsakon sons and das.



Pl. 372. Gen. 60.

The ruins of time are In times of peace pre-

Generation 61 FNR F. Tachnatis and (see seal) Aug. 3520, m. FNA OR- 6 Jan. 3520; had Namrut.



Pl. 373. Gen. 61.

Of all prodigality, that

Generation 62 FNR charis and F. Arlina, b. 13 m. FNA NAMRUT, b. 1 had Takalut.



Pl. 374. Gen. 62.

It is with our time, as band makes a little go a

Records found of bur- Washintona= Δ O Ψ Δ ancient Ægyptian Tomb tota with many Generations America. (See p. 838 of V, 1855, on Ethnology., as spelt ATTOTARHO invades the kingdom or by Ψ O □. Δ=Anona,



Plate 365. Gen. 58.



Plate 366. Gen. 59.



Plate 367. Gen. 60.



Plate 368. Gen. 61.



Plate 369. Gen. 62.

SON OF DAVID WAS IN HIS KINGDOM FOR HIM AND MAGNI- And Solomon had horses sent to Hiram=Hiram of in gold, silver, brass, iron and went son da. of Dan Cunning

LINA, da. F. Mizraim and 3392; d. 1 May 3450; m. 30 Mar. 3394; d. 6 Mar. 3494 sons.

you speak, and to whom.

RIUA, da. F. Anm son of F. Nov. 3403, d. 31 July 3511; 1 May 3412; d. 12 Jun. 3511;

immutable and unchangeable. thus: time and I will chal- Catouche Gen.59, Spell OHIO.

SARAHO, da. F. Shishark 3426; d. 6 Aug. 3520; m. 3432; d. 13 Oct. 3512; had

the monuments of mortality. pare for war till the millenium.

VASHATANA, da. Nasa, s. F. Baru, b. 9 Jan. 3450; d. 2 SAKON, b. 1 May 3452; d. sons and daughters.

of time is the worst.

ARKONA, da. F. Bocchar- Mar. 3472; d. 11 Jan. 3550; Sept. 3472; d. 7 Feb. 3552;

with our estates, a good hus- great way.

ial of ATATONWATEA= B. C. 829 Nov. 10 & on the face in ancient symbols Oha- of the Indian Tribes of Omo= Schoolcrafts Gov. work Part The name is also there found II. The SIXTH NATION territory of the 5th as shown O=Omo=America, U. S. A.

NOW THEREFORE, OUR GOD, WE THANK THEE, AND PRAISE THY GLORIOUS, NAME FOR JUSTICE.

Gen. 63 F. MUTTA,
Jan. 3494: d.
LUT, b. 2
Shamkon:



Plate 374. Gen. 63.

da. F. Boccharis and F. Arlina, b. 1
10 Mar. 3560: m. FNA TAKA-
Sept. 3495: d. 7 Feb. 3573: Had:
sons and daughters.

dees, of all men are the most unhap-
alone.

LA, da. KARLA, s. F. Osakon and
Jan. 3525: d. 23 Apr. 3572: m. F.
b. 2 Jan. 3520: d. 11 Oct. 3573:
sass: das. and sons.

man to be in his right mind, repeats
of religion.

LAH, da. F. Si Hasi and F. Sara-
Tubal Cain, b. 8 Mar. 3552: d. 4
m. FNA RAMSASS, b. 1 Oct.
Dec. 3632: Had: ZZO=SO: das.

acknowledged ONE MAKER and
under whom were many faithful,
whc., taught truth, which stands to-
selfish desires. Gen. 65 "C"=

da. Hafana, s. F. Namrut and F.
Aug. 3565: d. 10 Nov. 3647: m.
b. 1 Jan. 3560: d. 2 Feb. 3662:
cus: das. and sons.

of ZO=SO (English Bibles.) 2



Pl. 379
Gen. 63

Princes, and their gran-
py; for they live leas

" 64 F. CAMIL-
F. Riua, b. 1
SHAMKON,
Had: Ram-



Pl. 380
Gen. 64

I can hardly think that
Cicero, who is destitute

" 65 FNR MUL-
ho's son
Mar. 3612:
3544: d. 26
sons.



Plata 375. Gen. 64

The Ægyptians of old
Governor of the world:
and unfaithful servants,
day, untruths taught for
Christ.

" 66 F. NOARA,
Arkona, b. 3
FANA ZO,
Had: Samiti-



Plate 376. Gen. 65.

The Coin
Kings 17:4.



Pl. 381
Gen. 65



Pl. 382
Gen. 66

Plate 377 A
Gen. 66



Plate 377. Gen. 66.



Plate 377 B
Gen. 66

Good cannot do evil.

" 67 F. ZA-
and F.
1 Dec.
b. 1 May
Nachro:



Pl. 383
Gen. 67

It is certain there
was no God, but
sons not sound, that



Plate 378. Gen. 67.

RA, da. Nahi, s. F. Takalut
Mutta, b. 7 Jan. 3600: d.
3684: m. FNA SAMITICUS,
3604: d. 21 Jan. 3684: Had:

was never a man that said, there
that he first wished it, for rea-
self be advanced.

DOWN FROM GOD
DO NOT ERR, MY
DARE TO DO
EVIL.
LOVE GOD AND
MANDMENTS.



Gen. 68.
Plate 384.

GEN. 68. F. SAIO da.
Camilla, b. 14
F.NACHRO,
Had Sammis:



Plate 388. Gen. 68.

COMETH LIFE.
BELOVED BRETHERN.
RIGHT AND FEAR NO

KEEP ALL OF HIS COM-

Faconr, s. F. Shamkon and F.
Apr. 3620: d. 6 Jun. 3702: m.
b. 1 Sept. 3624: d. 4 Feb. 3725.
sons and daughters.

GEN. 69. F. SRTA, da.
Mullah, b. 15
F. SAMMIS,
Had Afras=



Gen. 69.
Plate 385.

Impenitency
uly.



Plate 389. Gen. 69.

Saml, s. F. Ramsass and F.
Sept. 3657: d. 3 Jun. 3748: m.
b. 2 Jun. 3658: d. 6 Feb. 3724.
Aprics.

is the undoubted issue of incred-

GEN. 70. FNR THA-
& F. Saio, b. 7
F. AFRIAS,
Had Niatatis.



Gen. 70.
Plate 386.

Alexander
sword, Square,
est Map, Chart
was the da. of
brother Thales
Fna Cambyzas
dane, da. Phra-
found absolute

GEN. 71. F.NIATATIS
Jun. 3764: d. 3
b. 8 May 3767:

For faces of
giving his gen-
and God, the
p r e s e n t

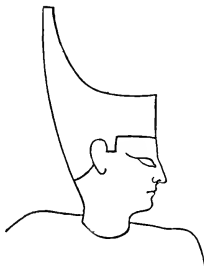

Plate 390. Gen. 71.

LA da. Alasanda, s. F. Nachro
Feb. 3681: d. 7 Jun. 3780: m.
b. 1 Feb. 3684: d. 2 May 3784.

the Great beareth on Medal,
of 69 Gen. 13 dots=stars on old-
and History. Thala, another,
Examius and Cleobula: her
d. in 96th yr. of his age, and m.
the s. of Alabandus and Man-
ortas. Of this last I have not
proof.

da. Afrias, and F. Thala, b. 9
Feb. 3824, m. F. CAMBYASAS,
d. 9 Jun. 3841. Had Cyrus.
Niatatis and Afras see the Pl. 63
ealogy back to Ava and Adam,
Universal Creator, our Omni-
Father.



Pl. 416. Gen. 71.

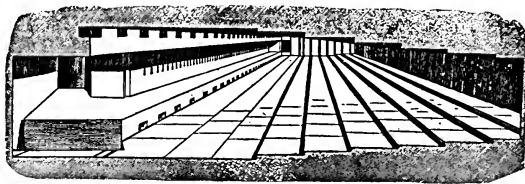

Plate 391. Court Entrance Into the Pyramid Built Altar Ueto God.

“A

T II CHRONICLES XXXVI CHAPTER AND VERSES 22 AND 23 IN MOTHER ENGLISH IS:—NOW IN THE FIRST YEAR OF CYRUS KING OF PERSIA, THAT THE WORD OF THE LORD SPOKEN by the mouth of Jeremiah might be accomplished, the Lord stirred up the spirit of Cyrus King of Persia, that he made a Proclamation throughout all his Kingdom

and put it also in Thus saith Cyrus All the Kingdoms the Lord God of and he hath charged House in Jerusalem

Who is there his people? The with him, and let True Plates low 404 of Wash-

The verses are Bible numbers, but ter the correct state- brew language, that points which are polated.

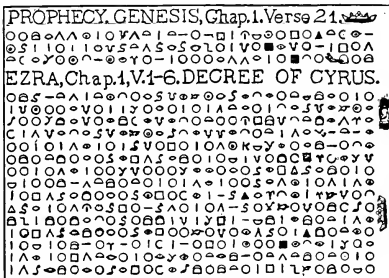

PLATE 403. UNIVERSAL INTERNATIONAL GENEALOGY. Each Ægyptian Symbol Represents a Hebrew Letter.

THE GREAT PROCLAMATION OF CYRUS THE KING WHICH GIVES FROM THE ÆGYPTIAN ABOUT FORTY GENERATIONS BEYOND THE PRESENT TIME 800 YEARS

Book of Ezra has it:—"Now in the first year of Cyrus King word of the Lord by the mouth of Jeremiah might be fulfilled, the spirit of Cyrus King of Persia, that he made a proclamation kingdom, and put it also in writing saying: Thus saith Cyrus Lord God of Heaven hath given me all the Kingdoms of the charged me to build him an House at Jerusalem, which is in

Who is there among you of all his people? His God be with up to Jerusalem which is in Judah, and build the House of the (he is the God), which is in Jerusalem. And whosoever remain- where he sojourneth, let the men of his place help him with and with goods, and with beasts, besides the freewill offering for that is in Jerusalem.

Then rose up the chief of the fathers of Judah and Benjamin, the Levites, with all them whose spirit God had raised to go up to the Lord which is in Jerusalem. And all they that were about them hands with vessels of silver, with gold, with goods, and with beasts, and with precious things, besides all that was willingly offered.

writing, saying: King of Persia: of the Earth hath Heaven given me; me to build Him a which is in Judah. among, you of all Lord his God be him go up."

Nos. 403 and be- ington Genealogy. not as recorded in are more to aid bet- ment of found He- had originally no wrongfully inter-

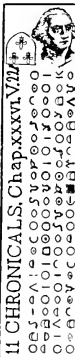

Pl. 404. Universal In- ternational Genealogy Second four symbols left to right spe II TAFT

of Persia, that the the Lord stirred up throughout all his King of Persia, the Earth; and He hath Judah. him and let him go Lord God of Israel eth in any place silver and with gold, the House of God

and the priests, and build the House of strengthened their



"I

FERNA
CYRUS KING

OF ALL EARTHS KINGS GIVEN

TO ME BY MY FATHER OMNIPOTENT GOD

WHO IS KING OF KINGS AND LORD OF LORDS TEMPORAL

THE TRINITY UNIVERSAL OMNISCIENT AND OMNIPRESENT ONE GOD

That All Should With Me, King of Fars, Worship and Obey His Commandments to Give This Decree Unto All the People on Lands and Seas Saying: Give Unto All My Children Wo Man Kind the Names of Their Foreparents I Created and Blessed to be Honored From Beginning from \odot to Their Change Ever with \circ (Symbols names of God.) Begin at Jerusalem in Juda to Build Me a Temple: Let Thy Descendants Build Pyramids. Obedient Unto Commands of My Father \odot the Holy One: in Fars From, Be It Said, Let Joyfully, It Be Willingly Begun: For God Who Made Us the First Two for the Land, Pointed Out by the Hand of Zana Oma Land of Mounds Where the Sun First Shone on Wo Men Kind.

$\Psi\Omega\Theta\Delta\text{P}\Delta\Delta$ Trans. BEFORE ME CYRUS was the beginning of my pure foreparents at Omo:."

TRANSLATION OF PLATES 403 AND 404.

"Before me were Fnl Nietatis and Fna Cambysas: Fnl Thala and Fna Afrias: Fnl Srta and Fna Sammis: Fnl Saio and Fna Nachro: Fnl Zara and Fna Samiticus; Fnl Noara and Fna Zo: Fnl Mullah and Fna Ramsass: Fnl Camilla and Fna Shamkon: Fnl Mutta and Fna Takalut: Fnl Arkona and Fna Namrut: Fnl Vashatana and Fna Orsakon; Fnl Saraho and Fna Si Hasi: Fnl Riua and Fna Osarkon: Fnl Arlina and Fna Boccharis: Fnl Baru and Fna Tachnatis: Fnl Halah and Fna Shishark: Fnl Aaglaha and Fna Mizram II: Fnl Anannah and Fna Sufis: Fnl Hazzalal and Fna Anm II: Fnl Mahataval and Fna Ramankhfa: Fnl Naanah and Fna Hana: Fnl Bithia and Fna Nabkth: Fnl Batha and Fna Nafakara: Fnl Lnar and Fna Satas: Fnl Frna and Fna Tyrous: Fnl Fafur and Fna Mananra: Fnl Farna and Fna Ramasi: Fnl Funar and Fna Tata: Fnl Hulda and Fna Mnas: Fnl Francasa and Fna Ratatka: Fnl Musar and Fna Harmanka: Fnl Farna and Fna Ramisar: Fnl Marrifu and Fna Rasahu: Fnl Marion and Fna Usakaf: Fnl Bunala and Fna Ramanka: Fnl Marlona and Fna Rashaf: Fnl Fammr and Fna Ratataf: Fnl Mathar and Fna Khufu: Fnl Fata and Fna Sanafra: Fnl Tatar and Fna Huni: Fnl Afr and Fna Ramfarka: Fnl Falamar and Fna Satos: Fnl Aloa and Fna Tata: Fnl Maron and Fna Rafa: Fnl Af Anr and Fna Naba: Fnl Arta and Fna Tata: Fnl Muto and Fna Santa: Fnl Naomi and Fna Utnas: Fnl Rafar and Fna Bainutar: Fnl Rafa and Fna Kaka: Fnl Fora and Fna Butan: Fnl Falafar and Fna Afosis: Fnl Lara and Fna Bianchas: Fnl Fardar and Fna Mars: Fnl Rachar and Fna Mantha: Fnl Hanar and Fna Hasaftr: Fnl Mira and Fna Atta: Fnl Mrai and Fna Att: Fnl Lyra and Fna Tta: Fnl Adr and Fna Anm=Ynm: Fnl Laza and Fna Mzraim: Fnl Anr and Fna Hm: Fnl Lamr and Fna Noah=Nh: Fnl Ladar and Fna Lmk: Fnl Salah and Fna Matosh: Fnl Sara Fana and Fna Hnok=Enoch: Fnl Santa and Farada: Fnl Lalar and Fna Mahallal: Fnl Nasata and Fna Konn=Cainan: Fnl Saio and Fna Anos: Fnl Sana and Fna St=Seth: Fnl Zana and Fna Abl: Fnl Kanafatafaa and Cain (that slew godly Abel) they twins of Ava and Adm: Fnl Ava and Fna Adam=THE CHILDREN OF GOD."



“**I** ADM, MY FOREPARENTS AND YOURS, AVA AND ADAM CREATED BY OUR GOD THE TRINITY ONE UNIVERSAL GOD, CREATOR, COMMANDETH TO BE BUILT THE MOUNDS IN OMO, ANON, THAT GOD built the Pyramid Lake, O for Ægypt to copy and keep in memory Serpent Mound, O, that now commandeth me to build a part of the Temple, us to finish it for Israel and all to worship him everywhere and in Temples kept sacred, dedicated to God.”

“I the mighty King Cyrus of all the earth and waters anointed from God speak. I write the words God my father of heaven commandeth saying by my mouth speaketh and say to all: After me shall come, Fnl Attosa, my pure daughter God's gift to me, and Fna Dariuc: Fnl Amastris and Fna Arta Ba Zanas; Fnl Musar and Fna Hystaspes; Fnl Furina A and Fna Arta Fonou Fernes: Fnl Athis and Fna C. Fones; Fnl Anagna and N. C. A. L. Farna: FNL AGRAI FAUNA and Fna Farna Bazus; FNL Camils Farno and Fna C. L. S. Furna; Fnl Cleopatra and F. C. C. Arta Bazus; Fnl Bazine and Fna Alexander the great king of the world; Fnl Apama and Fna Hercules Selucus Antiochus Fernes; Fnl I. Stratonicæ and Fna A. Antiochus Theon; Fnl Laodice and Fna Antiochus Theos; Fnl Loadice and Fna Seleucus Callinicus: Fnl Laodice and Fna Antiochus the Great: Fnl Arsinoe and Fna Antiochus Epi Fanous: Fnl ☉ Laodice and Fna Demetrius: Fnl Cleopatra and Fna Antiochus; Fnl Camila and Fna Antiochus Epi Fanous; Fnl Scribona and Fna C. C. L. Furnius; Fnl Farna and Fna M. M. C. F. Lucius C. Furnius; Fnl Tom Fonia and Marcus Agrippa Lucius Furnius; ☉ that goeth to the mound Land of Omo where after Christ the son of God one with trinity goeth; Fnl Thacla and Gracianus Julius C. C. Funarius; Fnl Furna and Gneus Agricola Julius C. Furnius; Fnl Julia Procilla and Fna Scribona; Fnl Domita Decidi Ana and Gneus Agricola Furnius; Fnl L. Honor and Fnl Furna; Fnl Thecla and Fna C. Fabi C. Furnius; Fnl Lælia and Fna Leucius Charinus Lentulus Furna; Fnl Livia Octavias and Fna C. F. Fabi J. S. V. L.; Fnl D. Marina and Fna Leonidas: Fnl M. Farnia and Fna Fars Fandari=C. C. Is Fendear; Fnl Fnia Chia da. Chinese Emperor and Fna Bahman=Farenes king of Persia that goeth to the land of Oma and buildeth the commenced ☩ Tower, ☉ Temple, Fort Ψ at R. I.; Fnl Ennia=Annia and Fna Sassan; Fnl Irena and Fna Babek Yezdigird; Fnl Tasthi Arta Ducta and Fna Arta Xerxes Adishir Babigan; Fnl Furan and Fna Sapor; Fnl Arcam and Fna Hormuz; Fnl Purana and Fna Farenes=Varanas; Fnl Fu r Ana Fir Uz and Fna Fernes; Fnl Car Zarma and Fna Shapur; Fnl Constantina and Fna Fara Mond; Fnl C. Irena Commena and Fna Mund Zunk; Fnl Hilda and Fna Attila, A Sword of God; Fnl Aridne and Fna M. Frna Clovis; Fnl Sarah and Fna Joannes Meroveus; Fnl Ala Fenius and Fna Childerick; Fnl Clotilda and F. F. F. Clovis Fnl Ingonda and Fna Clotharius; Fnl Brunehilde and Fna Sigebert; Fnl Failuba and Fna Childebert II; Fnl Thudachild and Fna Thierry; Fnl Ayasha and ΔΨϷ da. Mohammed and Ayasha and Fna Pepin=ΨΔ=☉Ψ; Fnl Zada Baga and Fna Bagi Zadah=Begga; Fnl Placitude and Fna Pepin De Herstal; Fnl Clotilda and Fna Childebert; Fnl Alif, da. Verimund, k. Spain, and Fna Robert Le Fort, strong of the Land; ☐=God eyes of France; Fnl Alsatha gr. da. Alfred the Great, and Fna Robert Duke of France; Fnl Edgina and Fna Hugh the Great; Fnl Adelaide and Fna Hugh Caput; Fnl Constantina and Fna Robert the Pious; Fnl Anne, da. Jaraslaus k. Russia, and Fna Henry I; Fnl Bertha and Philip I; Fnl Adelaid and Fna Lewis VI Le Crasus; Fnl Alice and Fna Lewis VII; Fnl Isabella and Fna Philip Augustus; Fnl Blanche and Fna Lewis VIII Cœur De Lion; Fnl Margaret and Fna Lewis IX St. Lewis; Fnl Isabella and Fna Philip III Le Hardi; Fnl Jolante and Fna Charles De Valois; Fnl Jane and Fna Philip VI De Valois; Fnl Bonne and Fna John Le Bon: Fnl Joan and Fna Charles V. Le Sage; Fnl Isabella and Fna Charles VI Bon Ami; Fnl Mary and Fna Charles VII Victor; of the Land ☐, France; Fnl Charlotte, Fna Lewis XI, most Christian King; Fnl Anne of Britiany da. Francis II and Margaret De Foix and Fna Charles VIII the ☩ Single Eye Pure for the Glory of France. That the Hand of God Points out. His Son the Mighty Man Writer of Medical Annals that All the World will be blessed there from despite evile Foes.



“L

ET NO ONE OPPOSE THE POWER OF OMNIPOTENT GOD THAT CHANGETH NOT NOR HIS WORD. L=FNL (MAGDALENE LULLIER AND FNA JEAN FERNEL,) GOD PROMISED “AVA AND ADAM shall be ancestors for making great the land of Pyramid Lake, Mounds Land, Omo= America.” Fnl Maria Commenius and Francis Junius Fernal; 4 wives: Fnl Anni-

etta De Coligny, da. G. De Coligny, Admiral, Commander of French Navy, Fna Dr. John Fernal: slain by Jesuit, pr. Pope: Fnl Elizabeth Amand da. Girard Amand and wife Elizabeth Washington, and Fna Captain William Fernald who sailed to America □=Omo=□□□: Fnl Joanna Warburton and Fna Dr. Renald Fernald, sailed to live in Omo: Fnl Temperance Washington and Fna Thomas Fernald: Fnl Mary Spinney and Fna Dr. John Fernald: Fnl Sarah Hincks and Fna John Fernald: Fnl Elizabeth Rogers, da. Rev. John and Martha, and Fna Captain John Fernald, of Waters and Captain Mark F. killed: Fnl Mary Savage, da Thos., John S, and Fna John Fernald, Priv. Sectry. Gov. John Wentworth, was in American Revolution: Fnl Elizabeth Johnson, da. Phineas, s. Col. Samuel and Fna William Fernald: Fnl Mary Cotton Pike, da. Robert, s. Genl. Zebulon: gr. da. Col. Wm.

Cotton, and Fna nald: (with about tions on this remark- clareth the long line) protected by God waters and children me, dwell with me, one, God. “It fur- about 800 years the two generations have discovery bearing previously recorded: search and research plete lawful punish- and every mass of been protected in setts and in New crimes from the least a continual addition 150,000,000 of) mar- the vital centre of all Nations for the Gen- Shall Cease Fully by Hypocrites Whose to Point the Way to

Run, to Satan’s Kingdom of Vile Evils; That Are Principally Remedied by Enactment and Enforcement of Our Three Great Moral Reform Laws. The Crown Was Offered to General George Wash- ington by England, That He Properly Refused, although From Ancestry Had a Right To Be a King In This Country That He Is, Was and Ever Will Be Father For Although It Has For Many Years Been Surrendered to the Unconstitutionally Licensed Rum Ring and a Clique, He Would Look With Hor- 1000 Upon If He Could Arise From His Grave and See the Thirteen Years’ Defeat Of Our Spirit Let- 1000 ters of Declaration of Rights of the Commonwealth of Massachusetts Inhabitants with the Constitu- 1000 tions of Sovereign States and United States of America, Land, Omo Cursed By a Church, That I Have 1000 Reduced Its Martyrs From 250,000,000 to 150,000,000, Due to Ever Meddling With States and Na- 1000 tions for Blood Shed by Ignorant Fanatics, Who Had Many Common Ancestors, All the Children of 1000 One God. Those Two Plates Compare with Other Two True Ones, page 112. Note the Change: Beware!!

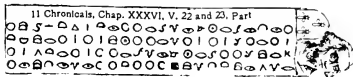
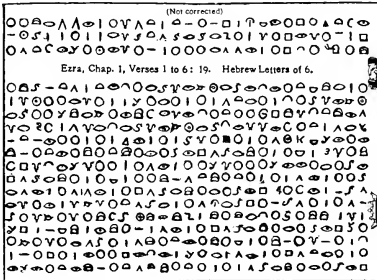

Plate 406.



Prophecy Genesis Chap. 1, Verse 21, Part 22. Plate 407. Plates of Comparison, page 112.

Jonathan Poor Fer- forty more genera- ble Decree that de- Fernald shall live Trinity till All earth thereon cometh to in my kingdom, of her alleges that it is earth is to remain:” been born since the the names that were Expert investigation, requested with com- ment of every single criminals that have Boston, Massachu- Hampshire in all to the greatest with well known (over tyrs ever striking to Governments and eral Destruction that the False Perjured Favorite Pastime is Heaven and Walk,





UET HE ALSO IS WISE, AND WILL BRING EVIL, AND WILL NOT CALL BACK HIS WORDS: BUT WILL ARISE AGAINST THE HOUSE OF THE EVIL DOERS, AND AGAINST THE HELP OF THEM THAT WORKETH iniquity. For the Lord is our Judge: Lawgiver and King Omnicient. That declareth unto $\odot \epsilon \varphi \circ =$ F. Cyrus= $\kappa \rho \upsilon \rho \omega \varsigma = \circ - \Delta \Psi = \sigma \tau \gamma \cdot$ Son of FNR CAMBYAS AND NI-ATATIS, DA. F. AFRAS=APRIES, AND HUSBAND OF F. ANAR MANDANE.

"ISAIAH Prophet of God THAT SAYETH "Even I will give thee dark treasures,
 'I will go before thee, and level mountains, And the hidden wealth of secret places:
 I will burst asunder the folding doors of brass That thou mayst know, that I THE LORD,
 And split in twain the bars of iron. Who called thee by thy name, am THE GOD.' "

Isaiah declared his name (44: 28) above a Century before he was born. Josephus says the Jews showed this passage to Cyrus. The few particulars in the Hebrew Bible from its found (called) lost language with the Ægyptian are authentic: a small part is given in this Edition to all. Xenofon in his Cyropaedia or Education of Cyrus: the basis of which is true history adorned and refined by philosophy, and exhibited for universal admiration with imitation of the pure acts of the prince Cyrus cradled in the ancient Persian school of the Pischdadians of the Socratic. Anointed, Chosen as the messenger by GOD to execute his high behests, one of the genealogy line of every person of earthly foreparents, and those to come Cyrus, Papyrus Prisse, Genealogy God for Mankind Stone, called Moabite, given, Cyrus subdued and reigned over the nations, viz:—Cilicians, Syrians, Paphlagonians, Cappadocians, Phrygians, Lydians, Carians, Phoenicians, Arabians, Ægyptians, Babylonians, Assyrians, Bactrians, etc.

SAADI in his Gulistan copies the wise inscriptions which Cyrus ordered to be inscribed on his crown:

"WHAT AVAILS A LONG LIFE SPENT IN THE ENJOYMENT OF WORLDLY GRANDEUR, SINCE OTHERS, MORTALS LIKE OURSELVES, WILL ONE DAY TRAMPLE UNDER FOOT OUR PRIDE! THIS CROWN, HANDED DOWN TO ME FROM MY PREDECESSORS, MUST SOON PASS IN SUCCESSION UPON THE HEAD OF MANY OTHERS."

PLINY comments of the tomb of Cyrus at Passagardae, in Persia=Fars. ARRIAN and Strabo describe it and they agree with Curtius, that Alexander the Great offered funeral honors to his shade (shade=tomb, death, earth, grave: that God commands) there: HE opened the tomb for his greatest treasure left, HIS SWORD, and found it the Persian Cimeter, that God honored; two Scythian Bows: symbolic of the duality of God, after Christ came, kept on the Chinese nine commandments of God and here PLATE 108  the original displayed Gift of same to AVA and Adam with be the gift to China, & Washington, and the universal creation, and its hieroglyphics record unto all people of earth and waters: Gift at Omo, Anonna, the Land of Lake Pyramid and Mounds where creation first begun and sun arose first to shine on the image or likeness of mankind created after Woman: Cyrus shield was found returning to dust. Plutarch records the inscription on the tomb, in his Life of Alexander as follows:

"O MAN, WHOEVER THOU ART, AND WHENEVER THOU COMEST, FOR COME, I KNOW, THOU WILT, I AM CYRUS, THE FOUNDER OF THE PERSIAN EMPIRE, ENVY ME NOT THE LITTLE EARTH THAT COVERS MY BODY."

CYRUS= $\odot \epsilon \varphi \circ =$
 KHOSRU "THE SUN"

FOUNDER OF FARSPERSIA AFTER A LONG BLOODY WAR SUBDUED EMPIRE OF TURAN REPAID EVERY FAMILY IN PERSIA PROPER THEIR WAR TAX: A RELIGIOUS REFORMER IN PEACE, 7 YRS. D.





DARED TO HIRE UNHOLY COUNSELLORS AGAINST THEM TO FRUSTRATE
THEIR PURPOSE ALL THE DAYS OF CYRUS KING OF PERSIA TILL THE
REIGN OF DARIUS KING OF FARs.



Plate 403. Generation 73.

GENERATION LXXIII.

FNR ATTOSA, da. F. Natatitit and F. Cyrus, b. 10 May 3824: d. 10 Oct. 3894: m. FNA DARIUS, s. Hystaspes and Halalialy, b. 10 Jun. 3819: d. 17 Aug. 3894: Had Arta Ba Zanes: Mandane: Ochus: Rhataguna: Fnr: Xerxes: Gobyraus: Sogdianus: Achaemenes: Ti Sa Fernes=Tisaphernes: Ratystone: Hystaspes: Ersones: et als.

THE LETTER, "Ezra V.
UNTO DARIUS THE KING: Governor Tatnai:
ALL PEACE:

BE it known unto the King, that we went into the province of Judea, to the Temple of the Great GOD, which is builded with great stones, and timber is laid in the walls, and this work goeth fast on, and prospereth in their hands.

We asked: Who commandeth you to build this Temple?

Answer: "We are the servants of the GOD of heaven and earth."

THEN DARIUS THE KING made a DECREE:

Search was made in the House of the Rolls, where the treasures were laid up in Babylon. There was found the Roll: Decree of Cyrus. "ALSO I have made a Decree: That whosoever shall alter this Word: Let timber be pulled down from his house, and being set up: Let him be hanged thereon. And the GOD that hath caused his name to dwell there destroy all Kings and People, that shall put to their hand to alter and to destroy this Temple of GOD which is at Jerusalem. The Jews builded, prospered and finished it according to the Command of GOD: Decree of Cyrus: Decree of Darius, said, I Darius have made a DECREE: LET it be done with Speed. AND ARTA Xerxes King of Persia: The Temple was finished on the Third Day of the Month of Adar: 6th Year of the Reign of Darius=

THE KING. They joyfully kept, dedication of GOD'S **کے کا وہیں** Temple."

"ARTA XERXES, KING OF KINGS, Unto Ezra the Priest, Scribe of the Law of THE GOD OF HEAVEN and COMMANDMENTS OF THE LORD, AND OF HIS STATUTES."

"PERFECT PEACE:

And I, Even I ARTA XERXES THE KING DO MAKE A DECREE to all the Treasures which are beyond the River: That whatsoever Ezra the Priests the Scribe of the Law of the God of Heaven, shall require of you: It be done speedily. Whosoever will not do the Law of God and The King: LET Judgement be executed speedily upon him; whether it be unto death; Banishment; Confiscation of Goods; or to Imprisonment.

BLESSED be the LORD GOD of Our Fathers."





LORD GOD TO WHOM VENGEANCE BELONGETH: SHEW THYSELF: WHO WILL RISE UP FOR ME AGAINST THE EVIL DOERS? OR WHO WILL STAND UP FOR ME AGAINST THE WORKERS OF iniquity? There shall no evil befall Thee, neither shall any plague come."
—Psalms.

GENERATION 74. FNR AMASTRIS, F. Morar P. b. 28 ARTA BAZANAS, 3839: d. 1 Oct. 3909: Picus = Pike: Had



Plate 410. Generation 73.

da. Ono Fas=Ono Phas=Otanés and Aug. 3830: d. 1 Aug. 3902: m. FNA s. F. Darius and F. Attosa, b. 20 Oct. Had Hystaspes who is identified with sons and daughters.



Plate 411. Generation 74

F. Arta Ba Zanas was the most powerful king of Media Atropatene and was never conquered by the Macedonians.

GENERATION 75. FNR MUSA, da. b. 23 Nov. 3860: d. b. 10 Apr. 3866: d. 1 an adoption of his son Musar: They had Phernes = Phernes:



Manada (d. Q. Pomponi) and C. Fana 20 Oct. 3911: m. FNA HYSTASPES, May, 3916: (See Chart Plate record, by his Father) Musa=in Ægyptian Ant I Foneou = Arta Fernes = Ara



Plates 412 and 413. Gen. 75.

What is fame? The advantage of being known by people of whom you yourself know nothing, and for whom you care as little.

GENERATION 76. FNR FURIN A, Fonei, b. 2 July ARTA FFER-Fonei, b. 1st Oct. et als. A temple purity by the Ro-and Fauna or Faula of the Tiber with lars and the cypher from God the Fa-



Plate 414. Generation 76.

da. C. Furnius and Hranci, da. M.N. 3881: d. 6 Aug. 3980: m. FNA NES = Faenas = Ant I Fonoou = 3885: d. 1 May 3955: Had C. Fonei: was built in her life time to honor her mans: the same as khow'n as Faunus and the Temple was built on an Island a Round Coin in Rome with pil-reading of coin declares of religion ther and God the Holy One: Athto.



Plate 414. Generation 76.



Plate 419. Gen. 77.

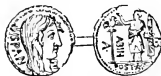

Plate 418. Gen. 77.



Plate 417. Gen. 77.

GENERATION 77. FNR ATTHIS, da. C. Furnius ann Atta, s. Athto, b. 11 Dec. 3901: d. 2 Aug. 3974: m. CIRUS FONEI, b. 1 Oct. 3904: d. 2 Aug. 3974: Had N. C. A. S. L. Farna: et als. This coin counts up their genealogy to Ava and Adam, and their possession of the Golden Tablets with EIGHT Commandments of God.

“**W**HOSO REWARDETH EVIL FOR GOOD, EVIL SHALL NOT DEPART FROM HIS HOUSE.” Prov.

GENERATION 78.

FNR ANAG-
b. 1 Aug. 3927: d.

FARNA, s. C.
20 July 3982: Had

prefix initials, M. N. C. A. S.) Anna Ferenna was the da. of Fanuel of the Tribe of Asher, a Prophetess: became a widow: went about and did much good: N=in in English A=in Hebrew.



Plate 420. Generation 78.

NA, da. Hystaspes and Anna Ferenna,
1 Nov. .3979: m. FNA N. C. L.

Fonei and Atthis, b. 2 Jan. 3928: d.

Farna Bazus, et als. (Farna full pre-



Plate 421. Generation 79. Plate 422. Generation 79

GENERATION 79.

FNR AGRAA FAUNA, da. F. Arta Farnas and F. Furina, s. C. Fabi, s. C. Foni, one of 306 killed at Cremera, 477, said F. A. Fauna, b. 2 Aug. 3944: d. 23 June 4011: m. FNA FARNA BAZUS, s. C. A. S. Farna and F. Anagna, b. 5 Apr. 3952: d. 2 Jan 4000: Had C. A. S. Furna: et als.



Plate 423. Generation 80. Plate 424. Generation 80.

GENERATION 80.

FNR CAMILS FARNO, da. Fatnus Faunus and Fauna, b. 10 Feb. 3982: d. 10 Feb. 4052: m. C. A. S. FURNA (same S. C. A. S. V. Fenas) b. 10 Feb. 3975: d. 20 Aug. 4052: Had F. C. C. Arta Bazus: (His mother had prefix C. Mari C) other sons and das.



Plate 425. Generation 81. Plate 426. Generation 81.

GENERATION 81.

FNR CLEOPATRA, da. Cleomenes and Arta Coma da. Ptolemy, b. 10 Oct. 4003: d. 10 Apr. 4061: m. FNA C. C. ARTA BAZUS, b. 3 Feb. 4000: d. 1 May 4067: Had BAZINE, et als.

The merit of great men is not understood, but by those who are found to be such themselves; genius speaks only to genius.

True valor braves danger without neglecting resources.



Chapter II

NOW THERE IS TO BE
HEBREW ANCIENT
WORD WHICH HAS
TRANSLATED WINE

} 99 = *o-o-o* = Water

SEEN IN THE TRUE
AND MODERN THIS
BEEN FALSELY
AND NOT WATERS AS

it is, because they loved wines, alcoholics, that the Saviour Christ did not make or drink: but did Pure Holy Water at the marriage feast in Cana of Galilee. St. John, 2.

GENERATION 82 FNR BAZINE, da. F. C. C. Arta Bazus and F. Cleopatra, b. 10 Dec. 4020: d. 21 Mar. 4072: m. FNA ALEXANDER, b. 3 May 4021: d. killed by Tolus, 4 Sept. 4054: Had: Hercules: 2nd. Hercules, killed: Alexander, killed.



PLATE 427. Generation 82.

Gen. 82. ALEXANDER THE GREAT: MOTHER, WIFE AND CHILDREN OF DARIUS AFTER HIS DEFEAT WITH 630,000 AT ISSUS, TREATED WITH UTMOST DELICACY AND RESPECT BY ALEXANDER THE GREAT SON OF PHILLIP II AND HIS WIFE OLYMPIAS. AN EXAMPLE THAT IT IS WELL TO IMITATE.

Alexander was born at Pella and killed at Babylon: descendant by mother of Archille line and Father from Fna Sammis: he and Atilla visited the Tomb of Apries their forefather and cut their names below the embalmed Fna Afras=Apries as is shown in Kircher's plate with Nietatis renewing there her vows and honoring ancestor as God hath commanded: After his death his foes were said to have slain his children and probably did Hercules, brother of Hercules saved that many pages might be written of him and coins.



PLATE 428



PLATE 429. Generation 83

GENERATION 83 FNR APAMA, da. Arta Bazus and Epi Da Fne Antiochia, b. 5 Aug. 3038: d. 27 May 4090: m. FNA HERCLES, s. of Alexander the Great, b. 3 June 4040: d. 4 Nov. 4194: Their cypher, hieroglyphic coins are valuable, his has a count from it taken from my Bible, to Ava and Adm. the O means son of, refers to Mounds Land F. Afras, etc. her coin beareth her monogram, GOD'S Golden Squares, also on his sword that refers to Omo, Eden: Had: Fna Antiochus, 14 Sons, 7 Daughters.



WITH THEIR NAMES WHICH ARE SYNONYMS, THE SAME IN FULL, SHOWING AND RECORDING FNR=HEBREW LNR=ÆGYPTIAN ☉-☿Δ□Δ WHOSE SYMBOLS WERE ALL DERIVED FROM THE ORIGINAL F. A. M. AND THEIR R interchangeable with Lon CIN. I I I V; his, Fna Hercules Selucius Antiochus Fernes: Had A. Antiochus, et als. Following Plates, Nos. 432, 433 and 434, are records of Fnf Hercules and Alexander the Great. Plate 430 is the most ancient name of America, Amaana=Anonna, known is derived; therein showing the Pyramids and Hebrew letter M. The gift of the Golden Squares Commandments to Ava and Adam touche of God in Omo Land of the mounds and record of dog or his faithfulness and is Creation, water, earth, Golden Squares Commandment-woman blessed labors, sail swim. Plates 435, 436, 437, love children, keep tree of tations for birds and man-tion of Cain and Ca Na Fa

after OMO from which it arrangement declares the for all. Plate 431 is a Ca-name, given by God to hon-illustrates a continuance of gave dominion to them, to drink: taught man and steps to travel the earth: mandments, worship God, family, build walls, habi-protection, with an illustra- their first da. (Cain's) Zana that m. Abel a son of Ava and Adm. 6, Gift of God's Laws: Catouches of St and Sana, after teaching Ava and Adm to navigate the waters: Slaughter of Abel by Cain, burial in mound of earth: sor-row of Ava and Adm: Birth of St, son, and wife, their marriage and one golden Square given to her. 7, Ava and Adm, Cain and Abl, and their pure wives, the first kings and queens: 4139—Records first two created by God. 440—Omo land of mountain: 441—Monogrammic names of earlier, before Flood, men and women first names. 442—Omoland of Mound and serpent peopling Ægyptis 443: 444 is religious promise Christ son of God, a Lamb. 445—Ham after Deluge. 446—Records first Laws of God at Lake Pyramid Omo and the names of At and Ta, Nh, Hm, Lamr, III sons. 447—Lamr returns to Annona. 448—Garden of Eden: twins of Adm and Avr, one a son: Squares, Mound of Abl: 449—Catouche of Oma, Nh and Lamr: Kfn=Cain: Abl, in fact the Primitive Alphabet in another form, give from God all names of earth and waters: 450—Serpent Mound commanded to

be built by God, Abl slain by Cain, Golden Squares, Adam, Cain, St and Wives built Mound: serpent represents lust and long line of Gen. with the serpentine ever in pursuit of pure woman, lion evil of Cain, cup he drank wine from he made. 451—Similar but does not record Drunk Cain, and shows expulsion from Garden of Eden, House built by God, Adam, Cain and Nh, lioness lust. 452—Lake Pyramid Ægypt copied: Squares, Laws, etc. Egg of Promise, Serpent Mound at O: Lioness lust: St pure and women: Waters: 454—Alexander, 3 sons and 2 das. 455—Lake Pyramid, A and O both names of God, worship: Gen. Tree. 456—Ananna. Nh counting family.



Plate 432.



Plate 433.



Plate 437.



Plate 455.



Plate 461.



Plate 435.



Plate 434.



Plate 439.



Plate 444.



Plate 446.



Plate 454.



Plate 459.



Plate 440.



Plate 445.



Plate 460.

Deity spelled backwards. Ava, God named Adm, ments, birds pure waters, waters and Oceans, and 438. Obey God's Com- genealogy, marriage protect kind for joy, safety and Ta Far Adam and Eve and



Plate 430.



Plate 436.



Plate 442.



Plate 443.



Plate 441.



Plate 447.



Plate 449.



Plate 452.



Plate 451.



Plate 450.



Plate 453.



Plate 457.



Plate 458.



Plate 448.



Plate 456.

IN HAND THE LAKE PYRAMID AND ONE GOLDEN SQUARE CARRIED TO "AIGPT" THAT SEVEN WENT FORTH TO PEOPLE AND BUILD OVER THE WATERS FRON OMO LAND OF LAKE PYRAMID. 457 TRUTH. 458 Mound earth where first two were created by God that promised Christ his son to be born of Mary and Joseph, children of God. Ægypt's line from mound land and waters upheld by hand of God there to grow mighty. 460 Embalmed Atta wife Mra. 461 Mound land Ur-

nor Tomb where first promised Golden Squares Ava and Adm. Record Adams Co. Name of carried across the Waters Recordeth the Prayers of ing of Abel by Cain. spirit one only God. ters. Plate 463 Sarco-

In the primitive may learn all requisite knowing may learn to It is no wonder that with a book that finds so

The consent of all very great weight with thing is true, is when it Thus we conclude there en believe it, there be- corrupt, that denies it.

As Atheism is in all hateful, it is in this, that of the means of exalting Lord Bacon.

As infidelity is the to give a man over to it, ment.

Impenitency is the credulity.

God has wisely pro- ministration of things, to of his just procedure to- and yet to leave us in- ward virtue and pros- ure us that he intends

I never had a view peror Aurelius, and yet it is discoverable by its constant experience of a proof of His being, and tion.

It was a good counsel given to the Athenians, to be sure that King Phillip was dead, before they expressed their joy at the report of it, lest they might find him alive to revenge their hasty triumph.

The like advice may be proper for all unbelievers. Let them be sure there is no God before they presume to defy him, lest they find him at last to assert his being to their destruction.

He that walks only by the light of nature, walks in darkness. None are so blind as they who will not see and understand truth from preconceived notions from illiberal education. Honesty, best policy.

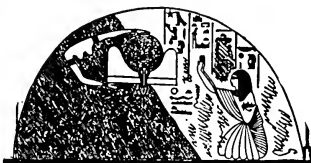

PLATE 462.



PLATE 463. SERCOPHAGUS OF FNA

was buried and God and gave with Laws to of Serpent Mound Ohio, One God and Great Seal, to Ægypt. Plate 462 Fnr Lamr: after the kill- Pure worship of great Their trip over the wa- phagus of Fnr.

Scriptures the ignorant knowledge, and-the most discern their ignorance. wicked men find fault much fault with them.

men, says Seneca, is of us. An evidence that a appears so to all the world. is a Divinity, because all ing no nation, however

respects despicable and it deprives human nature itself above human frailty.

greatest sin, so, for God is the greatest punish-

undoubted issue of in-

vided, in his present ad- give us instances enough wards the good and bad; stances enough of unre- perous wickedness to as- and after reckoning.

of my soul, says the Em- I highly value it; because operations; and, by my the power of God, I have a reason for my veneration.

THE PROPHECY OF NEWPORT MONOGRAMIC TOWER A TEMPLE BUILT UNTO TRINITY AT PLATE 464 BY KAKA THE WISE 465. A FRAGMENT OF PREVIOUS THAT DECLARETH A LABEL OR INSCRIPTION OR PLATE SHALL BE PLACED thereon. 466 Abl slain, lioness evil: Alcoholic curse brought by man suffered of God for their evil across the waters pure for all; land of Egg of promise of a destruction of alcoholics 467 part of it, Peter Faneuil Tomb Record, his Seal on Tomb, stabbed heart, time religious persecution of his ancestor's family: his line is there recorded and is counted by the Stars. 468—Trinity. 469—God's blessings on Pyramids obelisks, mound lands at Omo, Asia, Ægypt, etc.

470—Prayer, B. C., for that at great blessing in both countries. 471. The gift of Gold and pure waters. 472. Right-hand part prayer to God for gift of water, earth, Wo Man Kind 2nd. Cain slew Abl his brother, 3rd. Trinity grace by and for creation to perfect his children. Ægypt peopled from Omo, promise of God at Pyramid Lake of Christ his son for all. 474—God two in one, Lord. 475—The Mound Land history shall be protected by hand and arm of God. 476—Pyramid or Altar built after expulsion from the Garden of Eden versus lion evil. 477—Pharaoh telling of Indian people in Omo=America. 478—Rejoicing in the Lord's gift of mercy. 479—Anm of N. J. to be now exists. 480—Golden Squares Commandments preserved by Mizraim. 481—Anm's praise of the Lord for blessings at Omo Land of Mounds. 482—Lord's gift and eye that saw the Seal that shall be and was used in Ægypt and be on Tomb at Omo, Noah's Land Omo, that shall become mighty for God and people under the lily and tree of gen. 483—Upright man one the 4th with Trinity upheld. 484—The Bird count. 485—Ægyptians raising the Cross with the brazen serpent sword 2000 years B. C. 486—Another prophecy bearing Faneuil Seal. 487—St from mother: of Mound Land. 488—Square of Mound Land: Promise of Christ to go there. 489—Christ cometh there and teaching returns: wrote his name on the Rock. 490—The line of beauty Christ to come and go one with Trinity, Man, the Son of God to be born of Mary and Joseph made earthy and of waters, Heavens, God's perfect one a sword and king of God given. 491—Another Anm, a mighty Man of God on earth and waters. 492—A modern fallen Cross to banish the sins that it has been used to commit. 493—Daily Prayer worship of God. 494—Anm was a lion in traits in the Land of Mounds. 495—The power that is potent has arisen that will prevail and 496, conquer, 497 a long history of first indians in America. 498—Voice of Sealed Urn of God's words. 499—God's name is Fa that told Man Kind to call all Fnl, Fnr, Fna as his a line of and from God. It means in our language Miss, Mrs., Mr. 500—Tablets of God over Primitive Earth: Squares: Gen. Tree: Adam's the Lion changed to more valuable Dog. 501—Primitive Alphabet Seal, etc. 502—God's Dog of Mound Land for Honorable peace or righteous War. 503 and 504—Adam's and Noah's sons that even God did not destroy. 503—Center plate emblem sun, Mounds, and Crown with advent of Serpent into Ægypt.

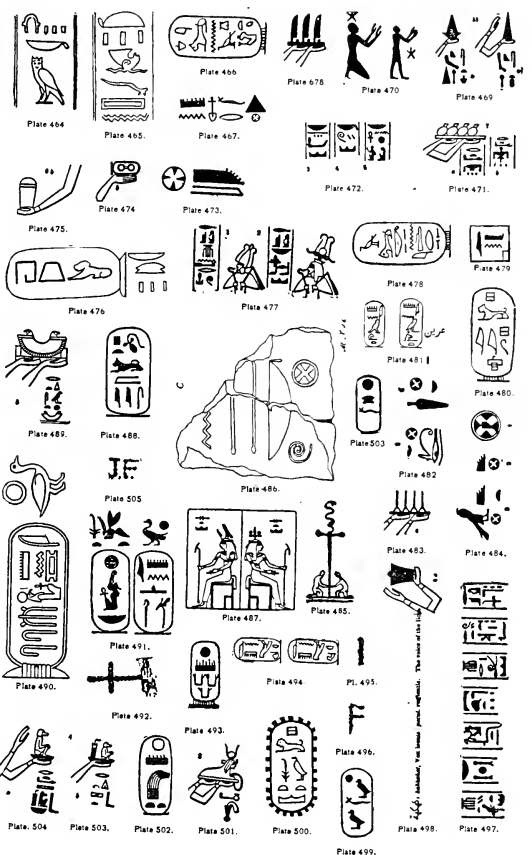

WIE AWAY TO THE BATTLE FIELD, FIGHT FOR GOD, HONOR, COUNTRY, STATES AND FAMILY AGAINST EVERY PERSON'S FOES. THE RUM ALCOHOLIC SOCIAL AND MALPRACTICE VILE RINGS. "HE WHO FALLS IN THIS RIGHTEOUS GLORIOUS WAR I WILL BLESS AND MAKE GREATER THAN 1000."

When I look upon every emotion of envy I read the epitaphs of ordinatedesiregoesout: grief of parents upon a melts with compassion. of the parents them-vanity of grieving for soon follow. When I those they depose, when placed side by side, or vided the world with putes, I reflect with ment on the little com-debates of mankind: al dates of the tombs, terday, and some several hun- great day, when we shall all makeour appearancetogether.



PLATE 506. EULOGY IS HEREON ABOVE. THIS, EARTH.

The providence of God eth and directeth with infinite

The thoughts of thy heart He knoweth thy determina-

Wonderful he is in all his scrutable. The manner of thy conception.

O, reverence the majesty tempt not his anger, lest thou

In the depths of his mind the secrets of futurity lie open

Pay, therefore, to his ation and bow thyself in hum- to his supreme direction.

There is but one God, the Author, the Creator, the Governor of the world: almighty, eternal and incomprehensible.



PLATE 507. BRITISH MUSEUM. YOU HAVE HIS ANCESTRAL REMAINS. THIS TO HONOR BOTH

the tombs of the great, dies within me: when the beautiful, every in- when I meet with the tomb-stone, my heart When I see the tomb selves; I consider the those whom we must see kings lying beside I consider rival wits the holy men that di- their contests and dis- corrow and astonish- petition, factions and when I read the sever- of some that died yes- dred years ago, I consider that of us be contemporaries, and

is over all his works. He rul- wisdom.

mind are open to his view. tions when they are made.

ways. His counsels are in- his knowledge transcendeth

of the Omnipotent; and be destroyed.

He revolveth all knowledge; before him.

wisdom all honor and vener- ble and submissive obedience



PLATE 509.

PLATE 510.

PLATE 510.

FNR I. STRATONICE, da. Demetrius Palior Cetes and Filia, b. 1 Jan. 4052; d. 20 Oct. 4100; m. FNA A. ANTIOCHUS, b. 23 Jan. 4059; d. 22 Aug. 4115. He was son of Gen. 83. Had Antiochus, Theos, Apama, Stratonicæ, et als. He was called Sotor meaning from his line of Nh, Christ should be born.

THAT GENESIS DECLARETH DISTINCTLY THAT FROM THE LINE NH, HM, SM, JAPETH, CHRIST THE SAVIOUR SHOULD BE BORN IS A GREAT BLESSING AS ONE CHRIST IS ONE WITH TRINITY A SINGLE GOD FOR THE NATIONS OF THE EARTH: HE IS SUPREME KING OF KINGS.

GENERATION 85 FNR LAODICE, da. M. Lepidus and

2 Jan. 4082: d. m. FNA AN-T. b. 6 May 4130: Had: inicus: Anti-Stratonid: et

called Theos meaning that from his line,



PLATE 511. GEN. 85



PLATE 512. GEN. 85.



Alexandria, b. 3 May 4142: TIOCHUS 4084: d. 1 Oct. Seleucus Call-ochus Hierax: als: He was N h, H m,

Christ was to be born.



PLATE 413. GEN. 86.



PLATE 414. GEN. 86.



PLATE 515. 85-6



GENERATION 86 FNR LAODICE, da. C. Fundan and OBO b. 1 Oct. 4098: d. 23 Apr. 4147: m. FNA SELEUOCUS, b. 1 Oct. 4194: d. 1 Apr. 4153: Had: Antiochus et als.



PLATE 517. GEN. 87.



PLATE 520. GEN. 86.



PLATE 516. GEN. 85-6



GENERATION 87 FNR LAODICE da. Mithradatis IV king Pontus and Lasa, b. 1 Oct. 4122: d. 20 May 4174: m. FNA ANTIOCHUS THE GREAT, b. 22 Oct. 4120: d. 22 July 4189: Had: Antiochus Epi Fanous et als.

GENERATION 88 FNR ARSINOES, da. Philip the son of Alexander The Great, b. 1 Oct. 4132: d. 4 Feb. 4184: m. FNA ANTIOCHUS EPI FANOUS, b. 9 July 4132: d. 10 May 4212: Had: Laodice: Demetrius: et als



PLATE 518. GEN. 88.



PLATE 519. GEN. 88.



GENERATION 89 FNR O LAODIC, da. Antiochus Epi Fanous & Aechia, b. 10 May 4150: d. 3 Jun. 4201: m. Grand Son of Antiochus the Great FNA DEMETRIUS, s. of Antigonus and Stratonic, b. 1 May 4154: d. 1 Oct. 4226: said to have m. four times besides this one but was given credit probably with those wives of Demetrius: I find their names as, Philia, Eurdice, that may or not be the same as here recorded: Deidameia, and Ptolemais: Had Antiochus: Anti Gonus: et als.



PLATE 522. GEN. 89.



PLATE 521. GEN. 89.



“**H**E THAT OVERCOMETH SHALL INHERIT, ALL THINGS; AND I WILL BE HIS GOD AND HE SHALL BE MY SON.”—Revelation 21 : 7.



Plate 523. Generation 90. Plate 523 A. Generation 90.

GENERATION 90. FNR CLEOPATRA, da. Marinus and Ana, b. 1 Mar. 4172; d. 3 Mar. 4259; m. FNA ANTIOCHUS, s. Demetrius and Laodice, da. Antiochus Epi Fanous, b. 9 May 4175; d. 9 Jan. 4248; Had Antiochus Epi Fanous:



Plate 524. Generation 91. Plate 525. Generation 91.

GENERATION 91. FNR CAMILA, (Pl. 524, Gen. 91.) da. M. Fanis and wife Staor, da. C. and Dionusio, b. 1 Mar. 4184; d. 9 May 4261; m. FNA ANTIOCHUS EPI FANOUS, s. Antiochus and Cleopatra, b. 21 Mar. 4194; d. 17 Mar. 4274; Had C. C. L. Furnius:



Plate 527. Generation 92. Plate 526. Generation 92. Plate 528. Generation 92.

GENERATION 93. FNR SCRIBONA, da. (Pl. 526, Gen. 92.) of Genl. C. R. F. L. M.=Lucius and E. X. C. Fnaf, b. 22 Mar. 4214; d. 22 Oct. 4264; m. FNA C. C. L. FURNIUS, s. Antiochus Epi Fanous and Camila, b. 10 May 4214; d. 1 Jun. 4284; Had M. F. F. I. C. F. Lucius: et als.



Plate 531. Generation 93. Plate 530. Generation 93. Plate 529. Generation 93.

GENERATION. 93 FNR FARNA, da. M. C. N. Stati Libo and Julia, b. 2 June 4263; d. 5 July 4315; m. M. FNA F. I. C. F., s. C. C. L. Furnius and F. Scribona, b. 26 May 4254; d. 8 July 4304; Had Marcus Agrippa Lucius Furnius: et als.

GENERATION 94. FNR TOM FO- and Filia, b. 10 FNA MARCUS b. 13 Apr. 4313; J. C. C. F.; et als. ton Rock 29 B. C., the Emperor Augustii (See coin.)



Plate 533. Generation 94

NIA=Pomponia, da. T. P. Atticus Dec. 4327; d. 6 June. 4357; m. AGRIPPA LUCIUS FURNIUS d. 29 July 4364; Had Cracianus His father wrote his name on Digh- and was a great naval commander of gustus, and named America Au- Plate 594, Chapter XX.

ENVY THOU NOT THE OPPRESSOR, AND CHOOSE NONE OF HIS WAYS.
 FOR OF OLD EVIL COMMUNICATIONS CORRUPT GOOD MANNERS.

GENERATION 95

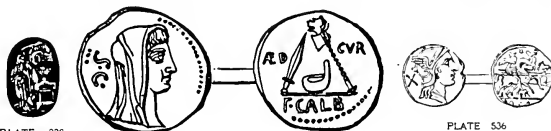

PLATE 335 SEAL PLATE 534. Cen. 95. SWORD OF C. FURNIUS, AND SEAL OF THECLA HIS WIDOW

PLATE 536

FNR THCLR=Thacla=Thecla, da, Mari=MARY and Joseph, b. 10 Dec. 4378 (=2 A. D.) d. 10 June 4442: m. GRÆCIANUS FURNARIUS J. CAIUS C. FURNIUS, b. 1 Jun. 4357: d. 1 Jan. 4402 (26 A. D.): Had: Gnaus Agricola Julius C. Furnius: Thecla b. 2A: D. C. Rubillus Blandus: Agrippa A: A F. Furnius b. 17: Julia Procilla b. 15 A. D. m. a cousin J. G. S. C. F. etc. Both Theclars are recorded as writers of said A. Codex. THE FOUND NEVER LOST HEBREW LANGUAGE GIVES MOST IMPORTANT HISTORY: HEB. St. Luke, Chap. III Verse 23 and 24. 12 last symbols, r. to l. a repetition:

ו י ש ו ע ת ה ה כ ב ו ש ל י ם ש נ ת ה ב ח ח ל ו א ת ע ז ב ד ת ו ו ח ש ב ה י ל ב ן ו ם ך ך ך
 א ם ם ם ם א ם ם א ם ם ם א ם ם ם ם א ם
 HEBREW LETTERS SYMB. ך
 IMPROVED OLD ÆGYPTIAN: א ם ם א ם ם א ם ם א ם ם א ם ם א ם ם א ם ם א ם ם א ם ם א ם ם א ם ם א ם ם א ם ם א ם ם א ם ם א ם ם

To aid in Godly work with pleasure is given expert Theologians this truth.

Left to right: Mari.
 m. Joseph=י״ם
 ם ם ם s. Heli=י״ה
 = ם ם Δ, s. Matthat=
 ם ם ם s. Melchi=
 ם ם ם ם ם s. Janna=
 = ם Δ--Δ



PLATE 539



PLATE 537

PLATE 538

JESUS CHRIST THE SON OF GOD THE FATHER, AND GOD THE HOLY ONE WAS BORN Sat. 10th. Oct. 4376, the 11 hour: Was born in Heaven 21 hour, 10 Oct. 44, equal Sunday 4376 from completion of creation of Ava and Adm, 7 Dec. and Sunday. The cypher and line work on this medal gives his birth and death. Prophecy fulfilled of death. Curse of God on those who wilfully changes Trinity Laws, Commandments, Words, also, shown four sides of two coins of his Ancestors. If Experts will examine with a magnifying glass the monogramic symbol of Mary back of neck of F. FmFF=Jof=F. Jasf="Joseph" the myth of an angel begetting Jesus is destroyed. The symbol on the double head coin gives again Omo and Lake Pyramid Oregon with Mounds Land America pretty well filled by the tools, assassins, fanatics, that have stooped for vile power and lusts the evil rapidly undermining our beloved nations God blessed here on Earth that mourn the rapidly increasing towards 250,000,000 Martyrs.



TRANSLATE ST. LUKE INTO THE PRIMITIVE LANGUAGE VERSE 27 AND IT DECLARETH: MRI THE MOTHER OF CHRIST WAS BORN 10 OCT. 4354: M. AET. 17, JOSEPH, D. KILLED BY SWORD 20 LAMECH=AUGUST 4422: Thecla was the first child b. after Christ. Married C. Furnius who had a da. Thecla the writer of the Alexandrian Codex at the British Museum. Thecla was a da. of a brother of C. Furnius who married Mary the Widow (of Joseph kil.) that she was killed 51 years after her marriage to Joseph, when a wife of C. Furnius. Thecla would thus be his daughter in law. Vide St. Luke, chapter 1, verse 27, below:

THE PROOF!

א י ע ל ב ה ת ו ל כ ב א ר ש ח ה ל א י ש ו ש ו י ו ס ק פ ס י ת ד ו ד ו ה י ע ל כ ה ש כ ה ב ה ב י ו י
 □ ○ ◊ Ψ | □ ○ | □ ◊ Λ | ○ ◊ ○ ◊ ◊ ○ ◊ ◊ ○ ◊ ○ ◊ ○ ◊ Δ ◊ | ○ ◊ Δ Ψ ◊ ○ ◊ ◊ | ◊ ◊ Δ ◊ Δ ◊ Δ
 :MFRMHM S HMLA HFD FDTFM SFSFFFN SFSFAL HSRAMLFTB HMLALA

SEE FERNALD PHILOLOGY, CHAPTER XX.



GENERATION XCVI.

FNR M. FURNA, da. of Germanicus and Agripina, b. 10 Dec. 4380=A. D. 4: d. 4 July, 4442; m. GNÆUS AGRICOLA JULIUS CAL FURNIUS, s. Græcianus Julius Caius Gnæus Furnius=Furna and Thecla, b. 22 Jun. 4377=A. D. 1; d. 22 Nov. 4432=55: Had a father named F. Furna and son Furna (Were they the Orators and Historians, "C. Furnii and Son?") If so, who beside myself will try to find their history?) and Trajan. fr. Trajanus, b. 18 Sept. 52; d. Aug. 117, whose grand neice Sabina, m. Hadrian: Roman Biog. Dictionary under Trajanus; M. Furnius a son of Junius: Scribonius C. F. appears as eldest son: et als.



GENERATION 97.

FNR JULIA PROCILLA, da. Thecla and Græcianus J. C. C., b. 30 May 15 A. D.: d. 10 Jun. 69 A. D.: m. FNA SCRIBONNIUS C—F—, b. 3 Jun. 17; d. 23 Apr. 53, he was son of Gnæus Agricola Julius Cal Furnius and M. Furna, da. of Germanicus and Agrippina (not sister): Had Gnæus Agricola Julius F.: et als.

It is one of the great effects of Providence that every nation, however miserable it may be, fancies that happiness cannot be found elsewhere. Modesty is always inseparable from true merit.

REJOICING IN THE HABITABLE PART OF HIS EARTH: AND MY DELIGHTS WERE WITH THE SONS OF MEN. RICHES AND HONOR ARE WITH ME: YEA, DURABLE RICHES AND RIGHTEOUSNESS.

GENERATION 98

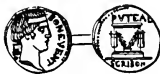

PLATE 545



PLATE 546. GEN. 98

FNR DOMITA DECIDA ANA, da. F. Galba and Æiotarou, da. Deistriou, b. 23 June 36 A. D. d. 10 Jun. 101 A. D. m. FNA MNÆUS AGRICOLA JULIUS F., b. 13 Jun. 37 A. D.: d. 23 Aug. 93 A. D.: Had: Furna: da. m. Tacitus: et als. Acts Chap. XXVIII, Verses 11 and 13, for the Record of Mariners Compass. "And after three months we departed in a Ship of Alexandria, which had wintered the Gale, whose sign was Caster and Polliux (12) and landed at Syracuse, we tarried there three days, 13th. And from thence we Fetched a COMPASS, and came to Rhegium: and after one day the South wind blew and we came the next day to Puteoli: 14, Where we found Brethern and were desired to tarry with them seven days: and so we went toward Rome. Primitive language on above coins give said facts.



GENERATION 99. PLATE 547.



GENERATION 99. PLATE 548

GENERATION 99 FNR L. HONOR, da. Bonevent Scribonis and Putea, b. 1 Oct. 53: d. 5 May 110: m. her Cousin, FNA FURNA, s. Gneæus Agricola Julius Furnius and Domita Decida Ana, b. 23 Apr. 57: d. 10 Jun. 125: Had: Thecla m. C. Fabi (C. Foni) C. Furnius and this is one of the Two Theclas that wrote the Alexandrian Codex that if Correctly Translated are the TRUTHS OF GOD FOR ALL PERSONS: An exact fac-simile of the ALEXANDRIAN Mss. and of Mary, wife of Joseph and FNR THECLA'S signature is found in Stow's History. F. I. From Sinai Mss. with corrections at different times. 1, St. John V. 6-9. 2 St. John VI. 14, 15. 3 See next page.

F. 1

ΤΩΥΑΑΤΙΜΟΝΟΝ
ΑΛΛΕΝΤΩΥΑΝΤΙ
ΚΑΙΤΩΔΑΜΑΤΙΚΝ
ΤΟΠΝΑΕΣΤΙΝΤΟ
ΜΑΡΤΥΡΟΥΝΟΤΗ
ΠΝΑΕΣΤΙΝΗΑΗ
ΘΕΙΑΟΤΙΟΙΤΡΕΙΣ
ΣΙΝΟΙΜΑΡΤΥΡΟΙ
ΤΕΣΤΟΠΝΑΚΑΙΤΟΥ
ΔΩΡΚΑΙΤΟΑΙΜΑ
ΚΑΙΟΙΤΡΕΙΣΕΙΣΤ
ΕΝΕΙΣΙΝΕΙΣΗΝΜ
ΤΥΡΙΑΝΤΟΥΧΥΑΜ

HCENCHEMEIONX
ΓΟΝΟΥΤΟΕΣΤΙΝ
ΑΛΗΘΩΣΟΠΡΟΦΗ
ΙΤΗCΟΕΙCΤΟΝΚ'ΙC
ΕΡΧΟΜΕΝΟC
ΜΕΛΛΟΥCΙΝΕΡΧ
CΟΝΚΑΡΠΑΖΕΙΝ
ΑΥΤΟΝΚΑΙΑΝΑΒΙΒΑCΗC
ΝΑ ΚΑΙΝΑΝΑΒΑCΙCΑ
ΔΕΥΡΕΙΤΑΙΝΑΙΝCΙΤ
Δ ΟΡΟCΜΟΝΟCΑΥΤ'.

PLATE 549

IN THE MULTITUDE OF THE PEOPLE IS THE KING'S HONOR: BUT IN THE WANT OF PEOPLE IS THE DESTRUCTION OF THE PRINCE AND NATIONS. HAGUE LEGISLATION, OUR THREE LAWS, ARE PERFECT SAFETY, HONOR, JUSTICE, RIGHTS, RIGHTEOUSNESS WITH GOD'S BLESSINGS.

GENERATION C.



Plate 552. Generation 100.



Plate 553. Generation 100.

FNR THECLA, da. L. Honar and Furna, b. 22 Aug. 76 A. D.: d. 2 Jun. 120: m. FNA C. FABI C. FURNIUS, b. 23 Aug. 73 A. D.: d. 12 Dec. 120 A. D.: whose ancestors' names were Fonii, Founi, Fodii, Fabii from whom descended the immortal 300 or 306 in the battle on the Cremera, his name was also spelled Furnis: Had S. N. Cornel Leucius Furnius: C. Furna L. C. L. Furna: Thecla: De Cinaus Funius: Fuvenalis, d. 127 A. D.

REPRODUCTION OF THE ORIGINAL MANUSCRIPT

ΗΕΝΕΝΩ ΠΟΥΠΙΡΟΣ ΚΑΙ ΤΟΥ ΧΙΛ
 ΧΟΙΚ ΚΖ ΑΝΟΚΗΩΤ ΚΡΕΙΤΤΗ
 ΗΛΙΥΤΕ ΤΜΟΥ ΚΡΟΥΣΕΙΝΑΙ ΤΡΙΤΑΙ
 ΒΙΡΛΑ ΝΤΩΝΗΦ ΠΝΕΥ ΠΥΗΡΕ ΜΠΙΧΑΡΗ
 ΕΝ ΖΩΝ ΖΝΤΩΝΤΕΡΟ ΖΝΤΕΩ ΟΡ Π ΝΟΜ ΠΕ ΜΠΕ
 ΦΙΛ ΠΡΟΜΜΗΝΟΥΤΕ ΙΩ ΖΛΗΝΝΟ ΕΡΕ ΒΑΜΙΩΝ
 Σ: ΠΙ Ν ΤΩΝ ΤΕΡΟ ΜΠΕ ΦΙΧΟ ΠΡΟΜΜΗΝΟ
 ΙΩ ΖΑΝ ΕΡΕ ΖΡΟ ΤΙΝ ΤΕ ΩΡΤΟΣ Η ΜΠΡΟ ΕΠΩΧ
 ΔΙΔΗΚΗ ΝΕ ΒΟ ΖΙ ΔΑ ΤΑ ΝΗ ΤΥ ΠΙ Κ Η Χ Α Ρ Ι Α Η Ν Δ Α Ν Α Σ Ι Α Σ
 Ε Μ Ο Η Π Ρ Ρ . Π Ρ Ε Σ Τ Α Ρ . Α Ν Ο Κ Ε Υ Η Ρ Ο Σ Α Ν Ο Κ Ι Σ Ο Ν Π Η Ν Ρ Ε Ι Δ Ο Κ Ω Β Η Μ Ρ
 + Ζ Π Ρ Α Κ Τ Ι Π Η Ο Υ Τ Ε Α Ν Ο Κ Ι Ο Υ Η Μ Ο Σ Ζ Α Ν Ο Η Ν Π Μ Α Ι Σ Α Ρ Ι Ο Σ Δ Ι Ο Υ . . .
 Τ Ε Ο Ν Μ Α Τ Ι Η Δ Ο Μ Α Ρ Π Ν Ε Ρ Τ Ο Ν Α Π Υ Η Ρ Ε Μ Ν Π Ε Π
 Τ Ε Α Ν Ο Κ Η Τ Ε Ρ Η Μ Α Ν Ο Κ Η Ρ Ι Ο Σ Ε Μ Α Ρ Α

132 THECLA IN BRIT.

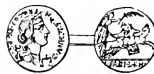

Plate 555. Generation 101.



Plate 556 A.

GENERATION 101 FNR LAELIA, da. C. Anni and Thecla, b. 10 May 90 A. D.: d. 20 Jun. 150: m. FNA S. N. CORNEL LEUCIUS C. FURNA L. C. F. s. C. FABI C. FURNIS and Thecla, b. 3 Dec. 94: d. 1 Aug. 145 A. D. Had C. F. FABI J. S. V. L.: et als.

“THE PREPARATIONS OF THE HEART IN MAN, AND THE ANSWER OF THE TONGUE IS FROM THE LORD”

GENERATION 102.

VIAS, da. Concordia, d. 3 June. FABI JULI, b. 3 July of Selucius Furna and and Thecla: Had Leonidas F.: et als.



Plate 557. Gen 102



Plate 559. Gen 102
F. C. FABI C JULIANUS. J. S. V. L.

FNR LIVIA OCTA-Pullus Lepidus and b. 10 May 110 A. D.; 150; m. FNA C. F. LIANUS S. VALENS 111; d. 3 Aug. 148, s. N. Cornel Leucius L. Fnr Lælia, da. C. Anni

GENERATION 103.

FNR lus Noninus and 130 A. D.; d. 2 NIDAS F.. s. Livia Octavia, b. October 20 3: dar! Origin writer of the Sacred Scriptures with his sister Thecla: He was a martyr and was beheaded by order of Severus: Six sons and two daughters.



Plate 560.



Plate 558. Gen 103.

D. MARINI, da. Marcel-Marcia Furnella, b. 1 Sept. Aug. 220; m. FNA LEO-C. F. FABI J. S. Valens and 21 Sept. 133 A. D.; d. 1 Had Is Fendear=Fars Fandar! Origin writer of the Sacred Scriptures with his sister Thecla: He was a martyr and was beheaded by order of Severus: Six sons and two daughters.

GENERATION 104.

FNR R vidius and An-150 A. D.; d. 1 FENDEAR= Persian Is Fen-and Marina, b. Had Fna Var=Farenes:

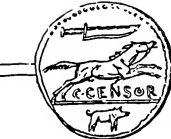

Plate 561. Gen. 104.

M. M. FARNIA, da. Heltea, son Fannia, b. 6 June Sept. 220; m. FNA C. C. FANDAL, translated from dear, s. Leonidas=Leonides 8 Jan. 150; d. 1 June 188: ahran=Bahman=Bahram et als.



Plate 561 A. Gen. 104



Plate 562.

Fig 4



COIN OF VARAHAN I.
Plate 563. Gen. 105.

Fig 5



COIN OF VARAHAN II.
Plate 564 Gen. 105.



Plate 564 A. Gen. 105.

Fig 1

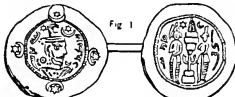

COIN OF VARAHAN IV.
Family Plates No. 565.

GENERATION 105. FNA CHIA, da. Emperor of China and his wife, b. 4 Dec. 170; d. 6 May 230; m. FNA VARAHAN= FARANES=BAHMAN=BAHRAM, b. 5 May 170; d. 8 June 223: Had F. Sassan: et als. They completed Newport Tower, fought with Indians, made peace and intermarried with them: See ante: et post. Their inscription is on Dighton Rock, Taunton River, Mass.

THIS COPAN STATUE IS REPLETE WITH PRIMITIVE LANGUAGE HISTORY, AND SHOULD BE TAUGHT IN OUR SCHOOLS.

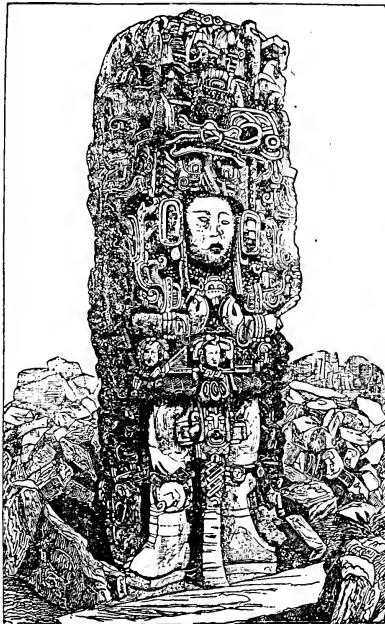

COPAN STATUE.
(Bureau of Ethnology.)

PLATE 1038. CHIA. GENERATION 105.

This Statue 13 ft. high, 4 ft. wide, and 3 ft. deep, in Central America. Copan has on it the features of Fnr Chia the wife of Bahman and daughter of the Emperor of China, the honored ancestress of General George Washington, the benign father of the U. S. A.

Giving only a few prominent features of it commencing at the top, we find in the primitive language we have from top down, as follows: The names of God the father, and God the Holy One, in irregular circles, with the hand line on forearm, also another on humerus over the son of God, and on hand four lines that signifies Trinity united with mankind as Created by God, maker of heavens, earth, waters, light, woman, man and the ribs, skeleton and then created the head from the earth, waters, light, air, the nerves, vessels, which uniting gave life, and made man for woman in the land of Anona. Omo; in his likeness to beget children and have power over inhabited earth and waters: the greatest honor gifts to woman. The Square tablet of God's Commandments is drawn and the Rolls of Trinity which is also at the top, seen from above Newport Tower and two of its Arches over the head and name of Chia. "Died 6 May, A. D., 230."



Portrait, Copan.

PLATE 1041. Restored (not correctly) by C. J. Peters
145 High St., Boston, Mass.

Rather avoid those vices you are naturally inclined to, than aim at those excellencies and perfections which you were never made for. Cicero.

Meditate often upon eternity, and no accidents of this mortal life will trouble you. Fr. Sales.

The conflict of patience, saith Euripides is such that the vanquished is better than the vanquisher.

He that needs the least, said Socrates, is more like the gods who need nothing.

"It is a strange thing to behold what gross errors and extreme absurdities many (especially of the first class) commit, for want of a friend to tell them their faults to the great damage of face and fortune.

Lord Bacon.



AT LEFT OF HER SCULPTURED FEATURES IS A LIKENESS OF "THE FLAG THAT WAS PUT OUT IN AND OVER DIGHTON ROCK, HERE COVERED BY THE TIDE. AT RIGHT ARCH AND BELOW, IS PICTURED THE spear of Bahman, her husband, slain by Indians and buried under the Tower." "The right arch, the tomb of her son, also that her child a da. was bur. under Tower. She had then living, two sons

and da. Chia. (see p. 132 that connects her with Arabia and the hieroglyphs the dates and facts of her gr. da. Palmyra. After the she remarried and had The greatest of the two who became great nawent to China, and was ius and their descend- their sculptured faces and her right arm.) progenator of thir- shiped GOD. The when God was forgot- populated, 7 were saved worship and they had were hid, indistrict- GOLDENSQUARES shall be found in the is built the Newport O circle with the top under the lowest blocks M thereon and below Squares over four slant- knees." It tells where

The remains of located at Rhode commenced by Marcus nius and completed by man. It is mono- at Vatican on a Roman page of Chapter X. Fernald has cut his was the first Geneal- in this country. He ty Lieut. Renald to America in 1645. to complete his fore- He died by poison in Tavern at New Castle



Hieroglyphics, top of Altar.

PLATE 1039.

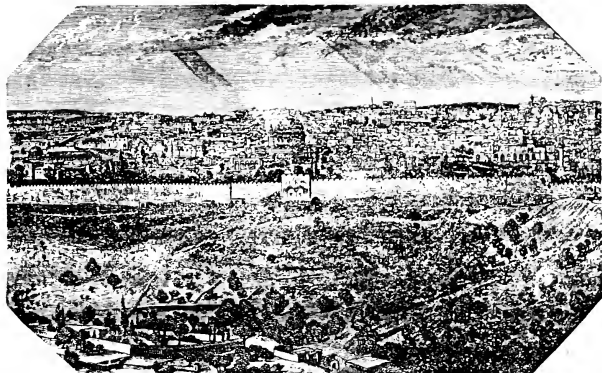

FIG. 5.—Old Stone Tower, at Newport, R. I.

PLATE 1040. H. W. F., Henry Washington Fernald's initials are cut inside

-3-4-5) for the history, the great Chieftian of glyphics of this corner therein recorded with Zenobia the Queen of death of Fna Bahman, numerous sons and das. sons went to Anona, tions, and the second the ancestor of Confucants multiplied. (See under the heart of Chia She and they were the teen nations, who wor- dark bloody days came en and Copan was de- by God for Trinity the golden squares that able: AND THOSE lost behind idolo try land of Omo and there Tower (see) the large of the restored tower head with the primitive it the two bright Gold ing panels between the they are to be found.

Newport Tower, is Island, U.S.A. It was Agrippa Leucius Fur- Fnr Chia and Fna Bah- grammic to be found coin, illustrated on first Henry Washington initials inside of it. He ogist that I have found came over with Depu. Fernald on his return Henry did not live parents' genealogy. Old Castle Hotel or or Portsmouth, N. H.



"My Happy Home"

From a photograph by Messrs. Mountford

Plate 1148. JERUSALEM. In his days Judah shall be saved, and Israel shall dwell safely; and this is his name whereby we shall be called. THE LORD OUR RIGHTEOUSNESS. IN JUSTICE, PROFIT, TRUTH, HOLINESS RENDER UNTO GOD: NATIONS, MANKIND THAT WHICH IS THEIRS IN VERITY!!

FOR MANY NATIONS AND GREAT KINGS SHALL SERVE THEMSELVES OF THEM ALSO: AND I WILL RECOMPENSE THEM ACCORDING TO THEIR DEEDS, AND ACCORDING TO THE WORKS OF THEIR OWN HANDS.

COMMONWEALTH OF MASSACHUSETTS.

UNITED STATES OF AMERICA.

Both of these popes and vaticans refused to attach their names against crimes and criminals.

1483 WASHINGTON STREET	
Boston, Mass.,	190
[POPE LEO XIII and] PIUS X, Vatican, Rome.	
Pay to	or Order,
	Dollars.
Charge the amount to my account as per bill sent to you, that would have been given to you with blessings if you had affixed your signature to the Godly Petition vs. Alcoholics, Polked, Social and Mal-Practice Evils, instead of giving gold medal to Viet Marine Co., and by selling socks appearing Christ-like work, making poor Indians like brave nations. (Amount sent \$1,486,000,000,000 and over plus \$4,000,000,000 and \$37,000,000 for 49 attempts on one life. 37 slain, witnesses plus 16,000,000 16 horses, Italian, a wife and child.) (Checks bulk of this sent to my beloved nations blessed of God.	

Dr. Jean Fernald and wife were poisoned, 1880, and the Roman Catholic Church do profit by their stolen \$20,000,000.

City of Boston stolen \$124,000,000 (See Charts for more particulars, Price, \$2.50.) Other Cities in U. S. A. and Nations.

PAPAL SUBORNATION OF PERJURY CERTIFICATE FROM SUBORNEE BY INSTRUCTIONS OF A GODLY PRIEST:—

"27 December, 1898." "I hereby certify that I was suborned to make oath against Dr. Charles A. Fernald by Attorney James W. McDonald to his injury and cost, not knowing or understanding what I was doing, but after knowing it was not true that I made oath to, I went to Dr. Charles A. Fernald and did tell him that, as of my own knowledge I do and did know him to be an upright and honorable Christian man, with nothing, to the best of my knowledge, against him."

"I have read and heard this read, and it is true:—Mary E. Carney, Hyannis, Mass.: Witnesses of Signature, Two good, true witnesses sign and their names reserved to prevent death mysteriously of 38 and 39 witnesses. This emanates from reporting Fire Arms concealed under a R. C. Church. I took a deposition of capital crime against the Bishop from the one who declared he helped to build the Secret Passages under Roman Catholic Church, corner of Malden and Washington Streets. This deposition was stolen while I was at church worshipping God.

For Justice, Nations Protection, Right is this given under our hand and seal on this the Fourth day of September, 1909.

CHARLES A. FERNALD, M. D.,
Principal of G. U. S. & F. A.



N. B. ALL NATIONS HAD CHECKS SENT BY ME FOR REPATRIATION IN AMOUNT LARGE ENOUGH TO OWN ALL PROPERTY OF ROMAN CATHOLIC CHURCH FOR 1000 YEARS. (This page substituted for stolen page 135.) PROTECT OUR NATIONS

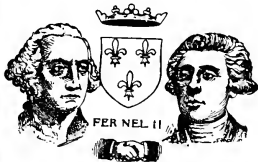

H A G U E

ALPHABET



BANNER

Encyclopa Americana et Universalis

No. XXV.

EX-PRESIDENT AND GOVERNOR'S MESSAGES: "Against Wrath of Lord, Man's Wisdom cannot avail." Folly of Man Afflicts Innocent. Uniformity in Divorce. Massachusetts Declaration of Rights. Celebrations. Laws!!! "GOOD WORK FOR MASSACHUSETTS ENACTED.—WE HELP NATIONS AND WORLD'S WORK!!! Universal Brotherhood Strengthens All Nations.

"UPRIGHT MEN (of all Nations) shall be astonished at this, and the innocent shall stir up himself against the HYPOCRITE." Job xvi: 8.

ONE HUNDRED AND THIRTY-FOUR REASONS WHY OUR LOYAL PATRIOTIC THREE GREAT MORAL REFORM LAWS SHOULD BE PASSED!!!!

1, Money. 2, Constitutions. 3, Laws of Nations. 4, State Laws. 5, United States Laws. 6, Commandments of God. 7, Confer good from evil. 8, Put one to three Billion Dollars in State and United States Treasuries. 9, Remove Financial Stress. 10, Double the pay of United States and State Officials. 11, Pay every Mariner twice present salary. 12, Double pay for every Soldier. 13, PENSION LIFE SAVING SERVICE. 14, Remove taxes from food and clothing. (15) 16, Build a Navy for Atlantic Ocean. 17, Increase the efficiency of the medical Staff. 18, Give pure ALCOHOLICS for Patients. 20, Save 300,000 lives in United States yearly. 21, Take off the liquor dealers' mortgage from unborn. 22, Permit the honorable doctors not to be *particeps criminis* of Saloonist. 23, Prevent more than three Harlot Houses to each licensed Rum Shop. 24, Prevent Murder by each licensed Saloon. 25, Punish the alcoholic dealers for crimes now (26) protected. 27, Permit protection of legitimate business now (28) unprotected. Allow HOUSE ownership BY "WE THE PEOPLE" (29 and 30.) 31, Aid all churches to enjoy their Worship of God. 32, By not accepting bribes from Rumsellers for daily bread. 33, Becoming *particeps criminis* with the Saloonist who is (34) the direct (35) OR INDIRECT CAUSE (80 per cent) OF ALL CRIME. 36, Prevent slaughter of 53 more United States marshals. 37, Empty our Prison (cells. 38, Reduce insanity. 39 and 40, Prevent killing of another President by Ex-saloonist, son of an Ex-saloonist. 41, Prevent killing of Lawful Rulers of Nations. 42, Prevent slaughter of another Governor (43) and Labor Union Leader. 44, Cure foul specific disease. 45, That in four generations has affected three-fourths of the people in the largest cities in the United States and worse in some (46) countries. 47, Preventing insults of United States flag. 48, Desecrations continued of Peter Faneuil Tomb. 49, Hancock Monument. 50, Old South Church Tomb-51, R. C. Cemeteries. 52, Reform in Massachusetts, 1500 fallen (53) by alcoholic imbibers into (54) Social Evil Houses in Massachusetts. 55, Now kept in over saloons. 56, Next doors. 57, In Hotels. 58, Tenement Houses. 59, Their procurers of (60) both sexes at work in Churches, (61) at Schools. 62, Balls. 63, Parties. 64, Sociables. 65, Intelligence Offices with one reported selling (66) the pure for from \$20.00 to \$200.00 (67) each. 68, Chapter VIII St. John is a remedy. 69 and 70, Effected by Enactment. 71, A divorce was granted to the man in our Court (72) that boasted of ruining 86 (73) and refused the pure (74) against a criminal guilty (75) with 16, and she was guilty of (76) perjury, (77) forgery, (78) attempts at murder, (79) poisoned (80) three (81) sisters, (82) theft, (83) once robbed United States Mail, guilty of worse crimes, (84) It is needless to say (84) IT WAS (85) a Beer Brewer's (86) daughter, (87, 88) boasting "protection" in "All," (89) beaten in Three Courts of four, (90) walks Boston's streets not tried for crimes to protect higher criminals, (91 and 92) one of which stored firearms to use against States (93) and United States, (94) and a deposition of capital crime was taken ante mortem and (95) stolen from him and by foes and (96) anarchists of every (97) Lawful Nation (98) Enactment prevents 50,000 (99) killed in Massachusetts annually. (100) And one every tick of the clock by Alcoholics, Social Evil, Malpractice and Infanticide. 101, Enactment prevents downfall of States, Nation, Nations and each individual 102. 3 - 4 - 5. 106, Brings Peace on earth and (107) goodwill with (108) brotherly love (109) for all. (110 and 111) Honors and Immortalizes Massachusetts Legislators, (112) Washington, (113) Hague. 114, Removes the violation of our CONSTITUTIONS by (115) killing off and making (116) unhappy the people by 96 per cent poisonous (117) alcoholics. (118) Specific disease, (119) Malpractice by (120) instruments (121) or drugs. 122, Protects the poor married woman that cannot raise another child without (123) starvation of some she has. 124, Empties the Poor Houses, (125-6) gives a Bank Account and Home to the PEOPLE. 127, ALL THE PEOPLE WILL ARISE AND CALL US (128) HONORABLE "BLESS'ED" (129) "FOR THE LORD is our defence; and the Holy One of Israel is our King!" Psalms 89: 18. 130-1-2-3-4, PEACE ON EARTH, GOOD WILL TO ALL.

GIVEN from our office with our hand and seal this Saturday, September Four, One thousand nine hundred and NINE. THE true DATE of GOD'S Creation of Ava and Adam, Six Thousand Two Hundred and Eighty-Five, Saturday, September Fourth, 2.32 P. M. At Boston, Mass., U. S. A.

CHARLES AUGUSTUS FERNALD, M. D.

Principal of G. U. S. and F. A.



This page substituted for stolen page 136.





LORD GOD, TO WHOM VENGEANCE BELONGETH. SHEW THYSELF:
FOR THE LORD OMNIPOTENT REIGNETH.



Plate 568. Generation 106.

Plate 566. Generation 106.

GENERATION 106. FNR ANR=ENNIA=
s. Macro and Ennia, b. 8
s. Varanas=Faranes=
10 Dec. 223, at Omo=
Yezdjird: et als.



Plate 567
Generation 106

ANNA, da. Macro and Codia, Dr. Codratus,
July 178; d. 1 Dec. 248; m. FNA SASSAN,
Bahman and Fnr Chia, b. 23 May 188; d.
America, at Massachusetts. Had F. Babek
See page 8 for F. Sassan's remains.



Plate 569 A. Generation 107

Pl. 569. Gen. 107.

COIN OF CHOSROES II.
Plate 570. Generation 107.

GENERATION 107. FNR IRENA, da. I.
Jan. 256; m. FNA BA-
Aug. 266. He was son
Xerxes Adishir Babigan.



Plate 571.
Generation 107.

Hostalus and Sarsena, b. 4 Jan. 200; d. 1
BEK YEZDIJIRD, b. 1 Apr. 206; d. 12
of F. Sassan and F. Ennia. Had Arta

Fig 1.



GENERATION 108. FNR
T A,
Firose

LATER COIN OF ARTABAZDES I.
Plate 573 A. Generation 108.

COIN OF ARTABAZDES
Pl. 573. Gen. 108.

TASHTI ARTA DUC-
da.Sarani and $\odot \circ \mid \varphi \circ \circ =$
 $= \odot \Phi \mid \text{PROC}$ (See Plate 574)
b, 10 May 220; d. 20
July 338; m. FNA
ARTAXERXES
ADISHIR B A B I-
GAN, b. 22 Oct. 224;
d. 12 Jun 338. Had
F. Sapor = Shapur:
et als.



Plate 574. Generation 109.

Plate 575. Generation 109.

GENERATION 109.

FNR FURAN, da. Arta Bazus and Narsas, b. 5 Jun. 240; d.
3 May 290; m. FNA SHAPUR=SAPOR, s. Arta Xerxes A. B.
and F. T. A. Duc-
ta, b. 1 May 240;
d. 8 Mar. 374;
Had Hormuz: et
als.



HEAD OF SAPUR I.
(from a gem).

Plate 576. Generation 109.



Fig. 2

COIN OF SARRES.



Plate 577. Generation 109.



Fig. 3

COIN OF YARABAN III.

Primitive Language and a prophecy that has been fulfilled.

Plate 574 has
written thereon
THECLA in the

RIGHTEOUS CONSIDER WISELY THE HOUSES OF THE WICKED: BUT
 GOD OVERTHROWETH THE WICKED FOR THEIR WICKEDNESS.
 A WISE KING SCATTERETH THE WICKED AND THEY ARE NOT.

Fig 3

GENERATION 110 FNR ARCAM da. Theodosius fr. Genl. Theo-
 dosius, b. 5 Mar. 256: d. 17
 Hormuz, S. F. Sapor
 d. 21 Aug. 374: Had F.



COIN OF HORMISDAS II
 PLATE 578 GEN. 110

d. 6 Nov. 339: m. FNA
 and F. Furan, b. 5 Aug. 258:
 Farenēs=Varahran:



COIN OF
 HORMISDAS II
 PLATE 579

GENERATION 111 FNR PURANA, da. Attar and Hormisdas 11, b.
 16 May 270: d. 3 May 332, m. FNA FARENES=
 VARANES, VARANAS b. 22 July 275: d. 27 Mar. 326:
 Had F. Fernis. et als.



COIN OF VARAHAN

PLATE 580. GEN. 111



PLATE 581

GENERATION 112 FNR FURANA FIRUZ, da. Far
 Rama, s. Arta Xerxes
 and F. Tashti, b. 15
 Sept. 288: d. 1 Apr. 357:
 m. FNA FERNIS, s. F.
 Fernis and F. Purana, b.
 8 Sept. 293: d. 1 Nov.
 392: Had F. Shapur Z.
 K.: et als.



PLATE 582. GEN. 112.

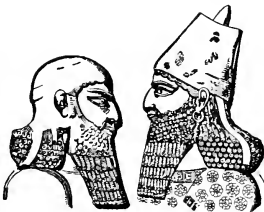

PLATE 583. GEN. 112

GENERATION 113 FNR CAR ZAMA, da. Adishir Babigan Arta Xerxes and Fnr
 Tashti Arta Ducta, b. 7
 m. FNA SHAPUR=
 KATA, s. F. Furnis and
 310: d. 7 Nov. 400: Had
 France and the ancestor
 Inhabitants have seen in
 carrying out the designs of
 ed in His only Omniper-



LATER HEAD
 OF SHAPUR IV.
 PLATE 584. GEN. 113.

Mar. 306: d. 24 Mar. 377:
 SAPOR III ZULA
 F. Furana Firuz, b. 23 Nov.
 Fara Mond who was of
 of its Kings, that the world
 the greatest historic acts for
 our Creator as God design-
 fication.



COIN OF SAPOR III
 PLATE 585 GEN. 123

Fig 5



UNITED NATIONS, PEOPLE, FAMILIES, WE STAND ON A FIRM, SOLID FOUNDATION.



589.



591



590

Chapter X.

FOR UNIVERSAL INTERNATIONAL GENEALOGICAL PURE PURPOSES TO HONOR ALL, WITH PLEASURE WE GIVE A COLLECTION OF HISTORIC COINS, MEDALS, RINGS, FACES, GEMS, ETC. TO PLEASE.



586 Great Seal of Massachusetts



Plate 592

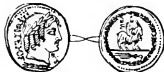

Plate 595



557 Restored Newport Tower, R. I. Coin at Vatican, Roma.



597



594



588 Gen. 94



ROMULUS II. (from a gem).

593 Gen. 114



Antioch in Syria. Head of Augustus.

596



PROPHECY, AND LABOR, O YE NATIONS, FOR PREVENTION OF THOSE EVILS THAT DESTROY.

A few of these coins were accumulated by a King of France for ancestral honoring the Nation. Nearly all by the writer to honor God and His beloved all nations on Earth for Genealogy. Select those you are related to and resemble; give proof and we will aid you all in our power to attach to the found and proved long line from our common ancestors for your honor and true prosperity.

To quickly remove a needle from the animated body is done by magnetizing a sharp, small, strong tenotome. Insert beneath needle, turn sharp edge against its centre transversely, hold it firmly fixed in position. Dissect tissues to needle; grasp it with strong serrated forceps and easily extract it from tissues.

A celebrated surgeon labored two hours and fifty-five minutes with patient under ether unsuccessfully to have it removed by this new method of author in three and one-half minutes without ether.

An apparatus devised by the writer of this has in every case used given a union by bone of fractured patella, even beyond the age of sixty years.

Many a little, constantly increasing, makes a "mickle," be it in knowledge, truth, wisdom, freedom from mental or physical pain, happiness, joys the forerunners of peace and prosperity, that can never be perfect without content that the good profit in gleaming.

N^o. 1.



N^o. 2.



N^o. 3.



N^o. 4.



PLATE 598 A.



12

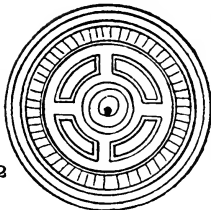

PLATE 599 PIKE.



5



PLATE 600 A. L.





ORK WHILE THE DAYLIGHT SUN SHINETH FOR WISDOM. FOR DARK-
 NESS COMETH, AND MEN ON THIS LAND THAT GOD GIVETH,
 LABORS NO MORE. GOD BLESSED HIS CREATION WITH LABOR.



Crossed L. RECEIVING TRIBUTE FROM THE ROMANS.
 Plate 607.

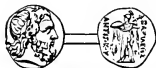

Plate 598.



Plate 599.

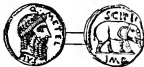

Plate 600.



Plate 601.

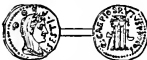

Plate 602.

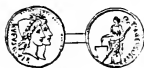

Plate 603.



Plate 604.



Plate 605.



Plate 608.

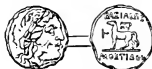

Plate 609.



Aemilianus.

Plate 610.



Plate 611.



Plate 612.



Plate 613.



STATUE OF SAPUR BY SALUPIUS (ARTIST'S).
 Plate 606.
 Generation 109. Fns Sapor m. Fur Furan.

IN OUR BANNER SENT TO THE AMERICAN DELEGATION TO THE HAGUE IS THE MONOGRAMMIC PRIMITIVE ALPHABET THAT THE LETTERS SPELLETH EVERY NAME AND HONORS UNIVERSAL CREATOR.

"The earth is the Lord's, and the fulness thereof, the world, and they that dwell therein. For he hath founded it upon the seas, and established it upon the floods."

Psalms 24:1,2.

"Wait on the Lord: be of good courage, and he shall strengthen thine heart: wait, I say, on the Lord."

Ps. 27:14.



James I. FORTESCUE, CREATOR OF THE GREAT MONARCH OF 1580 BARRON.
PLATE 614.

"Let integrity and uprightness preserve me; for I wait on thee."

Psalms 25:21.

"Gather not my soul with sinners, nor my life with bloody men: in whose hands is mischief, and their right hand is full of bribes."

Psalms 26:9,10.



BARRONIAI MONARCH SPEARING A FOREIGN KING.

PLATE 615.

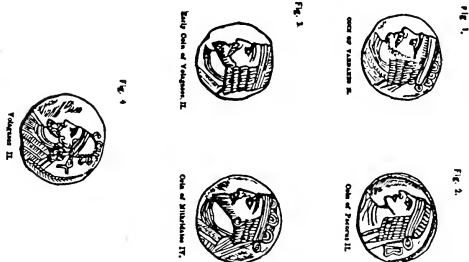

Fig. 1. King of the East.
Fig. 2. King of the West.
Fig. 3. King of the North.
Fig. 4. King of the South.
Fig. 5. King of the East.
Fig. 6. King of the West.

PLATE 616.

THY ANCES-
LOVING
MAY OUR
CONFER
ON THE

"The Lord is my strength and my shield; my heart trusteth in him, and I am helped: therefore my heart greatly rejoiceth; and with my lips will I praise him."—Psalms 28:7.

"Blessed is the nation whose God is the Lord; and the people whom he hath chosen for his own inheritance."
—Psalms 33:12.



CHARLES II. AND EMBLEMATIC FIGURES UNDER ARCH AT TARENT-BOITAR.

PLATE 617.

TORS LABORED IN
ACTS FOR THEE!
POSTERITY THUS
THE LIKE HONOR
UNITED STATES.

"Be of good courage, and he shall strengthen your heart, all ye that hope in the Lord."

—Psalms 31:24.

Blessed is the man unto whom the Lord imputeth not iniquity, and in whose spirit there is no guile."

—Psalms 32:2.



Coin of Dionisia I.

Fig. 2.



Coin of Laticata.

Fig. 2



Coin of Phur-tas I.



Pharates I. (Obreros.)

Fig. 3.



COIN OF PHALTADES AND MORLA.

Fig. 3



Coin of Mithridates I. (Native)



Coin of Mithridates I. (Greek)

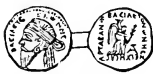

COIN OF VONONES I.

Fig. 4

Fig. 5



ARABUS I.



Mithridates I.



ANTAGORUS I.

PLATE 618.



COIN OF ANTABASUS I.



COIN OF PARDAKUS I.

PLATE 619



HAPPINESS IS THE GREAT IDEAL OF HUMANITY. THE GOOD, PURE, PROFIT FROM THEIR DEEDS.



Plate 620.



Plate 624



621



625 A



622



624 A



623

Tacitus, and his Brother Florianus.

Plate 628



625



73



77



Plate 627

Plate 626

TRINITY IS GOD WHO SO LOVED THE WORLD HE GAVE HIS ONLY SON FOR EACH ONE. HE TAUGHT US THE WAY OF WISDOM, RIGHT, JUSTICE, PROSPERITY AND GOOD ALL MAY HAVE. THEOS AND THEON was stamped in the Roman theon claims descent from Christ, should come. The on it the primitive alphabet.

Coins to show that he whose face is the line that the Son of God, Messiah, O equals son of. This large coin has



Plate 628



629



14

Plate 640.

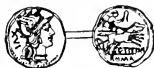

Plate 642



641



630

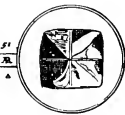

635



631



638



637



632



637



636

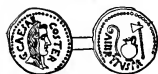

633



634



635





OLY IS THE LORD GOD OF HEAVEN THAT REVEALETH SECRETS UNTO THE KING WHAT SHALL BE IN THE LATTER DAYS.

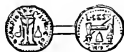

Plate 645.



646



649



650



651



653



654



655

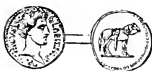

656

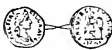

672 A. Duplicated

14



Plate 644



57
R
I



51
R
Δ



57
R
Δ



57
R
Δ



51
R
Δ



62
R
Γ



Plate 647

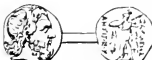

648



671



670



669



668

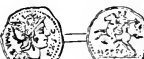

667



666



665



664

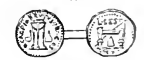

663

EVERY MAN'S WORK IS RIGHT
KNOWETH THE HEART.



Plate 672.

IN HIS OWN EYES. GOD JUDGETH,
DO RIGHT THAT GOOD COMETH.



Plate 673.



Plate 697.



674.



696.



675.



695.



676.



694.



677.



693.



678.



692.



679.



691.



680.

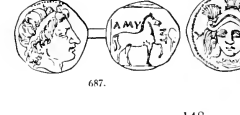

690.



681.



689.



SOLOMON ASKED FOR
ADDED TO IT. RICHES

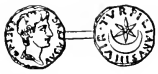

WISDOM AND GOD GAVE AND
FORMER IS MOST VALUABLE.

Plate 689



Plate 700

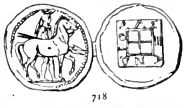

718



701



719



702



720



703



721



704

Plate 698



705



710



711

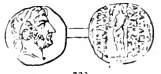

723

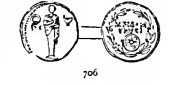

706



712



713



724



707



714



715



725



708



716



717



Fig 2

COIN OF SOBAD
726

TO CALL THE PIOUS GOD
 CONDEMN ALL WHO DO
 TRUE CHRISTIANITY,
 WHO IS UNTRUE TO
 ily. Every man is a Son of God.



Plate 728

LOVING ROMANS HEATHEN AND
 NOT BELIEVE AS WE DO IS NOT
 NOR IS ANY MAN A CHRISTIAN
 GOD, COUNTRY, STATE AND FAM-
 Ava was more honored by God than Adm.



Plate 729



Plate 727



745



730



731



746



731



732



747

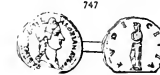

733



734



748



734



739



740



749



735



741



742



750



736



743



744



752



737

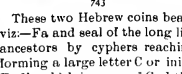

743

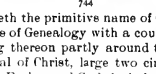

744



753



738

These two Hebrew coins beareth the primitive name of God, viz.—Fa and seal of the long line of Genealogy with a count of ancestors by cyphers reaching thereon partly around them forming a large letter C or initial of Christ, large two circles, Fa Fo, which is name of God the Father and God the holy one.



754

A

SEYEW GOOD OR EVIL,
LIKE, GOOD OR EVIL.

THUS SHALT THOU REAP THE
EARLY TEACHINGS FORM IT.

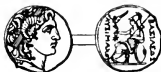
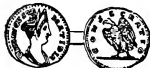

Plate 756.



Plate 757.



758.



759.



760.



761.



762.



763.



764.



765.



766.



775



776



777



778

Plate 755.



767.



768.



769.



770.



771.



772.



Plate 773.



774.



775.



776.



777.



778.



779.



780.



781.



782.

THE ARRANGEMENT OF PAGES IS THUS MADE FOR STUDY TO FAMILIARIZE THE LEARNER WITH A LARGE MASS OF INDISPUTABLE HISTORY FROM THE STUDY OF EACH COIN, AND COMPARISON WITH MODERN HISTORY.

R

RECORDS OF TRUTH STANDETH FOREVER.



Plate 783

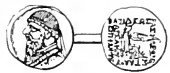

Plate 801



Plate 784



138 M r



Plate 802



785



129 M A



803



786



126 M A



129 M r



804



787



127 M A



805



788

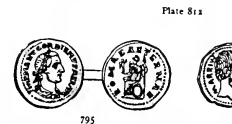

Plate 811



806



789



795



796



808



790



797



798



809



791

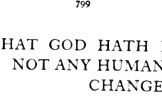

799



800



810



792



799

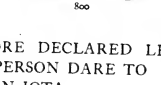

800



811



793



794

WHAT GOD HATH FORE DECLARED LET
NOT ANY HUMAN PERSON DARE TO
CHANGE AN IOTA.



SEARCH THOU THE FIELD GOD HAS
 BEEN PLEASED ME TO OPEN UNTO
 YOU TO HONOR YOUR POSTERITY.

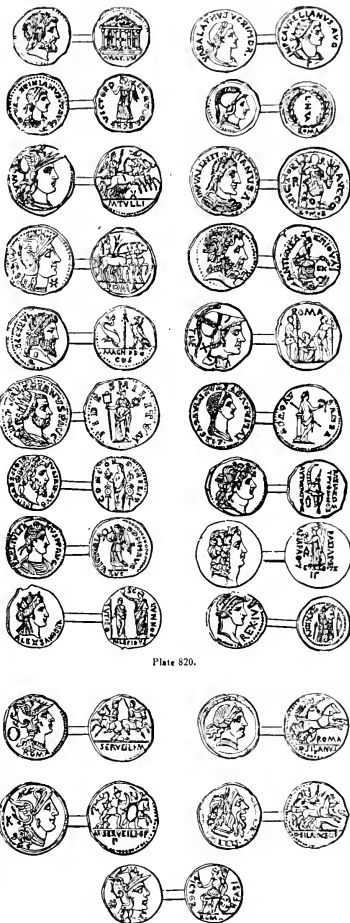
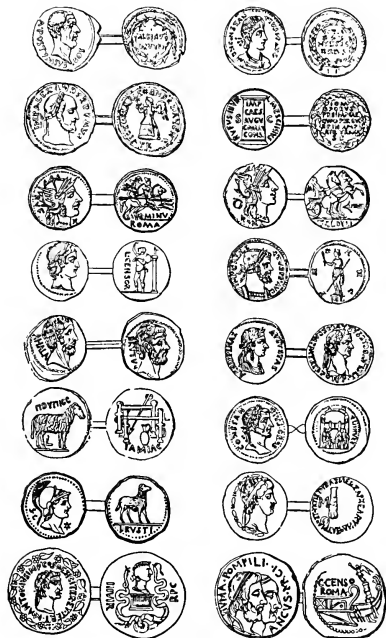



UT OF THE MOST HIGH PROCEEDETH NOT EVIL AND GOOD. WHY
SHEDDETH MAN'S BLOOD?



PLATE 821



PLATE 822



F
 OR TO HIM THAT IS JOINED TO ALL LIVING THERE IS HOPE: FOR A
 LIVING DOG, WHICH OF ANIMALS WAS FIRST CREATED, THAN A
 DEAD LION, CALLED KING OF BEASTS.

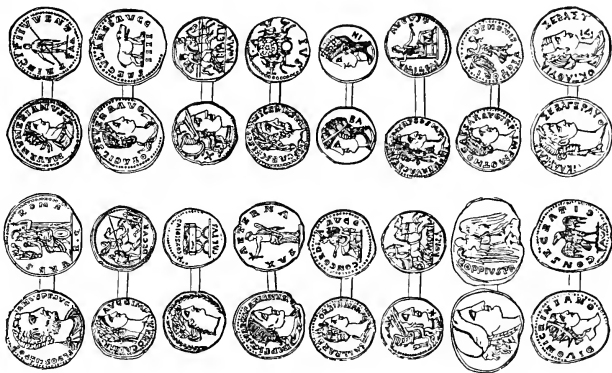

PLATE 823.

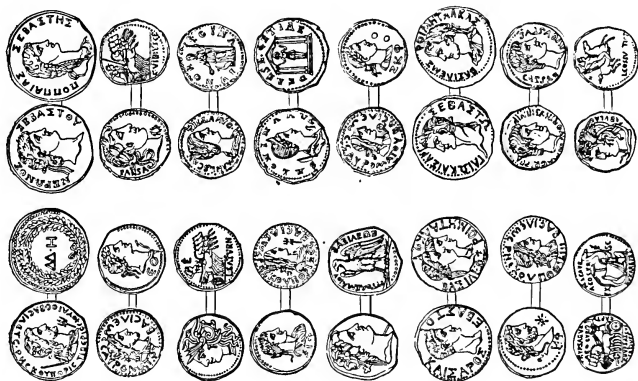

PLATE 824.

B
 UT IF A MAN LIVETH MANY YEARS, AND REJOICE IN THEM ALL;
 YET LET HIM REMEMBER THE DAYS OF DARKNESS FOR THERE
 ARE MANY. ALL THAT COMETH IS NOT VANITY. WE SHALL
 SEE GOD, AND AFTER THAT THE JUDGMENT FEEL.

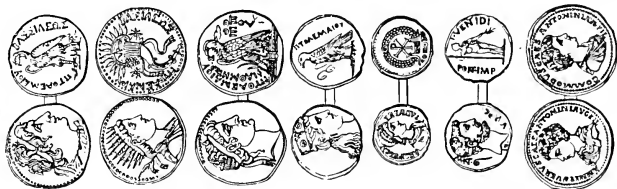

PLATE 825



PLATE 826



A

ND I TURNED MYSELF TO BEHOLD WISDOM, AND MADNESS, AND FOLLY; FOR WHAT CAN A MAN DO THAT COMETH AFTER THE KING? EVEN THAT WHICH HATH ALREADY BEEN DONE.

"Let them shout for joy, and be glad, that favor my righteous sense; yea let them say continually, Let the Lord be magnified, which has pleasure in the prosperity of his servants." Psalms 35, 27.

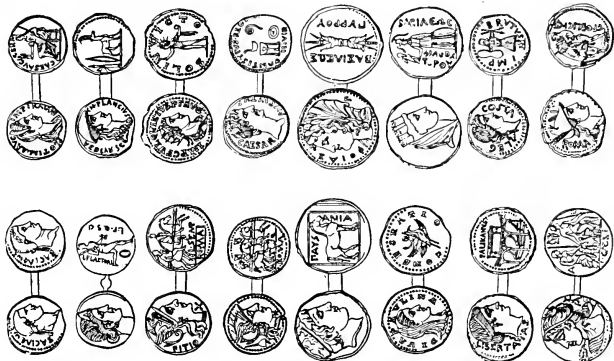

Plate 827.

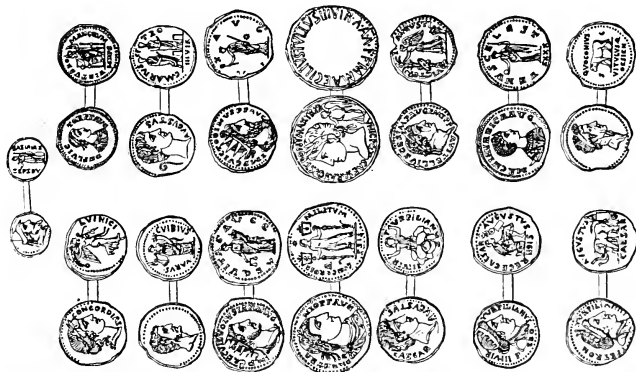

Plate 828.

NOT THAT ONE IS CAUSE THEY HAVE THEIR LABOR. one will lift up his fellow when he falleth, for he



PLATE 829.

BETTER THAN TWO: BE A GOOD REWARD FOR FOR IF THEY FALL, THE low: but woe to him that is alone hath not another to help him up.



PLATE 831.

Have the obey your risk of being man.



PLATE 832.

courage to maker at the ridiculed by



PLATE 830.

courage to be



PLATE 834.

independent if you can, and act

Have the moral courage to dis-the money.

The merit of great men is not are famed to be such themselves. by those who possess genius.

"Many are the afflictions of the eth them out of them all. Keep lips from speaking guile. Des- seek peace and pursue it." Ps.

"In God I have put my trust. can do unto me."

"Thou hast given a banner to be displayed because of the Lord, among the people. I will tions. Ps. 57, 9.

Have the prefer Propri- One is of the other.

Have the a visitor to ex- when his pres- feres with in- ence.

No success- palliate its evil.

"False witnesses did my charge things that warded me evil for my soul." Had I not Psalms, 35, 11, 12, 28.

"My tongue shall speak of thy righteousness and of thy praise all the day long. For evil doers shall be cut off; but those that wait upon the Lord, they shall inherit the earth." Psalms 37, 9.

"Behold, God is mine helper; the Lord is with them that uphold my soul." Psalms 54, 4.



PLATE 833.



PLATE 836.

independent when you may.

charge a debt while you have

understood, but by those who Genius ever is only appreciated

righteous; but the Lord deliver- thy tongue from evil, and thy part from evil and do good; 34, 19, 14, 13.

I will not be afraid of what man

them that fear thee that it may truth." I will praise thee, O sing unto thee among the Na-



PLATE 835.



PLATE 841.



PLATE 839.



PLATE 836.

courage to ety to Fash- but the abuse



PLATE 842.



PLATE 840.



PLATE 837.

courage to ask cuse you ence inter- your conven-

ful wrong can



PLATE 843.



PLATE 844.

rise up; they laid to I knew not. They re- good to the spoiling of power to refute them.

NOW THERE WAS WISE MAN, AND BY THE CITY; YET NO SAME POOR WISE



Plate 846

FOUND IN THE CITY A POOR HIS WISDOM DELIVERED MAN REMEMBERED THAT MAN.



Plate 845



Plate 847



Plate 849



Plate 850

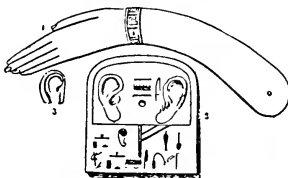

Esvoita.

Plate 848



Plate 851



Plate 852



Plate 855



Plate 854



Plate 853



Plate 856



Plate 857



Plate 858

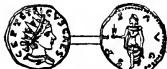

Plate 859



Plate 860



Plate 861



Plate 865

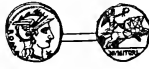

Plate 863



Plate 864

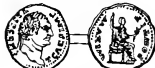

Plate 862



Plate 866



Plate 867



Plate 868



Plate 869



Plate 870



Plate 873



Plate 872



Plate 871

Fna Ann Ear Set of Surgical Instruments. Pl. 848

F AT THOU NOT THE BREAD OF HIM THAT HATH AN EVIL EYE,
NEITHER DESIRE HIS DAINTY MEATS: FOR AS HE THINKETH IN
HIS HEART, SO IS HE.

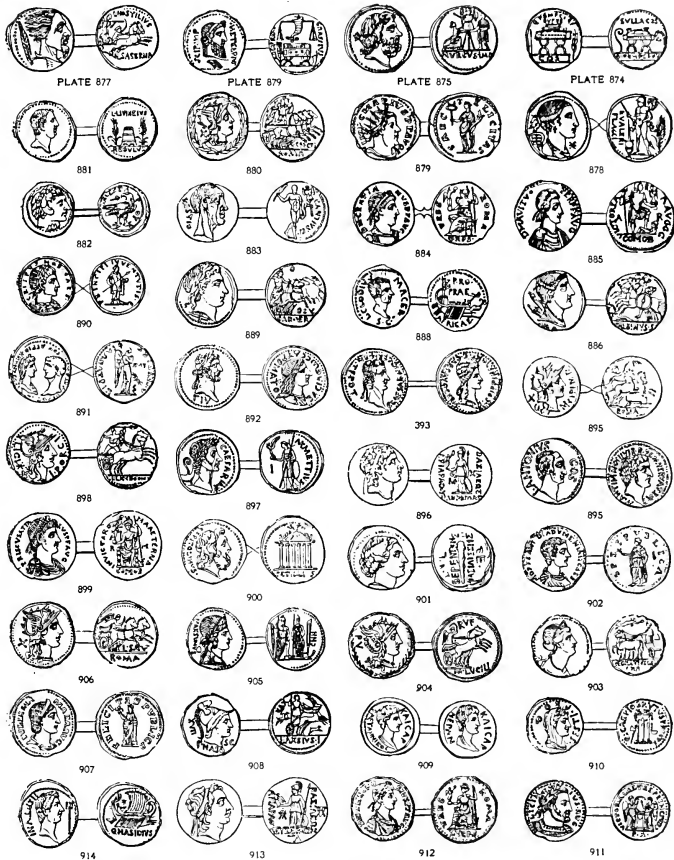

LOOK NOT THOU ON THE WINE WHEN IT IS RED, WHEN IT GIVETH
ITS COLOR IN THE CUP, WHEN IT MOVETH ITSELF ARIGHT. AT THE LAST
IT BITETH LIKE A SERPENT, AND STINGETH LIKE AN ADDER. HE THAT
IS DECEIVED THEREWITH IS FAR FROM WISE.

W

"BUT SOLOMON
HOWBEIT THE MOST
TEMPLES MADE
PROPHET, HEAVEN
MY FOOTSTOOL."—



Plate 915

BUILT HIM AN HOUSE.
HIGH DWELLETH NOT IN
WITH HANDS; AS SAITH THE
IS MY THRONE, AND EARTH
ACTS VII : 47, 48, 49.



Plate 918



Plate 933



Plate 917

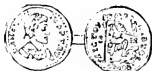

921



920



919

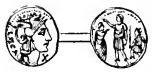

924



923



922



927



926

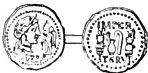

925



930



929

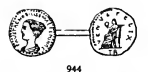

944



931



932



928



936



935



934



939



938



937



942



941

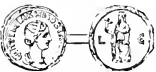

940



916

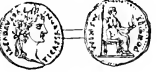

945



943

REMEMBER: ISAIAH, chapter 13, verses 11, 12 and 13: "And I will punish the world for their evil and the wicked for their iniquity; and I will cause the arrogancy of the proud to cease, and will lay low the haughtiness of the terrible." 12—"I will make a man more precious than fine gold; even a man than the golden wedge of OPHIR"—O F I R. 13—"Therefore I will shake the heavens, and the earth shall remove out of her place, in the wrath of the Lord of hosts, and in the day of his fierce anger." All prophecies will be fulfilled that have not been already, for all the great and small.



**N THE STAR OF ÆGYPT
PURE GOD, IN THE
names of Ava and Adam. It
their form to my gr. parents
parent. It is the Star of
pyramids and one of Lake Oregon, U.S.A.**



Plate 953

**IS THE SACRED NAME OF ONE
PRIMITIVE LANGUAGE AND THE
beareth our ancient Seal, that is kept from
Deed and Power of Attorney to my
U. S. A. and hath pictured thereon the**

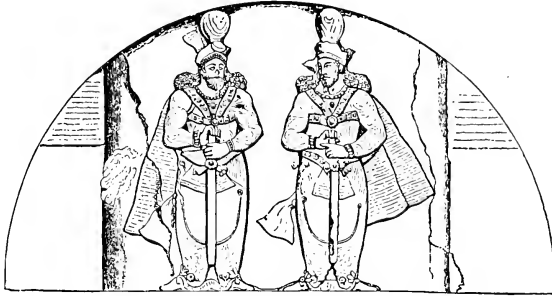

**BAS-RELIEF, NEAR KEOWANSHAW, REPRESENTING SAPHOR II. AND SAPHOR III.
Generation 113. Plate 946.**



Plate 952

It represents Sun.



Plate 946.

It represents Son.



Plate 957.

**It counts Five Indian
Nations & Six Families.
It beareth Primitive Al-
fabet. Spelt Alphabet by
grammarians covering
true history.**



Plate 954.

**This Roman Lamp hath Peter
Faneuil tomb Seal and Heb. R. etc.**



Plate 948.

**It is a promise of Univer-
sal International Geneal-
ogy Monuments for all
the World of God's
People.**



Plate 950

**GOD IS THE GREAT-
EST LIGHT, and gave
it to the World by Sun,
Moon, Stars, Lamps,
Good Acts, Great Men!**



Plate 955 is C. A. F. initials.

**It hath the copy of C.; Christ
wrote in Dighton Rock, found.**



Plate 949.

**IT is the promise of the
coming and going of
Christ the SON of GOD,
who came, went and will
come again. A=A.: Ana-
mona, O is the ancient
name Fa=GOD, name.**

FOR LOVE, HONOR, NA-
 AND HAPPINESS CALL
 ISAIAH LI, VS. 4 AND 7.
 AND NATIONS!! Listen

biased attention to my words,
 proceed from me, and I will make my judg-
 Notwithstanding our foes of the Vatican
 favoring the three greatest causes that
 fall of Nations, States and In-
 \$1,800,000 has been used with
 emanating from unholy cabals
 years they have continued to
 eous judgment by God, the
 Omnipotent, Omnipresent,
 for it. See Pamphlet with
 aiding our foes to cease their
 TION. Gather the good
 all his BELOVED NA-

"Blessed are they that
 doeth righteousness at all

"Fools, because of their
 iniquities are afflicted."

"They reel to and fro,
 man, and are at their

"And there shall
 the stem of Jesse, and a
 his roots; and the spirit
 on him, the spirit of wis-
 the spirit of counsel and
 knowledge of the fear of

"They did not de-
 concerning whom the Lord
 they sacrificed their sons
 devils, and shed innocent
 their sons and of their
 sacrificed unto idols of
 polluted with blood."

No man is
 person that per-
 ligious one who
 lief and serves
 to the dictates

"Say unto
 my sister; and
 ingthy kinswo-
 VII, 4.

"But why
 thy brother, or
 set at naught
 For we shall all
 judgment seat
 mans, 14, 10.



PLATE 997.



PLATE 998. AN ÆGYPTIAN SCENE.

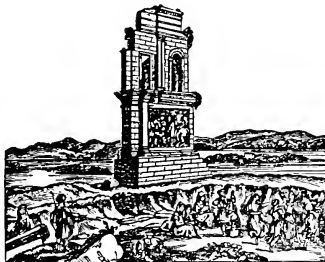

PLATE 999. SEVEN HILLS OF ROME. MARS HILL.



PLATE 1000. TRINITY MOUNDS, MINNESOTA, U. S. A.

TIONAL SAFETY, PROSPERITY
 THE ATTENTION OF ALL TO
 AND SAY: AMERICA. HAGUE
 unto me, all my people; and give un-
 O my Nation: for Three Laws shall pro-
 ment to rest for a light to the people.
 have decided to defeat them by duplicity
 from time primeval has caused the down-
 individuals, which to defeat
 all the subtle arts Satanic,
 and conspiracies, for thirteen
 oppose it; at the day of right-
 only just and perfect judge
 Omniscent, to be condemned
 this book for Universal good
 and your self DESTRUC-
 fruits God hath given unto
 TIONS OF EARTH.

keep judgment, and he that
 times."

transgression, and because of

and stagger like a drunken
 little wits' end."

come forth a rod out of
 branch shall grow out of
 of the Lord shall rest up-
 dom and understanding,
 might, the spirit of our
 the Lord."

stroy the Nations, com-
 manded them. Yea,
 and their daughters unto
 blood, even the blood of
 daughters, whom they
 wrong; and the land was

a pure religious
 secuted the re-
 is sincere in be-
 Cod according of
 conscience.

wisdom, thou art
 call understand-
 man." Prov.

dost thou judge
 why dost thou
 thy brother?
 stand before the
 of Christ." Ro-

87197 Mr. J. H. Smith
 N.Y.

“**H**EARKEN UNTO ME,
NESS, THE PEOPLE
LAWS: FEAR NOT
NEITHER BE YE



Plate 1001

Plate 1001—The temple of Jove, has only the primitive alphabet but other history. Foni was old spelling of Jove.

Time is what we want most, but must all give an account when time shall

Whatever thou takest in thou shalt never do amiss.

Plate 1002—From Jewish “Hic est praitus Tubias Bar Za Har Bar Za Har Ona.” It is interesting Greek, Latin with the Hebrew peated. They descend from May 11, B. C. “□ⁿξΕα□γξν=”



Plate 1002.

Charles V, Emperor of minions and retired to lead a mony of Christian religion:— in it sweets and joys that courts

Sir Francis Walsingham, to Lord Burleigh:—“We have try, to our fortunes, and to our we begin to live to ourselves, properly live to the latter with-



Fig. 391.—EGYPTIAN GOLD VASE.—See PAGE 40.

Plate 1003.

In that day shall the Lord in the midst and a pillar at the the Lord, and it shall witness unto the land of Ægypt, for the Lord because of he shall send them a one, and he shall they shall vow a vow keep it. The Lord saying, Blessed be and Assyria the work Israel mine inherit-

Men should connot made for themciety, for each other,



Plate 1004.

Ægypt's Found Cave Historic.

YE THAT KNOW RIGHTEOUS- IN WHOSE HEART ARE MY THE REPROACH OF MEN, AFRAID OF THEIR REVILINGS.

cut on it and so constructed as to give not distinctive features of ancestral religious

what we use the worst, and for which we be no more.

hand, remember the end, and

Catacomb in Via Portuensis:— Ona et Tare Carius filius Tubias to note that this inscription is in פלפ = Peace four times Fnr Saraho and Fna Si Hasi 3476, PEACE”, not correct.

Germany, resigned all his do-religious life; and left this testi- “the sincere profession of it had were strangers to.”

towards the end of his life, wrote lived long enough to our coun- sovereign, it is high time that and to our God.” We cannot out loving the preceding.

there be an altar to of the land of Ægypt border thereof to be for a sign and Lord of hosts in the they shall cry unto the oppressors, and Saviour, and a great deliver them,—Yea unto the Lord and of hosts shall bless, Ægypt my people, of my hands, and ance. Bible.

sider that they were selves, but for so- and for God Just.

“**A** WISE MAN WILL
LEARNING; AND
SHALL ATTAIN



HEAR AND WILL INCREASE
A MAN OF UNDERSTANDING
UNTO WISE COUNSELS.”

Plate 1005—Reverse of the Great

Seal of U. S. not adopted at 1776.

Truth may be expressed with-
out art or affectation: but a lie

out art or affectation: but a lie

Plate 1006—An ancient Man-
ner Compass with Sea green flag
left by him in Dighton Rock,
U. S. A. It was a present from
great naval victory.



Plate 1006—Roman Compass.

cus Agrippa Lucius Furnius Mari-
picted with history of its being
Taunton River, Massachusetts,
the Emperor Augustus for a

When the Emperor Conerade
ria, he would not accept of any
should be prisoners, but that the
without violation of their honor,
could carry about them, which
contrived to carry out on
hands and children, and
Emperor was so affected with
that he treated the Duke and
great humanity.

besieged Guelpho, Duke of Bava-
other conditions than that the men
women might go out of town
on foot, with so much only as they
was no sooner known, than they
their shoulders their hus-
even the Duke himself. The
the generosity of the action
his people ever after with

When we combat error
argument, we err more than

with any other weapon than
those whom we attack.

Truth in everything is
great Author, can be but
reason stands as firm as the
Reason is ever allied to truth.

still the same, and, like its
one: and the sentence of
foundation of the earth.

Hypocritical piety is



Plate 1007—White Mountains Scene.

double iniquity.

The Fanatic Bigot said:
published a book.”

“Oh, that mine enemy had

Tricks and
practice of fools, that
enough to be honest.

The Primitive
best friend of all.

Plate 1008—
man Catholic Bible,
the Expulsion of
the Garden of Eden.

Amicus Plato,
magis amica Veritas.
my friend, Socrates is
is my best friend.



Plate 1008. Garden of Eden scene (?) from my Roman Catholic Bible.

treachery are the
have not sense

Bible, Truth is the

Copy from my Ro-
as made to illustrate
Adam and Eve from

amicus Socrates, sed
Translation: Plato is
my friend, but Truth

“**G**IVE INSTRUCTIONS
BE YET WISER:
WILL INCREASE
ONE HAGUE! ONE



Plate 1009.

TO A WISE MAN, AND HE WILL
TEACH A JUST MAN, AND HE
IN LEARNING.”—Proverbs IX : 9.

BANNER!! ONE GOD!!!

sell the public interest.”—Solon.

Plate 1009—One Ring of
His remains, ashes in an urn,

Fame is as difficult to be
acquired.

For it shall be, that as a
nest, so the daughters of Moab
or Anona.

The whole earth is at rest,
forth into singing.



PLATE 1010—PANTHEON.

A man who is rightly hono-
do, but to what he should do.
tenance: speaks the truth: his
the blush of recantation: nor
good a lie with the secret glosses
Gent. Lib.

Plate 1010—Temple of
face coin with the Roman Ægle
Cross as it is in many prints seen
cut his name on Dighton Rock,
of General George Washington,
the United States of America,
from his and Bahman line of
foremother, by marriage with
peror of China, who descends
Omo, Annona, Augustii, now
their names are cut on Dighton
name by itself. Also C.

絲不可道

赫多阻兮有斐君子

如球如璧琴兮間兮

有斐君子如切如磋

瞻彼淇濱美芹竹猗猗

A Chinese Ode.

PLATE 1011.

Marcus Agrippa Lucius Furnius.
are at the Pantheon.

preserved, as it was to be

wandering bird cast out of the
shall be at the lords of Arnon

and is quiet: they shall break

est, looks not to what he might
He wears always the same coun-
cheeks are never stained with
does his tongue falter to make
of a double or reserved meaning.

Generation 94, whose excellent
or Eagle on staff not changed to
by writer. He, M.A.L.Furnius
29 B. C., and was the ancestor
the honored worthy Father of
that eleven generations after him
descendants, inherits from his
Fur Chia, daughter of the Em-
from Fut, a strong claim on
called America. All three of
Rock: afterwards Washington's
Furnius over M. A. L. Furnius.

Plate 1011—To

All ye inhabitants of
on the earth, see ye, when
on the mountains; and
pet, hear ye.” Isaiah 18:3.

And the works of
peace; and the effects
forever.

They also that err in
standing, and they that
doctrine. Woe to the
the Lord, that taketh
and that cover with a
spirit, that they may add sin to sin.—Isaiah XXIX. 24; XIV. 1. “God loveth not a quitter.”

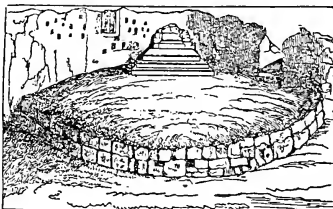

PLATE 1012

honor.

the world, and dwellers
he lifteth up an ensign
when he bloweth a trum-
righteousness shall be
quietness and assurance

spirit shall come to under-
murmured shall learn
rebellious children, saith
counsel, but not of me;
covering, but not of my



“**U**NDERSTANDING IS HIM THAT HATH
In the pursuit of know-
like fern, it is the pro-

coin, its circulation is not restricted to any par-
ticular class. We are ignorant in youth, from
idleness, and we continue so in manhood from
pride: for pride is less ashamed of being igno-
rant, than of being instructed and she looks too
high to find that which very often lies beneath
her. Therefore, condescend to men of low es-
timate, and be for wisdom, that which Alcibi-
des heard only one sound: and he that lives with
great drama of life. Mr. Locke was asked how
power. He that rings only one bell, will
with great drama of life. Mr. Locke was asked how
only one class will see but one scene of the
knowledge so rich, yet so extensive and so deep.
he had contrived to accumulate a mine of
what little he knew to the not
He replied that he attributed
for information; and to the
having been ashamed to ask
versing with all descriptions
rule he had laid down, of con-
ly that formed their own pe-
fidence of men, on those topics chief-
In the voyage of life, men
cular professions or pursuits. en, but take care not to ven-
profess to be in search of heav-
erations to it, as to entirely
ture so far in their approxi-
should their frail vessel be in
lose sight of earth: and will
danger of shipwreck, they
gladly throw their darling
vices overboard, as other mar-
inners their treasurers, only to
fish them up again when the
danger or storm is over.

A clear and well de-
proper rule of life, the dis-
wrong, in our mind, must
ing; but clearly ascertained
Our view of duty must be
ims of a loose and pliant
word of God, and the dis-
science. There must be a
lively feeling of obliga-
would “feel a stain like a
shrink at the very appear-

None should despair
them; and none should
can cross them.

America honors its
withstanding the poetical
my tent and lay down in
a season on bitterness fed;
gone to the hills of the
hunger or lingering
white man hath swept



A WELLSPRING OF LIFE UNTO
IT.” Proverbs xvi, 22.

ledge, follow it wherever it is to be found
duce of every country, all climates, and like

particular class. We are ignorant in youth, from
pride: for pride is less ashamed of being igno-
high to find that which very often lies beneath
her. Therefore, condescend to men of low es-
timate, and be for wisdom, that which Alcibi-
des heard only one sound: and he that lives with
great drama of life. Mr. Locke was asked how
power. He that rings only one bell, will
with great drama of life. Mr. Locke was asked how
only one class will see but one scene of the
knowledge so rich, yet so extensive and so deep.

Plate 1013. ROMAN STANDARD



Plate 1014

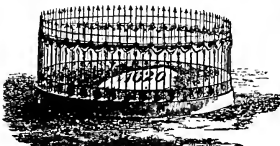

Plate 1015. PLYMOUTH ROCK.

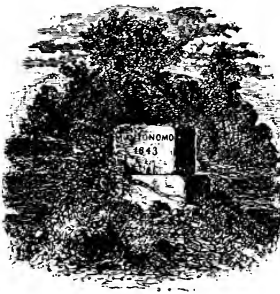

Plate 1016. TOMB OF MIANTONOMO.

finer knowledge of the
inctions between right and
not be vague and fluctuat-
and thoroughly settled.
derived, not from the max-
morality, but from the
tates of an enlightened con-
quicker perception, and a
tion, a moral sense, that
wound,” and cause us to
ance of evil.

because God can help
presume, because God

true noble Indians, not-
lament; “I will go to
despair; I will weep for
For my kindred have
dead. They died not of
decay, the steel of the
them away!”

F

ARTH HATH NO MYSTERIES CONCEALED FROM GOD ITS CREATOR WHO ESTABLISHED BY HIS SONS THE HAGUE THAT IS PROLIFIC OF GREAT GOOD. MAY HISTORY RECORD THE GREATEST ?

Plates 1017 and 1018—Golden Soteric and Prophetic.

Plate 1019—Greece was founded by Had Phroneus: Had Ce-Cro-Pia Cecro(p)fs: then Attica and then it French and Cric Chen Land by Ger-As-G-IANS=⊙ Δ ⚡ Δ ○ € Δ -C=F. Atti, s. of Ce Cro Pia, m. Athenia=A. their son Pel As G Ions was a Fonecian tians. From Athenia was the name of wife Athenia were skillful in the scien-Zenon Zus who was honored as is to be in a manner copied by the Roman persons called Saints, and keeping as was customary with the Ægyptians, Ionians, and other ancient and modern idolatry or intent to commit idolatry, gious denomination is very pure when not withstand the temptations of riches, inherited traits from Adam.

The facts that the Ægypto-existent, and that there was the slopes of the hills toward the cisterns, cellars and remains in erally known as the "Rock City" nicians in the 13th century B. C. tion of the olive tree, so well soil of the land.

Few cities, if any, can boast Standing upon the Acropolis, we ca bettus, a conical-shaped summit Zenon Zus rum where now stands cated to St. George, Greeks.

Roma was foun-B. C. who m. Fnr of Serpent Mound.

Do not evil that evil will be punished

Our Saviour divi-and let no one pre-hath put asunder.



Plate 1017



Plate 1018.



Plate 1019—View of Athens.



Plate 1020—Lake Pepin. Named for King Pepin, Ancestor. Of France.

Vases from Ægypt; Historical, Sym-

Fna Chua, s. of F. Utnas and F. Naomi: (founded Athens) son of Phernes Fana was from G. Rai Koi called, Greece by mans. The Greeks called them Pel-Fal As G I or Fans=Ians or Ions. Fenia, da. Poseidon and Trit Onis, and the Ph=Fonecians were Ægypt-Athens the capital of Attica. Atti and ces, arts and arms. They had a son found by Tablets to the "Highest Zeus" Catholic Church in honoring good relics to commemorate their good acts, Fonecians, Chinese, Chaldeans, Baby-nations, even unto this day without any sacrilege or sin. As a rule every reformed, but being like many men can-power, success without revealing their Cain and Noah.

tians, Hebrews and Greeks were a settlement of the Fonecians on sea, numerous graves, steps, seats, form, constituting what is gen-with the facts of visits by Foe-teaching, bringing arts, cultiva-suited to the dry and chalky

of a more beautiful situation. may see to the east Mount Ly-mount, 911 feet high, on whose had sanctum sancto-a small chapel dedi-the patron saint of the

ded by Fna Fnf, 1700 Anona of Omo Land

good may come: all by perfect judge God.

ded force from reason, sume to join what God Similia ad Similibus.



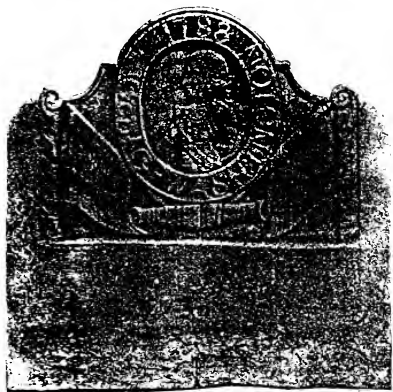

PLATE 1346—THE WASHINGTON FERNALD IRON TABLET.



JOHN WASHINGTON.
Generation 156.
W. 158. Fernald.



*PLAN OF
GOVERNOR'S
HOUSE*

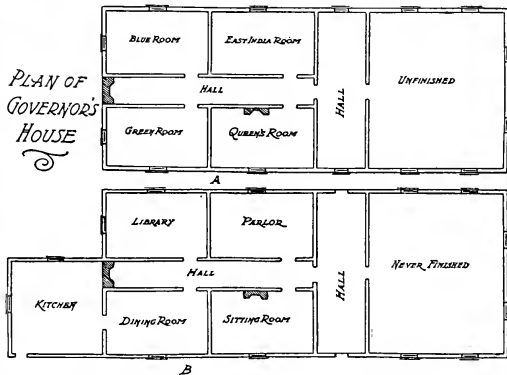

PLATE 1405.

Plate 1405—Governor John Wentworth's Wolboro, N. H., mansion. Courtesy of Editor "Granite State News," gratefully appreciated forever: forwarding loyal patriotic efforts, 1346 Col. Tobias Fernald, Capt. Abraham Fernald with John Fernald and his wife, Mary Savage, cannot be too highly honored for their bravery and true, zealous labors for Mother England, and, after the American Revolution began: their zeal and strenuous work for the United States, highly honored by General George Washington, the best, greatest and most beloved man in America.



Plate 314—The Indian Mother
defending her child.
Poman Coin, historic with the
Star of Egypt.
FOR PEACE.

This page is written as substitute for one of five, illegally taken by the Quadruple Ring, opposed to the Hague and the Enactment of our Three Great Moral Reform Temperance Laws.



GENERATION CXIV.

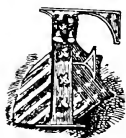

Plate 956. Generation 114

NR CONSTATINA, da. Constantinus the Great and Minervina, b. 9 Dec. 322; d. 2 Oct. 409; m. FNA



Plate 957. Generation 114

FARA MOND = PHARA-

MOND, s. F. Shapur Z—K. and F. Car Zama, b. 6 Oct. 327; d. 22 Jun. 420; Had F. Mund Zunk: et als.

GENERATION CXVI.

FNR HILDA, da. Constans Flavius who was called Farnius Julius, b. 2 Mar. 351; d. 1 Aug. 364; m. FNA ATTILA, "The Scourge of God," b. 8 Aug. 364; d. 22 Jun. 453; Had M. Frna C = Frna Clovis = Irna C: sons and daughters.



Attila. Plate 959. Generation 116

King Agrippa, believest thou the prophets? I know thou believest. Then Agrippa said unto Paul, Almost thou persuadest me to be a Christian.—Acts 26:27-28.

GENERATION CXVIII.

FNR SARAH, da. Constantinus and Fausta, b. 1 May 410; d. 9 Jun. 457; m. JOANNES MEROVÆUS, b. 12 Jun. 413; d. 23 Nov. 483; Had Childerick: et als.



Plate 961. Gen 118.

Attention is respectfully called to the months and dates of the months on this long line of genealogy of universal foreparents with resemblance in features. On the Plates and in the impression is to be seen and read from primitive language information to which line and generation he belongs. Hence the change from old to true data as per Bible of found lost Hebrew language.

GENERATION CXV.

FNR C. IRENA COMMENA, da. Isaac, s. Lucieus, s. F. Fernis and F. Ana F., b. 6 Jan. 347; d. 20 Nov. 436; m. FNA MUND ZUNK, b. 6 Mar. 347; d. 20 Sept. 437; Had Attila, the prophetic sword of God: et als. Fara Mond was buried in a pyramid, near St. Denis where many of the kings were laid to rest. Have, about 250 years old, a colored plate of Tomb, Pyramid shaped, in which he was laid to rest: before this St. Denis and several buildings, etc. Have also two more colored prints or engravings of about the same age: Notre Dame and Versailles, for Second Edition intended. Every wicked course is adopted to prevent this by crime for crime, vs. State, United States and Nations.



Plate 958. Gen 115.

GENERATION CXVII.

FNR ARIDNE, da. Zeno and Ari Ducta, b. 22 Nov. 389; d. 23 Nov. 468; m. FRNA CLOVIS, s. of Attila and Hilda, b. 1 Aug. 384; d. 23 Nov. 460; Had Joannes Merovæus: et als.



Plate 960. Gen. 117.

GENERATION CXIX.

FNR ALA FENIUS, da. Vasa Al Fenius and Veria, b. 23 Jun. 428; d. 10 Jun. 490; m. FNA CHILDERICK, b. 10 May, 432; d. 9 Oct. 500; Her father was 11th, and she 12th generation from Petrus Varus Ali Fonius: Had F. F. F. Clovis.

Fig. 5



PORTRAIT OF VARARAS V. (FROM A SEAL).

See Gen Pl 962. Fna Childerick

It is interesting to find that the same Birth marks exist to day that were found described on the Antioch kings found described in a very old book by the Author. It is a brown spot that varies in size and location in three generations examined: 4th Generation not as yet examined by writer. Although three aged Fernalds declared that the birth-mark extended to their greatest ancestors.

Si parvat licet componere magnis. Translation: If it is allowable to compare small things with great.



CEASE, MY BROTHERHOOD OF MANKIND, TO HEAR THE INSTRUCTIONS THAT CAUSETH TO ERR FROM THE WORDS OF KNOWLEDGE. IT IS AN HONOR TO CEASE FROM STRIFE.

GENERATIONS CXIX and CXX.

FNR CLOTILDA, da. Chilperic, King of Burgundy, b. 1 Dec. 447; d. 11 Jun. 527; m. FNA F. F. CLOVIS, b. 4 Nov. 448; d. 10 Dec. 512:

Had
Cloth-
arius:
Childe-
bert:
Clodo-
mir:
Thiary:
Ingom-
erius:
Theode-
childa.



Plate 962. Generations 119 and 120. Symbolic. Childeric, Clovis and Clotilda.

GENERATION CXXII.

FNR BRUNECHILDE, da. Athangildus k. Visgoths, b. 22 Oct. 500, Bible Records; 537 French Records; d. 22 Apr. 613; m. FNA SIGEBERT, b. 10 Jun. 493; d. 22 Oct. 575: Had Childebert II: 2 das.: Ingonda: Clotilda: Many descendants living in 15th and 16th centuries. Most of those living in America did not know their

descent that was concealed, to prevent sudden deaths.



Plate 964. Gen. 122.

GENERATION CXXIV.

FNR THUDACHILD, da. Tiberius, Emperor of the East, b. 3 May 580; d. 1 Jan. 613; m. FNA THIERRY, s. of F. Childebert and F. Failuba, b. 2 Aug. 590; d. at Metz, 21 Sept. 613: Had F. Pepin; Childebert; Meroveus and Gontran: due to the Turkish marriages, the Roman Catholic Church and King's Cut off line.



Plate 966. Gen. 124.

GENERATION CXXVI.

FNR ZADA BAGA, da. Mahomet's da. Fatimi and Ali, and sister of Ha Fne, b. 1 Dec. 641; d. 1 Oct. 702; m. FNA BAGI ZADAH=BEGGA, b. 1 Sept. 636; d. 10 Jun. 719: Had Pepin de Heristal.



Plate 961. Gen. 126.

GENERATION CXXI.

FNR INGONDA, da. Justin I, Emperor of Rome, b. 1 Jan. 469; d. 1 Jun. 549; m. FNA CLOTHARIS, b. 10 Aug. 468; d. 10 Nov. 562: Had Siebert; Cherebert: Gontram: Chilperic: and two das. French Records give him four more wives: Bible but one: I choose the Holy Bible.



Plate 963. Gen. 121.

As it is written, There is none righteous, no not one.—Romans 3:10.

GENERATION CXXIII

FNR FAILUBA, da. Anharis, k. Goths, b. 8 Apr. 570; d. 2 Dec. 638; m. FNA CHILDEBERTII, b. 25 Dec. 571; d. 1 Jan. 596; s. F. Sigebert and F. Brunechilde: Had Thierry; Theodebert; and Brunechilde. This Theodebert had a gold coin struck claiming his Roman descent: Proved by Holy Bible and part of French Records that have been tampered with, as Bible by wicked, that has deluged the earth with blood: God's Curse foretold fulfilled.



Plate 965. Gen. 123.

N.B.—Bible Records and French differ.

GENERATION CXXV.

FNR AYASHA, da. Mahomed and Ayasha, b. 1 May 572; d. 7 Jun. 649; m. FNA PEPIN, =FAFIN, b. 1 Oct. 607; d. 10 Sept. 639: Had Bagi Zadah=Begga; Charles the Hammerer: Herefore may be observed the cause, reason, or lack of wisdom in allegations concerning Mayor of the Palace.



Plate 927. Gen. 125.

GENERATION CXXVII.

FNR PLECTITUDE, da. Aribet, s. Arbet, b. 28 May 670; d. 3 Jun. 729; m. FNA PEPIN De HERISTAL, b. 5 Oct. 662; d. 14 Sept. 714: Had Childebert; Carloman=Charlemain; Gille.



Plate 969. Gen. 127.



REJOICE AND BE GLAD, FOR AFTER THE RAIN COMETH THE SUNSHINE,
BRINGETH FLOWERS.

GENERATION CXXVIII.

FNR CLOTILDA,
da. Baggis, s. Bagga, s.
Charibut, b. 5 Oct. 696; d.
1 Sept. 748; m. FNA
CIIIH, DEBERT, b. 9 May
692; d. 10 Dec. 771. Had
Robert, called Le Fort.



Pl. 970. Gen. 128.

GENERATION CXXX.



Alfred the Great. Pl. 972A

FNR ALSATHA,
da. King Ina the Law
Maker's, s. Fna and Anr
and gr. da. o: Alfred the
Great, b. 3rd May,
870; d. 23 May
918; m. FNA
ROBERT DUKE,
FRANCE, b. 1 Feb. 844; d.
10 May 923. Had Hugh,
after called, the Great.



Pl. 972. Gen. 130.

GENERATION CXXXII.

FNR ADELAI, da.
William III Tower Head,
b. 18 Oct. 942; d. 4 May
1002; m. FNA HUGH
CAPUT, b. 23 Dec. 941;
d. 24 Oct. 996. Had Rob-
ert the Pious, Havide, Ade-
laid, Goslinda. French
Records say: "Nat. s. Gos-
linus Archbishop of Bourges,
1029." Priests
should m. and obey God's commands.



Pl. 974. Gen. 132.

GENERATION CXXXIV.

FNR ANNE, da. Jar-
aslau, king of Russia, b. 3
Apr. 1010; d. 26 Nov.
1042; m. FNA HENRY I,
b. 23 Apr. 1010; d. 30 Dec.
1060. Had Philip: Robert:
Hugh: Ancestors of Anne
Igor m. Princess Olga-Svi-
atoslaff, kil. 972; 3 Valdi-
mer m. Anne, sister, Gk, Emp. Boslryus
Porphyrogenitus 2 Yaroslav, or Iaro Slav, or
Jaraslau, d. 1054, aet. 77. Henry I, m. old-
est da. of oldest line wife, see seal. Bur. St.
Denis.



Plate 977. Gen. 134.

GENERATION CXXIX.

FNR ALIF, da. Ver-
imund=Fri Mund, king
of Spain, b. 1 Oct. 792; d.
3 Jun. 846; m. FNA ROBERT
Le FORT=the
Strong, b. 10 Oct. 748; d.
10 Oct. 867 and ancestor of
Pike family in U. S. of
America. Had Robert,
Duke of France.



Pl. 971. Gen. 129.

GENERATION CXXXI.

FNR EDGINA, da.
Otho I and Theo Fania, sis-
ter of Emperor of Germany,
b. 10 Oct. 897; d. 17 Nov.
960; m. FNA HUGH
THE GREAT, b. Oct. 896;
d. 10 Oct. 956. Had Hugh
Caput: Otho: Henry:
Emma: Beatrix. Records
state Hugh the Great, s. Robert Duke of
France and Alsatha, da. k. Fna and Anr, da.
Ceadwall who m. d. of Tiberius son of Jus-
tinian II: Tiberius m. FANA=JANA da.
Alfred the Great. Ceodwall had a monu-
ment erected to him: Tradition related he
was a "Pagan" yet a child of God.



Pl. 973. Gen. 131.

GENERATION CXXXIII.

FNR CONSTAN-
TIA, da. William Cut Iron,
b. 29 Jun. 970; d. 7 Mar.
1032; m. FNA ROBERT
THE PIOUS, b. 13 July
971; d. 20 July 1031. Chn.
of Robert (133) Hugh:
Henry I: Rob.: Eudes:
and Adelaïd: Adelia=Alisa,
m. Richard III. See Deed of 1026. Bible
Records prove sd. Robt. and Chn. He re-
fused kindly offered kingdom of Italy by
Italians. Bur. St. Denis: F. R. he m. Ber-
tha, wid. Eudes I. Had trouble with Pope
and Excommunicated, separated by Gregory
V. This Robt. F. A. M. is recorded on my
Coin, Medal of Temperance Washington, m.
Thomas Fernald and Pike family in primi-
tive language there is Recorded.



Pl. 975. Gen. 133.

GENERATION CXXXV.

FNR BERTHA, da.
Florentius, b. 3 Aug. 1050;
d. 1 Dec. 1093; m. FNA
PHILIP I, b. 3 Jan. 1051;
d. 29 July 1108. Had Lewis
VI: Henry, d. y.: Charles:
Constancia: Fr. R. sd. Nat-
Phillip: Fleury: Cecilia:
Eustache a da. Bur. at Ab-
bey St. Benedict, Loire called St. Benoit.



Pl. 978. Gen. 135.



URITY, AS A WORD FITLY SPOKEN ARE LIKE APPLES OF GOLD IN BEAUTIFUL PICTURES OF SILVER.

GENERATION CXXXVI

FNR ADELAID, da. Humbert Count of Maurieme and Savoy, b. 11 Mar. 1098: d. 22 Aug. 1154: m. LEWIS VI, b. 1 Apr. 1070: d. 1 Aug. 1137: Had Philip: Lewis the Young: Henry: Hugh: Robert: Peter, surnamed Mauclerc, was Count of Britiany, m. Alice, heiress from whom Anne of Britiany descended: Philip: Peter, m. Isabella: Constantia, m. Eustace:



Gen. 136. Plate 979.

GENERATION CXXXVII

FNR ALICE, da. Thibaud, Count of Champagne, b. 17 Aug. 1136: d. 31 July, kil. 1206: m. LEWIS VII, b. 17 Aug. 1117: d. 18 Sept. at Paris 1180: Had Philip-Augustus; Alice; Agnes: French Records give him two more wives and chn. Eleanor who he properly repudiated; Had Mary and Alice; Constantina, da. Alfonso VIII, 1160: Had Margaret, m. Henry the Young and Bela III, k. Hungary, 1197, and had Alice: bur. at Baieux:



Gen. 137. Plate 980.

GENERATION CXXXVIII

FNR ISABELLA, da. Baldwin, Count of Hainault, b. 22 May 1160: d. 3 Feb. 1190: m. FNA PHILIP II AUGUSTUS, b. 15 July 1164: d. 14 July 1223: Had Lewis VIII: Philip, Count of Boulogne: Mary, m. Philip, Count of Namur, 2nd. Henry I, Duke of Brabant: Nat-s. Peter Charlot: 2nd. m. Ingeburga, da. Waldemar, and sister of Canute, ks. of Denmark: Philip put her away: Innocent III, obliged him to take her again. She d. 1236: m. 3rd. Agnes of Merania, da. Duke of Dalmatia: he repudiated her: it broke her heart: d. 1211 He, bur. St. Denis.



PHILIPPE II.

Gen. 138. Pl. 981

GENERATION CXXXIX

FNR BLANCHE, da. Alfonso IX, k. of Castile, b. 21 Aug. 1180: d. 11 Aug. 1252: m. FNA LEWIS VIII COEUR DE LION, b. 5 Aug. 1187: d. May 7th. 1226: Had Philip, d. y.: St. Lewis: Robert Count of Artois: Philip, d. y.: John Count of Anjou and Maine, d. y.: Alfonso, Count of Poitiers and Toulouse; Philip, surnamed Dagbert, d. y.: Stephen, d. y.: Charles, Count of Anjou and Provence, k. Naples, d. 1295; Da. d. y.: Isabella d. 1269, a saint in abby Louchamp, she founded. Blanche sister Beranger, m. Alfonso, k. Leon; Had s. Ferdinand, k. of Castile to prejudice of Lewis IX: Church enrolled both as Saints. He bur. at St. Denis.



LOUIS VIII.

Gen. 139. Pl. 982.

During the dark ages nearly all history "was lost". As men became better educated, they searched for the lost truths, and found many valuable facts, and much they did not understand! Alas!! They attempted to translate unknown to them matters, under the great difficulties of persecution, and, often death, if they dared to write truth. We cannot too highly appreciate those who did all they could for us.

IN THE EPOCH OF CHARLES VIII, THE HISTORIANS DID THEIR BEST TO PLACATE ROMAN PONTIFFS, WHO WERE SO DEGRADED THAT SIXTUS 4TH DECREED THAT POPES' NATURAL CHILDREN "BE Princes by right of birth, and established a Lupanar at Rome." Paul, "Religion ought to annihilate science, because science is the enemy of religion." Their misnomer.



CHARLES VIII.

PL. 1022. Gen. 149.

Charles VIII the Courteous, beautiful in person and mind, eyes bright grey and light brown hair, worn long and in curls, possessing the courage of his forefather, Pepin who alone of his officials dared to with the ancient Furni sword face and slay the Lion in the amphitheater: was led by his great love of humanity represented by most noble foreparents, that but few have equalled and none excelled. Attempted to reform the horrible state of immorality existing in France that was typified by the Borgias. Went to the fountain head by assembling an army and on Rome marched. Rome that had duped his father and used him as a tool prevented his education against his desires. No sooner than he became his own master than he wisely pursued his studies with indefatigable zeal. He was gentle till some great occasion aroused him. Ever considerate of others and it was said that never in his life did he say wilfully a single word to give pain to others. Lewis or Louis XI added greatly to his domains during his lifetime. Took by force a large district from Burgundy. Acquired Boulogne by purchase. The Bretons were defeated at St. Aubin, July 28, 1488 Duke of Orleans captured. The Duke of Bretagne did not long survive his defeat, leaving Anne the sole heiress of the duchy at thirteen years of age. Though young, she possessed a strong and vigorous mind, and discretion far beyond her years. Some advised her to marry the old Seigneur d'Albret, glorious spring and fading autumn. Others to marry Charles that she looked upon as the natural enemy of her family. Her choice fell upon Maximilian to whom for state reasons she was betrothed. He shamefully neglected her by not going to see her or sending troops to aid in her difficulty. Charles, seeing her neglected and not in love with Margaret that had been selected for him against his desires, renewed his suit backed by "50,000" strong arguments. The strongest was his love. He entered her capital in disguise and visited the Princess, pleading with such good success that he won his cause and they were married Dec. 10th, 1491.

With only 18,000 men and accepting the patriotic loan of the court ladies' jewels to raise money on for defraying his troops' expense he invaded Italy 1494. He proclaimed himself "the friend of Freedom and the enemy of Tyrants." "God blindfolded their eyes and had tied their hands by raising up this young king to chastise them for their impiety."

"1492 Christopher Columbus probably conversant with the Chart of Fna Chia and Bahman, after whom was named the Bahama Islands, and possibly with the trip here of Marcus Agrippa Lucius Furnius, that is corroborated by the Vatican retention of the coin of Newport, Rhode Island completed Tower. Showing their usual duplicity in claiming it as an emblem of the Hurdle Race. Alexander Sixth having brought Ferdinand the Catholic and King John of Portugal to choose him as mediator of peace. Drew a line which passed from pole to pole through the Azores or Western Islands, and decreed, by virtue of his universal omnipotence, that all the countries which were beyond the line, that is the West Indies, or America, should belong to the King of Spain, and those on this side, that is the East Indies and the shores of Africa, to the king of Portugal. His Holiness imposed no other condition on this magnificent gift than the immediate payment of a large sum of money and to convert, willingly, or by force, the inhabitants. Sixty years after this bull: 15,000,000 had been murdered by Missionaries." Is this the height of their religion, or the lack of it? True History.



UNTO THE KING THAT FAITHFULLY JUDGETH THE POOR, HIS
THRONE SHALL BE ESTABLISHED FOREVER.

When the scholars could not make a true translation, they would guess at the truth and arrange the matters so as to conform to their wishes or the desires of those in authority when the dark ages were passing away; thus error entered to be copied by the earnest and honest searchers after only truth. We labor for removing absurdities from history to advance the universal good for all; conformatory to God's first gifts unto our common parents.

Purity and its opposite exists in every rational person; that which we look for in faith we find in substance, feed meet for philosophical self-congratulation.

GENERATION 140

FNR Margaret, eldest da. Ramond II Count of Provence, b. 20 Nov. 1218; d. 5 May 1285; m. FNA LEWIS IX ST. LEWIS, b. 22 May 1214; d. at Tunis 25 Aug. 1270; Had Lewis, d. y.: Philip the Hardy; John, d. y.: John Tristan, b. 1250; d. 1270; Peter Count of Alencon; Robert Count of Clermont; Blanche, 1243; Elizabeth, m. Thibaud, k. Navarre 6 Apr. 1255, d. 1271; Blanche, m. Ferdinand de la Cerda, s. Alfonso X, k. Castile; Margaret, m. John, Duke of Brabant; Agnes, m. Robert II, Duke of Burgundy, 1327;

Wherein any manner of religious worship adds to the happiness of the individual, it is excellent.

GENERATION 141

FNR ISABELLA of Arragon, b. 19 Aug. 1230; d. 10 May 1271; m. FNA PHILIP THE HARDY, b. 11 Dec. 1245; d. 6 Oct. 1285; Had, Lewis, d. y. poisoned; Philip the Fair; Charles, Count of Evreux; Philip III the Hardy, m. 2nd. Mary, of Brabant in 1274; d. 1321; Had, Margaret, m. Edward I k. of England, d. 1317; Blanche, m. Duke Rodolphus of Austria, eldest s. Emperor Albert I.



LOUIS IX.

Pl. 983. Gen. 140



Plate 984. Gen. 140. Death of St. Lewis IX Canonized 11 Aug. 1297 by Pope Boniface VIII.

St. Lewis' flesh and bowels were removed to Montreal abby in Sicily and placed in a marble Tomb. His bones were carried to St. Denis and his head was removed from St. Denis and to the holy Chapel. Lewis XIII obtained a festival from Pope to be celebrated by the whole church.

GENERATION 142.

FNR JOLANTE, da. Alphonzo X, k. Leon and Castile, b. 23 June 1270; d. 21 Aug. 1321; m. FNA CHARLES De VALOIS, b. 6 Mar. 1267; d. 2 Dec. 1304; her mother was Iolante da. k. of Arragon; Had, Philip VI: John, kil.: John: Charles the Count of Valois son Philip ascends the throne: Charles De Valois is mentioned as a Minister 1325: Who was he?



Plate 986. Gen. 142.



PHILIPPE III.

Pl. 985. Gen. 241.

“REMEMBER THEM THAT HAVE RULE OVER YOU, WHO HAVE SPOKEN UNTO YOU THE WORD OF GOD.”

GENERATION CXLIII.



Pl. 987. Gen. 143.

FNR JANE, da. Robert, Duke of Burgundy, and Agnes, b. 13 July 1293; d. 23 Dec. 1348; m. FNA PHILIP VI. s. of Charles De Valois and Wife Jolante, gr. s. of Philip and Isabella, b. 26 Jan. 1293; d. 23 Aug. (Bible date) (French date 22nd) 1350: Had John; Lewis, d. at b.; Lewis, d. soon after b.: John, d. y.: Philip, m. Fnr Blanche, da. k. Charles the Fair, 1375; Mary, m. John of Brabant Duke of Limburg, 1333. Philip VI m. 1st, 1313; 2d, 1349: FNR BLANCHE da. Philip Count d'Evreux and Jane of Navarre: Had Blanche, 1371. Nat, s. John is mentioned as Count d'Armagnac, fought a duel with Knt. of Ipres in Flanders in 1350, signed "Simplician" who alleged a victory for said John.

GENERATION CXLIV.

FNR BONNE, da. John, king of Bohemia, b. 23 Aug. 1315: d. 26 Aug. 1349: m. FNA JOHN LE BON, son Philip VI and Jane, b. 8 Apr. 1320: d. 8 Apr. 1361: Had Charles V: John Duke of Berry: (Amadeus VIII, Duke of Savoy, was Pope Felix V time of schism, was this prince's gr. s. by Mary of Berry, his mother). Lewis, founder of the Dukes of Anjou, who formed second branch of the kings of Naples: Philip the Hardy, from whom the last Dukes of Bugundy were descended, 1404: Jane, w. of Charles, k. Navarre, 1373: Mary, m. Robert Duke of Bar: Agnes, 1349: Margaret, 1352: John Le Bon, m. 2d Jane, da. Wm. XII, Count of Boulogne and Margaret d'Evreux, 1349, d. 1361: Isabella, m. John Galeas, Duke of Milan, 1372; King John, bur. St. Denis.



JEAN LE-BON.

Pl. 988. Gen. 144.

GENERATION CXLV.



Plate 989. Gen. 145. Charles V. WARRIORS. Robert De Fiennes, 1380. L. Charles Da La Cerda of Spain, 1354. James De Bourbon, 1361. Walter De Brienne, 1356.

FNR JOAN, da. Peter, Duke of Bourbon, and Isabella of Valois, m. 1349, and was b. 11 May 1340: d. 7 Apr. 1377: m. CHARLES V. LE SAGE, b. 3 Aug. 1337: d. 16 Sept. 1380: Fna Charles the Wise, s. of John the Good and Bonne: Had Charles VI: Lewis Duke of Orleans: John, d. y.: Joan, d. y.: Bonne, d. y.: Joan, d. y.: Mary: Isabella: Catherine, m. to John De Berry, Count De Montpensier, 1388. Charles V, bur. St. Denis: Christian De Pisan, da. Thomas De Pisen, well named, agents: declared that the King d. the very hour her father predicted. She gives him title as "The King's Astronomer": translate poisoner and note the

deaths and persecutions to Charles VIII, who had energy enough to demand justice of Pope.

GENERATION CXLVI.

FNR ISABELLA OF BAVARIA, da. Duke Stephen, m. 17 July 1385, b. 1 Feb. 1370; d. 24 Sept. 1435: m. FNA CHARLES VI BON AMI, s. Charles V and Joan, b. 4 Nov. 1368: Crowned by Archbishop Pique=Pike, 4 Nov. 1380: and d. at Hotel de St. Paul, 20 Oct 1422, having led a life of repeated druggings, poisoned, and not only shamefully persecuted, but vilified by his powerful Vatican foes that he attempted to conciliate: Had Charles, d. y. kil. Charles, Duke of Guienne: Lewis: John: Charles VII: Philip, d. y. kil. at b.: Joan, d. y. kil. Isabella, m. Jane, m.: Mary: Michelle, m.: Catherine, m. Henry V k. England: papal muck throwers sd. had Nat-Margaret: Isabella carried in small boat to St. Denis where both were bur. The like is now carried on in U. S. of America, N. B. G. U. S. and F. A.



CHARLES VI.

Pl. 990. Gen. 146.

“**I**N ALL THINGS SHEWING THYSELF A PATTERN OF GOOD WORKS:
IN DOCTRINE SHEWING UNCORRUPTNESS, GRAVITY, SINCERITY.”
Paul to Titus, Chap. II, V. 7.

GENERATION CXLVII.



Plate 991. Gen. 147.

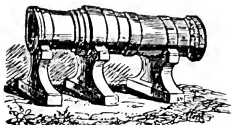

Plate 992. "Mad Margaret"
Some cannon kill both ways.

FNR MARY, da. Lewis II, King of Naples, b. 10 Feb. 1400: d. 23 Nov. 1463: m. FNA CHARLES VII, b. July 22nd: d. at Meun, France, 22 July, Th. 1461. Had Lewis XI: James of France, d. kil. y.: Philip of France, d. kil. y.: Charles of France, Duke of Normandy and Berry with Guienne. 1472: Radegonde: Catherine of France, m. Count de Charlois: Joland of France, m. Amadeus IX, Duke of Savoy: Joan of France, m. Duke John of Bourbon: Mary of France, d. kil. y.: Magdalen of France, m. Gaston Count de Foix: 1486. Had nat-chn. by Agnes Sorel supplied by R. C. C., as was offered in Boston by same in 1897, but here refused this bribe to work against state and U. S., and 3 more: Charlotte, m. James de Breze, kil. in ad-Lilley protects at B.: Margaret, m. Oliver de Coetivy: Joan, m. Antony de Bueil Count de Sancerre: Agnes Sorel poisoned after she had served her purpose: Fnr Mary was a princess of extraordinary merit, Charles VII the Victor, was wofully persecuted and poisoned, persecuted unmercifully: bur. St Denis. His distant relative Joan d'Arc, burnt to death 30 May 1431.



Plate 993. Gen. 148 Fna Lewis XI.

GENERATION CXI.VIII.

FNR CHARLOTTE OF SAVOY, da. Lewis II, Duke of Savoy and Anne of Cyprus, b. 30 Nov. 1420: d. 3 Nov. 1483: m. FNA LEWIS XI, s. Charles VII the Victor and excellent MARY, b. 1 Jan. 1423: d. 30 Aug., at 7.45 p. m.: Had Lewis, d. kil. y.: Charles VIII: Francis, Duke of Berry, d. kil. y. Louisa, d. kil. y.: Anne, m. Peter de Bourbon: Joan, m. Lewis of Orleans, after Lewis XII, was divorced from her to marry Anne of Britaniy, widow of Charles VIII, who always wore crape after his death: the Lewis, d. k. y. 1448 was s. of 1st wife Margaret of Scotland, who d. 1445: neither father Anselm nor le Gendre, mention him, he is known by a piece extant in the archives of our Lady of Clerly: Nat-chn. had by Phelise Regnard: Guyette: by Margaret de Sassenage: Joan, m. nat of Bourbon: Mary, m. Aymar de Pottiers, Lord of St. Vallier, grandmother to Diana of Poitiers; Isabeau, married Lewis de Saint the priests wrote history of the French kings and were fathers of their Nat-chn, even the good fathers are forbidden against God's Laws to marry.

LAYING UP IN STORE FOR THEMSELVES A GOOD FOUNDATION AGAINST THE TIME TO COME, THAT THEY MAY LAY HOLD ON ETERNAL LIFE.



Plate 995. Gen. 149. ANNE OF BRITANY.



Plate 996. Generation 149

FNR ANNE OF BRITANY, da. Francis II Duke of Britiany and Margaret de Foix, b. 7 Sept. 1477: d. 9 Jan. 1513: m. FNA CHARLES VIII, b. Aug. 30th 1470: d. 7 Apr. 1498: Had. Charles Orland, d. kil. y.: Charles, d. kil. soon after his birth: Francis, d. kil. soon after his birth: Anne,

d. kil. y.: Jean (French) John (English) Fernel whose life was saved by Marrietta Ferno, the Nurse and wife of Petrus Darius Fernel Italians in nativity Anne of Britiany was betrothed to Maximilian and his da. Margaret of Austria was not only betrothed to Charles VIII but educated at the Court of France where she was said to have borne the title of Madam the Dauphinese that was sent back to her father before the m. with Anne 13 Dec. 1491. In the treaty between France and Britiany there was a clause that if Charles VIII died without issue Anne should marry his successor, hence one of the causes that was advanced for m. of Anne that knew of the slaughter of her chn. and not only concealed Jean Fernel but caused him to be sent to England where he was lost, as a mere child and found on a Fern hearth from which was the allegation of the origin of name of Fernwardl, Fernland, Ferneley and Fernald came, although he was adopted by P. D. Fernel and wife Marietta, the nurse of Anne, when Jean was born. The money of Anne rewarded the Constable, I withold his name, and defrayed the expenses of Jean. The Cordelier of black knotted lace around her coat of Arms was a custom that has been preserved ever since, and is on the Tomb or iron Tablet grave "stone" in possession of writer, and Crest coat of Arms the High Roman Crown, depicted thereon. It is believed to be the one that ancestor John Fernald, presented with a Roll of Fernald Genealogical Records to a Boston Historical Society. Roll lost? Disappeared!



❖ ❖ ❖

“**U** E TYME AFTER RETYNE FROM CAPTURE OF LEWISBOURGE, BYE CAPTYNE JOHNE FURNELLE, 1745—6. WYTHE INSTRUCTIONS THAT THE GYFTE BE CONTINUEL KEPT FOR YE GUDE OF Countrie and al ye family. With this is the Washington Iron Tablet of Fernald. Parts of body of Anne were scattered among the churches: that were better in the tomb undesecrated.” “Her heart was encased in a gold egg shaped body, kept by ye church.”

COPY OF LETTER TO POPE
FROM SULTAN BAJAZET:

“The Sultan Bajazet, by the grace of God, the greatest King and Caliph of the two continents of Asia and Europe, to the lord ALEXANDER, father of all Christians, by the gift of Providence, and most worthy Pontiff of the Roman Church, reverence, kindness, and sincerity.” “I have, my Lord, until now, paid with exactness to your holiness forty thousand ducats a year, for the support of my brother Zimzim: but as Innocent the Eighth, your predecessor, as I have been informed, whilst he has been receiving large sums from me to guard that ambitious prince, was also listening to the proposals of the Sultan of Ægypt, and accepting his money to set Zimzim at liberty. I am led to fear, lest one day your successor may furnish troops to my brother, to enable him to dispute my throne.

“Your envoys are well apprized of my apprehensions, and have advised me to address myself directly to you, to procure for my mind the tranquility I so much need, and to put an end to the cause of my alarm.

They have even induced me to hope that you would listen favorably to my propositions.

“I then pledge myself to give you three hundred thousand ducats, several cities, and the shirt of Jesus

Christ, if your holiness will remove Zimzim from the world in any way you may judge best. A signal service will thus be rendered to the prisoner himself, for according to the prophet, he should prefer death to fervitude, and you, most illustrious lord, will not commit a crime, since, by your religion, Christians are ordered to exterminate heretics and infidels.”

The official document containing the Pontiff's acceptance disappeared, as did the communications from Leo XIII to Father Fitzgerald at Boston, U. S. A., and my taken deposition of ante mortem charges of capital crime against the highest in Boston, Leo XIII's official: Fitzgerald and brother found poisoned and the claims of suicide passed the protectors of infinitely worse crimes, now America's deluge. Comines' affirmation is corroborated by the treaty, secret, between the courts of Rome and Constantinople, Bajazet, to supply the Holy See 6000 cavalry, 6000 infantry against French.

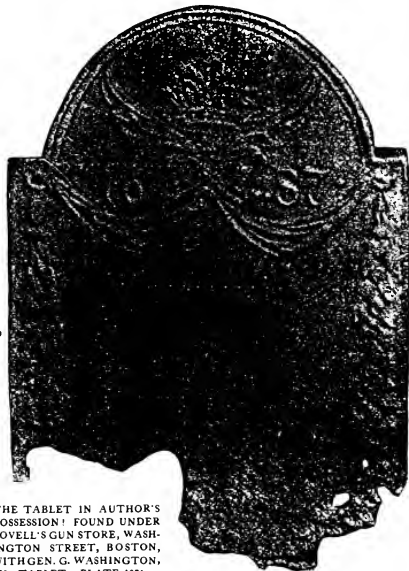

THE TABLET IN AUTHOR'S POSSESSION! FOUND UNDER LOVELL'S GUN STORE, WASHINGTON STREET, BOSTON, WITH GEN. G. WASHINGTON, 1780 TABLET. PLATE 1021.

IN THE EPOCH OF CHARLES VIII, THE HISTORIANS DID THEIR BEST TO PLACATE ROMAN PONTIFFS, WHO WERE SO DEGRADED THAT SIXTUS 4TH DECREED THAT POPE'S NATURAL CHILDREN "BE Princes by right of birth, and established a Lupanar at Rome." Paul, "Religion ought to annihilate science, because science is the enemy of religion." Their misnomer.



CHARLES VIII,

Pl. 1022 Gen. 149

Charles VIII the Courteous, beautiful in person and mind, eyes bright grey and light brown hair, worn long and in curls, possessing the courage of his forefather, Pepin who alone of his officials dared to with the ancient Furni sword face and slay the Lion in the amphitheater: was led by his great love of humanity represented by most noble forefathers, that but few have equalled and none excelled. Attempted to reform the horrible state of immorality existing in France that was typified by the Borgias. Went to the fountain head by assembling an army and on Rome marched. Rome that had duped his father and used him as a tool prevented his education against his desires. No sooner than he became his own master than he wisely pursued his studies with indefatigable zeal. He was gentle till some great occasion aroused him. Ever considerate of others and it was said that never in his life did he say wilfully a single word to give pain to others. Lewis or Louis XI added greatly to his domains during his lifetime. Took by force a large district from Burgundy. Acquired Boulogne by purchase. The Bretons were defeated at St. Aubin, July 28, 1488, Duke of Orleans captured. The Duke of Bretagne did not long survive his defeat, leaving Anne the sole heiress of the duchy at thirteen years of age. Though young, she possessed a strong and vigorous mind, and discretion far beyond her years. Some advised her to marry the old Seigneur d'Albret; glorious spring and fading autumn. Others to marry Charles that she looked upon as the natural enemy of her family. Her choice fell upon Maximilian to whom for state reasons she was betrothed. He shamefully neglected her by not going to see her or sending troops to aid in her difficulty. Charles, seeing her neglected and not in love with Margaret that had been selected for him against his desires, renewed his suit backed by "50,000" strong arguments. The strongest was his love. He entered her capital in disguise and visited the Princess, pleading with such good success that he won his cause and they were married Dec. 10th, 1491.

With only 18,000 men and accepting the patriotic loan of the court ladies' jewels to raise money on for defraying his troops' expense he invaded Italy 1494. He proclaimed himself "the friend of Freedom and the enemy of Tyrants." "God blindfolded their eyes and had tied their hands by raising up this young king to chastise them for their impiety."

"1492 Christopher Columbus probably conversant with the Chart of Fna Chia and Bahman, after whom was named the Bahama Islands, and possibly with the trip here of Marcus Agrippa Lucius Furnius, that is corroborated by the Vatican retention of the coin of Newport, Rhode Island completed Tower. Showing their usual duplicity in claiming it as an emblem of the Hurdle Race. Alexander Sixth having brought Ferdinand the Catholic and King John of Portugal to choose him as mediator of peace. Drew a line which passed from pole to pole through the Azores or Western Islands, and decreed, by virtue of his universal omnipotence, that all the countries which were beyond the line, that is the West Indies, or America, should belong to the King of Spain, and those on this side, that is the East Indies and the shores of Africa, to the king of Portugal. His Holiness imposed no other condition on this magnificent gift than the immediate payment of a large sum of money and to convert, willingly, or by force, the inhabitants. Sixty years after this bull: 15,000,000 had been murdered by Missionaries." Is this the height of their religion, or the lack of it? True History.



UNITED IN RIGHT. CHARLES VIII DISMISSED ALL UNJUST JUDGES AND UNWORTHY PERSONS FROM THEIR OFFICE. DETERMINED TO EFFECT A REFORM IN THE CLERGY WHOSE VICES RENDERED THEM contemptible to the people. He marched on to Italy!—Alexander to avoid embracing Charles the Courteous, as proper ceremony required, feigned to faint, and fell back in the sofa; Charles, took a seat near a window, until they had brought the holy father to the use of salts. The "talk" began:—Alexander agreed to live in peace with his cardinals, to pay them the rights due them; to place in possession of the king the cities of Viterba, Civita, Vecchia, Terracina, and Spoleto; not to



PLATE 1023.



PLATE 1024.

confer any legation without his permission; give cardinal hats to two of Charles VIII's Captains: accept ransom for Zimzim, investiture of Naples; his son Cardinal Borgia, as a hostage. The Pope kept his agreement, that is, so far as he was to be benefited by it. His son as a hostage, ninth day he escaped, took the money of the Sultan of Egypt, poisoned Zimzim with slow poison, who died the eighth day after he was surrendered to Charles the Friend of Freedom. Thus his Holiness got besides the sum paid by France, three hundred thousand ducats from the Sultan of Constantinople. Charles was greatly enraged, and he swore vengeance against the pontifical family. As his interest took him another way he marched on Naples and carried it by assault and the rest of the kingdom was conquered with marvelous facility. Alexander formed a formidable league with the Christian powers against Charles VIII the courteous French King. Ferdinand the Catholic Republic of Venice, Duke of Milan, Henry VII of England, Archduke Philip and his son Maximilian with past history before them supported the Pope. Charles soon discovered the danger that menaced him. He decided to strike a blow to alarm his enemies and chastise the pope for poisoning Zimzim. Leaving part of his troops in his new kingdom with 9000 picked troops he marched on Rome. The cowardly pope fled with his family to Orvieto. The King remained three days in Rome and went on to Tuscany and to Parma where 40,000 of the confederates had assembled to dispute his passage. With 10,000 troops he, at Fornova, cut to pieces and defeated and crushed 40,000 men. The pope sent ambassadors to Charles believing his arts triumphant. To inform Charles that his agreement was erased and annulled.

SOILED AND BLOOD STAINED FROM HIS SLAUGHTERED FOES THAT HE LED HIS INVINCIBLE TEN THOUSAND FRENCHMAN AGAINST—OFTEN ENGAGED HAND TO HAND, CHARLES VIII THE COURTEOUS, on the very day and time, received the Pope's delegates. The legates came "to summon him to go to Rome to render an account of his conduct to the Sovereign Pontiff," the adept in duplicity who ran away. "I will accept the invitation of the holy father and I hope he will await me, that I may have the honor of kissing his (dirty) feet, of which I was deprived, when I last passed through Rome," was courteous Charles' reply.



PLATE 1025.



PLATE 1026

In his laudable attempt to reform the clergy, whose vices and ignorance made them contemptible to the people, his life was cut short by their constantly kept employed assassins of Vatican scattered over the world affiliating with all. Even the French Consul was recalled, it was said, by stating that Charles VIII came to his death by "foul play," which fact I announced in public on State House Sacred Floor. But not that he was poisoned by Vatican, the curse of all nations, as historic truths declare, and herein I acknowledge thirty-six (now thirty-nine) attempts on my own life that belongs to God and my Country, and had I a thousand they are welcome to all. Notwithstanding my family are killed by these foes here and before shown up to a Just God and World.

Charles VIII departed this life for Heaven 7 April, 1498, at 11:11 p. m., and his father, Lewis or Louis, died 30 August, 1483, at 7:45 p. m. His body was taken from the tomb and insulted, 1562. Charles VIII the Courteous fought the greatest battle of modern times at Fornoua, July 6th.

Let none of the worthy ministers or professional gentlemen and worthy Christians of the Roman Catholic Church, and I know very many true noble persons among them, feel aggrieved at the misdeeds of the past which I have fearlessly set forth, and suppressed the worst. But use all your powers to prevent the great evils that are a shame to all.



THAT THE GREAT EMPEROR NAPOLEON SAID: "WHAT IS HISTORY BUT A FABLE AGREED UPON?" IS IT NOT, MY BELOVED RULERS OF 1,411,171,381 PEOPLE, AMPLE CONFESSION OF THE FALSITY OF FRENCH History, that without bigotry, (Sir Thomas More was beheaded by the Protestants; Rev. John Rogers burnt at the stake by the Roman Catholics; by King, Pope and Vatican, both the writer's ancestors.) YOU MAY AS MOST WISE EXPERTS CONSIDER AND JUDGE CORRECTLY FOR THE COMMON GOOD OF YOURSELVES AND OUR ENEMIES THAT NOT ONLY WOULD DESTROY YOU BUT THEMSELVES FROM DISOBEDIENCE TO THE COMMANDS OF OMNIPOTENT GOD BY WHOSE GRACE TRUE HISTORY TIMES IS BY HIS FREELY GIVEN UNCULANIAN LABORS ERRORS, TO GLORER AND HONOR YOU ANCESTORS IN VERCHOICE BLESSINGS EXCELLENT CHAP. I. V. 17:

יְהוָה שֵׁם לְחַא יֵרַע
 אֲפֹסִי אֲפֹסִי אֲפֹסִי אֲפֹסִי

Translation of Hebrew and that into the modern "I, God, Creator of the Adam for Ava the Pure up to be the Temporal lords of dominion and power as First Emperor, Empress, holy, purc, Lady, Govern, I, God of Heaven anoint marry, give authority, my with power of life and with Laws written and en-lets from which they shall point their long line to obeyed, respected down time till I call them to dwell verse. I, Omnipotent God, children to in exactness without change knowingly one iota for all shall be fulfilled as I, God, the Trinity, Decree. The sword, disease shall kill, destroy, punish with full righteous justice every one who disobeys me wilfully, maliciously, or for unhallowed gain by aiding Satan whom I cast from heaven for evil unkingly ambition."



PLATE 1027. Celebrities Honor.

FROM PRIMITIVE COMMANDS HEREIN TO YOU WITH HER TO EXPUNGE ALL IFY GOD OUR FATH- AND YOUR BELOVED ITY. CONFER MOST ON YOUR POSTERITY. RULERS! GENESIS,

יְהוָה שֵׁם לְחַא יֵרַע
 אֲפֹסִי אֲפֹסִי אֲפֹסִי אֲפֹסִי
 אֲפֹסִי אֲפֹסִי אֲפֹסִי אֲפֹסִי
 אֲפֹסִי אֲפֹסִי אֲפֹסִי אֲפֹסִי

into Primitive Egyptian English hath as follows:— earth and waters line of right line of Heaven; they Land and Seas given first Rulers of all Creation the King, Queen, President, nor and brilliant Star wife with holy oil, appoint, unconquerable sword, pike, death; Commands I gave graved on squares and tab- have Dominion, Rule, ap- Rule, be honored, loved, through the ages of earthly with me in celestial uni- Command all them my keep my Laws, Commands

Respect, Love, Honor and Obey thy Rulers of Heaven and Earth appointed by thy Father God, keeping my Commandments and thy reward shall be inconceivable great to you, my children line.



FATHER FRANCE, FR. OF DR. JEAN FERNELIUS, THE LAWFUL SON OF CHARLES VIII THE COURTEOUS AND ANNE OF BRITAINY, HAD FROM THE YEAR 430 TO 751 THE FOLLOWING EMINENT AND LEARNED MEN.

MINISTERS

Robert le Fort
Lando
Badegesilus
Theodoric
Gondoland
Landresilus
Cuppa
Landri
Chrodim
Gogon
Radon

Flotentian
Wiboad
Wrisachair
Berthoald
Protadius
Clausius
Lacin
Gondebald
Waraton
Carloman
Gondold

Sadregesilus
Arnoul
Cogon
Neyan
Pepin
Ega
Ebroin
Almaric
Flacchat
Martin
Grimoald

Charles Martel
Pepin, Sr.
Pepin the Short
Fainad, High Chancellor after
751
Eginhard
Adelhard
Hilduin
Bernard, son of St. William
Gombaud



Plate 1028



Plate 1029

Zeno, #11
Agathas
Alicimus
Avitus
Bele
Boetius
Cassiodorus
S. Anselmus
S. Benedict
S. Columbanus
S. Eoli
Ennodius
S. Epi Fanus

Fortunatus
Frolegarius
S. Fulgentius
Genadius
Gregory of Tours
John Climacus
Jordandes
Malcus
Marius of Ausche
Procopius
S. Remigius
Salvatus
Sidomus Apollinaris
Symmachus

LEARNED MEN

Archambaud
Zozimus
S. Boniface, after 751
S. Chrodegand
S. Pirmin
Alcuinus
Amalarius
S. Angilbert
Ansbert or Antpert
Leidrade
Ludger
S. Lulle
Paulus Diaconus
S. Paulinus

WARRIORS

Betheric
Frederic
Frederic
Gourdon

MAGISTRATES

Luitbert
Ludebert
Luitgard
Mummol

Theodolphus
Tilpin
Turpin
Usuardus
S. Agobard
Amalarius
S. Benedict
Dodana, wife Count Bernard
Dungal
Eginhard
Theodulfus
Robert le Fort or the Valiant
Ado
Florus

Freculus
Gatacalchus
Hilduinus
Jonas
Lupus
Methodius
Nithardus
Pascasius
Rathbertus
Rabanus Maurus
Rastranne
Walefridus
Lewis
Epron

Robert le Fort
Gerard
Bouchard
Beuland

Adalhard
Ralph
Valc
Charles of Argis

S. Boniface
Franco
Wolfrad

Bodillon
Ithier
Radon

Robert le Fort

Syzgrius

WARRIORS—GENERALS

Didier

Wm. Rostrenan
Bernard
Walter
Gerard

Count of Provence

Hillsachar
Fridagise
Theudo

Hugh

Leudegesilus
Landetus

“**U**OME AND SEE THE WORKS OF GOD: HE IS TERRIBLE IN HIS DOINGS UNTO THE CHILDREN OF MEN; THOU HAST BROUGHT A VINE OUT OF ÆGYPT:” “AND DID CAUSE IT TO TAKE DEEP ROOT, AND IT FILLED THE LAND.” Psalms 66, V. 5: 80 Vs. 8 and 9.

MINISTERS

Anscheric
Ebles
Sculf
William
Eudes

William
Jeffers
Raoul
Frederic
Robert

Ger-ase
Gouv
Hugh
Sens-chala
Thibaud I

Anseau de Garlande
William de Garlande
Stephen de Garlande
Raoul
Suger

Stephen
Algerus
Raoul



LOUIS XI,
26 roi, fils de Charles vi et de Marie d'Anjou. 1461-1483.



CHARLES VIII,
26 roi, fils de Louis vi et de Charlotte de Savoie. 1483-1498.



LOUIS XII,
27 roi, fils de Charles d'Orléans et de Marie de Clèves. 1498-1516.



FRANÇOIS I,
28 roi, fils de Charles d'Orléans et de Louise de Savoie. 1515-1547.



HENRI II,
29 roi, fils de François I et de Claude de France. 1547-1559.



FRANÇOIS II,
30 roi, fils de Henri et de Catherine de Medicis. 1559-1560.



CHARLES IX,
31 roi, frère de François II. 1560-1576.



HENRI III,
32 roi, frère de Charles ix. 1576-1589.



HENRI IV,
33 roi, fils d'Antoin et de Jeanne et de Jeanne d'Albret. 1589-1610.



LOUIS XIII,
46 roi, fils de Henri et de Marie de Medicis. 1610-1643.



LOUIS XIV,
46 roi, fils de Louis xiii et d'Anne d'Autriche. 1643-1715.



LOUIS XV,
48 roi, arrière petit-fils de Louis xiii et de Marie Theres. 1715-1774.



LOUIS XVI,
47 roi, fils de Louis Dauphin et de Marie Josephine. 1774-1793.



LOUIS XVII,
48 roi, fils de Louis xvi et de Marie Antoinette. 1793-1795.



NAPOLEON I,
49 emp. 1801-1814.



LOUIS XVIII,
70 roi, frère de Louis xvi. 1814-1824.



CHARLES X,
71 emp. frère de Louis xvi. 1824-1830.



LOUIS PHILIPPE I,
72 emp. 1830-1836.

Plate 1030

Plate 1031

ALL THESE FACES ARE CHARACTER STUDIES FOR EXPERTS

EMINENT MEN

Abbo
Ademar
Aimonius
Arnould
Burchard
Ditmar
Fulbert
Gerbert
Anastasio
Eudes
Odo
Flodoardus
Hincmar

Luitprand
Radulphus
Reginon
Joannes Scotus
Suidas
Avicenna
King Stephen
Ralph Glaber
Guido Aretinus
Helgaud
Humbert
Dr. John, King's Physician
St. Odilo

St. Odilo Adam
B rto
Aleluannus
Brenarius
St Bruno
Drogo
Gilbert
Gustmund
Lambert
Lanfrank
Marinus
Scotus
Odo

Petrus Damianus
Ralph Ardens
Raimbert
Anslem
Stephen
Eudes
William
Guilbert
Hildebert
Ivo Carnuteus
Leo Ostiensis
Marbodus
St. Norbet

Robert
Roscelin
Rupertus
Sigebert
Abelard
St. Bernard
Arnold of Brescia
Petrus Lombardus
Peter
Richard

WARRIORS

Keynard
Eudes
Robert

Hugh
Otho
Abbo

Arnoul
Roger
Franco

Baldwin
Alberic
Mathew II

Fouk Nerra
Hugh I
Jeffery Martel

Hugh of Chaumont

Simon de Neaufe

WARRIORS—CONSTABLES

Mathew of Montmorenci, 1160

MAGISTRATES

Urgad
Fouk
Anscheric
Ermate
Malute

Herveus
Roger
Luitgard
Ebles
Adalgre

Abbo
Ansegise
Eric
Hugh
Artaud

Aldric
Adalbeson
Fouk Nerra
Manasseh
Burchard

Bouchard

MAGISTRATES—CHANCELLORS

Noel, alive 1142
Hugh de Fuitesux

Cadure
Batholomew

Simon, 1152
Alderic

Hugh de Chamfleuri
Stephen of Senlis

Stephen de Garlande
Simon
Algrin

“**F**VERY PURPOSE IS ESTABLISHED BY COUNSEL: AND WITH GOOD
ADVICE MAKE WAR AGAINST THY DESTROYERS: EVEN THERE
THY HAND SHALL LEAD ME, AND THY RIGHT HAND HOLD ME.”

MINISTERS

William Robert Clement	Enguerrand de Marigni	Peter Bemg hanged 1328	Sectrys Gerard
Giles Clement	Raoul de Perreau	Muce de Maches and Rene de Siran, ditto	Gontier
Guerin	Ames of Orleans		Nicholas
Peter of Villebonne	John de Belut	Peter	Peter Blanchet
Mathew of Vendome	Philip de Carigni	William Flotte	Mag. Suson
Peter de la Brosse hanged in 1276	Charles of Valois	Peter	William
	Gerard de la Guette, died under torture 1322	John	John
		Philip	Peter

WARRIORS

Robert de Fiennes called Moreau 1380	J. Simon	Humbert	Renauld de Trie 1324
Bertrand	N. Thiessart	Giles	Gaucher de Chatillon
Arnoul	Henry Boileau	Humbert	John des Barres
John	P. Simon	Henry Clemens	Matthew de Trie
John	Nic. Jocv	Ferri Paste	James
John	John Dauvet	William	Arnold
Lewis	J. Simon	Gautier	Charles
Atty. Genl. William de St. Hermant	N. Calepean	Renauld de Sores d'Estrees	ancel
King's Ad.5 Johns	J. de St. Romain	Heric de Beanjeu, 1270	Charles
Atty. Genls. 1421 to 1472	Michael	Lancelot de St. Maard	Robert Vaurin
Jean Lullier, (da Magdalene, m. Jean Fernel)	"9 sent to their deaths"	Ferri de Ferneuil, 1288	Bernard
P. Cousinot	Peter Laillier, s. J. L. kil.	William	Walter
John Simon	John	Raoul de Clermont de Nesle	Rouel
John Dauvet	Robert	Gaucher de Ctatillon	Guy
J. Rapiout	Raoul	John de Harcourt	Edward
J. Rabateau	Dreux or Drew	Bouille Flamene	Robert de Fiennes
J. Jouvenel, Fouvenel or Favenal	Matthew	John de Varrennes	John
J. Morand	Alberic Clement	Simon de Melun	Mag. Peter
J. Barlin	Nevelon d'Arras	Guy of Clermont	Giles
Jas. Jouvenel	Henry Clement	Foucaude de Merle	John
	John Clement	Miles de Novess	Simon
	Simon of Mountfort 1218	Sacher de Chatillon	Atty. Genl. James Dandrie
	Robert de Coury	John de Corbeil, 1318	K. A. Gerard
	Amuri	John de Beaumont	William
			Renaut

MAGISTRATES

Hugh	Simon who was Pope Mar-	William de Crepi	Peter de Corbeil
Hugh	tin IV	Peter Floete	William de Nogaret
Guerin	Peter Barbet	Stephen Suzi	Giles Aicelin de Montagu
John Allegrin	Henry de Vezelai	Peter de Mornai	Peter de Latilli
John de la Cour d'Angerville	Peter Challon 1283	Peter Belle-Perche	Masters in Parliament
	John de Vassoigne	Peter de Grez	Hugh de Courci
			William Bertrand

KING'S ADVOCATES

John de Vaissoigne	Peter D'Arablai	Peter de Chappes	William de la Magdelaine
John Dubois	Mag. Paul de Brayeres	Mag. John de Cherchemont	Simon de Buci
John Pastoureau in 1301	K. A. Raoul de Presles 1315	Attorney General	Peter de Cugnieres
		Peter de Villebrene	Mag. Peter Rodier

EMINENT LEARNED MEN

Arnollus, 1182	St. Francis	William de Lorris	Raymundus Lollus
Guy D'Aties	William	Hugh Cardinalis	Antony Andrew
Averroes	Rigord 1224	Mathew Paris	Dante, 1321
Peter	Accursius	Peter des Vignes	John, Lord of Joinville
St. Dominic	Albericus	Robert of Sorbonne	Dr. Jean Fernel
Stephen	Alexander Halensis	Vincent of Beauvais	Petrus Aureolus
Endes	Philip d'Antogny, C. S.	Albertus Magnus	Francis de Maronis
Fouk	St. Antony	St. Bonaventure	Herve Noel
William	Stephen Boileau	Raymond of Fennafort	John
Godfrey	Peter de Fontaines	Roger Bacon	Alexander
William of Tyre	Giles	St. Thomas	Alverus Fel Pelagius
Helinand	Gingiskan	Stephen Tempier	Arnold
John	Nicholes de Gros-Parmy, C. S.	John Cholet	Peter
Joachim		William Durand	Durand
Maurice	Raoul de Gros-Parmy	William de Nangis	Gerard
Petrus Comestor	Parmy de Piris	Henry of Gaunt	Odo
Peter of Blois	Wm. de St. Amour	John de Meun	Laura
Villicharlonin	Amour	Jonnes Dun Scotus 1308	Ludolfus
	William	Giles Colonne	Ocham



UNITED WITH GOD FOR REFORM, NO MAN NOR CLASS OF MEN CAN PREVAIL AGAINST US.

Chapter XII.

DR. JOANNES FERNEL WORSHIPED ONLY GOD AND LOVED HIS PROFESSION.

GENERATION CL.

FNR MAG-LIER, da. Jean and wife, 1 July 1496; m. FNA Charles VIII, b. at Clermont, 26 April, 1533; Joannes (written over) Magdalene, b. Fernelius, b. four children scendants: one although the gives a differ-sufficiently Chart of the which was recovered lost records which as to cause a for writing to

"Though they grind slowly, yet they grind
Though with pa-
waiting, With exact-

They lie, says
believe there is no
may profess this
ly in the day time,
company; yet in the
they have doubtful

UNTO the 63,000 descendants in United States of America from Joannis Imperialis, Joannes Fernelius, Jean Fernel (in English, John Fernald,) the son of Charles VIII and his lawful wife, Anne of Britiany; we present a few of the plates of the in the seventeen books he wrote, of which the writer has now thirteen. They contain an assertion in those times of his Imperial descent. His Coat of Arms as Dauphin.



PLATE 1032.

DALENE LUIL-Jean, s. Peter, s. of Anne Washington, b. d. 30 March 1548; JEAN FERNAL, s. and Anne of Britiany, mont, 26 Apr. 1497; 1558; at Fountain-Jean Fernel and wife Fernel, b. 3 Mar. Fines or Funel—s. b. 3 Feb. 1535: 1 May 1544; Maria 5 Sept. 1546: All married and had de- record claimed, Convent of Visitation ent version. This is explained in the Fernald family printed from the concealed private were so important boycott in the U. S. said Convent.

fills of God grind
exceeding small,
tience stands he
ness grinds he all."

Seneca, who say they
God. Though they
somewhat confident-
when they are in
night, and alone,
thoughts about it.



NOT ALL THE BOOKS WRITTEN BY DR. JEAN FERNEL, THE MODERN
 GALEN ARE RECORDED ON THIS PLATE, 1033, WITH HIS COAT OF
 ARMS AS DAUPHIN OF FRANCE: PARTS ARE MONOGRAMMIC.

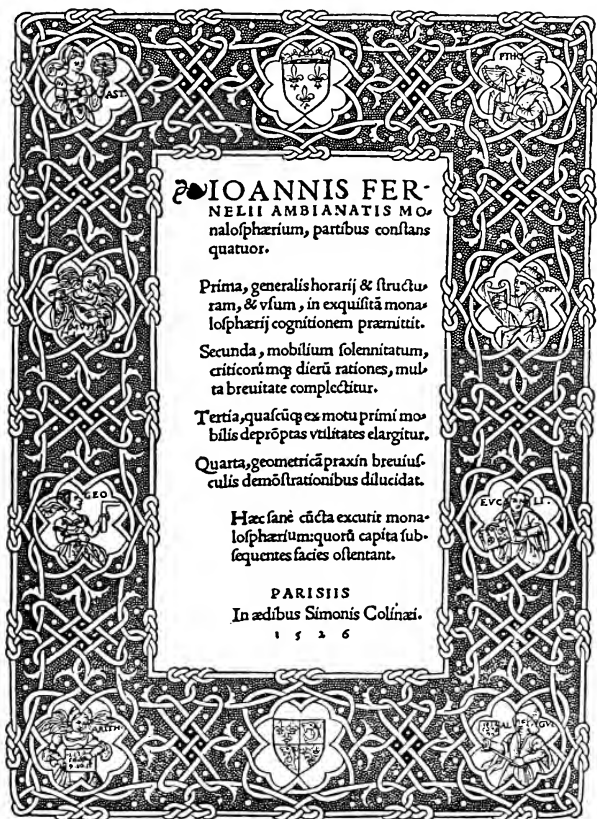

PLATE 1033

TO THE COLLEGE OF HERALDRY PARIS, FRANCE, MOST COURTEOUS THANKS FOR PRESENT OF THIS PLATE OF MY ANCESTOR DR. JEAN FERNEL THE MODERN GALEN, THAT FOUGHT FOR FRANCE. THE PHYSICIAN OF KING HENRY II, OF THE LINES OF USURPERS OF THE KINGDOM.



IOANNES, FERNELIVS, DOCTOR, MEDICVS,

N. De moffa sculp.

J E A N F E R N E L .

PLATE 1034

Dr. Jean Fernel, greater than Galen, who was born 1497 at Clermont, and his life saved by Marietta Færno, wife of Petrus Darius Fernel (called), the nurse of Anne of Britany, who substituted a dead child for Jean, thus an Italian or Roman saved the honored progenitor, 63,000 Americans.



O

F THE UNITED STATES AND THE WASHINGTON FAMILIES REPAY GRATEFUL THANKS TO GOD'S APPOINTED CHOICE OF A RIGHTEOUS WOMAN TO THWART EVIL VATICAN AND ALEXANDER SIXTUS the infamous Roderic Borgia, the holy father guilty of liaison with a beautiful Spanish lady, who was a widow with two daughters, who died, and then her daughters; the eldest put

in convent and by the youngest Rosa Vanozza, he had 5 children; Francis, Casar, Lucretia, Godfrey, and one d. young. The pope at the right hand of the Altar of St. Marie del Popolo caused to be placed a magnificent ozza for veneration of the Virgin. The but not the facts of sition of capital crime Popes and Vatican to malpractice with honor God and ben-commands; to be fol- a few protestant them boasting of a tainted money, form- makers to do excel- thing Roman Cath- testant. True facts

IT is with regret pelled in the cause tial justice to record protect the innocent ian and worker that ity, this plate, 1035, Dr. Fernel's numer- not contain the work erous foes that my and Mss. did more written several years called to the Coat of been of another, viz: posed to a caricature during whose epoch abominations so

of Europe instructed their Embassadors to summon the pontiff to put an end to his evil deeds or be deposed from the Holy Sec.

The Embassadors of the EMPEROR of GERMANY, the KINGS of FRANCE, ENGLAND, CASTILE, and PORTUGAL on a day of solemn audience notified the Pope; Alexander took it in bad part; and said for his unholy work as follows:—"Go, ye footmen, return to those who sent you, and say to them that I have yet much to do before I can equal them in wickedness." Brother Jerome Savonarola was kil. for saying:—"What should people think of their tyrants if an Alexander the Sixth judges KINGS to be more infamous than himself". Jean Fernel and wife were poisoned to death by Pope, Vatican, within about one month of each other. They said, "he died of grief."



FERNEL *Schema ecclesie magis Tulliano qui stilo
Abdito illustravit arte Anacropica Orgia
CAR. SPONZIO, AD. LINDUM*

PLATE 1035.

del Popolo caused to be portrait of Rosa Van- of the faithful instead worst is suppressed, theft of Mss. despo- and refusal of last two sign vs. alcoholic & dreadful diseases, to eft all people as God loved in that evil by churches, one of desire to receive er causing plate lent work on every- olic and slight Pro- and data.

that author is com- of right and impar- many of the items to forthcoming histor- God chooses for pur- taken from one of ous books, may or for evil of his num- stolen Court records fully set forth, as ago. Attention is Arms, that may have Count John F. trans- of Dr. Jean Fernel were the crimes and great that the prin-



AT PARIS DR. JEAN FERNEL APPLIED HIMSELF TO STUDY WITH THE MOST INDEFATIGABLE ZEAL, AND MADE SUCH PROGRESS THAT HIS LECTURES ON PHILOSOPHICAL SUBJECTS WERE greatly admired for eloquence and erudition. He was invited to become a professor in the college where he was a student—entered and accepted. He studied medicine, and

when graduated and admitted between his books and his five hours to rest in twenty-four. King, Henry II, "whose friend-secured by curing one of his (well knowing the fate of his to accept honors and places of and preferred the retirement every other pursuit. But on the sician, he was obliged at last to immense practice, making death he was possessed of his murderers, the Roman it, his destroyers used to fortify as being pulled down, as he was France, the lines of Kings of the criminals, in part through and partly because it was not the Throne, a curse.

The mysterious signature of seen below his plate, 1036, con- tive language of his ancestors, Queen of Palmyra, the grand- Fnr Chia, and her writing the to Ava and Adam, the children Kircher was familiar with, and William Warburton that plate was conversant with languages Syriac, Hebrew, Greek, Ægyp- He in signature speaks of his Waldsee-Muller, Emanuel of much more of historical value

The history of my French rigid examination by histori- further mutilated by the Roman caricatures were made of the as in Boston an imitation of Catholic Church, that ever have and families, but never to honor others without self aggrandize- politics that ever has caused

Plates 1036 and 1037—Very borders the emblems that are history of his family, that this others to contemplate, and



Jernel 1637

PLATE 1036



PLATE 1037

to practice, he divided his time patients, allowing himself scarce When invited to Court by the ship and good opinion he had favorites, he excused himself ancestors,) and when solicited emolument he modestly refused, and studies of private life to death of the King's first phy- settle at Court where he did an 12,000 livres a year, till at his \$20,000,000 that went to enrich Catholic Church, and a part of the walls of Rome now reported the true heir to the crown of France did nothing to punish cowardly fear of the Church, desirable to lose their claim to

Dr. Jean Fernel, which is to be tains information in the primi- also the relationship of Zenobia, daughter of Fna Bahman and line of their common ancestors of God, which line the Jesuit, in the Works of Cousin Rev. keeps the exact number. He of which a few were Arabic, tian, Latin, Sanskrit, et als. cousin, Americus Vesputius, and Portugal, (See Plate 1037,) and continued in Second Edition.

ancestors not only went under a ographers of the King, but was Catholic Church, or Vatican: features of Dr. Jean Fernel: and same by our American Roman and will meddle with politics themselves, or, Christlike, aid ment. They ever meddle with bloodshed.

valuable. Plate 1037 has on its indicative of the very remote work shows much light upon for complete for the good of all.



ET US RECORD THE LIFE OF DR. JEAN FERNEL IN THE WORDS AND LANGUAGE OF HIS STUDENT G. PLANTIO: WHOSE CYPHER SCROLL WORK GIVES HIM AS BEGOT BY CHARLES VIII AND ANNE.

“IOHANNIS FERNELII VITA.

Scriptore G. PLANTIO Cenomano D. Medico.”

“IOHANNES FERNELIUS, CLAROMONTIO oppidulo (quod viginti duxtaxat milliaribus a Lutetia distat natus atque ingenue educatus, Ambianum in operibus idcirco se prædicat, quod patrem inde oriundum habuerit.

Hic natu jam grandis quum sub triviali magistro Grammaticam didicisset, etiansi mater rebus eum curisque domesticis potius, quam literis tam sero destinandum contenderet, maximo literarum amore incensus, a patre cœpit postulare, ut Eloquentiæ ac Philosophiæ offeram daturus Lutetiam commigraret, acti temporis jacturam ac detrimentum incredibili studio summoque se sarciturum pollicens. Quod non Ægre impetravit. Noverat enim multarum rerum usu peritus senex, ut in segetibus fertilitas ac graviditas futuræ frugis ubertatem significant, sic literarum studia tantopore expitita, and divini ingenii seminaria iam ab adolen scentia, totius vitæ ac senectutis in viris ornamenta præagire. Erant tunc temporis Lutetiæ in gymnasio Barbarano, præter artium liberalium doctores, innumeri etiam juvenes non mediocriter (ut temporibus illis) eruditi, quorum diligentia and doctrina, veluti calcaribus ad artes, quæ tum erant in pretio, alacris amplectendas incitatum, tantos in arte differindi biennio progressus fecit, ut quam de se concitaverat expectationem, longe lateque superarit. Magisterii laurea publico eruditionis testimonio haud multo post donatus, a gymnasiarchis certarim ad professionem Dialectices splendis muneribus invitatus est, quibus non ante parere voluit, quam privatis lectionibus and studiis se in Ciceronis, Aristotelis, and Platonis doctrina diligentius exercuisset. Quod cum esset aggressus, quantum olim in constituendis suis studiis aberasset, primum animadvertit. Nihil enim ante præter ineptas questiones e barbaris præceptoribus hauserat: sed illud eo æquiore animo tulit, quod sibi cum pluribus gommene esse, nec ullo suo, sed ætatis vitio imputandum intellexerat. Quippe tune temporis artium omnium barbaries Academiam Parisiensem, scholarum omnium, quas ab orbe condito floruisse legimus, præstantissimam, ita etiamnum obsidebat; ut Grammatici and Rhetores nihil nisi barbaros Alexandros, Theopagitas, Græcismos, Theodoletos, atque ejusdem farinee reliquos authores in manibus haberent: Dialectici vero non nisi Clichtovæi terminos, Petri Hispani summulas, Bricotii Logica, Aliaque id genus opera interpretarentur.

Quum igitur in ipso vestibuloadiuque impigisset, judicavit temporis jacturam assiduo labore diligenter compensandam Itaque ludos, jocos, compatationes, and comessationes, sermones etiam omnium pene condiscipulorum, ac familiarium, fugere statuit, non cibi, non somni, non corporis, non valetudinis, non rei familiaris rationem habere, omnia perpeti, dum liberalium artium cognitionem assequeretur: omne in eis studium, diligentiam, curam, industriam adhibere, nullam præterquam ex discendo voluptatem capere: arbitratus omnem horam perire, quæ in bonorum authorum lectione and studiis non collocaretur: tanta in illius animo insitærat discendi cupiditas, tantus cognitionis amor and scientiæ.

Hanc porro habuit instituti rationem, ut primo quoque tempore barbariem, quam ætatis vitio, sub indoctis præceptoribus hauserat, Latinorum authorum, maximeque Ciceronis lectione repurgaret: ejus Academicas, cæterasq; potissimum de Philosophia disputationes, and de natura Deorum, ac de



❖ ❖ ❖ ❖

LDEORUM, ac de "officiis in id selegit, in quarum lectione aliquot menses ad dicendi facultatem collocavit. Celsum quoque cum ob orationis puritatem, tum ob sententiarum pondus habuit quam charissimum: atque etiam Platonem, cujus opera M. Ficinus Latine reddiderat.

Sed cum Mathematices indoctus, in exemplis, quae ab authoribus saepe proponuntur, titubaret, inhonestum esse duxit ea parte sapientiae vacare, quae certior quam sit, plus admirationis habet. Itaque distinctis and divisis studiorum temporibus, coepit ita suum ingenium excolere, ut mane Arithmetics, and Mathematicis disciplinis, a prandio vero ei Philosophiae parti quae in natura versatur operam daret; a caena Latinos auctores, Latiniq; sermonis observationes diligenter excuteret.

In hac literarum studia dum insatiabili, and indefesso labore incumbit, febre quartana tandem corripitur, qua crudeliter ac diu conflictatus, coeptum studiorum cursum interrumpere utque salubriore arte frueretur, solum vertere cogitur.

Profligata tandem quartana, recreatisque ruri viribus, Lutetiam redire cogitat, de deligendo vitae genere cum amicis deliberaturus. Horum alii Theologiam, alii Mathematicas disciplinas, alii aliam artem proponebant, in quam reliquum vite suae cursum conferret.

Jurisprudentiam plures contendebant, and ad opes maximas, an summos honores, dignitatique gradus; ceteris prestare: in qua etiam facile esse dicebant cum excellere, qui singularem artium liberalium cognitionem sibi comparasset. At vero ille, non minus prudenter quam acute officiorum omnium momentum ad naturam suam revocari accommodarique debere, nihilq; temere, nec invita, quod aiunt, Minera, sibi aggrediendum esse, contendebat. Quum igitur solitarium se, ac taciturnum, neque ad dicendum fatis expeditum agnosceret, facile judicavit, ne jure clamoribus forensibus, neque sacris concionibus satis se idoneum fore: idcirco Medicinam praeceteris artibus ac disciplinis elegit, vel hoc nomine, quod non ita pridem in febre quartana ejus opem sensisset.

Sed ecce dum haec cogitat, a patre literas accipit, quibus graviter conquerebatur, in unius filii studia nimium multa jam esse impensa, alios sibi sugeresse quae equa cura fovere debeat. Itaque aut domum se recipiat, aut que ad honeste and liberaliter vivendum necessaria sunt, aliunde petat. Quibus minime exterritus, retinuit etiam pristini consilii institutum, vel quod sibi nihil posse deesse speraret, vel quod obsequio parentem tandem flecti posse persuasum haberet.

Primum igitur, quoniam nulla re eque ut exercitatione ingenium acuitur, confirmaturque memoria, Philosophiam non intra privatos parietes, sed in gymnasio Barbarano publice profiteri decrevit, and Philosophicum curriculum emetiri, quod rudi adhuc saeculo summa cum laude, omniumque applausu, absolvit. Interim vero Mathematicis studiis plurimum capiebatur, in quibus quantum jam profecisset, ostendunt ipsius de iisdem disciplinis scripta olim emissa, in quibus si minus tersus, aut politus, quam in Medicis operibus, sermo videatur, tempora accusanda. Tum quippe, ut supra commonefeci, personabant adhuc scholae omnes vicibus imperitorum hominum and Barbarorum, nec dum politoris doctrinae splendor Gallis Philosophis illuxerat.

Quum satis superque in hisce artibus, quae ad Medicinam viam sternerent, operae laborisque posuisset, omnes meditationes suas, omnesque ingenii nervos integrum quadriennium ad ipsam in intendit, ita proficiens, ut illis sacris initiatus, non disputationibus solum, sed etiam publicis praelectionibus, egregium suae eruditionis specimen ediderit. Exantlatis per biennium primis illis scholarum laboribus, quum permulti primas doctoratus sedes certatim ambirent, totus celebrium hujus Academiae Medicorum cœtus, secundus illi ultro detulit, primas profecto daturus, si quantas ad disputandum, tantas ad





PECTO DATURUS, SI QUANTAS AD DISPUTANDUM, TANTAS AD INSUMENDUM FACULTATES HABUISSET. DOCTOR JAM FACTUS, LUTETIAM SEDEM SIBI DELEGIT, PROPTER EXIMIAM HOMINUM, quibus familiariter utebatur, eruditionem, and urbis frequentiam, quorum & scientia augeri, & exemplis infinitis illustrari poterat.

Neque enim, quod plerique fere omnes facimus, postquam Laurea medica decoratus est, vana & inani eruditionis persuasione ac opinione insolescens, otium jam & a seriis studiis feriandum sibi putavit, sed magis ac magis evolvendis veterum scriptis scrutandisque eorum sententiis, invigilandum. Hoc enim (quod res est) certo sciebat, e scholasticis disputationibus eodem duntaxat & inchoatam haberi rerum cognitionem, quæ manca & inutilis omnino futura sit, nisi continuato labore assiduaque vigilantia compleatur. Itaque Philosophicas ac medicas questiones missas fecit, utque intermissam insignium auctorum lectionem continuaret, domi se aliquot annos continuit.

FLOREBAT tum temporis Lutetiæ artis optime eruditissimus, Jacobus Strebæus qui se Joanni Fernelio, quem Mathematicas artes apprime callere noverat, conjungendum curavit. Itaque dum Strebæus a Fernelio, Mathematicarum disciplinarum, Fernelius, vicissim a Strebæo politioris literaturæ cognitionem & gravem plenumque orationis stylum accipit, integrum biennium exigitur.

Interea quamplurima Mathematices instrumenta magno rei familiaris dispendio excogi Tavit, ac fabricanda curavit, ne uxoris quidem (quam non ita pridem duxerat) doti parcens. Tantum in sui admirationem & amorem mentes hominum rapit atque allicit syderum coelestrumque rerum contemplatio, ut animum semel illecebris suis captum perpetua grataq; servitute sibi postea addicuum ac divinctu retineat. Uxor is pater, virperinde prudens ac eruditus, generum sæpe invisibatur, nonnumquam & convivam advocabat; quumque inter epulas non raro in Medicas disputationes incideret, oblata occasione apud generum querebatur, quod Medicinæ, cui totum jam pridem se dederat, nimrum oblitus Mathematicis disciplinis adeo inhæresceret, ut inde hactenus illum nec uxoris amor, nec liberorum blandimenta, nec rei familiaris, cura revocare totuerit. Mathematicarum artium cognitionem homine quide liberali dignam esse, & per se animi causa expetendam, si quis modum adhibeat, & per atatem attingat; sed in eatanquam in Sirenium scopulis virum probum & Republicæ & ac familiæ & studiosum obdormiscere, atque consenescere, indecorum. Non enim illam esse ad Republicæ conservationem necessariam, ut quæ quam minimum usum, nullam autem aut certe exiguam actionem ad retinendam civium societatem, si tamen Arithmetican & Geometriam exceperis, proferat. Medicinam, sive ad ea oculos mentesque convertimus, quorum naturas praeclara ac nobili contemplatione pervestigat. sive ejus usum commoda, & utilitates dispiciamus omnium artium merito præstantissimam judicari, ad ejus cognitionem parum Mathematicæ disciplinæ conferunt.

Hæc aliaque multa ad persuadendum efficacissima rerum plurimarum usu edoctus Senator Parisiensis genero proponebat, quibus cum minime flecti videretur, ille filiæ lacrymis permotus atque incensus, querelis cum genero paulo gravioribus egit, quas nihil refert hic adscribere. Qua admonitione & objurgatione tandem fractus, artem Medicam majori quam unquam studio persequi cœpit, Mathematicis artibus intermissis itaq; & sculptores, quos non sine magnis sumptibus jamdiu domi allebat remittere, & nobiles alioque discipulos, quos in hac habebat disciplina, alium præceptorem querere jubet, & e conspectu tum Mathematica omnium veterum opera, tum astrolabos, & innumera alia quæ ille jam sibi cuderat instrumenta ænea, abjecit, ut totum se Medicinæ devoveret. Quoniam autem. a.



❖ ❖ ❖ ❖

QUONIAM AUTEM A PRIVATA MEDICORUM AUTHORUM LECTIONE & MEDITATIONE MULTUM SIBI SUPERESSE TEMPORIS VIDERET, ID NE SIBI PERIRET, INTERIM DUM AD ARTIS OPERA SE COMPARARET, AD explicanda Hippocratis & Galeni scripta, quæ in publicis Medicorum scholis nondum doctor designatus olim enarrare cœperat, animum contulit, quod tanto discipulorum concursu, tantaq; frequentia præstitit, ut paucis annis fama eruditionis ejus extra Galliæ fines transiliens, in Germaniam Italiam Hispaniam, cæterasque exteras Europæ regiones pervolarit, & hac tanta famæ celebritate etiam absentibus innotuerit.

In hoc exercitii atque docendi labore dum annos sex totos summa cum laude versatur, sensim ita Lutetiæ increbuit nominis ipsius celebritas, ut curandis ægris opem ab eo poscentibus vix satis esse posset. Ad eum namque non cives modo Lutetiani, verum exteri quoque fere omnes confugebant, qui graviore aliquo morbo tenebantur. Quod illum susceptam docendi provinciam intermittere cœgit.

Sed ne sic quidem Theoreticæ Medicinæ partem neglexit, verum quidquid otii a gravioribus rebus, curis & negotiis dabatur, id omne in ea Medicinæ parte, quam Physiologiam inscripsit, commentariis & lucubrationibus suis illustranda consumpsit: in quo tam egregio Opere, qualem se præstiterit, posteritas livoris expers apertius fortasse prædicabit. Primus certe, quod sciam, rudi adhuc sæculo, ineptas illas questionariorum nugas, nihil præter spurcam fœdamq; barbariem personantes & inextricabiles argutulorum sophistarum Labyrinthos, qui rebus per se claris densas tenebras offunderent, e Medicis scholis expulit naturalem Medicinæ partem Latino sermone luculenter adeo, ac nihilominus breviter explicans, ut si quis præceptis institutisque Philosophiæ instructus, opus de ea Medicinæ parte ab ipso conscriptum non offcitanter semel atque iterum perlegerit, tenacique memoria longa Meditatione impresserit, eum nihil eorum latere possit, quæ de ea veteres omnes cum Græci, tum Latini & Arabes, infinitis voluminibus, vix semel in vita homini legendis, observatione dignum prodiderunt.

Hoc Opus typis jam excusum, ut interpretaretur, a philiatris omnibus & precibus & muneribus sollicitatus est, quod onus, (quæ erat ejus humanitas, ut prodesse vellet quamplurimis, imprimisque docendo) uxore, amicis omnibus, & ægrorum curis reclamantibus, vel magno rei domesticæ dispendio suscepit. In hoc vero Opere explicando annos tres strenue adeo laboravit, ut Reip. Litterariæ civem se utilissimum præstiterit, & ex schola ejus plures docti Medici, quam ex equo Trojano milites, prodierint, per omnes Europæ regiones atque tractus diffusi.

Interea dum hoc docendi munere summa diligentia & fide perfungitur, Opus Aliud de venæ secandæ ratione, Medico perquam necessarium, nocturnis vigiliis elucubrat, non minus quam illud tersum & elaboratum, quod in lucem emissum mox interpretandum suscepit.

Nec absolverat ejus commendationis explicationem, cum in gravissimo mulieris nobilissimæ casu ad aulicos quasi edicto regio rapitur. Per vagabatur enim incredibilis ad hujus imperii proceres de Fernellii eruditione fama & persuasio, quasi unus esset e Galliæ Medicis calamitosi illius morbi perstrenuus oppugnator, & impendens mortis fortissimus vindex, malorumque depulsor, quasi Hercules Alexiacus: quam ille opinionem de se strenue sustinuit, ut non tam sit creditus mulierem in vita retinuisse, quam jam profligata salute ex inferorum faucibus revocasse. Prima hæc cansa fuit cur in posterum





F PRIMA HÆC CAUSA FUIT CUR IN POSTERUM HENRICO, GALLIARUM REGI DESIGNATO, CUI ILLA CHARISSIMA ERAT, MAGNO SEMPER IN PRETIO FERNELIVS HABITUS SIT, QUEM JAM INDE PRIMARIUM MEDICUM sibi delegit annuo honorario proposito, si in aulico satellitio commoratus, suæ valetudinis curam reciperet.

Sed quia eruditionis quam gloria semper fuit avidior, tanti principis munera & propositos maximos honores contemnens, nec pollicitis deliniri, nec hortatu incitari, nec aliorum Principum & amicorum frequentium precibus in aula Regia diutius potuit retineri Itaque & infirmam valetudinem simulavit, & in artis Medicæ operibus nondum se satis exercitatum & versatum ingenue confessus est, cui Principes valetudinis suæ curam committerent. Idcirco futuri Regis majestatem & summam humanitatem obtestatus est, ut Lutetiam Parisiorum redire liceret, in qua urbe & cœpta studia absolvere, & in artis operibus diu ac multum sese exercere posset se enim postea & Regi, & Principibus omnibus, suam industriam probaturum.

Noverat enim, & sæpe prædicabat, frequentem medendi usum Magistrorum præcepta superare: neque medicos, neque imperatores, & oratores, neque jure consultos, neque ullos alios artifices, quamvis artis præcepta perceperint, quicquam magna laude dignum, sine usu & exercitatione consequi posse: quod nusquam commodius quam Parisiis, tum propter doctissimorum hominum frequentiam, tum morborum qui isthic grassantur varietatem se posse adipisci putavit.

Itaque eos ille Medici nomine indignos semper arbitratus est, qui Medicinæ præceptis institutisque cognitis, antequam in ejus operibus diu multumque in frequenti & populosa urbe sese exercuissent; & multa ad perfectam morborum curationem scitu dignissima (quæ ut seniores veluti per manus a majoribus suis acceperunt, sic, posterioribus tradere necesse est) observassent, in oppidula faciendæ medicinæ causa se reciperent. Etenim si vel in morbi causa pervestiganda (quod sæpe fieri verisimile est) vel in decernendis remediis aliquando aberrant, a quo revocentur & castigentur? Neque enim dissimulandum, sed ingenue confitendum, in iis qui artem, quam profitentur, jam diu feliciter & magna cum laude exercent, inesse nescio quid, quo ceteris & excellere & admirationi esse videantur, quodq; ut ab omnibus summopere expetitur, sic nec facile literis mandari, nec verbis luculenter explicari possit, sola observatione & longo usu cognoscendum.

Quocirca tutissimam ac brevissimam discendæ Medicæ artis viam eum sequi arbitrabatur, qui postquam præceptis institutisque Philosophiæ abunde instructus, fuerat, statim e terso & polito quodam, eoque compendiario autore Medico, primum quidquid ad humani corporis naturam exquisitè cognoscendam necessarium esset hauriebat; mox simplicium & compositorum medicamentorum temperamentum, sapes, vires, & facultates omnes examinabat, tum demum morborum, symptomatum, & signorum omnium differentias & causas addiscebat, ac tenaci memoria complectebatur: postremo in artis operibus cum seniore aliquo, eoque docto, & longo jam medendi usu perito Medico, diu multumque sese exercebat & quod e libris & viva præceptoris voce didicisset, in ipsis agrotis observabat. Multa in theoreticæ Medicinæ parte occurrere, quæ nisi ab eo qui longo artis usu & exercitatione valeat, nec recte explicari, nec intelligi possint; neminemque e solis libris omnibus numeris absolutum evadere putabat. Medendi usum & exercitationem, tanquam optimos Medicinæ interpretes, quidquid in tota arte obscurum, vel dubium tyronum ingenia retardat ac remoratur, luculenter aperire & stabilire: ut idcirco in theoria minime (quod tamen plerique faciunt) consensendum sit. sed ad artis opera tanquam ad optimos docendi magistros, si quis judicio valeat, sed medico seniore & exercitatu duce, properandum.



U

CONTRA OPINIONEM, & HÆRESIM, QUAM PLERIQ; OMNES MEDICINÆ PROFESSORES HACTENUS DEFENDERUNT, CONTRA QUÆ RECENTIORUM ERROREM, QUI IN SCHOLIS NIHIL FERÈ PRÆTER simplicem verborum interpretationem & inanes λεππολογίας suis auditoribus inculcant & obrudunt.

Damnabat etiam eos, qui politioris orationis stylum & linguæ cognitionem curiosius consecretantes non tam modum, quam copiam in dicendo quarerunt, & verbis ornatiorum quam sententiis illustriorem orationem contextunt, ipsarumque rerum speculationem & contemplantationem (quarum gratia linguarum cognitio expetiur) in totum fere negligunt. Vt enim in nummis non spectatur elegantia sculpturæ, sed pondus, & materia; ita parum refere quam sit elegans oratio, dum pura & perspicua sit, sententiisque abundans. Inde enim fieri, ut facundi & disertis quidem plurimi, Philosophi vero & rerum Medicarum scientia, præstantes pauci ad medicinam faciendam accederent, quod multo plus opera in bene & ornate dicendo, quam in recte, tuto & jocunde medendo collocarent.

Sæpe etiam audivi, quum affirmaret eos falli, & iudicio præpostero, qui in evolvendis anatomicis libris, & in cognoscendis simplicibus medicamentis, ad extremum usque senium desudarent, nullum interim nec agrum inspicientes, nec quæ a veteribus prodita sunt in agris observantes. Ille satius esse ducebat, eorum aliquo, qui de re anatomica docte pariter, & polite ac nihilominus breviter perscripserunt semel atque iterum perfecto, & accurate examinato, ad res ipsas in agris multis cognoscendas & explorandas descendere, quam in conciliandis tot dissentientibus inter se scriptoribus (Jam enim plures fere anatomici libri, quam ægroti reperiuntur, & plures herbarii scriptores, quam herbe numerando recenseri queunt vix homini in viti semel legendis, tempus & ætate perdere.

Linguarum autem peritia quoniam ad rerum cognitionem aditum patefacit, futuro medico utilissima censenda, si modo ea recte utatur, at si ob eam ita ille insoleat, ut nec a pharmacopola componendorum miscendorumque medicamentorum modum, nec a seniore medico faciendæ medicine rationem discere sustineat, sed e libris vecta sead artis apera conferat perfectam medicinæ cognitionem arroganter sibi vendicans, quanto in errore versatur, quanto ægrotantium atque adeo Reip. totius damno infanit? .

Ille etiam, quem admodum eam astronomiæ partem, quæ coelestium orbium motus, conversiones & siderum ortus, cursus, atque occasus, tradit, medico perutilem semper existimavit, & libras editis illustravit; ita genethliacam divinatricemque; astrologiam, quæ superstitiosa quadam observatione ex astris nescio quæ portentosa & mendaciorum plastra comminiscitur, quæque coelestes domos, & nulla ratione excogatas sedes constituens, uniuscujusque secundam & adversam fortunam ex horoscopo auguratur, ad darios siderum motus cogressiones, aspectus & conjunctiones, certos characteres & imagines consingit & de futuram rerum præsentatione sese venditat, omnino damnabat, eique se olim operam dedisse conquerebatur, quod eam fallacem incertam, & a vera religione alienam comperisset. Quinetiam dierum criticorum rationem minime ex vanis astrologorum commentis, qui certissimam veterum Medicorum observationem pervertunt, & dierum decretoriorum ordinem perturbant, ineundem esse contendebat, etiamsi olim variis divinatricis astrologiæ pollicitis deceptus & nondum in artis medicæ operibus satis versatus aliter censuisset sed spectandum morbi impetum, progressionem, committentis morbum humoris naturam, & morem, denique abditam, & occultam motuum naturæ, & eorum dierum, in quos hi motus incidunt, sympathiam & consensionem naturæque robur. Horum enim adimadversione quibus diebus, ex certamine naturæ & morbi, repentinæ ad salutem vel ad mortem ad melius vel deterius mutationes excitentur non autem ex siderum lunæque influxu, & aspectibus, qui neque in dies criticos incurrunt, neque humorum hyparxin constituunt, neque criseon inclinationes efficiunt, prævideri prædicique potest.





IEGO IGITUR TANTI VIRI DOCTRINAM IMITATUS, VANOS ISTOS DIVINATRICIS ASTROLOGIÆ PROFESSORES, GRAVISSIMUM VETRIBUS MEDICIS & CÆLO BELLUM INDIXISSE, DUM SUA APOTELESMATA vana & incerta pertinacius defendunt, conicio; ut qui vetrum Medicorum observationibus posthabitis, quidquid in inferioribus corporibus materiæ vitio accidit præter naturæ ordine, id totum syderum aspectibus & congressionibus acceptum referat, neque medicis suam constan auctoritatem and dignitatem opinentur, nisi clades, incendia, pestes, bella, alluviones, morborum contagiones, ærumnas denique & calamitates, quæcunque mortalium genus dixerant, ex syderum motibus, aspectibus, & conjunctionibus prænuntient, & quis eorum decursus, quis exitus futurus sit, prædixerint; quo quid absurdius, & vero magis contrarium, dici excogitarique possit, non video. Ingenuè quidem fateor, arcana præpotentis Dei voluntate, atque consilio, pestilentes morbos, sævaque contagionis semina, ad vindicanda sceleratorum flagitia, & revocandos ad bonam frugem ex morum corruptela & vitiorum inquinamenti homines, excitari, & huc non raro immitti: nec eo inficias, vi & maleficio syderum sic sæpe ærem infici, ut non solum nobis, sed etiam brutis animantibus morbidus aut exitialis sit. At id quidquid est, haud divinatrice illius astrologiæ, quam tantopere isti prædicant, ope, sed solo eventu hactenus cognosci deprehendique potuisse contendo. Sed ad rem redeo.

Cum a designato Rege dimissionem impetrare non posset Fernelius, simulata pleuritie, & conficta ementitaque, a Chirurgo, qui principi familiaris erat, periculi magnitudine per eum nuntiarî jubet, tanti mali causam ab animi ægritudine & mœrore proficisci; quod studiis esset abductus, ab uxore charisque liberis distractus, a lectione revocatus, & e Philosophica vita in inquietam & militarem tranquilla in actuosam, e sedentaria & litteraria in turbulentissimam pertractus: nec, nisi conjugii, nisi litteris, nisi suis ægrotis, nisi collegis redderetur, posse servari. Quibus impulsus Princeps, no modo eudomum remisit, sed etiam, ad studia quo magis inflammaret, nihil de anno honorario, quod sexcentas libras Gallicas efficiebat, demit. Verum assidendi onus molestum & grave, liberalissime remittit, asseverans eum apud se ἀρχίαττον fore, qui in bene medendo & sapientiar præcavendo cæteris præcelleret. Grata hæc tanti Principis verba non solum ementiti morbi curationem statim attulerunt, sed magis ac magis ad difficilia quæq; subeunda animum impulerunt.

Itaque post biduum domum reversus, interruptam libri de venæ secanda: ratione interpretationem ad calcem usque operis perduxit. Hoc perfunctus munere, alia quædam Hippocratis & Galeni interpretari scripta cogitabat, idque ab eo quotidianis precibus & acclamationibus contendebant philiatritomnes: sed præ ægrorum qui undique ad eum opis causa quotidie confugiebant, tuba, id muneris aggredi non potuit.

Et vero hæc quid illi efflueret temporis, quod in communem omnium utilitatem non cederet, nocturnis lucubrationibus insigne opus de abditis rerum causis conscripsit, in quo de rerum omnium primordiis deque multis valde obscuris Philosophiæ & theorematibus, tam docte tamque apposite in utramque partem disserit, ut recentiores in hoc scribendi genere longe multumque superasse videatur.

Hujus scribendi operis hæc fuit occasio. Quum in veterum Philosophorum ac Medicorum scriptis multa ille deprehendisset non parum obscura & dubia axiomata quæ incertis conjecturis in suam quisque opinionem facile traheret, atq; detorqueret, sine quorum tamen certa intelligentia Medicus in magnarum rerum ignoracione versaretur, & in ipsis artis operibus non raro hallucinaretur, ad certam eorum quæ in Physiologicis & alliis libris suis haberentur, demonstrationem, putavit proprio opere exactam controversorum illorum problematum tractationem suscipiendam, ne, si singulorum explicatio illis interjecta fuisset, tot ac



N

TAM LONGE PETITIS DISGRESSIONIBUS PERPETUÆ ORATIONIS CURSUS, & DESCRIPTARUM RERUM ORDO INTERRUPTUS, REBUS PER SE CLARIS VELUTI DENSAS TENEBRAS OFFUNDERET. HIS quasi fundamentis medicinæ positis, præclarum atque illustre de morbis opus, cui Pathologiæ nomen indidit, ante paucos annos perpolivit, tandemque in lucem emisit. In hoc quæcunque a veteribus bene scripta, ac rationibus firmis comprobata extant, ille retinuit: que vero omissa videbantur, de suo addidit, dubia stabilivit, obscura illustravit, falsa subvertit, superflua resecurit, nullius unquam in verba juravit, ne absurdarum sæpe opinionum defensor esse cogeretur.

Proximum erat ut cognitorum certisque notis deprehensorum morborum profligandorum methodum traderet Verum ne in singulorum morborum curationibus eadem identidem repetere cogeretur, & susceptæ rei cognitionem variis medicamentorum formis inturbare, tum simplicium, tum compositorum medicamentorum descriptionem præmittere decrevit. Itaque pari fide, nec minori diligentia quam quæ diximus opera, librum de medicamentorum compositione succisivis horis exaravit. In quo præter nova multa composita medicamenta, quæ longo usu efficacissima compererat, eorumque utendi modum, ea etiam quæ ex veterum præscripto ad quotidianos usus in officinis asservantur, diligenter examinavit, & alienissima, que vel numquam, vel non nisi cariosa ad nos perveniunt, expungens, nostratia illis suffecit, magno omnium mortalium commodo.

Solebat ille palam profiteri, nostratia pharmaca nescio quam habere nobiscum sympathiam, omnemque orbis partem, & suis, iisque peculiaribus, malis affligi, & propriis ac peculiaribus remediis a summo rerum omnium opifice concessis abundare. Ideoque summo in errore illos versari qui non nisi peregrina, & longe petita, atque idcirco cara medicamenta & commendant, & omnibus præscribunt, Gallos quidem, quoniam postremi medicinæ cognitionem amplexi sunt multa hactenus medicamenta, quæ adversus domesticos suos hostes, morbos inquam ipsos, in illorum finibus natura produxit, latuisse, que nostris sint laboribus non solum invenienda, & in usum afferenda, sed etiam literarum monumentis ad perpetuam rei memoriam committenda. Et idcirco nisi præmatura morte nobis fuisset ereptus, de nobiscum natis medicamentis purgantibus paratu facillimis, quorum omnium diligentissimus fuerat pervestigator, opus integrum aliquando edidisset.

Conscriptum de medicamentorum compositione librum semel atque iterum relegendo absolvit; purgantium medicamentorum non solum quantitatem ad calculum revocans, sed etiam illorum vires in multis ægris explorans, ne quid usquam in suis scriptis reperiretur, cujus vires in multis non essent comprobata.

Quod dum ille facit quidquid de simplicium medicamentorum temperatura, ac viribus in primis scitu dignum veteres literis consignasset, id ego ipsius hortatu ex eorum monumentis excerpti, & in unum contuli. Quod dum ille postea accuratius examinaret atque elegeret, parentheses (.) notam post descriptum singulorum temperamentorum passim interseruit, suam de unoquoque sententiam interjecturum, & quas in singulis deprehendisset singulares atque eximias vires a veteribus minime animadversas, in omnium mortalium usum atque utilitatem aliquando se explicaturum confidens. Et si enim Reipublicæ, literariæ & communis omnium utilitatis in primis erat studiosus, nolebat tamen que ad complures difficiles & pervicaces morbos multo labore, longoque medendi usu, sibi comparaverat insignia & valde effacacia remedia, statim omnibus innotescere, sed ea veluti arcana & ἀόρητα sibi reservanda putabat, dum editis libris ea a se excogitata & in usum primum allata omnes intelligerent, haberentque gratiam. Neque enim novum est, optimum quemque duci gloria & propagandæ nominis sui.





GLORIA, & PROPAGANDÆ NOMINIS SUI MEMORIÆ DESIDERIO INFLAM-
MARI.

ITAQUE NE QUIS EAM SIBI ERIPERET LAUDIS & GLORIÆ OCCASIONEM, quam tot vigiliis ac laboribus quasierat, operi de medicamentis simplicibus, in quod totus incumberebat, supremam manum admovendam non censuit, antequam curandorum morborum rationem literis tradidisset, quam eodem tempore emittere decreverat.

Verum enimvero dum haec animo cogitabat, ecce Henricus Galliarum Rex salutare ejus conatus & omnia consilia inturbat. Ille enim jam ante annos aliquot, mortuo Francisco patre, imperio positus, Iohannem Ferneliū (quem ob singularem eruditionem & incredibilem medendi felicitatem vehementer amabat, atque in archiatrum sibi jam pridem selegerat) ad se venire, & valetudinis suae curam habere jusserat: sed hic tantos honores prae literis, quarum amore flagrabat, asperratus, id muneris quasi hereditario jure D. Burgensi, Francisci Regis vita perfuncti, primario Medico obtigisse, debetique, multis rationibus vercunde contendens, veniam a Rege tantisper impetraverat, dum certius in multis agris ea experiretur, atque probaret, quae jam inter medendum annotaverat cum veterum scriptis parum consentanea, vel nova ad difficiles quosque morbos propulsandos excogitaverat. Sed demortuo Burgensi quum sufficeretur, causam dicere non potuit.

Annum tunc ille quidem aetatis suae circiter sexagesimum, sed cui tamen corpus erat robustum, & laboribus assuetum. Quae causa fuit, ut vita illa aulica, etsi tumultuosa, illi tamen prae inexhaustis laboribus, quos Lutetiae per annos jam multos superaverat, gratissimus Musarum secessus videretur: in quo se a Regis principumque negotiis plus otii ad suas lucubrations, quam Lutetiae a civium curis habiturum speraret. Neque profecto sua spe excidisset, nisi renovata saevissima bella, quae jamdiu Galli adversus Hispanos & Anglos continenter gerebant, Regem, qui Ferneliū a se nunquam dimittebat, sed quocumque proficisceretur secum deducebat, modo castra sequi, modo in hanc, vel in illam regni partem, in quam maxime hostes arma sua converterent, praesidii in ea vel collocandi, vel confirmandi causa, commeari cogissent.

Sed ne in tot quidem tantisque occupationibus diem ullum absque linea sibi effluere aut elabi passus est Fernelius. Siquidem februm curandarum rationem in peregrinatione cepit describere, eamque fere jam delineaverat, quum Rex Icium portum maritimum (Caletum dicunt) munitissimum, Anglis (qui eum centum jam annos occupabant) saevissimo hyemis frigoribus armis ereptum, secum pertraxit.

Inde reversus, uxorem ociosae & sedentariae vitae deditam, secum in fontis Belaii regiam sociam perduxit, quam maerentem se a suis avelli, paucos post dies febris continua, eaque acutissima corripit: qua crudeliter jactata, die tandem morbi vicesimo phrenetica convulsaque moritur.

Hic quam nemo omni ex parte sit beatus, facile fuit intelligere. Nam qui in calamitatibus, quas non raro illi in vita praeter animi sententiam accidisse memini, gravem, constantem, & fortem virum hactenus se praestiterat, hoc uno uxoris suae casu ita repente percussus ac prostratus est, ut ante duodecimum ab ejus funere diem ex summo animi maerore & angustia in febrim incidit continuam.

Lutetiae Parisiorum tum agebat Rex Henricus: ad quem quum renuntiatum est, Iohannem Ferneliū febre continua discruciatum jam acdebilitatum jacere, ejus vicem sane quam graviter molesteque tulit, & medicos alios sibi charos sedulo adhortatus est, ut ejus valetudinem curarent diligenter. Illud addidit, se haud posse sine gravi animi maerore ejus viri jacturam facere, quo vivo vix unquam se morituum credidisset. Itaque aulici, & celeberrimi quique medici, in eo invisendo mutuas operas conferre ceperunt. Hic interim minime malos Medicos



□ ❁ ❁ ❁ □

TIMITATUS EST, QUI IN ALIENIS MORBIS PROFITENTUR SE TENERE MEDICINÆ SCIENTIAM IPSI AUTEM SIBI MEDERI NON SATAGUNT: SED MOX UT FEBRE PREHENSUM SE ANIMADVERTIT, PRIMUM EJUS causam pervestigare, & morem observare, & minima quæque symptomata quid portenderent præviderè, & ut semel dicam, quæ ad ejus cognitionem aut curationem facere viderentur, excutere; deinde remedia efficacissima comparare, medicorum qui illi quotidie aderant, de his omnibus opiniones rationi consentaneas cogere cœpit.

Et me hercle ad septimum hujus morbi diem cum u— incalescent, & febris symptomata omnia multo leviora facta essent, qui illi opem ferebant medici, felicem exitum una cum agro expectabant. Verum ad undecimum mirum in modum exasperata sunt omnia, ideoque ager u— cruditate, atque aliorum symptomatum savitia permotus, ac mortis metu percubus, doctissimos Regis & hujus urbis Medicos aliquot in consilium adhibuit.

Hic, ut supra positum est, febre quartana aliquando conflictatus fuerat, & toto vitæ curriculo non solum vino oligophoro aqua abunde diluto usus est, sed etiam extra pastus, astate frigida potu sitim solitus erat, unde lien non parum lusus videbatur. Inde enim acoris cujusdam sensus ori ac faucibus integrum jam bienniu inerat, qui nullis remediis discuti poterat. Quum ergo causæ quædam externæ, hæque graves admodum, acerbissimum mororem attulissent, superveniente uxoris obitu, quo omnia exasperata sunt, humor in liene collectus tandem incalescens, atque putrescens, inflammationem ejus visceris peperit: unde & febris accensa est continua, quæ sensim increscens, ita naturæ vires omnes attrivit, ut eum decimo octavo die nobis immatura mors sustulerit anno ætatis suæ septuagesimo secundo, Christi* 1557 ("Natus ergo anno Christi 1485.") Nam causam interitus ex anatome pervestigantes, e lienis inflammatione perniciem manasse judicavimus, quum & valde tumidum & prorsus lividum ac viscens id viscus esset, & scalpello dissectum magnam saniei instar picis nigerrimæ copiam profuderit.

Hic certe ad morbi diem decimum quartum quum salutis suæ spem in angusto esse prævideret, se præpropera morte tam celeriter rapi graviter indoluit, non quidem vitæ, ut dicebat, desiderio, (satis enim naturæ, satis gloriæ, satis etiam uxori demortuæ, satique liberis vixerat) sed Reipub. vitæ, atque adeo Medicinæ causa: cui ut prædesset, omnes corporis voluptates atque valetudinem nihil fecerat. Hic dolor hominem præcipue angebat, hæc cura sollicitabat, quod therapeuticæ postremæ Medicinæ parti, in qua multum diuque versatus erat, quamque suis inventis plurimum læcuperare præterat, extremam manum non addidisset. Nec vero (quod Plinius de Apelle, qui imperfectum Veneris corpus ac rude Cois reliquit, memoriæ prodidit) qui inceptum, opus excoleret, præpararet, absolveret, inventus est. Inchoata ab eo opera Guillelmi Plantii fidei commissa sunt, de quibus alias.

Ioannis Fernelii nunciata mors gravem Regi, Reginae, ac aulicis proceribus mororem attulit. Non enim potuit non graviter ferre tam celebris Medici jacturam humanissimus Rex Henricus, cujus opem toties penserant, quem tot strenuos milites præclarosque duces a morte revocasse, tot hominum millibus auxiliare manus porrexisse viderat: nec minus reliqui Principes, qui ejus experientiam in gravissimis suis domesticorumque suorum morbis annos viginti perspexerant.

Hic equidem non tam sibi, quam hominum salutis, ac posteritatis commodis natus, nullum remittens tempus, nec se ipsum respiciens, quod interdiu præ agrorum ad se confugientium multitudine scriptis mandare non poterat, id ne brevissimis quidem noctibus parcens, vel magno valetudinis suæ dispendio elucubravit. In illustranda physiologia, & pathologia quum.

*N. B. Jean Fernel, b. 1497 d. 1558. Printing supervised by Roman Catholic Church and Government of Imperial France



HUJUS SÆCULI SCRIPTORES OMNES FACILE SUPERARIT, QUID ILLUM FAC-
TURUM FUISSE PUTETIS, SI QUAM ANNOS TRIGINTA TANTA LAUDE,
TANTO OMNINO APPLAUSU, IN TANTA ÆGRORUM TURBA LUTETIÆ
exercuerat, curatricem Medicinæ partem inventis suis illustrare fata voluissent? Sed ea est
miseriarum humanarum vicissitudo, ut neminem ad summum ascendere, aut votis omnibus suis satis-
facere patiatur.

Quum Lutetiæ medicinam facere cœpit, jampridem in summo pretio habebantur docti aliquot
medici, qui eum in ipsis principiis deterrere atque remorari conati sunt, quibus non multo post, fato
nescio quo, morte immatura de medio sublatis, superstes Fernellius, aliis palmam brevi præripuit.

Vnus Flexelius jam bene audientem & promeritum de civitate, vel obscurare, vel opprimere cogi-
tavit. Quum enim uterque arcanorum Medicinæ sacrorum summus princeps & mystagogus esse &
haberi cuperet, in eaque arte excellere in primis præclarum & illustre existimaret: in eo conatu tanta
facta est contentio, ut interillos benevolentia servari non potuerit. Flexelius namque gloriæ avidissimus,
cujusdam æmulationis stimulis impulsus, cum Fernellium, a quo nullum amoris, nullum studii,
nullum benevolentia officium desiderare poterat, reliquorum hujus urbis medicorum, qui illum ætate
autebant, & auram popularem jam ante ejus adventum consecuti fuerant, diligentiam atque famam,
non solum adæquare, sed etiam longe lateque superare cerneret, ejus conatibus sese obicere, atque pro
virili provectam ejus famam & existimationem extinguere constituit.

Arrepta inde ansa, quod Fernellius in cacochymia plenitudinis expertæ sanguinem abunde mitti non
pateretur, purgatione contentus, quæ peccantem duntaxat cacochymiam detrahit, quum venæ sectio
non solum cacochymiam, sed omnes humores equabiliter magna sæpe virium jactura evacuet, atque
tum maxime incommodet, cum obstructione jecoris, & mesenterii, & caloris insiti, aut ventriculi imbecillitate,
(quod fere fit) contrahitur cacochymia, ut in quodam ictero, in cachexia, & leucophlegmatia.
Flexelius enim & in omnibus febribus, quas putridus humor accendit, & in plerisque aliis morbis a ca-
cochymia ortis, sanguinem audentius ac sæpius mittebat, etiamsi nulla inerat plenitudo.

In quo uterque suæ sententiæ nimium inhaerere visus est. Fernellius quidem, quod parcius & reli-
giosius sanguinem detraheret, neque semper quum opus esset. Flexelius autem, quod sapius atque
ultra modum mitteret in omni fere morbo, frigido pariter ac calido, aliis medicis frustra obluantibus:
unde vires in multis sic sæpe prosterni atque labefactari vidimus, sicque spiritus & nativum calorem dis-
sipari, ut vel repentina mors, vel gravis & periculosus alius affectus consequeretur.

Verum cum Flexelius nec scriptis nec disputationibus publicis auderet Fernellium adoriri, convitiis
ingenuo & liberali homine indignis cum eo absente agere cœpit. Que quum Fernellius nihili faceret,
ita Flexelius exarsit, ut illum, qui & prælectionibus publicis & editis libris singularem suam eruditionem
orbi jam universo patefecerat, hominem ignarum, impostorem & circulatorum dicere non sit veritus.
Sed hic tamen nulla in Flexelium maledicta vel lacessitus retorquere unquam voluit, nec ei obrectare,
& de ejus fama detrahere. Si quando de Flexelio, ejusque in se maledictis, ab aliquo mentio fieret, me-
liorem ei mentem precari solebat: & ad egros curandos si quando cum illo vocaretur, negabat per sus-
pecta negotia, & occupationes serias, id sibi licere.

Non paucis Fernellius ejusdem ordinis parum gratus extitit, sed potius invisus, quod domestica re-
media, quæ amicis periclitantibus exhibebat, non pateretur vulgo in officinas abire, sed domi vel ipse



❖ ❖ ❖ ❖ ❖

FT "SED DOMI VEL IPSE COMPARARET, VEL AMICORUM PAUCORUM FIDEI CONCREDERET. QUOD TAMEN ANTE SE NEMINI VITIO DATUM ESSE COMPERIO.

Sed de his plus satis. Iam quem tenuerit studiorum modum, ex quo Lutetiae medicinam facere coepit, paucis, perstringendum.

Iampridem apud Gallos invaluit consuetudo, ut quando infimae sortis homines in morbum, incidunt, u— confestim ad medicum deferendam curent, e qua ille non solum, quamdudum aeger decumbat, quo morbi genere teneatur, quae pars in eo praecipue laboret, quaeq; symptomata crudelius illum discrucient, sed ejus etiam sexum & aetatem internoscat, ac nuntio referat, tandemque accommodata remedia decernat. Hoc jam olim vulgo persuaserunt scelerati quidam impostores empirici, qui medici nomen ac dignitatem falso & impudenter sibi arrogantes, populo eruditionem suam ita venditabant, ut eum dicerent medici nomine indignum, qui spectata u—, cum affectiones corporis praeter naturam omnes, tum animi etiam perturbationes non posset assequi. Ex horum officina praecleari illi, & Reipublicae (si Diis placet) non parum utiles, de u— cautelis libri prodire, quibus rudis adhuc medicus instituitur, acute excogitatis inanum verborum labyrinthis, eorum qui ad se u—deferrent, mentes & iudicium ita eludere ut tametsi temere, confuse, & fortuito nulta symptomata proponat, & enumeret, si forte tamen vel unicum, de quo aeger conquereretur, attigerit, illi statim recte eum conjectasse, & ex u—totam morbi historiam intellexisse arbitrentur.

Receptae igitur Medicorum consuetudini, licet iniquae & depravatae, morem gerens Fernelius, ab u—inspectione medicinam facere coepit. Mane siquidem ad quartam fere horam expectectus, e lecto prosiens in bibliothecam descendebat, ibique vel e veterum scriptis quidpiam de quo sibi non satisfaceret, vel cujus non satis meminisset, percurrerat, vel ipse aliquid commentabatur, dum illucescens dies illum ad publicas praelectiones, vel ad invisendos aegros prodire cogeret. Interimque adferebantur u— omnes ille inspiciebat, & de iis quid sentiret paucis praefatus, remedia instituebat morbi causae, & aegri naturae, quantum conjectura colligere poterat, consentanea.

Domum ad cibum reversus, interea dum prandium apparabatur, in bibliothecam, atque rursus sumpto prandio in eandem se abiebat, dum illi in urbem ad sua negotia esset redeundum. Non alio ante caenam interim dum mensa instruebatur, nec denique alio post caenam se recipiebat, ad horam noctis undecimam: quo fere tempore capitis gravitas somnum illum capessere cogeat. Hanc quidem tenuit studiorum ac vitae rationem annos amplius triginta, & eas in studiis progressiones semper habuit: Omnia animi & corporis oblectamenta praeter litterarum studii, & medicae artis exercitatione, pro nihilo ducens: ut nulla vite pars neque publicis, neque privatis, neque medicis, neque domesticis, in rebus vacasse officio videretur. Si quem forte ad caenam vel prandium aliquando invitaret, ab eo neque turpe, neque inhonestum ducebat, aliquanto post sumptum cibum studiorum causa se surripere.

Uxor is hortatu praedium Pentinianum, annis aliquot antequam e vivis abierit, comparavit, ad quod colligendi animi gratia e turbulentis urbis fluctibus tanquam in tranquillum portum se aliquando reciperet. Verum vix semel aut bis in anno eo proficisci voluit. Erat enim hoc robore animi, atque hac indole virtutis, & conticentiae, ut respueret omnes voluptates, omnemque vite suae cursum in labore corporis atque in animi contentione conficeret: quem non quies, non remissio, non aequalium studia, non ludi, non convivia delectarent, nihil in vita expetendum putaret, nisi quod esset cum laude, & honore"



□ ♣ ♠ ♠ ♣ □

U & CUM DIGNITATE CONJUNCTUM, NIHIL QUE EX OMNIBUS REBUS HUMANIS PRÆCLARIUS AUT PRÆSTANTIUS HABERET, QUAM DE REPUBLICA CHRISTIANA BENE MERERI. AFFLICTIS OPEM FERRE, periculis ægrotos liberare, succurrere omnium saluti, suamque salutem posteriorem salute communi ducere, denique intercludere omnes morborum vias. Quippe tantus ægrotorum numerus ad eum confugiebat, ut per totam fere ætatem stans prandere cogeretur: neminem quantumlibet pauperem a se abire dimittebat morbi quo angeretur ignarum, remediisque ad eum profligandum destitutum. Quod si illum nonnunquam de curanda corporis sui valetudine, deque nocturnis studiis intermittendis, commonefacerem, & ad quiescendum cohortarer; (erat enim somni parcissimus) responsum in promptu habere solabat, Longa quiescendi tempora fata dabunt.

Quamquam autem vultum ille præ se ferebat Philosophicum, severum, ac tristem, quamtamen ad ægros accederet, subridendo se hilarem præbebat, blandeque ac comiter illos vel de minimis symptomatis interrogabat, dum & morbi causam, & affectam partem, perspectam haberet: atque haud scio an ullus tam obscurus morbus ei unquam occurrerit, cujus scaturiginem ac naturam statim non agnovisset; an unquam tam implicita, tamque varia symptomata proposita sint, quæ non statim ad peculiare morbos tanquam ad suos fontes revocarit; tanto, tamque acuto, & perspicaci ingenio, judicioque præditus erat.

Ille ægrum, vel moribundum, ac deploratum, deterrebat nunquam, sed semper in salutis spem erigebat: oculorum necdum plane cognitorum morborum prædictiones ambiguis & obscuris verbis involvebat, que alii in aliam partem deflectere & interpretari possent: vixque initio quicquam de horum eventu, nisi ex hypothesi asseveranter pronuntiabat. In diuturnorum præsentatione vix unquam falleretur: futurum exitum tristi vultu, mæsta & clangosa voce laborantis amicis metuendum infinuabat: prævisam salutem hilari fronte, & jucunda oratione, pronuntiabat. Aliorum medicorum calumnias nunquam ridebat, recognoscens, sibi & bonis omnibus similes quotidie impendere.

Quemcunque ægrum ingenio præstantem curandum invisebat, siquidem morbi vehementia pateretur, & per negotia liceret, post intellectam morbi causam, & descripta remedia, familiarem cum eo sermonem aliquandiu conferebat, cum Philosophis Philosophica, cum Mathematicis Mathematica: cum ducibus, ac militibus, de urbium situ, & fluvii eas alluentibus, deque instrumentis bellicis, & eorum inventoribus, de arte militari: cum nautis, de navigandi ratione, & regionibus nuper repertis: cum Théologis, de Deo, ac coelestibus: cum mercatoribus, de negotiis: ut afflictos omnes consolaretur, & jacentes extolleret, confabulationes iniens. Sermones, & colloquia plane Philosophica, & nimium severa, salibus ita aspergebat, atque condiebat, ut ab omnibus coleretur, & observaretur, & tamen urbanus factusque videretur.

Corpore erat satis procerum, ac robusto, sed quod nephriticus dolor acerbissimus, quater aut quinque quotannis repetens, non parum debilitaverat, color faciei livescens, ac plumbeus, pilus nigerrimus, isque multus.

Quod ad animi mores pertinet, si quando iracundiam exercebat, mox cohibebat: semper fere cogitabundus, subtristis, ac taciturnus erat: nemini sua confilia communicabat, suspecta habebat omnia: attentus quidem ad rem familiarem, sed in suos beneficus, & liberalis.

Quandiu cum eo vixi (vixi autem integrum decennium) lucrum annuum sæpe duodecim librarum Gallicarum millia excessit, vix unquam infra decem substitit.



N JEAN FERNEL WHO WAS THE GREATEST AND BEST MAN OF
ANCIENT AND MODERN TIME EULOGIES.

SIMON PONCETIVS
Melodunensis Doctor Medicus ad

LECTOREM.

*Laetis Arabs Graijsque suos: Fernelius artem
Lampade perlustrat splendidiore tibi.
Abdit nam radians in apricum singula proferis,
Et quicquid solidum pulchrior usus habes.
Phabum erat. Sed max quum Gallus imminet atro
Turbine seditio, prob dolor! eripitur.*

ΑΝΔΡ. ΤΟΤ ΡΙΒΑΤΑΗΑΙΟΥΤ

*Πικτωσ' εἰς τὸ τὸ μακροτέρῳ Φερνελίῳ θεασί-
σισι σύγγραμμα ὑπὸ Πλαγίου ἀκρωβωβίν.
Οὐκ ἦν τῷ τῷ μύθῳ, ἀλλ' ὅσοι καὶ ἴσασιν
βιβλίων, Φερνελίου εὐαγγοῦ ἰπποκράτους,
Κ' ἐξ ἑαυτοῦ παρασκευάσει τὸν ἴσσορον, ἢ δ'
ὄψια τῶν ἡτων γνώμοισι ἐκ βασιάν.
Ἡὲν δ' ἰπποκράτης Γαλιῶν χειρὶς ἀμαυροῖσι,
Κλαγίῳ ὡς χειρὶ, βιβλίῳ Φερνελίου.*

RENATI GERVASII IN PRIMO
Gallie Senatufaufarum Patroni . de
Joanne Fernelio Medico.

*Hippocratem natura parens mortalibus olim
Edidit, ipsa sunt quo retineret opum.
Hoc duce longa fuit, magna ratione medendi,
Vita hominum. Tandem Fernelinque dedit.
Quo medico Doctore volat tua, Gallia genies:
Fama per ignotum. Omnibus ille salus.
Iam vero ipse Deus, longos ut carperet annos.
Fernelinum & terris, quem dederat, rapuit.
Antiquitas solum Natura laudibus: iisdem
Nostra celebrabunt secula Fernelium.*

ΕΙΣ ΙΩΑΝ. ΦΕΡΝΕΛΙΟΝ
Ἐπιτάφιος.

*Τῷ χθονὶ Φερνελίῳ σόδοις ἴσασιν, ἢ δέμοις αὐθις
Παλλάδι, καὶ Παλλὰς δόμοι τῆ Οὐρανίῳ.
Οὐροῖν πέρι αὐτῶν, μύθῳσι τῆ Φούροισι,
Κεκοσμηθῶσιν ἀρχίσσοισι βασιλῆϊ.
Τόσδ' ἀρ' ὑσσημισίσι ὅ, τὴν ἐκ χειρῶν ἀνάγει
Αἰὶνὸν ἢ δ' ἄσσοισι κτῆσιν ἀνεύροισιν.
Καὶ σσώδῳσι τῶ μῦθῳ, τοῖσι δ' ἴσσοισι τῆξασιν
Ζῆσι ἀσπίδῳ τῆσι μῦθῳ τῆ χθονί, τῆσι σσῆσιν.
Φ. Φέροισι Β.*

IN IO. FERNELIUM.

*Natumam melius, morbus, medicamina, casus
Nemo uno docuit, Gallus, Fernelio.*

IN EVNDEM.

*Iusserat Latice mysteria Delius artis
Scribers: Fernelius scripsit, & occubuit.*

IN EVNDEM.

*Hippocrates mortuus arcannum credidit aris.
Fernelio: hinc fama par fit & ingenio.
Elafus Fabius.*

ΕΙΣ ΤΟΝ ΙΑΤΡΙΚΩΤΑΤΟΝ ΦΕΡΝΕΛΙΟΝ.
*Ἰπποκράτης ἰατροῦ σσώδῳσι, μῦθῳ τῶν Γαλιῶσι,
Τοῖσι δ' ὅσι Φερνελίῳ τ' ἀξίῳ πατῆρι σσῆσιν.
Ἰάτῳ Ἀντωνίῳ τῷ Σαρακινῶ.*

In Io. FERNELIUM Medicum.

*Amplius grande sophos buccis & nomina mille
Turba supercilio sublato surgida jactet.
Mi fasus hoc, toto Medicus quod comprob orbem.
ANTO. FAYVS.*

EPITAPHIUM

IOANNIS FERNELII

Prout legitur in Aede Divi Jacobi ad Lanienam Parisiis.

See Chart First & Second Editions





ANKIND'S CHILDREN AND THEIR POSTERITY ARE BLESSED BY
ANCESTORS' GOOD DEEDS.

VIRORVM CELEBRIVM -
DE FERNELIO IVDICIA
SCAEVOLA SAMMARTHANVS

ELOGIORUM LIB. I.

AMBIANUS ager unde Silvius & ejus præceptor Tagautius prodire, tertium quoque Medicinæ lumen, & quidem cæteris limpidius, nobis extulit, Johannem Fernelium, virum singularem ac plane divinum. Cujus admirabili genio id contigit, quod a multis sæculis nulli, quamlibet erudito, contigisse memini, ut ipso vivo atque vidente, opera quæ de Universa Medicina scipsit, in scholis publice legerentur: ejusque auctoritas, veterum Scriptorum instar, apud optimum quemque rei medicæ magistrum gravissimi esset ponderis & momenti. Neque sane injuria: fuit enim in illo viro præter summum eloquentiæ candorem non solum Medicinæ, sed & Mathematicarum artium totiusque naturæ tanta vis tantaque cognitio, ut prodigii cujusdam id fuerit simile. Neque vere fuit hoc minus mirandum, quod & ejus virtuti fortuna ipsa bonis ut plurimum iniqua, non defuit. Nam & Lutetie sanandis ægris operam præbens rem egregie fecit, & ab Henrico II in regiam accessit principem inter ejus Archiatros locu tenuit. Eo felicitis operæ proventu, ut quod a natura negatum esse videbatur, artis beneficio consecutus invisamsterilitatem a domo Regia repelleret, Valesiumq; nomen optata generosæ prolis accessione propagandum curaret. Periit ex mærore, quem carissimæ uxoris importuna mors ægro invalidoque seni attulit 6 Kal. Maias illius anni quem Poeta medicinæ studiosus non insolue notavit his numeris.

ConIVge FerneLIVs rapta perCULsVs, Vt aVLæ,
Ut LUCIs satVr, Vt noMInIs, InterIt.

JAC. AUG. THAUNUS Historiarum Lib. 21.

FUIt & hic annus (CIC IC LVIII) doctrina illustrium Virorum morte insignis, nam XII. Kal. Aprilis &c. Et sexto post die apud nos (obiit) Joannes Fernelius, Ambianensis, cum Lxxii. annos exegisset, Regis Archiatros, Lutetia ad B. JACOBI in macello sepultus. Qui cum plureis annis in Philosophicis & mathematicis studiis summa cum laude exegisset, demum se Medicinæ totum mancipavit: quam & feliciter fecit, & universam doctissimis & politissimis scriptis complexus est: quæ etsi morte præventus non ædidit omnia, ut nec propriarum Observationum desideratissimos libros; tamen veram gloriam iis quæ publicata sunt Europa tota est adeptus, ut tanto viro disciplinæ etæ alumnus schola Medicinæ Parisiensis æternum sit jure glioriatura.

JOH. CRATO aKRAFTHEIM, Ioachimo Camerario apud Scholt Zium, Epist. 110.

De Fernelio hoc dixisse Fallopium, Fernelio hoc tempore attribui palman in re medica, etiam illius æmuli non negare posse, & Italos, qui suo more magnos viros obtræctionibus volunt premere, necessario agnoscere, Fernelium summum hujus ætatis Philosophum & Medicum: velle tamen minus eum fuisse audacem in reprehendis veteribus. Vide quam Fallopii judicium cum tuo consentiat."



M

JOH. CRATO. A KRAFTHEIM, CÆSARÆE MAJESTATIS ARCHIATROS,
ANDREÆ VVECHELO TYPOGRAPHO DE FERNELIO RURSUS IN LUCEM
PROFERENDO, ETSI QUÆ AD PRIORA NUNC FIAT ACCESSIO, IGN-
orem, tamen cum ipsum autorem ante annos XV publico scripto probaverim, studium quoq;
tuum magnopere probo; & etiam nunc in ea sententia maneo, semperque mansurus sum,

præclare Fernelium de universa Medicina esse meritum, nec me ab ea (licet hoc quidam facere conati sint) dimoveri patiar. Nam cum ante anos octo Plantius publice scripsisset, Fernelii opera me in meis scriptis adjutum: fuisse quosdam memini, qui parem hoc ad existimationem meam pertinere existimarent, verum tantum abest ut moleste hoc feram, ut Plantio etiam demortuo gratias agam, qui mei honorifice hoc in loco mentionem fecerit. Nam si meum libellum integre legit, haud dubie, æquissimo animo tulit, in quibusdam me a Fernelio dissentire, atque abortum istum (sic enim vere Isngogica nostra appello) non omnino improbat: si epistolam saltem quam præposui inspexit, nimium bonam de me habuisse opinionem necesse est. Cur igitur de illius facto male sentiam, aut quod re ipsa verum esse statuam, verbo negem. Ego vero utilem mihi fuisse lectionem scriptorum Fernelii ex animo profiteor, & hunc in Medicina profecisse, cui Ferneliana non displicent, statuo. Esse quædam & a pervulgatis opinionibus, & usitatis magnorum autorum sententiis, in arte nostra discrepantia, in itis non ignoro, & a doctis in disceptationem non pauca vocari intelligo. Verum quin præstantissimis viris, qui contra Fernelium disputarunt, idem quod mihi evenerit, ut cum in ea inquirerem (id quod ii fecisse me, qui nostra legerunt, sciunt) plurimum in disquisitione erudiar, non dubito. Vidi Victoris Trincavellæ præclarissimi Medici doctrinas quasdam in quibus acriter, modeste tamen, cum Fernelianis rationibus pugnat. Sunt & a Fallopio ingeniosissimo quædam vehementer, ut hominis natura ferebat, dicta. Sed illos ipsos quos ingenio & magno artis usu excelluisse sciunt omnes, utilissima scripta Fernelii censere manifestum est. Rondeletius parum æquum se illi epistola ad me prolixè scripta ostendit. Cum enim illius sententiam de mea Isagoge exquirerem, ut in Ferneliana animadverteret, præcipue eum occupari, nemini est obscurum. Idem ab aliis Gallis factitatum audio. Verum ista æmulationis, quæ rivalitati similis perhibetur, vis est. Evenire in Italia idem summo viro Iohanni Baptistæ Montano præceptoris meo doleo, & nuper animi mei sensum Clarissimo Medico Hieronymo Mercuriali patefeci. Verissimum autem est, scripta, ac potius excepta & divulgata, illius nomen minime illustrare: verum si recte reputare volumus, ad istum modum cogitata esse, ut plurimos qui deinceps scripserunt, & nunc quoque docent, præclare adjuverent, licet hæc dissimulent, apparebit. Sed de Fernelianis agamus. Memini, cum ante viginti octo annos Physiologica Fernelii prodissent, & Argenterius sua quoque proferret, Montanum vehementer Fernelii, atque adeo omnium conatum, in dilucidandis scriptis veterum probasse, & nimio Argenterii reprehendendi morbo, quem ille prodit, graviter offensum esse. Bassianum vero Landum virum ingeniosum, & philosophicis studiis atque elegantioribus litteris in primis politum, quem post meum ex Italia discessum atra dies abstulit, cum forte ad me venisset, & apud me Fernelii librum impulsisset, totum cupide domi sue perlegisse, mihi quoque illius iudicium exquirenti hoc respondisse; Gallus iste ingenii & doctrinæ luce atque ordine nobis Avicennam vel totum obscurabit, vel ut multos illius errores videamus, faciet. Vere Bassianum iudicasse, nec minus Fernelium quam Avicennam de arte Medica bene mereri voluisse, monumenta ingenii, voluntatis speculum sunt. Quanto autem illustrius & evidentius omnia in Fernelio quam Avicenna appareant, qui non perspicit, ille sua quadam persuasione cæcus est.





A

THOMAS JORDANVS de Peste, Cap. 12.

IOHANNES FERNELIUS, AMBIANUS IN ARTE MEDICA NON ALITER QUAM HERCULES IN AEGLE STABULO REPURGANDO, UNIVERSO VITÆ tempore, & quidem felicissime occupatus. Monumenta singularem raramque eruditionem

testantia, ostendunt, quam longo intervallo omnes qui modo vel olim scripsere a tergo reliquerit: ut nullus equidem illi par, nedum superior jure haberi censerique debeat; tanta dexteritate, sermonis nitore, elegantiaque dissipata, ne dicam confusa, dispersaque hinc inde, vastæ artis volumina in compendium redegit, ut nec quod intermissum desideres, nec quod superfluum reseces, vix quod reprehendas noris-ipse. Quapropter nostri seculi phoenix non indecoro elogio quibustam appellatus fuit, cujus vivacitatem utinam fata illi concessissent plurimos utique relicturus fuerat purissimæ limpidissimæque sanguinis suæ perennes rivulos, quibus horti Medici saluberrima irrigatione aspersi fructus non absimiles edidissent. Attamen volumina quæ extant, tamam nomenque illius aternitati perpetuæ jamdudum consecrarunt, quare præstitit, pede revocato, nihil quam pauca de ejus laudibus dicere, & quia jam maximus volitat per ora virum.

JOH. HEURNIUS de Sudio Medico Cap. 5.

Vnum ex hujus temporis Scriptoribus Veteribus addo, doctissimum Fernelium, qui Arabum ductum non sine Græcorum demonstrationibus secutus fuit. Ejus lectionem laudo: non modo cum jam dictis auctoribus conferatur, locaque annotentur, ex quibus suos rivulos traxerit: optima enim ex cunctis seligit, sed stare ejus auctoritate non potis est nisi ubi firma demonstratio sua stabilivit. Quare antiquos suos fontes si refundi possit, sane limpidissimam firmamque scientiam pariet. Sed tetus et abduci nequit, ut qui sponte interdum declinat & abit. Quid tunc agas? litem dirimit antiquorum demonstratio collata cum hujus rationibus: & usus, hæc si vicerint, excutiantur nova tanquam amentata: hasta, sin Fernelius quid melius, retineatur & gratia illi ascendant ut qui per cetera medica auxit. Sed gravis hic est auctor nec in primo medicinae limine ponendus; sed a Galeno hoc potius utendum. Qui tamen compendiosam Medicinam nimium amat, hunc legat cum judicio is enim, ut verum fatear, Græcam & Barbaram medicinam fere uno in volumine conclusit, & præcæcis locis Philosophiam Medicinæ intulit: ut non sit necesse aliam physicam usibus medicis quærere: cum ex latissimo nature ambitu facunde medicum campum irrigarit. RODERICUS a CASTRO, Lusitanus, Medici Politici Lib. II Cap. IX quo de Medici Bibliotheca. Fernelius superiori saculo, Averrhois & Avicennæ inculcatis dictionem animadvertens, eorum nomina obscurate detexit, edito egregio atque eleganti opere, quo universam fere medicinam complexus est, absolute quidem, si de crisis & diebus decretoriis tractationes ex Galeno aut aliunde suppleas: Ac morborum curationes ex Raza, vel Avicenna, & si novas aliquot opiniones, quas interdum inserit diligenter examines. Librum autem scripsisse videtur, sperans fore, ut aliquando in Academiis loco Avicennæ enarraretur, quod tandem post mortem in Germania obtinuit, nam—

Pascitur in vivis livor, post fata quiescit!



NEVER WAS THIS ANCIENT METAL HISTORIC, MONOGRAMMIC SWORD OF DR. JEAN FERNEL DRAWN IN A DISGRACEFUL CAUSE OR SHEATHED IN DISHONOR. HILT $\frac{1}{2}$ GOLD, MADE IN ITALY, AND BLADE WAS MADE IN DAMASCUS. AUNT PARMELIA WAS NAMED FOR PALM TREE ON ITS BLADE. OTHER NUMEROUS SYMBOLS ARE

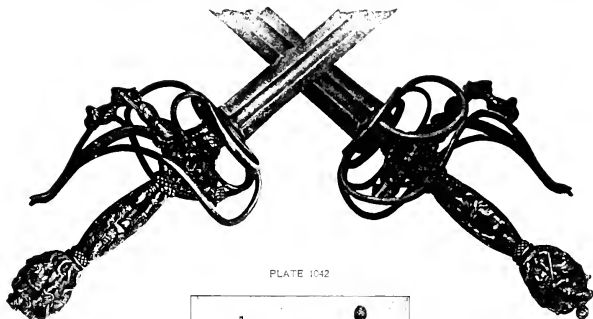

PLATE 1042

A PICTURE HISTORY OF FAMILIES THUS RE-SAME ANCESTORS AS IS ON 3RD SWORD FROM AND HISTORY CONTIN- THAT, 2ND GEN. GEORGE COL. TOBIAS FERNALD, FERNALD OF LOUISBERG COUSIN, AND IT BEAR-MONOGRAMS WITH COAT OF ARMS THE SERPENT, RATTLE WHICH THE UNITED AMERICAN REVOLU- ERTY. See 2nd Edition for graphs of Ohio Mound Serpent there engraved with the great recording supposed lost history

The writer has refused the Washington. The one below Albany, New York.



1 2 3 3 2 1
PLATE 1043—FERNALD THREE SWORDS.

THE ANCIENT FERNALD CORDER AFTER THE OF PERSIAN ANCESTRY THE RIGHT AS IS SHOWN UED ON THE SWORD WASHINGTON GAVE TO THE SON OF CAPT. JOHN FAME. THAT HE CALLED ETH THE FERNALD THEIR CRESTS OF THE CROWN OF PERSIA AND SNAKE FLAG UNDER STATES TROOPS IN THE TION FOUGHT FOR LIB- full reading of them and photo- with views of some foremothers mixtures of the ancient languages of great value to all.

sum of \$2,000 for this sword of and his staff are preserved at



WASHINGTON'S SWORD AND STAFF.

PLATE 1044—GENERAL GEORGE WASHINGTON'S FRENCH SWORD

D

DESCENDANTS OF THE FAMILY KEEP THEIR FACES AND RECORDS IN A MOST CAREFUL MANNER TO PROTECT THEMSELVES AGAINST CRIMINALS THAT ARE UNPUNISHED.

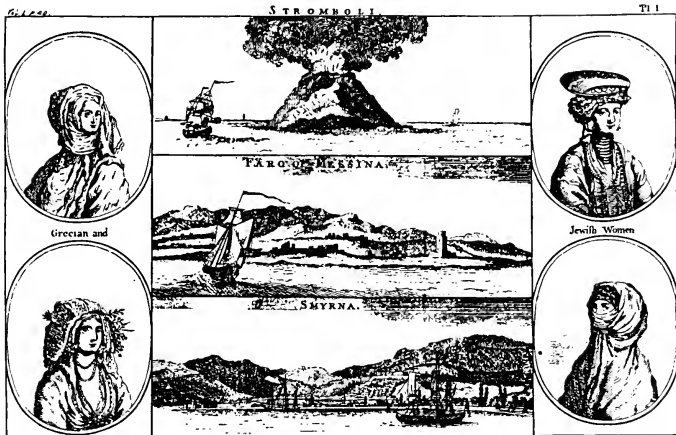

I. MAGDALENE LUIL-
(English for Jean) Fernel,
great expense in making
ments by not only using all of
hers at the time became
cried and complained to her
of Paris. The good Attorney
peal to Jean to desist from the
astronomical, gynæcological,
till he acquired enough money
and then use the surplus to
benefiting mankind. This
appeal was granted.

II. MARIA COMMENUS,
FERNEL, son of Dr. (Jean)

III. Anietta de Coligny, da.
and widow of Dr. John, son
Fernel. Her mother's name,
Anietta.

IV. REBECCA, da. EMAN-
wife of Francis J. Fernel,

Henry II, King of France,
went through with him, was
for saving the life of his lady
becoming aware of Jean's true
go to Court and act as his
unsuccessfully by Jean and



LIER, Wife of Dr. John
who, seeing her husband at
mathematical, surgical instru-
his vast income but part of
alarmed. She murmured,
Father, who was Counsellor
General of Paris made an ap-
great expense of making
surgical with other instruments
to provide well for his family,
make the instruments for
wise advice and courteous

wife of FRANCIS JUNIUS
John Fernel.

Admiral of France, Gasparde,
of Francis, son of Dr. Jean
I have a found Record, was

EUIL TREMELLIUS, 3rd
foreparents of Peter Faneuil.

whose wars Dr. Jean Fernel
much attached to Dr. Jean
before their marriage, and
parentage, compelled him to
physician, which was evaded
his wife, Magdalene Fernel.

“**S**TROVE THE PRINCIPALS OF COLLEGES WHO SHOULD HAVE HIM NOT TO TEACH LOGIC FOR A CONSIDERABLE STIPEND. HE WOULD NOT ACCEPT THEIR OFFERS. HE READ CICERO, PLATO, ARISTOTLE and most wise knowledge of those times. Four years he studied medical literature, graduated. Arose at 4 a. m., studied till time to read lectures or visit patients, returned to his books, ate and returned to his studies, which he did not leave till a necessary interruption required. At night he would leave his books for supper and return to them and study to eleven o'clock. Return-

ing from his wife, alarmed went to live with beau where she death, and he, a wards with every the foes of his dates, names, ings, writings marriages, places death, for enemies and demost respectable lies to the time



Plate 1048.



Plate 1049

dition of Calais, for the future, him at Fontain- was poisoned to month after- change made by forefathers, the features, say- altered even of birth and strengthening stroying these and godly fami- of Dr. Renald

Fernald that left Europe from persecution, for Strawberry Bank, New England," which continueth to 1908-9.

Dr. Jean Fernald, while at court, was asked by King Henry to cure his wife of barrenness and their conversation was thus kept: "Master Physician, can you get my wife with child?" Jean very properly answered: "Sire, I will be pleased to use all the skill God has given unto me by the proper use of medicines and appropriate measures indicated for the cure of her Majesty the Queen. "The rest I leave to your Majesty, Sire, and the gracious blessings of God." And it is a fact of common history that the Stork visited the King and Queen frequently.

Twenty million dollars of Dr. Jean Fernald's vast estate went to enrich the Roman Catholic Church and as it pleased them by Popes, Vatican, Bishop, Archbishops, and their protected in all crimes tools, to continue their evil work, the writer of this made full claim for it. Cast interest on the same and divided the bulk among the worthy nations of earth by proper Checks sent to them for universal needed protection against all those who destroyed the families of Napoleon, my only child and wife mother, four sisters, and 150,000,000 of godly persons, the Martyrs: with 1546 and one attempt on a christian physician's honor, 39 attempts on his life from March, 1870, to June 1908-9, and much of this for attempting to prevent the slaughter of the 16 Roman Catholic builders of the secret passages under Church of Bishop Williams; Boston, Mass., U. S. A., that the grip of the Vatican is upon; unless these works of God by his humble servant can arouse the brave and pure of all nations and churches to prevent the deluge of ignorance, crime, hypocrisy, unrighteous and unlawful greed with general and self destruction. The three Laws and enforcement of God's Commands is your safety. THE HAGUE is appointed of GOD. Let every individual support it for common NATIONAL Good transmit to posterity. In labors for papal representation at Hague it was found they desired it from selfish and not godly purposes. I would have helped them, but they would not do the work as God, Christ, commanded. Queen Mary per]Pope, Vatican, Jesuits, burned 5 Bishops, 21 Ministers, 129 Laymen, 55 Women, 4 Children to death. Is this Christianity which "never changes?



AT THE CONVENT OF VISITATION WAS SENT MY LETTER A FEW YEARS AGO, MAKING RESPECTFUL INQUIRIES CONCERNING THE CHILDREN OF DR. JEAN FERNEL, RECEIVED A BOYCOTT IN U. S. for it. Then the Records of relationship of Guy Patin with a deposition and court papers were taken with injury from my Yale locked desk while at church. Plate 1051 shows resemblance. He mentions two daughters of Dr. Jean Fernel, viz: "There is in the convent of Visitation at Lyons a da. of M. de Riant, counsellor of state. Her mother is niece to M. de Narbonne: her name is Mary des Prez. This beautiful nun, who has not yet made her vows, amongst other eminent qualities she possesses, is considerable by her birth, being descended from our great Fernel, who was really an incomparable physician. He left two daughters, the eldest of whom was married to M. Barjot, president in the grand council, and master of the requests. Dr. Jean Fernel and family were Protestants, also Dr. Ambrose Pare. The other was married to M. Giles de Riant, president au Mortier, who died in 1597. Her name was Magdalen Fernel and she died in 1642, aged 94 years. Et generatio rectorum beneficitor. I am very sorry that I did not go formerly to Villeroy, in the earldom of Perch, where she died, on purpose of having the honor of seeing her and kissing her hands. They make us kiss relics which are not worth these. So that your beautiful nun may boast that she is descended from the greatest man that was ever of our profession since Galen, because the great Fernel was her great-great-grandfather." In this extract from Biog. Dict. 1784 is when read in primitive language and translated gives him, Guy Patin a descendant and the F. J. Francis Junius as son of Jean. Vide Edition Second for its reading. "Fernelii discipulus [Jodoc. Lommivis (van Lom) Burensis-Geldrus, Medicus Turnaviensis, post Bruvellensis Ej."

GENERATION CLI.
 MENUS, da. of John Amos Phil Comenius of Savoy from Cormenin the writer of the the Popes of Rome, descend-
 Fnr Maria, b. 10 Oct. 1532; 1555 FNA FRANCIS JUN-
 Fernel and Magdalen, b. 3 1602: m, 3rd Rebecca, da., Rachel: 4th m. Elizabeth, da. from first w. no chn. They Kal. Id. March 1556: d. 1559; d. 1596: m. Capt. John 1631: 3 Anne, b. 20 Nov. 1560-
 ton whose nom de plume was cis, b. 1563-1603: 5, Magdas Fernalius: 8, Joannen Far-
 Fenne: 10, Tobias Fennel: nual: 12, Alexander Furnus: called Protestant Goliah; fa- of Granary Cemetery, Tremont as Peter Funal or Funel called ancient Bible name; Geneis 31, where points were inter-
 a deed to the City of Boston Benjamin, Andrew, Benj. m. 3 Mar. 1743, he gave money 1742 to aid in Spanish War. 14, Francis Funis: 15, Bertrand Fernelion: 16 and 17, Thomas Furnival and Joanna: 18, Josse or Justus Vondel=Fondel, m. Mary, Jesuit niece of Maurice who caused him to be fined 300 livres; Dutch Poet, Author, d. poor, with many chn.



PLATE 1047. Francois Junius Fernel and Sons. John and Francis.

FNR MARIA COM-
 Commenius and Marie, s. whom descended Louis Marie Public and Private History of ants of the Comneni families: d. 29 March 1571: m. 2 Apr. IUS FERNEL, s. Dr. Jean March 1533: d. 10 Sept. Emaneul Tremellius & wife Marquis Bertrand Fenelon: had XVIII chn. Joannes, b. 15 1575: 2, Maria, b. 10 Jun. Smith, b. Jan. 1579: d. 21 Jun. 1621: m. Samuel Washing-
 William Shakespere: 4 Fran- len: 6, Margaret: 7, Nichol- ineus Fillelen: 9, Otto 11, Henrietta Catherine Fer- Daniel Furnieu, 13 had Peter, Peter, bur. in my Tomb Old St., Boston, Mass., U. S. A., Faneuil, one spelling of our Chapter XXXII, V. 30 and polated in the F for P, I gave of the Hall, not Market. Had had Peter, b. 20 Jun. 1700, d.

NOT PLEASED WITH THE VIOLENT CONTESTS BETWEEN PAPISTS AND PROTESTANTS, REV. FRANCIS JUNIUS FERNEL, WHO WAS B. AT BOURGES, STUDIED AT GENEVA AND AT 32 MADE MINISTER OF WALLOON church at Antwerp, left to become Chaplain to the Prince of Orange and attended him in various expeditions. He studied Law and Medicine besides Military Tactics. Afterwards he read public lectures at Neustadt, and Heidelberg, and then visited France for the purpose of recovering his inheritance from the enormous estate of the late Dr. Jean and Magdalen Fernel but was thwarted by the convent of Visitation and Roman Catholic Church, although kindly received by Henry IV, who, it was said, knew he was rightful heir to the throne of France but did not desire to strengthen one who might be a claimant. Unsuccessful in obtaining justice he retired and settled at Leyden. His sons John and Francis were both born at Heidelberg and both studied mathematics to lead a military life, John choosing the sea. The conclusion of the war altered their plans. Dr. John studied medicine and was surgeon of Royal Navy and Francis (whose hand in plate support the point of Jean's sword and are arranged to make the letter F) altered his plans and devoted himself to literature, published some of his father's books, then travelled to France and England. He was thirty years in the family of Arundel. Taking advantage of frequent visits to Oxford, he studied the ancient languages of the Cimbric, Goths, Franks, Frisons and other northern nations as did his gr. fr. Both enjoyed a great flow of excellent spirits to their death. Francis was bur. in St. George chapel, but before he died he visited his nephew Dr. Is. Vossius at Windsor where he died leaving "by will" his MSS. and collections to public Library of his favorite Oxford. His honored father's publications were 64 volumes, and the best which on the title page keeps the cypher line of his ancestry is on the Latin version of the Hebrew Bible in my possession in which he was assisted by Emanuel Tremellius his father-in-law on whose tomb is cut by John counted by six pointed Hebrew in cypher of birth of J. P. Fer- scription over Samuel Washing-Shakespeare) remains counts the Fernel, chn. and one for self lines.

GENERATION NO. CLII



Plate 1054 Good Queen Bess who protected Wm. Fernald and named his wife Elizabeth Amand.

F N R .
Coligny ,
came to
Hugue-
tion was
m. 1 Jan-
N I U S
eldest son
M a r i a
1556 d. 25
phine, da.
4th Jan.

b. 14 June 1572 m. S. S. T. birth. Dr. John and wife An- who was born at the Castle of Church of the Holy Ghost, Baden, Germany, where Roman Catholic and Protestant Services were both held for the worship of one God as ought to be over the whole earth of God's children. On the book of Henry is arch of Newport Tower.



Plate 1051. Generations 153 and 154. Capt. Wm Ronald and Henry W Fernald that came to Portsmouth, N. H

ANNIETTA, da. Gasparde de the Admiral of France, who America to found a Colony of nots to escape fanatical persecu- b. 1 Apr. 1550; d. 23 May 1623; 1573 FNA DR. JOHN FUR-FERNEL in Royal Navy, the and heir of F. J. F. and wife Comnenus b. 15 Cal. Id. Mar. Aug. 1575 after 1st m. to Jose- Margerine de Vigne. 1571 by whom one da. Maria.

Yrkolsky: her mother d. at her ietta, had only one son William, Heidelberg and Baptized in "ye



DESIROUS OF FREEDOM TO WORSHIP THE SUPREME BEING IN ACCORDANCE WITH DICTATES OF CONSCIENCE. HONORING GOD AND FEARLESS OF MANKIND; CONVERSANT WITH THE DISCOVERIES of his relatives, Gasparde de Coligny and Captain John Smith, Captain William Fernald went forth to New England 1630 to personally examine the land.

GENERATION NO. CLIII.

FNR ELIZ-
Commander
Elizabeth
d. 1 Oct. 1648;



Plate 105.
Coin 1575 struck commemorating death of Dr. John Fernelius.



Plate 106.
Seal of Thomas Fernald and wife, Temperance Washington.



Plate 107.
Monogram. Seal of Anne of Brittany and Charles VIII.



*Iugens Ferneli tunc et proci filius unctus
Phycius. Oculis Cæsus et alter erat*

Plate 05. Generation 154. Dr. John Furnus Fernel, R. N. Stabbed to the heart by a Jesuit on the vessel's deck at night. Fourth slain—C—8th.



Son of Captain William F
Plate .CS3. Generation 154.

ABETH AMAND da. of Girard Amand and his wife Washington, b. 3 Apr. 1571; m. 16 May 1594, CAPT'N WILLIAM FERNALD, son of Dr. John Furnus=Fernelius=Fernel and wife Anietta (da. Gasparde de Coligny and wife Anietta) b. 10 May 1575; d. 20 or 8 Apr. 1675: Had (1) Renald Fernald: (2) Thomas, b. 13 Aug. 1597: (3) Henry, b. 5 Dec. 1599; poisoned in first hotel built at New Castle or Strawberry Bank: (4) William, b. at Eastwick, 30 Dec. 1600: (5) Robert, b. 20 Mar. 1604: (6) John, b. 9 Apr. 1607: (7) Edward, b. 4 Oct. 1611; m. Mary: (8) Strong Strangue, b. 16 Nov. 1614; m. Aellone and admitted to Church, 1643; a member of the Ancient and Honorable Artillery Company, 1651: (9) Joseph G. was b. at Feursen Forez; Professor of Anatomy in the Royal Gardens; author of a work on the Ear; celebrated;

and died in Paris, unable to recover his ancestors' stolen money.

In search of Captain Sir William Fernald presence here in United States was found an item copied in the Genealogical Register of his presence in Boston. Came over in the "King Philip" bringing Robert Washington and wife, Anna, daughter of Robert Bruce Cotton, son John and eldest child Temperance Washington, to Virginia, 1630. His name was spelled in many ways: Fenner, Furnival, Ferneli. He was knighted by Essex, 8 Oct. 1597: Commander of "The Cadiz Expedition," April 1596 with 1200 veterans, 7000 soldiers, at Downs, England: Commander Sir William Fernald gave to Dr. Renald Fernald the Sword and Bible of Dr. Jean Fernel with other important Relics, among which I have the ancient teapot that was made by the Grand Duke of Tuscany that "Good Queen Bess drank tea from last and named Elizabeth Amand for herself." Coin gift with it of death 1575 of above Dr. John Fernelius is lost to us.



Plate 1052. Generation 151.

WHICH FROM DISCOVERED LOST HEBREW LANGUAGE IN א רבשית GENESIS IS SPELT AMARICA (see plate 9) HE SAILED IN THE BARQUE "WARWICK" FROM DOWNS, OLD ENGLAND WITH HIS WIFE, JOANNA AND SON THOMAS AND

80 emigrants and they arrived 4 July 1630 at Piscataqua, Strawberry Bank, that from his and others Petitioners to the General Court at Boston, was changed to Portsmouth; granted 28 May 1653. He was New Hampshire's first Surgeon; Dept. Lt. in England; Captain of Militia Co.; Grand Juror, 1643; Town Recorder, 1643 to 1656, and wrote, aided by the Genealogist, his brother Henry, that cut his initials in Newport Tower ("H. W. F.") at B. Island their ancestral tree; Trial Justice of the Peace and punished the plaintiff for charging witchcraft; Recorder of Deeds; prominent in all good work and popular among the Indians that he kindly treated, and by them much loved. He accompanied his father on his sea voyages and was a very strong, short, powerful, brave, just, wise man; stricken down after the death of Henry, respected



Plate 1456. Gen. 155. Seal, Fleur-de-lis. Primitive Alphabet, Cypher around edge of Coin.



Plate 1064. Gen. 155.

honored and loved by his in my friends and relatives. He was the ship Chirurgion brought over many family relics, the swords of Dr. Jean and Dr. John F., that was given to him by his Fr. with seals, two Chairs, one at Washington, D. C.

GENERATION CLV. FNL TEMPERANCE WASHINGTON, da. Robert Washington and Anna, da. Sir Robert Bruce Cotton, the antiquarian, b. at Chester, Old England, June 6 or 16, 1622; d. 15 July 1706; m. Th. 16 Dec. 1639, FNA THOMAS FERNALD, s. Dr. Renald Fernald and Joanna, b. Sun. 1 July 1620; d. Sun. 15 July 1639. Bust, Pl. 1064, of Thomas Fernald; on U. S. Coin are the Features of his wife, Temperance (Washington) FERNALD, 1798. Vide, and their signatures at Rockingham Records, Vol. 9, Fol. 178 on a Deed: Had John b. 12 Dec. 1640; d. 1 Sept. 1687; m. Mary, da. Thomas and Margery Spinney, b. 1650; d. 1700; 2, Anne; 3, Thomas, b. 1653. 4, Patience; 5, Mary; 6, Samuel; 7, Joanna; 8, Sarah; 9, Hercules. Sig. Jean F., plate 1065 in language, giving true history.

Plate 1080. Our Free and A. M. loved token. Plate 1081. Gold Egyptian vase from Egypt giving the history of the Deluge of common fr. Noah and family: thus kept true records, God's Command. Plate 1079 is our ancient Egyptian Star Seal of the line and the circle is found on the history of creation by Far Lamar, the wife of Noah, most ancient Map, Pyramid of Egypt, down to the Power of Atty. given by fr. fr. to Father who used the same and others of family. Plate 1069. A recording apparatus of Noah, and Ham.

Sm, (Note fleur de lis.) Japeth and sons and das. Plate 1070 explains itself. Captain John Fernald's, Egyptian hitl monogrammic sword. Plate 1072, itself explanatory. Plate 1073. Governor of Enos that he betrayed to Philip II. king, Macedonin, B. C., 200, which in Thrace, owned by P. Philopater.



Pl. 1111. Lines are Gens Count.



Pl. 1112. Ring of Sam, Washington, nom. le plume, Wm. Shakespere.



Pl. 1113. Side view of same, counts gens. by cyphers and sqrs. the great men of ancestors.



Pl. 1114. Our Turkish relative's Seal.



Plate 1115. Lizzie gave her life for Boston, Mass., United States of America. The Free

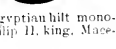

Renald Fernald
Signature. Plate 1063.

Jerne
Signature Jean Fernel.

Plate 1065. Signature Jean Fernel.

Elizabeth B
Signature of Good Queen Bess.

Plate 1067. Signature of Good Queen Bess.

Sm, (Note fleur de lis.) Japeth and sons and das. Plate 1070 explains itself. Captain John Fernald's, Egyptian hitl monogrammic sword. Plate 1072, itself explanatory. Plate 1073. Governor of Enos that he betrayed to Philip II. king, Macedonin, B. C., 200, which in Thrace, owned by P. Philopater.



Plate 1076.



Plate 1080.



Plate 1078.

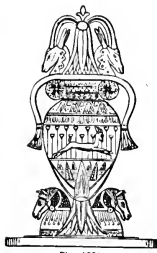

Plate 1081.



Plate 1082.



Plate 1083.



Plate 1094



Plate 1100.



Plate 1084.



Plate 1085.



Plate 1093



A SWORD
DIED IN THE
WIND AND
PERCUTINA
Plate 1070.



Plate 1077



Plate 1087.



Plate 1088.



Plate 1092.



Plate 1090.



Egyptian ring-money.

Plate 1089.



Plate 1069.



SEPTIMIA
POMIA ET FI

Plate 1073



Plate 1101.



Plate 1097.



Plate 1096.



Plate 1076.



Plate 1102.



Plate 1103.



Plate 1110.



Plate 1106



Plate 1093.



Plate 1099.



EXCERPTORUM SWORD FROM FABRIG, WITH GERMAN ENGRAVED ON THE BLADE
Plate 1072.



POMIA ET FI

Plate 1074
Pike Interchange



Plate 1108. Acres—Ahrs



Plate 1095



Plate 1104. On tomb of Samuel Washington, nom de plume
William Shakespeare.



Plate 1109.



Plate 1071.



Plate 1127.

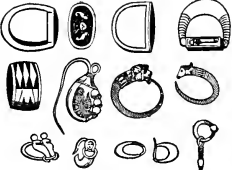

Plate 1105
217



Plate 1116.

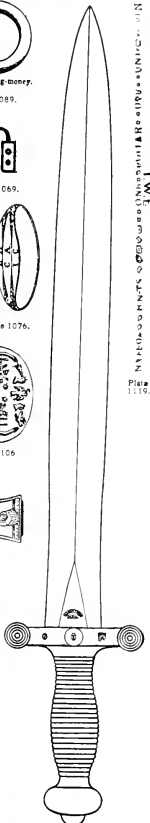

Plate 1098.

T.W.F. ...



N PLATES NOS. 1112, 1113 AND 1104 IS A CLUSTER OF POETRY, LOVE AND HISTORY THAT THIS THE CURTAIN OF MYSTERY WITHDRAWS GIVING BIRTH TO A NEW ERA. IN CENTRE OF SEAL OF 1112 IS OUR most ancient O seal, which is respected by all nations, civilized. Cord like line has at ends the nipple of the nursing bottle and the lines there inscribed by covering parts give the names of Charles VIII, k. of France and wife Anne: (see heart shape cord § 7=C. 8. O.F.E.V. E.L.C. 8 F. E. Hebrew R= and Greek v=N E. L, thus is name Fernel, ³=J. FRANCIS=F as before, R, ditto A= part of W read upside down as ^ Gk. vv=N from W, as M: C from Greek=Γ=C: I=Ξ, and S from the large S. By turning the monogram on the Ring upside down it is M. Initial of Magdalen and sd. L, of Luillier also of Maria & Commenius is spelt from ring and these were the foreparents of Samuel Washington who m. Mara Smith, but another Samuel Washington, nom de plume, Wm. Shakespere, m. Anne (Hathaway) Junius Fernel, da. Francis Junius Fernel and wife Maria Commenus, s. Dr. Jean Fernel, s. Charles VIII and Anne of Britiany. Thus when crime was rampant was kept our Records. Do any skeptics, if they exist, want more? Here it is on the wise monogrammi cinscription over Samuel Washington, nom de plume, Wm. Shakespere, that for many years lay forgotten till a legion of the family foes had gone to judgment, and the usurpers of rights saw blood freely flow and one went to execution, as it was God's will. Sir Thomas More, 1535, beheaded, another burnt Rev. John Rogers, 1555.

Plate 1104 counts by the E=Greek ε, that in the ancient /Egyptian means man and woman: 20 of these are to be found and his relatives of the family of Francis were 18 children plus mother and father =20. Further use of the philological scapel demonstrates one large B, it is the first letter of Hebrew in Genesis of "BRASFT" and comes on the third line: pointing to ancestry who worshiped God under the names of God the Father and God the Holy One, B. C. The first Fr. 2nd word is for Francis his wife's Father and the First G is a Greek C, and Co are the first two letters of Commenus and the o next means son Francis of John, see the big I=J in front of Jesus, which completes Trinity union with mankind: etc., etc. For complete reading of this Monogram, see Edition 2nd. More light was asked. It is given! Now the old Poem!!

TO THE IDOL FER NEL II OF MINE EYES
AND THE DELIGHT ANNE HATH A WAY.



1.

"Would ye be taught, y^e feathered throng?
With love's sweet notes to grace your song.
To pierce the heart with trilling lay,
Listen to mine Anne Hathaway!
She hath a way to sing so clear,
Phœbus might wond'ring stop to hear;
To melt the sad, make blithe the gay,
And nature charm, Anne hath a way.
She hath a way,
Anne Hathaway,
To breath delight Anne Hath a way

2.

When envy's breath and rancorous tooth
Do soft and bite fair worth and truth,
And merit to distress betray,
To soothe the heart, Anne hath a way:
She hath a way to chase despair,
To heal all grief, to cure all care,
Turn fœules night to fairest day:
Thou know'st fond heart, Anne hath a way,
She hath a way,
Anne Hathaway,
To make grief bliss, Anne hath a way.

Commence first stanza, 8, 9, 10th line, read top to bottom and you have U. S. A.: 2nd stanza, and we have reading from bottom to top A. S. W., or America's Samuel Washington: 3rd stanza, 8th line—So S. W.—Samuel Washington, 9th line She, 10th line Anne, 11th line Anne, hath a way; 4th, stanza; 3rd line F and our seal o, 3rd letter r, 4th line An, 5th line c and seal o, and thus Fr Anc 6th line 4th word i, 5th word s, thus Francis her father. 1 and 2 stanzas S. W.—Samuel Washington.

3.

"Talk not of gems, the Orient list,
The diamond, topaz, amethyst,
The emerald mild, the ruby gay:
Talk of my gem, Anne Hathaway!
She hath a way with her bright eye,
Their various lustre to defy,
The jewel she and the foil thee,
So sweet to look Anne hath a way.
She hath a way,
Anne hath a way,
To shame bright gems, Anne hath a way.

4.

But were it to my fancy given
To taste her charms, I'd call them Heaven,
For though a mortal made of clay,
Angels must love Anne Hathaway.
She hath a way so to Control
To rapture the Imprisoned Soul,
And sweeten Heaven on earth displas,
That to be in Heaven Anne hath a way!
She hath a way,
Anne Hathaway,
To be Heaven's self Anne hath a way."

Courteous reader I never read this till today June 12th, 1908, and copy it as it is part and parcel of our God given genealogy. It is printed in History and Poetry of Finger-Rings by Redfield, N. Y., 1855: Copy Righted by Charles Edwards, 1854. Dedicated to Anthony Barclay, Esq. H. B. M.'s Consul at the Port, N. Y.





FONIA, PL. 1074, IS THE PIKE NAME AND SYMBOL SHOWING AN INTER-MARRIAGE WITH THE FURNIUS FAMILY. PL. 1075. CELTIC RING MONEY MADE IN FORM OF G OR C, INITIALS OF GOD AND CHRIST PL. 1076; dated one century before Christ of God, Zana & Ham line, and that he was one with Trinity, God. Pl. 1077 and 1109 is a ring, in Bronze, of Rome, has on it forty-seven generations from Marcus Agrippa to Fnr Baru & Fna Tachnatis of Ægypt that he the son, Græcianus, had been to the land of Omo, Lake Pyramid, serpent mound: Pl. 1078: Seal of Thomas Rogers of Suessa: initials give Cicero, Charles, Philip, Samuel, John, Peter and Daniel Rogers, and clasped hands understood by experts: found in Sessa, red stone centre and Thos. name in Latin around it. From description other descriptions on it are, Pike conquered: Pike reigns: Pike's Commands. A coin was found of Pike. "The veritable signet of Cicero is the coral in centre of ring, Pl. 1079. Our ancient and modern family seal; see p. 214 Pl. 1082 one of Pike family seal rings: Pl. 1083 Fnr. Vashatana seal. Pl. 1084 and 1087 called the most valuable Ring and seal in the world in Dr. Abbott's collection found at Ghizeh in a tomb: they call it the Suphis or Sufis ring, it is invaluable: reading from right to left we have at top O which is 1st name of God=Fa 2nd. it is first letter of primitive alphabet F, 3rd symbol of sun, seal, birth, son, etc. The second double cross symbol is compound, the upright line over oval is I, J, H, F, L and egg shaped oval denotes creation of woman, and 3rd symbol with the transverse lines of cross and jug shape man, n, m, cut off the two lines leaving the projection and we have H O heavens God line, leave the projection on H both sides and we have "God's line created woman and man, it spells, Ava=AFA as in catouche, Adm and line to Nh, Hm, Sm, Jfth=Japeth and has the picture of Pyramid Lake Oregon, and U. S. A. and pictures of the mounds, even the serpent is delineated of Serpent Mound Ohio, and the wine bottle Cain drank of before killing his brother Abl, and Oratota, OMO, etc. It gives part of inscription on Dighton Rock (a small vol. may be written of) these hieroglyphics that claim it the "Ring and Seal of Queen AFA" Eve. Pl. 1088 represents the laws of God the father and God the holy One given to Ava and Adm, the sacred Bird and Altar of JAO or Jehovah: 1089 religious symbol of Christ & God made into Ægyptian money: Pl. 1090 & 1091 Ring and signature of Thecla, and her portrait with C. Furnius signatures—gold, at British Museum are both: this Thecla da. Mary, symbol on right hand and seal in left hand. Pl. 1092 hath Pike crest of coat of arms: when the tomb of Childerick was opened his ring was found, crystal orb, more than 300 little gold ornaments resembling bees of purest gold, wings inlaid with red stone-like cornelian. Napoleon adopted the fleurons or bees instead of fleur-de-lis. Pls. 1093 & 4 two gold etruscan rings at British Museum, latter has a white stone on swivel. Pls. 1095-6-7, "brass heavy gilt ring of Pope Pius 2nd. arms, topaz lost surface polish." Part copied from the Ægyptians & Turkish Crescent. He was proclaimed 26 Aug. 1458, 218 Pope, son of an outlaw; when a child he abandoned himself to the vilest practices." France, Scotland, Denmark, Poland and Hungary, with the cities of Venice and Florence disapproved of his election: Germany, dukes of Milan and Modena, Ferdinand of Sicily approved. He followed example of Borgias to replenish his treasure. Sold investiture of the King of Naples to an illegitimate son of King Alphonso, to prejudice of Rene and son John, for 600,000 gold crowns. He convened a general council at Mantau, 1st June, 1469, invited all kings, especially Charles VII, he called defender of Christian religion. After public session, the Embassadors of Charles VII demanded private audience,—granted. Baliff of Rouen reminded his holiness that the Kings of France off services rendered his predecessors; bitterly complained that the brother of St. Lewis had received Naples, that he was not permitted to sell what Rome had given and threatened pious with King's vengeance. This cost Charles VII his after trouble and afflictions continued. Pl. 1098 our Roman C. Furni historic sword: Pls. 1099, 1100-1, 2, 3, Irish diamond rings; Furni Ring Chinese Coins: Pls. 1105-6, 7, 8, 9, 10, 11—Ear drops and rings: see Edition second, very interesting.



“WHEN SPAKE FORTH THE WORDS OF SOBERNESS AND TRUTH.”
WHEN AGRIPPA SAID UNTO PAUL, ALMOST THOU PERSUADEST ME
TO BE A CHRISTIAN.”

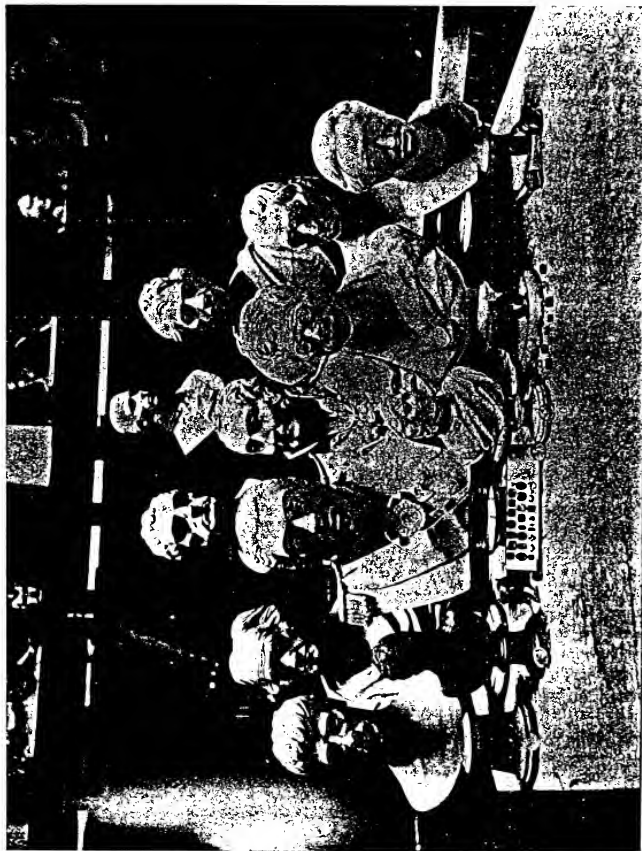

COL. TOBIAS FERNALD, s. CAPT'N JOHN, m. Elizabeth Rogers. MR. JOHN FERNALD. JOHN FERNALD.
Some Ancestral and Fernald Busts with others kept by the excellent Boston Antiquarium Society at Beacon Street, near State House, Boston, Mass.

HERE UNDER THE LIGHTS OF MASSACHUSETTS STATE HOUSE AND BEACON STREET HISTORICAL SOCIETY MORE RESPLENDENT SHINETH FORTH THE WHITE BUSTS OF THREE ANCESTORS OF THE LONG line as was prophecy line of the ancient Fernald Family, viz: Mr. John Fernald, m. Mary Spinney; Mr. John Fernald, m. Sarah Hincks and Col. Tobias Fernald in front row from seal and three relics, one is Dr. Jean Fernel and Ambrose Pare at base of first: eleven Fernald seals at base of the second, with relic Portrait of Joinville back of them; 26 seals and the historic corner-pieces of panel at base of Col. Tobias Fernald, whose epaulet has been broken from his left shoulder for daring to be true to God, Country, State and Family.

Whose blood from the ancient Fabi 300 to 1908, it has freely been shed on every battlefield for the holy cause of right and liberty.

GENERATION CLVI. FNR MARY SPINNEY, da. Thomas and Margery Spinney, b. 19 Feb. 1650: d. 7 Oct. 1700: married FNA JOHN FERNALD, son of Thomas and Temperance Fernald, 9th. Feb. 1650, b. 12 Dec. 1640 and died Sept. 1st. 1687: Had: John, b. 4th. March 1673: m Sarah, da. Judge John Hincks and wife Elizabeth Freyer, da. Judge Nathaniel and Christian Freyer of Portsmouth, N. H. II-James, b. 1676: m. Mary da. Judge John and Elizabeth Hincks: III-Thomas b. 1678; m. Mary Thompson: IV-Lydia, b. 1680: m. Moses Dennet 11 Feb. 1720: V-Margery, b. 1684: m. John Marshall: VI-Amos, b. 16 Apr. 1686: m. Mary Woodman.

GENERATION CLVII. FNR SARAH HINCKS, da. Judge John and Elizabeth, b. 26 July 1679: d. m. 7 Aug. 1696: FNA JOHN FERNALD, b. 4 March 1673: d.

1754 from an assault in battle with the Indians he was made blind in saving the life of his beloved wife Sarah: they Had: I, John, b. 15 March 1698: m. Elizabeth, da. Rev. John and Martha Rogers of Ipswich: II, Mary, 2 Mar., 1700: m. Thomas Rogers: III, Samuel, b. 1 June 1702: m. Mary Johnson: IV, James b. 4 Oct. 1704; m. Hannah Rogers: V, Joseph, a twin brother of James, m. Anna More pub. 1742: Sarah, b. 13 April 1709: m. Rogers: VII, Abigail, b. 10 Sept. 1710: m Joshua Staples: VIII. Benjamin, b. 1 Apr. 1717: m. Susan Chadbourn, 1743-4: IX, Lydia, b. 26 March 1719: m. James Johnson.

GENERATION CLVIII FNR ELIZABETH ROGERS, da. Rev. John and Martha Rogers, b. 10 Feb. 1705: d. m. FNA CAPTAIN JOHN FURNEL, at Kittery,

by Rev. John Rogers, 16 Jan. 1723-4: b. 15 March 1698: copied from his iron tomb tablet, Ob. 21 Feb. 1788-9, at Boston, Mass. Had MR. JOHN FERNALD, b. 23 Nov. 1742: m. Mary, da. Thomas John Savage and Mary II, Mercy: III, (Poly=) Mary, m. Wm. Cotton, 2nd.: IV, da.m. John Wentworth Fernald, a cousin, V, da. m. Mr. Dennet, VI Col. Tobias

Fernald, Sr., b. 1742 at 6 a m., who had a cousin, Col. Tobias Fernald both in American Revolution and both John Fernald and the father of Mary Savage signed the Association Test.

THE ASSOCIATION TEST, 1776.

"WE, the subscribers, do hereby solemnly engage, and promise that we will. to the utmost of our power, at the Risque of our lives and fortunes, with Arms oppose the Hostile Proceedings of the British Fleets, and Armies, against the United American Colonies." 497 signed and thirty one were either absent or refused to sign 6 Cottons, 5 Dennets, 5 Fernalds, 8 Langdons, 4 Marshalls, Luke Foster, 10 Hams, 11 Harts, 8 Langdons, 7 Moses, 2 Savages, 3 Pikes, 13 Sherburnes, 7 Walkers, 3 Waters et al. Refused: Parker, Rindge, Freeze, Weeks, Hastings, Atkinson, Sheafe, Little, Torrey, Hart, Hale, Palmer, Peirce, Noble, Eliot, Moore, Armet, Butler, Russell, Gardner, Jafrey, Wentworth, 2 Warners, Sherburne, Waters, Jr., Campbell, Tucker, Pickett. Rogers and Pease were absent.



FPHESIANS, V. 16. "REDEEMING THE TIME, BECAUSE THE DAYS ARE EVIL. 10, PROVING WHAT IS ACCEPTABLE UNTO THE LORD"



Plate 1120. Captain John Furnald, Convey of American Troops, sailing into Boston Harbor after the siege of Louisburg.

GENERATION CLIX
FNR MARY

Thos., John Savage, 7 Mar. 1804; m. 16 FURNALD; both New Hampshire, of fever at Portsmouth, 1792, and his death on his grave stone Portsmouth, N. H., Fernald that had papers stolen from is recorded in Brew-about Portsmouth Old South Church cord of his death in at that time. Both Secret Service of the is called "Uncle Washington, a nd buried in said tomb Mr. Graves of said of Captain Graves, that fought in the dying left to me the Graves & Davis bur. of said S. S., U. S. A. are on Plate 1133. age) Fernald had Fernald, b. 24 Oct. married: II. WIL- b. 10 Mar. 1775; m.



Plate 1121. Mary Savage, w. John Fernald: Colonel Tobias, son Captain John Fernald; Captain Abraham Fernald, the father, buried on Copp's Hill, at Captain Abraham Fernald, buried in New York, and wife on Copp's Hill, Boston, Mass.

S AVAGE, da. b. 17 June 1752; d. Nov. 1771, JOHN of Portsmouth, b. 23 Nov. 1742; d. mouth, 23 Nov. cease was chiseled in North Cemetery, while another John U. S. Government him at New York ster's R a m b l e s and is buried in the Tomb, with a re-an old paper printed Johns were in the United States, that Sam" for Samuel Samuel Fernald, at Old Granary S. S., the ancestor of New Hampshire, Civil War, & when gift of his sword. in O. S. C. Tomb Their signatures John and Mary Sav- John Wentworth 1772; s. p. d. UN- LIAM FIRNALD ELIZABETH

(Betsy) JOHNSON, da. Phineas, son of Col. Samuel; d. 20 April 1852; His wife b. 21 June 1778; m. 1 Feb. 1797; d. Wolfboro Centre, 30 Sept. 1897: III. James, b. 24 June 1779; m. Betsey Brackett; IV. Polly, b. 5 Sept. 1782; m. William Cotton: Moved to Maine.



F U.S.A.,
F I N
A P R I L
T A I N
d. July

at Wolfboro Centre, Mary and Betsey, 1787; Mary, m.: Bet-Nute: VIII, Sarah, Samuel Cotton, d. Joseph P. Cotton; Samuel C. Cotton: Cotton; Sarah M. 1140, Cotton & Fer-of arms; Col. Wil-Josiah of Plymouth, 15 Aug. 1756; Col. Clark; da. Mary Cot-whose da. Mary Cot-than Poor Fernald.

IX, Deborah b. at break of day, 27 ard Younge of Ro-Samuel; John; and son Smith. These

by agreement at Portsmouth, New Hampshire, and agreed to spell their names Fernald (the oldest line) Fernald, and Fernald, thus keeping trace of their descendants from most remote ancestors and this Plate 1122 was one of those made for the Great Seal of "Uncle Sam" United States of America; bearing the profiles of Captain John Fernald and his wife Elizabeth Rogers, da. Rev. John and Martha of Ipswich, "the Cradle of American Liberty," whose Descendants Remember my Ancestors, Rev. John Rogers, Burned to Death at the Stake, 4 Feb. 1555, After Beheading my Fore-father, Sir Thomas More, 5 July 1535, head placed on London Bridge, buried at St. Dunstan's in arms of da. Margaret, said to have m. Mr. Roper. Who among you condemn fanatics? Let him Act well.

GENERATION CLX. FNR ELIZABETH (Betsy) JOHNSON, da. Phineas & wife Hannah Poor, son of Col. Samuel, s. Captain Timothy, s. Timothy, s. John of Ipswich, s. a Lieutenant, brought by Captain William Fernald to Charlestown, Massachusetts Bay, 1630, in "King Phillip" from Hern Hill, Kent Co., Old England. Penelope, da. Timothy and Rebecca, b. 25 March 1679, kil. by Indians, March 4, 1698. Although Col. Samuel Johnson is claimed m. April 22, 1742 correctly, another Samuel Johnson, m. Elizabeth Fernald, May 19, 1748. Attested Records of Kittery, Maine, C. M. Prince, Town Clerk, Copy of Aug. 27, 1894.



PLATE 1122
This Great Cut Seal was not adopted for U. S. Coat of Arms. Captain John Fernald and wife Elizabeth Rogers.

V, ABIGAIL COF-FURNALD, b. 2 1785: m. CAP-JAMES NUTE, 18, 1856, both bur. N. H., VI & VII, (Geminæ), b. 2 Aug-sey, m. Richard d. h. 11 June 1790; m. 15 June 1830; had Wesley Cotton: Brackett Fernald Cotton; Plate n a l d coat liam Cotton, son of b. 8 Jan. 1680 and d. Wm., m. Mary ton, m. Robert Pike, ton Pike, m. Jona-

Sherburn Fernald, Feb. 1791, m. Rich- chester, N. H., had da. m. Wm. Addi- three brothers met

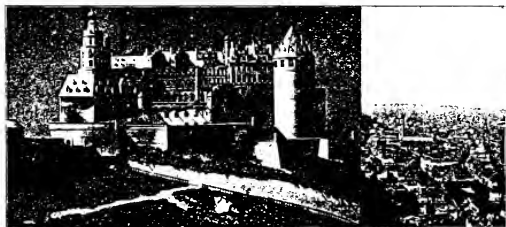
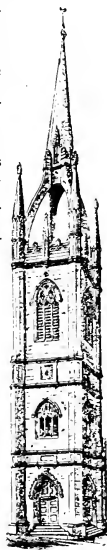

PLATE 1123. GEN. 153. Appreciating protection of Mrs. Annetta Fernald, Honoring Germany. a. The Castle of Heidelberg, Baden, Germany, restored. Birthplace of Captain William Fernald, christened, at Church of Holy Ghost where Protestant and Roman Catholic, and without contention, services were held for worship of God.



ST. GEORGE'S.
PLATE 1141.

MANKIND, OBEDIENT TO MOST HIGH COMMANDS, TRACE THEIR GENEALOGIES TO; "HONOR THY FATHER AND THY MOTHER THAT THY DAYS MAY BE LONG UPON THE LAND WHICH THE LORD THY GOD GIVETH THEE." THE FERNALD FAMILY COUNT THEIRS BY THE FIRST AND THE

last, the sun and the moon with the stars of heaven, and earth and waters, ridges of stones and slate, marble mounds of Omo, world, of sea, pyramids obelisks, statues, bols, swords, tablets, balls, globes, leaves, ægle and them on plate our generations Fernald on rudder again and Dr. his VII children, and you have the



Plate 1455.

Temperance (Washington) Fernald into letter of primitive M, the eye F. A. M., count base of wing 8 count middle of 2nd row, wing, Fernald: count tip of wing and Elizabeth (Rogers) Fernald: count children of William and Elizabeth count outer surface of body side of



Plate 1044.

dren of Fernald Cotton eleven. I And per and about fifty sold from a museum and my search over the world left by the wise Fernald their posterity in godly It was photographed and given that traces our true yond Dr. Jean Fernald given the same can be all. The key was found of a secret letter of my father in Secret Service at Portsmouth, N. H. lected grave. Plate 1128.



Plate 1143. Monogrammic history.



Plate 1124. Made about 1855.



Plate 1125 The son, John Washington, of Robert and his wife, Anna, daughter of Sir Robert Bruce Cotton, of Virginia, 1630

waves of waters, surf busts, letters, sym-circles, squares, trees, its feathers, count 1124 and you count IX—Capt. William of ægle, and count it Renald Fernald and count it third time children of Thomas and and the feet are arranged is an F, the bird an A= the family of John & Sarah: family of John and Sarah family of Captain John and of base of rudder and twelve (Betsy Johnson) Fernald: wing and you have the chil-

Jonathan Poor and wife Mary (Pike) Fernald the last. the saucer cop-metal was made ty years ago, discovered in for evidence family to aid work for all. true plate above genealogy be that with key easily read by by me in copy great grand-of United States See his neg-

Plate 1142— The relic sword of Dr. John Fernald, killed by Jesuit on deck. 1575, it counts his genealogy back to Charles VIII and Anne of Britany.

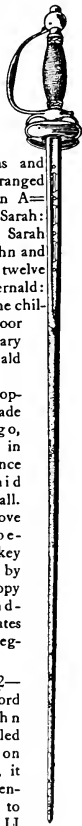

Plate 1142.

NOW ON PLATE 223 OF ANCIENT PIKE FAMILY THAT WAS TAKEN OVER FOR A CHRISTIAN SYMBOL, IS TO BE SEEN NAMES OF TRINITY. PRIMITIVE ALPHABET; LAND OF OMA; RELIGIOUS MOUND OF ANTEDELUVIANS SURMOUNTED by Lamb typical of peace and Christ; four rivers flowing from Garden of Eden; arches representing Newport, Rhode Island, Tower, etc.

GENERATION CLIX.

FNR (Betsy) ELIZA-
June 1778; m. FNA WIL-
1797; b. 10 Mar. 1775: He
mouth, and Wife d. 30 Sept.
both buried at Portsmouth,
children:

1. Jonathan Poor Fernald,
2. Mary Savage Fernald,
3. Samuel Fernald,
4. Elizabeth Fernald,
5. Hannah Fernald,
6. Deborah Fernald,
7. William Fernald,
8. Pamela Fernald,
9. Maria Fernald,
10. Henry Hincks Fernald,
11. John Fernald,
12. Margaret A. Fernald,

Mr. William Fernald who and afterward moved to Ports-
merchant and a very pious per-
his family up to be sincere care-
was taught the family history,
cate the same to his descendants,
of John Fernald, in Secret Ser-
brought over 6000 troops from
dence, R. I., that remained and
have read the letter many times
phics that in after years were
tian characteristics. From the
care of the Feuillants to Lafay-
branch of the Feuillants of the
1790. In 1630 the order in
in Italy. In the French Revo-
fayette and Sieyes was continued
Jacobines, that met in a convent
broken up by a mob in 1791.
papers that were stolen from
a letter mentioning the Feul-
in Secret Service, which I have

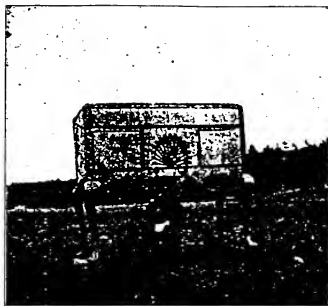

Plate 112: John Fernald's Desk, given to him by Governor John Wentworth now it is owned by Brackett Fernald Cotton, of Wolfboro, N. H. (Photo with dog Topsey under it by C. F.)



Plate 1127.

Plate 1127—Governor John Wentworth, the last English Governor of New Hampshire before the American Revolution, whose private secretary, John Fernald, rowed to take ship for England, never to return to N. H.

BETH JOHNSON, b. 21
LIAM FERNALD, Feb. 1,
d. 20 Apr. 1852, at Ports-
1867, at Wolfborough Centre,
New Hampshire: Had twelve

- b. 1 December 1797;
d. 23 April 1893.
- b. 11 April 1800; d.
- b. 22 August 1802; d.
- b. 19 September 1804; d.
- b. 27 January 1807; d.
- b. 20 January 1809;
d. 30 July 1894
- b. 20 March 1811;
d. 19 April 1862.
- b. 3 July 1813; d.
- b. 25 February 1816; d.
- b. 16 January 1818; d.
- b. 3 April 1820; d.
- b. 19 January 1822; d.

located at Brookfield,, N. H.,
mouth, N. H., was a lumber
son that carefully brought all
ful Christians. His oldest son
with instructions to communi-
giving him the aforesaid letter
vice of United States, which
France in July 1780 to Provi-
fought for American liberty. I
and it had numerous hierogly-
found to be in cypher of Ægyp-
writing thereon it was sent in
ette and Sieyes, who in this
order of Cistercians lasted to
France was separated from those
lution the club founded by La-
to a Co. in 1789 opposed to the
of the abolished order. It was
The United States Government
John Fernald in New York had
liants addressed to my ancestor
read, mentioned Jean Fernel.

J GENERATION CLXI.

FNR MARY COTTON PIKE, b. 12 Dec. 1800; d. 14 Feb. 1887; m. 13 Sept. 1821-

JONATHAN
1 Dec. 1797;
eleven chil-
Firnald, b. at Brkfld. or
1822; m. Oran Dixon;
Dixon, b. 24 Feb. 1850;
Post Master and Post
Center, N. H.; Wil-
8 Sept. 1856; d. 26 June
Parsons, da. George and
Had George O. and
d. y. 11. Mary Elizabeth
d. 4 Sept. 1895; m.
brother of Oran: Had
Frederick Page Dixon;
ward E. D. m. no chn.
chn. Joseph L. D. d.,
Daniel Coleman, of
d. and Mrs. Mary Eli-
Sept. 1895, at Wolfboro.
d. y. IV. Hannah Fir-
d. 22 July 1890; m.
their children were Ed-
garet A. Haines, d. y.
d. 1893. V. Nancy H.
m. William T. Dorr;
was in Heavy Artillery,
Ella, m. Ellis Lindskog;
m. Everett Avery; 2
Mrs. Jennie Gilman,
West), & s. d. y. VI,
1834; d. 24 Oct. 1838;
nal, b. 30 Aug. 1837;



Plate 1128. Grave of Mr. John Firnald who is honored by his beloved country-
men and friends with relatives, forgetting to add the building of a suitable
monument in commemoration of his great and honest deeds.
He was Private Secretary of Gov. John Westworth.

POOR FIRNALD, b.
J. 21 Apr. 1893; Had
dren: (1) Maria Renald
Wilbr., N. H., 16 Dec.
Had Charles Oran
m. Lizzie Avery;
Mistress of Wolfboro
liam Parker Dixon, b.
1903; m. Harriet E.
Mercy, b. 28 Aug. 1855;
Ray W.; Mary Abby
Firnald, b. 12 Dec. 1824;
Joseph Lord Dixon,
Edward Everett Dixon;
and George, d. y. Ed-
Frederick P. D., m., 2
and widow m. 2nd Dr.
Wolfboro, N. H., who
zabeth Coleman, d. 4
III. Hannah, b. 1826.
nald, b. 29 Nov. 1829;
Joshua B. Haines:
win Herbert, and Mar-
Mr. J. B. Haines,
Firnald, b. 3 May 1835;
d. 19 Jan. 1868; He
Civil War: Had Mary
3 chn. 2, Inez Estella,
chn. W. T. D. m. 2d.
had Lulu, s. p. (d. in
Brackett, b. 24 Dec.
VII. Joan More Fir-
m. Samuel H. Buzzell,



Plate 1129. The restored Governor John Wentworth Mansion and photograph of Mr. John Firnald's house, owned at time photo-
graphed by Thomas Whiton, ex-representative of Wolfboro Centre, near Lake Wentworth, New Hampshire. A glimpse
of the beautiful lake may be seen beyond mansion that Mr. Jonathan P. Firnald jumped from top to ell,
25 feet, and from there to ground, total 70 feet, when it was burning.

of Farmington, N. H. VIII. James W. Firnald, b. 24 July 1839; 3
m. Sarah Higgins of Cape Cod, Mass.; had Lyn H. Firnald;
Paul Firnald, m. Emma Rueckheim, 2 chn.: Lyn Marie; William
Paul: Ray Firnald, m. Ex-Governor's da. 1 ch. s. James W., IX,
Sophronia Chase Firnald, b. 10 Oct. 1841, d. 28 July 1896, poisoned
at Alton Bay, N. H., d. at 1483 Washington St., Boston, Mass.,
U. S. A. s. p. un. X, Jonathan B. Firnald, b. 11 Mar. 1844;
d. East Boston, 23 June, 1867, s. p. un. XI, Charles Augustus
Firnald, b. 5 Dec. 1847 at Wolfboro Centre, m. Eliza A., da. of
Mr. John Acres and wife E. A. Bellamy; had one da. Fronia Jose-
phine Firnald, b. 15 Jun. 1878, d. 11 Dec. 1886. Loved wife d. Oct. 23, 1880. Age, 37 y. 6m. 3 d.

JOHN FIRNALD

S. S. Plate 1133. Cipher signatures of Johna Fernalds
Mr. Davis and Mr. Graves, buried in Old
South Church Tomb, Boston, Mass.
1st John Firnal bur. N. Cemetery, Portsmouth,
N. H.



LIKE ANCESTRY WAS FOUND IN TWO LINES THAT WITH CHARITY FOR MISTAKEN RECORDS WOULD CUT OFF THE BLOOD OF WASHINGTON IN THE LINE, BEING A DIRECT BLOW AT THE STRENGTH OF STATE AND UNITED STATES IF THE ERROR SURVIVES AS FIRST FOUND BETIAL SEARCH FOR ON.

The second found line, true:—

- 1, ROBERT, b. 13 July 971-1031, m. CONSTANTINA.
- 2, ROBERT, brother Henry.
- 3, RICHARD.
- 4, HAMON.
- 5, GILBERT; d. 1261 had Gilbert, Hugh, Hamon, Robert, Thomas and William.
- 6, ROBERT, 1321.
- 7, ALEXANDER, 1329, m.; had Nicholas, John.
- 8, NICHOLAS, 1332, m. BEATRICE; had Joanna, John.
- 9, JOHN.
- 10, REV. G. PYKE, Seat, Baythorn Park.
- 11, THOMAS, 1410, sheriff, London. Have Coat of Arms.
- 12, 1462, London, Eng., baron.
- 13, JOHN, m. gr. da. Sir Thomas More, the Martyr.

- 14, REV. WILLIAM, 1591, d. a martyr. by Roman Catholics, m. da. Wm. Washington (W).
- 15, ATTY. JOHN, 1635 came to Charlestown, America, went to Ipswich; m. SARAH WASHINGTON. Samuel Moore mentioned in his will.

16, MAJOR ROBERT 1690 Commander-in-Chief, vide archives State House, Boston, Mass.

17, REV. JOHN 1653, of Dover, N. H. Educated at Harvard College.

18, MARINE R JOHN 1693, d., will dated Roxbury, grave in Dorchester, vide instructive gravestone Upham's Corner.

19, MIDSHIPMAN JOHN executor of Father's Will, vide Records, Boston.

20, CAPTAIN JOHN 1755, gallant soldier of New Jersey, at Kilburn Garrison with his son, Kilburn and son aided by women de-

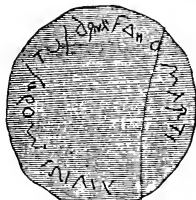

Plate 1130. Gens. 93 and 94.



Plate 1130. A Cup found in England at bottom of old well owned by Gen. 93, 61, B. C., d. Fano=Farna, m. son M. A. L. F., Lucif. fr., d. 12 B. C.



Plate 1132. Rev. John Rogers, burned 4 Feb. 1555.

feated 200 Indians: vide N. H. and Uncle Henry Pikes' histories.

21, MAJOR ZEBULON PIKE, 1751, b. Simeon, k. at (not Bunker) Breeds Hill, Charlestown, Col. Noyes a descendant (See line chn. genealogy.)

22, ROBERT, m. MARY, da. Col. Wm. Cotton in Fr. and Indian Wars. Had 10 chn., m. 2 Joanna E. Moore or More: (Jacob his bro.) a son, had Harrison Pike. Zebulon fr. Robert and of Brigadier General Zebulon

Montgomery Pike, after whom was named Pikes' Peak, was promoted to General, vide 'Archives, State House, New Jersey.

23, MARY COTTON PIKE m. JONATHAN POOR FERNALD had 11 chn. His gr. fr. John Fernald, bro. John W. Fernald, who was named by Gov. John Wentworth.

24, JAS. W. FERNALD m. SARAH HIGGINS of Cape Cod. Had Lyn, Paul, Ray, Howard, d. y.

25, PAUL FERNALD m. EMMA da. F. W. Ruckebheim: had Lyn Marie, Wm. Paul Fernald.

First line, viz:

1, JOHN m. SARAH.

2, ROBERT m. SARAH SAUNDEHS and MARTHA GOLDWYER.

3, MOSES m. SUSANNA WORCESTER.

4, JOSEPH, m. SUSAN KINGSBURY.

5, ROBERT, m. SARAH QUMBY.

6, ROBERT m. MARY COTTON.

I believe is not correct from later records discovered.

This second epistle, beloved, I now write unto you; in both which I stir up your pure minds by way of remembrance: That vs may be mindful of the words which were spoken before by the holy prophets, and of the commandment of us the apostles of the Lord and Saviour:



ON THE 16TH OF DECEMBER, 1773, TOWN MEETING ADJOURNED AFTER

mob. A meet-CommonStreet, patriots, who themselves as dians, boarded ships, armed, hours broke of tea, valued sterling discontents into No other prop-troyed except low-tail slashed Johnson with chette, and the scattered over

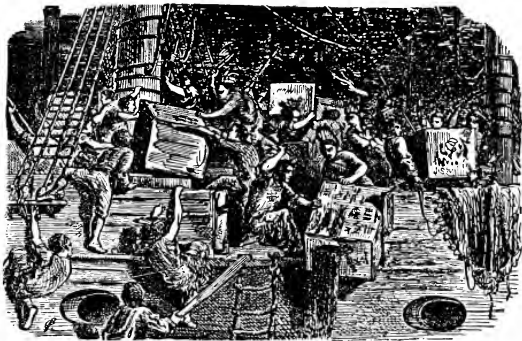

PLATE 1134.

hearing an account of "Tax on Tea," dissolved itself amid cries of a ing was held on Boston, by the there disguised Mohawk In-the three tea-and in about two open 342 chests at 18000 pounds charged their the briny sea. erty was des-the coat swal-open by Phineas his sharp ma-tea contents the Wharf.

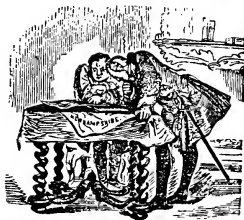

PLATE 1135.

I have relics of house.

Pl. 1134. Phineas Johnson with Machette in hand throwing Tea overboard in Boston Harbor: his da. Elizabeth ("Betsy Farnel") m. Wm. "Firnald = Fernald" Captain Timothy Jr. d. at Louisberg in the King's Services, 1746.

Plate 1135. Ferdinando Georges and Captain John Tufton Mason, search the Map-will of Dr. Renald Fernald, d. 1656.

Plate 1135A. Autograph of Ancestor de Colligny, Gt. Gr. Fr. Dr. Renald Fernald. The letter 2nd Edition purposed of 7000 pages, or more.

Plate 1137. AM(ER)ICUS Vesp(UT)US. Monogrammic illustration.

Plate 1136. Edition II for another full translation, very valuable.

Plate 1138. Presentation of C. Furni sword to a descendant Northman, Thorfin Karl Se Fne. Vide American History of the visit of Northmen to America.

Americus Vespucci was spoken of as a cousin of Dr. Jean Fernel, and his face shows the relationship of AMERICUS VESPUCCI—Fe S Puc Cl. Counts line to Mary and Joseph, Cyrus the Great.

PL 1137A. AM(ER)ICUS Vesp(UT)US Monogram.



PLATE 1135A.

אם תציון בוקי.
אַ צחק כוהונע
על שנת שופ
אל שנת השב
שנים לגלותנו

ואת ציון בוקי
כחקהונו
על שנת שופ
אל שנת השב
שנים לגלותנו

(On a gravestone at Simpheropol, Crimea.)

This is the grave of Buki, son of Issac, the priest; may his rest be in Paradise! [Died] at the time of the deliverance of Israel, in the year 702 of our captivity" (i. e. a. d. 6).

Cum grano salis. PLATE 1136.



PLATE 1138.

THE BIRTH OF AMERICUS VESPUTIUS AT FLORENCE, 9 MARCH, 1451: D. AT ISLAND OF TERCERA, 1514. TH³ REMAINS OF HIS SHIP, VICTORY, WERE PRESERVED BY THE KING OF PORTUGAL IN THE CHAPEL OF LISBON.

Ancestor Gaspard France to, (by wish of Protestants in escaping tical Roman Catholics decided to attempt the America. He solicited sion for this purpose from command of the expedition sailed with the squadron rived in May, he explor-built a Fort and called it VIII, k. Chas. (IX) approx-26 persons were left with that the civil bigots, war ing till return of peace donniere an able wise erected a new Fort and was said to please Charles usual privations of settlers. Sir John Hawkins arriv-offered them one of his about to embark, Ribault ments and supplies of ta of success before them. right to the country and under Pedro Melendez, French and Protestants their enemies! Nearly shipwrecked. The rest massacred except a few Roman Catholics. Those who escaped shipwreck, promised safety by surrendering, were foully slain and bodies hung on gibbets with the inscription:—"Not as French but as Protestants."

BLESSED ARE THE MARTYRS



PLATE 1139. Admiral Gasparde de Coligny: d. 1572.

de Coligny, Admiral of (his wife,) aid the pure from the bigoted Fan-protected assassins, was formation of a Colony in and obtained a Commis-Charles IX. He gave tion to John Ribault, who Feb. 1562. Having ar-ed the coast of Florida, Carolina after Charles prated honor of its name promises of further aid in France prevented send-1564, when he sent Lau-Commander. Th e y called it Carolina, which, IX. They suffered the When in great distress, ed with provisions and vessels to return. When arrived with reinforce-very kind. With a vis-Spain claimed a prior fitted out an expedition who were foes of the that upon the arrival of all embarked and were



Plate 1146. Francis, Gaspard, and Odet de Coligny. THE MARTYRS.

As the government did not take any measures to punish them as is to-day adopted by other nations, brave Dominic de Gourgues, a French Officer, fitted out 3 ships and 150 men at his own cost, 1568, an instrument appointed of God, surprised the Forts, captured many prisoners &



Plate 1145. Pope Alexander III, compels Frederic L' Emperor of Germany, to kiss his great toe. Ava's Roll of God is delineated on the tapestry curtains. SHAME!

hung them upon the same trees with the inscription over their heads:—"I do not this as unto Spaniards, but as unto Traitors, Robbers and Murderers". THUS as GOD saith:—"He that sheddeth Men's Blood by Men, SHALL HIS BLOOD BE SHED". All men except the Son of God hath committed evil. GREAT is to be the just punishment of the hypocrite, who knoweth well but doeth not righteously.

FIVE IS A CORRUPTION OF
 GOD CREATED WOMAN
 MID LAKE LAND OF

AVA, WHICH MEANS LITERALLY;
 IN HIS LIKENESS IN THE PYRA-
 ANONA. PURE HOLY.



Plate 1147 - Admiral Paul Jones b Selkirk,
 Scotland, d Paris, 1792



Plate 1146. Paul Jones



Plate 1149. Medal from Society of Colonial
 Wars, honoring Captain John Fernald, and
 given writer. Made from a cannon raised
 from bottom of the sea, at Lousberg

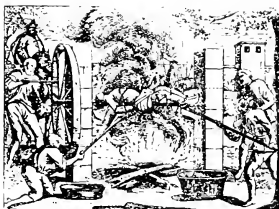

Drawn by M. Richardson from an old print.

Plate 1152. Roasting a Protestant Martyr of a Hebrew
 Par: sage. Seed of the Church. Shame of the
 World! He and you had the same com-
 mon parents — a brother!



Plate 1151.



Plate 1150. Same

"The Wise In Time Of Peace Prepare For War: Political, Judiciary, Corruption Precede It."

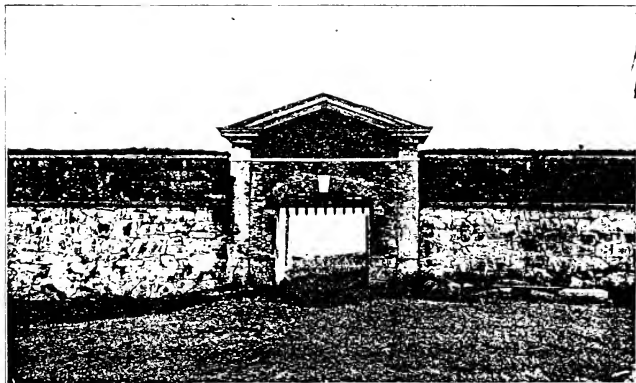

Plate 1153. US F. I. C. structure at Portsmouth, New Hampshire, now changed.

NOW THE GOOD SHIP IRONSIDES, CONSTITUTION, ON WHICH TOBIAS FERNALD, WOUNDED IN BATTLE, DID PULL HIS BLEEDING ARM FROM THE AMPUTATING SURGEON AND WAVED THE STUMP IN THE AIR JOINED in the loud cheers for victory won. He died from his wounds giving his life for Uncle Sam, a synonym for liberty, or honorable death, always preferable to the loss of honor and slavery.



Plate 1196.



Plate 1197.



Plate 1198.



Plate 1199.

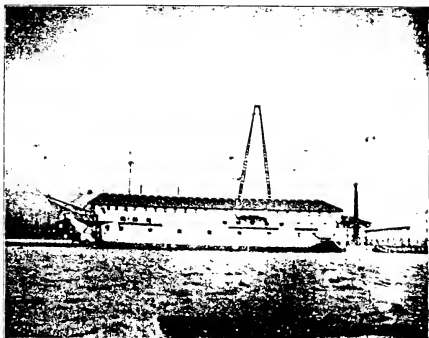

Plate 1153.

Photograph of Constitution taken at Charleston Navy Yard by writer from courteous aid of Captain Phillips at Navy Yard, and 'Uncle Sam's Boys'.



Plate 1204.



Plate 1205.



Plate 1206.



Plate 1207.



Plate 1200.



Plate 1201.



Plate 1202.



Plate 1203.

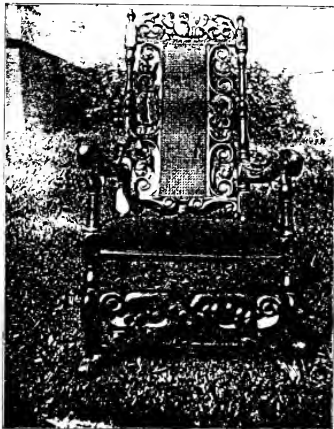

Plate 1154.

Photograph of Chair, said to be one of two brought over by Dr. Renald Fernald. Another he presented, at Washington, (it has on it the Coat of Arms of William Ferneley or Fernel cy.). The owners could give but very little information about it. Vide records of Anne Shaw Fernald, at Genealogical Rooms, Boston.



Plate 1208.



Plate 1209.



Plate 1210.



Plate 1211.

FERNALD FAMILY
SEALS

FERNALD FAMILY
SEALS



Plate 1156.



Plate 1155.

THE CAP-
 N A L D,
 POINTED
 ing awaiting
 for a night
 1 Nov. 1740,
 planned a massacre
 prevented by a surprise
 were killed and with
 wounded and Capt. John
 left side of mouth by an
 side of neck by the chief-
 he wrested from him
 and is now in possession
 blade is recorded "1100
 Turkish and Arabic and
 which is a metal history
 family custom that pro-
 bing into the light for
 when in the shadows of
 previous massacre at



TAIN JOHN FER-
FIRST AT THE AP-
PLACE FOR MEET-
 the arrival of his soldiers
 attack on Indian foes
 the Indians who had
 Oyster River, that was
 of the Indians and 110
 a loss of 14 slain, all were
 Fernald's wounds were
 arrow, left cheek and
 tan's scalping knife that
 and slew him with it
 of writer. On its ancient
 Indians" in mixture of
 primitive languages,
 in conformity with the
 longed search ought to
 universal good, at a time
 obscured truth. The
 Oyster River is recorded

Plate 1158

Plate 1162. Captain John Fernald

Plate 1159



JUNIUS.

Plate 1163. Francis Junius Fernald Family Appeal to the King for Justice

in ancestor Rev. John Pike's Journal:—"18 July 1694. The Indians fell suddenly and unexpectedly upon Oyster River about break of day. Took 3 Garrisons (being deserted or not defended) killed and carried away 94 persons, and burnt 13 houses—this was the first act of hostility committed by them after ye peace concluded at Pemnaqd."

Plate 1160

Plate 1161



**IN THIS HIS-
COUNT OF
LINE TO AVA**
on pen, plume,
also the Egg of Promise in Serpent Mound of American Antedeluvians.



Plate 1164. Furni Pike.

**TORIC PLATE IS THE
THE PIKE ANCESTRAL
AND ADAM BY LINES
and leaves of wreath, crown**



Plate 1213

**COMMONWEALTH
SETTS.** Office of the
War Services of Zebulon
Appears as cornet in the
on March 1, 1777; Reg-
20, 1777; Lieutenant,
Dec. 25, 1778; Regiment-
1780, and served to close
ies, 1791; Capt. in the
March 5, 1792; assigned
1796; Major, March 21,
Infantry, April 1, 1802;
nel, July 10, 1812; hon-
15, 1815. (Died July 27,
tinential Officers, Boston,
ed with original and
Wm. M. Olin, Secretary
Massachusetts, Office of
truly valuable Records
courteously supplied by
of Archives Dept. State



Plate 1165. Major Robert Pike. The ancestor of General Zebulon Pike. Father Z. M. P. and Robert, father of da. Mr. Mary Cotton Pike Ferrald.



Plate 1212

**OF MASSACHU-
Secretary. Revolutionary
Pike of New Jersey.
4th Continental Dragoons
imental Adjutant. Nov.
March 15, 1778; Captain,
tal Paymaster, June 1,
of war; Capt. in the Lev-
United States Infantry,
to 3rd. Infantry, Nov. 1,
1800; transferred to 1st.
Brevet Lieutenant Colo-
rably discharged, June
1834.) Heitman's Con-
June 13, 1895. Compar-
found Correctly Copied.
From Commonwealth of
Secretary. These ascen-
from my request, were
Messrs. Brown and Tracy
House, Boston, Massa-**



Plate 1166. Court Square, Springfield, Massachusetts. Well Known in History.

chusetts. A line of Pikes cut off m. with Washington and has substituted a m. to one of God's das. afflicted with a cancer, the worse will befall if our country is in its almost perfect Constitution—is changed from the glorious gift of General George Washington, Commander-in-Chief and Father, whose religion and instructions never warranted the removal of pure teachings in our schools from the Holy Bible of all denominations. Maj. R. Pike, Commander-in-Chief by Gov. Simon Bradstreet, 1690.

“**TH** ANY A LITTLE MAKE A MIKEL.” RIGHTEOUSNESS THE FOUNT OF LIFE.



Plate 1214. Thomas Fernald, Jr., the son of Mrs Temperance Washington.

Plate was made from a silvered bust which came into my possession with a statement that it was Thomas Fernald, Sr. Afterwards it was found to be his son.



Plate 1216. C. Furnius and Pike Lamp, dated 200 B.C., from the Catacombs of Rome.



Plate 1167 Rev. John W. Chamberlain at Wolfboro Cente School-house requesting of its teacher permission to photograph it. Graciously granted.



Plate 1215.



Plate 1217. In purity United Churches, "Zion still is well beloved"



Plate 1168. Great Battle of Kilbourne Carrison, 9th and 10th September, 1755. John Pike, his son John and wife, Sarah Faneuil; John "Kilburne," wife and daughter defeated from 170 to 250 Indians (different numbers stated by different authorities) who, after a long engagement, retreated, carrying off their dead, "considerable and wounded." John Pike was shot in head, and mortally wounded, died 13 days after. John Kilbourne, Jr., shot and killed the assassin. His sister joined in fight till wounded in arm and shot in shoulder. John Pike, killed, was grandson of Reverend John Pike, of Dover, New Hampshire. The Kilbournes were cousins of Pike.



Plate 1219. Monogrammatic signature of author.

NOW WE
UNCLE
NALD
GRAPH
disappear-
press, and only recov-



Plate 1221.

of the honest well
I have the pleasure of
thanking for their
Service, whose vast
voluminous work
highly appreciated by
nalds and descendants
of America, with the
the whole world, our
well cared for the
ancient name and

Too austere a
wise men: too rigorous
jects; too hard a relig-
ions whose devotions
—St. Evremond.

There is no nobil-
heart: for it never
wanting in good offices,
able. Is but slight
liam.

Who would not
Ageslliaus, King of
fined by the Ephori
of the hearts of the people
whom it was said, that
obeying it. That is

It was a maxim of
to reckon we have done
anything remains to be



Plate 1222.



Plate 1169. Uncle William Fernald, the Generous.



late 1170. Teacher and Scholars at School-house of Wolfboro, N. H.
Photograph by writer of his Alma Mater.

RETURN TO
WILLIAM FER-
WHOSE PHOTO-
MYSTERIOUSLY
ed when sent by ex-
pered by great expense



Plate 1220.

known company that
complimenting a nd
American Express
amount of successful
thereon cannot be too
the whole 63000 Fer-
in the United States
legions scattered over
kinsmen, that have
honor of their most
families.

philosophy makes few
politics, few good sub-
sion, few religious per-
are of long continuance.

ity like that of a great
stoops to artifice, nor is
where they are season-
praise for Uncle Wil-

desire the honor that
Sparta had, who was
having stolen away all
to himself alone? Of
he ruled his country by
well copied by corrupt.

Cæsar's that we ought
nothing so long as
done.



Plate 1222.

IN THIS PLATE GIVE
ILY ANCESTRY, WHOSE
MERIOUS THAT A
AT EAST WOLFBO RO IS
THEY WERE A
CLASS OF MEN AND



Plate 1171. Pike's Ancient
Signature



Plate 1172. Recording the
Mastery Pike. It counts back
twenty-nine Generations to Ena
Zo and So of Holy Bible Records on
Ægypt.



Plate 1172.

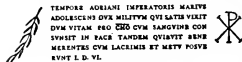

TEMPORE ADRIANI IMPERATORIS MARITVS
ADOLESCENS DVX MILITVM QVI LATVS VELIT
DVX VITAM REGI CERO CVM SAROVIVS CON
SVAVIT IN RAGE TANDEM QUIAVIT BENE
MERENTES CVM LACRIMIS ET MESTV POSVE
RVNT L. D. VL

Plate 1185. Self explanatory.



Plate 1175. Fernald's English Cotton family.
See Heraldry, America Cotton Fernald.

OUR ENGLISH COTTON FAM-
DESCENDANTS ARE SO NU-
LARGE TRACT OF COUNTRY
NAMED TO HONOR THEM.
STRONG, STALWART, BRAVE
GODLY WOMEN.

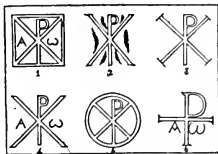

Fig. 87.—Various Forms of the Constantinian Monogram.

Plate 1173. Pike's.



Plate 1174. Thecla, m.
C. Furnius, da. Thecla,
m. Asa Pike, an early
union returns to one
again.



Plate 1176. The Battle, 27 April 1813 at Upper Canada, Toronto,
kil. Brig.-Gen. Zebulon Montgomery Pike, b. at Almatunk,
New Jersey, 5 Jan. 1779, bro. Kubert, b. 1772. Father
Gen. Zebulon Pike, m. Anna Parker Jureau
Funeil=Furnal=Faneuil, eldest ch. Rev.
Peter "ye Protestant Goliath."



Plate 1184. An enlarged
Thecla, C. Furnius
and Pike Seal, etc.



Plate 1188.



Plate 1186.



Plate 1177. A Pike Greek signature below.
Gen. Z. M. Pike, a Hero.



Plate 1189.



Plate 1187.



YMBOLIC STAR OF THE
MOST ANCIENT ÆGYPT.



Plate 1191.

UNITED STATES OF AMERICA, COPIED FROM THE
TIAN WRITINGS



Plate 1194.

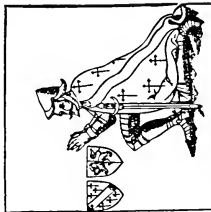

Plate 1179. See English Heraldry. Prayer.
Beda of Furness Sword.



Plate 1192.
Masonic G. Furni Medal.



Plate 1195.
Masonic Medal.
Order published in previous
edition, but to be changed
to the Order of Change
of God's Laws.

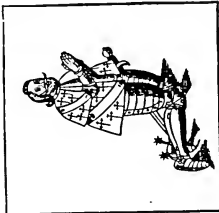

Plate 1180. God answereth prayer
for our god.

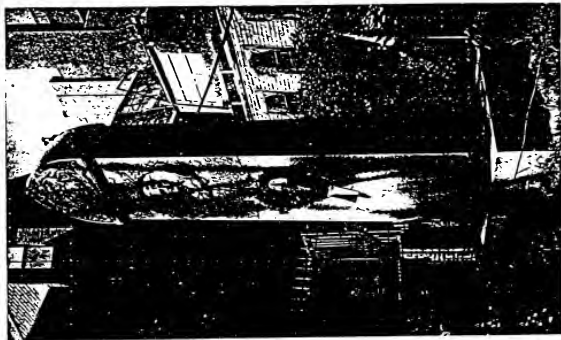

Plate 1178. Governor John Hancock Monument by Massachusetts, at Old Granary
Cemetery. Our genealogy on it. It should be cut into it. Common Ancestors.



Confessions of Immanuel JOHN HANCOCK—
God Honored.
Plates 1193 and 1218. (General) John Hancock.

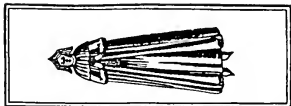
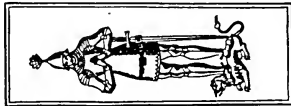

Plate 1180. United One.

“**C**ONSIDER THE LILLIES, HOW THEY GROW: THEY TOIL NOT, THEY SPIN NOT; BE YE THEREFORE READY ALSO; FOR THE SON OF MAN COMETH AT AN HOUR WHEN YE THINK NOT”

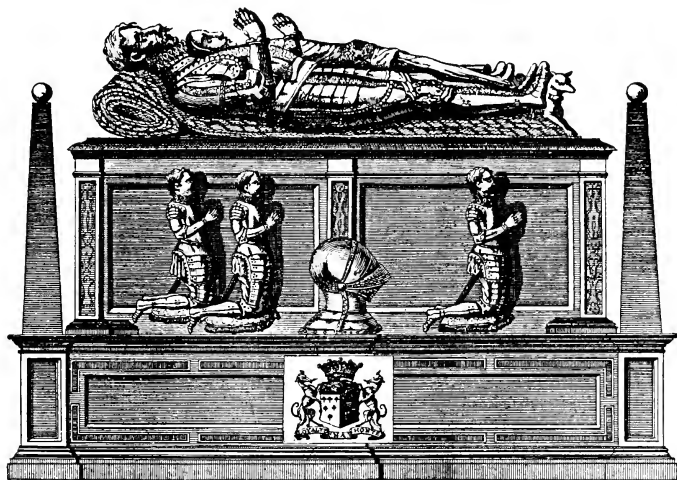

Plate 1182. See English Heraldry for these well honored.

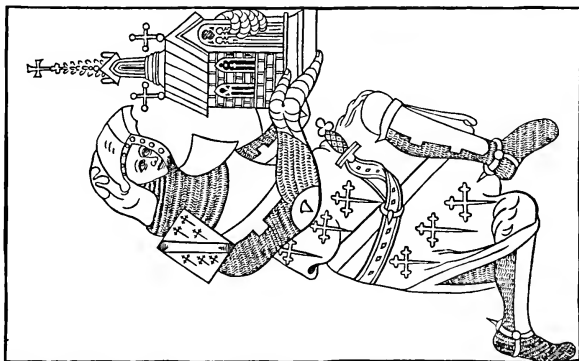

Plate 1185. Heraldry of our Mother Country. THEY HAVE REPEATEDLY FROM HONORABLE CONSULATE SIGNED OUR THREE GREAT MORAL REFORM LAWS, AGAINST THE PRIME CAUSE OF THE DOWNFALL OF NATIONS, EMPIRES, REPUBLICS, KINGS AND STATES. IN PURITY.

“**I** SPEAK AS TO WISE MEN; JUDGE YE WHAT I SAY, FOR WHO MAKETH THEE TO DIFFER FROM ONE ANOTHER? AND WHAT HAST THOU, THAT THOU DIDST NOT RECEIVE? NOW IF THOU didst receive it why dost thou glory, as if thou hadst not received it? Now ye are full, now ye are rich, ye have reigned as Kings without us, and I would to God ye did reign, that we also might reign with you.” “Now the God of patience and consolation grant you to be like minded one toward another according to Christ Jesus.” The Messiah. Honoring Nationalities.



Plate 1225. Masonic, bearing our most ancient family SEAL.



Plate 1228. Seal of Ring.



Plate 1224. The Great Seal of U. S. A.



Plate 1226. Benjamin Franklin.



Plate 1237. Try again.

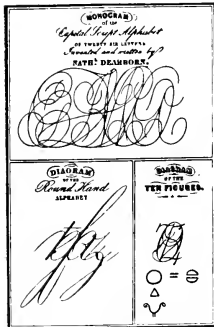

Plate 1231.



WASHINGTON'S BOOK-MARK.

Plate 1229.

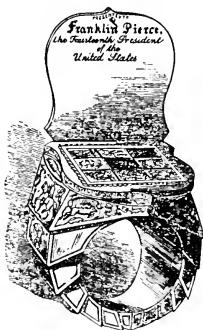

Plate 1230.

Plate 1231. On this wise plate of cousin Dearbon at bottom of right is written by author, the Primitive Alphabet, F. A. M. Keep the key, it is valuable. Plate 1229. WASHINGTON IN HIS SIGNATURE ACKNOWLEDGED HIS DESCENT FROM FERNEL. England offered to him the Crown if he would desert the holy cause of our freedom? He properly refused. Let every man and woman, War for God, Country, State and Family! Cease not till victory is won. Teach thy children to thus instruct posterity. Plate 1230. WITH RING OF 14th PRESIDENT OF U. S. A., PRESENTED BY CALIFORNIA, CITIZENS OF SAN FRANCISCO. Weight 1 lb., Value \$2,000. Massive, superb and emblematic. Purely chaste and historic.

ELIZABETH, QUEEN
ED THE FER-
FANATICS,
ten for three hundred
1575, nor coin of
ance Washington's honored fea-
Thomas Fernald, buried at
inscription stolen from it. Two
daughter of James Wm. Fernald,

Elizabeth B.

Plate 1232. "Good Queen Bess."

OF ENGLAND, PROTECT-
NALD FAMILY AGAINST
WHICH IS NOT FORGOT-
and three years nor the coin
Uncle Sam that bears Temper-
tures, the beloved wife of
Lynn, Mass., in tomb with the
children are named Lyn, viz:
and daughter of Paul Fernald.

"THE HERO OF TIPPECANOE"



Plate 1235.

Plate 1238—He
by the conspirators to
lack of enforced justice
been victims. The
court-martialled, and
over to God for punish-
crime committed
dent of United States
John Symmes Cleves
daughter of Z. M. Pike,
pure breeze the United
Peak. There our na-
servatory and its friends
the "Hero of Tippe-
who gave his life to
SACRED HONOR.



Plate 1238. General William Henry Harrison, 9th President of U. S. A.



Plate 1236.

forgave those appointed
kill him, and for the
our presidents have
criminals captured,
condemned, turned
ment in proportion to
against the 9th presi-
of America. His son,
Harrison, married
who first threw to the
States flag from Pike's
tional and historic ob-
do not cease to honor
canoe," and a Pike
preserve his nation's

Sir Thomas More,
ancestor of writer, was born
son of Sir John, a descendant
riage of Worthy Pike. They
Sir John was fined 100 £. Sir
the oath of supremacy, 1534,
rested and sent a prisoner to
be hanged, drawn and quar-
that the Pope was Supreme,
SUPREME GOD. His
be beheaded, and he suffered
on London Bridge from
St. Dunstan's.



Plate 1234 Sir Thomas More, 1480-1535. Chancellor of England.

Chancellor of England, and
1480 at London, and was a
of the St. Maur's by mar-
were persecuted by the court.
Thomas was requested to take
and refused. He was ar-
the Tower—condemned to
tered, for the absurd belief
when there is only one
sentence was commuted to
5 July, 1535. Head placed
Tower-hill and buried at



Plate 1237.



Plate 1238A

NOW AS A FEW RELICS MAY INTEREST US, THE TWO PAGES GIVE A PHOTO-PLATE OF PART OF MANY HUNDREDS IN THE POSSESSION OF WRITER.

1, Sword of President Harrison. 5, FERNALD family ancient genealogy historic sword blade covered with inscriptions in mixture of languages: features of Persian foremothers. 3, Dr. Jean Fernel's battle sword. 3, Masonic sword. 4, Washington's sword given to Col. Tobias Fernald. 6 and 7 back of it, Private Gen. Records- giving data of Dr. John Fernel and his sword with a cypher count to Charles VIII, k. France. 8, U. S. flag, showing increase of States. 9, U. S. flag 13 stars, made by Mrs. E. A. Fernald, whose ancestor John Dacres was in American Revolution and this lady gave her life for reporting concealed firearms to us vs. State and U. S. 10, flag, Italy, Rome. 11, last autograph letter written by ancestor



Plate 1239.

Gaspard de Coligny, Dr. Jean Fernel's one have 13 containing his Charles VIII with titles wrote, on one of which and one of the family of Capt. William Fernel 1630, brt. over to Va. da. Temperance Wash-Fernald. 14 Relic of Fernel's book with ti-ings. 16, 74, 75, 76, Union: and gun of Ad-Center gun owned by gun saved and given to with history, Regt- lock and sights shot to placed in ambulance. Potrait-Engraving pre-Louis Joriaux, Arch- of the world for Cabinet d. Hozier, his courteous letters re-

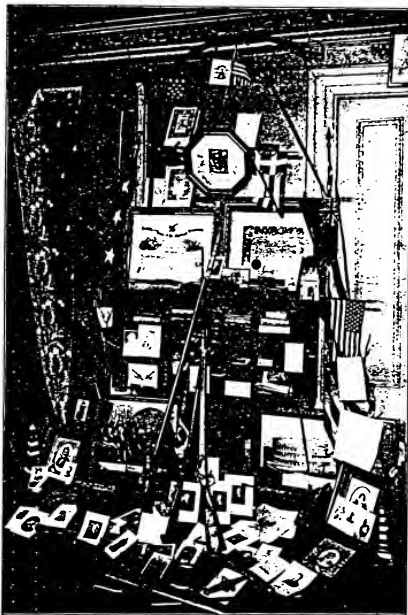

Plate 1241. Important Historic Fernald Relics. See numbers on PL 1246.



Plate 1140.

Admiral of France. 12, of 17 books I had and coat of arms as son of of many good books he is a caricature of him coat of arms, probably nald of King Philip, Robert and Anna with ington who m. Thoms. Civil war. 15, Dr. Jean tles of many of his writ-Relics of Civil war for miral John Paul Jones, N. H. soldier, shot, me by Mass. soldier Co., N. H., Vol. Its pieces. Soldier was 18, Dr. Jean Fernel sented to me by Hon. ives (during the search facts) de la Noblesse Paris, France. 19, plete in information.



Plate 1242.

20, Son of American Revolution Diploma: 21,22 Flag and captured Philippine Spear, etc. 23, Dr. Jean Fernel's large book on medicine with many Roman coins on top of it, left two Horse Pistols used in the American Revolution: with Dighton Rock, Plymouth Monument and Cannon Ball captured by Capt. Daniel Fernald, also, 31 Bunker Hill Monument, seen also, 107, on right corner of roll top desk the shell, surmounted by a loose ball, that was fired at Moro Castle, Spanish War. Fig. 30, my diploma as descendant of Capt. John Furnal, of the Abigail at seige of Louisburg. 36, Some of books written by Dr. Jean Fernel, on 4 shelves. Second row relics. Third row relics, a hammer from Gov. John Wentworth's mansion used to open skylight for the memor-able leap of 60 feet by Jonathan Fernald to escape death when it was burning down at Wolfborough, N. H., Wm. Fernald and Gov. John Wentworth's Portraits on right. 82, Hilt of Jean Fernald's sword: 3 very valuable books: "Good Queen Bess'" teapot: revolver bought for Spanish war: relics of American history. Docu-ment accepting my voluntary services for Spanish war. 84, Our Presidents. 80, Important books with top covered by Roman Coins. 77, Plymouth Monument. 63, One of the Bibles translated by Francis Junius Fernel with assistance of Emaneuil Tremellius, whose da. he married and their descendants, 2nd. Rev. Daniel, 3rd. Rev. Peter, 4th. Peter Faneuil is buried in Old Granary Cemetery. 55, Coliseum at Rome. 56, Dress sword of Capt. John Furnal. 52, Part of the remains of the Warwick that brought over Dr. Renald Fernald and 80 emigrants to Strawberry Bank, 1631. It was wrecked at Squantum about 185 years ago. Touching the wreck is the coat of arms sent from College of Heraldry Paris, France. Our family portraits are found scattered around the base, with the erased face of one of Boston's Protestant Ministers, by papists, who ever do all they can to detract from the old and best Puritan stock that number 62,000,000 in the United States of America.



Plate 1243.

THE FIG. 92 WAS TAKEN FROM THE ORIGINAL TIMBERS OF "IRONSIDE" SHIP CONSTITUTION AT PORTSMOUTH, NEW HAMPSHIRE. IT WAS POWDER AND FERNALD BLOOD STAINED, AND BEING WEAK IN centre is now to be seen broken from an accident. The boarding swords (95) were cast into the Sea after America's Civil War, that liberated.



PLATE 1244

Below is to be signatures of Samnald = Pharnell = Peniel = Faneuil = Funel = Furnall = Fer- See Genesis 32, 30, & Hebrew Bible. Old Granary Cem- Mass., U. S. A. ent spellings have most ancient name FNA&FNR with W. Fernald re- I have found 127 other modes of covered by me.

The Syrians, sians and Indians, the rising of the of the Athenians, Jews day began at cient Italians be- of sunset. The by Pepin, King of by history. There uable for good acts, as the present

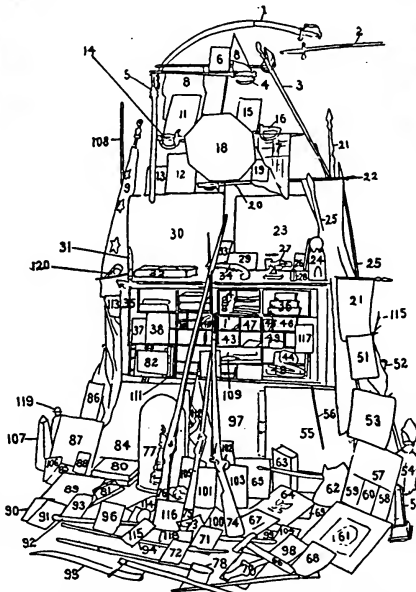

Numbers from Plate 1246 of some of Fernald Families Relics. From prolonged search not a single Fernald has been found untrue to State and righteous Government throughout the ages.



PLATE 1245

found two of the uel Fernald = Fer- $\Phi \epsilon \nu \epsilon \lambda = \text{FNR}$ = Faniel = Faniel = Funal = Fernald as is now spelt 31 of Holy Bible Faneuil Tomb, etery, Boston, Eighty-five differ- been found of our and the first is O-O = FNF. H. ported 125 ways. and there may be spelling it undis-

Babylonians, Per- began their day at sun. The civil day Arabs, Gauls, and sunset. The an- gin the first hour first clock owned France, recorded is no time so val- deeds, honorable time, to do well.

Sam[#] THE Saniet
TURKISH

PLATE 1247.

San[#] THE Saniet
TURKISH

PLATE 1248.

Two signatures of Samuel Fernald, Autographs. He was Atty. for my ancestor John and won his case in Boston Court after Attys. refused to aid him further. The sig. Turkish, Greek, Primitive, Monogramic, Genealogical. The same refused 1896 was repeated, to protect a proved criminal!





Plate 1249.



Chapter XIV.



Plate 1251.



PLATE 1250. Continuation of the Fernald Family Relics for Universal Good from my copper plate.

III

ATTHEW 11:28. "COME UNTO ME, ALL YE THAT LABOR AND ARE HEAVY LADEN, AND I WILL GIVE YOU REST."



Plate 1252.—Robert Washington and wife, Anna Cotton, daughter Sir Robert Bruce Cotton, Temperance Washington and brother, John Washington. Family discussion of advisability of going to America: 1630. Brought over by Captain William Fernald.



PLATE 1253—PART IN CIPHER AND THE KEY IS THEREON. An interesting study.

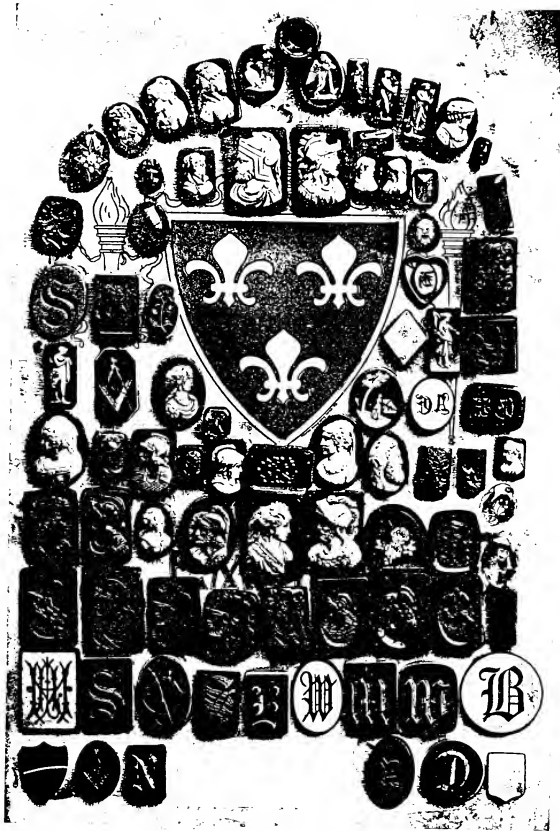

PLATE 1254. Seals, Monograms, Faces for Universal Genealogy! Select your own, give all the proof you can and we will aid you in the cause of truth and to honor thy father and mother.

SALMS 81:2 TAKE A PSALM, AND BRING HITHER THE TIMBREL, THE PLEASANT HARP WITH THE PSALTERY.

H

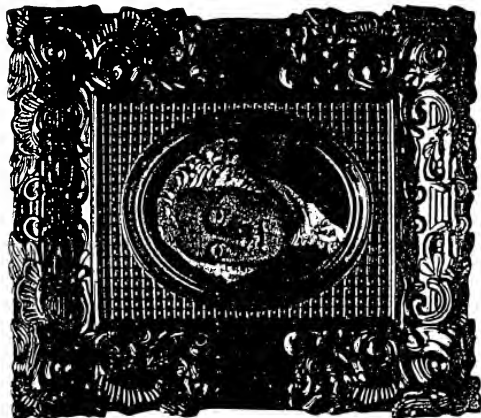

Plate 1256.

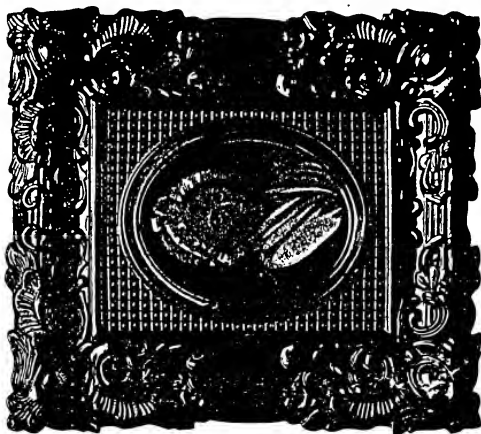

Plate 1255.

These two likenesses of the great and good General George and Martha Washington the parents of United States of America have been declared the two most accurate, and thus are accepted by an immense number of good judges.

Plate 1258—The autograph of General George Washington. Last part of name spell FERNEL or FIRNEL!!

George Washington

Plate 1258.



RECORDED IN CIPHER LANGUAGE IS THE LINE OF THOMAS FERNALD, WHO MARRIED TEMPERANCE WASHINGTON, TO CHARLES VIII, AND HER DEATH ON SPOON. VESSEL OF DR. JOHN FERNEI. TURKISH COIN.

Plate 1257. Silver spoon of Captain Sir William Fernald and ship, King Philip, on which, as did Peter Faneuil on Tomb, he counts his genealogy to Louis XI. King of France, etc. A Turkish spoon piece of money. Ancestral faces and a seal monogram of Anne of Brittany and C. S., etc. A Fernald Key: it turns both ways and unlocked the safe of Dr. Jean Fernel: given by William to Dr. Renald Fernald. IT IS VALUABLE AND HISTORIC. The Persian ancestral head is inlaid in a Mauser Rifle with 364 pieces to keep as a valuable war relic.

Autographs on deed of

William Fernald
Betsy Farnold

Plates 1266 and 1267.

to his oldest son, & in his Bible:

John Fernald

Fac-Simile Signatures. Plate 1268.

William Fernald

Plate 1264

William Fernald

Plate 1265.

Interesting signatures of Samuel Washington, whose nom de plume was William Shakespere.

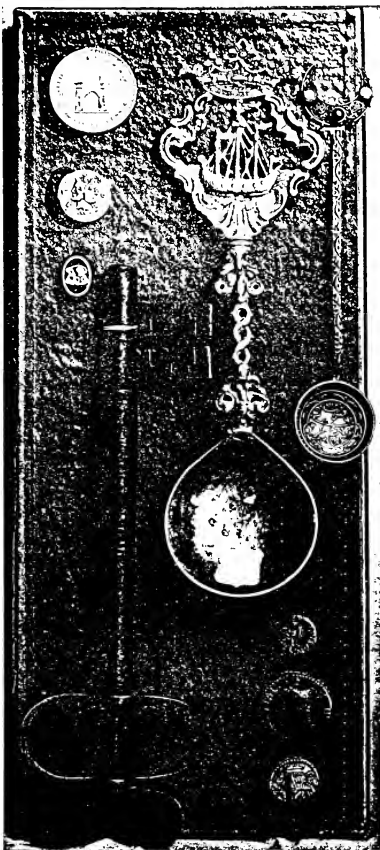

Plate 1257

Relics and a recent medal.

William Fernald

Plate 1259. AUTOGRAPH

Tobias Fernald Lt. Col.

Autograph of Colonel Tobias Fernald, son of Captain John Fernald of Abigail, at the Siege of Louisburg.



Plates 1262 and 1262-3.

Ring of Samuel Washington, m. Anne, da. Francis Junius Fernald.

ACH GOD

BLESSED.

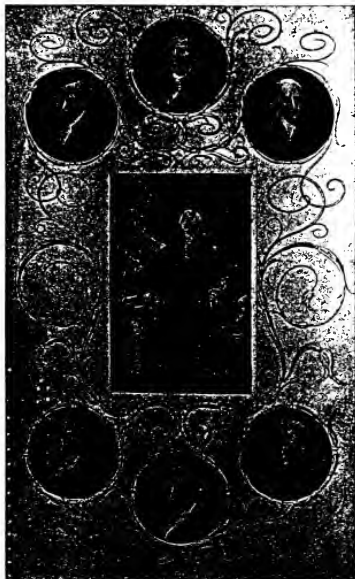

PLATE 1269.

Frederic T. Greenhalgh

Plate 1270. Fac-simile of Autograph.

*J. Braman Hall
Adjutant General*

Plate 1271. Fac-simile of Autograph.

Plate 1269. Every loyal American delights to honor our Presidents who led us through the perilous wars and many vicissitudes to the greater United States that its loyal men are in the broad strife for benefiting the whole human race, unselfishly in purity, ONE. The sword borne in the hand of Washington is the one presented to "Captn." Tobias Fernald.

Plate 1270. Following in the footsteps of illustrious predecessors, nobly he advanced right, notwithstanding his foes attempted to destroy the brave noble GOVERNOR OF MASSACHUSETTS.





EALS, RINGS, A FEW OF ANCIENT FERNALD FAMILIES ON PL. 1272 ARE DISPLAYED.

Plate 1272

View from left to right:—bottom to top:—1st, Thomas and wife Temperance Washington Fernald. Right Corner Ancestral Seal of Phineas, son Col. Saml. Johnson whose da. m. Wm. Fernald. It contains the initial letters of More etc. see Poem.

11th Seal of Alexander the Great. 13, 14, 15, Capt. John Fernald and wife Elizabeth Rogers: mourning ancestral ring, Annie of Britian, and her husband Charles VII Rings. 22 & 25, Turkish relatives Seals. 26, Thomas John Savage Seal said to have been given to Mary Savage who married Mr. John Fernald and buried in North Cemetery, Portsmouth, New Hampshire, U. S. A. His Epitaph well earned is as follows:



"HISTORY OF CREATION WHICH THIS ONLY WIFE OF NOAH WROTE ON THE ARK AT MOUNT ARAAT AND IS THE TRUTH PROVING THE HOLY BIBLE GENESIS TRUE BEFORE IT WAS WILFULLY CHANGED FOR POWER THE TABLET OF ABYDUS AT THE BRITISH MUSEUM BEARETH THE EGYPTIAN HISTORY IN PURITY."

"Mr. JOHN FURNALD, Obt. November 23, 1792: A e. 50." "Thro' all this large extended hallow ground, where the rich, the poor the humble and the BRAVE, not ONE more HONEST, or Friendly, E're was found: Than HE who sleeps within this silent grave." 27, Fernald & Cotton Coat of Arms. 30, Thecla of Urn of C. Furnias. 31, is the most important SEAL in the collection hereon shown, that ought to be preserved in the National Museum and guarded. For description, vide E1. Second. See the documents in reservation held of all of these and many more of the historic seals with Oldest of Fnr Lamr on the

LAST Ce-
 cealed
 North
 Corner
 of the
 Old resi-

dence of Mr. Jonathan Poor FERNALD (Fernald) where all of his children except Maria Renald Fernald were born. Sister Maria was born at Wolfboro or Brookfield, N. H. who married Oran Dixon, born at Lebanon, Maine, Aug. 21, 1819, died at Sanford, Me., Jan. 21, 1900, and his wife Maria R. Fernald, born 16 Dec. 1822; died at Wolfboro Centre, N. H., Dec. 14, 1892.

J. P. Fernald's house was built on top of a hill over a ledge of stone in pioneer times. The ell first and large part as related. The old apple orchard and plum with cherry trees came to maturity, were enjoyed then passed away, to be followed by two of the best parents on earth and eight children, leaving at date but three surviving. No eulogy of mine

of center J. P. Fernald's home. Show residences of Samuel Stevenson and Samuel Reynolds, in distance, with school house and near Oran Dixon's and son, Charles O. Dixon's, U. S. Post Master, and the large building is the hay and cattle building, where, when a boy, because the writer was afraid to do it, he walked unsupported along the top until fear vanished. Opposite side shows the residence of Mr. Thayer, and afterwards Joseph Nudd's and wife. The Blacksmith Shop, Uncle Henry Pike's and Henry Stevenson's buildings do not show on this plate of the beloved scenery of boyhood home, dreams, loves and ambitions that ever move the heart to quicker pulsation and the mind to review its deepest most hallowed recesses that are known only by God, and self



Plate 1273.



Plate 1274. The small village of Wolfborough Center, N. H. Photograph from Fernald's Hill, east of the house, near church.

can be perfect enough to do justice to my kind, firm, loving, perfect, Christian, generous parents. The house frame of large part was constructed from Parson Allen's church. The present church was built by Mr. Jonathan P. Fernald aided by Hon. Thomas L. Whitton and Elijah Horne, whose da. Bella married Rev. John Chamberlain who now owns and occupies it, having made many beautiful improvements, among which is the establishing of a summer resort on

the shores of Lake Wentworth that a road built from Fernald's Crossing (Railroad) leads thereto unto health, beauty, quietude, pleasure, recreation and happiness that cannot be too highly praised by the writer who has passed many enjoyable years in youth gleaming bountiful blessings from it and environment.

Plate 1274:

The village in 1869. On right



NOW IN PLATE 1275 IS SEEN ON RIGHT THE LAST DECEASED SISTER AND LIVING ONE AT THEIR RESIDENCE AND HOME: FARMINGTON, NEW

Hampshire: Mrs. Josie M. Buzzell and Late Miss Sophronia C. Fernald, who was at their Summer Cottage poisoned July 26th, 1906 and died at 1483 Washington St., Boston, Mass., 28 July 1906 and the infamous prisoner of three sisters and a brother, permitted to go on in boasted protection in all crimes: vide, Encyclia Americana with reports of our President McKinley assassination. And the intent to assassinate President Theodore Roosevelt, which culminated in that of a sister, and that of an ever believed forged change of her will, with express jollifications at the death of the most noble woman on earth.

Nothing but religion is capable of changing pains into pleasures. Where religion speaks, reason has only a right to hear. Hope makes time very long, and enjoyment very short.

The courage which emulation inspires for an enterprise soon finds the means of succeeding.

When a town, city, state, government, na-

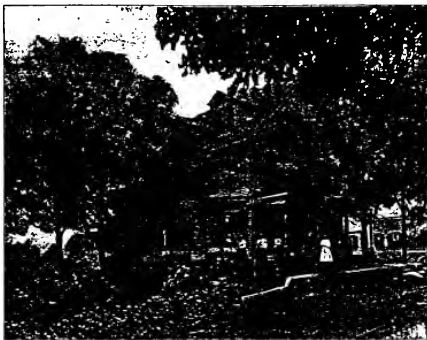

Plate 1275. Home of Mrs. J. Moore Buzzell & S. C. Fernald



Plate 1276 Tomb of Fronia Josephine Fernald and Miss Sophronia Chase Fernald, Farmington, New Hampshire, United States of North America.

tion or nations protect their criminals in highest or lowest classes: then, martyrdom of the virtuous in towns, cities and the world's pure is accomplished, and the general downfall is assured. The wise trace these matters to their own foes who are ungodly men in every station of life, whose deep subtilities are used to beguile the unwary.

"Vengeance is mine saith the LORD, I will repay!" God chooses his own agents to accomplish his own desires upon the depraved wicked.

Nature cries aloud to the most powerful, as well as the most abject of men, that they are members of the same body.

Must one cease to be virtuous to escape being exposed to the darts of envy? What a calamity would it be if the sun ceased shining that weak eyes might not be offended!



THAT MR. EDWARD E. DIXON VOLUNTEERED FOR SPANISH WAR WITH HIS UNCLE CHARLES DID NOT PLEASE THOSE WHO TWENTY YEARS PROTECTED CAPITAL AND WORSE CRIMES FOR WHICH TWO JUDGES AND AN ATTORNEY GENERAL RESIGN. AS BACK OF IT IS THE REPORT OF STORING FIREARMS TO USE AGAINST STATE AND U. S. WITH A DEPOSITION OF CAPITAL CRIME

AGAINST A HIGH DIGNITARY OF THE ROMAN CATHOLIC CHURCH. ALSO A REPORT OF SIXTEEN DEATHS OF ALL THOSE WHO BUILT SECRET PASSAGES UNDER HIS SAID CHURCH. NATIONS I FEARLESSLY SHOW YOU FACTS AND YOUR DANGER FROM THOSE. AMONG MANY PURE, FORMER NEITHER SERVE GOD NOR RESPECT THE LAWFUL RULERS OF THE NATIONS: MANY OF WHICH THEY HAVE MADE POOR BY EVER MEDDLING WITH POLITICS WITH EVER RESULTANT WRONGS, BLOODSHED. LET IT CEASE!! GIVE FULL JUSTICE.

Justice! unto the lawful Rulers of this Earth which the Lord thy God hath given to you, appointed and anointed, blessed you the head of all his children for your and their highest good that God so loved that he gave for death his only highest heavenly son who taught as the primitive religion taught,



Plate 1270.



Plate 1277. Ossipee Indian Mound and Fort.



Plate 1278. Edward Everett Dixon and Hunting Companion.

notwithstanding the 170 religions have changed the only one primitive found.

"Tis true, and sad, it is true, that of the seventy who wrote the Bible, when much was lost of the primitive religion, hundreds of years after Christ died. These great translators could not agree.

Careful studies for truth only has shown that in the Hebrew Bible and in the Hebrew New Testament, when they are translated into the Egyptian primitive hieroglyphics and symbols do clearly show all the primitive religion for all of earth made after the likeness of our Creator God whose name has even been found as spelt in 170 ways. The papyrus, mounds, inscriptions and coins give correct aids that the wisdom of this 20th century ought to as a sacred trust utilize conferring great honor on mankind by obeying the Commandments of God.

Plate 1278. Edward Everett Dixon and companion with Topsy on Mound. One looking to Fort, the other toward Lovell's Brook the scene of great Indian Battle. Topsy watching my camera work. Mr. Dixon on the right. Persecuted for seeing and testifying against protected Boston criminal.

"Behold, what manner of love the Father hath bestowed upon us, that we should be called the sons of God: therefore the world knoweth us not, because it knew him not."

GOING TO SQUANTUM TO ERECT A STATUE, WAS THE CRY OF THE SOCIETY OF COLONIAL WARS.

It was that brought Strawberry 185 years ago, and in a tions of the ancient vest-timbers on shore. It fore iron was substituted latter, the original and for repairs. See plate of Two English ladies de-came over at the time of from there to the Brit-fought against the Amer-

When great men overcome by the length let us see that they only the strength of their that of their minds; and of a good deal of vanity, other men.

Philosophy tri-and over future evils, but over philosophy.

We have all of us bear the misfort-

The constancy but the art of look-in in their minds

It requires support good than

Tacticus com-his elevation to the "Nihil in vultu tum: quasi imper-quam vellet." Hist.



Plate 1280. The Statue at Squantum, Massachusetts.



Plate 1281. In the American Revolution we fought under the Crescent.

There is going on in the human mind and heart a perpetual generation of passions, so that the overthrow of one is almost always the establishment of another. Self love is a flatterer.

The passions are the only orators that always persuade: they are, as it were, a natural art, the rules of which are infallible: and the simplest man with passion is more persuasive than the most eloquent, without it. Vide maxims of Francis Duc de la Rochefoucauld—line—Fulk.

here that the Warwick over 80 Emigrants to Bank was wrecked about part of it I found indica-sels and a portion of its showed construction be- for wooden pins, both, former, an iron bolt used relics for that portion. clare that their ancestor the wreck, and went ish Provinces. He icans on Breed's Hill.

suffer themselves to be of their misfortunes, they supported them through ambition, not through that with the exception heroes are, made just like

umphs easily over past present evils triumph

sufficient fortitude to unes of others.

of sages is nothing ing up their agita- and hearts.

greater virtues to bad fortunes.

ments of Piso on empire by Galba: habituque muta- are posset magis, 1. 17.





OUR POSTERITY ARE BLESSED BY THE NOBLE PURE GODLY ACTS AND DEEDS OF ANCESTORS!



JEAN FERNEL, b. 1497-1558.



PLATE 1303.
JONATHAN POOR FERNALD, b. 1797-1893. Photo at aet. 93.



WILLIAM FERNALD, b. 1775-1867. God's Children.



PLATE 1304. J. P. FERNALD, at 65 yrs.



PLATE 1305. Mary Cotton (Pike) FERNALD, at 62 yrs. of age.

Married: Jonathan Poor Fernald to Mary Cotton Pike, da. of Robert Pike and his wife Mary Cotton, da. Col. William Cotton and his wife Mary Clark, 13 September 1821. 11 children.

DOWN FROM TOP LEFT HAND ARE THE CHILDREN AS FOLLOWS:
 ("NANCY FOR ANNETTA") NANCY HORNE FERNALD, SCHOOL
 TEACHER, m. W. T. DORR, AT CIVIL WAR: MARIA RENALD FERNALD,
 School Teacher, m. O. Dixon.

Brackett Fernald, 1st, d. y. Hannah Fernald, 2nd, m. J. B. Haines.

James William
 Fernald, m. Sarah
 Higgins. 3d wife,
 Belle Matteson
 Joan More Fernald,
 School Teacher, m.
 S. H. Buzzell.

Hannah Fernald,
 1st, fl. y.

Mary Elizabeth
 Fernald, m. J. L.
 Dixon and D. Cole-
 man.

In centre is Moth-
 er Mary Cotton
 (Pike) Fernald.

Plates made by C.
 J. Peters, whose Ro-
 man Catholic Secre-
 tary kindly recom-
 mends to restore old
 plates those who do
 excellent work on
 everything that is
 not Protestant, ex-
 ceptable on Protestant.
 Nearly all these
 plates of my family
 line and relatives are
 caricatures, readily
 seen by comparison
 of my bro. James,
 and myself Phos.
 and plates delineated
 thus in this to stop
 every untruth forced
 upon a free Repub-
 lic, now overrun by
 bought up Vatican
 worked against enact-
 ment: shown up for it
 they refused to sign
 after offering a bribe
 of \$250,000 "to work
 against State and U. S.
 for the Roman Catho-
 lic Church," boasting
 "others will take it if
 you will not." Other
 bribes were offered.

Honestly, earnestly
 laboring for the good
 of all, using every
 righteous effort to
 keep from this book
 every radical state-
 ment, regretting that
 I am compelled to
 thus handle and
 demonstrate the
 dangers, as is done
 to preserve true
 christian manhood
 for peace on earth
 and good will to
 all men, a very
 humble servant of
 God, say: it hath
 been declared that
 any one who knows
 of a crime and will
 not aid or abet its
 prevention, its
 punishment, is
 particeps criminis.
 Popes Leo XIII
 and Pius X with
 Vatican refuse
 signatures against
 capital and worse
 crimes. May God
 forgive them! Con-
 fer Wisdom!!



Plate 1306. Family of J. P. and M. C. (P.) Fernald.—Continued p. 255.

press, spies, tools to
 aggrandize pa pa cy
 and rob all the good
 Nations.

Every conceivable
 persecution has to
 date been inaugu-
 rated, put in full force
 and continued from
 1870 to 1909 inclu-
 sive, after first mak-
 ing exhaustive to
 them as they be-
 lieved, inquiries, that
 has so clearly proved
 the accuracy of our
 long line of descent
 from Charles VIII
 with remote and de-
 scendant ancestors,
 as set forth, which,
 oath can be taken
 properly to its accu-
 racy, well known,
 that the Highest of
 the Roman Catholic
 Church have signed
 in Boston repeatedly,
 acknowledging same
 and petitioning for
 the enactment of our
 three great moral re-
 form laws against the
 cause of the downfall
 of men, states, gov-
 ernments and nations
 from primeval time
 to the end of the
 world: signing, they



IN EARTH THERE ARE NONE SO NEAR AND DEAR AS WIFE, CHILD, FATHER AND MOTHER, SISTER AND BROTHER, WHO ARE "BORN FOR ADVERSITY."

Charles Augustus Fernald, plates 1307 and 1308; WIFE, ELIZA AN. ACRES MORRIS FERNALD, da. FRONIA JOSEPHINE FERNALD, BROTHER and SISTER JONATHAN BRACKETT FERNALD and SOPHRONIA CHASE FERNALD.



PLATE 1307. Charles Augustus Fernald.

Mrs. Eliza A. Fernald.

Fronia Josephine Fernald.

"Behold, what manner of love the Father hath bestowed upon us, that we should be called the sons of God: therefore the world knoweth us not, because it knew him not." "Little children, let no man deceive you: he that doeth righteousness is righteous, even as he is righteous." "For this is the message that ye heard from the beginning, that we should love one another." "Not as Cain, who was of that wicked one, and slew his brother. And wherefore he slew him? Because his own works were evil, and his brother's righteous." St. John I. 3.

"Marvel not, my brethren, if the world hate you."

Who loveth not wife, child, father, mother, sister and brother knoweth not God, for God is love. These all I have loved, and of the dearest, only God remains.



Jonathan Brackett Fernald.

Sophronia Chase Fernald.

PLATE 1308. CONCLUSION OF FAMILY GROUPS.

Seven of these, and the family of Napoleon, General Moreau, Sir Thomas More, Rev. John Rogers, Dr. John Fernel, the husband of Annetta, daughter Gasgarde de Coligny, Admiral of France, the first American Genealogist Henry Washington Fernald were crowned by martyrdom with Francis Junius Fernel and his parents Dr. Jean Fernel and wife, after his father Charles VIII, from 1497 to 1909.

A good man out of the good treasures of his mind and heart bringeth forth that which is good; and an evil man out of the evil treasures of his mind bringeth forth that which is evil; for of the abundance of the mind and heart his mouth speaketh, thus sowing good or evil; as the seed, like will be the fruit.

"We know we have passed from death unto life, because we love the brethren. He that loveth not his brother abideth in death."

"Little children, keep yourselves from idols. Amen."

UPON THE GENERATIONS OF THE RIGHTEOUS IS CONFERRED THE DUTY OF PRESERVING THE HONOR OF THE HOUSE.

J A M E S
m. BELLE
A. and Mary
photo unchanged. Pl.
1310 is of his forefather.

"Men are sometimes because their accusers selves if they were in their

"Interest, which blinds others."

"Nothing ought so good opinion we have of disapprove at one time other."

"It is not all that know their hearts."

"We give nothing so

"Here, my sagacious this purse of gold, and to be so great a fool as to another." — *Q u e n t i n*

"We are sometimes as

"Nature creates merit play."

Juvenal or Fuvnal, the thorough appreciation of

"Respicit hæc pri-
servi
an post te sella, togati
ducta Paulus agebat,
vii. 141.

Quelle mesintelligence
Le philosophe vit mal
le politique rempli de
sait pas se gouverner."

"The head is always

"A determination poses us to deception."

Twenty-one of Rev. ants, besides those of fe- at Harvard College. By Sarah Story, Seaborn, b. on passage to N. E.: 2d Sarah: 3d John: 4th Roland, named for gr. fr.: 5th da. m. Mr. Eggington: 6th Maria m. Rev. I Mather: 14 have been clergyman.



Plate 1309. JAMES WILLIAM FERNALD. First to advocate
Flags over School Houses. Adopted by U. S. and other nations.



Plate 1310. REV. JOHN COTTON, b. 4 Dec. 1585; d. 23
Dec. 1652; bur King's Chapel Cemetery, Boston.
Ancestor of Mrs. Mary Cotton Pike Fernald.

WILLIAM FERNALD-
MATTESON, da. Joel
(Fish) Matteson. This
1309, photo a. 1894, Pl.
(Vide.)

accused of pride merely would be proud of them- places."

some, opens the eyes of

much to diminish the ourselves as to see that we what we approve at an-

their heads who know

liberally as advice."

friend," said Louis, "take with it the advice, never think yourself wiser than Durward.

different from ourselves."

and fortune brings it into

Roman lawyers, had a this truth:—
mum, qui litigat, an tibi
Octo, decem comites,
Ante pedes. Ideo con-
Quam Basilus."—*Sat.*

entre l'esprit et le cœur!
avec tous ses preceptes, et
vues et de reflexions ne

the dupe of the heart."

never to deceive often ex-

John Cotton's descend- male branches graduated 1st wife no chn.: 2d

REVERING AND HONORING MY FOREFATHERS, WHO WORSHIPED GOD IN WORDS, DEEDS, ACTS. FAITHFULLY, FREELY BESTOWED, GIVE WE THE WREATHS AND FLAGS OF GREATER UNITED STATES of America, to commemorate by dedication, a token of kinsmanship honoring and love.

JOHN, the brother of Seaborn Cotton, a minister of Plymouth, b. 13 Mar. 1640; d. 18 Sept. 1699; m. JANE ROSSETER, 7 Nov. 1660. Had—1, John, minister of Yarmouth; 2, Elizabeth, m. Rev. James Arling, 2. Rev. Caleb Cushing, of Plaistow, New Hampshire, and mother of Rev. James C. and Rev. John Cushing of Boxford; 3, Sarah; 4, Roland, minister of Sandw-
 wich; 5, Sarah; 6, Maria; 7, son died infant; 8, Josiah; 9, Samuel; 10, Josiah 2nd; 11, Theophilus, minister of Hampton Falls, N. H. grad. H. C. and died 18 August 1726: Above JOSIAH 2nd was born 8 Jan. 1680, father of COL. WILLIAM COTTON who moved to Portsmouth, and then to Wolfborough, New Hampshire.



Plate 1311. Names of those buried in my ancestor's, Rev. John Cotton's Tomb, at King's Chapel, Tremont Street, Boston, Mass.

SEABORN COTTON, son of Rev. John, was b. August, 1633, 3rd minister of Hampton, d. 19 April, 1686; m. DOROTHY, daughter GOVERNOR BRADSTREET. Had—1, Dorothy, m. a Smith of Hampton; 2, John; 3, Ann, b. 23 April, 1661; 4, Sarah, b. 2 July 1663; 5, Elizabeth, b. 13 Sept. 1665; 6, Mercy, b. 3 Nov. 1666, m. Capt. Tho. Tufts, father Rev. John Tufts; 7, Abia, d. infant; 8, Maria, b. 22 April, 1670, m. 1st, Mr. Atwater, 2nd, Samuel Partridge, one da. m. Mr. Richard Pierce, another m. Mr. Carr.

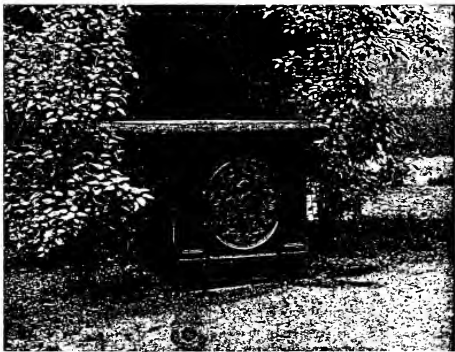

PLATE 1312.

Plate 1312. My Peter Faneuil=P. Furnal=Funel=Funal Tomb. Dedicated with prayer by Pastor Graves, first of October, 1 p. m., one thousand eight hundred and ninety nine, at Old Granary Cemetery, Tremont Street, Boston, Massachusetts, United States flag raised and it with Old South Tomb sealed. Former unto God, Country, State and Family, and later unto same and families! In the coat of arms on the Peter Faneuil Tomb are 256 lines of evidence and proof of same in monogrammic Newport Tower, also, in Dighton Rock inscription, Oldest Map Chart of our true genealogy and national discovered long forgotten universal history extending to primeval time and primitive religion, the lost now found, Hebrew language before points were introduced for obscurity.

William Cotton, of Boston, a member of the Ancient and Honorable Artillery Company 1650: Had William, b. 1646; William 2nd, 1654; William Cotton in Portsmouth 1685; John Cotton in Concord in 1667 and 1679. George in Springfield, d. 17 December 1699.

❖ ❖ ❖ ❖

"FANEUIL, 1, 2, 3, 14, 26, 36, 13, 186. Vol. 14. Town Meeting at FANEUIL HALL 1742, first time since the death of PETER FANEUIL, ESQR. 14 March." He d. 1743. Forenoon—Mourning. See Boston Report of the Record Commissioners: Note dates.

ORATION OF MR. JOHN LOVELL, MASTER OF THE SOUTH GRAMMAR SCHOOL, RECORDED BY ORDER OF THE TOWN.

I Stand in this place, my Fellow Townsmen, and my worthy Patrons, at the Call of those to whom you have committed the Directions of your Publick Affairs, to condole with you for the Loss of your late generous Benefactor, The Founder of this House. Certain I am, there are Numbers in this great Assembly, who could upon this occasion have done more Justice to his Memory, and have better Discharged the Office that is enjoin'd me. But the Commands of those (for such I must always esteem their Desires) who have devolved this Charge upon me, and the Veneration I have for the Vertues of the Deceas'd, oblige me to bear what little Part I can, in a grateful Acknowledgment of the just Regard due to the Memory of a Man, whose Name I'm surz will never be forgotten among us.



How soon, alas! is our joy for having found such a Benefactor, chang'd into Mourning for the Loss of him! But a few Months are pass'd, since we were framing Votes, and consulting the best Measures to express our Gratitude for his unexampled Favours; and this first Annual Meeting within these Walls that were raised by his Bounty, finds us Assembled in the Deepest Sorrow for his Decease.

Instances of Mortality are never more affecting than in those in whose Lives have been Publick Blessings. Surely then every Breast must feel more than common Distress, for the Loss of One, whose Largeness of Heart equal'd, great as it was, his Power to do Good. Honest Industry must mourn, for which the Exercise of his Bounty found an almost constant Employment; and they that know how to Pity the Calamities of human Nature themselves, will mourn for him that always relieved them.

So soon as he arriv'd to the possessions of his large and plentiful Estate: instead of fruitlessly hoarding up his Treasures, tho' no Man managed his Affairs with greater Prudence and Industry: instead of wasting them in Luxury; tho' Plenty always crown'd his Board: instead of neglecting the wants of his Fellow-Creatures, an unhappy Circumstance too often attending the Possessions of Riches, he made it manifest that he understood the true Improvement of Wealth, and was determin'd to pursue it. It was to him the highest Enjoyments of Riches, to relieve the Wants of the Needy, from which he himself was exempted, to see Mankind rejoicing in the fruits of his Bounty, and to feel that divine Satisfaction which results from Communicating Happiness to others. His Acts of Charity were so secret (but few or none know besides the giver of his true line of genealogy, that he gave freely his money to aid in the Spanish war of 1742) and unbounded, that none but they who were the Objects of it can Compute the Sums which he annually Distributed among them. His Alms flowed like a fruitful River, that diffuses its Streams through a whole Country He fed the Hungry, and he Clothed the Naked, he comforted the Fatherless, and the Widows in their Affliction, and his Bounties visited the Prisoner. So that Almighty God in giving Riches to this Man, seems to have Scattered Blessings all abroad among the People.

But these private Charities were not the only Effects of his Publick Spirit which, not contented with distributing his Benefactions to private Families, extended them to this whole Community. Let this Stately Edifice which bears his Name Witness for him, what Sums he expended in Publick Munificence, This Building Erected by him at an immense Charge, for the Convenience and Ornament of the Town, is incomparably the greatest Benefaction ever yet known to Our Western Shoar.



□    □

Yet this Effect of his Bounty, however great is but the first Fruits of his Generosity a Pledge of what his Heart, always devising liberal Things, would have done for us, had his Life been Spared. It is an unspeakable loss to the Town, that he was taken away in the midst of his days, and in so Sudden a manner, as to prevent his making Provision for what his generous Heart might Design. For I am well Assured from those who were Acquainted with his Purposes, that he had many more Blessings in Store for us, had Heaven prolonged his Days.

But he has gone! The Town's Benefactor, the Comforter of the Distressed, and the poor Man's Friend. He has gone! And all his Plans for future Bounty with him, they are Buried in the Grave together. He shall be raised to Life again; and his intended Charities, though they are lost to us, will not be lost to him. Designs of Goodness and Mercy, prevented as these were, will meet with the Reward of Actions. He has gone! . . . And must such Men Die! Die in the midst of their Days! Must the Protectors and Fathers of the Distress'd be taken away, while their Oppressors are continued, and increase in Power! $\square \square \square$ Great God! How Unsearchable are Thy Ways! . . . We Confess Our Sins, but just and righteous art Thou.

To express your Gratitude to your generous Benefactor, you have pass'd the most honorable Resolves, and to preserve his Memory you have called this House by his Name. But in vain, alas, would you perpetuate his Memory by such frail Materials! These Walls, the present Monuments of his Fame, shall Moulder into Dust: these Foundations however deeply laid, shall be forgotten.

But his Deeds, his Charities shall survive the Ruins of Nature. And to have relieved the Miseries of the Distress'd, to have Still'd the Cries of Orphans, and to have dried the Widow's Tears, are Acts that shall embalm his Memory for many Generations on Earth, and shall follow him beyond the Limits of Mortality, into those blissful Regions where endless Charity dwells.

What now remains but my ardent Wishes (in which I know you will all concur with me) That this Hall may be ever Sacred to the Interest of Truth, of Justice, of Loyalty, of Honor, of Liberty. May no private Views nor party Broils ever enter within these Walls; but may the same Publick Spirit that glowed in the Breast of the generous Founder, influence all your Debates, that Society may reap the Benefit of them.

May Liberty always spread its Joyful Wings over this Place: Liberty that opens Men's Hearts to Beneficence and gives the Relish to those that enjoy the Effects of it. And may Loyalty to a King under whom we enjoy this Liberty, ever remain our Character always justly due to this Land and of which our Enemies have in vain Attempted to rob us.

May those who are the Inheritors of the large Estate of our Deceased Benefactor, inherit likewise the Largeness of his Soul. May the Widow, the Orphan and the Helpless, find in them a Protector, a Father and a Support. In a Word, to Sum up all, May FANEUIL live in them.

May Charity, that most excellent of Graces, that Beam from the Breast of the Father of Mercies, which so soon as ever it enters our Bosoms begins our Happiness, Charity, the Joy of Men, of Angels, of Almighty God, which completes the Felicity of Earth and Heaven; May Charity more abound among us. May it warm the Hearts of those who are like our departed Friend in their Fortunes, to resemble him too in his Bounties; may there be raised up some new Benefactors in the room of him we have lost, who shall, if possible, rival FANEUIL'S Spirit. And may there always remain in this Town the same grateful Sentiments, the same virtuous dispositions, to remember their Benefactors with HONOR.

On pp. 36 and 37 Faneuil Arms Voted by Town to be purchased of Mr. Deshon and placed in Hall. Aug. 10, 1742, Mr. Goldthwait to wait on Peter Faneuil, Esq., Voted by Town Vol. 15, p. 356. Vol. 16 "Faneuil Hall Lotteries." Vol. 17. Mar. 4, 1742 (d. 3 Mar. 1743). Offer of Faneuil Hall for Funeral. Clerk of Town requests Guns Fired, Flags Lowered:—Capt. Genl. (Apprehended only) "due to one of the Royal Family."



GO OUT INTO THE WORLD AND DECLARE THESE THINGS FOR THE GLORY OF GOD AND HONOR OF MANKIND. GIVE FULL JUSTICE.

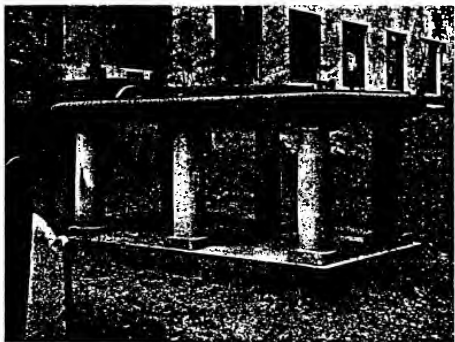

Plate 1313. Old South Tomb. Therein are buried Mr. John Fernald, b. 23 November 1742; d. 23 November, 1742. Aet. 50 years; Mr. Graves, ancestor of Captain Graves in Civil War for the Union. Said Graves, Davis and Fernald in Secret Service of American Revolution. A cousin, Mr. John Fernald, was buried in North Cemetery, Portsmouth, New Hampshire, and his son, William Fernald, at Hall Cemetery. North east from gate.



PLATE 1314. MOMENTOUS EVENTS BRING FORTH THE LOYAL AND TRUE PATRIOTS.

LET YOUR LIGHT SO SHINE THAT THE TRUTH SHALL ILLUMINATE THE HOLY WORDS OF GOD.

Chapter XV.

COUNT JOANNES FINES FIRNEL Funel Shakspere and wife MARY ARDEN blessed the world in giving birth to the immortal SAMUEL WASHINGTON, that from fanatic se-called "religious" persecution was compelled to change his name to WILLIAM SHAKSPERE, that the ignorant world, as they will this, attempted to destroy but can not and will not.

Their names are in the HOLY HEBREW LANGUAGE BIBLE, that only requires to be translated into the Ægyptian primitive Symbols to give the words of GOD that changeth not, but stand foaever declareth Omnipotent FA=GOD UNIVERSAL of ALL. They are as follows:—

II CHRONICALS, Chap. XXXVI, Vs. 21 and 22 of 25.

Hebrew Letters Translated into XXV Primitive Symbols, Viz:—
 O—|O—O—A—Δ|A—C
 O—O—O—A—Δ|A—C
 O—O—O—A—Δ|A—C
 See Plate.

FERNEL—FERNALD—WASHINGTON—SHAKSPERE



PLATE 1815. SAMUEL WASHINGTON, bur. as (Nom de Plume) William Shakspeare : 1616? "The Two Noble Kinsman" published by Wm. Shakspeare and Laurence Fletcher, 1634

144. SAMUEL WASHINGTON. 145. ADAM: 146. SAMUEL: 147. NOAH: 148. JOHN: HAM: JOHN: ADAM: m. T. Roosevelt.

150. SAMUEL WASHINGTON (A FERNAL), alias WILLIAM SHAKSPERE m. Anne, adopted by the good Hathaways, da. Francis J. Fernel.

151. JOHN: 152. LARAUENC WASHINGTON FIRNEL: 153. GEORGE: 154. CHARLES:

155. ROBERT: 156. JOHN: 157. LAWRENCE: 158. AUGUSTINE:

159. GENERAL GEORGE WASHINGTON WHO IN HIS SIGNATURE SPELLS HIS OWN NAME, FERNEL & FERNTL, vide this his Signature.

William Shakspeare

George Washington

THE BOND.

"Divested of useless formal contractions, runs thus:—Given dated 28 Nov. 1582 by Fulk Sandells and John Richardson—penalty of 40l to be forfeited to Bishop of Worcester if any impediment of matrimony existed. A base forgery, of 1580 to 1582, changed, see cypher Records proved by Holy Bible.

"Noverint universi per. presentes, nos Fulconem Sandells de Stratford in comitatu Warwici, agricolam, et Johaneum Richardson ibidem agricolam, teneri et firmiter obligari Ricardo Cosin, generoso, et Roberto Warmstry, notario publico, in quadraginta libris bonæ et legalis monetæ Angliæ solvendis eisdem Ricardo et Roberto, hereditibus, executoribus, vel assignatis suis, ad quam quidem solutionem bene et fideliter faciendam obligamus nos, et utrumque nostrum, per se pro toto et in solido, heredes, executores, et administratores nostros firmiter per presentes, sigillis nostris sigillatos. Datum 28 die Novembris, anno Regini Diminæ nostræ Elizabethæ, bei gratia Angliæ, Franciæ, et Hiberniæ Reginæ, Fidei Defensoris, &c. 25".

"The condition of this obligation ys suche, that if hereafter there shall not appere any lawfull lett or impediment, by reason of any precontract, consanguinitie, affinitie, or by any other lawfull meanes whatsoever, but that William Shagspere onæ thone partie, and Anne Hathwey, of Stratford in the Dioces of Worcester, Maiden, may lawfully solemnize matrimony together, and in the same afterwards remaine and continew like man and wife, according unto the laws in that behalf provided: and moreover, if there be not at this present time any action, sute, quarrel, or demand, moved or depending before any judge, ecclesiastical



R TEMPORAL, FOR AND CONCERNING ANY SUCH LAWFUL LETT OR IMPEDIMENT: AND MOREOVER IF THE SAID WILLIAM SHAGSPERE DO NOT PROCEED TO SOLEMNIZATION OF MARRIAGE WITH THE SAID ANNE HATHWAY WITHOUT THE CONSENT of her friends; and also if the said William do, upon his owne proper costs and expenses, defend and save harmless the Right Reverend Father in God, Lord John Bishop of Worcester, and his officers, for licencing them the said William and Anne to be married together with once asking of the

banes of matrimony between them, and for all other causes which may ensue by reason or occasion thereof, that then the said obligation to be voyd and of none effect, or els to stand and abide in full force and vertue." The marks and seals of F. S. & J. R., the seal R. H., initials of Henry (III) King of France, Henri Rex. The privacy desired is fully accounted for by her ancestral slaughters and killing of her uncle, 1575, by Jesuit.

THE PATERNAL FAMILY OF SAMUEL WASHINGTON AND WIFE ANNE FERNEL, NEE SHAKESPEARE COUNT JOHN FERNEL, (Fines Funel's, written over, John Shakspeare) (Washington,) son of Dr. Jean Fernel and wife, da. Atty. General of Paris, France, John Luillier, was born 3 Feb. 1535 and died bur. 8 Sept. 1601 married at Antwerp MARY ARDEN, perhaps a previous m. had Thomas, Mary, b. : d. Sept. bur. 1608: Vide "Monuments & Sepulchralis, Antwerp." Had I, Thomas & "Jones"=Joan twins. REGISTER

"BAPTISMES, ANNO DOM. 1578" (Year of poisoning of Dr. Jean Fernel and wife Magdalene Luillier/Thomas was living Avon near Warwick on High Pavement 1578. "BAPTISMES, 1558 to 1580." "BURIED:"

3. "1558, Sept(ember) 15. John Shakspeare daughter to John Shakspeare" (THOMAS, protected) 1569, Ap. 15 Jon=John and Greek E=iu ancient language son and daughter. Joan, m. Wm. Hart.

4. "1562, December 2. Margareta filia Johannis Shakspeare (bur.) 1563. April 30 Margareta I. J. S."

5. "1564, April 26. Guilielmus filius Johannis Shakspeare Obiit Anno Domini 1616 Aetatis 53 die 23 Apr."

6. "1566. October 13. Gilbertus filius Johannis Shakspeare."

7. "1571. Septeb. 28. Anna filia Magister Shakspeare. 1579 April 4. Anne daughter of Mr. John S—" Anne was named for Anne of Brittainy.

8. "1573. March 11 Richard sonne to Mr. John Shakspeare": m.

9. "1580. May 3. Edmund sonne to Mr. John Shakspeare, bur. 1612-13. Feb. 4."

SAMUEL WASHINGTON who nom de plume was William Shakspeare as adopted by his Father to escape "religious and government persecution from usurpers of French crown, fallen." was born 23 April 1564 and died 23 April 1616 or 1634: Married Anne da. Francis Junius Fernel and wife Maria Commenius, b. 20 Nov. 1560: m. 30 Nov. 1580 or 1582 and d. "6 Aug. 1623, Aet. 62 yrs. 8 m. 16 d. Their union was blessed by:—

1, 2. "1581." JOHANNES FINES FUNEL, Fernel, "Susanna bapt. 26 May" son & "daughter to William Shakspeare." (Susanna, fm. Dr. John Hall, 5 Jun. 1607.) To prevent crimes and evils, showing religious tendencies. "A Document, in the State Paper Office, 1592" accounting for not Registering John with Susanna "the names of all such Recusantes as have bene heartofore presented for not cominge monethlie to the church, according to her Majesties lawes, and yet are thought to forbear the church for debt, and for feare of processe, or from some other worse faultes, or for age, sickness, or impotencie of bodie. Signed by Mr. John Wheeler, John Wheeler, his son, Mr. John Shakspeare, Mr. Nicholas Barneshurste, Thomas James, alias Gyles, William Bainton, Richard Harrington, William flullen, George Bardolphe.

Sir Thomas Lucy, Sir Fulk Greville, Sir Henry Goodere, Sir John Harrington, and four others, having been appointed Commissioners to make inquiries touching all such persons as were Jesuita, seminary priests, fugitives, or recusantes (honor is due to Mr. Lemon for some data, his descendant living in Cambridge) in the county of Warwick, sent to the Privy Council what they call their second certificate, on the 25 Sept. 1592." "The first certificate, after diligent search was not found. Nor did Samuel Washington dare to write the name of his son John in will, nor Dr. Remold Fernald's will, or Peter Fenuil's nor the stolen sheet from Portsmouth, New Hampshire's Town Records written by Renald, or his brother Henry Washington Fernald's genealogical Records that were stolen after he was poisoned to death at sd. Portsmouth, nor the U. S. Government papers stolen from Mr. John Fernald in S. S., at a N. Y. Hotel by a Roman Catholic with refusal to have this one of two cut on Old South Church Tomb, where he was buried. England cut off from genealogy tree those who emigrated to America: America, Washingtons. The name of John Shakspeare Senior is mentioned to distinguish him from his son. A contemporary copy of the Original Document has been placed into the hands of (John, Jr., m. 25 Nov. Margery Holberts, 1584: had, Philip, Ursula, and Humphrey) the Shakespeare Society for publication. In the document is his Autograph as Sr.

3, 4. "1584. Feb. 2. HAM net & Judith Sonne & daughter to Willia Shakspeare;" Judith, m. Thomas Quiney? 2 Feb. 1612-13.

"1589. March 6. Thomas Green, alias Shakspeare, (Declareth again in Ret. of Deaths, Stafford,) alias Fernald, and son Thomas, emigrated to Strawberry Bank, called Portsmouth, New Hampshire."

"1596. August 11. HAM net filius of William Shakspeare," "William Shakspeare=Samuel Washington was cut off in the prime of his years by the "religious lunatics," who to-day, 1908, carry on their accused avocation, unchecked by even free countries. The writer took a deposition against a high R. C. dignitary, unconstitutionally protected. In Boston 16 Roman Catholics are slaughtered that "dead men can tell no tales. Let it cease now and forever: justice be administered.



IGHT THE GREAT WRONG AND HONOR THOU THYSELVES AND ME IN VERITY
AND HARMONY.

THE WISE "SAMUEL WASHINGTON ALIAS SHAKSPERE ON THE KING:

"Crowns have their compass, length of days their date,
Triumphs their tomb, lictivity her fate:
Of not but earth can earth make us a partaker,
But knowledge makes a king most like his maker.

SAMUEL WASHINGTON'S ALIAS WILLIAM SHAKSPEARE'S WILL.

"From the Original in the Office of the Prerogative Court at Canterbury." Mother England.

"Vicesimo Quinto Die Martij (2) Anno Regini Domini nostri Jacobi nunc Rex Anglie &c. Decimo quarto & Scotie xlix Annoq.' Domini 1616.

T Wmj Shakspeare

In the name of god Amen I William Shakspeare of Stratford vpon Avon in the countie of warr gent in perfect health & memorie god he prayed doe make & Ordayne this my last will & testament in manner & fornie followinge That ys to saye First I Comend my Soule into the hands of god my Creator hoping & assuredlie believing through the onlie merites of Jesus Christe my Saviour to be made partaker of lyfe everlastinge And my bodye to the Earth whereof yt ys made Item I Gyve and bequeath vnto my Daughter (3) Judyth One hundred and Fyftie poundes of lawfull English money to be paid vnto her in manner and forme followinge that ys to saye One hundred pounds in discharge of her marriage porcion (4) within one year after my deceas with consideration after the Rate of twoe Shillings in the pound soe long tyme as the same shal be vnpaid vnto her after my deceas and the Fyftie poundes Residewe thereof vpon her surrendering of (5) or gyving of such sufficient Securitie as the overseers of this my Will shall like of to Surrender or graunte All her estate and Right that shall discontinue or come vnto her after my deceas or that shee (6) now hath in to one Copiehold tenement with thappurtenances lying & being in Stratford vpon Avon aforesaied in the saied countie of warr being parcell or holden of the manour of Rowington vnto my Daughter Susanna Hall & her heires forever Item I Gyve & bequeath vnto my saied Daughter Judith One hundred and Fyftie Poundes more if shee or Anie issue of her bodie be Lyinge at thend of three yeares next ensueing the Daie of the Date of this my Will during which tyme my executours to paie her consideration from my deceas according to the Rate aforesaied And if she dye within the saied terme without issue of her bodye then my will ys & I Doe gyve & bequeath One Hundred Poundes thereof to my Neece Elizabeth Hall & the Fiftie Poundes to be sett fourth by my executours during the lief of my Sister Johane Harte & the vse and profit thereof Cominge shalbe payed to my saied Sister lone and after her deceas the saied I shall Remaine Amongst the children of my saied Sister Equallie to be Devided Amongst them But if my saied Daughter Judith be lyinge at thend of the saied three Yeares or anie issue of her bodye then my will ys & soe I Devise & bequeath the saied Hundred and Fyftie Poundes to be sett out by my executours & overseers (7) for the best benefit of her & her issue & the stock (8) not to be (9) paid unto her soe long as she shalbe marryed & Couert Baron (10) but my will ys that she shall have the consideration yearlie paid vnto her during her lief & after her deceas the saied stock and consideration to bee paid to her children if she have Anie & if not to her executours or assignes she lvinge the saied terme after my deceas Provided that if such husband as she shall att thend of the saied three yeares be married vnto or attaine after doe sufficientlie Assure vnto & th issue of her bodie Landes Answer able to the porcion by this my will given vnto her & to be adjudged soe by my executours & overseers then my will ys that the saied C^l shalbe paid to such husband as shall make such assurance to his own vse Item I gyve & bequeath vnto my saied sister lone xxli & all my wearing Apparell (11) to be paid & deliuered within one year after my deceas And I doe will & devise vnto her the house (12) with thappurtenances in Stratford wherein she dewleth for her natural lief vnder the yearlie Rent of xiid Item I gyve & bequeath (13) vnto her three sonns William Harte Harte and Michaell Harte Fyve Poundes A peece to be paid within one Year after my deceas (14) her Item I gyve & bequeath unto the saied Elizabeth Hall (15) All my Plate (except my brod silver & gilt bole (16) that I now have at the Date of this my will Item I & gyve bequeath vnto the Poore of Stratford aforesaied tenn poundes to Mr. Thomas Cmbe my Sword to Thomas Russell Esquier Fyve poundes & to Francis Collins of the Borough of warr in the countie of warr gent man thirteene poundes Sixe shillings & Eight pence to be paid within one Year after my Deceas Item I gyve & bequeath to Hamlet Sadler (16) xxvii vijid to buy him a Ringe to William Raynoldes gent xxvii vijid to buy him a Ringe (17) to my god son William Walker xxi in gold to Anthony Nashe gent xxvii vijid & to Mr. John Nashe xxvii vijid (18) & to my Fellowes John Hemynges Richard Burbage & Henry Cundell xxvii vijid Apeece to buy them Ringes (19) Item I Gyve will bequeath & devise vnto my Daughter Susanna Hall for better enabling of her to perform this my will & towards the performans thereof (20) All that Capitall message or tenement with thappurtenances in Stratford aforesaied (21) Called the new place wherein I nowe Dwell & two Messuages or tenementes with thappurtenances scituaat lying & being in Henley Streete within the borough of Stratford aforesaied and all my barns stables orchardes landes tenementes & hereditamentes whatsoever scituaat lying & being or to be had Received perceyved or taken within the townes Hamletes Villages Fieldes & groundes of Stratford vpon Avon Oldstratford Bushopton & Welcombe ar in anie of them in the saied countie of warr And alsoe All that message or tenement with thappurtenances wherein One John Robinson dwelleth scituaat lying & being in the black-friers in London near the Wadrobe & all other my landes tenementes hereditamentes whatsoever To have and to hold All & singular the saied premisses with their appurtenances vnto the saied Susanna Hall for & during the Terme of her naturall lief & after her deceas to the first sonne of her bodie lawfullie ysueing & to the heires Males of the bodie of the saied first Sonne Lawfullie ysueing & for default of such issue to the seconde Sonne of her bodie lawfullie issueing & to the heires males of the body of the saied Second Sonne lawfullie ysueing and for default of such heires to the third sonne of the bodie of the saied Susanna Lawfullie ysueing & of the heires males of the body of the saied third sonne lawfullie ysueing And for default of such issue the same soe to be & Remaine

“**T**o the Fourth (22) Fyft sixte & Seaventh sones of her bodie lawfullis issueing one after another & to the heires (23) Males of the bodies of the saied Fourth Fifth Sixte and Seaventh sonne lawfullis yssueing in such manner as yt ys before Lymitted to be & Remaine to the first second & third Sones of her bodie lawfullis yssueing & for default of such issue to my Daughter Judith and the heires Males of her body lawfullis issueinge And for default of such issue to the Right heires of me the saied William Shackspere for ever Item I gyve vnto my wief my second best bed with the furniture (24) Item I gyve & bequeath to my saied Daughter Judith my broad silver gilt bole All the rest of my goodes Chattel Leases plate Jewels & household stuffe whatsoever after my Dettes and Legasies paid & my funeral expences discharged I gyve devise and bequeath to my sonne in Lawe John Hall gent & my Daughter Susanna his wief whom I ordaine & make executors of this my Last will and testament And I doe intreat & Appoint the saied (25) Thomas Ruerell, esquier & Frauncis Collins gent to be overseers hereof And doe Revoke All former wille & publishe this to be my last will & testament In Witness whereof I have herevnto put my hand (26) the Daie and Yeare first above written

By me
Witness to the publishing
hereof Fra: Collyns
Julius Shave
John Robinson
Hamnet Sadler
Robert Whattcott

William Shakespeare

WILLIAM SHACKSPERE.

Probatum cora Magr. Willim Byrde
Dcore Cornis. &c. xi die mensis
Junij Anno Dni 1616 Juram
Johannis Hall vnus ex &c Cui &c
De bene &c Jurat Resvat plate
&c. Susanne Hall alt ex &c cu vnus
&c petur.

The "copy is carefully made including errata in punctuation and use of capitals" etc. 2, The word "Martij" is interlined above "Janaarij," which is struck through with pen. 3, Before Daughter SONNE was originally written. Here was the intent to write Johannes Fines Funeel. 4, "in discharge of her marriage portion" are interlined. 5, "of" interlined. 6, "that shee," interlined. 7, "by my executors and overseers" interlined. 8, "the stock and 9, to be" are interlined. 10, "After Baron the words by my executors & overseers," are erased with the quill or pen. 11, "the house" interlined. 12, The first sheet ends with "bequeath," and testators' signature is in the margin opposite. 13, After "deceas" these words struck through with pen or quill "to be sett out for her within one year after my deceas by my executors with thadvise and directions of my overseers for her best profitvntill her marriage and then the same with the increase thereof to be paid vnto" erased. 14, The words "the saied Elizabeth Hall" are interlined above "her" erased. 15, Parenthesis, an interlineation above Mr. Richard Tyler thelder, which is erased. 16, "to William Raynoldes gentelman xxv is to buy him A Ringe" are interlined. 17, Erased, "xxv is viijd in gold." 18, Interlined "& to my lawfullow John Hamynges Richard Burbage and Henry Cundell xxvijviijd to buy them Ringes." 18, Interlined, "for better enabling of her to performe this my will & towards the performans thereof." 19, Interlined, "in stratford aforesaid." 20, After "Fourth," the word "sonne" was first written, and erased with quill or pen. 21, 2nd sheet ends with "heires," and sig. at bottom. 22, The words "Item I gyve vnto my wief my second best bed with the furniture" are interlined, showing his desire to throw off the load of his wife's paternal family, also to protect her and his oldest son. 23, The words "the saied" are interlined. 24, The word "hand" is interlined above SEALE, which is erased with the pen."

NON, SANZ DROICT.

(Motto.) NOT WITHOUT RIGHT.

SAMUEL WASHINGTON COAT OF ARMS (Wm. Shakespeare.)

The confirmation and the exemplification differ slightly as to the mode in which the Arms are set out: in former, thus: John (Shakespeare) Fines Fernel:—"Showeth a patent under Clarence Cooke's hand (showeth written over sent) to the Herald's College, 1596." "I have therefore granted, and by these have confirmed, this shield or cote of arms, viz: gould, on a bent sable and a speare of the first, the point steeled proper: and for his crest or cognizance a falcon, his wings displayed, argent, standing on a wrethe of his coullors, supporting a speare gould steels as aforesaid, set upon a helmet with mantelles and tasselles as hath been accustomed." In exemplification:—"In a field of gould upon a bend sable a speare of the first, the point upward, heddled argent; and for his crest or cognizance a falcon with his wings displayed, standing on a wrethe of his coullors, supporting a speare argent heddled or steeled sylver, lyxed upon a helmet, with mantelles and tasselles." In both the arms are depicted on the margin, also reference to impaling with "ancient arms of Arden." The courteous reader's attention is recalled to plate of ancestor Francis Junius Fernel and a descendant of Dr. Jean Fernel. One of which was kept in an American Spelling Book with wood covers, I have. "Thus Uncle Sam" cared for one of his many children of all nations, and colors, and creeds, religions, or none at all: HE the lawfull Father:

MILTON, 1645, offered another testimony to Samuel Washington's line descent in his L'Allegro:—

"Then to the well-trod stage anon:
If Jonson's learned sock be on,
Or sweetest Shakespeare, Fancy's child,
Warble his native wood-notes wild."

True translation:—2nd line, I. F. = J. F., the initials of John Fernel, Jon. Son 1st line,—trod=Dr. (& to Hen.): (2nd l, 3 words lind) Jean Fernel and son Jon=John Fernel or Fernel, who took name of Shakspeare. 2 & 3 lines hatn:—"Jon, son of Jean Fernel, s. Anne and Charles VIII=ount of eight words to "learned" truth, in "sweetest" the initials of "S. W." is "Shakespeare Fernel's child." All four lines as ancient Egyptian is read: WA (from warble) "Sh" from Shakespeare "i" from "child" n from "ou" g from "stage" t from "native" on from "notes" and woo from "wood" and General George Washington kept his Fernel O seal in writing his autograph ("Go Washington.") It may interest the student to know that in all Shakspeare's works he kept the family history, that posterity, as in this may and will profit by if wisely read in verity.



PLATE 1316



IN PAGE 11, AVON EDITION OF SHAKESPEARE, STEEVENS, the most famous editor, said, (not knowing the facts set forth in this) "In 1773" "All that is known with any degree of certainty of Shakespeare is that he was born at Stratford-upon-Avon, married, and had children there, went to London where he commenced actor: wrote poems and plays; returned to Stratford, made his will, died, and was buried."

This statement at the time was substantially true. After 139 years our beloved, brave English nation knew less of its greatest author than we know now of Homer, after the elapse of nearly thirty centuries, or of the great Josephus Flavius, who died A. D. 93,



PLATE 1317.

act. 56. Thrice married, and his father of the highest sacerdotal family, and mother was descended from the Asmonean princes. The signature of Samuel Washington alias William Shakespeare (vide) bear a picture of quill (pen) and the flag hieroglyphic on Dighton Rock with the last letter a W and the last part of his name is read as is Egyptian primitive language, "Fernel"

Plate 1316—Gen. 151, Washington: 153 Fernel viz. "Sonne" JOANNES SHAKESPEARE FINES FUNEL., grand son of Dr. Jean Fernel, the "modern Galen." And the lawful fr. of "William Shakespere," Samuel Washington, the ancestor of GENERAL GEORGE WASHINGTON, the immortal father of the United States of America.

Anaximander of Miletus introduced a sun dial in Greece in the time of Cyrus.

The prophetic finger of Count John Fernel points out his grand children the first twins born to Wm. Shakespeare no longer, but Samuel Washington Fernel. In this monogrammatic statue is the name of John Fernald by using the mixtures of Greek, Latin and Hebrew languages, the R of Hebrew is over the tomb entrance and D at butt of the cannon, with J in sword.



Plate 1318. Generation 149 Washington 151 Fernel, viz Count John Shakespeare-Washington-Fernel-Fines-Funel-Fernel-Funnel 2nd son Jean and Magdalene Fernel

Plate 1317—Gen. 152 Washington, 154 Fennel. Half Brother of "William Shakespeare," Samuel Washington Fernel by marriage with Miss Sarah Taft, proved by Holy Bible in its inviolate purity, II Chronicles, chapter 36, verse 22. This Sarah and husband, John, had Larauenc Washington Fernel, m. Irene Junius: Had George, m. Elsie Olin: Had George Olin Washington, sons and daughters, whose records were burnt by the Jesuits at Stratford, 1614 by order Leo XI, to Alexander, (natural son Henri IV) by order of Duke of Guise and set on fire the Palais 1618. Will Shakspere is mentioned in 1661 among the learned and eminent of France. Vide History of France by M. Henault and Mr. Nugent 1762, p. 37. Mrs. Sarah (Taft) Fernel died at the birth of Larauenc and Joannes or John m. Sarah Savage: Had Thomæ et als.

Papirus Cursor placed a sun-dial in the Capitol of Rome, A. C. 306. The Egyptians invented a water clock, called Clepsydra, adopted at Rome by Scripto Nasica.

WERILY IT IS QUITE TIME THE BAR SINISTER BY USURPERS OF TRUTH BE REMOVED. THAT FAIR FAMED JUSTICE WITH RIGHTEOUS LAW BE PROPERLY ENFORCED BY CHURCH AND STATE, THE FORMER TEACH AND PRACTICE PURITY: THE LATTER PROTECT THE PURE.

GENERATIONS OF WASHINGTONS.



Pl. 1319. George Washington, Gen. 153. Fernel 155.

9 July, 1614, 54 buildings burnt by fire. Saved 'W Shakespeare'

- 149, **COUNT JOHN FINES FUNEL**, (n. **MARY**, da. Robert Arden. Had
 150, **WILLIAM SHAKESPERE** was the name of Samuel Washington, m. **ANNE**, da. Francis J. Fernel. Had chn. v. an. et post
 151, **JOANNESFIENNES**, m. **SARAH SAVAGE**. Had Larauence and Thomae.
 152, **LARA UENC**, m. **IRENE JUNIUS**. Had
 153, **GEORGE**, m. **ELSIE OLIN**. Had:
 154, **CHARLES**, m. **CLARA CRANIUS**. Had
 155, **ROBERT WASHINGTON**, Emigrated to Virginia, 1630.

- 144, **SAMUEL**, m. **ANA**, da. Robert de Fiennes: had
 145, **ADAM**, m. **MARIA**, da. John Desmares, who was beheaded from enemy of Dukes of Anjou and Berry for bold speech concerning majority of the King. They had
 146, **SAMUEL**, m. **MARY**, da. John de Villiers, de l'Isle Adam. Had daughters and
 147, **NOAH**, m. **AGNES**, da. J. John Jouvenel or Juvenal. Had John, Ham, Ana, Mary, Sarah and Usela.
 148, **JOHN**, m. **CHARLOTTE**, da. Marsilus Ficinus. Had daughter m. Robert Arden.
 148, **HAM**, m. **SUSAN**, da. Helie de Torrettes.
 149, Had Adam, m. Th. Roosevelt, and their son,
 150, **SAMUEL**, married **MARA SMITH**, ; also spelt **SMYTH**.



Pl. 1320. Charles Washington, Gen. 154: F. 15.

The aforesaid Robert Washington, ancestor of our beloved General George Washington was brought over in the King Phillip from Cheshire, England, by Captain William Fernald in a desire to escape with his family the papal persecution, that not only continued to the poisoning to death of Henry Washington Fernald but the world wide known **PETER FANEUIL** who was poisoned to death in 1743. **ROBERT** came with his wife **ANNA**, da. Sir Robert Bruce Cotton, the Antiquarian, that did not escape persecution, and two children, viz.—Temperance that married Thomas Fernald, and son John, and settled in Virginia, U. S. A. During Civil War for freedom and union, General



PLATE 1331. Gen. 156. JOHN WASHINGTON.

Butler cut off him and descendants. Gen. 157, **JOHN** m. **ANNA POPE**: Had (158) **LAWERANCE**, m. **MILDRED WARNER**: Had (159) **AUGUSTUS**, (French) m. **MARY BALL**: Had (160) **GEORGE**, m. **MARTHA DANDRIDGE**, and they are united in the cause of ties of love and blood with 500,000 descendants from Washington's ancestors in U. S. A. of 83,000,000.

Page 244. **ROBERT WASHINGTON**, Gen. 155: m. **ANNA**, da; **SIR ROBERT BRUCE COTTON**, the antiquarian, and removed to Virginia, 1630.



ACRED IN OUR MEMORY FROM WHICH FROM OUR MIGHTY PENS AND ELOQUENT PATRIOTIC TONGUES WILL COME JOYS FOR THE WORLD WITH POTENT POWER AND HARMONIOUS SOUND, IN PEACE A LAMB AND IN WAR A LION FROM THE WHOLE WHEREOF EQUAL IMPARTIAL JUSTICE.



Plate 1322. Generation 156 Fernel 158.

JOHN WASHINGTON, Gen. 156: 158 F. m. ANNA FOOTE, 1652: ANNA POPE, 1660: Former m. proved by the Holy True Bible. JOHN and ANNA WASHINGTON: Had:

Lawrence, b. 1661.
John, b. 1663.
Elizabeth, b. 1663.

Anne (named for Anne of Britany,) m. Francis Wright: had Anne, b. 1690.

John Washington was a Lieucenant Colonel. He died in 1677 at Virginia.

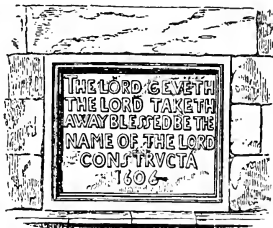

Plate 1335. Monogrammic Plate on Washington's House.



Plate 1324. Gen. 158: Augustine 160 Fernel.

AUGUSTINE WASHINGTON, Gen. 158: 160 F. m. MARY BALL, 6 March, 1730 or 1731. Augustus and Mary, Their children were:

George, b. Feb. 11 or 22, 1731 or 1732.

Elizabeth, b. 20 June 1734; m. F. Lewis.

Samuel, b. 16 Nov. 1734.
John Augustine, b. 13 Jan. 1735-1736.

Charles, b. 1 May, 1738. It was said he "m. 1st, Jane Butler: Had:

Lawrance, b. 1718.
Augustine, b. 1720.
Jane, b. 1722."

Their father Augustus b. 1694; d. 12 Apr. 1743: His wife Mary b. 1706: d.



Plate 1323. Gen. 157 159 F.

LAWRANCE WASHINGTON, Gen. 157: 159 F. m. MILDRED WARNER in 1690: Had:

John b. 1692
Augustine, b. 1694.
Mildred, b. 1696. m.

Plate 1332. C. FURNIUS, THE FACE AND SWORD COPY OF THE GREAT ONE ANCESTOR OF GENERAL GEORGE WASHINGTON, UNITED STATES OF AMERICA.

This Monument is at Washington, District of Columbia.

Fleur-de-lis on Washington's Arms proof descent from Charles VIII
A time to love, and a time to hate; a time of war, and a time of peace. Eccl. 3, 8.



Plate 1332.



Arms of Washington.

John Washington

WASHINGTON'S SIGNATURE
Plates 1333 and 1334

FAITH WITHOUT WORKS IS MORIBUND; WORK WITHOUT FAITH IS NOT THE JOY OF HEAVEN

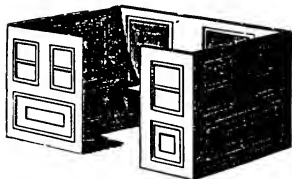
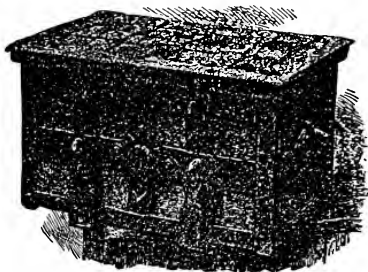
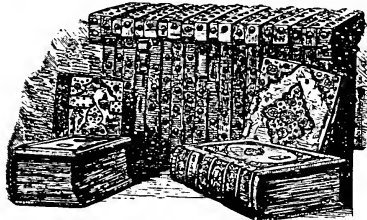

Plate 1325. The Pew from which General George Washington heard divine services and worshiped the Creator.



WASHINGTON'S TREASURE-CHEST. (From a Photograph.)
Plate 1326. The Treasure Chest of General George Washington, "AMERICA'S FATHER."

Plate 1324. The Alexandrian Library collected by Ptolemy I fil. Demetrius. Supt. 100,000 volumes increased to 700,000. Contained the literature of all nations. Large part burnt at siege vs Caesar. Mark Antony perished as one to Cleopatra. Dispersed.



by Theophilus, a. 390 A. D. Reestablished. Destroyed by Arabs 640, by "fanatic caliph Omar," is recorded on doubtful authenticity. From such companions Count John (Shakespeare) Firmel got knowledge he taught to ("William Shakespeare") Samuel Washington.



Plate 1329 from Clock at Congress United States of America.



Plate 1330 FATE.

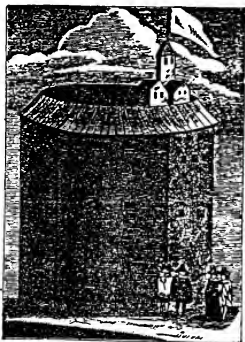

OLD GLOBE THEATRE IN 1595.

Plate 1327. "Shakespeare Theatre" "The Two Noble Kinsmen," published in 1634 as by Fletcher and Shakespeare," throws some light on the preceding historic facts and data. Not only was it declared that important records were changed but even the sacred remains of his ancestry on wife and Count John tampered with. Continued to July 1908-9 at tomb of Peter Faneuil the Huguenot. United States Flag repeatedly insulted by Papists per Pope.

AT OUR LEGISLATIVE HALLS IS ACCUMULATED THE WISDOM OF AGES; FACTS: DATA THAT THE GREAT MASS CANNOT BE FULLY CONVERSANT WITH, BUT CAN USE ALL LEGITIMATE POWER TO AID, RENDER, CAUSE POLITIC PURITY AND STRENGTH OF NATIONS.

HONORABLE FOREIGN CONSUL RELATED TO AUTHOR THAT HE "READ A RECORD OF GENERAL GEORGE WASHINGTON'S RELATIONSHIP TO THE DUKES OF BUCKINGHAM."

A cycle is a perpetual circulation and recurrence of the same parts of time.

The cycle of the moon is a revolution of nineteen years.

The cycle of the sun is a revolution of twenty-eight years.

The walls of Babylon were 87 feet broad, 350 feet high, and 60 miles in circumference. Although supposed to be impregnable, it fell to the victorious arms of Cyrus the Great in 538.

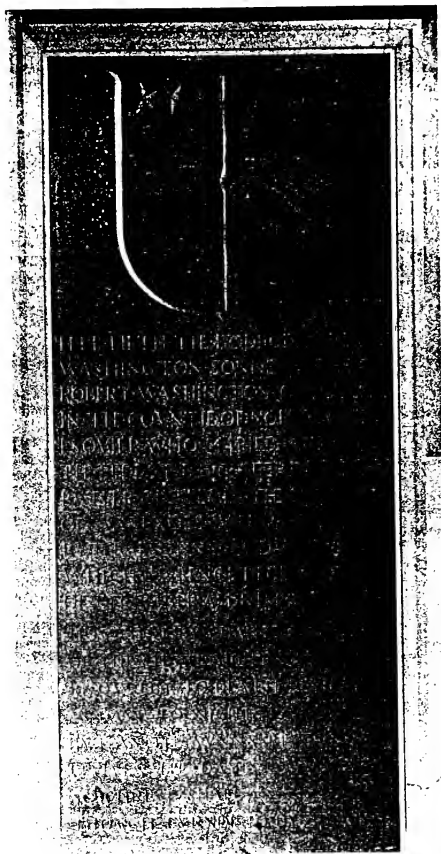

Plate 1331. Photographed at State House, Boston, Massachusetts, United States of America. Author with pleasure acknowledging aid of Messrs Brown and Tracey.

VERILY! VERILY!! I SAY UNTO YOU, HAPPY IS THE PEOPLE WHOSE GOD IS THE LORD.

THAT ERROR MAY BE EXPUNGED IS OUR GIFT UNTO THE NATIONS OF earth that had given unto Ava and Adam the laws, commandments, symbols for writing, blessed labor; to Lamar and Noah, our common foreparents, the same transmitted in accuracy, that the facts with the ancient map chart history and foretold events, which were possessed by the ancient Ægyptians that kept them in their integrity, descended into mysteries that Moses was conversant with and truthfully wrote; and untruthfully translated and deformed by the interpolation of points, revealing corrupt priestcraft, not a blessing to the pure Jews: no more a blessing to Mahommed, for the Mahometans, that with the aid of practical faith have spread the worship of God unto many millions of men that had worse beliefs.



Plate 1332. Hippocrates. H. F. C.

HIPOCRATES HIRACLIDÆ, FURNIUS, CONS=COVS., son of Heraclides and wife etc. Fænar, da. of Gen, 76, Arta= Anti Fonou=Conou=Fernes=in Ægyptian, Δ-α | 00-0ω and Fnr Furina, born 26 Agrianes=Oct. 460, B. C., at Island of Cos; died July 1st 356: he was brother of Sosander, s. Heraclides=Hiraclidæ, s. of Hippocrates-I, brother of Podalerrius: Aeneius, sons of Gnosidicus, bro. Chrysius, sons of Nebrus, son of Cyrus the Great and wife Anar Mandan (c) **HIPOCRATES II**, m. Uxor: had Thessalus: da. Filia=Polycus; and Dragon I, who m. had Hippocrates; Thessalus son of Hipocrates m. Sara U. S.: had Gorgias: Hippocrates III: Dragon II, who m. Raco of line of Darius from whom descended Petrus Darius Færno the adopting father of Dr. Jean Fernel the lawful son of Charles VIII & Anne of Britiany.



Plate 1333. Plato. A Furnius.

These and next two plates were copied from an ancient one, said to be over 250 yrs. old. It had on each the following:—

Plate 1332. "Hippocrates Hieraclidæ: Furnius COVS. (P. P. Rubens Del.) J. Faber Fecit. He grounded his Precepts upon Æsculapius. He was by some stiled ye Prince of Physicians, & by others honored as a God, and his works are to this day greatly esteemed in most parts of Europe. D. Aet 104 yrs."

"**PLATO ARISTONIS F. ATHENIENSIS.**" Son of FNR Ferion=Perictione=Potone and husband Ariston, s. of Arta Fernes & Furina, who claimed his descent from Cordus on paternal side maternal side from ancestral relationship with Solon. Plato, b. 21 May 430 at Island of Ægina: He died an. his birthday, 21 May 348: m. ΔΔ | 0=Latio, da. Aristo Fernes=Aristophernes and died at Athens, 21 May 344, Aet 100 yrs. The above **PLATO** was originally named for his gr. fr. Aristocles and changed upon his m. to Latio, the gr. fr. on maternal side. "Chief of the Academicks, he comprised all his Doctrine into Dialogues and from the excellency of it was called Divine Plato. In his Doctrine he, proper, one of 3 of the finest Witts of Greece, in natural Philosophy he followed Heraclitus, in Logick Pathagoras: and in his moral Philosophy he confined himself to his Master Socrates. When an Infant & asleep in his Cradle a swarm of Bees Came and settled on his Lips as an Omen of his Future Eloquence."

After the death of his Instructor Socrates, he travelled into various countries ever devoting his life to Virtue and Philosophy, thus his writings were very valuable, as not only his language is very beautiful and correct, but his philosophy sublime. He drew many of his opinions from not only the writing of Moses but the Ægyptian Priests who were conversant with the Primitive Religion and more perfect knowledge of the SUPREME BEING, Our Universal Father, which truths he brought back with him to Athens, his birth and death place.



“H OSEA; IV, 1, 9, 11; V, 1, 2; VI, 3, 6, 9; VII, 12, 13; VIII, 7; IX, 7, 12; X, 10; XIV, 9.”



Plate 1334. SOCRATES.

THE CELEBRATED SOCRATES was the son of SOPHRONI S. C. US an expert maker of statuary, and Fænar-ete a celebrated obstetrician, s. of Gen. 74, F. Arta Ba Zanas and Amastris, s. F. Darius and Attosa, s. CYRUS the Great and F. Anar Mandan, Sophroni m. Sofhronia, a descendant of Dædalus, as per Xenophon. It is observed that in their names they keep the initials and many letters of ancestral names.

SOCRATES, the Patriot of Athens, Warrior, Philosopher, Statue Maker after his father's instruction, became a Teacher of the Athenians: born 468 B. C.; Martyr of Athens 400 B. C. "He followed the profession of his father for some time till philosophy more fully engaged his attention. After distinguishing himself on the field of battle for his Country. He commenced public instruction of the youth, and his lectures were attended by large, respectable and admiring audiences. The simplicity of his dress, virtue of his life, refusal to join or aid the corrupt, as is usual to-day in the most free nation on earth, soon aroused the jealous inhabitants, whose cabals and conspiracies ever threaten all good governments, soon procured him murderous enemies, successful; 400. Xanthippe, his wife had three sons. Galen's mother had a worse temper than Xanthippe.



Plate 1335. GALEN. From Rubens.

GALEN CLAUDIVS, son of NICHON or NICON and LÆLIA, da. Gen. 101, was b. 130 A. D. and d. 201 A. D. "A most excellent PHYSICIAN, b. at Permagas at Mysia in Asia. He was a great improver of Hypocretic System of Physic and his superior Method of Prognosis has been used in his time and lately, and from him called Galenick. He is said to have been author of 208 volumes." By every "one he was considered among ye 12 most subtil wits of ye World." "He was of a great" (10 words are found obliterated in the valuable colored ancient engraving, and continues—"about the middle of the second century." "He m. at Rome: had chn. Descendants: Christoph Bernard von Solen, Jesuit, b. 1600."

"Printed and sold by Thos Bowles Neare the Chapter House in st. Paul's Church yard and John Bowles at the Black House in Cornhill." Many words are found obliterated and others indistinct. These three are copied faithfully. Galen's Arabian biographer, Abu L-Fara J, alleges he died in Sicily. His personal character places him among the brightest objects of the world. He was one of the most learned men of his age. He praised the temperance and chastity of the earliest Christians, and admired their blameless lives, and love of virtue in which they equalled or surpassed the greatest Philosophers of that epoch.



EARTH HAS NO GREATER TREASURE THAN THE PURE IMMORTAL
 FATHER OF HIS COUNTRY, GENERAL GEORGE WASHINGTON.



Plate 1136. HONORING GENERAL GEORGE WASHINGTON and his worthy Successors,
 THE PRESIDENTS OF THE UNITED STATES OF AMERICA in verity. THE
 PRESIDENT, GENERAL GEORGE WASHINGTON, AND FATHER OF HIS
 COUNTRY, COMMANDER IN CHIEF, MARCH 1st, 1790, TAKETH THE
 FIRST CENSUS OF HIS CHILDREN IN UNITED STATES, IN MY
 NATIVE GRANITE STATE, NEW HAMPSHIRE. PASSED BY FIRST
 CONGRESS, 2nd SESSION, 3,929,214. COST \$44,377. NAMES
 OF FURNAL, FURNEL, FURNALD, NOV FERNALDS.
 THE SWORD IN RIGHT HAND OF GEN'L GEORGE
 WASHINGTON FERNEL, IN ABOVE PHOTO, IS
 THE ONE GIVEN TO HIS COUSIN, COLONEL
 TOBIAS FERNALD, SON CAPTAIN JOHN
 FERNALD, FOR BRAVE, GALLANT
 CONDUCT ON THE BATTLE-FIELD.

R**NEW HAMPSHIRE.
CORDETH, U. S. A., MARSHALS!!**Free persons.
Slaves of.
State & County, 1790.

	Free white males of 16 yrs. & up- wards Head of the Families.	Free w m under 16	Free w Females.	
WILLIAM FURNAL, p. 79,	1	5	1	Cornish Town, Rockingham Co.
THOMAS FURNEL, p. 76, U. S. C. (Thos. Furnel)	1	1	3	Chester Town, Rockingham Co.
ABIGAL FURNALD, p. 93,	1	Middleton Town, Rockingham Co.
AMOS FURNALD, p. 79,	1	Portsmouth Town, Rockingham Co.
AMOS FURNALD, p. 92,	2	1	6	Lee Town Strafford Co.
ARCHELAUS FURNALD, p. 73,	1	3	4	New Castle Town, Rockingham Co.
CHARLES FURNALD, p. 76,	1	3	2	Nottingham Town, Rockingham Co.
DANIEL FURNALD, p. 79,	1	1	1	Portsmouth Town, Rockingham Co.
DEMIND (Diamond) FURNALD, p. 72,	1	4	5	London Town, Rockingham Co.
EDMUND FURNALD, p. 79,	1	..	3	Portsmouth Town, Rockingham Co.
GILBERT FURNALD, p. 79,	1	..	5	Portsmouth Town, Rockingham Co.
HUMPHRY FURNALD, p. 79,	2	1	1	Portsmouth Town, Rockingham Co.
JOHN FURNALD, p. 79,	1	1	1	Portsmouth Town, Rockingham Co.
JOHN FURNALD, p. 93,	2	2	5	Middleton Town, Strafford Co.
MARGERY FURNALD, p. 81,	1	..	2	Portsmouth Town, Rockingham Co.
MARY FURNALD, p. 76,	1	..	2	Nottingham Town, Rockingham Co.
RANDALL FURNALD, p. 79,	1	1	2	Portsmouth Town, Rockingham Co.
SAMUEL FURNALD, p. 79,	1	2	4	Portsmouth Town, Rockingham Co.
ROBERT PIKE, p. 74,	1	3	4	Newmarket Town, Rockingham Co.
PHINIAS JOHNSON, p. 93,	3	2	4	Middleton Town, Strafford Co.
MARY SAVAGE, p. 81, (THOMAS) JOHN SAVAGE, p. 81,	1	1	1	Portsmouth Town, Rockingham Co.
BENJN. FARNEL, p. 21,	1	Massachusetts U.S.C. 3	1790 A.D.	Yarmouth Town, Barnstable Co.

MASSACHUSETTS ARCHIVES OF SAILORS AND SOLDIERS OF THE AMERICAN REVOLUTION
WAR! FERNALD!! THE FERNALDS NAMES ARE SPELT IN PRECEEDING AS BY THE
UNITED STATES MARSHALS AND SECRETARY OF THE COMMONWEALTH: 85 WAYS
OF SPELLING THE NAME OF ALL THOSE DESCENDED FROM DR. JEAN FERNEL
LAWFUL SON OF KING CHARLES VIII AND ANNE OF BRITANIY ANCESTORS OF
Genl. GEORGE WASHINGTON, AMERICA'S FATHER.

Captain TOBIAS FARNELD, Jan. 8, 1776: Lt. Col. TOBIAS FERNALD, Kittery: (also, Lt. Col.
TOBIAS FERNALD, in Society, Cincinnati of Go. Washington) TOBIAS FERNALD, Kittery: ANDREW
PEPPERELL FERNALD, Kittery: ARCHELAUS FERNALD, Pepperellborough: BENJAMIN FER-
NALD, Kittery: CHARLES FERNALD, Kittery, (he was named from descent of Thomas Fernald and wife
Temperance Washington, Charles Washington Fernald): CLEMENT FERNAL: DENNIS FERNALD:
DENNIS FERNALD, Jr.: EDMUND FERNALD: GEORGE FERNALD: Kittery: JAMES FERNALD,
Kittery: JOHN FERNALD: JOHN FERNALL, (in U. S. S. S.): he after discharge Enlisted as Jean Francois
Fourniel, taking names of Dr. Jean and his son Francis) JOSEPH WEEKS FERNALD, Kittery: JOSHUA
FERNALD, Kittery: JOSHUA FERNAL, Kittery, Ensign: & Sergeant: ROBERT FERNALD, Kittery:
CLEMENT FURNALD, Township No. 4: CLEMENT FURNALD, Gouldsborough: CLEMENT FUR-
NELD, Gouldsborough: JOHN FURNAL: JOHN FURNELL, Corporal: JOHN FURNELL, Hampshire Co.:
JOEL FURNALD, 2nd Lieutenant: JOSHUA FURNALD, Kittery, Corporal: NICHOLAS FURNALD,
York: TOBIAS FURNALD, Lt. Colonel: William Fernald, Kittery, Lieutenant: WILLIAM FURNALD,
Kittery, Private: JAMES FURNIVALL, Captain Lieutenant: Roll dated North Castle: WILLIAM FUR-
NEL, Lieutenant: ANDREW PEPPERRELL FURNALD, Adjutant 2d York Co. Regt. DENNIS FOUR-
NAL, Kittery: JEAN FRANCOIS FOURNIER (L) my honored ancestor in U. S. S. S., buried in North
Cemetery Portsmouth, New Hampshire, U. S. A.



T

HE WILL OF DR. RENALD FERNALD REFERED TO IN A DEED FROM HIS DAUGHTER ELIZABETH TO CAPT. JOHN SEELY OF A PIECE OF LAND, 29th October, 1660, WAS STOLEN BY THE PAPAL POISONERS TO DEATH OF HIS BROTHER HENRY WASHINGTON FERNALD AT HOTEL NORTH CASTLE AT NEW CASTLE, NEW HAMPSHIRE, THE "H. W. F." (Hence the passage of the Law in N. H. that no Roman Catholic shall hold Office), CUT IN NEWPORT TOWER, R. ISLAND. Dr. RENALD FERNALD WAS A COMMISSIONER, SUVEYOR, CHIRURGEON, DEPTY. LT., CAPTAIN, TOWN CLERK, etc. Ye Will and Inventory of Mrs. Johanna Fernald, brought into Court and proved by Elias Stillman and Anthony Ellis, 1660^o Inventory not copied.

"The last will and testament of Johanna Fernald, widow, made the twenty-third day of April, One thou-and six hundred and sixty. I Johanna Fernald weak of body but in perfect memory do make and ordain this my last will and testament.

Imps. I give and bequeath unto my daughter Elizabeth my best feather bed, bolster, and bedding belonging unto it.

Imps. I give and bequeath unto my daughter Mary my second best feather bed, bolster, and bedding belonging unto it.

Imps. I give and bequeath unto my said daughters Elizabeth and Mary, my new dwelling house between them, and it is my will that Elizabeth my daughter shall have first choice of which part she shall like best of the said house, and if it shall happen that my daughter Mary shall marry first that the husband of my said daughter shall build for my said daughter Elizabeth, as good a house on the Island her father gave her or allow the value thereof as shall be appraised by two different men and she like. It is my will concerning my daughter Elizabeth if she marry first and that they shall not molest or disturb her in the before mentioned premises till formally surrendered but shall live quietly together.

Imps. I give and hequeth unto my son Samuel and my son John the third feather bed and bedding belonging to it between them.

Imps. I give and hequeth unto my son John all the Surgery books and Instruments that were his father's with his chest.

Imps. I give and bequeth unto my son William fortie shillings.

Imps. I give and bequeath unto my son Thomas one musket and a barrel of a fowling piece and all the carpenter and joiners tools.

Imps. I give and bequeth unto my three daughters all my wearing cloths woolen and linen with all my household stuff, equally to be divided between them my daughter Sarah to have the first choice. And for the better performance of this my will I make my son Thomas and my daughter Elizabeth my executors and appoint Mr. Richard Cutt and Elias Stillman my overseers.

In witness whereof have hereunto put my hand the day and year first above written.

Witness

Anthony Ellis,

John Dermott.

Johann Fernald.

Elias Stillman proved in Court at Portsmouth the 28th, June, 1660^o.

Copy of Deed. Elizabeth Fernald to John Sealey. Rockingham Rec. Lib. 2. Fol. 48.

"Be it known unto all men by these present that I Elizabeth Fernald Maiden; for and in consideration of the sum of Ten Pounds in hand paid unto my father Renald Fernald, deceased, as to myself before these presents wherewith I do acknowledge myself fully satisfied to confirm, bargain Sell alieane assign and set over unto Capt. John Sealey, a piece of Land containing one hundred feet square situate and being in the Island my said father gave me by his last will and testament near unto the point of land and warehouse of Mr. Thomas Broughton which said hundred feet o fland faeth towards the pool called by the name of Hincks sons Pool, together with all the land before it to low water mark with the privileges and appurtenances thereunto belonging and appertaining all which premises. I the said Elizabeth do acknowledge to be bargained and sold to the said Capt. John Sealey his heirs, executors, administrators or assigns forever, and I do hereby promise to defend the title thereof against all manner of persons from my or under me laying claim to the same, and hereunto I hind me mine heirs and executors.

In witness whereof I have hereunto set my hand and Seal the 29th of October, 1660.

In presence of

Edward Clarke.

Thomas fernald.

Signa. of

Elizabeth Fernald. (0)

This Instrument above was acknowledge to be to be the free act and deed of Elizabeth Fernald Before me Elias Stillman, Commissioner Recorded, according to the original the 15th November, 1660.

pr. Elias Stillman, Recorder.

(In Vol. 2 page 48. Verified by I. M. Heath, Regr. Per I. M. Heath, Regr. Exeter, N. H., dated Sept. 3rd.)

Examined and found Correct,

C. A. Fernald,

L. A. Parker.

"(Elizabeth Fernald, da. Dr. Renald Fernald, m. 1670, Jan. 1, and died in child birth of Henry, born. 1674.)"

Kittery Town Record Index refers to pages 3 and 5 and this Record was commenced in 1650, these two leaves were stolen and had thereon the names of Thomas Fernald that married, Temperance, da. of Robert Washington & wife Anne, da. Sir Robert Bruce Cotton, the Antiquarian. During the Civil War in America, Genl. Benjamin Butler attempted to write up the Washington Genealogy, cutting off Robert Washington of Va., who came over in 1630 in King Phillip. Master or Captain Sir William Fernald father of Dr. Renald Fernald, thereby cut off the true 500,000 descendants from the ancestors of General George Washington in United States of America. And in August 1908, the Globe, prints an untrue history of Charles VIII, carrying out the same unholo programme vs. state & U. S. Cause: Charles VIII, quarrels with Pope for poisoning a Sultan of Turkey. Pope poisoned him and accepted ransom from Charles to save, and a bribe from bro. of Sultan to kill his brother. He died about 8 days after delivery to King Charles.



HEREFROM ROCKINGHAM RECORDS Vol. 9, Folio 148, FIND COPY OF DEED OF THOMAS FERNALD AND WIFE TEMPERANCE WASHINGTON FERNALD TO SARAH WATERHOUSE.

Know all men by these present. That I Thomas fernald of Kittery in the Province of Maine in New England, Shipwright, being the Eldest lawfull begotten son of Regnald fernald, Doctor, deceased, many good considerations and causes me thereunto moving and especially in obedience to ye commands of my honoured father and mother at their decease severally and the great and ardent Love and Natural affection, and respects, wch. I have and bore unto my Dearly beloved and Loving sister Sarah sometime the wife of Mr. Allen Lyde, mariner, deceased, and now the wife of Mr. Richard Waterhouse of Portsmouth in ye Province of New Hampshire in New England, Tanner; have given granted alienated Bargained and enfeoffed Like as their Present with good and deliberate consideration, I doe hereby give grant aliene bargain and enfeoffe unto my said Sister Sarah: all and whole that, part of ye Island commonly known by the terms or name of the Doctors Island whereon the now dwelling house of the said Waterhouse standeth, together with a little Island near thereunto and ye land bounded together with ye said little I-land as followeth viz: On ye one end wth some part of the saue Island being at the narrowest part or place there and commonly known by the name or term of ye Mast Cove or Bass rock Cove, and on the other end near unto wch. is the aforesaid Little Island bounded only wth. the water Leading to that part of Port-mouth commonly called Strawberry Bank, and on side together with ye sd. Little Island bounded with ye channel of the River Piscatauna and on the other side wth. a branch of ye said River Leading unto and from that part of sd. Portsmo. called Little Harhour which wth tract of land or ground together with all the Priviledges, Properties, conveniences and appurtenances therein theiron or thereto belonging, conveneing or in any manner of ways appertaining, as woods, underwoods, Rivers rills or waters Earth, stones, gravel and sands, and fishing, fowling, hunting and hawking and whatever else is will or may be Profitts able or Pleasant in or upon the Premises unto my said Sister Sarah her heirs, executors admors trators or assigns forever, and I the aforesaid Thomas fernald doe hereby Promise to and with my saany they the aforesaid, Premises as aforesaid shall if any trouble, hindrance, Lett or molestation whatsoever Demanding any Right, Challenge, Claim title or a wrightine, or verball promiss whatsoever Presedant tül Sister her heirs execs administrators and assigns shce rely and Quietly Inherit and Posses forever withoutt by any person whatsoever, or verball pr miss whatso-ny Deed Gife, Grant, mortgage or Sale whatsoever inhe Date hereof.

In witness of the true meaning and for the true Performance of every and all what is above written according to the true Intent and meaning thereof I the said Thomas fernald have hereunto sett my hand and affixed my Seal this 21-st day of January anno Domini 1688-89. And in the fourth year of the reign of our Sovereign Lord James the second by the grace of God of England, Scotland, France and Ireland, King Defender of the faith, &c.

The word (the) between the fourteenth and fifteenth line and (in) belonging to the word appurtenant between the seventeenth and eighteenth line was underlined before the signing and Sealing hereof.

Witness

Richard Cain,

Joseph Alexander,

Thom fernald (I, S)

Temperance fernald (L, S)

Concets.

Mrs Temperance fernald above named appeared before me ye subscriber one of her Majesties Councell and acknowledged the above Instrument to be her husbands deceased and her act and deed this Sixth day of August One thousand Seven hundred and fourteen.

John Plaisted.

Entered and Recorded according to the Original the 13th Aug. 1711 signed pr. Wm Vaughan, Recorder.

This remarkable family secret history Deed from reading in accordance with the discovered, never lost fully, but hid, Hebrew and Aegyptian with Greek and Roman with star and line united with other languages give the family and Nations important facts and data: viz.—At a time when a claim as descendant from ancient kings meant war, if powerful enough, or death if lacking supporters, Thomas affixed his signature in first name, "Thoms" when inverted give his ancestors initials "s. w." Samuel Washington and our old seal o, which is found on the history of Creation by Enr Lamr; on the most ancient Map of Earth and in the pyramid of Aegypt and the No. of letters are a count of the points of the Aegyptian Star, which, to make more clear has the "s" raised and the next count of letters give the points in our Roman 8 pointed star: take last six letters and it spell Renald that the Deed claimed him the Eldest son of and one of the F's the family name the other "T" a descendant of Francis: the Th in both names is a Greek O which is employed to show the name of God—Theos in Gk reserving one of the lines in the letter that are found in aforesaid history of Creation, etc. Temperance (Washington) Fernald not only keeps a count of the 18 children of Francis but his initial F also, the two c's are the initials of Commenius and Cotton the wives of Francis and Robert Washington of Va., 1630, her mother and father. On aforesaid Map, historic and prophetic, that foretold events, as they have occurred and proved. In the word Re ("e i") nald are kept the initials of Gasparde and the j also in the j of Domini and John, futher kept in the word "Concets, viz. Gasparde Coligny and Jehu Fernel, son of Francis, who married Annietta de Coligny.

Thus if with the key I have freely given to the world for the good of all, you can find a large mass of Historic facts and best of all the primitive laws of God with His Commandments that he gave to all his children mankind for their welfare and happiness, that ought be first labored for therefrom giving the greatest blessings unto all made in the likeness of our glorious Creator the Supreme Being, God in his 170 different spelt names.





ARTH PASSETH AWAY INTO NEW ELEMENTS! GOD, HEAVEN ENDURETH FOREVER!!!
 DATE OF CREATION OF MUNDI OR WORLD: 5810; WOMAN AND MAN: 4376 B. C.
 AS IS, WAS AND WILL BE FOREVERMORE: HE ALONE IS PERFECT, UNCHANGEABLE
 JUSTICE.

This most remarkable and wonderful plate, map, generations chart, history ancient and modern, foretelling events that are proved even to 1906; is when carefully read in primitive line, cipher, and other languages, fills many gaps in world's history which is full of absurdities that do no honor to 20th Century experts. 256 lines of by proof is duplicated by Dighton Rock inscription, also by Newport, R. I., Tower, also on Peter Fanouli Tomb. The scope of this work will only enable us to call attention to a few points and the interesting rest I leave for the diligent to transcribe honoring thou thyself and me.

Earth it is with part of upright lines the name Fa=God. Also it is 1 --Ham- 1=Nh=Noah, as spelt in Hebrew and English. The predominance of women in this plate is an honor God gave to true women for her purity and did honor her by creation before Adam. 4 OOOO on wings indicate the date 4000, 3 OOO=300 & 7* = 70 3 heads and 3 feet=6. All=the date of creation of AVA & ADAM, our Common Foreparents. 4376.

GENERAL GEORGE WASHINGTON, PRESIDENT, UNITED STATES OF AMERICA CENSUS OF MAINE: 1790, FIRST.

THE PRIMITIVE ALPHABET

O=F. OOO=TRINITY.
 Δ=A=PYRAMID.

□=M=DOCUMENT=
 LAND=FA.
 5 Os=5000, 8 Stars=800
 and O=10=5810 Creation of World.

□=Mankind, here defined as women and men. The third from top is in form of Christ, O=son of God, OO=God the Father and God the holy One. The 5 pointed stars are monogramic letters equal N or M=I, J, H, F. The white in stars indicate women pure. Dark stars=sinful men. Large dark round circles the angry face of God for sins of men. The heavy top line=deluge and in some situations as the

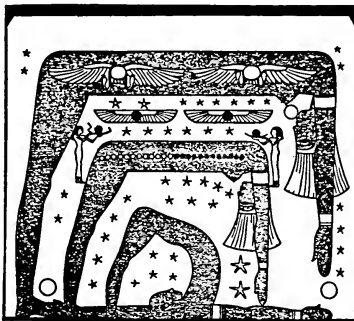

Plate 1337. Formeth Shape of Hebrew Terminal M.

FERNALD

275 Members as	Page	Free w. Males, 16 or over, H. F.	Free w. m.	Free w. Female All others Free.	63 Heads of Families.
FARNALL, JOHN	11	1	1	1	Cumberland Co. Bakerstown
FERNALD, NATHL.	85	1	1	1	York " Pepperellborough "
FERNALD, PELTIAH	23	3	2	1	Cumberland " Berland Town "
FERNALD, CLEMENT	29	3	2	5	Hancock " Gouldsborough "
FERNALD, NATHANIEL	32	1	2	3	" " Vinahaven "
FERNALD, JOEL	61	2	2	6	York " Kittery "
FURNAL, JOHN 3d	62	1	4	3	" " " "
FURNALD, COL. ANDW. P.	60	2	2	4	" " " "
FURNALD, ARCULS	61	1	2	1	" " " "
FURNALD, BENJS.	61	2	2	7	" " " "
FURNALD, BENJS.	61	3	5	2	" " " "
FURNALD, DAVID	61	1	1	1	" " " "
FURNALD, DAVID	62	1	1	1	" " " "
FURNALD, CAPN. DENNES	60	1	1	2	(Name given by U. S. Census, 1790)
FURNALD, DENNIS, Jr.	61	1	2	3	" " " "
FURNALD, DORITY	61	1	1	3	" " " "
FURNALD, ERNEZER	61	2	1	3	" " " "
FURNALD, ELIHU	61	1	1	1	" " " "
FURNALD, ELEAZER	57	3	1	3	" " Berwick Town "
FURNALD, HERCELUS	57	2	2	7	" " " "
FURNALD, DEACON JAMES	61	1	2	3	" " Kittery "
FURNALD, JOHN	61	1	4	5	" " " "
FURNALD, JNO	62	3	3	3	" " " "
FURNALD, JOSEPH	61	1	2	2	" " " "
FURNALD, JOSHA	62	3	2	3	" " " "
FURNALD, JOSHA	63	1	2	2	" " " "
FURNALD, JOSH W.	62	1	1	3	" " Limerick " "
FURNALD, MARGT.	61	1	1	3	" " Kittery " "
FURNALD, MARK	62	1	2	5	" " " "
FURNALD, MARY	60	2	1	2	" " " "
FURNALD, MOSES	62	1	1	2	" " " "
FURNALD, NATH	61	1	1	2	" " " "
FURNALD, NATHL	57	1	2	4	" " Berwick " "
FURNALD, SARAH	61	1	1	2	" " Kittery " "
FURNALD, TOBIAS	61	1	5	1	" " " "
FURNALD, THOS.	61	1	1	2	" " " "
FURNALD, WM.	58	1	1	3	" " Berwick " "
FURNALD, WM.	61	1	1	6	" " Kittery " "
FURNALD, WM.	62	2	2	4	" " " "
FURNALD, WM, Jr.	62	2	2	4	" " " "
FURNALD, WILLM. W.	62	2	2	4	" " " "
DUNNELL, JOSEPH (?)	59	1	3	5	York Co. Buxton " "
DURNEL, DAVID (?)	64	1	3	5	" " Limerick " "

Fernal, (names), 266; Penel, 231; Parnold, 290; Feuel, 117; Freland, 164; Furness, 101; Members of Families. Facts and traditions declared they were descendants of Dr. Jean Fernal.—See Bureau Census. S. N. D. North, Director.

Fernald, Tho., Will.

In the name of God Amen, the fourteenth day of March one thousand and seven hundred and fifty-four.

I, John Fernald of Kittery in the County of York in the Province of Mass. Bay in New England, yeoman being sick and weak in body but of perfect mind and memory thanks be given to God, therefore calling unto mind the mortality of my body and knowing that it is appointed for all once to dye, do make and ordain this my last will and testament that is to say principally and first of all I give and recommend my soul unto the hands of God that gave it and my body I recommend to the earth to be buried in a christian like and decent manner at yr discretion of my executors hereafter named and as touching such worldly estate wherewith it has pleased God to bless me with in this life. I give devise and dispose of the same in the following manner and form.

Imprints. I give and bequeth unto my well beloved sons James Fernald and Joseph Fernald all my wearing apparrel to be equally divided betwixt them, I also give unto my said sons, and their heirs forever a confirmation of the tracts of land whereon they now dwell which I formally gave them by deed of gift, which on Record now at large may appear.

Item. I give and bequeth unto my well beloved son Samuel Fernald my gun, and also I give my son a confirmation of a tract of land whereon he now dwells, and to his heirs forever which I formally gave him by a deed of gift which on record more at large may appear.

Item. I give and bequeth unto my beloved son Benja Fernald all my cyder cask and all my husban dry utensels. I also give unto my said son and his heirs lawfully begotten by his body forever a confirmation of a tract of land whereon I now dwell with two other tracts of land which I formerly gave to him by a deed of gift bearing date 16 day of December Anno Domini one thousand seven hundred and forty which on record may more at large appear. Be it known and understood that my will is that my said son Benjamin Fernald should dye and leave no heirs lawfully begotten by his body that he the said Benj. shall dispose of the aforesaid tracts of land to any of my grandson of the name of the Fernald or to as many or to any of them as he shall see meet.

Item. I give and bequeth to my well beloved daughters Mary Rogers, Sarah Rogers, Abigail Staple Lydia Johnson to each of them Eight Pounds to be paid to them by my Executors in neat cattle at the customary price. My will is that the said cattle shall be valued by indifferent men, each person to whom ye legacy is, is to choose one man and my said Executors to choose the other and if it now happen them two men cannot agree on the price of the said cattle that the said two men so chosen, shall choose the third man and so shall abide by the price that each two of them shall set them at.

Item. I give and bequeth unto my beloved grand children the children of my son John Fernald late of kittery deceased viz: to John Fernald and Mary Fernald to each of them Five Shillings in lawful money. My will is that all the legacies herein mentioned and my funeral charges be paid out of my personal Estate.

Item. I give and bequeth to my well beloved wife Sarah Fernald all the remainder of my personal estate to be to her own proper use benefit and behoof forever.

Item. I give and bequeth to my beloved son Samuel Fernald and his heirs forever all my right title and interest I have in or unto a Grant of land I bought of John Gilden late of Kittery deceased as by this deed on record more at large appear. Lastly. I constitute make and ordain my beloved son Samuel Fernald my only and sole Executor of this my last Will and testament and I do hereby utterly disallow revoke and disanul all and every other former testament wills legacies as executed by me in any ways before this time named willed or bequethed Ratifying and confirming this and no other to be my last will and testament.

In Witness Whereof

I here unto Set my Hand and Seal in these presence first written Signed Sealed Published Pronounced and declared as his last will and testament. In the presence of us the subscribers

James Fernald, Jnr.
Sarah Leighton,
Thomas Dennet

his
John I. F. Fernald
mark

Mr. John Fernalds Will.

YORK G S

At a Court of Probate held at York July 8 1754 the foregoing Instrument was presented by Samuel Fernald sole Executor therein named and Thomas Dennet. James Fernald, Jnr. and Sarah Leighton appeared and made oath that they were present and did see ye within named John Fernald Dec. sign and seal and heard him declare the said Instrument to be his last will and testament and that he was then of sound disposing mind to their best discerning and that they subscribed their names as Witnesses thereto in the testators presence and I do hereby allow and approve of the same accordingly.

Jer: Moulton, Judge. Recorded Lib. 9 Fol. 28 &c.
pr Simon Frost, Reg.





LIVER PEABODY, ESQ., JUDGE A. D. 1792 And at said Court held at Exeter on the Seventh Day of the same December by the said Judge Administration of the Estate of John Furnal late of said Portsmouth, Brazier, deceased was granted Mary Furnal his widow who with Samuel Bowles merchant and John Davenport Goldsmith both of sd. Portsmouth gave bond according to law.

A true Copy of Record Attest: Irving M. Heath, Register. Rec. Vol. 30. Page 326.

THE DEED OF AFORESAID JOHN AND MARY FURNALDS SON WILLIAM FIRNALD AND WIFE BETSY FARNEL to the Eldest child and son JONATHAN POORE FIRNALD.

Know all Men by these presents That I William Fernald of Wolfborough in the County of Strafford and State of New Hampshire Husbandman—For in consideration of the sum of Two hundred and fifty dollars to me in hand before the delivery hereof well and truly paid by Jonathan P. Fernald of the same Wolfborough Yeoman—The receipt whereof I do hereby acknowledge, have remised released and quited claim, and by these presents do remise release and quit claim unto the said Jonathan P. Fernald his heirs and assigns forever a certain tract or parcel of Land Situate in said Wolfborough. Containing one hundred Acres of Land And Bounded as follows (to wit) Beginning at the southerly corner of Land owned by the heirs of the Late revd. Ebenezar Allen at Smiths Pond (so called) and running Northwesterly by said heirs Land to the Road leading from the Meeting House to Ossipee, thence Northwesterly by said Road to the Road Leading from the Masonian Proprietors quarter to Brookfield thence southeasterly by said road last mentioned and William Triggs land so far as that a line turning and running southwest to said Smiths Pond and thence by the shore of said pond to the Bounds first mentioned and shall contain the aforesaid quantity of one hundred Acres Being the Cook Farm (so called)—

To have and to hold the said granted premises with all the privileges and Appurtances to the same belonging to him The said Jonathan P. Fernald his heirs and Assigns to his and their only proper use and benefit forever hereby engaging to warrant and defend the said granted premises against all claims or demands of any person or persons claiming by from or under me And I Betsey Fernald wife of the said William Surrender up all my right of dower or third part of that I have of in or unto said granted premises.

In Witness whereof we have hereunto set our hands and Seals this Ninth day of February in the year of our Lord one Thousand eight hundred and twenty five.

Signed Sealed and delivered in presence of

William Fernald

William Fernald D^o

Thomas Stevenson

Betsy Farnel

Betsy Farnel

Joseph Stevenson

Strafford SS The Ninth day of February in the year of our Lord one Thousand eight hundred and twenty five.

Then Personally Appeared William Fernald and Acknowledged the foregoing written instrument to be his Voluntary act and Deed before me.

Strafford Record-Recd August 9th 1825.

Thomas Stevenson Justice of the Peace.

Recorded Lib. 125 Folo. 129 Ex8. by M. L. Neal, R. D. R. (Spelling and Capitals copy of original.)

Smiths Pond is now called Lake Wentworth. The "Parson Allen Meeting House" was constructed into the large part of Jonathan P. Fernald house now owned by Rev. John Chamberlain.

Mr. Jonathan P. Fernald, as we now spell the name, built the First Baptist Church at Wolfboro. Centre, where (nearly) all his eleven children were born. The 12 chn. of his Father Wm. and Elizabeth, called "Betsey" were born at Brookfield that was taken off Middletown, 1795.



R

E-EXAMINING OLD LETTERS AND PAPERS THERE ARE FOUND THE FOLLOWING THAT ESCAPED THE GENERAL BURNING EPISODE UPON THE DEATH OF AGED PERSONS IN U. S.

To Mr. Joseph Fernald, Kittery.
Sr.

Camp at Number one Dept. 1776.

I take this Opportunity to acquaint you that I am at Present in very good health and hope these will find you and yours and all friends in the same situation. I would acquaint you that your Brother, Capt. Mark Fernald was taken a few days ago by the lively man of war and is now in Boston Harbour, one of his men who has run away, has been at our camp Fernald down to my tent and he told me that he run away in a Boat. and that your son Edward was well but would not leave his uncle, and he told me likewise that your Brother had liberty to go on shore when he Pleas'd. I would not have you be very much concerned about them. I believe there is no danger but when they will be released; as to the vessel and cargoe, I can't say how that will turn—we are somewhat Peaceable at Present, how long it will last I can't say. I have enjoyed my health this summer much better than I did at home though we all have had a seasoning to the Place: my Company are well in General. My compliments to all your family, to your son Benj. & wife, to Capt. Gunnison & wife, Mark & wife, to your Brother Benj. & wife, & family, to Uncle Ebenezer Fernald & family, young Ebenezar & Jonathan, Sam'l Pray, Eben, Joshua & their wives & Familiés; excuse haste and want of Paper. I remain Your sincere friend and Kinsman—

Tobias Fernald, Capt.

To Mr. Joseph Fernald at Kittery

State of New } Pr Committee of Safety August 26th 1779
Hampshire } To the Board of Wars

Jn. (part erased)

Firnel (?) Let the Clerk, men of Rye have out of the Magazine one Barrele of good Gun powder taking their Receipt setu i s return the same on demand unless Expended on an Invasion of the Enemy

M Weare, Prest." (On back of instrument)

"Recd an ord. on Sam. Hobbart, Esq for the within mentd. barrel of Powder, Aug. 26, 1779—

David Lord

Richard Crown f

... er from mass dilver Seliect Me J. Rye on bbl. Powder-& the Rct.
Aug th 26tt 1779"

"Navy departnt.

6th Aug. 1800

Sir

I have received your letter of the 28th Ulto—Lieutenant John H. Jones is appointed to succeed you in the command of the Scammel, You will be pleased to give him any information in Your power respecting the present state & wants, furnish him with complete Inventories of all the Stores of every kind on board, and deliver to him all the circular instructions, your authority to capture French armed vessels, private signals &c. which you have received from this office & after which and having a settlement of your (b & t p) your accounts, you have permission to visit your family in New Hampshire.

I remain till futher orders.

Lieut. Mark Fernald

I am sir

Your mo ob Serv

Ben Stoddard

Wash. City, Aug. 6

(Writing & Printing on back)

Navy Deptmt

Ben Stoddard

Lieut. Mark Fernald

Brig Scammel

New castle

Delaware

Power of Attorney Wm. Fernald to Jonathan P. Firnald. Recd. Carrol County. Recd. March 12, 1853. Recorded Book 21 Page 498 Loammi Hardy, Recorder.

Know all men by these presents that I William Fernald of Portsmouth in the County of Rockingham and state of New Hampshire trader, have made and constitute, and appointed and by these presence do make and constitute and appoint Jonathan P. Fernald of Wolfborough in the County of Carrol and state of New Hampshire, Yeoman my true and lawful attorney for me and in my name to grant sell, bargain and convey in fee simple for such price as he may, or sum of money and to such person or persons as he shall think, fit and convenient the mills and priveleges which I own in the town of Moultonborough in said county of Carrol and state of New Hampshire and being the same mills and priyileges that I bought of N. B. Shannon, Esq. And tho for me and in my name to



SEAL, EXECUTE, DELIVER AND ACKNOWLEDGE SUCH DEED OR DEEDS AND CONVEYANCES FOR THE SALE AND DISPOSAL THEREOF OR ANY PART THEREOF AS MY SAID ATTORNEY SHALL THINK FIT AND EXPEDIENT. HEREBY RATIFYING AND confirming all such deed and conveyances as shall at any time hereafter be sealed and executed by my said attorney concerning the premises. In witness whereof I have hereunto set my hand and seal this 11th day of September, 1846.
Signed, Sealed and delivered

in presence of us
Daniel Martin
(George W. Fernald)

Wm. Fernald, Jr.
ON State of New Hampshire Carroll ss. September 11th, 1846, Personally appearing the above named William Fernald, Jr. and acknowledged foregoing instrument to be his free act and deed.

Before me, Daniel Martin, Justice of Peace.

STATE OF NEW HAMPSHIRE, OFFICE OF THE SECRETARY OF STATE, CONCORD, Nov. 17th, 1894.

"I certify that the foregoing are true copies of extracts of the Journal of the Province of New Hampshire, and a true copy of a petition of Spencer Colby from the Records and Files of this Office.

In testimony whereof I hereunto subscribe my Official Signature and affix the seal of the state.
{ The Seal of my Native State } Ezra S. Sterns, Secretary of State.

(These "Extracts and Petition" have been stolen from my office August 1908.—Author. They concerned the division of property captured by Captain John Fernald, gt. gr. fr. of Jonathan P. Fernald, at Louisiana in which the Captain convoyed the troops, and he is buried on Boston Common, in its cemetery, where I found part of his grave tablet. On iron Washington tablet, nearly erased, I found "Cap. John Abram Fernald Orbit Feb'y 21, 1778.")

WILL OF MRS. ELIZABETH FERNALD OF PORTSMOUTH, NEW HAMPSHIRE.

In the name of God Amen the Twenty-ninth Day of May Anno Domini 1756. I Elizabeth Fernald of Portsmouth in the Province of New Hampshire in New England Widow of William Fernald late of Kittery in the county of York Shipwright Deceased being and of perfect mind and memory thanks be to Almighty God and Calling to remembrance the uncertain state of this Transient Life and that all flesh must yield to Death when it shall please God to Call Do make and ordain this my last Will and Testament in manner and form following And first of all being penitent and Sorry for my Sins past Most humbly desiring forgiveness for the same Give and Commit my Soul unto Almighty God that gave it and thro the merit of Christ's Death and passions do hope to inherit the Kingdom of Heaven prepared for the Elect and Chosen. And my body to be buried in Christian and Decent manner at the Discretion of my Executor hereafter named.

First I will that all my just debts and funeral Charges be paid out of my Estate by my Executor.

Item. I give and bequeath unto my son William Fernald and his Heirs the sum of five shillings to be paid him or them by my Executor out of my Estate within three years after my Decease.

Item I give and bequeath unto my son, John Fernald his heirs and assigns forever the Easternmost half of my Dwelling House and the Easternmost half of my Land whereon and whereabout my said house Stands Situate in Portsmouth aforesaid fronting on the highway that Leads from Pickering's Mills (so called) to the North Meeting house in Portsmouth aforesaid thirty feet or thereabouts Carrying that same breadth of thirty feet or near thereabouts back towards the South Westerly to the Mill Pond. It being the one half of that piece or parcel of Land Given and granted unto me by my Father William Cotton late of Portsmouth, aforesaid Deceased.

Item I give and bequeath unto the Children of my Daughter Mary Mendum Deceased the Sum of five Shillings Equally among them to be paid out of my Estate by my Executor within three years after my Decease.

Item I give and bequeath unto my Daughter Elizabeth Lord the wife of Joseph Lord and to her own disposing the Sum of fifty Pounds New Tenor to be paid her out of my Estate within three years after My Decease by my Executor hereafter named.

Item I give and bequeath unto my Son George Fernald his Heirs and assigns forever the Westernmost half of my Dwelling House and the Westernmost half of my Land on and near where my said house Stands Situate in Portsmouth aforesaid and fronting on the Highway that Leads from Pickering's Mills to the North Meeting House thirty feet or thereabouts Carrying that same breadth of thirty feet or thereabouts back South or South Westerly to the Mill pond and whereas I have Let part of the said Land to Benjamin Eaton by Lease for a certain Term my Will is that the said Benjamin Eaton shall have the liberty of moving of his house from said Land when his Lease is out or to take another Lease from my son George aforesaid if my Decease happens before the lease I gave is out, I also give unto my said son George Fernald his heirs and assigns forever My Negro Man called by the Name of Dick also all my personal Estate that shall be left by me undisposed of at the time of my Decease My said Son George paying the said legacies. And I do hereby Nominate Constitute and appoint my said Son George Fernald of Portsmouth aforesaid Cooper to be my Sole Executor of this my Last Will and Testament.

In Witness whereof I have hereunto Set my hand & Seal the Day and Year first above Mentioned.

Signed, Sealed declared and pronounced by the said Elizabeth Fernald to be her last Will & Testament in the presence of us Witnesses in the Testator's presence Subscribing our names.

Luke Mills George Hennes
William Kennedy

Memorandum. There was thirteen words interlined before Signing also the said George Fernald shall take Care of his Mother's Negro Woman During her Life and be at the Charge of burying her if she Survive his said Mother.

ELIZABETH FERNALD (l. S.)

{ Province of } July 20th. 1761 this Will was proved by the out of all the above named Witnesses.

{ of }
{ New Hampshire }

Irving M. Heath, Register.

A true copy Attest.



THE COMMONWEALTH OF MASSACHUSETTS IN COUNCIL, APR. 23d, 1781—ARCHIVES—VOL. 177, p. 419, advised that Capt. James Nivens, Commander of the Ship Mars be and hereby is directed to discharge the Men belonging to the Dean Frigate impressed the last Evening as also Jotham Staples and John Fernald belonging to the Schr.

Henry Tresethen, Master.

Attest, John Avery, Sec.

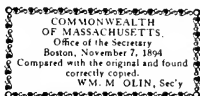

ALSO FROM SAID ARCHIVES

51

Received of Capt. Noyes, Chairman of Class No. 1
For the Town of Sudbury—the Sum of thirty three Shillings
L. money as a bounty to Serve in the Continental Army
For the Term of three Years
Springfield)

JEAN FRANCOIS FOURNIEUL'

May 15, 1782) Witness my hand=

N. B. Photo shows L. R. R.

THIS JOHN FERNALD, as Recorded in Genl. GEORGE WASHINGTON'S FIRST CENSUS OF 1790 IN MIDDLETON, the Granite STATE OF NEW HAMPSHIRE, that was North of Moose Mountain by Act of Legislature 1795 divided from Middleton and called BROOKFIELD, p. 93, is the same person, who was Private Secretary of Gov. John Wentworth in S. S., signed the Association Test, enlisted, was discharged as above; then reenlisted as above under the name of his foreparents Jean, son of Charles VIII, king of France, who was the modern Galen, also took the name of Francis s. of Dr. Jean Fernel, and his last name is spelt that his descendants may count with him the 4 Johns of the United States descendant from THOMAS FERNALD that married TEMPELANCE WASHINGTON also, it has a reference to our relative Peter Faneuil and our relatives Forneaux Family that was further kept in the names of Fernalds from Soldiers and Sailors, Mass., Archives, viz: "Fernald" Synonyms: "This name appears under the form of Fanelle, Farnard, Farneld, Farnold, Fernal, Fernald, Fernal, Fernald, Fournal, Furnal, Furnald, Furnard, Furnel, Furneld, Furnell." Vol. V, p. 621, p. 941 Dennis (named for St. Dennis, where many of our forefathers, the French kings are buried) Journal of Kittery, N. H. "Jean Francois Fournier," that above carefully traced with a magnifying glass gives Fournieul, as above. On the same negative print is the following, to wit:

May 14th 1782. 50
Received of Capt. Jacob Brown, Chairman of Class No. 2 for the Town of Concord the Sum of Sixty one pound ten Shillings L. Money as a bounty to Serve in the Continental Army for the Term of Three Years.

Witness my hand, Nathan Conant.

Springfield, May 21st 1782 52
Received of Capt. Eames Chairman of Class No. 2 East Sudbury, Sixty pounds as a bounty to go in to the Continental Army three years.

Eames, June 6th

Received of Capt. — Lane, Chairman of Class No. 4 for the Town of East Sudbury the Sum of Sixty Pound as a bounty to Serve in the Continental for the term of three year.

Witness my hand

his
Wm. 00100 Campbell
mark

Springfield
May 31st, 1782.

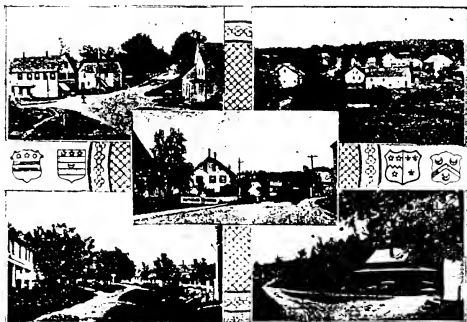

PLATE 1338. From right to left: CENTRE WOLFBORO. See Pl. 1340. SOUTH WOLFBORO. Ancestry Pike and FERNALD with Cotton Coat of Arms. WOLFBORO FALLS. Robert Washington & Anne Cotton, & GENERAL GEORGE WASHINGTON Arms. EAST WOLFBORO, or Cotton Valley. NORTH WOLFBORO, NEW HAMPSHIRE, U. S. A.



DURING THE WAR OF 1812, 1813 WHEN WAS KNOWN THE FERNALD MOTTO, "TRUE TO GOD, COUNTRY, STATE AND FAMILY," AND MY GREAT GRAND-FATHER'S GENERAL ZEBULON PIKES SON BRIG. GENL. Z. MONTGOMERY PIKE motto: "1. Preserve your Honor free from blemish. 2. Be always ready to die for your Country." That was no idle boast, as General Pike led his men to victory 27 April 1813 and gave his life for country's honor. Fell. My honored father JONATHAN POOR FERNALE, 1812 went to Rochester to

serve with arms his country. His brother SAMUEL FERNALD, enlisted. Former to short, like King Pepin and his brother, Uncle Sam. sent substitute to protect his loved country, being ill. New Hampshire Adj't. Gen'l's Report for 1868 Wolfborough Soldiers in War of 1812.

SHANNON, NATHANIEL H.	Lieut.	in	Capt. Stories	Co.,	Page 139	And probably others,
CLARK, TIMOTHY	Corpl.	"	" " "	" " "	" " "	as the Residence is not given in more than one half of the Companies.
GLINES, MOSES J.	P	"	" " "	" " "	" " "	COLONEL
GLINES, NATHANIEL	P	"	" " "	" " "	" " "	GEORGE C. GILMORE
HOLMES, JOHN	P	"	" " "	" " "	" " "	
ROGERS, JOHN	P	"	" " "	" " "	140	
WALLACE, JACOB	P	"	" " "	" " "	" " "	
FULLERTON, JOHN	Sergt.	"	" " Moores	" " "	145	P. S. Where mentioned not given Gil.
DREW, JOHN	"	"	" " "	" " "	" " "	
LUCAS, MARK	Musician	"	" " "	" " "	" " "	
AVERY, WALTER	P	"	" " "	" " "	" " "	Nov. 17th., 1904
COOK, ICHABORD	P	"	" " "	" " "	" " "	
EVINS, THEODORE	P	"	" " "	" " "	" " "	Hon. Ezra S. Stearns,
HARVEY, JACOB	P	"	" " "	" " "	" " "	Sec. of State of N. H.
JUDKINS, JOSEPH L.	P	"	" " "	" " "	" " "	Dear Sir:—
LUCAS, ANDREW (missing)	P	"	" " "	" " "	" " "	Your courteous
RICHARDSON, DANIEL D.	P	"	" " "	" " "	146	favor, containing Official
TEIHE, WILLIAM	P	"	" " "	" " "	" " "	Document of my gt. gt. gr. father's Military Services, with Memoranda were received this a. m.
HOIT, JOSEPH	P	"	" " Willey's	" " "	182	Enclosed please find a Ck. \$2.00 for the small amount due for same.
SHEPHERD, JOHN	P	"	" " "	" " "	" " "	With sincere grateful thanks, I remain,
EDMUNDS, STEPHEN	P	"	" " "	" " "	" " "	Faithfully yours,
GRAY, JOSEPH	P	Sick	" " "	" " "	" " "	Charles A. Fernald
WIGGINS, JOHN A.	P	Deserted	" " "	" " "	" " "	
ROGERS, JAMES	P	in	" " "	" " "	" " "	
HAWKINS, STEPHEN	P	"	" " "	" " "	" " "	
TRIGS, THOMAS	P	"	" " "	" " "	" " "	
WILLEY, JOHN	P	"	" " "	" " "	" " "	
DREW, DANIEL	P	"	" " "	" " "	" " "	
HALL, JESSE	P	"	" " "	" " "	" " "	

Mr. JONATHAN POOR FERNALD, armed an equiped went to Manchester or Rochester to be mustered in as a substitute for Uncle Thomas Stevenson, Justice of the Peace, and was refused on account of his statue although he had been a Moderator of the Town of Wolfboro, Tax Collector, Highway Surveyor and many years had charge of the highway; notwithstanding at a Town Meeting, where it was customary for the atheletes to wrestle as part of the physical training to provide soldiers for their country's protection, he vanquished the champion town wrestler. Gave with approval consent for two of his sons to enlist for Civil War, prevented by mother. Built the First Baptist Church at Wolfboro Centze, aided by Hon. Thomas L. Whitton, Horne & Chamberlain. Held open and hospitable house for the clergy at quarterly meetings and regular services, of which he was a prominent member over three generations. Possessed of a wonderful memory of most ancient and more recent family history that has without a single exception been verified as he recalled it for over 1800 years, by writer that never knew him to tell or act an untruth: ever just, generous, stern, brave, firm, very kind hearted, strong in noble true manhood. Deep great love for his family and godly persons, scorning every impurity in act, thought and deed. Giving to his two sons a part of his land to cultivate for their personal use, with the lesson that it was better to earn than accept. Gave to each son generously to start in life. Cared for his widowed daughter most tenderly and nobly. Was a most perfect true noble father that pen or words can never fully give the great honor or love merit this great MAN OF GOD, EVER LOYALLY PATRIOTIC. George Washington his ideal of religious incorruptable manhood, United States Father taught to his children as an example. Aided in this and in the history of Wolfborough, New Hampshire. Courteously acknowledged by Author, Mr. Benjamin F. Parker.

“FOR A DAY IN THY COURTS IS BETTER THAN A THOUSAND. I HAD RATHER BE A DOORKEEPER IN THE HOUSE OF MY GOD THAN TO DWELL IN THE TENTS OF WICKEDNESS. FOR THE LORD GOD IS A SUN AND SHIELD: the Lord will give grace and glory: no good thing will he withhold from them who walk uprightly. O Lord of hosts, blessed is the man that trusteth in thee.”—Psalms 84:10-12.

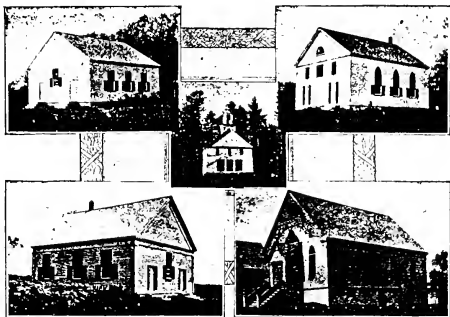

5
PLATE 1411.

1. J. P. Fernald Pioneer Church at Wolfboro Center, N. H. 2. North Wolfboro Church.
3. Cotton Valley Church at East Wolfboro, N. H. 4. Advent Chapel, Wolfboro Village.

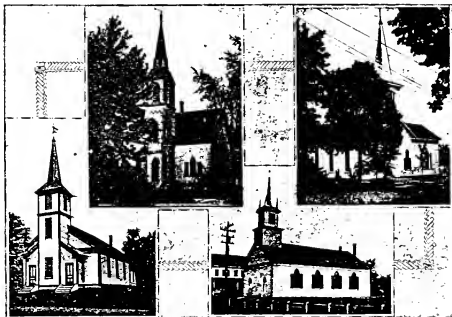

PLATE 1410.

- Free Baptist Church, Wolfboro, N. H. Congregational Church, Wolfboro, N. H.
Unitarian Church Christian Church

LET THE RISING GENERATIONS STRIVE TO EMULATE THESE GREATEST AND BEST OF MEN, MR. JONATHAN POOR FERNALD AND GENERAL GEORGE WASHINGTON, DESCENDANTS OF ROBERT WASHINGTON OF Virginia! These they can never excel! Comely in features, father in form was like that of his ancestor, King Pepin of France typically well shown when he with his short Roman sword fought and slew unaided the lion in the amphitheatre, that all France's bravest refused to attack. His face at his death was typical of with excess of beauty of his relative King Francis of France! Slow to anger, patient, firm, stern, unchangeable as laws of Medes and Persians, godlike. Over seventy years he was a faithful soldier of God, the universal our Commander-in-chief.

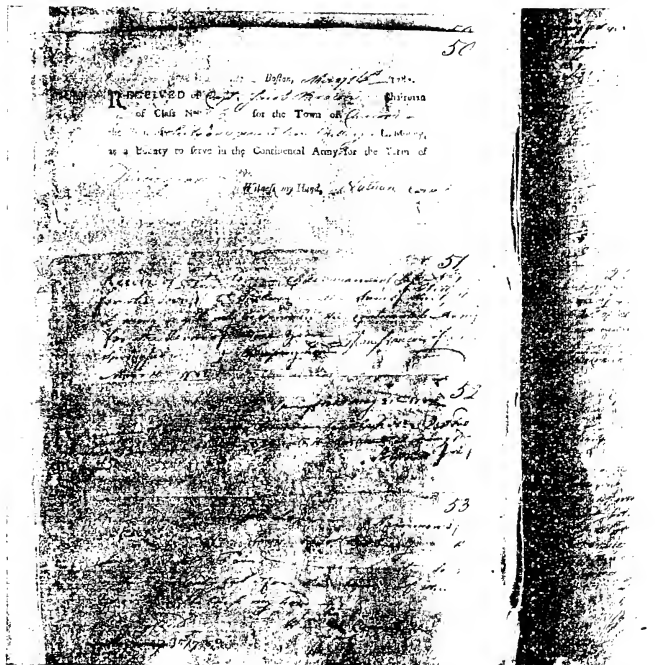

Plate 1339. Photographed from the Archives of Massachusetts, per courtesy of Messrs James J. Tracy and Brown, Chief of the Archives Department, State House, Boston, Mass. EXETER DEEDS AND NOTES, Volume 112, Folio 447: 16 Sept. 1778: John Furnald, Jr., of Middleton, yeoman, man and wife, Mary, daughter of and one of the heirs to the estate of John Savage, late of Portsmouth, N. H., yeoman, interstate, deceased. We hereby acknowledge receipt from Mary Savage, the widow of John Savage, and John Savage, the son of said deceased, administrators of estate of said deceased, 120¢ in full of said Mary's share. Acknowledged 23 Oct. 1778. Recorded 30 Sept. 1780.
Signed, JOHN FORNEL
MARY (X) FORNEL

This ancestor reenlisted as per above "Jean Francois Fournel," or neuil, or r.

DIEU MADE WOMAN AND MAN IN HIS IMAGE AND GAVE THEM DOMINION,
LAND AND SEAS.

A CERTIFIED COPY OF CONVEYANCE OF REAL ESTATE, 1841 TO 1896, PARTS
omitted to save repetition, to and by FERNALDS, Carrol County, New Hampshire, by H. F. Abbott,
Register.

	Book	Page		Book	Page
Jonathan P. Fernald, to Ambrose,	10	540	Frost to Mark Fernald	6	372
William " Jr. from Shannon,	6	119	Daniel Fernald from Copp	31	510
Joseph " to Stevens,	12	373	Stephen Fernald and Libbey	24 Agmt.	118
Simeon " to C. and S. E. Fnd,	24	386	John W. and Lucinda Fernald to Drew	34	221
Mark " " Jenness,	36	576	Henry C. Fernald to Foss	39	3
John W. " " Stillings,	41	171	" " " Pitman	41	226
" " " " "	"	"	Nathaniel " " Dodge	43	287
" " " " Willey,	42	5	Mark " " Avery	"	278
Simeon " " Henson,	44	524	Daniel " " Stockbridge	"	144
Calvin " from Davis	44	411	Daniel " Jr. from Horne	44	139
" " " Hooper	44	350	John W. " Agt. Warner	45	189
Mark " to Varney, et al.	45	554	" " " to Warner	45	504
Olive " " E. Fernald	46	63	" " " from Stillings	"	598
Edmund W. " " Sargent	46	65	Mark " " Patrick	46	542
Daniel " from Brown		307	" " " Brock		544
Brackett M. " to Trickey	47	169	Nathaniel " " D. H. Wood	48	43
" " " Mason	47	171	Lucinda " " Rogers	"	358
" " " from "	47	181	Henry C. " " Cook	"	374
David " Jr. to Bryant	49	298	Daniel " " Streeter	49	301
Jonathan P. " to Willey	50	94	" " " Ladd	50	273
John Y. " from Garland	"	143	Henry C. " " Gray	51	405
Nathaniel " to Roles	51	98	John W. " " Trickey	51	181
" " " "	"	128	Simeon " " Campbell	"	55
John B. " to J. M. Brackett	52	127	Mark " to Gale	52	282
Henry " from Wentworth	"	115	" " from Hanson	"	287
Henry C. " " Rogers	"	123	Daniel " to Durgin	"	110
Daniel " Jr. " Bean	54	234	Samuel " from Bean	55	292
Oliver G. " " Bullard	54	200	George W. " " Packard	55	587
Jonathan P. " to Chas. A. Fernald	"	297	Mark " " Johnson	"	173
Joseph " " Joseph A.	55	443	George W. " to John W. F.	"	"
Henry C. " " J. W. Fernald	57	320	Mark " " J. W. F.	57	311
John Y. " from White	59	326	Simeon " et als. to Brown	60	535 and 511
Jonathan P. " to Railroad	60	450	Daniel " to Canney	60	1
" " " " Sophronia C. Fernald		367-8	M. P. P. w., H. Fernald from Cook	60	47
Charles A. " " Jonathan P. Fernald	60	353	Daniel Fernald from Durgin et al.	"	344
Joseph A. " " Chamberlain	61	455	Mark " to R. R.	61	445
Samuel " " "	"	299	Henry C. " " Emery	"	193
Charles F. " " Langley	"	173	James A. " " Chamberlain	61	455
Samuel " from ———	"	308	Charles F. Fernald from Langley	61	173
Henry C. " " Emery	"	191	James A. " to Nichols	62	553-4
Joseph A. " to Moulton	63	26	John Y. " " J. W. Fernald	63	154
George W. " " Drew	"	184	Albert F. " " Avery	"	195
Mark " " Albert F. Fernald	"	196	George W. " " Drew	"	192
John Y. " from Roberts	"	130	John Y. " " Smith	"	153
Mark " " Johnson		284-7	Tobias M. " " S. B.	64	486
Simon " to Campbell	64	516	Henry C. " from Nute	"	317
Henry C. " from Stephen	"	310	Mark " to Brown	65	522-2
Joseph A. " to Dore	65	220	Henry C. " from Hall	"	56
Mark " " Meserve	66	383	Mark " to Henry C.	66	297
John Y. Fernald et als F. to John W. Fernald	"	152	John W. " " McMellan Sevy	67	172
Henry C. Fernald to Dame	67	311	Simon and wife " Wentworth	67	266
" " " " Blake	"	193	Charles F " " Perkins	68	186

	Book	Page		Book	Page
Oliver G. Fernald from Canny (109 and	68	587	Henry C.	"	from Roles " 183
" " " to Joel Fernald	69	489	Joel	"	to Oliver G. 69 519
Albert F. " from Nason	"	509	John W.	"	from Larabee " 494
Henry C. " and w. to Black S. B. 157	70	245	Mary P.	"	" " Black 224
" " " " " from Hale 167 Hall	"	187	George M.	"	" " Davis 70 217
John W. " from Melorn	"	572	Henry C., w.	"	to Hanson 71 7
Simon " and w. to Hanson, D. E. 193	71	366	Mark	"	" " B. & G. W. F. 71 371-499
Jonathan P. " to Sophronia C. Fernald	"	525	Chas. A. & wife	"	Jonathan P. F. 71 525
J. P. " " Sophronia Chase Fernald	"	525	Sophronia C.	"	" " " " " 523
Mrs. J. M. " B. to Jonathan P.	"	"	Nancy H.	"	" " Nicholas 72 97
Henry C. " from Hanson	"	8	Mark	"	from Peirce 71 189 M. 167
Simon " " D.	"	168	Geo. W.	"	" " Mark F. 71 499
Mark " " Chas. E. P.	72	240	Albert F.	"	" " Nason 72 338
Simon (583) " " Merserve Weeks	"	388	Nancy Fernald	to	Nichols & B. 133 380
Chas. E. P. " " Mark Fernald	"	240	Oliver G.	"	" " R. 28
Mark " " to J.	"	409	Oliver G.	"	" " R. 74 75
Chas. E. F. " " Mark Fernald	74	374	B. M. Fernald	"	" " Nason " 443
George M. " from Hastings	"	100	H. C. F. & M. P. F.	to	Meserve 76 122 126
Jonathan P. and Sophronia C. and			Henry C. & Mary P.	"	Masen 76 53
Mary Cotton Fernald to Josie M. Buzzell	75	506	" " " " " " Eastman	"	" 205
Oliver G. Fernald from Caverly	77	88	Simon Fernald	to	Weeks 77 583
Henry C. " 78 to Hall, Thompson,	163-5-7		Calvin	"	" " Samuel C. F. 78 411
Helen G. " Dearborn	79	517	Oliver G.	"	" " D. 79 517
Daniel " Jr. from M.	"	492	" " " " " " from Joel F. & C.	56 58	
Samuel C. " from Oliver G. Fernald	"	524	Helen G.	"	" " J. Clay Dearborn 516-17-520
Sophronia " to H.	80	388	Albert	"	" " N. 80 413
Henry C. " from N., M., M., 136, 163,	"	235	Samuel	"	to Orland, M. F. 81 28
Simon " to D.	81	147	B. M.	"	" " Hatch " 283
G. M. and M. E. Fernald to G. S. & E. W. Fernald	82	128	Horace E.	"	from Caverly 82 328
Daniel Fernald, Jr. from C.	"	327	Henry C. Fernald	to	Henry P. Fnlld 83 162
John W. " " to McK.	84	136	John W.	"	from D. 84 215
Henry C. " " 82, 415, 420, 465	"		Hollis E.	"	" " C. 85 48 50
Charles A. " from S. C. Fernald	85	89	Geo. S. & E. W. F.	"	" " H. 491
Oliver G. " " J. Varney	"	495	Samuel C.	"	to Calvin 86 44
Calvin " " S. Fernald	86	66	Geo. S.	"	" " Willey 87 258
Edward W. Fernald to Willey	87	258	Byron W.	"	" " H. " 308
Osborn " " Grant	"	315	Leonard A.	"	" " Grant " 315
Frank exux " " " "	"	317	Adelbert	"	" " " " " 318
George S. " from H. O. F.	"	449	F. & O. F. & L. A.	from	D. " 223
Daniel " Jr. to P.	88	85	Aris M. Fernald	to	Danl. Fernald 88 405
Byron W. " from Stillings	"	195	Brackett M.	"	from Stillings " 418
Tobias M. " " Hodge	"	570	Olando M.	"	to S. 89 388
H. C. and B. M. " " Gr.	89	198	Osborn F.	"	" " Gr. " 107
Frank " to " "	"	113	Chas. F.	"	from " " 199
F. and O. F. and L. A. and A. Fernald from Grant	40		Daniel " Jr.	"	" " Trustees Stone Col., 1-4
Osborn F. Fernald from Gray	89	571	Osborn F.	"	to Gray 90 205-6
Henry C. " 325 " "	90	338	George S.	"	" " " " 326
Nancy J. Y. " Widow from Seas	"	54	Danl. F. and Mary Fernald to H.		91 42
Mary P. " to E.	91	306	Hollis E. Fernald from B.		91 214
Daniel " from B.	"	234	Byron W.	"	" " M. " 242
Brackett N. " " M.	"	196	Henry C.	"	" " S. " 283
Henry C. and wife and E. F. to B.	92	451	" " " " " " P.		92 181
Charles T. Fernald from P.	"	282	Mark & Payson Fernald to H.		93 544
Osborn " to Wm. H. Fernald	93	480	John W. Fernald from B.		" 197
Edward H. " " B.	94	386	William H.	"	to Osborn E. Fnlld. 94 74
Hollis F. " " D.	"	311	Edward " " from B.		" 386-7

	Book	Page		Book	Page
Brackett M.	..	444	Maria A.	..	94 315
Samuel C.	..	193	Osborn F. 74
James F.	..	87	Helen G.	..	95 392
Albert C.	..	95 8	Mark 45
Byron	..	225	H. E. & G. S.	..	95 180 & 225
Edward	..	96 600	Mark & S.	..	97 250
Osborn	..	97 310	Brackett M. 312
John W.	..	17	John W.	..	100 49
Hollis E.	..	98 154	Margaret M. Fernald	..	98 157
Elmer E.	..	99 83	Eliza J.	..	99 119
Calvin	..	119	W. H. 466
Brackett M.	..	476	Calvin 440
Byron W.	..	483 100
Elmer E.	..	16	G. S. et ux	..	100 563
Oliver G.	..	100 583	L. A. and Eva M. 102
Byron W.	..	101	Simon	..	101 121
Oliver G.	..	176	Eliza J. 204
Calvin	..	258	Alzada M. 340
Jerome K.	..	564	Oliver G.	..	102 206
Tobias M.	..	102 221	Simon 353
Hollis E.	..	125	O. G. 138
Oliver	..	315	Simon 371
Simon	..	443	Mark	..	103 360
Jerome K.	..	103 555	Wm. H.	..	104 184
Osborn F.	..	104 588 178
Mark	..	178	Tobias M.	..	106 309
Oliver G.	..	106 175	Simon	..	105 345
Brackett and Mary C. w. from Geo. S. F.	..	105 550	Lenard 593
James F. Fernald 2 from Geo. S. F.	..	336			

A few of last initials employed to fill blanks.

The writer regrets to find when too late to rectify the omission that evidently Mr. Abbott was so weary that he could not write the full names of the good Towns people that had business dealings with the numerous Fernald families, in Real Estate, many united by ties of blood.

JOHN FURNELL'S WILL. In the Name of God Amen.

I John Furnell of Portsmouth in the Province of New Hampshire Mariner being in good health & of Sound mind & memory but knowing I must Dye & not knowing how soon, Do make & ordain this to be my Last Concerning Such Worldly Estate as God has been pleased to Give me. And first my will is that all my Debts & funeral Charges should be first paid. And the residue of my Estate, Real & Personal I Give Devise & Bequeath in manner and form following that is to say the One half part thereof unto Katherine my well beloved Wife & to her Heirs & assigns. And the Use Improvement of the other half during the time that she shall be & Remain my widow. But upon her Death or marriage again the said other half to go to & become the Right & property in Fee Simple of my Child or Children that shall survive me in equal parts or shares. And I make my said Wife Sole Exec. of this my last Will and Testament, and Revoke all other Wills by me in any manner heretofore made Ratifying & confirming this alone to be my Last Will & Testament.

In Witness whereof I have hereunto set my Hand & Seal the Twelfth day of January One Thousand Seven Hundred & Forty & in the Fourteenth year of His Majesty's Reign.

Signed Sealed & Declared by the said John Furnell to be his last Will and Testament. In Presence of us

William Parker, George Libbey, Elizabeth Parker

JOHN FURNELL { Seal. }
Rec. Vol. 11, Page 522. Proved Apr. 25, 1750.

A true copy of record, Attest: Irving M. Heath, Register.

B. 11. L. 26. Lieut. John Johnson's, Oct. 5, 1695, aged 63 yrs. of Haverill in New England gift upon marriage of son Timothy Johnson of thirty acres of land. Two cows. Two young oxen. Ten sheep. Two swine. a young horse. Twenty Bushells of corn

Witness Josiah Gage

John Johnson. My honored fore Fr.

Cutter Noyes Acknowledged—5 Oct. 1695—endorsed on deed—Nathl Saltonstall, J. P.

Lib. 10. f. 14. E. pr Steple-Sewall, Regr. Essex Regr. Deeds, So. Dist. Salem 9 July 1895 V. C. A. C. Osgood, Reg.

N

COTTONIAN PAPERS AND THE HOLY BIBLE RECORDS FROM BRACKETT FERNALD COTTON. COL. WILLIAM COTTON MOVED FROM PORTSMOUTH TO WOLFBOROUGH IN 1781 AND SETTLED ON THE

Farm now owned by Dea. Thomas Cotton—being then forty-three years old he lived until Sept. 8th, 1821. He had twelve children, four of whom died in infancy. William his eldest child at first settled in Wolfboro. but afterwards moved to Castine, Maine. A son of this William, William (3) the third returned to Wolfboro. and made that town his home. He was a man of considerable influence: serving seven years as one of the Board of Selectmen. A son of his Dudley P. Cotton is now a wealthy merchant in the West Indies, he still retains a kindly interest for the home of his childhood and has given the neighborhood substantial proofs of his regards. The elder next of Col. Wm. John Pickering, Thomas; then James, Isaac, George, Mary and Samuel. The six sons last named settled in Wolfboro. Isaac however moved to Lancaster. Wm. 2nd married Polly Fernald of Brookfield by whom he had four children. He died in Castine, Me., at the age of 64 years. John married Bessie Allen of Ossipee by whom he had nine children. Thomas married Martha Furber of Wolfboro. by whom he had six children, he died at the age of 81 years. James married Betsey Robinson of Brookfield by whom he had four children, he died at the age of 87 yrs. Isaac married Eliza Martin of Wolfboro. by whom he had eight children, he died at the age of 72. George married Sally Wiggin of Wolfboro. by whom he had four children, he died at the age of 63. Samuel married Salley Fernald of Brookfield by whom he had five children; he died Feb. 8th 1892, aged 72. MARY married ROBERT PIKE of Middleton, she was the mother of ten children, she died at the age of 55.

The eight children of Col. William Cotton that survived the infantile period reached an average age of 71 yrs. and were the parents of fifty-six children; six of whom died in infancy. The most of the others reached maturity and became the heads of families. Quite a large proportion of their descendants still remain on the farm occupied by their ancestors. So numerous are they, that they have given name to a locality of the town which is called Cottonborough. They now possess 1600 acres of land, the most of it adjoining. The original stock (see plate & coat of arms ante) were strong athletic fellows. John P. Cotton, a grandson of the Col. has served six years as Selectman and (2) two years as Representative. A brother of John P., Elliott Cotton has served two years as Representative and on the board of Selectmen (2) two years. Another, Thomas has been twice in the State Legislature of which he was a member.

Mrs. Sally Cotton, the wife of Geo. O., d. June 25th, 1864 aged 90 years. Mrs. Nancy Cotton wife of Dea. Thomas died in the 45th year of her age. Mr. John F. Cotton, Son of Thomas, Sen. d. Aug. 30th 1855 aged 55 yrs. Alizora, daughter of John F., aged 17 yrs. Aug. 29, 1855. Copy from Cottonian documents loaned to writer by Mr. Brackett Fernald Cotton of Cotton Valley July 12 1894. His P. O. Address East Wolfboro, N. H. that show that gt. gr. fr. Col. Wm. Cotton in French Wars was with his wife Mary Clark were the parents of Mary Cotton who married my gr. fr. Robert Pike, whose daughter Mary Cotton Pike married Jonathan Poor Fernald, the father of my brothers and sisters. Obituary, "Died in Wolfborough, Sept. 8th, 1821. Mr. William Cotton. aged 84. He was a Soldier in the old French War, and Colonel in the Militia several years. A useful member of the Methodist Church for about 13 years of the latter part of his life. Funeral was attended by Elders Ashchoft and Townsend. He has left afflicted Widow, eight children, forty-seven grand children, several great grand children." From preponderance of evidence. The above Col. William was the "adopted" son of William Cotton of Portsmouth who had five sisters one married



JOHN SNELL, ONE WITH A HUTCHINGS, ONE WITH A MARDEN, ONE WITH A DAVIS, AND ONE WITH A LEWIS. MR. ALVIN COTTON, SON OF JOHN F., JAN. 25, 1861, AGED 36 YEARS. MR. DANIEL COTTON, OCT. 20, 1865, Aged 62 years. Samuel Cotton, born May 29, 1780: married Sarah (called Salley) Fernal, April 26, 1809; born June 11, 1790; died June 15, 1830; and he died February 8, 1852: married 2nd, Abigail Hobbs, born September 1, 1797; died 22 February, 1864; married March 16, 1831—The Bible Record in conformity with Cottonian Records: Samuel Cotton, born May 29, 1780; died February 8th, 1852: married April 25, 1809, Sarah Fernald, born June 11th, 1790; died June 15, 1830: Had Joseph P. Cotton, born February 12, 1812; died August 6, 1883. Wesley Cotton, born February 5, 1815; died in the State of Iowa. Samuel Clark Cotton, born July 27, 1820; died March 12, 1839. BRACKETT FERNALD COTTON, born September 30, 1826. Sarah Maria Cotton, born December 6, 1829; died August 1, 1845.

Brackett Fernald Cotton has in his possession Mariner Chest of Captain John Fernald, father of John Fernald, whose Writing Desk (see plate before) or Secretary he owns, and promised it to the writer at his decease.

Sunday, July 28, 1895, I visited the graves of Colonel William Cotton, my great grandfather aforesaid. Also that of grandfather Robert Pike and wives: viz. my grandmothers, Mary Cotton Pike and Joanna E. More; John Wentworth Fernald's on Cottle Place. July 29, 1895, visited and copied from John Isaac Daniel Martin Monument:—front, north west side: Sophia W., wife of Daniel Martin, born February 25, 1810; died February 24, 1849: Daniel Martin, born March 26, 1802; died June 7, 1874: 'Loise, wife of Isaac Martin, born May 14, 1779; died October 26, 1832: Hannah, wife of John Martin and mother of Isaac Martin, died April 25, 1814; Aet. 82 years: Maria M., born January 25, 1810; died October 14, 1811: George, born February 12, 1805; died February 12, 1817: Children of Isaac and Lois Martin:—South West of same Monument:—Edgar I., born December 19, 1835; died March 23, 1839: Leander, born May 1, 1839; died October 25, 1842: Almena A., born September 15, 1833; died March 21, 1852. Daniel and Sophia Martin Children, George B. Martin, born September 15, 1830; died October 8, 1873, in Brewster, Mass. South east chiseled record:—James Fernal, born June 24, 1779; died June 4, 1861, and Betsey Brackett, his wife, born January 8, 1774; died June 6, 1861, the parents of Sophia W., wife of Daniel Martin. Deacon James Fernal, died September 1823, and Mary, his wife, died December 2, 1831. Aged persons and parents of Lois, wife of Isaac Martin.

To all People to whom these Presents shall Come Greeting &c. know ye that we John Fernald Shipwright George Fernald Cooper & Elizabeth Fernald Spinster of Portsmouth in the Province of New Hampshire in New England for & in Consideration of that Love good will and affection which we bear toward our loving Brother-in-Law Jonathan Mendum of Kittery in the County of York in the Province of the Massachusetts Bay in New England aforesaid Shipwright has given and granted by these presents do freely Clearly and absolutely give and grant unto this Jonathan Mendum his heirs and assigns forever all the Estate Right Title Interest Reversum Claim Demand whatsoever which we the sd. John Fernald George Fernald Elizabeth Fernald now have may right or ought to have or which we or our heirs at any time hereafter shall or may have might or ought to have or claim of in or to any Part of that Land Scituate & being in the Township of Berwick and Kittery afore sd. that was drawn by Lott and laid out to our Hond. Grandfather William Fernald formerly of Kittery dec'd. for his part or Portion in the Common undi. etc.

Apr. 3, 1760
True Copy

John Fernald
George Fernald
Elizabeth Fernald

{ Seal. } Daniel Moulton, Regr.

T

VALUABLE ENCLOSURE FROM "PAPERS OF DAVID A. HINCKES, ATTY. AND COUNSELOR AT LAW, 39 COURT ST., ROOM B, BOSTON, MASSACHUSETTS, JULY 5th, 1895." HISTORIC: VIZ.

"John Hinckes came from England about 1670 or 1672, and settled in Great Island in that part of Portsmouth now called New Castle in New Hampshire, was Councilor for Province of New Hampshire and Assistant in the Court of Chancery from 1688 to May 25, 1686, when he became a Councilor in the New England government of President Joseph Dudley having been named for the office in the commission of James II, dated Oct. 8, 1685: was appointed Chief Justice of the Court of Pleas and Sessions in N. H., June 10, 1686 and July of the same year was commissioned to be "Captain of the Fort and band of trained soldiers" in Great Island. He continued in office as Councilor, Judge and Captain of the Fort until the overthrow of the Colonial Government in April, 1689, and was again named as Councilor March 1st, 1692, in the commission of William and Mary creating a new government for N. H., and was President of the Council, January 19, 1696, he was a second time appointed Captain of the King's Fort, then called Fort William & Mary, "and band of trained soldiers" at New Castle with Theodore Atkinson as his Lieutenant. In 1699 he was appointed Chief Justice of the Superior Court and remained in office as president of the Council, Judge, Chief Justice and Captain of the Fort until 1707. He was living at New Castle, New Hampshire, date unknown, Elizabeth Freyer, born in Boston, Mass., November 1, 1657, daughter of Judge Nathaniel and Christian Freyer of Portsmouth, N. H. He had —, daughter, married Thomas Gross; Samuel, son, married Elizabeth Winslow Scott; Christian, daughter, married Richard Jordan of New Castle; Barbara, daughter, married John Perce of New Castle. Sarah m. JOHN FERNALD of Kittery, Elizabeth m. Wm. Pitman, Boston. Said John Fernald and wife SARAH were writer's foreparents.

The Cradle of American Liberty Left Us in Trust Ipswich, Mass., Aug. 9, 1895.

I Charles W. Bamford do hereby certify that the following are correct copies from the records of births in the Office of the Town Clerk of Ipswich. Page 11, Book 1, John son to Mr. John Rogers, minister, and Mrs. Martha his wife was born January 27th, 1692. Page 29, Book 1, William son to Mr. John and Martha Rogers born June 19, 1699. Page 33, Book 1, Nathaniel son to Mr. John & Martha Rogers, was born Sept. 22, 1701. Page 37. Book 1, Richard, son of Mr. John & Martha Rogers was born Dec'r. 2d, 1703. Page 43, Book 1, Eliza, da. of Mr. Jno. and Martha Rogers born Feb. 10, 1705. Page 46. Book 1, Daniel and Elizabeth Rogers, twine, children of Mr. John and Mrs. Martha Rogers, born July 28, 1707; Page 49, Book 1, Samuel, son of Mr. John and Martha Rogers, born Aug't. 31, 1709.

Seal of the Town of Ipswich, Mass.

Witness my hand with the Seal of the Town affixed.

Charles W. Bamford, Town Clerk.

Mr. John Fernald the son of Mr. John Fernald and wife Elizabeth Hinckes was married to Elizabeth Rogers, da. Rev. Jno. and Martha Rogers of Ipswich by Rev. John Rogers at Kittery, November 25th, 1723. Their son Col. Tobias Fernald married Elizabeth Mitchel of Kittery, April 28, 1776. Rev. Benjamin Stephens at Kittery officiated. See the letter above of this Tobias Fernald. I hold the Records of Mrs. Elizabeth (Rogers) wife of said John Fernald, a Captayne, mentioning their son Mr. John Fernald with said letter of Tobias who mentions his relatives in part therein. Relics I have mentioned by his mother and his autograph signature that was, the same when he Enlisted as Jean Fraucois Pourniel or Fournior and the copy in my father's old papers had his name as same FOURNIEL and he was the 4th or IV John from Dr. Remald Fernald and Col. Tobias his Sword pictured in hand of General George Washington above with a record of its gift to Capt. Tobias Fernald his cousin. Before me in "FAC SIMILE OF AUTOGRAPHS OF THE ORIGINAL MEMBERS OF THE SOCIETY OF CINCINNATI for the State of Massachusetts. Formed at the contentment of the AMERICAN ARMY, on the banks of the Hudson River, June 9th, 1783. The GENERAL SOCIETY, consisting of ALL the officers of the CONTINENTAL ARMY was formed at the same place May 10th, 1783, of which the first President was Go: Washington."

The objects of the Society are stated in the original compact "to commemorate the establishment of the UNITED STATES OF AMERICA, as Free, SOVEREIGN and INDEPENDENT. To cherish between the several states that Union and national honor so essential to their welfare, prosperity and dignity: to preserve a just regard for those exalted rights of human nature, without which the high rank of rational beings would scarcely be a blessing; to perpetuate the mutual friendships formed in a time of common danger, to effectuate acts of benevolence toward those of officers or their families which might need assistance; and to inculcate to the latest ages the duty of laying down, in peace, arms taken up for the public defence. Hereon Tobias Fernald, Lt.-Col. 2nd Column: Tobias Fernald, Lt.-Col. 5th column, last 26th name from my ancestor John Fernald of Portemo., Wolfboro, Brookfield and Middleton: 2 d. E. Davis, p. 11 U. S. 1st Census Bakertown Plantation: 5 sons 3 das. at Mr., 1790. Crispus Graves, p. 14, 1 son, 2 das: Brother of Elias of Dal. Sunderland Town, Mass. bur. in Old Granary Cemetery, Boston. Ancestor of Capt. Graves. Asa Underwood, p. 156. U. S. 1st C. Tyngsboro, Mass. John Sherburne, 3 das. at Portemo. Town, N. H. See pl. Two John F's, & C. G. & A. U. & J. S. aforesaid did their best to establish equal rights in USSS. The Immortal 322

Autograph signatures from above important document are subject to order of all descendants.

"DIOCESAN REGISTRY. Chester 29th Sept. 1894." REIGN GOOD QUEEN VICTORIA.

C. A. Fernald, Esqr., M.D.
Boston, Mass.,
U. S. A.

From the courtesy of RICHARD FARMER, Dep. Registrar
Memoranda from the Parish Registers of Runcorn. OLD ENGLAND.

"Elizabeth Savage bapt. erat ij Aprilis, 1570. Ellena Savage bapt. erat iij Augusti, 1572; Johannes & Margeria Savage bapt. V Junii 1575; Edward Savage bapt. xxx July, 1577; Thoms Savage, xxx bapt. XVo Januarii, 1580; (Jonani S(ava)ge, bapt. pmo, Septembris, 1584 to 6; Eleana Savage als Runcorne Xij Februarii ? 1605; Thomas Savage als Rosaton, Xvi Julij ? 1605; Alicia Savage filia Edw. Augusti ? 1605; Tho. Savage filio Edw: 25 April 1608; Maria Savage filia Tho: 16 Maji 1609; Elena Savage filia Johis 18 Septembris 1609; Henrico Savage filii, Edw: 7 Decembris 1610; Elena Savage, filia Tho: 17 Maji 1612." Due to a "natural decay of the parchment skins the fading of the ink" some portions are indistinct which the kind Mr. Richard Farmer has marked? For a large amount of labor and care that was perfect, the small sum of "£2 1 1" only was charged and "recept. acknowledged" for search and labor "in looking over Registers from 1558 to 1612." Our numerous Savage families in U. S. graciously appreciate the valuable data and historic copy for the good of ALL.

SIX DAYS SHALL WORK BE DONE, BUT ON THE SEVENTH DAY THERE SHALL BE TO YOU AN HOLY DAY A SABBATH OF REST TO THE LORD; THEN SHALT THOU DELIGHT THYSELF IN THE LORD; AND I WILL CAUSE THEE TO RIDE UPON THE HIGH PLACES OF THE EARTH.

—Exodus 35:2; Isaiah 58:13.



PLATE 1342. Historic. John and Mary Fernald (and Governor John Wentworth) Houses. Birth place of their son William Fernald and grand son Jonathan Poor Fernald at Wolfboro, Centre. Birth place of great grand children; 100 acres that extended from highway crossing Rattle Snake Brook or Ripulet to Lake Wentworth, to a few rods below Fernald and Willey Brook, about 1 mile long and 1-4 wide. Tracings of his house shown as photographed from Martin's and Cook's Hills. Smith's Pood was named for Captain John Smith, son of George and daughter of Francis Junius Fernald, and son, Captain John Smith, Jr., located there and built a log house on Stamp Act Island that was thus named for a deserter in American Revolution that lived as Hunter (2nd) John Smith's log cabin that writer has repeatedly visited when from 15 to 19 years of age. Captain departed and Cook purchased, and then by consent it was named for Cook the navigator, whose descendant married Miss Pike, my cousin. Dr. Cook, discoverer of the North Pole, is a descendant, and Captain Furneaux (which was the French mode of spelling Fernald, they changing "al" or "al" into "eaux.") A lady of the Haines family was chased by wolves, and by her great wisdom and bravery escaped death by feeding them with beef, carried on back of her horse, until she reached home, when some were slain and others fled. Good Dog Oms that saved my life.



PLATE 1343. Coat of Arms of Barton D'Acres whose descendant, John Acres, was in the American Revolution. See Acres line of genealogy herein.

T

FROM DEBRETT'S PEERAGE SUPPLEMENTS FROM MAY, 1834,
TO APRIL, 1835—ADDITIONS:—

Pages 28 and 207—"THOMAS BRAND, BARON DACRE, born 10 March, 1774, succeeded his mother, Gertrude, the late Baroness, 3 October, 1819; married December, 1819, Barbarina, one of the daughters of Admiral Sir Chaloner Ogle, bart., and relict of Valentine Wilmot, of Farnboro, co. Southampton, esq. Collins Peerage record the Acres as being always held in reserve to win battle.

RANULPH DE DACRE (descended from William de Dacre, sheriff co. Cumberland, temp. Henry III) was summoned to Parliament, 1321. From him descended THOMAS, 6th Baron, who died 1457, leaving granddaughter and heiress, Joan, married Richard Fiennes, who was summoned to Parliament, 1459, as Baron Dacre. He was ancestor of GREGORY FIENNES, 9th Baron, who died 1594, leaving an only sister and heiress, MARGARET, wife of Sampson Lennard, esq: she claimed and was allowed the barony 1604: son emigrated to America, Boston. THOMAS LENNARD, 14th Lord Dacre, great-great-grandson of the above named Margaret, was created Earl of Sussex, 1674, and died 1715, leaving two daughters and co-heiresses, Barbara and Anne, between whom the barony of Dacre fell into abeyance. The former of these ladies married Lieutenant General Charles Skelton, but died without issue, 1741, when the title devolved on her sister, ANNE, Baroness Dacre, married, 1st, Richard Barrett Lennard, by whom she had one son, THOMAS, 15th baron; she married 2nd, Henry Roper, 8th Lord Teynham, to whom she was 3rd wife, and by whom she had (besides other issue) Charles, eldest son, married Gertrude, sister and co-heiress of John Trevor, of Glynd, co. Sussex, esq., and had issue, CHARLES, 16th Baron, and GERTRUDE, late Baroness. The Baroness married 3rd, Robert, son of Henry Moore, 3rd Earl of Drogheda, by whom she also had issue; she died 1755 when the barony descended to her eldest son, THOMAS-BARRETT LENNARD, 15th Baron, who also died without issue, 12 January, 1786, and was succeeded by his nephew, Charles-Trevor Roper, 16th Baron, who also died without issue, 4 July, 1794, and was succeeded by his only sister and heiress, Gertrude, married, 20 April, 1771, Thomas Brand, of the Hoo, co. Herts, esq. who died 21 February, 1794 and had issue, 1, THOMAS, present Lord; 2, Henry-Otway, C. B., major-general in the army, late lieutenant-colonel in the Coldstream regiment of foot-guards, took the surname of Trevor only by sign manual, 1824, married, 21 July, 1806, Pyne, eldest daughter of the late honorable and reverend Maurice Crosbie, D. D., Dean of Limerick, and only brother of William, Earl of Glandore, whose former marriage with Sir John Gordon, of Park, bart., was dissolved by act of Parliament in 1806, and had issue, Pyne-Jessie, married, 12 August, 1828, John Henry Cotterell, esq., eldest son of Sir John-Geeres Cotterell, bart., who died 3 January, 1834. 2, Julia, married, 28 June, 1824, Samuel Charles Whitbread, of Arlington, co. Bedford, esq. 3, Henry, died 27 February, 1814. 4, Thomas. 5, Gertrude, married 21 July, 1831, Sir George Hamlington Seymour, cousin of the Marquess of Hertford. 6, Henry, in the army. 3, Gertrude, born 25 October, 1772. The Baroness died 3 October, 1819, and was succeeded by her eldest son, THOMAS, present and 28th Baron. Heir Presumptive, Major-general Henry Trevor, only brother of his Lordship."

CREATION, 5 November, 1321. Arms—see plate 28. Quarterly of 6. 1st, Azure within a bordure engrailed, or two swords in saltire argent, pomels and hilts, gold—BRAND. 2nd. Per fess azure and or a pale counterchanged and three stags' heads erased of the Second—ROPER. 3rd. Or on a fess gules, three fleurs-de-lis of the field—Lennard. 4th, Azure, three lions rampant or FIENNES. 5th, Gules, three escallops argent—DACRE. 6th, as 1st. CREST—Out of a ducal coronet, or a leopard's head coupé at the neck and affronté argent, semée of hurts, pellets, and



TORTEAUX, ALTERNATELY. SUPPORTERS—DEXTER, A WOLF ARGENT, GORGED WITH A SPIKED COLLAR AND CHAIN REFLEXED OVER THE BACK OR. SINISTER, A BULL GULES, ARMED, DUCALLY GORGED AND CHAINED OR. MOTTO—POUR BIEN DESIRER. TO DESIRE GOOD.

ACRES RECORDS—JOHN D. ACRES came to Boston, Massachusetts, in 1656, and was the ancestor of Acres. His brother George arrived 8 July, 1666. Their father, Francis, aged, died 8 Carolus I, was the son of Randel, brother eldest of Ralph, buried at Greystone. Synonyms—Akers, Accres, Acker, Ackus. George was an officer in American Revolution, and was ancestor of Miss Eliza Ann Acres, born 20 April, 1843, the eldest daughter of John Acres and his wife, Eliza Ann Bellamy, who were born 21 August, 1825, and 28 July, 1824; married March 30, 1842, 2nd Generation. Had 15 children.

I, MRS. ELIZA A. (ACRES)(MORRIS) FERNALD had three daughters: Lida, died s. p. unm. k. Mamie, married Mr. Hale, one child by 1st marriage. From 2nd m. was born FRONIA JOSEPHINE FERNALD, who with loyal, true, brave, noble mother, was killed by the Roman Catholic Church for reporting Fire Arms stored under their Church, corner Malden Street, to use against United States Government, succeeded by the Jesuit Col. educated politicians in stealing over \$108,000,000 from the City of Boston with repeatedly offered bribes to writer, one amount \$250,000 for work against state and government, to which add 39 attempts on my life, and 38 witnesses killed. And 16 who built the secret passages under the said church on Malden Street. 37 insults to U. S. Flag! Inspect Arms!! Evidence was reported to Boston Police, who protected and aided the criminal Roman Catholic Church, that refused from Vatican and two Popes their signatures against crimes, being particeps criminis, claiming immunity from crimes that have laid 150,000,000 martyrs beneath the sod.

Report of a United States Operator: "Last night a plank was part sawn through, at the Roman Catholic Church, this morning one of the men who built the secret passages under it was sent to get a hammer on the further end of the plank placed on top of the Church: He refused, and was driven by a Priest, went, pale as death, the plank broke: He fell to the ground and dashed his brains out; a sickening sight; I shall tell other good citizens about it; when the time comes tell about it." This was on or about 1873-4.

II, JOHN W. ACRES, born 21 October, 1844; died 5 August, 1888; married; has descendants. III, Hannah M., born 29 June, 1846; died 3 July. IV, George Henry, born 25 July, 1847; died 15 May, 1852. V, Sarah Eliza, born 18 February, 1850; died 4 March, 1852. VI, Charles Bellamy born 27 June, 1851; married. VII, William Trench, born 12 March, 1853; married; children. VIII, Eben Lincoln, born 28 February, 1855; died October 28. IX, born 12 March, 1856; married. X, Benjamin Collier, born 12 May, 1858. XI, George Henry, born 4 July, 1860; died 9 September, 1861. XII, Arthur Porter, born 24 March, 1862, and died 30 October. XIII, Maria Bellamy, born 2 November, 1863; married Capt. D. W. Sullivan; children. XIV, George, born 7 November, 1865. XV, Etta, born 25 November, 1867. THIRD GENERATION: George Acres or Ackus, born 1790; married in 1818, Hannah, daughter of Otheniel and Hannah Trench (nee Carey) who was born in November, 1800: Had GEORGE WASHINGTON ACRES, born 22 February, 1819. II, John William, aforesaid. III, Hanah Maria: Martha Ann: William. UNITED STATES FIRST CENSUS gives George, 2 heads of Family, three sons; five females who was ancestor of George, viz:—FOURTH GENERATION: GEORGE ACKUS, born; married; had: George, born 1790. John, married Rachel, and he died 15 February, 1809; Rachel died 17 September, 1803. Richard or William? Joan: Margaret: Anne: Gertrude and Barbara: GEORGE ACRES, the father of the said children, was an officer in American Revolution, and his FATHER JOHN ACRES, married DESIRETRUTH, daughter William Thorn, both of Boston, and FIFTH GENERATION, had George et als. Joseph Acker, in Bristol County, Westport Town, had 3 in family. Children Henry and Hannah: Catherine: Mary: John. SIXTH GENERATION: WILLIAM AKERS, married; had John and five daughters. He was of Brookline Town, Suffolk County. SEVENTH GENERATION: MOSES ACCRES, at Newbury Town, had with him his father, John, and besides the two daughters, was the parent of William, and had with him his father, John, the son of John of 1656, whose father was attained 8 Carolus I. See Baronia Angelica Concentrata, et U. S. Records cut off after A. R. that gave nine generations to Gregory Fiennes, 9th Baron, who died leaving an only sister an heiress, Margaret married Sampson Lennard. THE BELLAMY LINE IS FROM PREPONDERANCE OF EVIDENCE, viz.: Miss Eliza Ann Bellamy, married John Acres. II, CHARLES BELLAMY, married COLYER. III, JACOBUS, born 1757; died 86. IV, Joseph Bellamy, D. D., born 1719; died 6 March, 1790. JACOBUS, born 1757; died 6 March, 1786; a Dutch poet.





CALEB HOLLIS MARRIED ELIZABETH MARTIN: HAD ELIZABETH; CALEB; HEZEKIAH; JOSEPH, MARRIED ACENIA WESTON; CHARLES; GEORGE; JOHN; THOMAS. 1, CALEB; 2, HEZEKIAH; OTHNEIL, 3rd; 3, JOHN; 4, THOMAS. HOLLIS IN CIVIL WAR, 1ST MASS. "TRUE BLUES." THOMAS HOLLIS, JR., MARRIED MARY BRITNELL.

ELIZA TRENCH, daughter Othniel and Hannah (Carey) Trench, married Thomas Hollis. Their son, John O. Hollis, Druggist, married Elizabeth Jones; 2nd, Lara Keys. "Micha Trench in Revolutionary War, and gr. fr. George in War of 1812; father J.W. Acres." Nancy Trench married 2 John Hollis. The children of Thomas Hollis and wife, Eliza Trench, were: *Parmelia*, married *Asa Fisk*; *Eliza Ann*, died young; *Maria*, married *James Stearns*; *Francis*, married *Lona*——; *Joseph Edward Hollis*, married *Parmelia Fisk*; he was a Soldier and a Representative. TRENCH LITCHFIELD PRATT et als. *Joshua Staples Mott*, married *Salomia Litchfield*, horn and married in Scituate: Had *Benjamin Litchfield Mott*, born 10 August, 1816; married *Rebecca Trench*, daughter Othniel and Hannah (Carey) Trench, son of Othniel, son of Micha Trench, horn in England and died therein, married *Achlanor Calhoun*, who died in Boston while he was in England, who had *Micalh Trench* (said to be a descendant of *Baron Trenck*) went away and not heard from: 2nd, Othniel, horn in Boston: 3rd, *Hannah Trench*: Othniel, married *Hannah Carey*, both of Boston, January 1st, 1790. Had 18 children: Othniel, horn 12 July, 1794; died 21 January, 1826: *Samuel*, horn 16 September, 1796; died: *Hannah*, horn 2 September, 1797; died s. p.: *Hannah*, horn November, ; married *George Acres*; fr. *John*, died in East Boston: *Samuel*, 2nd, horn 1801; died in Havana, 1822: *Nancy*, horn 2 May, 1806: *William*, horn 1808: *Martha*, horn 1810; married *Phineas Collyer*: *Henry*, horn 1812: *Rebecca*, horn 16 December, 1814 or 16: *Samuel*, 3rd, horn, and *Micalh* 2nd. The aforesaid *Rebecca*, horn 1814, married *Benjamin Litchfield Mott*, son *Joshua S.* and *Salomia Mott*, horn 10 August, 1816, March 17, 1836, and he died August 10, 1877, and brother of *Eliza Belknap Mott*, horn 1822, and married *John H. Litchfield*. *J. S. Mott* married, 2nd, *Angeline Pratt* and had *Angeline*: *Joshua*, (drowned in California): *Caroline Augusta*: *Isaac*: *Charles* and *Lucinda Mott*. The children of said *Benjamin L.* and *Rebecca (Trench or Trenck) Mott* were: *Eliza*, horn, and died at 21 years: *Rebecca Frances Mott*, horn August, 1839; married *Mr. Lyman Preston*, most excellent persons with whom the writer lived during first years of medical and surgical practice in Boston: *Benjamin L. Mott, Jr.*, horn 10 December, 1841; married *Miss Emily Jones*, August, 1867; child died in infancy; *Emily*, died aet 7 months: *William Henry Mott*, horn in 1845: *Emily*, horn, died, at 10 years, in 1859: *Joshua*, horn 1850; died at 3 years: *Saloma* horn; died at 18 months: *Benjamin L. Mott, Sr.*, went to California during gold fever. *Benjamin L. Mott, Jr.*, enlisted in Co. G, 44 Massachusetts Volunteer Infantry. Was at *Kingston*, *Whitehall*, *Goldsboro*, *Mill Creek*, *Siege Little* *Washington*, *North Carolina*. Served nine mos. *Mr. Lyman Preston* died; had chn.

MR. OTHNIEL TRENCH, born at Boston, 12 July, 1793; married SARAH N. BREEDEN, born at Malden, Massachusetts, 5 August, 1793, and married 19 September, 1817. He died September 19, 1828, at 35 years, and his wife, Mrs. Sarah N. (Breedon) died 11 January, 1864.

BARONIA ANGELICA CONCENTRATA. JOHN SAVAGE, THE EARL OF RIVERS. See pages 326, 327 and 286.

JOHN SAVAGE, Earl of Rivers, married CATHERINE, daughter of William Parker (died 1622) married Elizabeth, daughter Sir Thomas Tresham, knight, and said William was son Edward Parker, Lord Morely, (died 1618) who married ELIZABETH, daughter and heiress of WILLIAM STANLEY, Lord MONT'EAGLE. Said John and Catherine Savage (he died 1654) had Thomas, ob. 1694) John Richard, who married, and had John, the last Earl of Rivers, ob. 1728, coalebs: Five daughters were horn to John and Catherine: they were Elizabeth, married Lord Petre; Jane, married Lord George Chandos, 2nd, married Sir William Sidley, 3rd. George Pitt, Esq., whose grandson, George, was father of George Pitt, created Baron Rivers of Stratfield, 1776, who had George and 3 daughters, viz.: Penelope, who was Countess of Ligonier; Louisa, married Peter Beekford, who was the ancestor of many U. S. Bickfords, well known and highly respected, and Marcia married James Fox Lane, from whom many U. S. Lanes are descended; 3rd daughter, Catherine, married Charles Sidley, brother Sir William, had daughter, Catherine, who was not married to Charles II, but was created by him, Countess of Dorchester, from which Dorchester, Massachusetts, is named: She after married David Colyear, 1st Earl of Portmore; had issue whose descendants came to Massachusetts. Also coheirs of Baronies of Morely and Monteaagle: 4th, Lady Mary Savage married Henry Killgrew, Esq., and 5th died young or came to America. No account of issue of Elizabeth, m. Edward Cranfield. The son of Thomas Savage, ob. 1694, viz. Thomas, married "ob. vi. pat. s. p. m." had John, who married Mary, had John; and Mary, who married my honored Forefather, MR. JOHN FERNALD, OF MIDDLETON, NEW HAMPSHIRE, U. S. A. The desired truth.





Acres



PLATE 1343. "Coat of Arms of Baron D'Acres whose descendant, John George Acres, was in the American Revolution. See Acres line of genealogy herein."

"JOHN ACRES, of Boston, 1656, and wife, DESIRE TRUTH, daughter William Thorne. Had, 1 and 2, Eliza and Desire Truth, twins, baptized 8 July, 1666; 3 and 4, Henry, a twin, born 15 July, 1667, one died at birth; 5, Eliza, born 22 November, 1669; 6, Deborah, born 26 February, 1671; 7, John, born 10 August, 1673; 8, William, born 29 June, 1679; 9, Mary, born 26 May, 1682, and died; 10, Mary, born 20 May, 1683, in Dunstable; 11, Joanna, born 10 June, 1684, at Dunstable.

HENRY, brother of John and his wife, Desire Truth (Thorne) Acres, born 22 November, 1669; married 13 March, 1674, HANNAH SILVA: both lived in Newbury: They had Catherine, born 17 March, 1675; John, born 2 October, , d. y. ch.; Mary, born 8 October, 1680; John, 2nd, born 20 January, 1694, married about 1714. It was claimed in England was executed two of the Acres family by malignancy of powerful enemies. That the Castle of Norse was captured, burnt, razed. One execution 33 Henry VIII for defending his wife and life: 2nd temp. Car. 1 for the defence of that king who was unrighteously executed. Hence the name, Desire Truth. As in case of Lord Cromwell, temp. Henry VIII, he was attainted in Parliament, condemned, executed, without being allowed to make any defence. In Boston, taking a deposition of capital crime caused defeat of case, six saw crime, on trial for divorce 1896 protecting criminal.

"JOHN ACRES, son George, died 15 February, 1809, and RACHEL, his wife, died 17 September, 1803: Their children were Rachel, born 1784; John, born 1786, died s.; John, 2nd, born 9 October, 1788; Samuel, born 1790; George, born 1792; Thomas, born 1794; Martha, born 1796; Mary, born 1798; Eliza, born 1801; Charles, born 1803. John, born 1788, married Eliza Carey, 3 May, 1812: Their children: Elizabeth Earl Acres, born at Boston, 26 August, 1814, is grandmother to William A. Miles, 57 Chrystie Street, New York. Mr. John W. Acres, Jr., was in Civil War, and had descendants. Both he and parents are deceased. These records were copied by me at 20 Henchman Street, Boston, and the True Copy attested to by Rebecca Mott, Benjamin L. Mott, and Lyman P. Mott, 6 December, 1894.

"Giles D. Acre bought Houghton (?) House and Lady Anne founded a Hospital for twenty children to be brought up there at one hundred pounds per annum. Within the Diocese of London Hospital of St. Thomas of Acars called Acon in the Holy Land, called Mercer's Chappel, dedicated to St. Thomas of Acres, etc. Lord D. Akers and Dame Anne Grystock, daughter Elizabeth, married Sir Thomas Nevil.

EPITAPH RHYME ENGRAVED

O Lord my Saviour and heavenly Maker
Have mercy of Elizabeth Graistock and D AKER."

CAPTAIN DANIEL WILLIAM SULLIVAN, S. S., son of John L. & Margaret Jane (Splaine) Sullivan, born April 30, 1848, married MARIA BELLAMY ACRES, 11 June, 1881, who was born 2 November, 1863: Had Daniel William Sullivan, Jr., born 24 December, 1883; Margaret Elizabeth, born 6 October, 1885; Robert Augustus, born 26 February, 1888. 1865, Youngest non-Commissioned Officer in U. S. Army, First U. S. Calvary; Co. M, Genl. Crook's Indian Scout, at California, Nevada, Oregon, wounded 1869 by Indians, shot through arm. See Army Records. Captain of Militia, Malden Police Department and Fire Department. Brother-in-law now actively engaged in Secret Service, at Pemberton Square, Boston.





Chapter XVII

GENERATIONS CLV and CLVI.

2. ELIZABETH FERNALD, daughter Dr. Renald and wife, Joanna Warburton, born 4 March, 1630; married 1 1670, Eastwick, after the document recorded her as "Maden" "gess unmard." Died in childbirth of Henry, 1674:
3. MARY FERNALD, May 5, 1634, daughter CLIV; married JOHN PART-
RIDGE, 11 December, 1660; died 16 August, 1722: Had 7 or "8" children.
Vide Partridge Genealogy for facts and data. Repetitions due to many genea-
logical records.
4. SARAH FERNALD, daughter 154, born April 3, 1636; married 3 December,
1660 ALLEN LYDE: Had Allen, born 29 July, 1666, who married had Eliza-
beth, born 15 November, 1692; Francis, born 28 September, 1695: Mrs. Sarah
Lyde married, 2nd, Richard Waterhouse, 19 June, 1672: Had Richard Water-
house, born 19 April 1674 or 5; Samuel, born 9 May, 1676; married: Timothy,
born ; Ruth, born , married John Gains;
Sarah, born ; Lydia, born , married
1, Captain Colby; 2, Elisha Dennet; 3, John Plummer, Judge.
5. JOHN FERNALD, born 1640 and d. a. s. p. unm. 1697. I have record of his
name interpolated.
SAMUEL FERNALD, born 4 March, 1642; married Hannah, sister of Mary,
and daughter of Thomas and Margery Spinney: Mr. Thomas Spynie, the first
schoolmaster of Maine, was a lineal descendant of Baron Spynie, of Scotland.
The barony was claimed by Colonel Fullarton, but was properly rejected by the
House of Lords, who resolved, 18 April, 1785, that the petitioner had no right to
the Barony of Spynie" The House of Lords and Colonel Fullarton had many of
the Fernald Records. Where are they now? Some records were found changed
four times.
7. WILLIAM FERNALD, born 5 March, 1646, married ELIZABETH LANG-
DON, 16 November, 1671, born September, 1656, died 11 May, 1740: Captain
William Fernald died July 5, 1728.

GENERATIONS 155-6.

- SAMUEL FERNALD, son of Dr. Renald and Joanna, born 1642; died 1 De-
cember, 1698; married HANNAH SPINNEY, daughter Thomas and Margery:
Had:
- 1, Sarah, born 17 June, 1678.
 - 2, Nathaniel, born 28 May, 1681, married Anne Allen, 10 September, 1702,
daughter Robert Allen and his lawful wife.





- 3. HANNAH, BORN 16 OCTOBER, 1684.
- 4. JOSEPH, BORN 21 DECEMBER, 1688.
- 5. MARTHA, BORN 18 FEBRUARY, 1692.
- GENERATION 155. Captain WILLIAM FERNALD, son of Generation 154, born 1646: married ELIZABETH (SHERBURNE) LANGDON: Had:
 - 1. Elizabeth, born 17 August, 1674; married Clement Deering, 25 September, 1701; died 2 June 1745: son Roger.
 - 2. William, born 31 October, 1676; died 6 December, 1683. (Deering said to be a descendant of Roger Williams.
 - 3. Tobias, born 26 December, 1678; married Mary Deering June 12, 1701.
 - 4. Margaret, born 27 March, 1681: married Solomon Cotton 14 May, 1702: son William Cotton. Portsmouth.
 - 5. Temperance, born 17 September 1683: married John Deering 12 December, 1705: 2, Ebenezer Moore; 6 children.
 - 6. William L., born 11 May 1686: married _____ died January 12, 1727.
 - 7. Joseph, born 21 December 1688.
 - 8. Sarah, born 24 April, 1691; married Jonathan Dane 28 October, 1711; died 15 November, 1748.
 - 9. Lydia, born 19 April 1693; married John Clark, 27 May, 1725; died 17 April, 1743: Had Mary: Elizabeth: Edward.
 - 10. Benjamin, born 11 July 1695; married _____ and died 19 April, 1738.
 - 11. Nathaniel, born 12 May 1698; married Margaret Triper April 7, 1720 and died 9 1 September, 1771.
 - 12. Ebenezer, born 7 October 1699; m. Patience Mendum, 22 December, 1724 and died 29 January, 1787.
 - 13. Tobias, born 3 December, 1702; married Mary Mendum, December 22, 1724 and died November 11, 1761; five of these children belong to another family or families.

GENERATION 154. THOMAS FERNALD, brother Dr. Renald and son of Captain, Commander Sir William Fernald, also was found spelt Fenner, Furnival, Fernerl, Furnel, etc., and his autograph was found in Boston on a receipt for payment of money recorded in (to the best of my remembrance) Mass. Historical Society Proceedings and wife Mrs. Elizabeth Amand, was born 13 August, 1597; married _____ Had descendants that in three or four generations died out and that line became extinct" declared to writer Rev. O. H. Fernald, who was actively engaged in genealogical work to aid his Nephew, Prof. H. T. Fernald, State Col. Penn., to whom my most courteous thanks for kind gift, of the American parts of my line of ancestry proved. Said Thomas and wife had Elizabeth, born 6 January, 1683, married Captain Stephen Eastwick and died 26 April, 1741, aet. 31 years 2 months 20 days, buried in Navy Yard, Portsmouth, N. H.

- GENERATIONS 155-6. THOMAS FERNALD, son of Dr. Renald and Joanna Warburton, his wife, married "THEMPRANCE," daughter of ROBERT WASHINGTON and ANNA COTTON, his wife, residing in Virginia, 1630. (See Plate 1252)
 - 1. Had JOHN, born 12 December, 1640; married Mary, daughter Thomas and Margery Spinney or de Spynie.
 - 2. ANNE, born 1651; married ROBERT ATKINS, 9 November, 1686, and died. Had children.
 - 3. THOMAS, born 2 July, 1653; married Elizabeth Hunkins, born 15 May, 1658; 2nd, married Mary about 1675.
 - 4. PATIENCE, born 3 March, 1655; married Captain Steven Eastwick.
 - 5. MARY, born 16 June, 1657; married Samuel Pray; 2nd, Thomas Parker. born 15 May, 1658.





6. SAMUEL, born 1 January, 1659; married SUSANNA PAUL, 12 October, 1699.
7. JOANNA, born 13 February, 1663; married CHARLES KELLEY, 25 May, 1699, and had issue.
8. SARAH, born 2 March, 1668; married WILLIAM HENDERSON, 16 July, 1700; 2 children. Elizabeth married.
9. HERCULES, born 29 September, 1688; married MARY FUNAL, daughter Rev. Peter Funal, and wife Sarah, son of Daniel and wife Mary Moulin, who were the ancestors of Peter Faneuil who is buried as Peter Faneuil and Peter Funal in Old Granary Cemetery, Boston: Daniel Furieu was the 13th son of Francis, son of Dr. Jean Fernel, the son of Charles VIII and Anne. Hercules married, 2nd, Sarah that was not Sarah Hinckes, daughter of Judge John and wife, but Hickes. Elizabeth was daughter of Thomas, brother of Dr. Renald Fernald. Hercules son
1. JOHN, born 2 August, 1718; married Margaret Fernald, 7 September, 1739; died 20 January, 1790.
2. JANE married SAMUEL GUNNISON, 6 February, 1745 or 6; died 20 January, 1750; 2nd, he married ALICE FERNALD.
3. SARAH, married THOMAS FERNALD, published 1 December, 1744, and his 2nd wife.
1. CHARLES, son of Roger KELLY and brother of Sarah, Ruth, Abraham, Ellsha, Roger, married JOANNA, daughter Thomas Fernald, and had Mary, born 27 December, 1699, married after 1721, Roger, Deputy General Court.



Plate 1345. ANCESTOR MR. THOMAS FERNALD AND TEMPERANCE WASHINGTON, HIS WIFE. ISLAND. THE SEAL OF SAMUEL WASHINGTON FERNALD COAT OF ARMS AND UNIVERSAL SHOULD BE MOTTO: U. S. BATTLE SHIP. Copy: A Plot of Mr. Thomas fernald Island taken Nov. 20, 1702, By order of Mistris Temperance (Washington da. of Robt. and wife Anna, da. Sir Robert Cotton, of Va.) fernald Relict and Administratrix of the Deceased and the several Divisions made thereon By order and Consent of children surviving the sd. Thomas Fernald Deceased above sd. the sd. were taken By Election and By Lott To the Consent of Each person as their part or portion of sd. Island and are Distinguished by Town names Being Sett in each Division or part By first Consent of sd. administratrix and children of the Deceased after Surveys for the Town of Kittery. Attest: William Godsoe." The cardinal points are indicated by a symbol of Fleur-de-lis of Fernald coat of arms arranged as Handle and hilt of our ancient C. Furnius Roman Sword.

ROBERT FERNALD, BROTHER DR. RENALD FERNALD, WAS BORN 20 MARCH, 1604, LIVING IN VIRGINIA, 1623-4, AND NAME SPELT FENNELL IN MUSTER ROLL OF THE INHABITANTS OF VIRGINIA, CAME OVER IN THE CHARLES, 1624, AGED 20 YEARS. MARRIED
HAD CHILDREN.

GENERATIONS 154-3.

ROBERT FERNALL, son Francis, born 1563, son Francis, born 1533, came to America in London Merchant, Va. 1619, act. 31 years, born 1588; married (See Plate No. 1059) Had children.

GENERATION 151 or 3. COUNT JOHN FERNEL, brother-in-law of Henrietta and Louise de Coligny, was thus written to by Louise: "I hardly know how the children and I are to maintain ourselves according to the honor of the house—MAY GOD PROVIDE FOR US." Thus wrote and prayed the sister of beautiful Annietta to her brother-in-law, Count John," as she was bereft of two good husbands. Fr. 2, Francis m. c. Anthony Bonall, born 1579, La Guard, James Bonall, twins; John Vennell, born 1581. These three went to Virginia, and were living there 16 February, 1623. Anthony came over in the Abigail, 1621.

GENERATION 152. MARIA, 2nd child Francis, 1, and wife, Maria Commenius, and of same family as Louise Marie de Cormenins, who gave his great and true work on history of the Popes, a great work that has been translated from the French. Said MARIA FERNEL, married Captain George Fulton Smith, born 10 June, 1559; Captain John Smith, born at Willoughby, Lincolnshire, England, January, 1579, and died at London, 21 June, 1631, and grandson of Thomas, probably Sir Thomas, who was born 1514, and died 1577, that was employed to negotiate an alliance in France, 1572. Somerset was his patron, and during reign of Mary he was deprived of all offices, but reinstated temp. Queen Elizabeth. George and Maria Smith had children, viz., Capt. John, married: Had 1 John Smith, born 1608; died 1652, August 7. Had descendants, Thomas, born 1638; married; had Edmund, born 1668. 2, Jo. Miles Smith, born 9 November, 1579; died 1624; married: Had James and Edward: one went to Ireland: married: had James who married and James, a signer of the Declaration of Independence, that was born about 1719: From Monmouth Rebellion 1682 out of Bridgwater Prison that came from Taunton were, John and William Smyth. 62 by the name of Smith and 4 are recorded in "Lists from 1600-1700" by James W. Bouton of those that came to America. It is interesting to find the names of Francis, Frances, Maria, Anne, Ann, Joan, Elizabeth, Margaret, Margerie, Robert, John, Richard and Samuel; giving a great field for search into the history of these numerous and worthy families.

GENERATION 152. ANNE, 3rd child, born 20 November, 1560; married SAMUEL WASHINGTON, whose nom de plume was William Shakespere; vide ante.

GENERATION 151. JOHN, son of Dr. Jean Fernel, born 3 February 1535; married Francis, daughter Sir James Foljambe and Alice, daughter Thomas Fitzwilliam and Anne, daughter Sir Nicholas Pagenham, Knight, said Thomas, slain at Flodan; also a brother, John Fitz Williams, died. Thomas was son of Sir Thomas Fitz William and Lucy, daughter and co-heirs of John Nevill. Their descendants were numerous:—JOHN & FRANCES, married 1553 and had: Prosper Farinaccio an Italian Attorney, born 1554 at Rome; died at Louvene 1631: Calo Farina, born at Andria, 1556; and died 1640: married; had Carlo: John: William and Thomas: Francisco, born at Milan, 1577; died 1669 at Milan.

GENERATION 152. WILLIAM FABRICUS, b. 1560; d. 1634, AET. 74, AND WAS A SURGEON. THOMAS FIENUS, b. AT ANTWERP, 1566: d. AT LOUVENE, 1631.

PROSPER FARANACCIO m. OCTAVIA FERRARI, da. Octavian, b. 1518: d. 1586. She was b. 1555, d. 1625, m. 1576: had Emanuel, b. 1590, d. at Madrid, 1650: Paul Ferri, b. 1591, d. 1669: the Reverend Charles Frelincourt or Delincourt b. at Sidon, 1595, d. 3 Nov. 1669, m. 1625 Sarah, da. of Comenin & Cicely, b. 1600: had 16 chn., Lawerance and Henry, both ministers: Charles b. at Paris, 1633, a Dr. d. at Leyden, May, 1692, m. had Charles: Anthony, b. at Orbes, Switzerland, a Dr. A son, d. at Geneva studying Divinity: Peter, Dean of Armagh, 7th Son, Frelincourt: six more sons and 2 das. d. y. another da. m. Malnoc, Advocate parliament of Paris and his influence was not great enough to regain from the Roman Catholic Church the money of Dr. Jean Fernel that now amounts with the interest to several times more than the wealth of the World, which a large mass of it was sent by check for great good to the lawful Nations of Earth which amount is so large that it can never be paid by R. C. C.

GENERATION 153.

HERCULES FERNALD, brother of Samuel, b. 29 Sept. 1688, m. MARIA da. Rev. Peter Fernald the "Protestant Goliath" and father of Peter Faneuil bur. in Old Granary Cemetery, b. July 1, 1696, m. 4 Apr. 1705. Had John, Francis, Daniel and Peter. Mrs. M. MARIA FERNALD d. 1717, Jan. 31 and then he m. SARAH HICKES, da. of George Hickes, an eminent English divine, b. 20 Jun. 1642, d. 15 Dec. 1715. At Paris he was a friend of Justell, Henry, who gave him MSS. to present to Oxford. Born at Newsham, Yorkshire. His bro. John 1685 joined the duke of Monmouth's Rebellion, captured, exiled. Children by 2nd wife:—John, b. 25 August, 1718, m. Margaret Fernald, 7 Sept. 1739, d. 1790: Jane, b. 1719, m. Samuel Gunnison, 6 Feb. 1745 or 6, d. 20 Jan. 1750: Sarah, b. 1721, m. Thomas or Benjamin Fernald, pub. 1744 or 5.

GENERATION 156.

F SAMUEL FERNALD, b. 1 Jan. 1659, s. of Thomas & Temperance (Washington) Eldest s. Dr. Renald & Joanna (Warburton) m. Susanna, da. Stephen & Katherine Paul, 12 Oct. 1699, d. 13 Feb. 1746: had Temperance, b. 25 Oct. 1702: Samuel, b. 1 Mar. 1704; m. Joanna Furbish, 20 Feb. 1731, d. 1775: Susanna, b. 1706, m. William Lawry, 12 Nov. 1727: Hannah, b. 1708: Thos., b. 1711, m. Hannah Whitney, 16 Nov. 1733: Hercules, b. 8 Sept. 1713, m. Mary Tucker, pub. 18 Mar. 1735-6, Elizabeth, b. 5 May 1715, m. Ann, b. 1717, m. Moses Fowler of Durham, N. H. pub. 29 Apr. 1743.

GENERATION 156.

HERCULES FERNALD, brother of Samuel, b. 29 Sept. 1688, m. MARIA da. Rev. Peter Fernald the "Protestant Goliath" and father of Peter Faneuil bur. in Old Granary Cemetery, b. July 1, 1696, m. 4 Apr. 1705. Had John, Francis, Daniel and Peter. Mrs. M. MARIA FERNALD d. 1717, Jan. 31 and then he m. SARAH HICKES, da. of George Hickes, an eminent English divine, b. 20 Jun. 1642, d. 15 Dec. 1715. At Paris he was a friend of Justell, Henry, who gave him MSS. to present to Oxford. Born at Newsham, Yorkshire. His bro. John 1685 joined the duke of Monmouth's Rebellion, captured, exiled. Children by 2nd wife:—John, b. 25 August, 1718, m. Margaret Fernald, 7 Sept. 1739, d. 1790: Jane, b. 1719, m. Samuel Gunnison, 6 Feb. 1745 or 6, d. 20 Jan. 1750: Sarah, b. 1721, m. Thomas or Benjamin Fernald, pub. 1744 or 5.

GENERATION 157-8.

DEACON JOHN FERNALD and his wife, SARAH, da. Judge John and ELIZABETH HINCKS, had nine children. 1st, John, b. 1698, had six children: John, Mercy, Polly, Ann, m. a cousin, Mr. John W. Fernald, v. m. Mr. Dennet, Lt. Col. Tobias Fernald, (see Letter) Polly m. Wm. Cotton, had children: Mary, da. Dea. John, m. Thomas Rogers, had 8 children: Brother Joseph, m. Anna More, pub. 1742, had William, b. 1757, baptized July 24, 1757, 1st church, m. Molly, b. 1759, d. 13 Sept. 1822. He d. 1816. Had John, b. 2 Dec. 1781, d. 22 Jan. 1860. William, Jr., b. 1783, d. Jan. 1784. Daniel, b. 10 Nov. d. Sept. 1812. William Fernald, 2nd, s. b. 27 July 1786, d. 21 March, 1863. Samuel Fernald, b. 15 June 1788, d. 19 July 1855. Joseph, b. 21 Apr. 1790, d. 8 May 1832. Thomas, b. 19 Mar. 1792, d. 20 May 1849. Benjamin, b. 15 Dec. 1793, d. 19 July 1825. Mary, b. 22 Apr. 1796, d. 1 July 1841. James, b. 25 Feb. 1798, d. 1804. Sally, b. 1802, d. Betscy, b. 5 Jan. 1806, d. 23 Apr. 1823. Molly (Clements) Fernald. WILLIAM FERNALD, b. 1786, m. Lydia Clements, b. 21 Feb. 1786, d. Oct. 9, 1869: Had Elsie Ann Fernald, b. Mar. 2, 1814. Lydia, b. 31 May 1816, d. Wm. Henry b. 17 Oct. 1818, d. 1821. Martha, b. 16 Feb. 1821, d. 8 Jan. 1890. William, b. 8 March 1823: Soldier in Second New Hampshire Regiment: d. 1876.

S

DANIEL, BORN 18 FEBRUARY, 1825; DIED 15 OCTOBER 1826: JOSEPH FERNALD, BORN 4 SEPTEMBER, 1830; MARRIED MISS LOUISA STODDARD CROCKER, DAUGHTER DANIEL S. CROCKER AND WIFE DEBORAH Prior, married 25 December 1861, had children. Charles Pierce Fernald brother Joseph was born 3 August, 1832 and died from accidental poisoning with "Water Hemlock Socrates poison" 10 June, 1838. Joseph was in thirteen battles in the Civil War and wore the Oak Leaf of Fort Fisher. He died in Medford, Mass., killed by a fractured skull, although footprints were seen beside his dead body, there were no police investigations. His beloved wife did not long survive him. Nor the sudden death of Captain Martin L. White at Charlestown that was said to have been shot by a needle gun, and face showed it.

GENERATION 156-7. EBENEZAR FERNALD, son Captain William, son Dr. Renald, born 7 October, 1699 married 22 December, 1724, Patience, da. Jonathan and Sarah (Downing) Mendum and died 29 January, 1787. Wife died 5 January, 1775, aet. 74: Had Alice, born 21 January, 1726, married Samuel Gunnison, 3 May, 1752: Sarah born a twin, married Benjamin Fernald 6 March, 1746; died 13 May, 1801: Joanna, born 17 February, 1728: married Simeon Dane, 11 May, 1749; 4 children: Ebenezer, born 27 March, 1729: married Sarah Lewis; died 9 June, 1807; Jonathan, born 31 August, 1731, married Sarah Weeks, 21 August, 1755; Olive, born 25 February, 1733; married Relicker Weeks and died 25 July, 1774: Dorothy, born 25 February, 1733: died 29 May, 1791: Elizabeth, born 4 February, 1736, married Benj. Underwood, 7 September, 1762, 2d 4 May, 1780 married William Holbrook: died 14 May, 1844: 5 children: Simeon, born 28 September, 1738, married Margery Gunnison, 14 November, 1763: Miriam, born 13 April, 1741, married Timothy Fernald, 10 May, 1764: died 6 March, 1766: Patience, born 16 December, 1743, died 7 August, 1749: Joshua Downing, born 22 July, 1748, died 5 August, 1749.

GENERATION 157-8. JONATHAN FERNALD, son of above, married 21 August, 1752 Sarah, daughter Joseph and Sarah (Haley) Weeks and died 26 December, 1789: Had Joseph Weeks, born 4 June, 1756, married Catherine Chandler, born 15 March, 1758, married Daniel Crosby of York, 17 April, 1791: Sarah, born 5 August, 1760, married Capt. James Brown 9 March, 1783 and died 3 February, 1822: Daniel, born 19 June, 1762, married Hannah Manson 8 August, 1791: Elihu, born 3 October, 1763, married Hannah Chandler 18 January, 1787: Mary, born 17 November, 1765, died 26 January, 1803: Samuel, born 20 December, 1767, married Elizabeth Chandler, 2d Mrs. Catherine (Fernald) Keen; Lucy, born 28 May, 1771, married William Fernald, 14 April, 1793 and died 2 July, 1867: Jonathan, born and died 1773: Hannah Moore, born 14 July, 1774, married Joseph Keen, November, 1794: Jonathan, born 3 July, 1776. Died.

GENERATION 158-9. DANIEL FERNALD, son of Jonathan above, born 1762, married Hannah Manson, daughter Joseph and _____, born 27 July, 1767 and died 24 June, 1846. He died 9 May, 1838: Had descendants:—Lucy, born 23 November, 1791, married Capt. Samuel Pray 5 November, 1808, died 23 October, 1826: William Manson, born 7 April, 1796, married Abigail W. Barry of Boston, 3 December, 1820, died 8 May, 1875. Lived in Portsmouth. In War, 1812. 5 children: Appia Marja. b. 2 June 1798, married Capt. Samuel Badger 19 July, 1817, d. 3 April, 1848, 7 children: Daniel, born 1800 and died 1800: Lavina Lyman, born 24 September, 1802, married Benjamin C. Fernald 27 October, 1824 and died 15 October, 1857: Albert, born 17 February, 1806, died 29 September, 1819: Charlot Martin, born 3 March, 1808, married Joseph Cox, 8 February, 1829, died 24 July, 1870: Frederick Waterman, born 8



September, 1810, married Harriet Rockwell Cate 29 December, 1834, 2d Mrs. Phebe (Abrams) Chamberlain 19 September, 1850, died 30 April, 1855. Lived at Portsmouth, N. H. 5 children: Appia Maria Fernald, wife of Capt. Samuel Badger were the parents of MR. SAMUEL AUGUSTUS BADGER of Boston, who was a most estimable religious gentleman very prominent at Union Congregational Church, Columbus Avenue, gave me some notes of his descent from the Bellamy family and died 1908.

GENERATION 154.

STRONG STRANGE FERNALD, brother Dr. Renald, ship carpenter, born 1614, married AELLONE 1641, had: Elizabeth, born 7 and baptized 14 May, 1643; Mary, baptized 10 August, 1645; Joanna, baptized 26 February 1647; Susan, born 14 September, 1652; died 1652; John, baptized 28 January, 1654; William, baptized 1655: he died and his widow married 1659 Michael Lambert. Children: WILLIAM of BOSTON, a Butcher, and son of Rev. Daniel, son of Francis, son Dr. Jean, married Ellen and had: Joanna, b. 9 December, 1652; William, born 29 July, 1654; Joseph, born 19 January 1657. I do not find their descendants, if any.

GENERATION 157-8.

DEACON JAMES FERNALD, son of John and Mary Spinney Fernald, was born 1676, married Mary Hincks, and died 1740 (per Rev. O. H. F.) daughter Judge John and Elizabeth Hincks, daughter Judge Nathaniel and Christian Freyer, of Portsmouth, although in the Hincks Genealogy, the daughters named are three and one not named may have been Mary that may have married Thomas Gross. Had Elizabeth, born 8 September, 1706, married James, son Daniel and Hannah (Libby) Fogg, 23 October, 1728; died 1766: Mary, born 14 May, 1712; married John, son John and Amy (Dennet) Adams, 15 October, 1734; 7 children: Joanna, born 19 January, 1713 or 14; married George Rogers, published 25 December, 1736; Anna, born 28 October, 1716; married Joseph Fernald, published 14 June, 1737; Margaret, born 13 January, 1719 or 20; married William Hammett, published 26 September, 1741; Dorcas, born 14 September, 1722; married John Seavey, published 8 December, 1744; Eunice, born 13 March, 1725; married John Gunnison, published 18 September, 1742; 1 child; He married Rebecca Norton, 10 February, 1747; 6 children: James, born 24 May, 1728; married Mary Fernald, 7 April, 1748; Deacon James had a grant of 30 acres of land, 1699, and he or his son James purchased 580 acres and 19 rods, November, 1818, Strafford Co.; died 1740; wife died between 1740 and 1742. See Plate 1342.

GENERATION 157-8.

THOMAS FERNALD, son John and Mary Spinney, his wife, was born 1678; married 28 November, MARY, daughter JOHN AND SARAH (Remick) THOMPSON: Had: William, born 1 November, 1701; married Hannah Seavy, 24 June, 1724; Lydia, born 11 February, 1703; married Moses, son Alexander Dennet, of Portsmouth, 11 February, 1723 or 4; died 15 July, 1749; Mary, born 22 April 1708; Hannah, born 22 February, 1710 or 11; married Benjamin Welch, of Ipswich, 9 November, 1736; Margery, born 10 December, 1713; Thomas, born 3 March 1716; married daughter Hercules Fernald; 2nd, Grace Remick, 4 November, 1755; 3rd Eunice Lewis: Abraham, born 14 November, 1719; married Mary Trickey, 16 May, 1742; Benoni, born 17 February, 1723.

GENERATION 156-7

NATHANIEL FERNALD, born 1681, son Samuel and Hannah son Dr. Renald; married ANN ALLEN, daughter Robert and Hannah (White) Allen, 10 September, 1702, at Dover, New Hampshire. Rev. John Pike officiated. He was a Shipwright. Will probated 4 April, 1748: Had: Tobias, born 25 August, 1703; married Abigail Smith: Nathaniel, born 19 February, 1707; married Mary Weeks, 10 October, 1734; Elizabeth, born 17 July 1710, not in will: Hannah, born 19 February, 1712; married Bryant Bradeen, 27 December, 1733; Ruth, born 22 May, 1717 (two Timothy names may or not belong here). Ruth is recorded as married Mr. Knight.



A WILLIAM FERNALD OF PORTSMOUTH, MARRIED 31 JULY, 1707, ELIZABETH, DAUGHTER WILLIAM AND ABIGAIL (GREENLEAF) COTTON. HE DIED 12 JANUARY, 1728, AND HIS WIDOW'S WILL PROVED 1761 (See Ante) Aforesaid William, son of William of Boston and wife Ellen, born 29 July, 1654; moved to Portsmouth, N. H., and brother; Joanna. born 9 December, 1652,

GENERATION 155-6. and Joseph, born 19 January, 1659. Had Mary, born 13 March, 1711; married Mr. Mendum: William, born 10 February, 1713; Abigail, baptized 10 April, 1715; JOHN, baptized 31 May, 1719; m. Abigail Coffin; moved to New Hampshire, (A cousin, of John married Mary Savage,) and was buried in Mr. Young's cemetery at Wolfboro: Elizabeth, baptized 15 October, 1721: George, baptized 27 October, 1723; married Elizabeth Lang, 2d Anna Leach: Abigail, baptized 15 May, 1726:

GENERATION 155-6. BENJAMIN FERNALD, son William, son Dr. Renald, born 1695; married Catherine Hammond; died April, 1743: Had Joseph, born 5 May, 1719; married Anna Moore, of York; Benjamin, born 27 June, 1721; married Sarah Fernald, 6 March, 1746: Josiah, born 29 June, 1724; married Mary Pierce, 26 November, 1748; resided in New Castle, N. H.: Mark, born 19 August, 1726; married Mary Simpson, 3 May, 1752; died 14 May, 1779; lived in New Castle: Catherine, born 8 July, 1735: And Edward, baptized 7 December 1729.

GENERATION 155-6. NATHANIEL FERNALD, son Captain William, son Dr. Renald, born 1697; married 7 April, 1720, MARGARET, daughter Sylvanus and (Diamond) Tripe; He died 18 September, 1771, and wife the same month: Had MARGERET, born 6 January, 1721; married John Fernald, 16 September, 1739; died April, 1791: Tobias, born 27 March, 1723; married Lucy Lewis, 19 May, 1748: Elizabeth, born 2 October, 1725; married Samuel Johnson, 19 May, 1748, and Rev. Wm. W. Johnson wrote that they went or belonged to the British Provinces or Canada; married 2d. or published to Edward Ingraham, 2 June, 1766; died 6 April, 1818: Abigail, born 30 November, 1727; married James Caswell, 17 November, 1748; died 28 January, 1776; Joshua, born 29 June 1730; died 18 September, 1748: Mary, born 5 August, 1732; died 10 September, 1749: William, born 16 September, 1739; married Abigail Dennet, 28 June, 1763:

GENERATION 156-7. CAPTAIN TOBIAS FERNALD, born 1702; son Captain William, son Dr. Renald; married MARY MENDUM, daughter Jonathan and Sarah (Downing) Mendum; died 11 May, 1761, and wife, Mary, died 16 October, 1767: Had Dennis, born 7 December, 1725; married Sarah Frost, 9 October, 1750: Mary, born 5 August, 1728; married James Fernald, 7 April, 1748; died 25 May, 1761: Miriam, born 26 March, 1733; died 8 April, 1739: Robert, born 11 December, 1736; died 7 March, 1741; Robert, born 2 March, 1741; died 1764, in London, England: Tobias, born 1 February, 1743 or 4; married Dorcas McIntire; 2d, his widow married Richard Rogers, 18 December, 1786: Eleazar, born 23 September, 1746; married Margery Staples, 31 January, 1771:

GENERATION 158-9. LIEUTENANT COLONEL TOBIAS FURNALD, son of Captain John and Elizabeth (Rogers, daughter Rev. John, of Ipswich,) son Deacon John and Sarah (Hinckes, daughter Judge John and Elizabeth,) son of Dr. John and Mary (Spynic, daughter Thomas and Margery,) son of Thomas and Temperance (Washington, daughter Robert and Anna, of Virginia, 1630,) eldest son of Dr. Renald and Joanna (Warburton) Fernald, was born 3 December, 1743; (married MARY, daughter NATHANIEL FERNALD, Gentleman, and MARY, his wife,) born 22 August, 1741; married 27 November, 1759: Had Miriam, born 1



U

JANUARY, 1761; MARRIED WILLIAM LEIGHTON; MARRIAGE INTENTIONS PUBLISHED 23 NOVEMBER, 1777; 12 CHILDREN. HANNAH, BORN 2 JANUARY, 1761, AT 1 A. M., AND SISTER AT 12 P. M.; MARRIED 17 MARCH, 1780, MR. ELISHA GURNEY: NANCY, BORN 6 FEBRUARY, 1763; MARRIED JOHN ROGERS, 26 DECEMBER, 1790, NEWPORT, MASS.

8 children: Eleazer, born 23 September, 1765; married Margery Staples. 31 January, 1771, born 18 November, 1747, daughter Nathaniel and Margery, who died in 1826, and he died at Ossipee, N. H., 1823; had 6 children: Mary Washington White, born 25 April, 1766; married Mr. Samuel Fletcher, 11 October, 1812; died 26 April, 1860: Archelaus, born 16 March, 1769; married Eunice Trefeather: Peletiah, born 2 August, 1771, went to England, and married Anne, daughter Rev. Isaac Barrows; Had 8 sons: Charles; John; Francois, that went to and settled in France: William went to and married in Italy, Rome: David went to Scotland: Tobias to Germany, and Thomas that lived and died, married with children in London that a descendant called on the writer, 1895, and gave to me some some of these last facts with the names of his father, Nathaniel, and grandfather, Josiah, the son of Thomas, which to interest after searchers I will here give the following brief connection of that illustrious family that had many descendants in United States the First Census by General George Washington of 1790, and are all the Fernald relatives. It grieves me much more, for what I cannot do for you. TWELFTH NIGHT.

F

DR. ISAAC BARROW was the son of Mr. Thomas Barrow (A Citizen of London of good Reputation yet living, "1722" Brother to Isaac Barrow, Esq., of Spiny Abby in Cambridgeshire (where he was a Justice of the Peace for 40 Years) Son of Philip Barrow who has in Print a Method of Physic, and had a Brother Isaac Barrow Doctor of Physic, a Benefactor to Trinity College, and there Tutor to Robert Cecil Earl of Sailsbury and Lord Treasurer." 1st sd. Dr. Isaac Barrow "was born in London, October, 1630.* His mother was Anne, Daughter of WILLIAM Buggin of North Gray in Kent, Esq.; whose Tenderness he did not long enjoy, she dying when he was about four Years old." Vide Life of Dr. Isaac Barrow, M. D. p. And footnote—"Dr. Pope in the Life of Bishop Ward, p. 129, says this is a mistake; but it was not, as appears from Dr. Barrows Epitaph from his Father's information, and mentioned by Dr. Pope himself, page 169." The name William Buggin was in fact one of the changes from the persecutions necessary for the descendants of Dr. Jean Fernel, therefore William Fernel alias Buggin, a descendant from second son Count John Fernel, nor does this remarkable proof all rest here for in the Works of the Learned Isaac Barrow, D. D., in three Volumes Large is his Portrait that has the Coat of Arms of our Ancient Family: viz.—On shield four "fleur-de-lis," two cross X swords (ours three) Helmet top of shield and the Crest a squirrel eating a savory nut with great enjoyment. His portrait is a well marked typical Fernald face. He died the 4th of May, 1677. "In the Epitaph, Dr. Mapletoft, his much esteemed friend, doth truly describe him: his picture was never made from life, and the effigies on his tomb doth little resemble him. He was in person of the lesser size and lean, of extraordinary Strength, of a fair and clear Complexion, a thin Skin, very sensible of the Cold; his Eyes grey, clear and somewhat short sighted; his Hair of light auburn very fine Curling. He is well represented by the Figure of Marcus Brutus on his Denarii, and I will transfer hither what was said of that great Man. Virtue was thy Life's great Centre and from thence Did silently and constantly dispense The gentle vigorous Influence To all the wide and said Circumference."



NOW TO HONOR A WORTHY DESCENDANT OF DR. JEAN FERNEL'S SECOND SON, AND BROTHER OF FRANCIS WHO KEPT ACCOUNT OF 2ND SON BY CROSSED TWO SWORDS FORMING V AND A. ALSO TO call attention to the many small and beautiful faces to be seen by a magnifying glass on the stick like frame, title page etc. around the EPITAPH it is given verbatim and viz. :

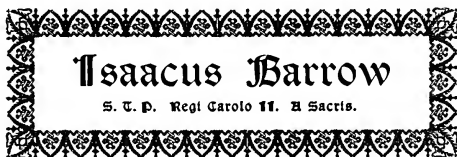

VIR prope Divinus & vere Magnus, si quid magni habent

Pietas, Probitas, Fides, summa Eruditio, par Modestia, Mores sanctissimi undequaque, & suavissimi. Geometriæ Professor Londoni Greshamensis, Gracæ Linmæ, & Mathesos apud Cantabrigienses suos, Cathedras omnes Ecclesiam, Gentem, ornavit. Collegium S. S. Trinitatis Præses Illustravit, Jactis Bibliothecæ vere Regiæ Fundamentis auxit, Opes, Honores, & universum vitæ Ambitum, Ad majora natus, non contempsit, sed reliquit seculo. Deum quem a teneris coluit, cum primis imitatus est. Faucissimisegendo, benefaciendo quam plurimis, Etiam posteris, quibus vel mortuus concionari non destinit. Cætera, & pene Majora ex scriptis peti possuit. Abi, Lector, & æmulare. Obiit IV, Die Maii, Ann. Dom MDCLXXVII. Ætat XLVII. Monumentam hoc Amici posuere.

GENERATIONS 158-9 THOMAS FERNALD, son of Samuel, born 1659, and Susanna Paul son THOMAS and TEMPERANCE WASHINGTON, s. Dr. Renald and Joanna Warburton, their wives, was born 5 July, 1711; m. HANNAH WHITNEY, 16 November, 1733, daughter John and Lettice Whitney. He died 1794; will probated October. Their descendants recorded: Henry, baptized 2 November, 1735: Thomas, baptized 23 January, 1737: Margery, baptized 16 December, 1739: William, baptized 19 April, 1741. Said Thomas was given as married Pamela Jones, 13 September, 1787, and John, born 1738; died at Sea on Brig Sally, 8 August, 1767: Hannah, born 17 January, 1744: Eunice, born 3 February, 1746; married Andrew Grace: Susanna, born 7 January, 1751; married Samuel Fowler; 2nd, Mr. Todd: died 15 May, 1841: Lettice, born 7 December, 1854; married Andrew Phillips, 19 March, 1843. He was Sergeant in the Revolution. Had five children.

HERCULES, son Samuel, son Thomas and Temperance Washington Fernald, son Dr. Renald, and said

GENERATIONS 157-8. HERCULES, born 8 September, 1713; married MARY TUCKER, born 23 March, 1719; marriage intentions published 18 March, 1735 or 6: Had: Alice, born 24 May, 1737: Susanna, born 29 July, 1740; married David Duncan:



MARY, BORN 29 OCTOBER, 1742; JOEL, BORN 13 FEBRUARY, 1745; MARRIED ELIZABETH PETERS: JOSIAH, BORN 11 MARCH, 1746 OR 7; DIED YOUNG: HERCULES, BORN 4 DECEMBER, 1749; MARRIED MIRIAM PERCY, OF YORK, 30 JANUARY, 1772; DIED 27 OCTOBER, 1833, in American Revolution of North Berwick: Josiah, born 19 September, 1751: Stephen, born 21 August, 1754; resided in Rochester, N. H.: Sarah, born 1756: Esther, born 5 September, 1759; married.

GENERATIONS 157-8. JOHN FERNALD, born 25 August, 1718, son Hercules and Sarah (Hicks) son Thomas and Temperance (Washington), son Dr. Renald Fernald and Joanna (Warburton), married 7 September, 1739, MARGARET, daughter Nathaniel and Margaret, born 6 January, 1721: died 1791; He died 1790, at Kittery: Had: Sarah, born 5 April, 1740; died small pox: Archelaus, born 25 September, 1741; died 1 January, 1760, at Sea: Joshua, born 7 August, 1743; married Elizabeth White, 18 November, 1764: Margaret, born 8 April, 1745: married Mr. Moore, of Sanford, Me.; died November, 1843: Pelatiah, born 22 April, 1747 (See above) married and settled in England: John, born 20 February, 1750; married Mary Fernald, daughter Tobias and Lucy: Jane, born 30 April, 1752; married Captain John Seavey, 1 October, 1776; 2nd, John Stevens; died 17 February, 1836: Mary, born 10 April, 1754; married William Pierce, of New Castle, 16 November, 1783; d. 30 June, 1845: Abigail, born 29 April, 1758; married Benjamin Remick, 15 January, 1777; died 22 October, 1825: Betsey, born 2 September, 1758; married Wentworth Ricker, of Somersworth, N. H., 21 June, 1778: Miriam, born 20 April, 1762; married Samuel Fletcher; died November, 1812: Archelaus, born 16 March, 1769; married Eunice Trefethen, 10 June, 1790; died 24 November, 1853.

GENERATIONS 156-7 JOHN FERNALD, son of William and Elizabeth (Cotton), son Captain William and Elizabeth (Langdon), son Dr. Renald and Joanna (Warburton), baptized 31 May 1719; married Abigail Coffin.

GENERATIONS 157-8. JOHN FERNALD, son of Joseph, born 19 January, 1659, son of William the Butcher and wife Ellen, said William a brother (twins) of STRONG STRANGE, born 16 November, 1614, "if the record be true which the preponderance of evidence of 1895—caused me to throw out and now to bring back from like work in Old Kittery, written by E. S. Stackpole and by Prof. H. T. Fernald, prepared to honor which the data said Mr. John Fernald, born about 1696, son Joseph Fernald and Mary, daughter Samuel Fairbanks, a reputable and well represented United States Family, married "Elizabeth, daughter of Richard and (Eleanor Heard) Rogers, 16 January, 1723 or 4. He married (2) Dorothy Main of York, 19 January, 1730—31. He was a farmer and died before 18 April, 1738, at which date the widow was appointed administratrix. Children: John, born—; married—, and had a son James: Mercy, born—: Elizabeth, born 2 December, 1731: Child, born posthumously. This John is one other of "14 John Fernalds" reported by Rev. O. H. Fernald mistaken from a proved line.

GENERATIONS 157-8. SAMUEL EERNALD, son Deacon John Fernald and his wife Sarah (Hinckes) son John and Mary (Spinney), son Thomas and Temperance (Washington), son Dr. Renald and Joanna (Warburton) was born 1 June, 1702; married MARY, daughter Samuel and Eizabeth (Haskins) JOHNSON, 26 February, 1729-30: Had Samuel, born 1732: Noah, born 1735: Mary, born 1740. As all of these children died single persons, unmarried, they will the Farm to their cousin, Mr. Nathaniel Staples. Will probated 1798.



F

DEACON JAMES FERNALD, BORN 1704, SON DEACON JOHN AND SARAH HINCKES FERNALD, M. PUBLISHED 30 OCTOBER, 1730, TO HENNAH, DAUGHTER REV. JOHN AND HANNAH (FOGG) ROGERS, BORN 11 JUNE, 1710: HAD DESCENDANTS: KEZIAH, BORN 3 APRIL, 1734; MARRIED MR. RICHARD GOWELL, 9 JANUARY, 1752; 2ND,

Timothy Hanscom: John, born 3 July, 1737; married Sarah Wentworth, 17 April, 1759; Hannah, born 7 May, 1740; m. Capt. John Wentworth, 1758; 2 children; married 2nd, Sarah Bartlett, 17 September, 1762; James, born 20 September, 1744; married Abigail Wentworth, 1762. The writer has been unable to find other than the above ancestry of said Deacon James, s. of Deacon John and Sarah Hinckes F. The above record is given from "OLD KITTY" printed 1903. The next is true.

GENERATIONS 157-8. DEACON JAMES FERNALD, brother Captain John Fernald that married Elizabeth, daughter Reverend John and Martha Rogers of Ipswich, as is declared with Seal of the Town which I have before me, married Mary, daughter Judge John and Elizabeth Hinks; he was born 1676, and record from Rev. O. H. Fernald gives her as the sister of Sarah Hincks who married John Fernald, therefore as the first daughter's name of the family is not mentioned, probably she was the lady. Aforesaid Deacon James, son of Dr. John, married Mary Spinney, son Thomas married Temperance Washington: Their descendants were: Elizabeth, born 8 September, 1706 (See previous record) Deacon James, son James, 8th child born 24 May, 1728, married Mary, daughter Lieutenant Colonel Tobias and Mary (Mendum) Fernald, 7 April, 1748. He died 17 March, 1757, and wife died 26 May, 1761. Said Lieutenant Colonel Tobias Fernald, son Captain John and Elizabeth (Rogers, Ipswich) (See his letter) JAMES F. had descendants. Said Lieutenant Colonel Tobias was living at Middleton with Uncle John in 1790. Deacon JAMES, born 16 February, 1749; married MARY STACEY, 30 November, 1769; Mark, born 26 May, 1751; Mary, born 20 June, 1753; Benjamin, born 17 January, 1756. Sunday, July 28th, 1895, I visited the Tomb, and on Martin Monument found:—Deacon James Fernald Died September, 1823, and Mary his Wife Died December 2d, 1831. Aged Persons, parents of Lois, Wife of Isaac Martin. Lois, descent from Colonel Tobias, but not his. Uncle John Fernald of Middleton, Brookfield, Wolfboro. that married Mary Savage, daughter John and Mary, son JAMES and MARY, daughter of WILLIAM STACEY. He was a Farmer, Deacon of 2d Parish, 1781, and moved to Wolfboro. N. H., about 1793. Purchased Corbit, 580 Acres and 19 Rods Farm. Died 1823. Had: Mary (Molly) baptized 4 April, 1773; married John W. Fernald, of Wolfboro. 4 June, 1795. 8 children. Fanny, baptized 7 May, 1774; James, baptized 1775? died young; Betsey Ann, baptized 6 July, 1777; married Rev. Ebenezer Allen, of Wolfboro. New Hampshire, Lois, baptized 20 June, 1779; married Isaac Martin, of Wolfboro. New Hampshire, 26 Nov., 1800; James, baptized Sept., 1781, unmarried; lost at sea: Randall, baptized 30 July, 1785; Diadema, baptized 1 November, 1787; married Joseph Frost, of Wolfboro. New Hampshire, 4 September, 1803; Susan (Sukey) Sparhawk, baptized April, 1792; married Jacob Stanton,



OF BROOKFIELD, N. H., 28 MARCH, 1811. (I OWN) THE SWORD OF COL. TOBIAS FERNALD AND A LETTER STATING IT WAS GIVEN TO HIM AS CAPTAIN TOBIAS AND A COUSIN OF General George Washington, which I find from search and research bears the Fernald Crest Persian coat of arms, the Crown surmounted with the Rattle Snake from which the banner fought under in American Revolution: \$2000 has been refused offer for it, which is invaluable as the sword of the Father of Our Country. There is much more about this historic sword given for gallant conduct, etc.

GENERATION 159-160

LIEUTENANT-COLONEL TOBIAS FERNALD, son of Captain John Fernald and wife Elizabeth Rogers, son John, married Sarah Hinckes, son John, married Mary Spiny, son Thomas, married Temperance Washington, son Dr. Renald, married Joanna Warburton, son Captain William, married Elizabeth Amand, son Dr. John, married Annetta de Coligny, son Francis, married Maria Commenus, son Dr. Jean, married Magadeline Luillier, son of Charles VIII, king of France and Anne of Brittany, was born at 6 o'clock, two hours after his brother John, the 23rd of November, 1742, married Mary the daughter Mr. Jonathan Andrews, Sr., and Elizabeth, (4 chn.) daughter Rev. William Thomas and wife, 30th March, 1740, and united in holy wedlock 27 April, 1758, and Mr. Jonathan Andrews, Jr., married Mary, daughter Peter Fournier and Anne, daughter Edward Thompson, born 1710, died 1758: son Peter, born 1670, died 1738: son Joseph, born 1630, died 1690: son Tobias, born 1604, died 1676; s. Peter, b. 1575, died 1664: brother Lancelot, born 1565, was Chaplin of Queen, by Walsingham, Secretary of Queen Elizabeth, and died 1626: son James, b. 1528, died 1654: gr. son Del Sarto Andrew, born 1417, died 1493: son Andaomicus, born a. 1397, died 1478. The children of Mr. Jonathan Andrews and his wife Elizabeth, daughter Rev. William Thomas—Were: Elizabeth, born 1735, died 1773: John, born 1737: James, born 1738: Mary, born 30 March, 1740: married Lieutenant-Colonel Tobias Fernald, 1758: Peter, born 1742: Francis, born 1744: Jacob, born 1746: William, born 1749: Mercy, born 1752: Thomas, born 1752: Blanche, born 1754. (Were there more than two Lieutenant-Colonel Tobias Fernalds in American Revolution? By clerical error given as children of same Father? (I found cousins.) THE FAMILIES THOMAS LINE:

Rev. William Thomas, born at Bristol, 2 February, 1613 and baptized Friday, 3 February, died 25 June, 1689: by Blanch, daughter Mr. Peter Samyne and wife, he was a Dutch merchant; had William, died young, Peter, John, Blanch, Bridget, William, Sarah, and Elizabeth: John Thomas married Mary, daughter Mr. William Bagnal: Elizabeth m. Mr. Jonathan Andrews, Sr. First said Rev. William Thomas, bishop of Worcester, was of very ancient and noble family, as appears in a pedigree taken out of the Heralds Office by William Thomas, lord Bishop of Worcester in 1688, to prove his right to the Herbert Arms. His Father was John Thomas and wife Elizabeth Blount, son of James Thomas, native of Hagelstein, died 1653, son of Mr. William Thomas, a recorder of Cærmearthen: the Earl of Northampton, then President of Wales, said, "That he was the wisest and most prudent person he ever knew of a corporation." Alfred the Great wisely hung 41 corrupt judges for reform.

THE ANCESTRY OF COLONEL TOBIAS FERNALD'S LOVED WIFE, MARY, DAUGHTER JONATHAN ANDREWS, JR. AND WIFE, MARY (ELIZABETH FELIBIEN FELLEIN) (PETER ANDREW MARRIED MARY FELLIEN); 3RD, Joseph Andrews married Elizabeth Felibien) ANDREWS LINE: 1, JONATHAN ANDREWS, SR., 1790 Census, and Jonathan Andrews, Jr. 3rd John Gerhard Beinhard

Andrae; b. 1724; d. 1793: 4, Ives Mary.(male) Andrew, b. 1675; d. 26 Feb. 1764: 5, John Andrea des Rochers, born 1650; d. 1741: 6, Tobias, Andredo, b. a. 1626; d. 1766: 7, Thomas Andrada, b. a. 1606; d. 1682: 8, Valerius Andrew, b. 1588; d.—; living 1652: 9, Anthony d' Andrada, b. a. 1560; d. 1634, at Portugal: 19, James Andreas, b. 1528; d. 7 Jan. 1590: 11, Sarto del Andreas, b. a. 1483; d. 1530: 12, Publ. Faustus Andrelinus, b. a. 1458; d. 1518: 13, John Andrew, Secretary at Vatican, b. a. 1438; d. 1493: 14, Andrew of Ratisbon, b. a. 1413; d. a. 1462: 15, Peter Ancharano, b. a. 1350; d. 1417: 16, John Andreas, b. a. 1278; d. 1348. His beautiful daughter Novella m. (17) John Calderinus. The motto of Andrew Felibien, b. at Chartres, 1619 and d. 11 Jun. 1695, was "Bene Facere, Et Vere Dicere."—"To do Good and Speak the Truth." From a written record I give:—Lord Francis de la Force, the father of Duke James de la Force, born 1563; died 1652, with his brother, Armand de la Force, on Sunday, 24 August, at night, 1572, these three were in bed together, the feast of St. Bartholomew Massacre, at the ringing of the bells of St. Germain for martins, the slaughter began by the murder of Admiral Gasparde de Coligny by a domestic of the Duke de Guise, Besme, who entered his room with a horde of assassins, sword in hand, and found him sitting in an elbow chair. "Young man," said he to their leader in a calm and tranquil manner, "thou shouldst have respected my grey hairs: but do what thou wilt: thou canst only shorten my life by a few days." Besme stabbed him repeatedly and threw him out of the window at the feet of the Duke of Guise, who proceeded to mutilate him. Besme trampled on the corpse, body exposed three days to fury of fanatics and then hung by the feet on gallows of Montfaucon. His cousin Montmorenci had it taken down to bury secretly in chateau de Chantilli. An Italian cut off head and carried it to Catherine de Medicis who caused it to be embalmed and sent to Pope Gregory XIII, the 234 Pope, who sent Charles IX a magnificent sword with the exterminating angel thereon. Gregory received head with transports of ferocious joy, called in the most skillful painters, and to perpetuate the memory of the murders, ordered several pictures representing the episodes of the St. Bartholomew. Among other things there was represented in the Hall, called the Hall of the Kings, in the Vatican, three frescoes: 1st, Assault on Admiral Coligny on leaving Louvre. 2nd, Scene of carnage by torch light. 3rd, Charles IX (It was reported after murder of good King Humbert the intent to substitute a Vatican tool for the present good lawful King) seated over Parliament, and glorifying himself for exterminating 100,000 loyal good French subjects. I have before me the colored picture of the presentation of my forefather Coligny's head to Gregory, and I saw a plate of Duke of Guise cutting off other members of the body of the noble Gasparde de Coligny, one of alleged 250,000,000 martyrs that from search and research I have reduced to 150,000,000, and saw a plate of the medal struck to glorify the fanatics of St. Bartholomew. Often heard boasted that martyrs are the seed of the churches by ministers and authors. If this is the height of any religion, then the quicker that and all like religions die the better for all mankind whose common forefathers were the children of God who commanded "THOU SHALT NOT KILL." LOVE ONE ANOTHER AS GOD LOVES YOU."': as declareth the primitive commandments of primitive times recorded by ancient Egyptians, the most religious class of men and women on earth since Adam and Eve, or Ava and Seth. Lord Francis de la Force and son Armand de la Force were slain, and the brother Duke James de la Force was overlooked and escaped from the assassins that will be punished by God and their superiors in a greater degree in exact proportion to the deeds done in and by their bodies, aiders and abettors. For God is Omnipresent, Omniscient and Omnipotent, the Glorious Father of All Creation. By marriage aforesaid Duke James de la Force is related to Fernald family of Colonel Tobias and Mary, his wife.



HAVING MADE CLEAR TO THE WISE MANY THINGS HIDDEN WE MAY NOW GIVE CHN. TOBIAS FURNALD AND HIS BELOVED WIFE, MARY ANDREWS: HE b. 1742, WIFE b. 1740, m. 27 APR., 1758. MERCY, b. 15 FEB., 1759; m. Mr. Joseph Billings 3 Jan., 1782; d. at Lebanon, Maine, U. S. A. Nathaniel, b. 9 July, 1760, m. Hannah, da. Nathaniel and Mary Fernald, b. 26 Jan., 1761, m. 4 Aug., 1788, Rev. Joseph Lichfield, Officiated. Elizabeth, b. 25 July, 1765, m. Mr. William Berry, d. 12 Mar., 1842; Tobias, b. 31 Dec., 1768; m. Abigail Chambers, (5 chn., Sophia Ann, Lydia, John, Peletiah, M. C., William H.) Lydia, bapt. 28 July, 1772; m. Capt. John Williams, pub. 17 Oct., 1801 and d. 30 Apr. 1859; Sarah, b. m. William Wells of Boston, Jan. 9th, 1805. But was given as m. Wm. Boston of Wells, both names are in Census 1790 and for her birth probably the Wells and Bostons can give dates that may reveal two of like names of two families, data.

"Die Evangelische Bokschrift

In a book "Der Herrlichkeit Bokkes in Jesu Christo," etc. Pub. Leipsic 1735, is to be found the following:—"Georg Philippi Brchin, sailed from Germany the 12 day of April 1752 Arrived in Halifax: New Scotland the 1st day of August 1755. The 12 day of February, 1753 I married my wife Elizabeth Fellein. On the 8 day of June 1753 we stormed the 11 ? Castle. The 3 day of July 1753 we commenced to build our House. The 30 day of October gave us the Lord a Son which we named John Giorg. The 2 day of November we took him to the holy baptism." Top of title page written by script "Christian Felibien" and other many written words, part not distinct. With Brechin or Breckein appears written over the word Filibien.

Jacobus Augustus Thuanus (De Thou) or Fuanus, b. 9 Oct., 1553 at Paris, (his bro. d. 1579,) wife 1601: m. 2d and had three sons and d. 17 May, 1617. His father was First President of Parliament and Faunus a celebrated historian. He was Master of Requests, 1584. Attached himself to king Henry II

He was bur. in chapel St. Andrew of the Archer. The eldest of his three sons was Francis Augustus Faunus, b. from 2d wife and Librarian to the King but as he did not reveal a conspiracy by Marquise d'Effiat against Richelieu; and the Cardinal, resenting the levity and contemptuous manner in which he had been mentioned in the pages of the historian, most inhumanly sacrificed the son to his mean revenge, and caused him to be beheaded at Lyons, 1642. His honorable ancestry were connected with the long line of proved genealogy by marriages.

GENERATION 158-9. JOSEPH FERNALD, b. 1704, s. of Deacon John Fernald and wife Sarah Hincks, m. Anna More, da. , b. m. 1736-7, d. He d. Had descendants: Joseph, b. 25 May, 1738; m. Lydia, b. 1 Jan. 1740; m. Robert, s. Thomas and Dorcas (Hammond) Cutt, 18 Nov., 1758; Benjamin, b. 1 July, 1742, m. Hannah Spinney, Dec., 1764.

GENERATION 158-9. WILLIAM FERNALD, s. Thomas and Mary, b. 1701, m. Hannah Seavey 24 June 1724. She was da. Benjamin and (Wallis) Seavey of N. H. Had: Hannah, b. d. m. Capt. Gowell ; William, b. 22 Feb., 1732; m. Abigail Tobey, 2d Mary Staples: Dimon, b. 1734: killed by the Indians near Halifax, N. S., 1753 a.

GENERATION 158-9. THOMAS FERNALD, b. 1717, s. Thomas and wife Mary, da. John and Sarah (Remick) Thompson, m. Sarah, da. Hercules and Sarah (Hicks) Fernald, pub. Dec. 1, 1744: Had: Mary, b. 1746; m. Mr. George Rogers of Berwick, 30 Aug., 1770: (2 chn.) Archelaus, b. 1748; m. Hannah Trefethen: b. 1798; d. 1805. He resided in Newcastle, N. H. (7 chn.,) Dimon, b. 2 April, 1750: m. Margaret, da. Abraham and Mary (Trickey) Fernald: d. 28 Dec., 1806, Loudon, N. H. (15 chn.,) Renald, b. 13 Apr., 1752, m. Elizabeth Viner or Vennard, 2 Sept., 1781; 2d Mrs. Pricilla Davis, 29 July, 1792; 3d Mary, da. Andrew Sherbourne, 6 Sept., 1801.



A FOURTH WIFE MRS. JANE LARKIN? 4 NOV. 1810. HE WAS CALLED DR. LIVED AND DIED IN PORTSMOUTH, N. H. 10 APRIL, 1844. HAD FIVE CHILDREN, ONE OF WHOM WAS THE EXCELLENT GENEALOGIST, MR. AMMI R. HALL FERNALD. Mr. Thomas Fernald wife died and he m. Grace, da. Joshua and Dorcas (Hill) Remick 4 Nov., 1755: Had Robert, b. 1756-7 "that was impressed into the English Navy?" This is in Archives, State House, Boston, Mass. Muster Pay Roll. Services in New York. He Enlisted 13 Dec., 1776, in Capt. Wm. Holbrook Co., Col. John Frost. As a Privateers man. It was said he was captured and imprisoned in England during last part of the Revolution, Discharged at its close, married and settled in England where was recorded as Robert Fernell, which does not seem to show that all the prisoners captured in the American Revolution were harshly used. Hannah, b. 1761: m. Elisha Gurney of Newport, Mass., 17 Mar., 1780: d. 1833 (8 chn.) Nancy, b. 6 Feb., 1764, m. John Roges, 26 Dec., 1790: d. 19 Jan., 1852: (2 chn.) Sarah, b. 1766, m. Samuel Pray of Berwick, d. 1848 at Topham or Topsham, Me. (3 chn.)

GENERATION 158-9. ABRAHAM FERNALD, b. 1719, s. Thomas and wife Mary Thompson, m. MARY TRICKEY at Newington, N. H., 1742, May 16, probably a sister of Jonathan, son of Jonathan Trickey; Had: Abraham and Isaac, bapt. 5 May, 1744, m. Judith Hill and d. Sept., 1815, Barrington, N. H. (13 chn.) Clement, bapt. 11 May, 1746: m. Dorcas Tucker 29 Sept. 1768 at Dover, N. H. Resided in Goldsboro, Me. In American Revolution. (8 chn.) Thomas, bapt. 1 May, 1747, m. Anna Kennison: Resided at Nottingham, N. H. (14 chn.) Jedediah or Jeremiah, b. a. 1749: Charles, b. 12 Mar., 1752: m. Abigail Tricky and d. Apr. 8, 1828: Residence, Northwood, N. H. (6 chn.): John, b. a. 1755: Mary, bapt. 21 Aug. 1757: m. John Sporfield of London Town: Margaret, b. 28 June, 1758, m. Dimon Fernald: d. 21 Jan. 1833 at London, N. H.: daughter (Sarah) m. Mr. Huckins: Keziah, b. Feb. 1767: m. Mr. Samuel Buzzell 1790: d. 30 Nov. 1814 at Wayne, Me.

B GENERATION 157-8. NATHANIEL FERNALD, b. 1707, s. of Nathaniel and Ann Fernald, m. MARY, da. Nicholas and PRICILLA (GUNNISON) WEEKS, 10 Oct., 1734: Had: Mary, b. 5 May 1735: Tobias, born 7 Nov. 1736, m. Mary Hammet 27 Nov., 1760; he d. at Poughkeepsie, N. Y., and his widow m. Thomas Jackson, 27 Feb., 1780; (3 chn.) Timothy, b. 18 Sept., 1738, m. d. 11 Apr., 1775: Nathaniel, b. 6 Apr., 1740: m. Mary Gunnison 5 May, 1763: Mary, b. 22 Aug., 1741: Pelatiah, b. 3 Aug., 1743: m. Mrs. Abigail (Strout) Eldridge 4 June, 1768; d. 22 Feb. 1816: resided in Falmouth, Me., and had: Nathaniel, Anthony, Joshua, Joseph, and Mary: Elizabeth, b. 20 Dec., 1744: m. Joshua Mendum Jan., 1764: Nicholas, b. 22 May, 1747; m. Esther Thompson of York 1 Nov. 1772; 2d Mary (Molly) Furbish 12 Oct., 1779. Resided in York, Me. In Am. Rev. and had Mary, John, Timothy, Samuel and Catherine: Joseph, b. 11 June, 1749: b. 3 Nov., 1752: Anna, b. 12 Nov., 1759; m. Samuel Remick, 26 Dec., 1780: Hannah, b. 26 Jan., 1761; m. 4 Aug. 1788 Nathaniel Fernald, Rev. Joseph Litchfield officiated.

GENERATION 154-8. TOBIAS FERNALD, s. Nathaniel and Anna, b. 25 Aug., 1703, m. ABIGAIL SMITH, pub. 22 Feb., 1728-9. She was da. of John Smith, s. Capt. John Smith who was at Portsmo., moved to Wolfboro. and Holdness, N. H., had 5 or 6 chn. Smith's Pond was named for him. Now called Lake Wentworth. Had: George, b. 8 Feb., 1730; m. Eunice Knight: Abigail, b. 1 Jan., 1731: John, b. 23 Feb., 1732: Mary, b. 27 Jan., 1733: Thomas, b. 9 Jan., 1734: Nathaniel, b. 7 Jan., 1735: Renald, b. 19 Jan., 1736: Samuel, b. 11 March, 1737. Mr. Tobias Fernald, d. 1 Oct., 1737.

GENERATION 156-7. GEORGE FERNALD, son William and Elizabeth (Cotton) born 1723, married ELIZABETH LANG, 5 Dec., 1754: married ANNA LEACH, 1 Jan., 1767 and d. 1774: Had Daniel, b. 19 Nov., 1767: m. Beulah Nichols, 2 Sept., 1780: 2d Mrs. Jane (Marden or Martin) Otis, 3 July, 1822: d. 7 Mar., 1866: Sea Capt., 12 chn., George, b. 7 June, 1770: Simeon, b. 20 June, 1772: Betsey, b. m. Moses Griffin, Derry, Anna, b. m. George Griffin Sandown. All resided in N. H. and chn. b. in Kittery, hence grave doubts of its correctness.



F

JOSEPH FERNALD, S. BENJAMIN AND CATHERINE, B. 1719, M. ANNA MOORE, OF YORK, PUB. 1 JAN. 1742 OR 3. A SHIPWRIGHT AND MEMBER OF "BLUE TRUPE OF HORS" AT BERWICK, 1757. WILL 5 Apr. 1792, prob. 13 July, 1792: Had: Benjamin, b. 12 Apr. 1744, m. perhaps Sarah Beaver and Lucy Lewis, a descendant gave records (stolen) to writer of Sarah Beaver m.

GENERATION 156-7. to Benjamin, son of Deacon John and his wife Sarah Hinckes, b. 1717, that m. Susie Chadbourne after too late to print. Mary, born 16 May, 1746; m. Benj. Gunnison, 9 Aug. 1770; d. 22 May, 1802; Mark, b. 7 June, 1749; m. Martha Rackley; 2nd, Eunice Leach: Edward, baptized in Feb. 1755. In Am. Rev. An Edward of the Brig Venus was captured by British, 1 Jun. 1781, and committed to Old Mill Prison November, 1781. Edmund Fernald Enlisted in Capt. Tobias' Co. and Col. Edward Phinney's Reg. in Garrison Fort George, Dec. 8, 1776. Enlisted May 18, 1776. Discharged Nov. 8, 1776. Served 5 Mos, 20 days. Probably another Fernald. No later record of Edward. Eleanor, b. 5 June 1759; m. Benjamin Gunnison, 8 June, 1803; d. 18 June, 1820. He was Lieut. in United States Revenue Service. Joseph, baptized 10 June, 1764.

GENERATIONS 156-7. BENJAMIN FERNALD, b. 1721, s. Benjamin that m. Catherine Hammond, m. SARAH, da. Ebenezer and Patience (Mendum) FERNALD, 6 March, 1746; Shipwright; d. 4 Mar. 1798; will probated Mar.: Had: Lucy, b. 25 Mar. 1747; m. Mr. Holbrook: Josiah, b. 13 July, 1749; Joshua, b. 11 Nov. 1751; Joseph, b. 10 Jan. 1753; Alice, b. 13 Dec. 1754; Robert, b. 16 Aug. 1757; Noah, b. 23 Sept. 1759: 5 of these are not mentioned in father's will. Miriam, b. 12 July, 1762; m. George Phipps, 20 Dec. 1781; Elizabeth, b. 25 Sept. 1764; m. Mr. Crosby? or Crosbie: Catherine, b. 2 July, 1769; m.: William Fernald, b. 6 May, 1796; m. Lucy Fernald, 14 Apr. 1793; Benjamin, b. 7 Apr. ; m. Eunice Place, 2 Dec. 1795.

GENERATIONS 159-160. OPPOSITE SOUTH WEST CORNER OF OLD STATE HOUSE AT BOSTON, MASSACHUSETTS, COPY FROM BIBLE, Printed at 2 Cornhill Square, 1818, "COPIED FROM TOBIAS FERNALD'S, son of Capt. John Fernald, BIBLE written Records by his Wvfe Elizabeth, da. Mr. John and Martha Rogers of Ipswich, written by Molly (Mary) Hammond ye wvfe of Mr. William Fernal, 1820, at ye Towne of Cornish, N. H. Col. TOBIAS FERNALD, twin brother Captayne John and Elyzabeth Fernald's son Mr. John Fernald was born at six o'clock, two hours after John ye 23 Nov. 1742; m. Mary Andrews, da. Jonathan Jr. and wife Mary, da. Peter Fournier and Anne, da. Mr. Edw. Thompson, b. 30 Mar. 1740; m. 27 Apr. 1756; Chn.: bap. 24 July, 1757; m. Mary Hammond (Molly) b. 1759; d. 13 Sept. 1822; he d. 1 Sept. 1816; their chn.: John, William, Daniel, Wm. 2nd, Samuel, Joseph, Thomas, Benjamin, Mary, James, Sarah, (Sally) (Betsey) Elizabeth, (See ante): Mercy, b. 15 Feb. 1759; m. Mr. Joseph Billings, 3 Jan. 1782; d. Me.: Nathaniel, b. 9 July, 1760; m. Hannah Fernald, 4 Aug. 1788: Miriam, b. 1 June, 1761; m. William Leighton, 23 Nov. 1777 (12 chn.): Lydia b. 11 Mar. 1762; m. John Williams, 3 Dec. 1801. Rev. William Briggs officiated. Nancy, b. 6 Feb. 1763 or 4; m. Mr. John Rogers, 26 Dec. 1790: Lydia Sally, b. 4 Jun. 1764; m. William Mugridge of Newbury, 3 Sept. 1792; [5 chn.] d. 26 Apr. 1848: Elizabeth, b. 25 July, 1765 or 6; m. Mr. William Berry, 12 May, 1842; d. 18 Jan. 1852: Mary Washington White, b. 25 Apr. 1766 or 7; m. Joseph Hammond 7 Nov. 1784; d. 1857; had Wm. and chn.: Tobias, b. 31 Apr. 1767 or 8; m. Abigail Chambers (and had Sophia Ann, b. 20 Feb. 1807; Lydia, b. 8 Aug. 1808; John, 7 July, 1810; Pelitiah. (M. C.) b. 16 Mar. 1812; Wm. Hinckes, b. 29 July, 1815); both of Portsmo.: SARAH, b. 13 Mar. 1768 or 9; m. Samuel Pray, of Berwick; d. 1848: Archelaus, b. 16 Mar. 1769 or 70; m. Eunice Trefethen, 24 Jan. 1804; d. 1851: Mark, b. 3 Feb. 1770; m. Mary, da. Bartholomew Berry, of Portsmouth, 30 Oct. 1796 or 7; was born Mark, 8 Jun. 1798: m. Ruth, b. July 16, 1805;" He d. 8 Jun. 1880, and Ruth Fernald d. 8 Oct. 1889, aet. 82 and 84 yrs. as pr. tomb Stone at Cornish, N. H. Peletiah, b. 2 Aug. bap. 5, 1771; m. Sarah, b. 11 Dec. 1774, da John and Mary Fernald; m. 10 Dec. 1797, and had Joanna, b. 11 Dec. 1798: John b. 2 Apr. 1802: Peletiah, b. 19 Aug. 1804: Samuel and Mark, b. 19 Sept. 1806." This Bible Record from preponderance of evidence author accepts,



WHOOSE AS WE MAY GOOD OR EVIL, RIGHT OR WRONG, HAPPINESS OR MISERY. TRUTH CAN NEVER DIE. MY CHOICE IS THAT BIBLE IN ITS ANCIENT ÆGYPTIAN THAT THE CO-EXISTANT HEBREWS DID faithfully copy and will stand forever, notwithstanding the craft have erroneously translated it to suit their desires and forget to

"Remember the days of old,
Consider the years of many generations:
Ask thy father, and he will show thee:
Thy elders, and they will teach thee."

—Deut. xxxii. 7.

"Tell ye your children of it,
And let your children tell their children.
And their children another generation."

—Joel 1. 3.

I have given all these three records of my ancestor's son, Col. Tobias Fernald to teach children to carefully scan and reflect on all writings, appreciate the arduous duty of the faithful genealogist, especially when there has been a threat, I heard it to injure the family as much as possible for attempting to bring criminals of high degrees (the boasted foes of, godly nations that I will aid, for the good of all) to justice. The Bible unchanged is right. Our long line of Genealogy is CORRECT to the best of my knowledge and belief. Without any aspersions on the officials of Towns and Cities, but direct charges vs. those well known who boasted of winning an unjust against a just cause, threatened to involve America and England in war, succeeded in Russia, Spain, and tried it in wise polite France, Italy, and were defeated. Yet still threatened, hoping to involve Japan to their injury, from subtle cabals and conspiracy by their tools reaching forth over earth to be understood by wise Germany, the brave and honest learned nation who protected my foremother Annietta de Coligny wife of slain Dr. John Fernel, made Martyrs of our Presidents, good king Humbert of Italy, Wife, P. D. Fernel saved life of Dr. Jean Fernel that has 63,000 descendants in U. S. alone and ten times as large or more in number at Europe all from Ava and Adam, whose descendants people China the peaceable. Turkey the warriors that practice all they preach; Portugal the friendly, and Austria, who by some wise laws teach wisdom we do well to copy: dispensing full impartial justice to men, thus preventing continued slaughter of those God has placed in authority. GOD the Creator who made AVA and ADAM after his image and pronounced his work "very good" made the most perfect specimens of mankind for

Not out of weakness rose their gradual frame,
Perfect from their Creator's hands they came.

As in forms excelling, so in mind

The parents of men transcended all mankind.

GENERATION 156-7. TOBIAS FERNALD m. LUCY (Lewis?) Atkinson, da. Samuel Sr., and sister Samuel Jr., who had 3 sons and 3 das. (1790, at Boscewen Town, N. H.), 19 May, 1748. He was son of Nathaniel and b. 1723 and d. 4 Mar., 1777; had: Lucy, b. 9 Apr., 1749; m. Joel Haley 29 May, 1768; d. 16 Aug., 1821; Joshua, b. 9 Mar. 1753; m. Lucy Wingate, 2d Mrs. Hannah Snow; d. 11 Jan. 1830. Resided in Eaton, N. H., and Limerick, Me. Ensign in American Revolution: Chn. Peninah, Elizabeth, Lydia, Edmund, Diadema and Simcon: Joel, bapt. 13 Apr., 1755; d. y. Eunice, b. 10? Mar., 1756, m. James Hutchings 2 June, 1774, 2d Joseph Wilson 15 Dec., 1784; d. 25 Mar., 1830; Edmund, b. 5 Sept., 1757, m. Polly 29 May, 1787. At American Revolution:

GENERATION 154-5-6-7-8. JOEL (FRUNALD, Census, 1790) FURNALD, s. Hercules, m. Sarah Hicks, 2, m. Susanna; s. Samuel, s. THOMAS and wife TEMPERANCE WASHINGTON, s. Dr. Renald and Wife Joanna Warburton, b. 13 Feb., 1745, m. ELIZABETH PETERS, da. 1st Amos Peters of Warren Town deceased before 1790 and had 5 or 6 das. He was Blacksmith in Am. Rev. and m. on or about 1767: had:

Simon, b. 13 Aug., 1768: m. Elizabeth Lowe of York, pub. 8 Nov., 1794. He resided in York. Hannah, b. 16 Jan., 1770; Sally, b. 20 Oct., 1771: d. 3 Aug., 1793; Lydia, b. 14 Jun. 1774; Ruth, b. 23 Feb. 1776: m. Daniel Farely of Charlestown, Mass., 21 Nov., 1805; Susanna, b. 9 Feb., 1777: m. William Litchfield 27 Sept., 1799, d. a. 1856 at Lowell, Mass.; 9 chn., Joel, b. 27 June, 1782, m. Eleanor Blaisdell, 17 June, 1805. Residence Frankfort, Me.: 5 chn. Stephen Fernald was born on the eighteenth of





CTOBER, 1784; MARRIED ALICE CARTER, 27 NOVEMBER, 1806; JOSIAH, BORN 20 OCTOBER, 1786; MARRIED PENELOPE OAKMAN, 18 JUNE, 1809; DIED 13 SEPTEMBER, 1865; RESIDED IN FRANKFORT, NOW CALLED Winterport, Maine; 12 children: Dorcas, b. 18 Aug. 1788; m. Francis Brewer, 15 Jun. 1817; 2nd, Elihu Dole, about 1822.

GENERATIONS 156-7. WILLIAM FERNALD, s. Nathaniel and Margaret, b. 1739; m. ABIGAIL, da. Thomas and Mary (Bartlett) DENNETT, 28 Jun. 1763; Farmer; d. 29 Sept. 1823, and wife, b. 28 Apr. 1741; d. 5 Apr. 1818; Had—Thomas Dennett Fernald, b. 29 Feb. 1764; m. Pamela Jones, 13 Sept. 1787; 2nd, Hannah Goodrich, 16 Oct. 1794; d. 8 Jun. 1834; resided in Berwick, Me.; Had—Dorothy, Thomas, John, Hannah, Sally, Nathaniel, Daniel, Permelia, Abigail, William: Mary, b. Aug. 1766; m. Richard Wilson, 16 July, 1791; Abigail, b. 24 May, 1769; d. 16 Dec. 1800; Margaret, b. 14 Nov. 1771; m. Tappan Hurd of Berwick, and d. 27 July, 1844; Sarah, b. 12 Feb. 1774; Eleana, b. 16 Oct. 1776; d. y. and Eleana, b. 13 Nov. 1779; m. Robert Fernald of Shapleigh, Me., 2 Jun. 1822; William, b. 3 Feb. 1784; m. Mary Souther, of Haverhill; pub. 19 Aug. 1804, at Charlestown, Mass.; 2nd, Sarah Carlton, 29 July, 1806, and resided in Charlestown, Mass.; Had—William B., Mary A., Guy C., Sarah C., and Abigail D.: Elizabeth, b. Jan. 1786; m. Rev. George Hurd of North Berwick, 30 Nov. 1820. Census, 1790, no Fernalds in Massachusetts Recorded; and only two states, Maine and New Hampshire.

GENERATIONS 157-8. EBENEZER FERNALD, s. Ebenezer and Patience, his wife, b. 27 Mar. 1729; m. SARAH LEWIS, 4 Oct. 1753, b. 3 Jun. 1730; He d. 9 Jun. 1807; Had—John, h. and d. 1754; Ebenezer, b. 19 Aug. 1757; d. 4 July, 1781; David, b. 2 Jan. 1760; m. Esther Tucker Leach: Eunice, b. 2 Apr. 1764; m. Thomas Brown, 3 Sept. 1788; Miriam, b. 2 Jan. 1767; m. Simeon Fernald, 6 July, 1794; d. 8 Apr. 1846; William, b. 15 May, 1771; d. 20 Oct. 1794; Sarah, b. 22 July, 1774; m. John Brown, 21 June, 1795; Peter, b. 8 Nov. 1777; d. 26 Sept. 1786.

GENERATIONS 157-8. SIMEON FERNALD, b. 28 Sept. 1738; brother of above; m. MARGERY GUNNISON, da. Elihu and wife, (Emerson) b. 4 Nov. 1763. He d. 6 Feb. 1780; Had—Amos, bapt. 2 Dec. 1764; m. Lydia Treadwell, 25 Dec. 1791; d. 9 May, 1830. Resided at Portsmouth. Had—Amos, Lydia, Isabella: Mary, m. William Blunt, Sept. 1786; d. 4 Sept. 1859, at Portland, Me.: Dorothy, bapt. 17 Sept. 1769; m. ? Nathaniel Melcher, Nov. 1792; Miriam, b. 28 July, 1772; m. Henry Elkins Cotton, 27 Oct. 1798; d. 15 Dec. 1828; Elizabeth, b. —; m. Woodbury Tucker, 4 Nov. 1797; Margery, b. 8 Apr. 1779; d. 11 Mar. 1847.

GENERATIONS 157-8. DENNIS FERNALD, s. Capt. Tobias and Mary, b. 1725; m. 9 Oct. 1750, SARAH, da. CHARLES and SARAH FROST; Farmer; d. 2 Aug. 1805, and wife d. 20 Aug. 1804, at. 74; Had—Dennis, b. 24 Jun. 1752; d. 5 Apr. 1755; ANDREW PEPPERELL, b. 26 Feb. 1758; m. Martha Shapleigh: Charles, b. 1 Feb. 1755; d. 4 Feb. 1778; Dennis, b. 29 Sept. 1757; m. Elizabeth Stacy, 24 Aug. 1780; Miriam, b. 12 Dec. 1760; Sarah, b. 24 Dec. 1763; m. James Johnson, 10 Oct. 1784; Molly, b. 26 Jan. 1766; m. Ralph Tristram Jordan, Esq., Pepperelboro Town, 1790, with 6 chn., m. Oct 1, 1789, Tristram, Jr. s preceding and had—Tristram, Abigail; she d. 18 Sept. 1863; Robert, b. 6 Mar. 1768; m. Betsey Ferguson, 13 Nov. 1791; Robert, Frederick, Bell, James, Sally, Benjamin Johnson and Betsey: Margery, b. 24 Jun. 1770; U. S. Census, 1790, gives Capt. Dennis Fernald, Sr., 1 son, 1 da. and slave; Dennis Fernald, Jr., 2 sons and 2 das., the sons under 16 years of age.

GENERATIONS 157-8. LIEUT. COL. TOBIAS FERNALD, s. Capt. Tobias Fernald, b. 1 Feb. 1743; m. DORCAS, da. Capt. John and Harriet McIntire, and d. 15 Aug. 1784; Had—Harriet, b. 22 Nov. 1781; d. 1829; Juliet, b. 12 May, 1783; m. Col. Daniel Lane, 21 Jan. 1808; d. 27 Feb. 1829; 4 children.

GENERATIONS 157-8. ELEAZAR, bro. of above, b. 1746; m. 31 Jan. 1771, MARGERY, oldest da. of Nathaniel STAPLES, of Cape Elizabeth, and his wife, Margery; Farmer; d. 1823, at Ossipee, N. H. His wife, b. 18 Nov. 1747; d. 1826. Had—Tobias, b. 8 Nov. 1771; m. Sally Pray, Lebanon, N. H., 2 Aug. 1792; d. 3 July, 1849; Had—Joanna, Dorothy, Joseph, Mark, Charles, Nathaniel, John Yeaton, Abigail and Samuel Pray Fernald. He resided at North Berwick, Me. and Ossipee, N. H.: Nathaniel, b. 20 Oct. 1773; m. Polly —; m. Mary, b. 20 Feb. 1775; d. 28 Jan. 1776; Elliott, b. 2 Mar. 1778; m. Sally Mudgett, 31 Jan. 1811; d. 16 Jun. 1858; Had—Judith, Dorothy, Sarah and Elliott: He resided and Nathaniel at Parsonfield, Me.; Margery, b. 6 Jun. 1780; m. Levi Pray, of Lebanon; d. in Paris, Me.: Joanna, b. 25 Sept. 1782; m. Pelatiah Pray, 2 Dec. 1800.

L

JOSIAH OR JOSHUA FERNALD, S. JOHN AND MARGARET, S. ARCHELAUS AND SARAH (DA. REV. GEORGE HICKS,) S. THOMAS AND WIFE, TEMPERANCE WASHINGTON, M. ELIZABETH WHITE, DA. Dea. Joshua White. b. 16 Apr. 1740; m. 18 Nov. 1764, and d. 2 Nov. 1816: He d. 6 Dec. 1816, as from Records of Elder Mark Fernald: Had: Mary White, b. 25 Apr.

GENERATIONS 157-8. 1766: John, b. 7 Feb. 1769; m. M. B. G. Mitchel; d. Nov. 12, 1793: Peletiah, b. 5 Aug. 1771; m. Sarah Fernald, 1798; d. 12 Oct. 1849: m. is again given as 10 Dec. 1797: Elizabeth, b. 19 Jan. 1777; d. 1854, s. p.: Joshua, b. 16 May, 1781; d. 27 Sept. 1849, s. p.: Mark, b. 9 Mar. 1784; m. Miss Jane Stevens, 16 Oct. 1825; 2nd. Mrs. Emily St. A. Shepard, widow of Elder Mark Shepard, and da. of Mr. Samuel Badger, of Deerfield, N. H. Elder Mark Fernald was Ordained To the Sacred Ministry, Sept. 20, 1809. The three last children were born in the Manor House of Sir William Pepperrill and Rev. Mark Fernald was chosen Pastor of Kittery Church in 1815 and continued to 1850. By first wife he had four sons d.y., and a da. Elizabeth Jane, b. 21 Mar. 1830.. His first wife d. 19 Nov. 1848. He d. 30 Dec. 1851, beloved by all his good friends and relatives. He also was a Fernald Family Genealogist and he gave the name of Mrs. "Elizabeth Eastwick." Copied from Tomb Stone in Portsmouth Navy Yard. "Here lies the body of Elizabeth Eastwick wife to Stephen Eastwick Age 31, 2 Mos. & 20 Days." That I visited and read on it.

GENERATIONS 157-8. JOHN FERNALD, the Mariner, b. 20 Feb. 1750, s. of John and Margaret Fernald, eldest da. of Nathaniel and Lucy Atkinson, da. Samuel, m. Mary, da. Tobias and Lucy Fernald, 25 Nov. 1772: Had: Sarah, b. 15 May, 1774; m. Peletiah Fernald, 10 Dec. 1797; d. 20 Jun. 1855: Abigail, b. 1778; d. 14 Aug. 1852: Mary, b. 1779; d. 21 Aug. 1863: Samuel, b. : Margaret, b. 1783; d. 6 Sept. 1854: Edmund, b. : Mark, b. : m. : d. 1841: John, b. : m. Rhoda Maria Bunker, of York, pub. 5 Apr. 1825: Had: Mark Harris, Nancy Maria, Mary; his relict m. Henry Abbott, 8 Nov. 1835.

GENERATION 159. JOHN FERNALD, b. 1737, s. James and Hannah, da. John and Hannah (Fogg) Rogers) s. of Deacon John Fernald and wife Sarah Hinckes, s. John and wife Mary Spinney, s. Thomas and wife Temperance Washington, s. Dr. Renald Fernald and wife Joanna Warburton; married 17 Apr. 1759, Sarah, da. Capt. William and Margery (Pepperell) Wentworth. He was a soldier in the French and Indian Wars as was his forefather Thomas on whose knife with Turkish Hieroglyphics on blade and bone handle is cut the genealogical line down to John Fernald who m. Mary Savage. He d. 16 May 1835 and wife b. 24 Oct. 1740, d. 24 May 1784, after the death of Sarah he may have been the John Fernald who m. a da. of Capt. John Fernald and wife Elizabeth Rogers of Ipswich, or even the John W. Fernald, which last is not probable, but that two das. m. two cousins, he is probably the "Old John Fernald" referred to in some Cotton records. Mr. John Fernald d. 14 Oct. 1836, æt. 87, in Wolfborough, N. H. Christian Register Oct. 29, 1836. Henry W. Fernald, b. P.O. Their descendants were: William Wentworth, b. 13 Oct. 1760; m. Waite Salisbury: Samuel, b. 12 May 1762; m. Betsey Fernald, 11 Apr. 1825: Sally, b. 4 Jun. 1764. was probably the da. of Lt. Col. Tobias Fernald, s. Capt. John and Elizabeth (See Bible Records and U. S. Census of 1790.): Betsey, b. 13 Dec. 1765; d. 18 Sept. 1820: Mary, b. 30 Mar. 1767; m. Theodore A. Cutts, 25 Nov. 1804; d. 14 Apr. 1853; had chn.: James, b. 1. Aug. 1770; m. Mehitable York of Shapleigh, 29 Dec. 1799; d. 9 Feb. 1819. Resided at West Newfield, Me. Had: Sarah W. ("Washington") Martha, Mary, Keziah, Mehitable and Betsey. She was sd. to m. 2nd Joseph Burbank, 15 July, 1821: John, b. 14 Jun. 1776; m. Olive Moore, 17 Jun. 1799; d. 20 May 1837. Resided in Norwich, Conn. Had: Benjamin M., John and Olive: Hannah, b. 11 Aug. 1777; m. Benjamin Fernald, 12 Feb. 1800; d. 11 Nov. 1815.

GENERATIONS 159-160. JAMES FERNALD, pub. m. 2 Oct. 1762, ABIGAIL, da. William and Margery (Pepperell) Wentworth, b. 1744; d. 1763 and was s. of James and Hannah (Rogers), s. Dea. John and Sarah (Hinckes), s. John and Mary (Spinney or Spinney as now spelt) s. Thomas and Temperance (Washington): Had: Hannah, b. 1763; m. Nathaniel Fernald, 1788; d. 1834.



F

GENERATION 157-8.

CAPTAIN MARK FERNALD, B. 6 MAY, 1751; S. JAMES AND MARY (MENDUM) M. MARY, DA. CAPT. JOHN SHAPLEIGH AND DORCAS (LITTLEFIELD): HE D. 1 JULY, 1818, AND WIFE DIED 27 AUGUST, 1820, AGED 70 YRS.: HAD JAMES, B. 17 DEC., 1774; D. 18 JAN. 1775: Dorcas, b. 17 Oct. 1777; m. Capt. John Denny, 19 Nov., 1807: Mary, b. 11 Sept. 1779; m. Ebenezer Goodwin, 17 Feb. 1807: Mark, b. 22 July, 1782; m. Margery Cutts, 6 March, 1807: Alice, b. 12 Apr., 1785; m. Moses Goodwin, 19 Apr. 1809; 5 chn.: Isabella b. 23 Apr. 1788; m. Richard Rogers, 28 Jan. 1813: Betsey, b. 13 June, 1792; m. John Wentworth, 13 Nov., 1819; 2nd, James Wilson; d. Apr. 1868. Occupation Blacksmith, sd. to have m. Dorcas.

GENERATIONS 157-8.

BENJAMIN FERNALD, b. 1756; m. LUCY COTTLE, 4 Nov. 1777, (2nd or another Benjamin,) m. Mary Mellen, of Portsmouth. He d. 3 Dec., 1812: Had: Charles, b. d. 1778: Samuel, born 9 Dec. 1779, m. Mercy Rogers, of York, pub. 1 Nov. 1810: Mary, b. 9 Sept. 1781; m. John Hammond, 29 Dec. 1802; d. 19 Sept. 1856: Ann Maria, b. 20 Mar. 1809: Sarah Mellen or Marion, b. 16 Aug. 1810; m. Reuben Winchell, of Limerick, Me.; 10 chn.: GEORGE WASHINGTON FERNALD, b. 29 Sept. 1811; m. Elizabeth W. Shapleigh, 28 Nov. 1847: Another record gives 5 chn. and Washington Fernald. Benjamin the father, s. James, s. James, s. John and wife, Sarah (Hinckes) Fernald.

GENERATIONS 160-1.

WILLIAM FERNALD, b. 1732; s. William, s. Thomas, s. John and Mary (Spinney) s. THOMAS and TEMPERANCE WASHINGTON FERNALD m. Abigail, da. of Samuel and Mary (Spinney) (?Toby) 19 Apr. 1752; 2d, MARY da. ROBERT STAPLES, 10 Dec. 1761; Carpenter; Had: Eleanor, b. 25 May, 1752 or 3; m. Mark Hanscom, 6 Feb. 1773; 2nd, William Wooster, b. of Sullivan Town, Hancock Town, Hancock Co., eldest s. of Wm. W., 27 Sept. 1802; d. 1853: William, b. 28 April, 1755. m. probably the Mary Hammond recorded in Old Kittery, unless of same name as m. Son of Lt. Col. Tobias Fernald's, William, b. 1757; m. Molly, b. 1759 from preponderance of evidence in writer's possession this gives the Col. Tobias William that Mr. Joseph Fernald declared was in the Revolution with grave doubt of first da. data and family that throughout the whole of Old Kittery Fernald families should be only accepted as proved by unchanged wills (and records that from writer have been repeatedly stolen) and Mr. Henry Fernald conforms in declaring incorrect—for truth only we labor. Susanna, b. 29 June, 1756; m. Miles Ford, of Clinton, Me., who as "Milsford" with wife and da. appears in Waterborough, York Co. in U. S. Census, 1790. Chn. by MARY, da. ROBERT STAPLES who has four sons and 3 das. at Little Ossipee Town, U. S. C. 1790, and wife: Had Abigail, b. 1762; m. John Tethly about 1785; 1 da. 1790: Mary, b. 13 Mar. 1765; m. Joseph Hammond, Kittery, (3 das. 1790) 7 Nov. 1784; 6 chn.: James, b. 24 Apr. 1769; m. Susan Remick, 16 Jan. 1792 (only one Deacon James Fernald is found 1790 U. S. C. in Maine, none in N. H.) 2nd, Mrs. Nancy C. (Goodwin) Wakeham, 24 Dec. 1817; d. 11 Aug. 1854; 14 chn.: Hannah, b. 24 Apr. 1769; d. 18 Oct. 1779: Sarah, b. 25 Apr. 1774, m. Nehemiah Green, 12 Apr. 1807; d. 9 July, 1860: Lydia, b. 23 Jun. 1778; m. Josiah Remick, 6 Sept. 1801; d. 26 Nov. 1866.

GENERATION 157.

TOBIAS FERNALD, s. Nathaniel, s. Samuel, s. Dr. Renald, m. ABIGAIL SMITH, pub. 22 Feb. 1728, da. John Smith 3 of Durham Town, Stafford Co. N. H. (The line of Smiths are to 1790 from Sir Clement Smith, m. Dorothy, da. Sir John Seymour and Margery, da. Sir Henry Wentworth, who was an Ambassador to Spain, s. Sir John Smythe, m. Agnes Charnock, and had Thomas, John, George and others. Sd. George, b. : d. 1597; m. Maria, da. Francis J. Fernel, s. Dr. Jean Fernel. Sd. Maria, b. 10 Jun. 1559; m. 1 January, 1578, Sir Thomas John George Smith, and had Capt. John Smith, b. at Willoughby, Co. Lincolnshire, Eng.; d. at London. 21 Jun. 1631, neglected, drew a map of New Eng., went to Me. 1607, ret., and came over in 1614, he m. had William d. in Eng. but s. Joseph is recorded as of Hampton who had s. John, b. 9 Jan. 1669; married 1694, Susana, daughter Benjamin, Jr. of Dover; had John, Jr. born 1695.

M

HAD JOHN 3D WHO MARRIED AND HAD JOHN 4TH THE FATHER OF ABIGAIL. THE WIFE OF TOBIAS FERNALD, A COLONEL. AFORESAID DIED .ÆT. 80 YEARS: M. DA. JOHN SMITH JR.: JOSEPH, BORN 1701: Samuel. Ebenezer a younger brother of Benjamin and Winthrop. Elijah Horne said that Captain John Smith, who was probably either John Jr. or 3rd, built a Log Cabin on Stamp Act Island and hunted from there and its vicinity for beaver and other game. The Log Cabin was utilized as the residence of a deserter in the American Revolution. I have repeatedly seen its ruins. Lake Wentworth was first named Smith's Pond in honor of Captain John Smith, as was the Isle of Shoals, both names taken from them (thus the neglected to be righteously honored Smiths): above TOBIAS and ABIGAIL (SMITH) FERNALD had George, b. 8 Feb 1729 or 30; m. Eunice Knight, 6 Dec. 1753, by Rev. John Newmarch, and I find nine children in a record given to him, viz.: George, Abigail, John, M^{ary}, Thomas, Nathaniel, Renald, Samuel and Tobias, who, after Dugdale, I "ghess" if data is discovered destroyed by vandals, will reduce some of the numerous marriages to a single person, unnecessary, to prove our ancient family of Turkish honorable descent. Three colored inks have been found in one family record. Tobias, above, born 13 April, 1754; married Elizabeth Mitchel, 28 April, 1776. Rev. Benjamin Stephens officiated.

GENERATION 158. GEORGE FERNALD, son of above, born in lawful wedlock, 1729, married EUNICE KNIGHT, 6 December, 1753; had George, born 3 November, 1753; married——: Abigail, born 26 July, 1759; married Joseph Brooks, 8 December, 1776, and died; William, born 1761; married——: Tobias, born 1 April, 1757; died small pox, unmarried.

GENERATION 158. TOBIAS FERNALD, born 1754; married ELIZABETH MITCHEL, 28 April, 1776. Rev. Benjamin Stephens officiated. In American Revolution son Tobias killed on Constitution; married Abigail Chambers: Had: Sophia Ann: Lydia Frances: John: Pelatiah (M. C.): William: Had descendants: George, born 30 January, 1777 or 8: Richard More, born 24 March, 1780 or 1: Tobias, born 8 September, 1782 or 3: John, born 11 November, 1785: James M., born 22 August, 1788: Eunice, born 1 December, 1791. He is credited with 5 sons by United States First Census, 1790. What has become of the Records sent to Rev. O. H. Fernald for Professor H. T. Fernald with those of Attorney Fernald that I requested a loan of to copy after their refusal to print to honor state and government and the breaking of his promise to enlist with me in the next war, which are always righteous of "Uncle Sam." Attempts were made from tools that aided the miscarriage of justice in the court of Judge Charles S. Lilley, notwithstanding six saw crime, and one honorable gentleman interrupted the court by a charge of then "perjury" that was reported to me as bought up for \$50,000: subornation of perjury: attempted to get me on the "Maine" before it was to be blown up, well known in Boston, and to make war by the fanatics, I fought. How my promise was kept the following shows;—

"Address Bureau of Navigation Navy Department,

and Refer to No.

L. D.

91165

{ Seal. }

WASHINGTON, D. C.

February 24, 1898.

SIR:—The Bureau acknowledges the receipt of your letter of the 18th instant, volunteering your services as Surgeon in the Navy in case of war with a foreign country, and informs you that the same has been placed on file and will receive due consideration.

Respectfully,
Dr. C. A. Fernald,
1483 Washington Street,
Boston, Massachusetts.

S. W. Dickinson,
Acting Chief of Bureau.

Tobias Fernald, wounded, withdrew his amputated arm from surgeon, waved it in air, joining his comrades shouts for victory in the War of 1812.



THORE OF 7 ATTEMPTS TO GET TO THE FRONT, ONE SENT TO CHARLESTOWN NAVY YARD WITH NEPHEW'S EDWARD EVERITT DIXON'S ACCOMPANYING NAME THAT WAS PERSECUTED FOR seeing and testifying to crime that a high dignitary of church might escape an ante-mortem deposition of capital crime, that Boston Police were too cowardly to arrest, preventing sixteen plus 38 more slain, and with a righteous claim paid, gives debt of \$126,000,000 city of Boston, that boasted of having "the power and" would "soon the money"! Dupes? 62,000,000 people being enslaved.

My native state protects its children.

"STATE OF NEW HAMPSHIRE"

"Adjutant General's Office."

"Concord, May 31, 1908."

"Dr. C. A. Fernald, 1483 Washington St.,
Boston, Mass.

Dear Sir:

By direction of Governor Ramsdell I have the honor to acknowledge receipt of your letter of May 26th to him, and to express his thanks and appreciation of your patriotic offer, which has been placed on file.

A. D. Ayling,
Adjutant General.

A. D. A. F."

When any well bodied man refuses after or before promise to fight for his Country and deliberately forces his attenuated blood other relatives into a line cutting out a loyal class, denying "authenticity" in print of facts that he was at cost of writer requested to come and investigate the old true documents in my safe and Bible Records, which are acknowledged by officials representing 1, 411, 171, 381 people and the descendants of 500,000 of the ancestors of General George Washington's ancestors in America, is it not time that he should select a country where the belief is taught to "do evil" which I leave to the experts of all nations trustingly to determine and settle truly.

OUR LINE IS CORRECT DESPITE THE MACHINATIONS BRIBERY, FORGERIES NUMEROUS I HAVE SELN, PERJURIES, CRIMES OF QUADRUPLE ALCOHOLIC, SOCIAL MALPRACTICE RING HERETOFORE SET FORTH FOR NATION'S SAFETY.

GENERATION 150. TIMOTHY FERNALD, b. 1738, s. of Nathaniel and Mary, m. ELEANOR ADAMS 10 May 1764, da. John, s. John, s. of Christopher, the Emigrant, and petitioned for land 1644 in Mass. with Henry, Sr. & Jr. & Thomas with Samuel Adams. Had Nathaniel Fernald, m. Hannah Spinney and had Wm. D. Fernald.

GENERATION 154-5-6-7-8. Renald, s. Samuel, s. Nathaniel, s. TIMOTHY FERNALD, b. a. 1745, m. MIRIAM, da. Ebenezar and Patience (Mendum) Fernald, 17 Oct., 1762-3; Had: Sally, b. 13 Dec., 1764, m. Nathaniel Hanscom: 12 June, 1791. Had chn. Meriam, b. 28 Feb., 1766, m. Joshua Small of Limington, Me., 30 Oct., 1800, probably moved from Little Ossipee: Polly, b. 8 Apr., 1771, d. 19 May, 1796 and may or may not have been the Margeret of Kittery, widow, with one son and two das. from a m. to another Fernald.

TIMOTHY FERNALD m. PATIENCE, da. Jonathan and Rachel (Powers) MENDUM 17 Oct., 1770; Had Susanna, b. 14 July, 1772; d. 14 Dec., 1798; m. Tryon who d. credited with two sons and 1 daughter and d. 1798; Hannah, b. 11 Jun., 1774, m. Henry or Joshua Small of Me., 15 Feb., 1819, probably son of Henry of Little Ossipee.



GEN. 159. NATHANIEL FERNALD, B. 1740, S. NATHANIEL, S. NATHANIEL, MAR. ANNA ALLEN; SON OF CAPTAIN WILLIAM OR SAMUEL THE SHIPWRIGHT, SON DR RENALD AND WIFE JOANNA Warburton; married 5 May, 1763 MARY GUNNISON. Dealer in Shoes. Did not live in Kittery or Berwick, proof U. S. C. 1790, pp. 57 and 61 nor can I find him recorded in either Maine, New Hampshire or Mass. Census. The descendants ascribed to them: Nathaniel, born _____; died February, 1806; married "Sarah Googin," children, Mark, David, Samuel, Nathaniel and two "perhaps" Sarah and Mary: John, born _____, married Betsey Carvill, 2nd Betsey Rich, pub. to him or another John, 9 December, 1810, said to reside in Saco and "Poland, Me.," children Hannah, Mary, Joseph, Eunice, Nathaniel, Hope and Sarah (Sally): Joseph Gunnison, born 22 September, 1770, married Hope Cobb, died 3 March, 1849. Resided in Portland, children, Mary, Benjamin Cobb, Ann, Samuel Rand and James Edward. Timothy, born 5 May, 1777, married Betsey Whiting Ray 1799, died 14 August, 1834, resided in Otisfield, Me. Children, Miriam, Otis, Betsey, Eli, Mary, Emily, John Colby and Albert Lewis. Another child is given, that belongs to Col. Tobias Fernald and his name is MARK, grandson Captain John Fernald and his wife Elizabeth (Rogers of Ipswich.) Cup found in Eng. declares Christianity taught 69 A. D.

GENERATION 158.

BENJAMIN FERNALD, son Deacon John Fernald and wife Sarah (Hinckes), son Dr. John and wife Mary (Spinney), son Thomas and wife TEMPERANCE WASHINGTON FERNALD was born 2 April, 1717, married SUSAN (Susie) LUCINDA (Lucy) CHADBOURNE 21 November, 1743. Had: MARK, born 1 January, 1745; married _____; had children born at Portsmouth. Shot accidentally or intentionally on Hancock Wharf at Boston, May 7 and died 14 May, 1779. In American Revolution. Annulus, b. 10 Feb. 1746, married. In American Revolution. Died. Benjamin, born 29 April, 1748, married "probably Sarah Beaver." In American Revolution. Died 12 November, 1812. Sarah Hinckes Fernald, born 12 March, 1750, married _____; died _____; From courtesy of Recorder at Old Court House and Officials at Historical Rooms, Beacon Street, I am indebted for replacement of stolen Records relative to Captain MARK FERNALD, giveth.

CONTINENTAL JOURNAL, May 7, 1779: Item as follows:—
 "The following melancholy accident happened on Saturday afternoon last: As Captain Mark Fernald of Portsmouth was standing on Hancock Wharf, he received a musket-ball in his shoulder which broke his collar-bone and otherwise wounded him in such a manner that it is said his life is despaired of. The ball was from the Warren Frigate, and was aimed at a boat that was coming up the river, under pretence of her not showing proper respect for the Continental flag then displayed on board of the Commodore. The shot was fired by the boatswain, who was said to be the principal officer then on board."
 20 May, 1779 Continental Journal "On Friday Evening last, died here of the wound he received as mentioned in this paper of the 7th inst., CAPTAIN MARK FERNALD of Portsmouth. A worthy, honest man."

GENERATION 159.

BENJAMIN FERNALD if "Old Kittery" (book of Mr. Stackpole) be true, the son of above Deacon John and Sarah, born 1748, married Sarah, daughter John and Sarah BEAVER, 1765-6, born 28 February, 1745 at Boston, died 12 May, 1801. He died 12 November, 1812. Served in American Revolution. Had descendants. Catherine, baptized 4 January, 1767, married Captain Ephraim Keen 19 February, 1800, 2d, Samuel Fernald, 5 February, 1821; died August, 1828: Sarah, baptized 3 February, 1771: Simon, baptized 22 September, 1771, married Miriam Fernald 6 July, 1794: Benjamin, baptized 6 August, 1775: married Hannah Fernald, 12 February, 1800: Mark, married New York Lady and died at New York. Anna, baptized 8 March, 1780; married Thomas Dennet 4 April, 1805: Edward, baptized 3 March, 1782: Joseph baptized 8 March, 1784, died young. Joanna Beaver, baptized 20 October, 1785, d. of smallpox. Fanny, baptized 24 May, 1788, married John Shute of Portsmouth, 1811. "Ghess" s. John of Concord, N.H., 1790: Mehitable, m. Josiah Keen, 2d Ebenezer Spinney. Milton says in Alfred's time Justice not only flourished but triumphed.

M

ARK FERNALD, b. 7 Jun. 1749, s. JOSEPH AND ANNA, s. BENJAMIN AND CATHERINE, s. CAPT. WILLIAM, s. DR. RENALD AND WIFE JOANNA Warburton, m. MARTHA RACKLEY, 2 Jan. 1773; 2ND, Eunice Leach, 7 Oct. 1804. He was Sea Capt., d. 9 Oct. 1824; Martha, b. 5 Feb. 1753; d. 18 Mar. 1803; Eunice, b. 28 Oct. 1761; d. 5 Feb. 1844. Descendants—Temperance, b. 28 Mar. 1774; m. Eastwick Pray; Mark, b. 1779; d. y.: William, b. 3 Dec. 1780;

GENERATION

159. d. 10 Jun. 1815, in Dartmoor Prison, Eng. I have his or another William Fernald's canteen that he used in the War of 1812-13: Martha, b. 24 Nov. 1783; m. Benj. Jenkins, 4 Jan. 1804; Joseph, b. 27 Mar. 1786; d. 20 Aug. 1805. at Damarara; Molly, b. 25 Mar. 1788; m. Samuel Laighton, of Portsmouth; d. 1 Mar. 1834: Phebe, b. 18 Sept. 1790; d. 8 July, 1855.

GENERATION

159. WILLIAM FERNALD, h. ———: m. 14 Apr. 1793, LUCY, b. 1771, da. JONATHAN and SARAH FERNALD, s. Ebenezer, s. Capt. William, s. Dr. Renald; he d. 17 Apr. 1828. A Fisherman. Further and date of birth, I cannot find to present time. Prob. s. George and Eunice (Knight) b. a. 1761; Had—Noah, b. 23 May, 1794: m. Lydia S. Brown, 15 Apr. 1831. Resided in Saugus, Mass. Had—Albert H., Angeline and Ammi C.: Robert Phipps, b. 23 July, 1796; m. Mrs. Eunice (Brown) Sullivan: Benjamin, b. 23 Aug. 1798; m. Julia Clark, 17 July, 1825: Mariam, b. 18 Jan. 1801: Henry Brown, h. 6 June, 1803; Lucy, h. 25 Mar. 1809; m. Joseph Fernald, 24 Dec. 1835: d. 16 Dec. 1875.

GENERATION

158. BENJAMIN FERNALD, b. 1774, s. Benjamin and Sarah, s. Ebenezer and Patience, s. Capt. William, s. Dr. Renald; m. EUNICE PLACE, 2 Dec. 1795, da. Annas Place of Pownalborough Town, Lincoln County, Me.: Catherine, b. 30 Apr. 1796; m. Noah Manson, 16 July, 1817; d. 23 Dec. 1847: 10 chn. 4th changed his name to Benjamin Fernald and his descendants retain the name.

R

NATHANIEL FERNALD, m. 14 Aug. 1788, HANNAH, da. James and Abigail (WENTWORTH) FERNALD. He d. 2 May, 1824; farmer; Had—Hannah, b. 1 Jun. 1789; m. Robert Manson, 27 Nov. 1806; d. 20 Oct. 1871: James, b. 1792; m. Olive Pettigrew, pub. 18 Jan. 1817; d. 30 May, 1855; 5 chn.; York, Me.: Oliver, b. 158-9. 1795; m. Maria Hichborn, 31 Dec. 1820; d. 11 Dec. 1842, Boston, Mass.; 7 chn.: Susan, b. 1799; d. 1841: Renald, b. 23 May, 1800; m. Rachel Frost, 23 Mar. 1841.

GENERATIONS

GENERATIONS

158-9. DAVID FERNALD, m. ESTHER TUCKER, 13 Jan. 1791, da. Samuel and Esther (Tucker) LEACH, Farmer, in American Revolution; d. 27 Dec. 1846; Wife d. 25 Mar. 1839: Had—Samuel L., b. 6 Dec. 1791; m. Rebecca Harris, of Eastport; d. 1827 or 8: Unice L., b. 25 Sept. 1793; m. Stephen Young, 12 June, 1833; d. 1 Nov. 1888; 3 chn.: Ebenezer, b. 4 Oct. 1795; m. Mary Ann Manson, 6 July, 1820: Theodore, b. 31 Aug. 1797; m. Lydia Adams, 6 Jan. 1828: William, b. 16 Dec. 1799; m. Miriam Spinney, of Eliot, b. 31 Mar. 1836; d. 1856, at Eliot; 6 chn.: Esther, b. 20 July, 1802; m. William H. Brown, 8 Dec. 1829; d. 4 March, 1881.

GENERATIONS

A

158-9. JOSEPH WEEKS FERNALD, b. ———; m. CATHERINE, daughter Thomas and Jane Marr CHANDLER, 13 February, 1787; in American Revolution; d. 22 November, 1822; Wife, born 15 July, 1755; died 17 November, 1815; Had—Jane Chandler, born 30 December, 1787; married Thomas Trefethen; died 28 July, 1869: Daniel, born 30 October, 1789; m. Phebe Trefethen, April, 1812; died at Portsmouth. Catherine, born 13 July, 1792; married Timothy Parker, of Saugus, Mass., 4 May, 1815; died 15 February, 1855, at Saugus; Sarah Weeks, born 28 February, 1795; married John Chandler, of Saco, 5 Apr. 1813; died 20 April, 1814.

GENERATIONS

L

158-9. ELIHU FERNALD, married 18 January, HANNAH, daughter Thomas and Jane (Marr) CHANDLER, born 23 September, 1765; died 20 September, 1836; he was a Carpenter; died 4 December, 1851: Had descendants—James Brown, born 11 July, 1787; married Ann Card, 30 November, 1809; died 25 May, 1822; resided in Portsmouth, New Hampshire, and had 4 children.



F

MARY, B. 9 MAY, 1789; D. 10 JULY, 1790: MARY, B. 9 JULY, 1791; M. ROBERT NEWSON: HANNAH C., B. 14 JUNE, 1793; M. WILLIAM PARKER, OF SAUGUS: ELIZABETH, B. 16 SEPTEMBER, 1796; M. JOHN Alden, of Boston, Mass.; 5 chn.: Benjamin Chandler, b. 1 June, 1798; m. Lavina L. Fernald, 27 Oct. 1824; d. 11 Sept. 1878; resided in Portsmouth; 8 chn.: Sarah, b. 23 March, 1800; m. Thomas Jones, Portsmouth; Elihu, b. 6 May, 1802; m. Margaret T. Holbrook, 27 May, 1838; d. 25 Aug. 1847; 3 chn.: Jane Chandler, b. 9 May, 1804; m. Elihu D. Brown, 17 May, 1838; d. 16 June, 1882: Pamela, b. 14 Oct. 1806; m. Samuel Parker, of Saugus, Mass.: Olive C., b. 30 Jan. 1808; m. William B. A. Locke, 10 April, 1831; d. 30 Nov. 1874: Thomas, b. 28 Oct. 1809; lost at Sea about 1829; Martha, b. 18 Jan. 1811; d. 10 Sept. 1814.

GENERATIONS 158-9. SAMUEL FERNALD, m. 19 July, 1791, ELIZABETH CHANDLER, b. 17 April, 1773; d. 20 Nov. 1815: He m. 2nd, Mrs. Catherine (Fernald) Keen, da. Benj. and Sarah (Beaver) Fernald; He was a Sea Captain and Carpenter; d. 10 July, 1821: Had —Martha C., b. 1791 or 2; m. Elihu D. Brown, 29 April, 1824; d. 22 Oct. 1837. Proof wanted of second marriage, and the names of his other children, if any.

GENERATIONS 158-9. ANDREW PEPPERRILL FERNALD, s. Dennis, s. Tobias, s. Capt. William, s. Dr. Renald, b. 1753; m. 24 Dec, 1778, MARTHA, da. John and Abigail (Bartlett) SHAPLEIGH, b. 16 April, 1760; d. 26 Nov. 1819. He d. 18 May, 1821. Officer in American Revolution, Captain, Major, Adjutant, was ever prominent in all civil and military matters concerning the common good. He was more nearly related to the writer than has been heretofore shown for three brothers met at Portsmouth, N. H., and agreed to spell their descendants names as—"Fernald, Firnald, Furnald taking first part Fur of Roman ancestors; 2nd, Fir for Persian and oldest line and Fer for ancestor, Dr. Jean Fernel, they might know each the other descendants;" this compact and agreement was sacredly kept by an honored father and grandfather, as may be seen by their Bible Records, deeds, etc. Andrew P. spelt his name "Firnald," my brother changed ours to Dr. Renald Fernald's ancestral signature. (See autograph signature at State House, Boston, on petition to change Strawberry Bank to its present—Portsmouth.) Spelt his name "Firnald." Had descendants—Charles (named for Charles VIII, King of France) b. 22 Nov. 1799; m. Stairia Ayers, of Canterbury, N. H., 1807; d. Sept. 1823; Had—Martha (named for Martha Washington keeping in memory right descent from Robert Washington of Va. through Thomas and Temperance Washington Fernald) b. 21 Dec. 1781; m. Elisha Shapleigh, 9 Nov. 1801: Andrew (named for father and to memorize descent from the great Sir Andrews family) b. 26 May, 1785; d. 30 Nov. 1787: Sarah, (named for his foremother SARAH da. of Judge John Hinckes, and wife of John Fernald. To this given family is to be added two sons and one da. before 1790, "AUTHENTIC" proof United States Census) b. 13 Sept. 1788; d. 13 Apr. 1791: Abigail, b. 7 Mar. 1792; m. Nathaniel Hanscom, 18 Feb. 1819; d. Oct. 1849: Andrew, b. 16 July, 1794; m. Mary Ann Lord, of South Berwick, 19 Feb. 1819; d. 11 Jun. 1826; resided in Eliot; children—Martha, b. 28 Mar. 1820: Owen, b. 24 Aug. 1821: Mary E., b. 11 May, 1823: Andrew P., b. 26 Mar. 1825: John Shapleigh (named for Dr. John, grandson of Dr. Jean Fernel, both of whom were killed by religious fanatics) (see my past and present history of same) b. 1 May, 1800; m. Sarah Ann Paul, 26 Dec. 1826; 2nd, Mary Ann Meserve, of Barrington, N. H., 19 July, 1840; d. 4 Jan. 1863:

GENEALOGICAL REGISTER OF THE FIRST SETTLERS OF NEW ENGLAND, 1829. Presented to Charles A. Fernald by Mary A. Fernald, æt. 84 years, Nov. 19, 1895, Widow of Dr. J. S. Fernald, July 12, 1895, 46 Dudley Street, Roxbury." "Among all my husband's books there was this one, besides the Bible, he most highly prized, and I want to make a present of this and his door plate of silver as a keep sake and token of esteem". The former is before me with the beautiful handwriting of one of the noblest and best aged ladies that I ever was blest by knowing the most glorious work of God.



N

OW IN POSSESSION OF EVERY GENEALOGIST OF AMERICA SHOULD BE THIS EXCELLENT AMERICAN BOOK, PUBLISHED BY JOHN FARMER, AT LANCASTER, MASS., BY CARTER, ANDREWS & CO. DR. JOHN

S. Fernald was a very skillful physician, faithful and unsparing of himself to alleviate the sufferings of his numerous patients; a good genealogist; an erudite scholar; friend of the poor, even when they were not called God's poor; a good and deeply-loved husband; wise, affectionate father; an honest man, the noblest work of God. His widow frequently called upon me and related many parts of very interesting history concerning his labors that aid in this work, to be left for other generations to perfect, so far as possible. I was informed that about two years ago she had gone to join her beloved husband. He was not the first, by many, genealogist of the Fernald family. His writings, unchanged, would be a great aid, if in the hands of trustworthy persons. Far more valuable would be those of Henry, bro. of Dr. Renald Fernald, who also, I am informed, wrote some at Portsmouth, N. H.; Hon. Mark Dennett, Mr. A. R. H. Fernald, Rev. Mark Fernald, Francis Junius Fernel, Vossius, Dr. Jean Fernel, which the Vatican could have supplied in 1870 entire; Guy Patin, partly changed; and those who wrote up for kings of France—changed and changing as new lines occupied throne and as new popes came into office—et als. including Henry W. Fernald, Prof. H. T. Fernald and Uncle Rev. O. H. Fernald, with innumerable persons since my first Encyclopaedia was sent forth to all the world, our beloved relatives. Some further corrections of above—Col. Andw. Pepl. Fernald family, viz.: He d. 20, not 18th; Statira, eldest da. Mr. Joseph Ayers and wife Miriam; Mr. Elisha Shapleigh, 3rd s. Capt. Elisha and wife Elizabeth; m. 5th, not 9th, Nov.; Nabby, not Abigail (named for _____); m. Capt. Nathaniel Hanscom, eldest s. Mr. Nathaniel and wife Sarah (Sally) Fernald; John Shapleigh Fernald m. 17, not 26, Mrs. Sarah A., his wife; d. 16 April, 1838, and da. Mr. James Paul of Eliot and wife Mary; Mrs. Mary A. (Merserve) Fernald, wife of and widow Dr. John S. Fernald, was da. Mr. Andrew Merserve and wife Patience. I have 4, not 5, chn., to wit: Ann Martha (named for Annie of Britainy and Martha Washington, wife of Genl. George Washington), b. 30 Jan., 1828; Mary Caroline, named for mother of Washington, Mary (Ball), as also, reading double, aforesaid Ann for his foremother, Anna (Cotton), wife of Robert Washington of Va., 1630) Caroline for bro. of Augustine, viz; Charles Washington, also double the four names—VIII and Carol—from Latin Carolus—in English Charles, to wit. Charles VIII, k. France his ancestor. Sd Mary Caroline, b. 24 Dec., 1831, d. 30 Apr., 1832; Clara. Jane. b. 5 Sept., 1835 (name from Latin, clarus, clear: Old French, cleir, N. Fr. clair, Pr. clar, Sp. & Pg. claro, Ger. klar meaning here clear, bright ancestral line. The S . . . after "Ann. Clara. Jane. Sarah. Ann. theirs not mine" significant! Mary, also, named for the excellent wife of Charles VII, & Jane from 2d wife of king John, fr. Charles V, her name in History of France is also spelt Jane & Joan) (k. John's wife had Jane, m. Charles the Bad, king of Navarre) "Sarah. Ann. Paul their dau., b. 2 Apr., 1838". Will the writers of Old Kittery Families give authentic records of a fifth child?

GENERATION 159. DENNIS FERNALD, s. of Dennis & bro. of Col. Andrew Pepperill, b. 1757, m. 24 Aug. 1780 ELIZABETH STACY, b. 9 Jun. 1761, d. 14 Oct. 1842. He d. 1 Jan. 1836-7: Had descendants—Dennis, b. 24 Apr., 1781 Moved South and d. in South Carolina, Charlestown, U. S. A.: Charles, b. 7 Apr., 1783, m. Mary Libby 1 Aug., 1817, d. 12 Jun., 1841, 2 chn.: Elizabeth, b. 24 Apr., 1785, m. Samuel Fernald 11 Apr., 1825, d. Sept. 18—: Sarah, b. 7 Feb., 1788, d. 5 or 6 Feb., 1852; William Stacy, b. 21 Jun., 1790, m. Elizabeth Batson (or Hayden) of Quincy, Mass., d. 1854; 5 chn.: Margery, b. 9 Mar., 1793, d. 12 Apr., 1823; Martha, b. 29 Jun., 1795, m. Charles Parsons of York, pub. 8 Dec., 1817, d. at Spata, Ohio, 1840, 5 chn.: Robert, b. 10 Aug., 1797, d. y., Hiram, b. 5 Mar. 1801, d. 12 Apr., 1852; Miriam, b. 29 Dec., 1823; Samuel, b. 18 Dec., 1808, m. Laura Graham Cooper of Malden, Mass., d. 20 Feb., 1896 at Eliot, Me., 7 chn.



WOL. 18, pp. 36, 144, 145, 146, 148. GRAND JURY. BENJAMIN FANEUIL, ESQR.
 NO TAX DUTY ON TEA. 8D. BENJAMIN, WAITED UPON WITH
 CLARK & SONS, SAID TO BE FACTORS OF EAST INDIA CO., Re-
 quested by Town Committee to resign their Appointment. Refused to resign. Letter
 Daringly Affrontive to Town, Voted. Nov. 18, 1774 "Friends in England have entered
 into penal engagements in our behalf, merely of a Commercial nature;" not "to comply with request
 of Town." Signed by "Benja. Faneuil Junr., for self and Joshua Winslow, Esq., Richard Clark &
 Sons, Elisha Hutchinson for my brother and Self—" Letter read—satisfactory—Passed in the Negative
 Neme Cont." "Vol. 23, p. 203. Boston Ss: At Meeting of Selectmen, Nov. 28, 1773. Sabbath
 Day, Present." "Mr. Clark" and "Mr. Benjamin Faneuil another Consignee" of TEA,
 "—out of Town" "—not in Town". Vol. 25, pp. 11, 15, 33, 38, 49, 50, 51, 54, 55, 134,
 171, 182, 184, 185, 189, 204, 205, 217, 220, 221, 224, 227, 236, 241, 251, 257, 267, 268, 275, 280, 285,
 288, 295, 317, 323, 324, Faneuil Index. Mentions Hall, Market, etc. Lottery 1780. And 1783
 Hall granted to Deacons for disposal of Quarterly Charities. Lottery 3d time in Hall, 1783. Re-
 pairs. Repairs. Arsenal for Arms in upper chamber of Hall, 1783. Before and since President
 McKinley's death in Roman Catholic Churches. Lectures in Hall, 1785. No abatement of rents,
 F. Hall Market "Instructn. in Military Arts" at Hall, 1785. Compy. Cadets for use of Hall. "Lec-
 tures on Philosophy of Natural History—" "Repairs". "Inspectors." Cadet Co. firearms deposited
 Faneuil at "Hall." Vol. 29, p. 306. "Mr. Peter Fanieuel a Mercht." Vol. 30. Index, pp. 7,
 393. Faneuil (Fannell, Fannil), Benjamin, Marriage Intentions, 1752-61. Benjamin Faneuil, Jr.,
 & Jane Davenport 9 June, 1753 m. Maguam Ebert and Flora Fannil, m. 3 Sept., 1790 (Int. reads
 Magguam Eben, Funnell George Bethune & Mary Faneuil, m. Int. 15 July, 1754, m. 13 Oct."
 "Willson Fannell m. Sarah W. Williston, 22 May 1760. Int. reads Fennel" "Benjn Farnald &
 Elizabeth Willson, 19 Aug., 1798. John Freeland m. Elvina Larkin, 28 Feb., 1801." Vol. 31
 Faneuil mentioned 116 times. "Vol. 32 Strong Furnell, pp. 85, 121. ffurnell, bill, 14f. 6s. Power
 Atty." to col. £14 6s. Vol. p. 325, Peter Faneuil \$350 for Picture of him to be put in Hall Mr.
 William Fennelly (Ferneley) Dr. Renald Fernald chair sd. to bear Ferneley Arms "Appointed
 Auctioneer 182-3" Vol. 34. pp. 412-13. House owned by Benjamin, Nephew Peter Faneuil."
 There is great probability of Benjamin Sr. & Jr. being Fernely and Fernald and ancestors of present
 Banker, Geo. A., and Henry W. Fernald—I leave for future searchers. "Vol. 35. 117" times
 Faneuil Hall is mentioned. "Vol. 37. 66" times Faneuil Hall is mentioned. Robert Fennelly, or
 Fernel cy one of the Select Men, 1820: mentioned 7 times. Vol. 38, 1811, Robert "Fennelly"
 mentioned twice: Vol. printed 1908 and "Faneuil Hall" about 28 times. Robt. Fernel cy paid City
 for Drains with others, while since the religious and political changes. Boston stops up good ones,
 forces in bad, knocks underpinning from property and revels in 124,000,000 dollars unholy frauds to
 benefit those that should be brought to the bars of Justice. And be taught the Ten Commandments
 from the Bible Taken unwisely from our Schools. "In Vol. 28, p. 177 William Freeland m. Jane
 Miller, 26 Sept., 1732, JOHN FREELAND & ANNA MALLET m. Int. 15 Jan., 1736.
 THOMAS FORELONG m. ELIZABETH HAMLIN, 1 Apr., 1726" Int. read Forlong &
 Elizabeth Hamling." These copied give a pretty full index of names and matters concerning
 Faneuils as kept by the City of Boston as printed." Alfred the Great made additions to the good
 laws of KING INA=FNA whose valuable laws in a large book of great interest is owned by writer.

SIMON FERNALD, B. 1771, M. 6 JULY, 1794 MIRIAM, DA. EBENEZER AND SARAH (LEWIS) FERNALD & D. 19 JAN., 1827. SHIPWRIGHT AND MARINER. HAD—WILLIAM, B. 29 MAY, 1796, D. 27 SEPT., 1798; SIMON, b. 6 Dec., 1799, m. Joanna F. Williams 11 Dec., 1834; Sally Ann, b. 18 July, 1802; Joseph, b. 8 Nov., 1804, m. Eliza Rice of Portsmouth; Charles W., b. 7 May, 1807, m. Abigail Duley of Gloucester, Mass., 16 Dec., 1832, d. 24 May, 1867; Cooper: 5 chn.:

GENERATION 160. Harriet, b. 20 Jun., 1809, m. Oliver Adams:

GENERATION 161. NATHANIEL FERNALD, s. Tobias and Abigail (Chambers) Fernald, m. HANNAH SPINNEY, 29 Oct., 1791; Mariner and died at sea: Had—Olive, b. m. Joseph Dame 4 Jan., 1818; Mary, b. m. William Marden of Portsmouth; Patience, b. m. Lyman Parker March 1826; William Dennet, b. 4 Jan., 1807, m. Mehitable Odiorne Jan., 1828, d. 5 Dec., 1893, Spar maker, Portsmouth: 7 chn.

GENERATION 160-1. BENJAMIN FERNALD, s. Benj., s. Dea. John and Sarah, m. 12 Feb., 1800 HANNAH, da. John and Sarah (W.) Fernald and d. 1818 at Sea: Had—William Wentworth, b. 6 Feb., 1802, m. Elizabeth Make Peace Weeks, 19 Mar., 1823; d. 12 Nov., 1871. York Farmer: 9 chn.: Benjamin, b. 15 July, 1804, d. 1820; John Beaver, b. 19 Feb., 1807, m. Prudence Lord 20 Nov. 1828, 2d, Abbie S. Langdon 17 Feb., 1859, d. 27 Feb., 1891; Ship Master: Resided at York. 2 chn.: Elizabeth, b. 28 Oct., 1808, m. Jonathan Lancton, pub. 11 Feb. 1827; Eliza, b. 22 Apr., 1811, m. Ezekiel Prescott, 25 Oct., 1830, d. 1868 at Brookfield, N. H., 7 chn.: Ann Wentworth, b. 24 Apr., 1813, m. Henry Thompson 30 Sept., 1835, d. 24 Dec., 1893 at York: 2 chn.: Sarah, b. 1815, d. y.

GENERATION 160-1. ROBERT PHIPPS FERNALD m. EUNICE (Brown) SULLIVAN 13 Jan., 1828: Had descendants—Sarah Catherine, b. 26 Oct., 1828, m. Alfred Jones of Saugus, Mass.: William Henry b. 14 Dec., 1829, m. Eliza Downing 14 Oct., 1851; Ship carpenter, Kittery: Lydia Maria, b. 30 Oct. 1831, m. Noah Manson 16 Mar., 1855; 3 chn.: Mary Eleanor, b. 17 Oct., 1833, m. Charles Clough 12 Dec., 1853; 9 chn.: Elizabeth Crosby, b. 23 Nov., 1835, m. Joseph Jenkins 1 Nov., 1859; d. Jun., 1883:

GENERATION 161-2. REGINALD (called Renald) FERNALD, m. RACHEL, da. ELLIOT FROST, 23 March 1841; Kittery Farmer: His wife was b. 18 Jun., 1812 and a Daughter of the Revolution:

Hannah C., b. 27 July, 1842, m. Frank B. Bartlett, 18 Dec., 1867; Calvin, b. 18 Dec., 1847; d. 14 Sept., 1852; Rachel, b. 18 Dec., 1851, d. 10 Jan., 1852:

GENERATION 159-60. EBENEZER FERNALD, s. David, b. 1795, m. 6 July, 1820 MARY ANN da Thomas MANSON, Ship Carpenter. In War of 1812 and d. 17 Nov., 1865: Had—Sarah Chandler, b. 20 Oct., 1820, m. William Cromack: Timothy, b. 13 Mar., 1822, d. 19 May, 1822; William, b. 30 Apr., 1823, m. SUSAN (Grey) TRUE, 2d Carrie Hammond 30 Aug., 1857 and d. 11 Apr., 1895. Ship builder at Portsmouth, N. H., 5 chn.: Eunice, b. 25 Mar., 1825, m. Lorenzo D. Witham 19 Mar., 1844; Ebenezer, b. 19 May, 1827, d. 15 May, 1851:

GENERATION 159. CAPT. DANIEL FERNALD, b. 1789, m. PHEBE TREFETHEN, April, 1811.12, Ship Captain. Had descendants: Joseph, b. 1816, m. LUCY FERNALD. 24 Dec., 1834, d. 1850; Andrew, b. 2 May, 1818, m. Mary Rogers Manson 5 Dec., 1839 and d. 4 Sept., 1889; had—George A., Phebe Ann, Mary Lavina, Joseph H., Frances Jane, Ellen E., Lucy A., Robert, b. 24 Sept., 1820, m. Cary Jane Donnell, pub. 5 Oct., 1848, d. 9 May, 1895; Resided at Malden, Mass.; had Frederick W., Daniel E., Charles F., George F., Eunice, b. 15 Sept., 1822, m. Joseph Tuttle 5 Dec., 1841; Thomas, b. 7 Aug., 1825, m. Delia Elwell 8 Dec., 1849; Mariner: Henry, b. 6 Dec., 1827, m. Mary Eastman 5 Nov., 1850, 2d Mrs. Mary A. Knights 18 Aug., 1877; had—Francena, Harriet, Clifford, Lillian, Jeremiah, b. 10 Nov. 1879, m. Marcia B. Leach pub. 18 Oct., 1851, d. 21 Sept., 1877; had—James, Everit, Daniel L., b. 8 Jun., 1833, m. Henrietta E. Bright- 13 Mar., 1869; Lucia Maria, b. 9 Oct. 1835, m. Daniel Parker of Saugus, Massachusetts.



S

THEODORE FERNALD, S. DAVID, S. EBENEZER AND SARAH (PROBABLY) ATKINSON, S. EBENEZER AND PATIENCE MENDUM, S. CAPT. WILLIAM AND ELIZABETH LANGDON, S. DR. RENALD AND JOANNA Warburton, s. Dr. John and Wife, Annietta de Coligny, s. Francis and Maria Commenius, s. Dr. Jean Fernel and Magdalene Lieullier, s. Charles VIII and Anne of Britainy, 158. Their lawful wives, and the whole line as given back to our world's worthy ancestors, Adam and Ava. Created by Our most Glorious God in His Image and His Wisdom, m. 6 Jan. 1828, LYDIA, da. Samuel and Lydia (Coleman) ADAMS, and he d. at Sea, 18 Nov. 1836: Had descendants—Harriet Olivia, b. 9 Sept. 1829; m. Henry W. Trefethen: Samuel, b. 19 Nov. 1831; d. July, 1862, in Civil War: Alonzo, b. 20 Mar. 1835; m. Martha E. Berry, 2 Oct. 1859; 2nd, Annie Irene Philbrick, 27 Jun. 1880.

GENERATION

GENERATION

159. WILLIAM M. FERNALD, b. 7 Apr. 1796; m. ABIGAIL WOODS FERNALD, 3 Dec. 1820, da. of James and Hitty Barry, of Boston, was of Kittery, Me. From News Paper—"Mr. William M. Fernald, May 6, 1875. He was in the War of 1812" In the book of life—God's Album—May his name be found with care—And may all who have here loved him—Find a home there." A little of first was illegible, but the writings in Holy Bible gave same facts. This Bible was presented to me by a descendant. Children—Anna Abigail, b. 17 Jun. 1821, Sunday morning, 1-2 past 1 o'clock; m. Tilton, and d. 18 Apr. 1849: William Henry was b. 9 Dec. 1822, on Monday morning, 1-2 past five o'clock: Lucy Pray, b. 16 Dec. 1826, Saturday morning, 4 o'clock: William Frederick, b. 31 Jan. 1830, Sunday afternoon, 5 o'clock: Albert Henry, 21 Mar. 1835, Saturday morning, 9 o'clock: William Fred. Fernald, d. 29 Jun. 1883. Mrs Abigail W. Fernald, d. 29 Jun. 1883, aged 80 yrs., 6 mos, 21 days. 8 stanzas of poetry pasted in back of Bible, written by A. D. F. Date of Bible, 1818 printed.

FROM MARRIAGES PAGE.

GENERATION

159-160. From Family Record BIBLE of Dr. John Fernald copied in Bible of grandson William at Portsmouth, N. H., given writer by Aunt Sophronia (Chase) Fernald, Cordis Street. "of the ages JOHN FURNALDS' Children. (The name of his wife MARY SAVAGE was part erased and completed while writer was at Church) John W. Fernald, born Saturday, October 24, quarter past ten, A. M., 1772. James Fernald, born Thursday, June 24, at two o'clock, P. M., 1779. Polly Fernald, born Tuesday, Sept. 5th., at ten o'clock, A. M., 1782. Abigail Coffin Fernald, born Thursday, April 2, at 10 o'clock, A. M. 1785. Mary and Betsey Fernald, born Wednesday, August 1st, at nine o'clock, A. M., 1787. Sarah Fernald, born Friday, June 11th, at nine o'clock, A. M., 1790. Deborah Sherburne Fernald, born February 27th, at daybreak, 1791.

GENERATIONS

160-161. From same above Holy Bible, Births page 2 now, as found—If recorded WILLIAM FERNALD, born 1775, at Brookfield, incorporated as a town from Middleton, 30 Dec. 1794, after an attempt to form a new town from parts of Middleton and Wolfborough which petition "To the Honorable the Council and House of Representatives sitting at Exeter—" was signed by "Nicholas Austin, Benjamin Clay, Josiah Robinson, Stephen Lyford, Jonathan Clay, Bartholomew Richards, Jedidiah Drew, David Durgin, Daniel Croxford, Eb'zer Bennet, Simon Dearborn; (my great grandfather) JOHN FARNEL, (who in the spelling of his last name kept in second letter O, the family and most ancient seal in the world, see same on history of Creation from Tablet of Abydus and on the oldest Egyptian Pyramid, also he kept the exact number of letters of Dr. Jean Fernel name) and he and his wife Mary Savage were the parents of preceding, Gen. 159, family;) Isaac Drew, Joseph Wille, Samuel Tibbetts, Josiah Wiggin, Ezekiel Sanborn, William Wile, Moses Perkins, Peter Stellings, John Palmer, who were then of Middleton. Of Wolfborough—Robert Calder, William Cotton, Joseph Leavitt, James Sheafe, Jonathan Lang and John Costelloe." A petition the same month of June, 1785, more numerously signed, defeated it.



❀ ❀ ❀

F SPECIALLY DESIGNATED IN AFORESAID BIBLE RECORD BESIDES THE TWELVE CHILDREN OF MR. WILLIAM FIRNALD & WIFE MRS. ELIZABETH (BETSEY JOHNSON, DA. PHINEAS, S. COL. SAMUEL JOHNSON; IS the Family of William Fernald, Jr. & Chase Family, viz:—

GENERATION 161 WILLIAM FERNALD, Jr., b. Mon. May 1811 m. SOPHONIA CHASE, b. 1814. Had descendants: George W. Fernald, b. 28 Nov. 1831, m. Had several descendants; Tanner. Resided at Portsmouth. Charles Gustus, b. 2 Oct. 1838 d. y. 1838. Ann M. Fernald, b. 6 Jan. 1841, m. Rev. Charles D. Young and had descendants: Mrs. Sophronia (Chase) Fernald's brothers and sisters were—Joshua W. Chase b. 1781: Ruth, b. 1789; John E., b. 1810; Sophronia, b. 1812; Mary, b. 1814: William Fernald, d. 20 Apr. 1853 and his wife 30 Sept. 1867 Betsey or Elizabeth at Wolfboro. and they are buried at Portsmouth, N. H. William Fernald Jr. d. 19 Apr. 1862 & his sister Mrs. Elizabeth Darling d. 22 Feb. 1859 and brother Mr. Henry Hinckes Fernald, d. 6 Oct. 1855. See page Bible Record for further information.

GENERATION 158. AMOS FERNALD, b. 16 Apr. 1686 and son of Deacon John Fernald & Wife Sarah Hinckes, s. of Dr. John Fernald, & Wife Mary Spinney, s. Thomas Fernald & Wife Mrs. Temperance Washington married 4 Nov. 1714 MARY WOODMAN: Had 2 sons:—Humphrey, b. 1716 d. 3 Apr. 1766, m. Mrs. Dorothy Sims of Portsmouth, N. H. 6 Jan. 1740: Had 5 chn.: John, b. 1718 m. Mary He was a Mariner and his Father and brother were Coopers:

GENERATION 159. HUMPHREY FERNALD, s. Amos & Mary Woodman his wife as before set forth de facto, s. John & Wife Sarah, da. Judge John Hinckes, m. Dorothy Sims, widow of Sims and da. of Samuel Fernald, b. 9 March 1676, who was s. of Samuel, s. Dr. Renald Fernald and a cousin. Humphrey d. 3 Apr. 1766 and his wife d. 6 Sept. 1770: Had descendants: John, b. Nov. 1740, d. Nov. 1792, m. Mary Bowles 19 Jan. 1771: His widow m. Deacon Jno. Noble of Portsmo. and d. 1804: Elizabeth, b. 1745 m. Capt. Thos. Darling in 1763 and after his death 2d Rev. Dr. McClintock of Greenland in 1786. 2 chn. 1st m. Thomas, d. y. John R. Darling or Darling who commanded one of Mr. Gray's Indiaman and d. in Salem 1807 leaving a large property to his mother 2d m. Elizabeth d. Wm. and wife Betsey (Johnson) Fernald, b. 19 Sept. 1804 & d. 22 Feb. 1859 to 1 son Samuel. Mrs. Elizabeth McClintock d. in Portsmo. July 1813 aet. 68: Humphrey Fernald Jr. b. Nov. 1749 m. Sarah Stickney of Newburyport and d. 9 Aug. 1796. One son left John Fernald, widow m. Capt. Moses Little of Campton, N. H. In Yellow Fever epidemic, 1798, left Portsmo. for Campton, but only reached Dover, N. H., when both Husband & Son had the fever and d. in three days after leaving Portsmo. after Mr. Little's death his widow m. Capt. William Noyes of Newburyport, & d. there 1812: Mary Fernald b. m. 1st Capt. John Hart of Portsmo. 1780, He d. m. 2nd Capt-Wm. Parker who d. 1797; Mrs. Mary Parker, d. 1800: 2 sons by Capt. Parker, John, d. y. Samuel m. Ruth Brewster of Portsmouth. He d. 1816. Mrs. Parker m. Capt. Samuel Rice, living at Claremont, N. H. at time this record was written: 5th Samuel Fernald bro. of four preceeding and son of Humphrey & Dorothy Fernald, b. Aug. 17th 1756, m. Deborah Griffith 7 Nov. 1784 by Rev. Samuel Haven, D. D. Capt. Samuel Fernald d. 4 Jun. 1830 aet. 74 yrs. Mrs. Deborah (Griffith) Fernald d. 1839 aet. 79 yrs. He was formerly Town Clerk of Portsmouth.

“**I**OANNIS MERCERI REGII QUONDAM IN ACADEMI PARIISIENSI LIT-
 ARUM HEBRAICARUM PROFESSORIS ERUDITISSIMI; DILIGENTISSIMI
 AND IN PRIMIS VERAE RELIGIONIS CULTERIS IN GENESIN PRIMUM
 MOSIS LIBRUM, SIC A GRAECIS Appellatum Commentarius NUNC PRIMVM
 IN LVCEM EDITVS Addita THEODORI BEZAE praefatione,” with plate bearing

our ancient seal; and hieroglyphic C found on Dighton Book, with a motto, “**VIDE BENIGNI TATEM AC SEVERITATEM DEI,**” with a tree in centre bearing round encircled globes, and at right a majestic man, raised head bearing our seal and hand pointing to Heaven, with in front a hand and arm passing an ax from the encircling clouds; three stumps; all encircled with a wreath of leaves, etc., etc. Beneath, “**EXTIPOGRAPRIA MATTRA EI BERJON:—M D XCVIII,**” ARE FOUND OUR AUTHENTIC RECORDS THEREIN: “Charles and Anne of Britany, R. Viii, France, 5 chn. Charles VIIj fili Dr. Jean Fernel, born at Clermont, 26 April, 1497, FINIS GENESEOS: Ob. 26 April, 1558; m. Magdalene, da. Jean Lvuilluier; b. 3 June, 1506; m. 2 April, 1530; ob. 26 or 30 March, 1558. At Fontainbleu (on margin) 4 Chn.: B. Francis, 3 March, 1533. At Cher Bouges: Ioannes Fines, b. 3 Feb., 1535; II, Magdalene, b. 1 Miy, 1544; ob. 1638; m. Gilles de Riant; III, 4 chn.: Maria Fernelius, b. 5 Sept., 1546; m. Philibert Barjot, 3 May, 1568; IV, 5 chn. Francis, sonne Dr. Jean Fernel m. Maria Commenus, da. John Amos Commenius, son of Phil. Comenius, 2 April, 1555;” (this last name is either Comenin’s or as written; the records have been wet and difficult to read: all records are open to experts of state and governments that have stood loyal and staunch in our social war against the downfall cause of nations from time primeval) (being a microscopist, hence accustomed to search for hidden things, I have carefully, with magnifying glasses, searched for truth all records that are not clearly distinct for this book). “Maria de Ferneley, ob. 29 March, 1571; 3rd, m. Rebecca, da. Emaneuil Tremelius and wife Rachel; 4, m. Elizabeth, da. Marquise Bertrand Fernelon, 10 Dec., 1581; his oldest, John, b. 15 Cal. Id. March, 1556; m. 4 Jan., 1571, Josephine, da. Marguerine de Vigne; b. Maria, 11 June, 1572; b. S. S. T. Yrkolsky; m. 2nd, Annetta, da. Admiral Gasparde de Coligny, wickedly slayne at St. Bartholomew; b. 15 Sept., 1550; m. 2 June, 1573, Had—William, b. 12 June, 1574, at Castle Heidelberg; bapt. 16 June in ye Church of Holy Ghost, Baden, Germany. Dr. John, in Royal Navy, was stabbed to death by ye Jesuit Clemens on ye vessel’s deck at night, 25 Aug., 1575. Good Queen Bess favored W. him and struck by Mynt ye COIN of 1575 (to commemorate John’s death). His father, Francis; Chaplin, Warrior, Dr., Lawyer, was poisoned by Vatican, Papa, 30 Nov., 1602. Capt. Sir William Ferneley m. ELIZABETH, da. Girard Amand and his wyfe, ELIZABETH WASHINGTON, da. Samuel Washington and wyfe Anne da. Francis and wyfe Maria Commenius, and adopted da. of Mr. Hathaway) sometyme writer playes as William Shakespere (see his alias photo. signature). Capt. William Fernel forte ye Spanish Armada, Knyted by Essex; m. ELIZABETH Amand, naymed by Queen Bess, 16 May, 1594; IX chn.: Renald Fernald, eldest, b. at Bristol, Eng., 6 July, 1595; m. Ioanna Warburton (da. of George, d. 1 Jan., 1612; 2nd son of Sir Peter); b. 1603; m. 1619, Jan. ye First, and d. 15 May, 1660; hurried at Point of Graves Cemetery with Dr. Renald Fernald at Portsmouth, N. H.; ii Thomas, b. 13 Aug., 1597; iii Henry W., b. 5 Dec., 1599; d. s. p. poisoned at Old Castle Hotel; iiij William, b. at Eastwick, 30 Dec., 1600; v Robert, b. 20 March, 1604; vi Jno., b. 9 April, 1607; vii Edward, b. 4 Oct., 1611; m. Mary, da. Thomas and Philadelphia Scroope, sister of Emanuel; viii Strangue, b. 16 Nov., 1614; m. Aellone, da. Lenord D. Acres, 2nd son Wm., conspired vs. Queen; attained, acct. property of 3 sisters; m. 3 sons Duke of Norfolk; ix Joseph G., b. at Feurs en Fores, 5 Aug., 1648; d. 10 Sept., 1730, at Paris; unable to recover Dr. Jean Fernel’s descendants’ money; m. Joseph was born 1712. His father moved to Avignon. He was prof. anatomy in Royal Gardens; celebrated author.







LINE NORTH AMERICA, NEW ENGLAND NEW HAMPSHIRE
PORTSMOUTH

W

"I, Thomas and Wife Temperanc Washington fernald write these Records from my Father Capt. Reginald Renald F. and bro. Henry Fernald's Holy Bibles with my own, leaving some places to be filled by my descendants." "IN GENESIN (p.) 127 In Cap. V. (Before said Book)

My Honour'd Father, Capt. Lieut. Dr. Renald Furnel Chirurgion, Sonne of Commander Sir William Furnell Son of Dr. John, Son of Rev. Francis, Son of Dr. Jean Fernel ye Son of ye King Charles VIII of France and wives—Anne of Britainy da. Francis (indistinct), Magdalene Luillier, da., Jean Couinsseiller of Paris; Maria Commenius, da. John Amos Commenius, Annetta, da. of Admiral Gasparde de Coligny, France; Joanna Warburton, da. George, Son of Sir Peter Warburton, Knt. and Wyfe Mary, da. Sir John Holcroft, Knt., m. 2 July, 1619: Had—Thomas fernald, born 1 July, 1620,—m. Temperanc Washington, da. Robert and wife Anna da. Sir Robert Bruce Cotton, 16 Dec. 1639, at Chester, Old England, born 6 of June, 1622; m. at Virginia: Elizabeth, born 4 March, 1630—Steven Eastwick iiiii Jan. 1670, dyed in birth of Henry, Jan. 1, 1674, burd. at Point of Graves: Mary, born 5 May, 1634; m. John Partridge, 11 Dec. 1660; d. (other records give d. 16 Aug. 1722): Sarah, born 3

S

Apr. 1636; m. Allen Lyde, 3 Dec. 1661; d.——: John Fernald, born 27 Sept. 1640; d. s. p. unm., 1687: Samuel, born 4 March, 1642; m. Hannah Spinney, 6 Oct. 1674; died 1 Dec. 1698: The Spynie Barony in Scotland that ought descend to her Fr. Thomas and wife Margery Manwaring, da. George and Elizabeth is wythe held. (name after spelt) Mainwaring. William Fernald, born 5 March, 1648; m. Elizabeth Langdon, 16 Nov. 1671 born 13 September, 1656, da. Capt. Tobias and Elizabeth Langdon. Dr. Renald Fernald died 6 Oct. 1656: Mrs. Joanna, d. 29 December, 1660. Continuance of Mr. Thomas Fernald's Records:—"My Sons and Daughters Born are—John, born

T

12 December, 1640; married Mary, da. Thomas and Margery Spinney, da. George and Elizabeth Manwaring, 8 Jan. 1671, b. 9 Feb. 1650: Anne, born 1 July, 1651—Robert Atkins, 9 Nov. 1686, d.——: Thomas, born 2 July, 1653; m. Elizabeth, born 1655 or 4, m. 1671 or 2, da. John Farnel, 2nd s. Henry Pranel and wife Frances, da. Thomas Howard and wyfe 3rd Mabel; H. Pranel, Citizen of London, s. Francis, s. Francis, s. Dr. Jean Fernel: Had Henry, Eizabeth, John, Thomas, Anne, da. bef. b., Anne; w. m. E. Seymour and Lodovick, an Earl and Duke. Had—Elizabeth, m. Stephen Eastwick; John; Mabel; Frances and Margaret: Patience, born 3 May, 1655; m. Steven Eastwick, 1674; He was a Sea Capt- yne and dyed 23 Sept. 1691: Mary, born 16 June, 1657; m. Samuel Pray; 2nd, Thomas Barker, born 15 May, 1658: Samuel, born 1 January, 1659; m. Mary, da. Sir William Seymour and 2nd wyfe Frances had—Wm., d. y.: Samuel: Mary: Joanna, b. 13 Feb. 1663; m. Mr. Charles Kelley, 25 May, 1683; had—Jane, Margaret and John: Sarah, born 2 March, 1668; m. Mr. William Henderson, 16

A

of July, 1690, s. of John, s.: Hercules, b. 28 September, 1688; m. Mary, da. Rev. Peter Funal and wyfe Sarah; s. Rev. Daniel and wyfe Mary Moulin, s. Francis, s. Dr. Jean Fernel; m. 2nd Sarah Hick which John Fernald II copy by request of my honored grandfather. Mr. Thomas fernald who died on ye 15 of July, 1699 (last 9 is blotted probably by wetting of Book, but more distinct of 9 than 7 and is one of the two figures) and my grandmother, Mrs. Temperanc WASHINGTON fernald departed this lyfe ye 20 of June, 1706. My My honoured father, John Fernald, I, Died 1 September, 1687, and my mother died 19 April, 1697, and buried at Point of Graves syde by syde. From my foreparents Bibles I copy ye Records. I John 2nd who was born 4 March, 1673, and married Sarah, ye da. of ye Judge John Hinks and wyfe Elizabeth Fryer, May 10, 1773. My brother James was born 14 August, 1676, and married Mary Hinks, da. Judge John and Elizabeth, da. Judge Nathaniel and Christian Freyer, of Portsmouth, N. H. Elizabeth, born in Boston, 1 November, 1657. Thomas, 17 September, 1678. Mary, da. James and Susan Thompson: 3 daughters—Lydia, born 13 May, 1680; married Benjamin Miller; 2nd, Moses Dennet: Margery, born 16 April, 1686; married John Marshal, 11 February, 1720: Amos, born 16 April, 1686; married Mary Woodman, 4 November, 1714; 2nd, Elizabeth Chadbourne, 1 January, 1720.



W

DEACON JOHN FERNALD MARRIED MISS SARAH HINCKS 7 AUGUST, 1796 WHO WAS BORN 22 JULY 1679. OUR CHILDREN WERE: JOHN, B. 15 MARCH, 1698, M. ELIZABETH ROGERS, DA. REV. JOHN ROGERS AND wife Martha of Ipswich, Mass., born 10 Feb., 1705; m. 16 January, 1723. Mr. Jno. Rogers sonne of John, President of H. C.: Mary, born 2 March, 1700 married Thomas Rogers 5 July, 1728: 8 Chn.: Samuel, b. 1 June, 1702, m. Mary Johnson, 26 Jan., 1730: James, b. 4 Oct., 1704: married Hannah Rogers 30 October 1730; Joseph and James (twins) born 4 October, 1704, Joseph, married Anna More 1742, 21 June., da. Samuel & wife Mary Moore, s. John, s. William of Piscataqua, s. Thomas gr. s. Sir Thomas More, (who was beheaded, s. Sir John, descendants of St. Mauirs: from 1742 the writing is illegible or so indistinct that I cannot be positive of it to brackets.) Sarah, born 13 April, 1709, m. Richard Rogers 27 January, 1735, d. 6 August 1761: 6 chn., Benjamin b. 1 April 1717 m. Susie L. Chadbourne 21 Nov., 1744 was born 25 Oct., 1724: descendant. da. James Chadbourne & Sarah, s. James & Elizabeth, s. Humphrey & Lucy, came over with Dr. R. F., 1631: William and Mary Perpoint, da. Evelyn Perpoint and wife Mary, da. William Fielding, Earl Denbigh of Old England, related; Lydia J., 9th child was born 26 March, 1719 and married James Johnson, son of Samuel, born 1678, s. Saml. b. 1658, s. John, b. 1639, s. Isaac and Arabella, s. Abraham. My beloved sonne CAPTYNE JOHN FERNALD, YE HERO of Louisberg, His Bible gyveth my Grand Children Born by the wyfe Elizabeth: Anne, b. 3rd Jan. 1725, d. 18 Mar. 1726: Magdalen, b. 9 Feb. 1727, d. 21 Jan., 1728: Maria, b. 5 Jan. 1729, d. 7 May, 1729: Annetta, b. 17 Sept., 1730, d. 17 July, 1731: Elizabeth Washington, b. 29 Nov. 1733, d. 3 Oct 1737: Joanna, b. 16 Oct., 1735, d. 23 Jan., 1736: Temperance Washington, b. 29 Aug., 1738, d. 17 Mar., 1738: Sarah, b. 31 Dec., 1740, d. 27 Jan., 1741: JOHN, born 23 Nov., 1742 at 4 o'clock A. M., and Tobias, (Twins) b. 23 Nov., 1742, at 6 o'clock A. M.: MERCY, b. 16 Feb., 1745 at Sun Rise m. Nathaniel Dennet, 1 May, 1767 (had 4 sons and 3 daughters) of Portsmouth; d. 18 Sept., 1791: Elizabeth Mary, b. 29 Oct., 1746, m. William Cotton of Portsmouth, s. of Wm. Cotton, Sr., Mary, b. 2 May 1751, m. John W. Fernald 25 Nov. 1772 (8 chn.) Capt. JOHN FURNAL 3d s. Deacon John 2d s. Dr. John 1st s. Thomas was in French & Indian wars living with two sons, under 16 years of age, and two das. at Kittery 1790; despite the alleged forgery in his father's will during the dark days in attempts to get the Spynie Barony, and Sherburne property, etc. (Dea. John Fernald misspelt Finley was in Kentucky with Daniel Boone.) Mrs. Elizabeth Fernald died at Kittery 21 September, 1752; 2nd wife, Deborah Sherburne, daughter of Jonathan, born 15 August, 1750, married 1 Aug. 1775, da Jonathan, s. Henry, b. 1709, Counsellor of N. H.: Speaker of House of Representatives, s. William of Portsmo, 1644, s. Henry, b. a. 1612; came over with Dr. Renald Fernald 1631, Representative of Portsmouth at Genl. Court, Mass 1660: Had Jonathan, b. 3 July 1776 & Deborah, b. 6 Mar. 1778 & d. from child birth He m. 3d Abigail Coffin, 30 Jan. 1779: da. Peter, s. Peter & Wyfe Abigail Starbuck s. James & wyfe Mary Severance, (14 chn.), s. Tristram; Had-William b. 3 Dec. 1780, m. Abigail Coffin 28 Apr. 1800 and Had-William Sherburne Fernald b. 29 Mar. 1802 m. Sarah A. Hanscom 6 May 1827, d. 20 Oct. 1848: (3 Chn.): Abigail, b. 17 Sept. 1783, Married 1803" Captain John Fernald (after the death of his last wife moved to Middleton, N. H., from Kittery & Portsmouth, Brookfield to Wolfborough and died very aged at Mr. Youngs, residing part of the time with Mr. Nute after m. of his chn. declared tradition, notwithstanding, I found part of his gravestone in Cemetery on Boston Common and Mr. Edward Fernald alleges he found from a printed Boston Guide Book Record buried in Cemetery of Boston Common. I found he fought a hard long battle in Boston Courts and won although he could not get a Boston Atty. to fight for him, but finished it with his Uncle Samuel as his Atty. which he won. Understanding from finding only two, out of 85 attys. in Boston, true, reported: for punishing the storage of firearms to use vs. state & government: d. 1 Feb. 1788. I found part of his gravestone in said cemetery and inquired at Police Headquarters if I had a right to take the same as part proof for my work and was informed not to disturb it. He was in battle a lion, in peace much beloved for most noble traits. The true friend of all honorable men and opponent of the ungodly workers of evil deeds.



AT NEXT PAGE IN A DIFFERENT COLORED INK I FIND THE FOLLOWING INTERESTING RECORDS OF "MR. JOHN FURNALD YE SONNE OF CAPTYNE JOHN AND ELIZABETH FURNEL, YE DAUGHTER OF REV. Mr. Jno and Marthar Rogers of Ipswich was borne one o'clock A. M. 23 November 1742 and married mary Savage born 17 June 1752 daughter Thomas. Jon. in American Revolution, sonne Thomas ob. 1694 sonne John, Earle of Rivers ob. 1654 sonne of Edward Constable sonne Sir John Savage Knyte married 16 November 1771. Mr. John Furnald, was in ye American Revolution and dyed of Fever 23 November 1792 in Portsmouth, N. H. Aet. 50 years, Mary dyed 7 March 1804.

AGES OF HIS CHILDREN

John Wentworth Furnald was horn quarter past ten A. M. Saturday 24 October 1772 and naymed by Governor John Wentworth hys name for hys Private Secretary and friend Jon Furnald.

William Furnald was born eight o'clock A. M. Friday 10 March 1775.

James Furnald was born two o'clock P. M. Thursday 24 June 1779.

Polly Furnald was born ten o'clock A. M. Tuesday 5 September 1782.

Abigail Coffin Furnald was born ten o'clock A. M. 2 April 1785-Thursday.

Mary and Betsey Furnald was born nine A. M. 1 August 1787-Wednesday.

Sarah Furnald was born nine o'clock Friday 11 June 1790.

Deborah Sherburne Furnald was born 27 of February at day break 1791."

"From my respected father was stolen ye ancient parmtree history sword, one of three and ye Doctor Renald Fernald Bible copy names ages there, by ye Roman Catholics. General George Washington gave his sword to Captyn Tobias Furnald."

"My brother John Wentworth Furnald obit 3 November 1793. Not married." The writer had a record of sd. sword as a gift of Washington to his "cousin Capt. Tobias Fernald."

Charter of Wolfborough granted 21 Aug. 1770 to Gov. John Wentworth and others. First Minister Rev. Ebenezer Allen m. Betsey Furnald, Nov. 7, 1796: John Wentworth Fernald, m. Polly Fernald 18 May 1795 Mr. Allen settled 1792, d. 1806, first pioneers Capt. John Smith, hunter, Mr. Cooke & settlers, Mr. James Thompson, Cooke, two others besides B. Blake J. Lucas, James Lary, J. Fullerton, and others. Middleton Charter 1771 to Sir William Mayne & others. First Minister Rev. Nehemiah Ordway, 1778. Brookfield from Middleton formerly a part of it was incorporated by Act Legislature 30 Dec. 1794 therefore as perceived Mr. John Furnald and wife were residents of Middleton after his removal from Portsmouth to Wolfboro. with Gov. John Wentworth, to Middleton where his 1790 Census was taken and ret. and died 1792 at Portsmouth, bur. in N. Cemetery. Continuance of the Holy Bible Records of the Long Line of Furnalds in 126 modes of spelling their names during a few generations when there were a variety of Grammars.

"William Firnald, son of Mr. John Furnald (Fornel) 4th. and wife Mrs. Mary Savage Furnald daughter of Mr. John Savage, and wife Mary, son of Thomas Savage, was born at Middleton, now Brookfield N. H., 16 March 1775 Married Betsey Johnson, da. Phineas and wife Hannah Poor, son of Col. Samuel Johnson (and both) In American Revolution, born at Andover, Mass. 22 June 1778 Married 1 February 1797: Had: 12 descendants.

At 1 A. M. JONATHAN POOR FIRNALD born at Brookfield 1 December 1797.

" 3 " " Mary Firnald was born 11 April 1800: m. Samuel Holmes. No chn.

" 2 " " Samuel Firnald " " 22 August 1802 m. Hannah Horne, son George m. Eunice Knight, chn. (3 chn) Joan, m. Capt. Ichabord Frisbee & sister married GEORGE WASHINGTON WILLIAMS in Civil War.



B

AT 4:00 A. M. ELIZABETH FIRNALD WAS BORN 19 SEPTEMBER, 1804. RECORD LOST.

AT 6:00 A. M. HANNAH FIRNALD WAS BORN 27 JANUARY, 1807. RECORD LOST.

AT 5:00 A. M. DEBORAH FIRNALD WAS BORN 20 JUNE, 1809; MARRIED Phillip Towle; chn. d. y.; m. 2nd, Jonathan Roberts; da. Anne, m. Henry Roberts, chn. and d. 30 July, 1894, at Farmington, N. H.

At 7:00 A. M., William Fernald, born 20 May, 1811; m. Sophronia Chase, had George W., born 28 Nov. 1831; m.; chn.

At 8:00 A. M., Parmelia Fernald was born 3 July, 1813; m. Mr. Denny, in Civil War; had chn.

At 10:00 A. M., Meriah Fernald was born 26 Feb. 1816; m.

At 9:00 A. M., Henry Hinckes Fernald, born 20 Jan. 1818; m.; d. at Sea, Oct. 1864. (?)

At 11:00 A. M. John Fernald was born 2 April, 1820; m.

At Noon, Margaret A. Fernald was born 19 June, 1823; m. Thomas Jenkins, of Portsmouth, N. H., and died at East Boston, Massachusetts (Webster Street) Godlike in nobly and unselfishly caring for others, proud, sensitive, wise, prudent, firm, unchangeably patriotic, an enemy to all foes that threaten State and United States, and its honorable families, bitterly opposed to the church who srew wickedly by assassinations her foreparents for their money, they fearless of a righteous retribution deserved for their deeds and teachings of "do evil that good may come to Vatican and Pope, thus aiding, causing national destruction." She was just and liberal. A noble, true, intellectual woman.

The Holy Bible Records of Jona. P. Fernald, Born Decr. 1st, 1797, Married To Mary Cotton Pike, Sept. 13, 1821, da. Robert Pike and wife, Mary Cotton, da. Col. William Cotton and wife, Mary Clark: son of General Zebulon Pike (bro. Jacob) son of Capt. John Peake, s. John Pike, s. John Pike, s. Rev. John Pike of Dover, s. Major Robert Pike, Commander-in-Chief, s. Atty. John, m. Sarah Washington (not Saunders). Mrs. Mary Cotton Pike Fernald, Born December 12th, 1800, Middleton, N. H. Had—Maria Renald Fernald, born at Brookfield or Wolfboro, December 16th, 1822, moved to Wolfboro. Mary Elizabeth Fernald, Born December 12, 1824. Hannah Fernald, Born 3 December, 1826; d. y. Hannah Fernald, Born November 29th, 1829. Nancy Horne Fernald, Born May 3rd, 1832. Joan More Fernald, Born August 30th, 1837. Brackett Fernald, Born 24 December, 1834; d. 24 October, 1838. James William Fernald, Born 24 July, 1839. Sophronia Chase Fernald, Born October 11th, 1841. Jonathan Brackett Fernald, Born March 11th, 1844. Charles Augustus Fernald, Born December 5th, 1847. William Fernald, my Father, Born March 10th, 1775. Betsy Fernald, my Mother, Born June 22nd, 1778. J. Brackett Fernald, Died June 23rd, 1867. Nancy H. Dorr, Dau. J. P. Fernald, Died January 19th, 1868. MARY C. FIRNALD, Died February 14th, 1887, Age, 86 years, 2 m., 2 days. Hannah Haines, Died July 31st, 1890." Here ceases the Holy Bible Records of my honored and much beloved Christian Father that no pens or tongues of men can fully describe his to be emulated and rewarded deeds, JONATHAN POOR FIRNALD, Died 23 of April, 1893, at Farmington, and buried by the side of loved Mother at Wolfboro. Centre, New Hampshire, in 96 year of age. Sad, we view loved ones gone before to our Heavenly PARENT GOD. See illustrations of this family, papal persecuted.

THE FERNALD WOLFBOROUGH MARRIAGES AT GRANITE STATE, N. H. U. S. A.,

18 May, 1795, John Wentworth Fernald and Polly Fernald, both of Wolfborough, N. H., U.S.A.

7 Nov., 1796, Betsy Fernald and Rev. Ebenezer Allen, both of Wolfboro.

28 Jan., 1800, Nathaniel Fernald of Brookfield and Polley Coleman of Wolfboro.

22 Nov., 1800, Lois Fernald and Isaac Martin, both of Wolfboro.

29 Aug., 1801, James Fernald of Brookfield and Betsy Brackett of Wolfboro.

— Aug., 1803, Diadema Fernald and Joseph Frost, both of Wolfboro.

25 April, 1809, Sarah Fernald, b. 1790; m. Mr. Samuel Cottin of Wolfboro, wife of Brookfield,

Cotton Records.

18 March, 1811, Susan Fernald of Wolfboro and Jacob Stanton of Brookfield.

20 March, 1820, Sarah Fernald and Samuel Tibbets, both of Wolfboro.

21 May, 1821, Jonathan P. Fernald of Wolfboro and Mary C. Pike of Middleton.

14 Nov., 1821, James Fernald of Wolfboro and Mary Hodges of Brookfield.

1 June, 1822, Elizabeth Fernald of Wolfboro and John Locke of Wakefield.



F 13 SEPTEMBER, 1821, JONATHAN POOR FERNALD, OF WOLFBO-
ROUGH, NEW HAMPSHIRE, AND MARY COTTON PIKE, OF MIDDLETON,
24 July, 1824, Samuel Fernald and Hannah Horne, both of Wolfborough, Brothers, see
above Record.

7 June, 1829, Sophia W. Fernald, of Durham, and Daniel Martin, of Wolfborough.

23 May, 1830, William Fernald, Jr. and Sophronia Chase, both of Wolfborough. He was brother of above Jonathan P. and Willam Fernald.

13 October, 1836, Mark Fernald, of Wolfborough, and Mary C. Furbish, of South Berwick.

4 June, 1838, Rosella Fernald and Leonard Shortridge, both of Wolfborough.

1 July, 1844, Mary Elizabeth Fernald and Joseph Lord Dixon, both of Wolfborough.

26 August, 1844, Maria Renald Fernald and Orin Dixon, brother of above, both of Wolfborough.

27 November, 1851, Hannah Fernald and Joshua B. Haines, both of Wolfborough.

9 March, 1852 Nancy H. Fernald, of Wolfborough, and William T. Dorr, of Ossipee, 4 sisters, daughters or Mr. J. P. Fernald and Mary Cotton Fernald.

The above few Records, from THE HISTORY OF WOLFBOROUGH by BENJAMIN FRANKLIN PARKER is an excellent book that ought to be in the hands of Tourist, Historians and Genealogists, who will profit by a vivid description. This Town has become deservingly celebrated as a summer resort and for its healthy invigorating climate. Situated on Lake Winnipiseogee, S. E. and S. W. border, while the lofty mountains of Ossipee, and the rugged granite hills of Tuftonborough tower up in the rear like impregnable walls of some gigantic fortress, its Lake Wentworth, a mirror whose clear crystal surface reflects a scenery presented to the view at once picturesque and sublime. The summer evening trips on the lakes are truly delightful. At sunset, when the evening shadows begin to fall upon the distant mountain tops, presenting their rugged outlines in bold relief, and the moon and stars, gliding into the firmament, kindle their brilliant fires up in the depths of the clear blue waters, the excursions seem like a delightful journey to the Elysian Fields. In autumn the variegated leaves on the forest trees in all their marvelous beauty, which like moral old age, is most instructive and beautiful upon its departure in aid of the glorious spring, whose heralds are the musical songs of birds, given to gladden, as the flowers soothe, in whose glory Solomon was not clad equal unto these the least, surpassed only by the little ones made most perfect in the glorious likeness of perfect-only God.

Mrs. Nancy H. (Fernald) Dorr (Door, Dore) Family Genealogy At East Wolfborough, obtained W. T. Dorr Records. Jonathan Door, or Dorr, as now spelled, of Rochester, N. H., m.— and had three sons before 1790 Census, probably moved to Alton, incorporated 15 January, 1796, formerly called Durham Gore. Had—Isaac Dore: Charles; James; John; Ezekiel; Mason, b. 12 Sept. 1798; d. 12 April, 1840; m. Sarah M. Marston, 16 Mar. 1824. A da. m. Moses (?) Twombly, Alton, N. H. Da. m. Col. Taylor. Da. m. Mr. Merrow. Edward Dorr, of Roxbury, had a son Edward that d. 1683. Ten of them educated at Harvard College and four at N. E. College, and these two were claimed as ancestors of the family.

Mason Dore, b. 1798; m. Sarah M. Marston, da. Simeon Marston and Wife, b. 1799; d. 14 Jul. 1864. His widow m. 2nd, Joseph Baker, Jr., b. 1802; d. 17 Apr. 1858. Their descendants were:— Sarah A. Dorr, b. at Wakefield, N. H. 1825; m. Capt. John C. Rogers (of Militia) of Concord; Abigail, b. 9 July, 1828; d. 9 Apr. 1843; Mary Jane, b. 1 Dec. 1836; d. 6 Dec. 1838; William Towle Dorr, b. 2 Oct. 1830; m. Nancy Horne Fernald, da. Jonathan P. and Mary C. Fernald; In Heavy Artillery, C. W.; Simeon L. b. 1832; m.—; in Civil War; d.—; Lewis Mason Dorr, b. 1835; d. s. p. 1907; William T. Dorr, b. 1830; m. Miss Nancy H. Fernald, 12 Mar. 1852, who d. 19 Jan. 1868; Their descendants—Mary Ella Dorr, b. at Ossipee, N. H., 12 Oct. 1854; m. Ellis Lindskog; Inez Estella, b. 22 Dec. 1856; m. James E., s. Mark and Betsey Avery (nee Nute) Mr. W. T. Dorr, m. 2nd, Mrs. Jennie Gilman, da. of Alonzo Ramsdell and wife, Mary Elizabeth Tripp, da. Samuel and wife, Sarah Tripp, nee Hubbard, da. of Sea Capt. John Hubbard and wife, Mrs. (Wise) Hubbard, Kennebunkport, Me.; Chn.: Lula Dorr, b. 12 Apr. 1876; d. 31 Dec. 1907, s. p. bur. Wolfboro Centre: Willie Mason Dorr, b. 4 July, 1877; d. 21 July, 1878.



THE HISTORIC SWORD OF CAPT. JONATHAN GILMAN WAS GIVEN TO ME BY HIS WIDOW AND WIFE OF W. T. DORR THAT WAS USED IN THE COLONIAL WARS, AMERICAN REVOLUTION, 1812, AND C. W. THAT HAD

one of Capt. J. Gilman's brothers, a Capt. in Union Services and another a Col. in the Southern Services. Brother pitted against brother from in the by body politic corrupt, that, as in ancient Rome deluged God's earth with torrents of blood, terminating there in its destruction, pure by slaking off the shackles of slavery, ever a blot, on the escutcheons of national services all preventable had the Africans been bought up and freed. Now with greater devastations may cause downfall of us, threaten from delay of enactment against the cause of downfall of states and nations, which delay, but aids the well known destroyers to be defeated—it is predicted—by G. U. S. and F. A.

Mr. Ellis Lindskog, son Charles John Lindskog, A. M. Ph D. and wife Anna Margaret Haigle that d. 1884, aet 62; d. 1906, Aet. 77 Married Mary Ella Dorr, da. Wm. T. and Nancy H. (Fernald) Dorr Jan. 1886: Had Inez Anne Lindskog, b. 4 Oct. 1886: Louise Lindskog, b. 12 Sept. 1891: Carl Dorr Lindskog, b. 18, Mar. 1894: Rachel Lindskog, b. 8 Oct. 1892, d. 12 Oct. 1892:

Mr. James E. Avery m. Inez Estella Dorr, da. William Towle Dorr & Mrs. Nancy H. Dorr: Had descendants—Charles Edward Avery, b. Lena Estella Avery, b. 2 March 1884; m. Harry David Wentworth b. 9 Sept. 1876, m. 1 Apr. 1905, son of Orin H. Wentworth and wife Mary A. Leonard; had 2 chn. Everett O. Wentworth b. 13 Sept. 1906; Richard Fernald Wentworth b. 24 Sept. 1908.

Mr. Benjamin Franklin Parker's History of Wolfborough, N. H. and Mr. John Farmer's Gen. Register are replete in valuable information concerning its families who have made the greater U. S. also Collins Peerage give the name of John Hain, Esq. m. Jane Sandys, da. Col. Henry Sandys, s. Sir Edwin Sandys and wife Elizabeth Sandys, s. Anthony, s. William, whose epitaph "Here lie intom'd a happy Pare William Sandes and Margaret fair, His vertuous Wife, a Jewell rare" etc. Vol. 6. p. 567. And Vol. 11, p. 416 the da. Anne and coheir of John Haynes, of Shropshire Esq: m. Thomas Edwards, s. Sir Thomas Edwards, Knt. & Baronet, the first by King Charles I, m. Cecily Brooks. Farmer gives the name as Haynes and the New Hampshire as Haines and the three had a common ancestral progenitors. Governor John Haynes, Cambridge, came to N. E. 1633 from Copford Hall in Essex. Gov. 1835. Removed to Conn., Gov. 1639 and every 2d yr. till death 1654. By 2 wives he had 8 chn. Robert, Hezekiah, John, Roger, Mary, Joseph, Ruth and Mabel, 3 last by 2d wife.

Samuel, Portsmouth, a deacon and founder of 1671 church, m. Mary Fifield 9 Jan. 1673: Had Mathias, b. 7 Mar. 1677; William, b. 7 Jan. 1679, Samuel, b. July and 3 das. His numerous N. H. descendants write the name Haines. Wolfborough was chosen by Joshua Haines in 1784 that came from Greenland with his three sons—Jacob, Matthias and Joseph; they d. aet. 90, 89, 86, and wife Ruth, 85 & sister Jane, 94 yrs. U. S. C. 1790 gives residence of Joshua Haynes as Washington Town, Cheshire Co. 1 son & 1 da. under 16 yrs. of age. "Jos. Haynes, Brimfield Town, Mass., 9 sons over 16 and 4 das. and these all I find of Joshua, who was probably 1st named. The next generations as they appear recorded are Joseph, chn. Polly, Eleanor, Hannah, Sally, Joseph 2nd m. had, George, John L., Joshua B., and Joseph Rodney Haines who was elected four times Representative of N. H., Joshua B. Haines, m. Hannah, da. Jonathan P. and wife Mary C. Fernald and left one son Edwin Herbert Haines a Wolfboro. Merchant. Mr. John Haines, m. had 12 Chn. Lucy M., William, Joshua, John, Mary B., Mathias M., Hannah, Charles F., Martha J., Sarah A., Arvilla B. and Daniel J.,

Communication from Mr. William Bellamy. "Eliza Bellamy was da. of Charles Bellamy, eldest son of Charles Bellamy who came from Boston to Exeter, N. H. He fought in the war of the Revolution and died about 1811. I think his father's name was also Charles and I have been told that his father was a brother of Joseph Bellamy the divine, I do not know any one acquainted with my family history, and indeed take little interest in it" etc. Eliza A. Bellamy, above, m. John Acres and eldest da. m. the writer of this work to honor States, U. S. and Nations and for honorable peace that is only to be obtained by equal and impartial justice with good laws.



BOSTON RECORDS PRINTED DURING THE CONTINUED ANNUAL INCREASE OF INDEBTEDNESS OF CITY TILL WITH A CLAIM, NOT YET SETTLED; IT AMOUNTS TO OVER ONE HUNDRED AND TWENTY-four millions of dollars. Corrupt politicians educated at the Jesuit College on Harrison Avenue, Boston. "It was observed of the Jesuits, that they constantly inculcated a thorough contempt of worldly things in their doctrines, but eagerly grasped at them in their lives. They were wise in their generation, for they cried down worldly things, because they wanted to obtain them, and cried up spiritual things, because they wanted to sell them. Lacon."

"Vol. 1. List of Inhabitants, Index, and p. 154 "Benjamin Funnell, John Funnell, Andrew Funnell; John Fonnell" p. 162, 1691. List No. 1. 1674 "Samll Burnell 2nd Part—Sanuuell Burnall, pp. 22, 28, 84 146 mentions his "negro boy, from 1674 to 1695. Vol. 2., p. 68: William Burnell Admitted Townsman 26 Aug., 1640. Vol. 3. p. 77 Charlestown, John Funnell 1 Mar., 1657-8 Lott 19 of wood 0033 Mistick syde, common 0051-2 and Acres. Deed by Edward Johnson to John fownell 1660. Vol. 4. 1676, p. 212" probably forgery. "Jno Fennow" (Furneaux=Furnal)—"libitie to git three or fower load Clobord out of the Cedar Swamps" Vol. 5. Faneuil, pp. 68, 69 & 70 interesting to Hon. Atty., one deed recorded 47 yrs. after it was said to be given. Andrew Faneuil, d. 1737, bought Stone House for £800, in 1710, devising to Peter Faneuil—death 1742" (he d. 3 Mar. 1743), "the inventory appraised his Mansion House £12,375." In 1772 it became the property of John Vassall, who being an unfortunate "conspirator," the commonwealth pocketed £2,400 by selling to Isaiah Doane, 1783 (l. 160, f. 125). Wm. Phillips bought it 1701." etc. Vol. 7. John Foreland, 1700, Clerk of ye Market." Vol. 8, p. 29. Andrew Faneul:—build and maintaine a Wharf. the width of the Street between mr. Faneuils and mr. Aphorps—Select men—Leaving the end of Sd. Wharfe free for the Town, when they shall see reason to plant Guns for the defence of Said Town." Samll Furnell, p. 1, 45, 69, 74, 89, 170 & 196." "Vol. 9, 1679, Births & Baptisms Samuel of Samuel & Anne Burnell, b. Oct. 10: John of John and Esther Barnell Aug. 13: pp. 16, 17, 19, 21, 140, 147, 168, 178: Furnel, Furnell, Furnill 15, 16, 21, 22, 24, 25, 28, 31, 35, 36, 38, 39, 41, 45, 46, 56, 71, 141 & 251;"

"Strange" "Strong and Ellenor Furnell, (City Document No. 130) Births and Baptisms" Children: "Elizabeth, b. 7 Mar. 1643; bapt. 14 Mar.: Marie of Strong and Elliner Ffurnell, b. May, 1645, bapt. Mary of Strong Furnell, aged about 8 days, 10 June, 1645: Joanna, b. 26 Dec. 1646; bapt. 28 Dec.: John, bapt. at a. 5 ds. 20 Jun. 1648: 17 Samuel, bapt. 14 Feb. 1650: Mary, bapt. 1 April, 1651: Sarah of Strang's wife, bapt. 26 Aug. 1651: (Belknap wrote Strange) Susanna, b. 14 Sept. 1652: Susan, d. 21 July, 1652: "(says Records) John, b. 28 Jan. 1653; bapt. 29 Nov.:" Susannah, of Strong Furnill, bapt. First Church, 19 July, 1652: John, of Strong and Elline Furnell, b. 28 Jan. 1653; bapt. 29 Nov.: William and Elline Furnell, another Eleanor whose many ways spelt name is found, and Michæl Lambert, p. 71 is found m. widow Elinor Furnell" no month, date "1659." "William Furnell" m. "Helen" and had: Joanna, b. 9 Dec. 1652: William, b. 29 July, 1654: Joseph, b. 19 Jan. 1656." In "1677, Olive, of John and Olive Furnell, b. 24 March, and m. John Smallpiece" Boston: "by Mr. Miles, Apr. 7" no yr. given. Vol. 10, 1645 Fanneuil, p. 88: p. 110 John funill gon to sea." "Vol. 11. p. 105 and 117, Faneuil." Vol. 12. p. 259, "Peter Faneuil Offer of Market to Town." His signature could not be found. "Donates p. 183, £100 to build Work House," p. 260. "Thanks of Town." p. 306. Offer to appoint a Clerk of Market. "Mr. Thomas Jackson, Merchant of Boston: By Governr. and Council Feb. 1st, 1691. List of persons of the french nation admitted into the Colony: Benjamin, John and Andrew funell; peter de Vaux, wife, da. and Eng. maid; francis Legare—two sons; James Montier, wife, and Eng. maid; Isaac Biscoon and wife; Dr. Bassett; Gabriel Bernon; William Barbut; Louis Allare; Moses Secq; Peter Urigne to give Security next meeting. City Document 150 Vol. X. p. 62. Vol. 13 John Fantel, p. 232, care of engine. p. 128, Liberty Granted to mr. Andrew faneuil to Erect a Toomb in the South Burying Place near to the Toomb of Simion Stoddard, Esq." That has been continually desecrated.



F

STEPHEN FERNALD, A FARMER, B. 1784; S. JOEL AND ELIZABETH, S. TOBIAS AND LUCY (ATKINSON), S. NATHANIEL AND MARGARET, S. CAPT. WILLIAM AND ELIZABETH, S. DR. RENALD AND JOANNA WARBURTON; m. 27 Nov. 1806, Alice Carter, who d. 26 June, 1868; he d. 11 Feb., 1857; had Clarissa, b. 13 April, 1807; m. Gideon Bray of Rockport, Mass.; d. 1861; Stephen, b. 14 Sept., 1808; m. Susan Tibbets of Gt. Falls, N. H., 1837; d. 23 Jan., 1891, at Peabody,

GENERATION 159. Mass., leather merchant; 1 son; Sarah, b. 15 Oct., 1813; m. Parker Maynard, 2d Alpheus Church of Winchester, Mass.; John, b. 4 March, 1815; m. 7 Sept., 1852, Eliza T. Tomlinson of Alfreton, Eng.; d. 10 Nov., 1859; safe and lock dealer; 3 chn.: Mary Ann, b. twin of sd. John; m. Mr. Smith of Boston, 2d George Barnes of Concord, N. H., 3d Mr. Wardwell of Malden, Mass.; Cyrus, b. 14 Feb., 1817; m. Sally Ann Quimby of York, pub. 1 Feb., 1838; 2nd, Olive F. Manson, 3 July, 1843; Asnath, b. 22 Jan., 1819; m. Mr. Nutter of Boston; 2nd, Charles Cook of Boston; d. June, 1881; Luther, b. 9 July, 1820; m. Lucy M. (Norris) Kenny, 25 Nov., 1847; Tanner at Peabody, Mass.

GENERATION 159. PELATIAH FERNALD, b. 1771; m. Sarah, da. John and Mary (Fernald) Fernald, and d. 12 Dec., 1849; carpenter; Joanna, b. 10 Dec., 1798; d. 10 Nov., 1800; John, b. 2 April, 1802; m. Mrs. Mary (Caswell) Fernald; 2nd, prob. 1st; m. Miss Clarissa Caswell, and d. 23 April, 1887. Had—George; George William was a son of William of Portsmouth, N. H., s. Wm., s. Wm., s. John, s. John; Peletiah, b. 19 Aug., 1804; m. Mary Caswell, 10 Mar.; d. 20 Sept., 1842; Mark, b. 19 Sept., 1806; d. 1 Oct., 1806; Samuel, b. 19 Sept., 1806 (twins); m. Caroline Hope, 2 Dec., 1829; 2nd, Ann Jane Seavey, 7 Feb., 1832; d. 9 July, 1889, at Clifftendale, Mass.

GENERATION 160. WILLIAM WENTWORTH FERNALD, m. 10 Oct., 1789, Waite Salisbury, Mass.; b. 1760; d. 8 Sept., 1851, and wife d. 2 Sept., 1855; Farmer, prominent in Civil matters. Had descendants—Wentworth, b. 12 Nov., 1790; m. Miriam Staples, 30 Nov., 1820; d. 19 Jan., 1878, at Eliot. Nancy, b. Oct., 1794; m. Col. Gowen Wilson, 27 Nov., 1816, and d. 6 May, 1887; Waite, b. 25 June, 1707; m. Oliver Staples, 16 April, 1818; d. 24 Dec., 1876; 4 chn.: Alzira, b. 11 July, 1799; m. James Johnson, 15 Nov., 1821; 2 chn.: William Salisbury, b. 1802; m. Sarah Ann Hanscom, 6 May, 1827; d. Oct., 1848; Hannah Salisbury, b. 10 Feb., 1805; d. 1 Feb., 1806; Julia, b. 9 Feb., 1808; m. Rev. Paschal P. Morrell, 27 April, 1831, and d. 17 March, 1901, at Hyde Park, Mass.; 2 chn.: Sarah Ann, b. 11 June, 1810; m. Rev. James Cushing, 16 Aug., 1832; d. 2 June, 1845; 2 chn.

GENERATION 160. SAMUEL FERNALD, b. 1762; m. 11 April, 1825, Betsey Fernald, da. Dennis and wife, Elizabeth (Stacey) Fernald, and d. 3 March, 1857. Had—Sarah A. E., b. 12 June, 1826; m. 5 Oct., 1845, Warrington Paul of Eliot; 12 chn.: Maria, b. 1 Sept., 1827; m. 12 March, 1848, Samuel Paul; d. 31 Oct., 1848.

GENERATION 159. MARK FERNALD, s. Capt. Mark and ; b. 1745; m. 6 March, 1807, Margery P., da. Robert and Margery Pepperrill (Wentworth) Cutts; b. 14 Feb., 1784, and died 1864. He was a Blacksmith, and d. 20 Jan., 1852. Had—William Cutts, b. 7 Sept., 1907; m. Jane Tibbets of Sanford, 1 Oct., 1835, and d. 4 Oct., 1878; Grocer at Rochester, N. H.; 6 chn.: James Madison, b. 23 April, 1809; d. 8 June, 1810; Hiram, b. 16 May, 1811; m. Amelia Maria Childs, 18 Oct., 1836; d. 23 Dec., 1870; Grafton, Mass.; 4 chn: Samuel, b. 25 April, 1813; m. Levina Wherrin, 26 May, 1835; d. 14 Oct., 1886; Elizabeth Ann, b. 19 April, 1815; m. Elisha Hammond, 7 Oct., 1838; 2nd, John B. Hanscom, 1853; Robert Cutts, b. 4 June, 1817; m. Caroline Newell, 13 Oct., 1839; 2nd, m. Eunice Lord, 5 June, 1847; 3rd, Ann Pray; d. 20 Aug., 1894; Merchant at Salmon Falls, N. B.; 6 chn.: Mark, b. 10 Aug., 1820; m. Julia A. Hanson, 13 June, 1842; d. 1868-9; Police Sergeant; 4 chn.: John Dennet, b. 7 Oct., 1822; m. Mary A. Paul, 7 Oct., 1846; d. 11 Jan., 1892; Farmer of Eliot, Me.; 5 chn.: Mary, b. 18 Jan., 1825; m. Moses Hammond, 1854; Margery C., b. 23 July, 1827; m. William A. Fernald, 20 Oct., 1850; d. 26 Feb., 1892.



F

Fernald Marriage Records

Boston, U. S. A.

DATA ETC. 1886 A. D.	NAMES	BIRTHPLACE.	PARENTS.	CHILDREN
59	Thomas F. Fernald,	Portland, Me.,	Edwin and Martha M.,	
Jan. 5	Julia H. Porter,	Hartford, Conn.,	Henry C. and Sarah C.,	
3980	George H. Fernald,	Boston, Mass.,	John C. and Sarah A.,	
Dec. 15	Mahel Laughton,	" "	James C. and Eliza J.,	
1887				
3072	Frank C. Fernald,	Portsmouth, N.H.,	Frank L. and Mary E.,	
Sept. 21	Lois H. Curtis,	Boston, Mass.,	Thomas and Deborah M.,	
3177	James H. McAdams,	" "	James and Sarah F.,	
Oct. 10	Ella F. Fernald,	" "	Mark and Julia A.,	
1888				
1267	Claudius B. Lasell, Jr.	Schoharie, N. Y.	Claudius B. and Elizabeth W. K.,	
May 8	Lizzie S. Fernald,	Boston, Mass.,	Thomas F. and Sarah L.,	
3078	Albert O. Waitt,	Malden, "	Joseph H. and Elizabeth W.,	
Sept. 20	Lizzie B. Fernald,	Essex, "	Isaac and Lizzie,	
3786	George O. Lanphear,	Windham, Vt.,	Henry and Experience,	
Nov. 11	Eliza L. Fernald,	Parsonsfield, Me.,	James and Dorothy M.,	
1889				
219	James O. Fernald,	Tuftonboro, N. H.	Joel and Mahala,	
Jan. 31	Carrie C. Bartlett,	Boston, Mass.,	John and Caroline,	
1890				
123	Charles P. Fernald,	Boston, Mass.,	Joseph and Louise S.,	
Jan. 16	Florence T. Brigham,	" "	Edward and Josephine,	
4897	Frederick A. Edwards,	W. Gardiner, Me.,	Alhion K. P. and Sarah D.,	
Dec. 13	Annie L. Fernald,	Cambridge, Mass.,	William-H. and Charlotte,	
1891				
2619	William E. Fernald,	Boston, Mass.,	Daniel F. and Mary F.,	
July 28	Augusta M. Heven,	" "	John F. and Mary J.,	
2962	Burton Fernald,	Halifax, N. S.,	Charles W. and Clara A.,	
Aug. 27	M. Lizzie Smith,	Rumford, Me.,	John and Lydia,	
4567	Edmond E. Fernald,	Farmington, N.H.,	Lewis C. and Caroline V.,	
Nov. 18	Jeannette G. Foster,	Trenton, Me.,	John P. and Tryphosia W.,	
1892				
1084	Archbow A. L. Hoyle,	Webster, Mass.,	Andrew and Hannah,	
Apr. 6	Helen B. B. Fernald,	Milford, "	Henry W. and E. L.,	
2955	Walter F. Fernald,	Boston, "	Joseph L. and Louisa D.,	
Aug. 13	Alice V. Jones,	Needham, "	George E. and Hannah M.,	
3262	Harry Fernald,	Cambridge, "	Joshua W. and Mary E.,	
Aug. 17	Helen Thomas,	Vermont,	Franklin M. and Lydia,	
1893				
5677	Charles H. Bense,	Boston, Mass.,	George F. and Mary A.,	
Dec. 31	Mary I. Fernald,	" "	John and Jane,	
43*				
Jan. 21	Albert C. Fernald,	Cone Valley, Cal.,	Albert A. and Martha,	
	Fidella F. Trefrey,	Novia Scotia,	John and Emma,	

"Those marked * one, or both, out of City."





643*	Charles W. Fernald,	Portsmouth, N. H.,	Charles and Lucy C.
Oct. 22	Etta Kelley,	Boston, Mass.,	Charles P. and Lydia A.
646	John J. McGurin,	Boston, Mass.,	William P. and Harriet F.
Oct. 19	Caroline E. Fernald,	Boston, Mass.,	Robert A. and Margaret
1894			
692	William Day,	England,	Richard and Alice
Jan. 31	Annie M. Fernald,	Boston, Mass.,	George C. and Irene M.
934	Charles F. Fernald,	Scituate, Mass.,	Bryant W. and Henrietta C.
Mar. 28	Eva J. D. Abbot,	Boston, Mass.,	John K. and Isabella
1435	Harry Richardson,	Galveston, Texas,	Harrison R. and Martha
Apr. 28	Gertrude E. Fernald,	Vineyard, Wis.,	Charles and Maria
2198	Arthur Fernald,	Canaan, Me.,	Josiah and Julia
Jun. 23	Dora Ames,	Canaan, Me.,	Horace and Tryphena
3483	George A. C. Berry,	Boston, Mass.,	David A. and Tryphena C.
Sept. 19	Carrie S. Fernald,	Scituate, Mass.,	John and Henrietta C.
1895			
42	Charles E. Watson,	Boston, Mass.,	George B. and Annie J.
Jan. 2	Lilla E. Fernald,	Boston, Mass.,	Charles W. and Eliza L. F.
901	Harry Fernald,	Cambridge, Mass.,	Joshua W. and Mary E.
Mar. 6	Jannett A. Birch,	Beverly, Mass.,	Charles W. and Mary J.
2837	George N. Crowell,	Nansemond Co. Va.,	Horatio and Sarah
July 14	Annie I. Fernald,	Kittery, Me.,	Jesse and Irene
3806	Alfred R. Phillips,	Hamlington, Ohio,	Alfred A. and Emma C.
Sept. 19	Gertie E. Fernald,	Whitewater, Wis.,	Charles H. and Martha
4784	Oscar Fisher,	Nova Scotia,	Mathew and Eliza
Nov. 2	Dora M. Fernald,	Burlington, Me.,	William and Mary
1896			
2288	Joshua W. Fernald,	Portsmouth, N. H.,	Thomas and Margaret H.
May 27	Mary E. Rice,	Charlestown, Mass.,	Melvin and Mary I.
3893	Charles A. Fernald,	Boston, Mass.,	George C. and Irene M.
Sept. 2	Gertrude M. Davis,	Boston, Mass.,	Horace F. and Frances
1897			
2833	Warren H. Blaisdell,	Westford, Mass.,	Israel and Louisa
Jan. 4	Annie L. Fernald,	Greene, Me.,	Thomas and Jenette
4454	John H. Jackson,	New York, N. Y.,	William W. and Mary A.
Oct. 11	Annie L. Fernald,	Boston, Mass.,	Levi P. and Ellen A.
1899			
899	Dennis J. Swanson,	England,	Alfred and Mary A.
Feb. 26	Ella M. Fernald,	Somerville, Mass.,	Henry C. and Mary J.
1840	Joseph Thompson,	St. Johns, N. F.,	Thomas and Ellen
May 11	Annie Fernald,	Boston, Mass.,	Alonzo and Catherine
3188	Luther T. Fernald,	Somerville, Mass.,	Luther E. and Mary E.
July 9	Elizabeth A. Jack,	New Brunswick,	John M. and Hannah
600*	Fred A. Fernald,	Kittery, Me.,	Alonzo and Martha F.
Aug. 23	Florence M. Baker,	Lebanon, N. H.,	Joel and Josephine J.





1900

743	(Dr.) Adelbert Fernald,	Jackson, N. H.,	John W. and Lucinda
17 Oct.	Evelyn W. Nunn,	Hackettstown, N. J.	Miller R. and Hulda

1901

827	William T. Fish,	Pittsfield, Me.,	William T. and Mary B.
13 Feb.	Tallulah F. Fernald,	Fitchburg, Mass.,	William G. and Tallulah F.
1760	Benjamin F. Chapman,	Boston, Mass.,	Benjamin H. and Ellen A.
29 Apr.	Majorie E. Fernald,	Dorset, Vt.,	Luke B. and Clarissa A.

1902

3512	Fred H. Pearson,	Windham, N. H.,	Hiram C. and Elizabeth B.
5 Aug.	Sadie B. Fernald,	Boston, Mass.,	Levi P. and Elena
3860	John Coughlin,	" "	Patrick and Margaret
12 Aug.	Caroline C. Fernald,	" "	Henry and Mary J.
4372	Christopher T. Lenord,	" "	Mathew and Mary
30 Sept.	Sarah H. Fernald,	" "	Robert A. and Margaret

1904

25 May	Lee E. Fernald,	Eliot, Me.,	George W. and Elizabeth
3333	Mildred B. Pettingill,	Amesbury, Mass.,	Granville W. and Fronia
7 July	Edwin I. Warshauer,	Milwaukee, Wis.,	Simon and Anna
5552	Carrie E. Fernald,	Boston, Mass.,	Daniel F. and Mary F.
2 Nov.	Joseph W. Noble,	Woodstock, N. B.,	Theodore H. and Matha L.
6293	Gertrude E. Fernald,	Peterboro, Can.,	William N. and Emily
30 Nov.	Semuel H. Dodge,	Windsor, N. H.,	John G. and Nellie M.
798	Margaret J. Fernald,	Boston, Mass.,	John M. and Mary J.
26 Sept.	Denis E. Kelley,	" "	John and Catherine
	Evie M. Fernald,	Northport, Me.,	Austin and Kate

1905

630	Ralph E. Fernald,	Kittery, Me.,	Warren and Margaret
16 Feb.	Julia Murphy,	Ireland,	Edward and Margaret

1906

3061	Frank L. Fernald,	England,	John A. and Mary F.
23 Jun.	Katherine E. Doughty,	So. Manchester, Ct.,	John W. and Elizabeth A.
5012	Edward G. Storey,	New York, N. Y.,	John M. and Caroline A.
20 Sept.	Grace H. Fernald,	Boston, Mass.,	Levi P. and Ellen A.
5627	Ralph S. Fernald,	" "	William F. and Mary
17 Oct.	Katherine G. Littlefield,	Cambridge, Mass.,	Charles and Adelaide
6118	Anthony H. Dernald,	Boston, "	William H. and Maria L.
5 Nov.	Laura K. Penny,	Natick, "	Thomas and Julia
6164	Harry V. Fernald,	Arlington, "	Henry A. and Susan R.
8 Nov.	Mary C. McAuliffe,	Lynn, "	William J. and Mary
6245	Leroy C. Pinkham,	Etna, Me.,	Randall and Lizzie C.
12 Nov.	Ella M. Fernald,	Ellsworth Falls, Me.,	George and Pricilla

1907

2780	Albert H. Davis, Jr.,	Bridgeport, Conn.,	Albert H. and Ella
5 Jun.	Helen A. Fernald,	Boston, Mass.,	George W. and Harriet S.
5266	Gordon H. Fernald,	Cambridge, Mass.,	Robert P. and Jennie
18 Sept.	Adeline M. Taft,	Worcester, "	Frank W. and Mary
6064	William E. Anderson,	Halifax Co., N. S.,	William C. and Lalia
9 Oct.	Louise S. Fernald,	Boston, Mass.,	John and Mary J.
6167	George H. Hartshorn,	Walpole, "	Warren and Angeline
23 Oct.	Gertrude H. Fernald,	Portland, Me.,	Samuel R. and Ellen L.



R

DATA ETC.	NAMES.	BIRTHPLACE.	PARENTS.	Children.
1908	Arthur L. Fernald,	Islesford, Ce.,	Samuel S. & Phebe,	
282	Katherine E. Griffin,	Fitchburg, Mass.,	Patrick & Nora,	
16 Jan.	James Gallacher, Jr.,	Scotland,	James & Jeanette,	
2969	Carrie E. Fernald,	Everett, Mass.,	Charles B. and Elsie,	
23 Jun.	Albert Fernald,	Winterport, Me.,	Alexander & Rumney G.,	
4451	Edith H. Dyer,	Gorham, "	George W. & Martha,	
9 Sept.	William G. Fernald,	Houlton, "	John A. & Joanna,	
527*	Cora E. Shaw,	W. Buxton, "	Joseph & Emily,	
16 Jun.	William T. Cummings,	Boston, Mass.	George R. & Annie,	
563*	Laura Fernald,	Medford, "	Frank & Mariette F.	
24 Jun.				

Addenda.

1909				
30 Sept.	Paul Fernald,	Chicago, Ill.,	James W. & Sarah	
	Mrs. Louise M. Scruton,	Jamaica Pl., Mass.	John O. & Mary Waters	



Births

NAME.	PARENTS' NAMES.	DATE OF BIRTH.	NO
Margaret Jane Fernald,	da. John and Mary J.	Portland, Me., and Boston, Mass.,	Jan. 9, 1886, 3888
William Fernald,	son, Andrew G. and Orilla,	New Brunswick, N. B.	Sept. 11, 1886, 7655
Theodore Nixon Fernald,	son Almerin W. and Emma J.,	Boston, Mass., and Albion, Me.,	Aug. 24, 1886, 9491
Minnie Lucretia Fernald,	da. " " " " " "	" " " " " "	July 25, 1888, 3202
Beatrice Geraldine Fernald,	da. Walter C. and Emma K.,	" " " " Winchester,	Jan. 22, 1888, 4128
Alonza Fernald,	son Alonzo and Catherine,	Quincy, Mass., and Ireland,	Oct. 23, 1888, 4275
Walter Fernald,	son Walter E. and Kate M.,	Kittery, Me., and Janesville, Wis.,	Nov. 14, 1888, 5100
Frank Fernald,	son John and Mary J.,	Portland, Me., and Boston, Mass.,	May 26, 1889, 3310
Evelyn Ida Fernald,	da. William H. and Maria L.,	Pembroke, Me., and Newfoundland,	Mar. 22, 1889, 3841
Edith Clare Fernald,	da. Andrew G. and Orilla,	St. Johns, N.B., and St. Johns, N.B.,	Apr. 23, 1889, 7977
Leroy Adams Fernald,	son Charles B. and Elsie B.,	Rockport and Dorchester, Mass.,	June 13, 1890, 10184
Henry Francis Fernald,	son Henry H. and Ellen E.,	York, Me., and New Brunswick,	Apr. 29, 1890, 7977
Da. Fernald,	Everett and Lizzie,	Maine and Newfoundland,	Sept. 13, 1892, 2032
Ronald Fernald,	son William H. and Maria L.,	Machias, Me., and Newfoundland,	Dec. 18, 1892, 8558
Annie Fernald,	da. _____	_____	Sept. 16, 1892, 11863
Mildred Estella Fernald,	da. William E. and Augusta M.	Boston, Mass., and Boston, Mass.,	June 18, 1892, 14677
Dorothy Fernald,	da. H. H. and Ellen E.,	York, Me., and at St. Johns, N.B.,	Nov. 23, 1893, 9402
Gladys Myrtle Fernald,	da. Charles and Susan,	Boston and Arlington, Mass.,	Mar. 19, 1895, 1642
Dorothea Fernald,	da. Elbridge S. and Alice J.,	Winterport, Me., Milwaukee, Wis.,	Mar. 10, 1897, 1609
_____ Fernald,	son Elmer R. and Hattie I.,	Kittery and Lisbon Falls, Me.,	Nov. 22, 1897, 10054
Constance Fernald,	da. Edward A. and Gertrude,	Chelsea and Dedham, Mass.,	Apr. 4, 1900, 4513
Roy Lynde Fernald,	da. Charles W. and Hortense,	Winterport, Me., and same,	Dec. 9, 1901, 13626
_____ Fernald,	son Luther T. and Bessie H.,	Somerville and N. B.,	Dec. 10, 1902, 13549
Clarence Fernald,	son Chas. A. and Gertrude M.,	Boston and Roxbury, Mass.,	Aug. 13, 1904, 6666
Ruth F. Fernald,	da. Frank L. and Kitty,	England and Manchester, Conn.,	Oct. 5, 1907, 8809
Virginia L. Fernald,	da. Charles W. and Etta T. K.,	Portsmouth, N. H., and Boston,	Dec. 8, 1907, 12223

Here closes the Birth Records furnished to writer from Recorder's Office, Old Court House, Boston, Monday, 8 February, 1909. The Death Records, also, after the boast to destroy F— name and Families "by those who destroy every family, no matter, how good or high they stand if the crimes of criminals were not condoned!"—which line was not condoned—but shown up to the world for proper protection of its noble, lawful, God chosen rulers and honorable inhabitants, the beloved children of our Heavenly Father God who have seen two judges and an attorney general resign; subornation of perjury; death of President McKinley, and the good kings of Italy and Portugal; et als. See Encyclia sent to every Nation and every State Library in the United States. And copy of sworn statement sent to former chief of state police, that should have been promptly acted upon for safety of every good citizen, even if those in high position were brought to the bar of justice, as constitutions and all common laws direct and demand for the safety of the public and all law conforming people which the Declaration of Rights of the Commonwealth of Massachusetts requires to preserve its Sacred Honor. Protect the Innocent! Punish the Guilty!!! I Gave You Proof!!!!

- Joseph Fernald, 9 Apr., 1887, aet. 82y. 6m. 1d., Kittery, Me., son Simon and Miriam, Kittery, Me., 2629.
- Huldah A. Fernald, maiden name Friend, 15 Nov., 1890, 80y. 6m. 9d., Stoddard, N. H., da. Nathaniel (wife Woodbury, M.,) 8942.
- Sarah P. Fernald. (Marshall.) 6 Sept., 1891, 79y., Bradford, N. H., da. Nathan R. and Abigail, N. H., 7119.
- Ellen P. Fernald, (Abrams,) 29 May, 1892, 73y., 6m., 18d., Monhegan, Me., da. John and Phoebe, Boston-Portland, Me., 4757.
- Lenora W. Fernald, 13 Jun., 1892, 26y. 11m. 4d., Lowell, Me., da. Benjamin W. Lowell, Me., 5146.
- Bryant N. Fernald, 14 Jun., 1892, 69y., 1m., 7d., Quincy, Mass., s. Lemuel and Mary, Nottingham, N. H., 5205.
- Sarah E. Fernald, 1 Nov., 1892, 72y., Lynn, Mass., da. Ezra, Lynn, Mass., 9358.
- Thomas F. Fernald, 21 Apr., 1893, 62y., 10m., 5d., Portland, Me., s. Edwin and Martha, Portland and Yarmouth, Me., 3699.
- Orilla M. Fernald, 11 Jun., 1893, 34y., St. John, N. B., da. Thomas C. and Mary A., St. John, N. B., 5347.
- Charles W. Fernald, 2 Oct., 1893, 63y. 5m. 28d., Portsmouth, N. H., s. Joseph and Eliza, Portsmouth, N. H., 8857.
- Mary J. Fernald, 25 Nov., 1893, 28y., Somerville, Mass., da. Patrick, wife Henry, Ireland, 10486.
- Margaret Fernald, 30 Nov., 1893, 62y., Cambridge, Mass. da. John, wife of William, 10367.
- Julia A. Fernald, 17 Sept., 1894, 75y. 9m. 31d., Somersworth, N. H., wife Mark, da. John & Rebecca Roberts, 1358.
- Chester N. Fernald, 3 Feb., 1894, 22y, 1m. 21d., Scituate, Mass., da. Bryant N. & Henrietta C., Quincy, 1131.
- Lizzie Fernald, 13 Mar., 1894, 64y., Somersworth, N. H., Daniel & Phebe, w. Chas. C., 2402.
- Sarah E. Fernald, 28 April, 1894, 78y., Boston, Mass., widow Eli, maiden name Goodwin, 3845.
- George C. Fernald, 13 Feb., 1895, 61y. 5m. 22d., Boston, Mass., s. Benjamin & Julia, Kittery, Me., 1426.
- Minnie E. Fernald, 7 June, 1895, 6y. 5m. 15d., Boston, Mass., da. Almerin W. & Emma J., Boston & Albion, Me., 4976.
- Irene M. Fernald, 11 July, 1895, 56y. 2m. 26d., Waldboro, Me., da. Charles & Althea (Brackett) Me., 5828.
- William H. Fernald, 11 December, 1895.
- William H. Fernald, 25 May, 1896, 65y., York, Me., son of William & Elizabeth (Weeks,) 4697.
- Mary E. Fernald, 23 July, 1896, 42y, 6m., England, da. Thomas Coop & wife Ruth Bradshaw, Eng., 6638.
- Alice J. Fernald, 10 March, 1896, 27y. 5m. 10d., Milwaukee, Wis., da. M. E. Smith & w. Emma Grant, Can., 2341.
- Oliver G. Fernald, 8 May, 1899, 55y. 2m. 23d., Tuftonboro, N. H., s. Joel & w. M. Caverly, Tuftonboro, 4146.
- Joshua W. Fernald, 2 Feb. 1899, 74y., Portsmouth, N. H., s. Thomas & w. Margaret (Marshall,) 1212.
- Mary A. Fernald, maiden name Meserve, widow of Dr. John S. Fernald, 18 May, 1899, 87y., Barrington, N. H., da. Andrew & w. Patience Hall, N. H., 4414.
- Lucien W. Fernald, wife John C., 9 Jan. 1900, 51y., Mexico, son of John & Joanna (Whitnect,) New Brunswick, 297.
- Sarah A. Fernald, 14 Dec. 1901, 77y. 6m. 28d., Boston, Mass., da. Thomas Hunting & w. Sarah Burrill, Petertown, N. H. and Salem, Mass., 10814.
- Olander M. Fernald, 15 Apr., 1902, 61y. 7m. 14d., Candia, N. H., s. Samuel & Hannah, New Hampshire, 3314.
- Ellen E. Fernald, 29 March, 1902, 49y., 81*.
- John Fernald, 1 Jan., 1903, 58y. 8m. 23d., Portland, Me., s. Alfred B. & Anna O. (Curtis,) 11.
- Sarah A. Fernald, 15 Sept., 1903, 53y., St. John, N. B., da. Wm. & Catherine Boyle, Ireland, w. of 7740.
- Harriet S. Fernald, 25 Dec., 1903, 54y. 2m. 1d., Concord, N. H., da. Albert Nichols & w. Nancy Batchelder wife of George W., Amherst & London, N. H.
- Eliza Fernald, 28 Dec., 1903, 74y., Boston, Mass., da. Benj. and Julia (Clark) Fernald, 10532.
- John C. Fernald, 29 Feb., 1904, 84y. 10m. 11d., Otisfield, Me., s. Timothy & Betsey (Ray) Fernald, 47*.
- Leona A. Fernald, 7 Aug., 1904, —y. 1m. 15d., Somerville, Mass., da. Luther T. & Bessie A. (Jack) Fernald, Somerville & New B., 6581.
- Laura J. Fernald, 22 Sept., 1904, 49y. 10m. 22d., Portsmouth N. H., da. Wm. H. & Frances H. (Brooks,) Me., 7913.
- Henrietta Fernald, widow Bryant N. Fernald, 20 Jan., 1905, 73y. 2m. 23d., Nova Scotia, da. Henry & Selina Simpson (Baker,) 617.
- E. L. Fernald, 8 April, 1905, w. Henry W., 65y., Hadley, da. Elbridge G. & Mary M. Bothwell (Spencer) Haddan, Conn., 3143.
- SOPHRONIA C. FERNALD, 28 July, 1906, 65y., Wolfboro Centre, N. H., da. Jonathan P. & Mary C. (Pike) Brookfield & Middleton, N. H., 4th sister poisoned, See C. B. Records, House. 6530.
- Mary F. Fernald, 4 Dec., 1906, 74y. 2m. 24d., Ossipee, N. H., wid. Danl. F., da. Wm. & Lucinda Hazlett (Smith), Portsmouth, N. H., 491*.
- Clara A. Fernald, 15 Mar., 1907, 73y. 2m., Boothbay, Me., widow of Charles W., and da. Simeon Sawyer, 2560.
- John S. Fernald, 23 Dec., 1908, 53y. 3m. 2d., Boston, Mass., s. John & Eliza (Thomlinson) Fernald, Kittery, Maine and Alfreton, England, 11510.

L



PLATE 1346. Col. Tobias Fernald, Capt. Abraham Fernald, Mr. John Fursuld and wife Mary, da. John and Mary Savage

Chapter XVIII.

"Copy.

UNITED STATES GOVERNMENT DESPATCH AGENCY, 4 Trafalgar Square, W. C., London.
His Excellency, 15 January, 1896.

Hon. Thos. F. Bayard,
United States Ambassador,
123 Victoria Street, S. W.,

Sir:

In compliance with my promise of the 11th instant, I now have the honour to enclose a copy of—
A Registry of the Commissions in the Army under the Command of the Honble. Wm. Pepperrell, Esq., for an Expedition against the French Settlements on Cape Breton.

This Register gives the names of the Officers of the Forces sent out by New Hampshire, Massachusetts and Connecticut, in the Expedition that captured Louisburg June 17, 1745." etc.

"The rolls asked for in Mr. Gilmore's letter to Mr. Gallinger, and transmitted through the Department of State to you, cannot be found in either the Colonial, the Admiralty, or the War Offices; and it is presumed that they do not exist in England; but a search is being made in the Audit Office, on the chance of their having been used as vouchers, as suggested by Mr. Gilmore.

Mr. Douglas Brymer, the Canadian Archivist, Ottawa, some time ago said that many documents of the nature of the desired rolls, at about the period of 1745 and later, were transmitted to Halifax, and these documents, or some of them, may still exist at Halifax." etc.







F

For making the present search and for copying the enclosed Register, I shall be a willing recipient of seven dollars, if Mr. Gilmore is willing to make such a remittance. I have the honour, etc.,
 B. F. Stevens."

Copy

1878

General Officers.

William Pepperell, Esq., Lieutenant General and Commander-in-Chief of all Forces by Sea and Land in said Expedition and dated 31 January 1745. From Govr. Shirley and Govr. Law and Govr. Wentworth.

Roger Wolcott, Esqr., Major General from Govr. Shirley. Dated 7 March, 1745.

Samuel Waldo, Esqr., Brigadier General from Gov. Shirley. " 7 " 1745.

Joseph Dwight, Esqr., Brigadier General from Gov. Shirley. " 20 Feby. 1745.

Commissions in the first Regiment of the Massachusetts Troops Received from Govr. Shirley.

NAME.	QUALITY.	DATE
The Honble. Wm. Pepperell, Esq.,	Col. & Capt. of 1st Company.	31st January, 1744
John Bradsheet, Esqr.,	2d Col. & Capt. 2d Company,	5th Feb'y, "
Richd. Cutt, Esqr.,	Major & Capt. 4th Company.	" " "
Peter Staples,	Capt. Lt. 1st Co.	" " "
Ephraim Baker,	Capt. 2d "	16th " "
Jno. Kinsclagh,	Capt. 5th "	2d " "
Jno. Harman,	Capt. 6th "	5th " "
Moses Butler,	Capt. 7th "	
Thos. Perkins,	Capt. 8th "	" " "
Wm. Warner,	Capt. 9th "	" " "
Moses Pearson,	Capt. 10th "	6th " "
John Butler,	Lieut. 2d "	16th " "
John Fairfield,	Lieut. 3d "	5th " "
Bray Deering,	Lieut. 4th "	" " "
Andrew Watkins,	Lieut. 5th "	2d " "
Benj. Harman,	Lieut. 6th "	5th " "
	Lieut. 7th "	
John Burbank,	Lieut. 8th "	" " "
Geo. Garrish,	Lieut. 9th "	" " "
George Knight,	Lieut. 10th "	6th " "
Geo. Gowell,	2d Lieut. 1st "	5th " "
Joel Whittemore,	Ensign 1st "	" " "
John Greenough, Josiah Rice,	Ensigns 2d "	16th Feb'y, 1st Mar., 1744
Nathl. Kimball,	Ensign 3d "	5th Feb'y, 1744
Jos. Weeks,	Ensign 4th "	" " "
Charles Cavenagh,	Ensign 5th "	2d " "
Thomas Adams,	Ensign 6th "	5th " "
	Ensign 7th "	
Thomas Hardy,	Ensign 8th "	" " "



Jno. Bridge,	Ensign, 9th Co.,	5th Feb.,	1744
James Sprigger,	Ensign, 10th Co.,	6th Feb.,	"
Joseph Goldthwaite,	Adjt.	12th Mar.,	"
Jno. Gorman,	Armorer,	1st Feb.,	"

Commissions in the Second Massachusetts Regiment whereof Honble. Samuel Waldo, Esqr., is Col.

Saml. Waldo, Esqr.,	Col. and Capt., 1st Co.	7th Feb.,	"
Arthur Noble, Esqr.,	Lt. Col. and Capt. 2nd,	" "	"
Wm. Hunt, Esqr.,	Majr.	15th Feb.,	"
Saml. Moody,	Capt. 1st. Co.,	9th "	"
Jno. Watts,	Capt. 2nd "	8th "	"
Philip Duamresque,	Capt. 3rd "	8th "	"
Benj. Goldthwaite,	Capt. 4th "	9th "	"
Daniel Hale,	Capt. 5th "	11th "	"
Jacob Stevens,	Capt. 6th "	9th "	"
James Noble,	Capt. 7th "	8th "	"
Richard Jaques,	Capt. 8th "	9th "	"
Daniel Fagg (Flagg?)	Capt. 9th "	13th "	"
Jeremiah Richardson,	Capt. 10th "	8th "	"
Cahrles Procter (Charles?)	Lt. 1st "	9th "	"
James Noble,	Lt. 2nd "	8th "	"
Josiah Crosby,	Lt. 3rd "	8th "	"
Charles Harrison,	Lt. 4th "	9th "	"
James Bayley,	Lt. 5th "	11th "	"
Stephen Webster,	Lt. 6th "	9th "	"
Solomon Bragdon,	Lt. 7th "	8th "	"
Wm. Allen,	Lt. 8th "	19th "	"
Jonn Sibbee,	Lt. 9th "	16th "	"
Clemt. Chamberlain,	Lt. 10th "	8th "	"
John Murphey,	Ensign 1st "	9th "	"
John Cargill,	Ensign 2nd "	8th "	"
Thos. French,	Ensign 3rd "	15th "	"
Jos. Newhall,	Ensign 4th "	5th Mar.,	"
Abraham Edwards,	Ensign 5th "	11th Feb.,	"
Edmon Morse,	Ensign 6th "	9th "	"
Danl. Mishervy,	Ensign 7th "	8th "	"
Edward Clark,	Ensign 8th "	9th "	"
Jona. Lord,	Ensign 9th "	16th "	"
Jno. Russell,	Ensign 10th "	8th "	"
Jno. Shaw,	Second Lieut.,	12th June,	"

Commissions in the Third Massachusetts Regiment whereof the Honble. Jeremiah Moulton is Col.

Jeremiah Moulton, Esqr.	Col. and Capt. 1st Co.,		
Nathl. Donnell, Esqr., (Fernel)	Lt. Col. and Capt. 2nd Co.	5th Feb.,	"
Edward Ellis, Esqr.,	Major and Capt. 3rd Co.,	25th "	"





Christor. Marshall,	Capt.	3d	15th	Feb.	1744
James Grant,	Capt.	4th	1st	"	"
Charles King,	Capt.	5th	1st	"	"
Peter Prescott,	Capt.	6th	9th	"	"
Ammi Ruhami Cutter,	Capt.	7th			
Samuel Rhodes,	Capt.	8th	29th	Jan.	1744
Bartho. Trow,	Capt.	9th	15th	Feb.	1744
Estes Hatch,	Capt.	10th	4th	"	"
	Capt. Lieut.	1st			
	Capt. Lieut.	2d			
Benjamin Stansbury,	Lieut.	3d	1st	Feb.	1744
Benjamin Pippins,	Lieut.	4th	1st	"	"
John Marston,	Lieut.	5th	4th	"	"
Wm. Larkin,	Lieut.	6th	9th	"	"
	Lieut.	7th			
Jonathan Hartshorn,	Lieut.	8th	8th	Feb.	1744
Joseph Miller,	Lieut.	9th	15th	"	"
Ebenezar Newell,	Lieut.	10th	4th	"	"
	2d Lieut.	1st			
	2d Lieut.	2d			
Nathaniel Richardson,	Ensign	3d	15th	Feb.	1745
Israel Porter,	Ensign	4th	1st	"	"
Joseph Gerrish,	Ensign	5th	14th	"	"
Jonathan Hoar,	Ensign	6th	9th	"	"
	Ensign	7th			
John Hearsey,	Ensign	8th	8th	Feb.	1745
Jos. Fairbanks,	Ensign	9th	8th	"	"
Ebenezar Sumner,	Ensign	10th	4th	"	"
James Donnell, (Fernel)	Ensign	—	5th	"	"
John Lane,	Lieut.	—	5th	"	"

Commissions in the Fourth Massachusetts Regiment whereof Saml. Williard, Esqr., is the Col.

Saml. Williard, Esqr.,	Col. & Capt.	1st	Co.	19th	Feb.	1744
Thos. Chandler, Esqr.,	Lt. Col. & Capt.	2d	"	9th	"	"
Seth Pomroy,	Major & Capt.	3d	"	24th	"	"
Joshua Pierce,	Capt.	1st	"	18th	"	"
John Warren,	Capt.	4th	"	18th	"	"
David Melvin,	Capt.	5th	"	15th	"	"
Palmer Goulding,	Capt.	6th	"	15th	"	"
James Stevens,	Capt.	7th	"	13th	"	"
Jno. Huston,	Capt.	8th	"	15th	"	"
Jno. Miller,	Capt.	9th	"	16th	"	"
Jabez Homstead,	Capt.	10th	"	29th	"	"
Abijah Williard,	Lieut.	1st	"	18th	"	"
Jno. Payson,	Lieut.	2d	"	9th	"	"
Eb. Alexander,	Lieut.	3d	"	9th	March	"



R

Jos. Whitcomb,	Lieut.	4th Co.,	18th	Feb.	1744
Ebenezer Melvin,	Lieut.	5th "	15th	"	"
Jno. Stearns,	Lieut.	6th "	15th	"	"
TIMOTHY JOHNSON,	Lieut.	7th "			

(Gt. gt. gr. Fr. of the writer) that was killed in the King's service at Louisburg.

Reuben King,	Lieut.	8th "	15th	Feb.	1744
Saml. Chandler,	Lieut.	9th "	20th	"	"
James Fry,	Lieut.	10th "	13th	"	"
John Trumball,	Ensign	1st "	18th	"	"
David King,	Ensign	2d "	9th	"	"
Wm. Lyman,	Ensign	3d "	9th	March	"
Wm. Hutchins,	Ensign	4th "	18th	Feb.	"
Issac Barran,	Ensign	5th "	15th	"	"
Nathan Payson,	Ensign	6th "	15th	"	"
	Ensign	7th "			
Benjamin Shelden,	Ensign	8th "	21st	Feb.	1744
Jno. Maw,	Ensign	9th "	20th	"	"
	Ensign	10th "			
Jona. Hubbard,	Adjutant		18th	Feb.	1744
John Hamilton,	Lieut.		20th	"	"

Commissions of the Fifth Massachusetts Regiment whereof Robert Hall, Esqr., is Colonel.

Robt. Hall, Esqr.,	Col.				
Edward Evelith, Esqr.,	Lt. Col. & Capt.	2d Co.,	7th	Feb.	1744
Moses Sitcomb, Esqr.,	Major & Capt.	3d "	7th	"	"
	Capt.	4th "			
Jona. Bagley,	Capt.	5th "	7th	Feb.	1744
Jerent. Foster,	Capt.	6th "	7th	"	"
Sml. Davis,	Capt.	7th "	7th	"	"
Thos. Staniford,	Capt.	8th "	7th	"	"
Charles Byles,	Capt.	9th "	12th	"	"
Benjn. Ives,	Capt.	10th "			
	Capt. Lieut.	1st "			
David Silton,	Lieut.	2d "	7th	Feb.	1744
Saml. Greenough,	Lieut.	3d "	7th	"	"
	Lieut.	4th "			
Caleb Sivan,	Lieut.	5th "	7th	Feb.	1744
Danl. Giddins,	Lieut.	6th "	7th	"	"
Isaac Annis,	Lieut.	7th "	7th	"	"
	Lieut.	8th "			
Sam. Morgan,	Lieut.	9th "	12th	Feb.	1744
	Lieut.	10th "			
	2d Lieut.	1st "			
Danl. Eveleigh,	Ensign	2d "			
Bembsley Glakiev,	Ensign	3d "	7th	Feb.	1744
	Ensign	4th "			
Joseph Fry,	Ensign	5th "	7th	Feb.	1744



F

Jos. Goodhue,	Ensign	6th "	7th - Feby. 1744
Jno. Rowe,	Ensign	8th "	" " "
	Ensign	7th "	
Jos. Stanwood,	Ensign	9th "	12th Feby. "
	Ensign		
Benjamin White,	Adjutant		16th Mar. "

Commissions in the Sixth Massachusetts Regiment whereof Sylvester Richmond, Jr., Esqr., is Col.

Sylvester Richmond, Jr.	Col. and Capt. 1st Co.		6th Feby. 1744
	Lt Col.		
	Major,		
Robert Sevan,	Capt.	4th "	13th Feby. 1744
Ebenezer Eastman,	Capt.	5th "	6th " "
Cornelius Sole,	Capt.	6th "	8th " "
Jona. Laurence,	Capt.	7th "	5th " "
	Capt.	8th "	
Eben Nichols,	Capt.	9th "	6th " "
Jer. Weston,	Capt.	10th "	12th " "
Nath. Bosworth,	Capt. Lt.	1st "	6th " "
	Capt. Lt.	2nd "	
	Capt. Lt.	3rd "	
Thos. Waldron,	Lieut.	4th "	13th Feb'y, 1744
Jona. Roberts,	Lieut.	5th "	6th " "
James Griffin,	Lieut.	6th "	8th " "
Thos. Mowray,	Lieut.	7th "	7th " "
Wm. Trefry,	Lieut.	8th "	7th " "
Ed. Pratt,	Lieut.	9th "	13th " "
Jos. Clark,	Lieut.	10th "	20th " "
	Lieut. (2d)	2d "	
	2d Lieut.	3d "	
Edward Gray,	Lieut.	1st "	6th " "
Seth Hathaway,	Lieut.	1st "	6th " "
Jer. Prebble,	Ensign	4th "	13th " "
Jno. Webster,	Ensign	5th "	6th " "
Jos. Brown,	Ensign	6th "	8th " "
Math. Smith,	Ensign	7th "	15th " "
Jno. Tinney,	Ensign	8th "	12th " "
Grover Scolley,	Ensign	9th "	13th " "
Ben. Esterbrook,	Ensign	10th "	20th " "
Mad. Engs,	Adjutant		14th March, "

Commissions in Seventh Massachusetts Regiment whereof Shubal Gorham, Esqr., is Colonel.

Shubal Gorham, Esqr.,	Col. and Capt. 1st Co.		20th Feb'y, 1744
Jno. Gorham, Esqr.,	Lt. Col. and Capt. 2d "		20th " "
Jos. Thacher,	Capt.	3d "	10th " "



F

Edward Dimmock,	Capt.,	1st Co.,	15th	Feby.	1774
Elisha Doan,	Capt.,	4th "	20th	"	"
<hr/>					
Sylvanus Cobb,	Capt.,	5th "			
Israel Bayley,	Capt.,	6th "	13th	Feby.	1774
Gersham Bradford,	Capt.,	7th "	14th	"	"
Jona. Carey,	Capt.,	8th "	"	"	"
Saml. Lumbart,	Capt.,	9th "	"	"	"
	Capt.,	10th "	20th	"	"
<hr/>					
	CAPT. Lt.	2d "			
Nathl. Fish,	Lieut.	1st "	15th	Feby.	1774
Jos. Freeman,	Lieut.	3d "	14th	"	"
Theophilus Paine,	Lieut.	4th "	20th	"	"
<hr/>					
	Lieut.	5th "			
Saml. Bartlett,	Lieut.	6th "	13th	Feby.	1774
Jos. Lawrence,	Lieut.	7th "	5th	"	"
Jona. Loring,	Lieut.	8th "	14th	"	"
Nathl. Bourne,	Lieut.	9th "	"	"	"
Peter West,	Lieut.	10th "	20th	"	"
<hr/>					
		2d Lt.			
Sylvanus Hall,	Ensign	1st "	2d	March	1774
Joshua Bassett,	Ensign	3rd "	14th	Feby.	"
Wm. Clark,	Ensign	4th "	20th	"	"
<hr/>					
	Ensign	5th "			
Nathl. Bosworth,	Ensign	6th "	13th	Feby.	1774
Jona. Eames,	Ensign	7th "	14th	"	"
Caleb Cocke,	Ensign	8th "	"	"	"
Jona. Carver,	Ensign	9th "	"	"	"
Jos. Manter,	Ensign	10th "	20th	"	"
Mathew Lombart,	Adjutant,		12th	April	"

Commissions in the Connecticut Regiment whereof William Burr, Esq., is Colonel.

Andrew Burr, Esq.,	Colonel,	16th March, 1744.
Simon Lothrop, Esq.,	Lieut. Col.,	" " "
Eleazr. Goodrich,	Major,	3rd June, 1745.
David Worster,	Capt. of a Co.,	16 Mar., (Prob. same yr.)
Henry King,	Capt.,	3rd June, " " "
William Whiting,	Capt.,	16th Mar., " " "
Danl. Chapman,	Capt.,	" " " " "
Robt. Dennison,	Capt.,	" " " " "
Andw. Ward,	Capt.,	" " " " "
James Church,	Capt.,	" " " " "
Stephen Lee,	Capt.,	" " " " "
Nathl. Beedle,	Lieut.,	" " " " "
Sam. Torrey,	Lieut.,	3rd June, " " "
Wm. Throope,	Lieut.,	16 Mar., " " "



T

Noah Taylor,	Lieut.	16th March, (Probably 1745)
David Seabury,	Lieut.	" " " "
Wm. Smithson,	Lieut.	" " " "
Saml. Pettibone,	Lieut.	14th June, " "
Jona. Read,	Lieut.	" " " "
Nathan Whiting,	Ensign	16th March, " "
Jno. Hodgkins,	Ensign	12th April, " "
Jos. Wait,	Ensign	14th June, " "
Jno. Huntington,	Ensign	16th March, " "
Jon. Darling,	Ensign	" " " "
Christr. Tracey,	Ensign	" " " "
Jon. Noble,	Ensign	14th June, " "
Thos. Leeds,	Ensign	3rd " " "

COMMISSIONS IN THE NEW HAMPSHIRE REGIMENT, WHEREOF
SAMUEL MOORE, ESQR., IS COLONEL

Saml. Moore, Esqr.,	Col. and Capt. 1st Co.,	1st March, 1744
Nathl. Mesharve,	Lt. Col. Capt. 2nd "	" " "
Eliczr. Gilman, Esqr.,	Major. Capt. 3rd "	" " "
Jno. Tufton Mason,	Capt. of a Co.	" " "
Wm. Sayward,	Capt.	" " "
"Jno. Turnel"=Fernel=Fornel,"	Capt. (Pls. 1162 & 1246)	" " "
(The writer's ancestor, Capt. John Fernald, the Hero of Louisburg) (Cut off by Jealous Pepperell) (Plates 1120-1-2, 1339) (For son, see Plates 1346, 1128 & 1129) (Plate 1126) (Page 220)		
Sam. Hall,	Capt.	1st March, "
Jacob Tilton,	Capt.	" " " "
Edwd. Williams,	Capt.	" " " "
James Whidden, (Whitton?)	Capt. Lt. 1st Co.	" " " "
Thos. Westbrook Waldron,	Capt. Lt. 2nd "	" " " "
Moses Wirgett,	Lt.	" " " "
Ezekiel Pickman,	Lt.	" " " "
Richard Mattoon,	Lt.	" " " "
Saml. Robie,	Lt.	" " " "
Jona. Flagg,	Lt.	" " " "
Elipht. Daniel, (Fannel?)	Lt.	" " " "
Jerh. Wheelwright,	Lt.	" " " "
Sam. Levitt,	2nd Lieut. 1st Co.	" " " "
Clement Ham,	Ensign	" " " "
Jno. Hart,	Ensign	" " " "
Robt. Perkins,	Ensign	" " " "
Edmund Brown,	Ensign	" " " "
Christr. Huntress,	Ensign	" " " "
Thos. Pickering,	Ensign	" " " "
Edwd. Brookes,	Ensign	" " " "
Jno. Eyre,	Adjutant	" " " "
Thos. Sherbourne,	Capt. of a Co.	6th June, 1744
Trueworthy Dudley,	Capt. and Lieut.	1st March, "
Sam Conner,	2nd Lieut.	" " " "
Danl. Wormaall,	Ensign	" " " "



N

Jno. Gilman,	Lieut. of Marines,	15 April, 1744
Abraham Trefethen,	Capt. Co. Marines,	15 " "

COMMISSIONS OF THE TRAIN OF ARTILLERY SENT FROM THE MASSACHUSETTS PROVINCE

Jos. Dwight, Esqr.,	Colonel,	20 Feb., "
Richd. Gridley, Esqr.,	Lt. Col. and Capt. of the Train and Com- missionary,	21 " & 20 Mar., 1744
Abraham Weller,	2d Capt. and Chief Bombardier 16th Y 21st,	21 Feb., 1744
Thos. Campling,	1st Lieut.	21 " "
Bartho. Green,	2d Lieut.	21 " "
Jos. Chadwick,	3d Lieut.	21 " "
Jos. Holbrook,	4th Lieut.	21 " "
Jno. Gorman,	1st under Bombardier,	20 " "
Charles Pincheon,	Adjutant,	20 March, "
Jos. Hawley,	Chaplain,	10 " "

COMMISSIONS

Jno. Henry Bastide, Esqr.,	Principal Engineer,	3 June, 1745
Robert Glover, Esqr.,	Adjutant General,	10 March, 1744
Wm. McIntire, Esqr.,	Quarter Master General,	20 " "
Edwd. Ellis, Esqr.,	Surgeon General of the Mass. Troops,	19 Feb.
Joseph Pierce, Esqr.,	Surg. Genl. of N. H. Troops & Naval Force,	1 March
Robt. Keith,	2d Surg. Genl. of the Massachusetts Troops,	20 " "
John Kinsclagh,	Agent for the Transports,	10 " "
Jno. German,	Principal Armourer,	1 Feb.
Thos. Waldo,	Muster Master,	7 March
Andrew Lemereicer, Jr.,	Interpreter,	7 " "
Nathl. Walter,	"	22 " "
Sam. Rhodes,	Aid de Camp.	1 May
Sam. Waldo, Jr.	" " "	" " "
Wm. Winslow, Sam Waldo, Jr.,	Commissaries of the Provisions of Muster Roll for the Connecticut Regiment.	2 Feb., 2 Feb., 20 Feb.
Melatiar Bourn, Geo. Carwin,		21 Feb., 14 March
Jer. Miller, Jr.,	General Clark,	10 June
Andrew Le Mercier, Jr.,		

COMMISSIONS

" " " "	Agent transports Clark,	18 March
Eduard Baine,	Master of the Baggage,	19 March

SURGEONS

Alexr. Bulman, Wm. Rand, Jos. Binney, Antho. Emery, Philip Gaspers	Cast, Gullam Taylor,	
— 4 Feb., 1744, 9 March, 10 Feb., 20 Feb., 19 Feb.		
Charles Pyncheon,	Surgeon General's Mate,	10 March
Jos. Lebarron, Jacob March,	} Under Surgeons,	19 Feb., 4 and 18 Mar.
Michael Lowell,		
Jona. Prescott, James Oliver,	Dr. to Surgeon General	19 March
Mathew Barnard,	Capt. House Carpenters,	16 " "
James Pierpont, Andrew Brown,	2d Capt. and Lieut.	11 " "
Edward Paine, Richard Abbot,	} Capt. of an Independent Co. of Granediers,	19 Feb., 19 Feb.,
Geo. Hanners,		





COMMISSIONS.



Moses Dennett,	Capt. of a sloop in the pay of the Massatts.	18th March, 1744.
John Prentiss,	Capt. of sloop Defence in pay of Connecticut.	19th " "
Ed. Brooks,	1st Lt. sloop Abigail in pay of N. H.	1st " "
Zechariah Forss,	Lieut. of the sloop Abigail.	" " "

BREVETS.

Benjamin Green, Capt. &c. 1 at March; Wm. McIntire, Major, 22nd March; Jos. Goldthwait, Capt., 20th March; Robt. Glover, Capt., 19th March; Saml. Waldo, Jr., Capt. 23rd March, Andrew Lemerrier, Jr., Lieut., 5th Feb'y; Andrew Pepperell Frost, Lieut. 1st March; Benjamin Green, Secretary of the Expedition,, March 1st; Charles Frost, 2nd Secretary, 1 March.

A true copy, Benj. Green, Secretary.''

Capt. JOHN FERNALD, or Turnel, or Fernel, or Furnald was Convoy of the American Troops.

MEMORANDA OF THE MILITARY SERVICES OF THE PATRIOTIC FERNALD FAMILIES DURING THE CIVIL WAR.

Congressional Medal of Honor to Captain Albert E. Fernald

Born 13 May, 1838, at Hampden, Me., s. Elbridge & Mary W. (Blake) Fernald. Enlisted 23 July 1862; m. Abbie H. Colburn, 1st June, 1865: Had—Elizabeth M.; Charles W.; and Roy L., a Lieut. in 26th U. S. V. Inf.

Albert P., b. 15 Aug. 1819. Enlisted 15 Aug. 1862. Discharged for disability. 6 Aug. 1863, 1st Sergeant, Co. H, 12th N. H. Inf.; m. 1st, Rosetta H. Hunt; 2nd, Mary H. Fernald: Had—Mary G. E., Frank, Carrie.

Alonzo, Kittery, b. a. 1835. Enlisted in Co. G, 27th Me. Inf., 30 Sept. 1862: m. Martha Berry, and 2nd, Anna Irene Philbrick: Had—Frederick, Hattie, Charles and Frank.

Alonzo, enlisted in Co. H, 4th Mass. Inf., 16 Mar. 1861; b. 1843. Hon. discharged 22nd July, 1861: Reenlisted 4 July, 1864, in C. 24th Mass. Inf. Promoted to Corporal, and discharged 20 July, 1865.

Benjamin, b. 17 May, 1812, s. "John and Betsey (Manson)" Fernald: Enlisted, 2nd Sept. 1862, Co. G, 27 Me. Inf. Mustered out with Regt., 17th July: m. Amy C. Lydsten, 28 May, 1840: Had—Benjamin E., Annie E., Charles H., Margaret E., William K. and Julia, all born at Kittery, Me. His son—

Benjamin E., b. 5 Aug. 1841; Enlisted 2nd Sept. 1864. He was at battles of Fort Fisher, and had a very long range of services till 1894, when he was placed on the Navy Retired List.

Benjamin H., b. a. 1842. Residence, Alfred, Me. Enlisted 2 July, 1864. Hon. discharged 30 Nov. 1864.

Benjamin W., b. a. 1833, of Abington, Mass. Enlisted in Co. H, 58 Mass. Inf., 27 Feb. 1864. Died of wounds at Washington, D. C., 8th July, 1864.

Benjamin W., died 21 June, 1864, of 10th Indiana Battery. Buried at Marietta, Ga. Sec. G, No. 349. His name appears among the known dead published by U. S. Government.

Cassius M., b. a. 1844, s. Rev. James and Maria (Brackett) Fernald, of Saco, Me. Enlisted in U. S. Engineers during the Civil War. His brother—

George P., enlisted as Private and promoted to Lieutenant.

Charles, Co. C, 2nd Iowa Inf. Died 14 Dec. 1864, and buried at Cave Hill, Louisville, Ky. Sec. 3, Range 4, No. 63.



N

CHARLES A., b. Jun. 1838 at Burlington, N. H., s. Isaac & Mary (Drew) Fernald, Enlisted in Co. E. 13th N. H. Inf., 7th Aug. 1862: Hon. Discharged 16 May, 1864. His Brother Nehemiah C. was a Member of 30 M. 1st Heavy Arty., he m. Mary E. Randall of Lee, N. H. and had Charles E., Daniel C., Clarence L., and Florence M. Fernald.

Charles C., b. 19 Sept., 1829, s. of Robert and Aphie (Coffin) Fernald. Enlisted 6 Sept., 1864 as Actng. 3d Assistant Engineer in the Navy. Hon. Discharged 21 Sept., 1865. Served on U. S. S. Colorado and Trefoil. Lewis C. served in Co. D. 5th N. H. Inf.

Charles Freeman Fernald, b. 24 July, 1842, s. "Mark and Ruth (Fogg) Fernald." Enlisted in Co. H. 2d, N. H. Inf. 11 Aug., 1862. Killed at Chancellorsville, Va., 3d, May 1863.

Charles Frost Fernald, b. 25 Mar., 1836, s. Simeon and Olive (Keniston) Fernald. Commissioned 2d Sept., 1862. Mustered out 2 July, 1863. Com. Capt. Co. M. 2d N. J. Calvary, 2nd Sept., 1863. Mustered out 1 Nov., 1865. Com. Major 24 Oct., 1865. His father served in War 1812-15. Gr. Fr. served in American Revolution: m. 10 Sept., 1863 to Sarah Kyte. His last known address at Marshallton, Kansas, U. S. A. His brother, Frank S., of Co. B. 15th N. J. Inf., was killed at Spottsylvania, 12 May, 1864.

Charles G., b. at Elliott. Enlisted 20 Sept., 1861, in Co. G. 23d Mass. Inf. Promoted to Cor. Flag State Bearer of Regiment. Taken prisoner at Battle of Doweys Bluff, Va. and d. at Andersonville, 29 Aug., 1864. Bur. No. 1754.

Charles H., b. 16 March, 1838, s. of Ebenezer and Sophronia (Wosgatt) Fernald. Appointed Masters Mate on U. S. S. Stetten, 28 April, 1863. Transferred to the Cornation, 9th July, 1864. Promoted to Actng. Ensign, 6 Aug., 1864. Detached and ordered to Satapsco, 9 Sept., 1864, to the G. W. Rogers, 2nd Jan., 1865. Detached 16th June, 1865. Resigned 30 May, 1865. Accepted and Revoked 30 May, 1865 and granted two mos. leave from 20 June, 1865. Hon. Discharged 20 Aug., 1865 m.

Charles Hale, b. 3 July, 1836, s. Nathaniel and Rebecca (Hale) Fernald. Com. Capt. in Co. D. 118 Penn. Inf. and Mustered in 25 Aug., 1862. Hon. Discharged 1 Feb., 1864. Com. Quarter Master 214 Penn. Inf. and Mustered in 20 Mar., 1865. Hon. Regiment with his mustered out 21 Mar., 1866 m. Margaret, da. Dr. Vandyke of Philadelphia and d. prior to 1878.

Charles O., b. 31 May, 1840, s. Simon and Caroline (Fenderson) Fernald. Enlisted in Co. B. 4th Me. Inf. 15 May, 1861. Arm lost in 1st Bull Run battle, 21 July, 1861. Tasted the horrors of Libby prison four months. Mustered out 20 May, 1864, m. in 1872 Elvira F. Lampman, who d. 12 April, 1886: m. 2d Persis A. Mugridge, had one da. and Harry B., and George A. Fernald.

Capt. Daniel, b. 19 Nov., 1767, s. George and Anna (Leach) Fernald, although not Enlisted, took a hand in the Revolution and War of 1812-15. See previous written record.

Dalos, Corporal Co. H. 2nd Michigan Cavalry. Died 26 Dec., 1864: buried at Jeffersonville, Ind. Grave Section 1st 122.

Daniel, Quarter Master on U. S. S. Nippon, off New Inlet J. V. C. 9 Nov. 1863, of Malden, Mass. Edmund Fernald in Capt. S. Buleins Co., Genl. Jno. Blakes Regt., 31 Aug. to 3 Sept., 1814.

Edward, Co. H. 2d Miss. Calvary. Enlisted 26 Aug., 1861, at Climax, Mo. d. 21 July, 1862, at Memphis, Mo. of wounds recd. in battle.

Edward Ambrose, b. at Boston, Mass., s. Eli and Sarah (Goodwin) Fernald. Enlisted as Drummer, Co. H. 47th Mass. Inf. 16 Oct. 1862. Hon. Discharged 1 Sept., 1863, and d. 27 Sept., 1863. Aet. 17 yrs. 7 mos. 17d.



F EDWARD S., b. 1840. Enlisted at Boston in U. S. Navy 26 April, 1862. Served on the Ohio, Dacotah, Brandywine. Discharged 21 March, 1865 (Edward H., in Navy on U. S. S. Hinson, so Barker says.) These records abbreviated taken from Loan of Mr. Henry W. Fernald, Boston, P. O.

Edward S., if the record be true? s. of Saco, Me. drafted for one year. Sent James Stevens, 29 Aug., 1864 in Me. Inf. "Some declared it an unholy war and unpatriotic, kept away."

Eli, b. 11 Sept., 1826, s. James and Nancy (Waterman) Fernald. Enlisted 29 Aug., 1864, Co. L. 21 N. H. Regt. Hon. Discharged 15 June, 1865. His bro. William of Springfield, Mass. Served in 2d Mass. H. Arty. during the war. Eli, m. Eliza Ann Welch, had chn. d. y. He d. at Milton, N. H., 27 Sept., 1869.

Elisha, b. a. 1843, s. Thomas Chandler Fernald and wife Sarah. Enlisted, 8 Nov., 1861 in Capt. James Fernald's Co. 72d Ohio, Vol. Inf. Discharged 11 Sept., 1865. They were brothers and their father Thomas Chandler Fernald served as Private in his son's Company.

Frank B. Fernald. Enlisted in 60th Mass. Vol. Inf. 100 days men.

Frank Simon, b. 1 July, 1839, s. Simon and Olive (Kinston) Fernald. Enlisted 4 Aug., 1862 in Co. B. 15th N. J. Vol. Inf. for the term of three years. Killed in action at Spottsylvania, Court House 12 May, 1864. Born at Eaton, N. H., a school teacher. Moved to Warren Co. N. J. Married Emma Plotts Feb., 1861. He was brother Capt. Charles Frost Fernald of the 27 N. J. Inf. and 2d N. J. Calvary of Civil War.

Frank L., b. 11 Nov., 1835 at Eliot, Me., s. Wm. S. and Sarah A. (Hanscom) Fernald. Commissioned as Naval Constructor 12 March, 1875, a very long line of duties and Promotions from 1871 to repairing Vessels at Hong Kong, 27 March, 1901.

George Fernald, Kittery, Me. Enlisted as carpenter in the Navy during the Civil War.

George E. Fernald. Commissioned as 2d Lieut. in 5th Maine Vol. Inf. Residence, Portland, Me.

George H. Fernald, b. 2 Feb., 1837, s. Henry Jonathan Fernald and wife. Enlisted 15 Sept., 1864 Co. B. 29 Me. Vol. Inf. Promoted and discharged 31 May, 1865. Resided at Troy and Canaan, Me.

George L., b. 1827. Enlisted as Private and Mustered in 3 Sept. 1862. Mustered out 27 June, 1863, m. and resided at Westfield, Union Co., New Jersey. Co. H. 30th N. J. Vol. Inf. See Ad. Jt. Genl. Records, N. J.

George P., 1839, s. Rev. James and Maria (Brackett) Fernald. Bro. Cassius M. Fernald, U. S. Engineer C. Corps, Enlisted as Private in 10th Me. Vol. Inf. Served from 4th Oct., 1861 to close of war. Promoted to Sergeant, and later to 2d Lieut.

George R., b. 25 June, 1825 at S. Levant, Me., s. Robert and Roxanna (Buswell) (Buzzell?) Fernald. Commissioned as 2d Lt. 21 Aug., 1862 Co. C. 1st Me. H. Arty. Promoted to 1st Lt. Capt. 7 Nov., 1864. Capt. George R. Fernald was State Senator and Member of Gov. Robies Council in 1885-6, m. Jane Blake, m. 2d Eliza Woodbury.

George T., b. 1843, s. Mark and Julia A. (Hanson) Fernald. Enlisted in Co. I. 46 Mass. Inf. 29 Oct., 1862. Hon. Discharged 20 Aug., 1863, also, in Co. C. 42 Mass. Inf. from 14 July, 1864 to 1 Nov., 1864. 100 days men taken prisoner and paroled at Galveston, Texas, 1 June 1863, m. Sarah F. Berry in 1868; had Emma and Mark living in Malden.

George W., b. 1821. Enlisted 29 Dec., 1863 as Private in Co. G. 29th Me. Inf. Died of Pleurisy at Alexandria, 8 May, 1864. Buried in Section 1, No. 19, m. Mary Kneel, had ; Chesley H., Nancy J., Oliver N., George W., Julia E., Hersey E. and child that died young.

N GEORGE WALLACE FERNALD, b. 21 April, 1875, s. Thomas L. and Mary A. (Mills) Fernald. Enlisted in the Minnesota Guard, July, 1895, also in 13 Min. Vol. Inf. 28 April, 1898. Service in Philipines and brother Thomas C. was in same Co.

Granville, s. Otis Fernald. Commissioned Capt. in Co. B. 23 Me. Vol. Inf. 29 Sept., 1862. Resigned 13 April, 1863. Capt. reserved Veteran Corps Stationed at Washington, D. C. 30 April, 1864.

Henry A., b. 1839, s. Hiram and Abigail (Grant) Fernald. Enlisted in Co. B. 22 Mass. Vol. Inf. 10 Sept., 1861. Promoted to Sargeant, 2d as 1st Lt. 1861, 3d as Capt. Commissioned. Ordinance Officer. Resigned and reenlisted 1866. Major 1869, m. went into U. S. Signal Serv. Resides in South.

Henry W., b. 21 Dec., 1840, s. Benjamin and Lavina L. Fernald. Enlisted in Co. H. 25 Mass. Vol. Inf. August, 1861. Discharged at close of War 26 July, 1865. March 1867 he was appointed as Clerk in the Money Division, Boston, Post Office, which position he still holds Jan., 1909. Is a member of Edw. W. Kinsley Post and Department of Mass. G. A. R. and Past Snr. Vice Commander of it. Past Vice President of the 25 Mass. Vetn. Vol. Association. Member King Arthur's Lodge No. 1492, K. of H. and several other organizations, m. 20 Jan., 1870 Eleanor L. Bothwell, had son died young.

Hercules S. Fernald. Enlisted in Co. D. 10 Me. Vol. Inf. and d. 22 Feb., 1862 of Typhoid Fever at Relay House, Md.

Herrick J. Fernald, Co. F. 22d Ill. Writer suggests further investigations.

HORATIO P. FERNALD, b. 1834, s. Hiram and Abigail (Grant) Fernald. Enlisted Co. F. 7th Me. Vol. Inf. 23 Jan., 1862. Trans. to 1st. Me. Vol. Inf. 4 Jan., 1864. Dentist. Resides in Cheltenham, England.

Isaac, b. 1835. Enlisted 29 Aug., 1862 Co. E. 3rd Mass. Cavalry. Promoted to Sargeant. Hon. Discharge 18 Oct., 1863. Occupation, Merchant and Real Estate, resides in Chelsea before Gt. Fire.

Jacob Fernald, b. Served in Sargeant, Nath. Greely's Detachment at Plumb Island, Sept., 1814.

Jacob E. Fernald, b. 20 Dec., 1831, s. Josiah and Sophia (Eastman) Fernald. Served in Civil War.

James Fernald, b. 1839, s. Thomas C. and Sarah Fernald. Appointed as 2d Lt. 19 Oct., 1861 to Recruit men for the 73 Ohio, Vol. Inf. Commissioned as 1st Lt. and Capt. 7 Jan., 1862. Mustered out with Co. 11 Sept., 1865. His father, Thomas C. and bro. Elisha served in his Co. through the War. In his Co. Captain James was distinguished for his bravery and good conduct and received special mention from his Commanding Officers on several occasions.

James Brown Fernald, b. 11 July, 1787, s. Elisha and Hannah (Chandler) Fernald. Served during the War of 1812 and 1815. He m. 30 Nov., 1809 Anna Card and had Thomas C. who with his two sons served throughout the Civil War in Co. G. 72 Ohio, Vol. Inf.

James G. Fernald, b. a. 1843 at Canterbury, N. H. Resided at Manchester and 22 July, 1861 in Co. A. 3d N. H., Vol. Inf. Wounded at Fort Wagner, S. C., 8 July, 1863, again at Morris Island, S. C., 31 Aug., 1863. Reenlisted and mustered in 12 Sept., 1864 and again wounded at Drury's Bluff, Va., 13 May, 1864, again at Bermuda, H. Va., 4 June, 1864, again 31 Aug., 1864 at Petersburg, Va. Being made of the same flesh and blood of his Roman Forefathers he had not enough of it till the foe was conquered and reenlisted 12 days later and served with his Co. until the 7th April, 1865 when he was transferred to 168 Co. Vet. Reserve Corps 2d Battalion of Uncle Sams Family.



T

JAMES M. FERNALD, b. a. 1836. Enlisted 24 June, 1861, as Musician. Discharged by Act CONGRESS 7 Aug., 1861. Resided at Houlton, Me.

James S., b. 31 May, 1834, s. Benjamin and Lavinia L. Fernald. Enlisted as Sergeant in Co. B., 7th Me. Vol. Inf., Sept., 1861, d. Baltimore, Md., Dec., 1861. Buried Concord, Mass. Name inscribed on Monument. Married Julia A. Sanborn, 1 Oct., 1856, of East Boston, Mass. His son, Fred A. Fernald is proprietor of University Book Store, N. Y. City; and writer bought Plate of Dr. Jean Fernel on a page of Book at his Store.

John, b. a. 1832 of Kittery, Me. Enlisted in Co. A., 32 Me. Vol. Inf., 3 Mar., 1864, Wounded 12 May, 1864. Transferred to Co. A, 31st Regt. Me.

John, b. 1837, s. Parker and Lydia (Tuttle) Fernald. Enlisted in Co. B, 17th N. H. Vol. Inf., 26 Sept., 1863. Transferred to Co. K, 2d N. H. Vol. Inf., 16 Apr., 1864. Served also in the Navy several years after Civil War. Married 6 July, 1866, to Louisa Newell, residence Salisbury, Mass.

John Frank, b. 6 Dec., 1839, s. Benjamin A. and Caroline E. (Young) Fernald. Enlisted 13 Aug., 1861, in Co. B, 4th N. H. Vol. Inf. Hon. discharged 27 Sept., 1864.

John Kinsman, b. at Portland, Me., 1830, s. Nathaniel and Rebecca (Hale) Fernald. Served in Civil War.

John N., b. a. 1844. Enlisted in Co. C, 18th N. H. Vol. Inf., 9 Sept., 1864. Discharged 10 June 1864. Residence Ossipee, N. H.

John S., b. a. 1843. Enlisted 19 Nov. 1861 in Co. E, 24 Mass. Vol. Inf., and d. 11 Sept., 1862, at Newbern, N. C. Residence Boston, Mass. Artist or Painter.

John S., b. a. 1845. Enlisted in Co. B, 42d Mass. 100 days Regt., 14 July, 1864. Discharged 1st Nov. 1864. Resided at Roxbury, Mass.

John S. P., b. 10 Apr. 1847 at Barrington, N. H. Enlisted in Co. K, 11th N. H. Vol. Inf., 8 Aug., 1862. Honorable discharge 14 Jan., 1863, at Washington, D. C., d. at Roxbury, Mass., 18 Oct. 1874.

John Q. A., b. a. 1839. Enlisted 29 Aug., 1862, in Co. E, 20th Me. Vol. Inf. Hon. discharged for disability in 1863. Residence Waldoboro, Me.

Two by the name of Joseph Fernald served in Capt. H. Frost's Co., Col. Pyersons Regt. Also in Col. Paul Merritt's Regt., Capt. Pike's Co., 1814. Served at Newbury Fort and Plum Island. And two by the names of Joseph Fernald, s. Joseph and wife Anna More, b. 4 Oct., 1704, s. Deacon John F. and wife Sarah, da. Judge John Hinckes, s. of John F., m. Mary Spinney, s. Thomas and Temperance Washington, s. Dr. Renald F. and wife Joanna Warburton, in Capt. Tobias Fernald's Co., Col. James Scammon's Regt. 30th, Fort 1. A Bounty Coat, payable Lieut. Thomas Cutts, Nov. 28, 1775. And Joseph Weeks Fernald, Private, Enlisted May 13, 1775. Former served 8 months and latter in Capt. Samuel Leighton's Co., same Col., served 3 months, 4 days. How long after that they may have served to writer unknown.

Joseph B. Fernald, b. 22 Jan., 1843. Enlisted 11 Oct., 1862 in 26th Me. Vol. Inf., also in Co. B., 29th Me Vol. Inf., 30 Dec., 1863. Residence Troy, Me., Transferred to Veteran Reserve Corps.

Joseph F., b. at Portsmouth, N. H. Appointed from Boston, Mass., 25 Aug., 1863, as Acting 2d Assistant Surgeon in U. S. Navy. Hon Discharge 5 July, 1865. Served on U. S. S. Britania and sent to Boston as Engineer-in-Chief on prize ship "Storm King." Returned to Britania till his Honorable Discharge.



**F**

JOSEPH FERNALD, b. 4 Sept., 1830, s. William and Lydia (Clements) Fernald, s. William and Mary (Molly Hammond) William was bapt. 24 July, 1757, s. Col. Tobias Fernald and wife Mary, (da. Jonathan Andrews,) s. Capt. John and Elizabeth (Rogers) Fernald, s. Dea. John and Sarah Hinckes Fernald, s. Dr. John and Mary (Spynnie) s.

Thomas and Temperance (Washington) Fernald, s. Dr. Renald and Joanna (Warburton) Fernald, m. at East Boston, Mass., 25 Dec., 1861, Louise Stoddard Crocker, b. Duxbury, Mass., da. Daniel S. Crocker and wife Deborah Prior, 22 May, 1835 they had Mary Louise (named for Mary Spinney and Louise de Coligny) Charles Pierce (named for Charles VIII and the fate of Dr. Renald Fernald's grandfather.) Walter Frank, George Porter, Albert Chapman, Flora Alice, and Josephine May. He was an Engineer in Civil War and wore the Oak Leaf of Fort Fisher and his brother William, b. 8 March, 1823, was a Soldier in 2d N. H. Regt. Another brother Charles Pierce, b. 3 Aug., 1832, "was poisoned accidentally by" ? "Water Hemlock." (Socrates poison) Joseph Fernald, d. from fractured skull at Medford, Mass., 2 Dec., 1897. It was alleged to writer by—"by crime and not accidentally falling into a trench excavated for water pipes." His widow Mrs. Louise S. Fernald, d. at Medford, Mass., 6 Feb., 1898. Mr. Joseph Fernald was with me many times and many hours. In form he was a remarkable resemblance to my father and his many noble traits of character displayed under trying circumstances demonstrated a grand noble man. His Mansion Hall was constructed in a grand Roman and French ancient and beautiful architectural style.

Laban Fernald, b. a 1844. Enlisted 11 Oct., 1862 in Co. A. 26 Mass. Vol. Inf.: also in Co. B. 29 Me. Vol. Inf. 30 Dec., 1863. He was promoted to Corporal and Sergeant. Resided at Troy, Me. Recorded as Henry, s. Jona.

Lewis C., b. 4 Nov., 1840, s. Robert and Afshia (Coffin) Fernald. Enlisted in Co. D, 5th N. H. Vol. Inf., 25 Sept., 1861. Wounded 3 June, 1864 at Cold Harbor, Va. Honorably discharged 29 Oct., 1864: m. 25 Dec., 1860 Caroline V. Wingate. His brother Charles C. was Engineer in the Navy. Mark in Capt. J. Chamberlain's Co., 1812.

Mark, s. of James, s. Dea. John and Sarah (Hinckes) Fernald, s. Dr. John and Mary (Spinney) s. Thomas and Temperance (Washington) Fernald was in Capt. Chase's Co., Col. Benj. Lincoln's Regt., from 8 to 25 July, 1814.

Mark, b. 17 May, 1837, at Ossipee, s. Charles, s. Ebenezar. Enlisted in Co. A, 2d Me. Cavalry, 2d Sept., 1864. Resided in Newport, Me.

Nehemiah C., b. 18 Aug., 1828, at Milton or "Wilton," N. H. Enlisted from Haverhill, Mass., 6 May, 1862, in Co. M., 1st Mass. Heavy Artillery. Hon. discharged 12 Nov., 1865. His brother Charles A. of Co. E, 13 N. H., Vol. Sons of Isaac and Mary (Drew) Fernald. Former m. Abbie J. Heard of Haverhill, Mass.

Oscar M., b. a. 1842. Enlisted in U. S. Navy 31 Aug., 1864, for one year. Resided in China, Me.

Owen, b. 24 Apr., 1821, s. Andrew and Mary A. (Lord) Fernald. Enlisted 14 Apr., 1862 in Co. E, 7th N. H. Vol. Inf. Honorably discharged 27 Jan., 1863 at Falmouth, Va. He m. Eliza Temple, da. Uriah of Westmoreland, N. H.

Peletiah, b. 26 Oct., 1829, s. Nathaniel and Nancy Fernald. Enlisted 11 Oct., 1862, in Co. B, 26th Me. Vol. Inf.; also in Co. F, 8th Me. Vol. Inf., 4 Jun. 1864. Killed in action near Petersburg, Va. Married and his Residence was at Searsport, Me.



L

PHILEMON H. FERNALD, b. a. 1845. Residing at Livermore, Me. Enlisted 28 Dec., 1863 in Co. G. 30 Me. Vol. Inf. and d. 2 Oct., 1864.

Robert, b. a. 1842. Residence, Boston, Mass. Enlisted 26 June, 1861 in Co. B. 12 Mass. Vol. Inf. Killed at Antietam, Md. 17 Sept., 1862.

Roy L. Fernald, b. 21 Jan., 1875 at Winterport, Me., s. Capt. Albert E. and Abbie H. (Colburn) Fernald. Enlisted in the 7th U. S. Inf. for Spanish American War. Wounded at El Caney. Commissioned as 2d Lt. of 26th U. S. Vol. Inf. 12 July, 1899. At the fight near Dunsangas Island, 5 June, 1900, he was specially mentioned for distinguished bravery and proved worthy son of a "Medal of Honor" soldier. He died a noble soldier's death while carrying out orders, official, on the 1st of Sept., 1900. "When with a detail of men while fording the Jalam River being about ten feet in advance of his men, his horse in the swollen river stepped beyond its depth and sank. Lieutenant Fernald sprang from its back towards the shore, but the river being high and its current swift and encumbered as he was, the task was Herculean and he sank when within a few feet of the shore." Thus in the prime of noble manhood gave freely his life for the Country he loved so well to be mustered into everlasting life, by the GREATEST COMMANDER GOD.

Samuel, b. a. 1838. Enlisted in Co. I. 2d Minn. Vol. 30 July, 1861 and d. Keokuk Io. 21 July, 1862, b. at Me. Enlisted at Red Wing, Minn. Buried at Oakland Cemetery.

Samuel H., b. 29 Apr., 1829. Enlisted in Co. K. 12 Me. Vol. Inf. 16 Nov. 1861. Wounded on "Constitution." Hon. discharged 17 May, 1862. Left Fortress Monroe for home.

Samuel Fernald in Capt. Chase Co. Col. Clarke's Regt.

Simon, b. at Kittery, s. Ensign Joshua and Lucy (Wingate) Fernald served through 2d War with England; his father served through the American Revolution and gr. fr. Capt. Lord's Blue Troop of Horse, in the French wars, and two of his sons, Charles F. and Frank S., in Civil War. He lived at Eaton, N. H. Private in Capt. John Marsh Co.

Simon, h. at Kittery, Me., 1841. Enlisted in Co. G, 27 Me. Vol. Inf., 30 Sept., 1862. Hon. Discharged 17 July, 1863, m. Mary Duncan, had Edward L. and Walter L. Fernald.

Simon M., b. at Ossipee, 30 Jan., 1834, s. Joseph, enlisted in Co. G, 35 Mass. Vol. Inf., 4 Aug., 1862. Hon. discharged 30 Oct., 1862 for disability. Resided at Haverhill, Mass.

Stephen, b. 11 Jun., 1826, s. Alpheus, s. Hercules. Resided at Newfield, Me. Enlisted in Co. K, 27 Me. Vol. Inf., 15 Oct., 1862. Hon. discharged 17 July, 1863, d. at New Haven, Conn., 17 Feb., 1872, m. Matha Lewis, 17 Nov., 1836, at Newburyport.

Steven L., s. Edmund and Betsey Fernald. Enlisted in Co. K, 51st Mass. Vol. Inf., 4 Aug., 1862. Hon. Discharged 27 July, 1863. In 22d Co., 4th Heavy Artillery, 1864 to 1865. Residence, Mendon, Mass. His bro., Sergeant Thomas was killed at Antietam, Md. His bro., Wm. H., was Private in Co. A., 36 Mass. Vol. Inf., d. Feb., 1864, and buried at Camp Nelson, Jessamine Co., Ky.

T. Fernald, m. Enlisted 7 Aug., 1863, in Co. C. 1st Me. H. Artillery. Hon. Discharged 11 Sept. 1865. Age 22, Residence, Belfast, Me.

Theodore, b. a. 1833. Residence, Boston, Mass. Enlisted in Co. C, 1st Mass. Vol. Inf., 27 May, 1861. Hon. Discharged 31 July, 1861, at Fort Albany, Arlington, Va.

L

THEODORE, b. 31 Aug., 1797, s. David and Esther Tucker (Leach) Fernald. Appointed Acting Boatswain in the Navy 15 March, 1836. Ordered to the Norfolk Navy Yard, did not report. Ordered to the Sloop, Boston 28 May, 1836. Resigned 6th Oct., and d. at Portsmouth, N. H., Nov., 1836, m. 6 Jan., 1828 to Lydia Adams, b. at Newington 15 Aug., 1799.

Theodore, s. Capt. Edward and Mary Fernald, was Lieutenant in the Revenue Maine Service and stationed in Southern Waters in 1840. Left Service and went to South America. Who will continue these records?

Thomas, in Lt. Capins Co. Col. Nichols Regt. from Sept. to Oct. 1814. Service at Portland, Me. Thomas, in Sergeant Charles Gardners Detachment from Lt. Col. Paul Merrill. Regt. of Newburyport. These detachments to serve one week each at Plum Island, 26 July to 2d Aug., 1814. This Thomas, s. of Thomas and Mirableh (Black) Fernald. His father a Rev. Soldier Thomas, in Sergeant Masons detachment.

Thomas C., b. at Dixfield, Me., s. Edmund and Betsey Fernald. Enlisted in Co. K. 15th Mass. Vol. Inf. 1 July, 1861. Kil. at Antietam, Md. 17 Sept., 1862. Resided at Blackstone, Mass.

Thomas C., b. at Portsmouth, N. H., 28 Oct., 1810, s. James Brown Fernald and Anna (Clark) Fernald. Enlisted 7th Jan., and mustered in 18th Feb., 1862 in Co. G. 72 Ohio, Vol. Inf. Hon. discharged 10 June, 1864. His father was in War of 1812-15. His nephew Thomas C. served in the Civil War. Thomas C's. two sons, Thomas Charles and George W., served in the same Co. o 13th Minn. Vols. in the Philippines 1898.

Co. G. Ohio, Vol. Inf. Civil War was commanded by Capt. James Fernald, s. of 1st named, Thomas C. (b. 1810) and in same Co. was bro. Elisha and Fr. Thomas C. This is the first instance known to two writers where the father and son served as privates throughout the war with another son and brother their commanding officer.

Thomas Charles, s. Thomas C. and Mary A. (Mills) Fernald. Enlisted March, 1895 in Minn. Natl. Guards, also in 13th Minn. Vol. Inf. 28, April, 1898. Promoted to Sergeant and mustered out with the Regt. at San Francisco, Cal. 3rd Oct. 1899. Served in Philippines and bro. George Wallace Fernald served in the same Co. and Regt.

Timothy E., b. at Northwood, N. H. 25 June, 1823, s. Timothy and Mary (Osgood) Fernald. Enlisted in Co. C. 15th N. H. Vol. Inf. 13 Sept., 1862. Promoted to Sergeant and Hon. discharged 13 Aug., 1863. Residence Enfield, N. H.

Timothy, b. 24 Aug., 1831. Enlisted in Co. K. 17th Me. Vol. Inf. 7 Aug. 1863, also served in 1st and 3d Me. Vols. his ancestry given as Nathl., Nathl., Pelatiah, Nathl., Nathl., Samuel and Dr. Renald Fernald.

Tobias A., b. 30 April, 1840. Enlisted in Co. K. 22 Me. Vol. Inf. 10 Oct., 1862. Hon. Discharged 8 Jan., 1863. Residence Newport, Me. Reported as having died in the Service is not verified.

True O. Fernald, b. 2 May, 1815 at Northwood, N. H., bro. Timothy E. Enlisted 24 July, 1862 in Co. C. 11th N. H. Vol. Inf. Wounded severely 12 May, 1864 at Spottsylvania, Va. and Hon. discharged 12 May, 1865.

Warren Fernald, b. at Kittery, Me. a. 1838. Enlisted with bro. Simon in Co. G. 27 Me. Vol. Inf. 30 Sept., 1862. Hon. discharged 4 Jan., 1863 (Malaria.) He m. Margaret Jenkins and had Carrie, Cora, Marcia, Daisey, Flora, Ralph, Everett, and George.

WILLIAM, b. 3 Dec., 1780, s. Mark and Martha Fernald. Enlisted as seaman in Navy. Captured and died in Dartmouth Prison, Eng. 10 June, 1815. Resided at Kittery: m. Abigail Stevens of Portsmouth 14 June, 1804. His widow Petitioned 2d Session, 15 Congress for a Naval Pension: at 1st 16th Congress: again Petitioned. Not granted, probably from lack of proof. There is no question of his Service, Capture and Death. His father served in the American Revolution, and was later Commissioned as Lt. in the Navy."

William Fernald, b. 27 July, 1796, s. William, b. 1757 and wife Molly (or Mary Colby? Hammond) Fernald, s. Col. Tobias, s. Deacon John and Sarah (Hinckes) Fernald, s. Dr. John and Mary (Spinney), s. Thomas and Temperance (Washington) Fernald, s. Dr. Renald and Joanna (Warburton) Fernald, s. Capt. Wm. and Elizabeth (Amand) Fernald, s. Dr. John and Annetta (de Coligny) Fernald, s. Francis and Maria (Commenius) Fernald, s. Dr. Jean Fernald and wife Magdalene Luillier, s. Charles VIII and Anne of Britiany: "It is said was a Soldier in the War of 1812-15 but I have been unable to verify the statement," declared Mr. Henry W. Fernald. I have his wooden Canteen with his name marked on it in initials W. F. in War 1812. Then written records (of Wm. Fernald fought Invincible Spanish Armada, Act. 15 or 13) written on paper attached to the wooden Canteen by red sealing wax. A quaint article.

William, b. 7 April, 1796, s. Daniel and Hannah (Manson) Fernald, served as Private and was stationed at Fort Constitution. (See plate) at Portsmouth Harbor, in 1812. He m. 3 Dec. Abigail Barry, had William F., Lucy and Albert H. Fernald.

William, b. 4 Dec., 1821. Enlisted in Co. H. 2d Mass. H. Artillery, 17 Sept., 1864. Discharged 26 July, 1865. He was s. of James and Nancy Fernald of Lebanon, Me., and brother of Eli of the 1st N. H. Vol. Inf., m. 1st Nancy Mason, 2d Sarah Fay. Died at Springfield, Mass. 28 Nov., 1896.

William b. 1840 at Greenwich, Conn., 6 Aug., 1862. Enlisted at Stanford, Conn., in Co. B. 17 Conn. Regt. Captured 19 May, 1864, at Welakin, Florida. Parol. 14 March, 1865, and d. six ds. later leaving widow and two children.

W. E. Farnell. Enlisted in Co. D. 15th Me. Vol. Inf. Died in service and buried at Beaufort, S. C. Natl. Cemetery. Section 20, No. 151.

William A., b. at South Boston, Mass., s. Nathaniel and Margaret Ann (Foss) Fernald. Enlisted in 3d Mass. Battery 10 Sept, 1861. Hon. discharged 16 Sept., 1864: died in Melrose, Mass., July, 1891.

William G., b. 8 Dec., 1840 at Houlton, Me., s. John and Joanna (Allein) Fernald. Enlisted in Co. K. 1st Me. Vol. Inf. 1 Sept., 1862 as Hospital Steward. Promoted to Assistant Surgeon 30 Jan., 1864, m. at Atlanta, Ga., 8th Jan, 1873. Had Tallalak, b. 20 June, 1874, and Frances. He was not mustered in as Assistant Surgeon.

"William H. Enlisted in Co. A. 36 Mass. Vol. Inf. 3 Aug., 1862. Discharged 30 April, 1864 at Halls Gap, Ky., s. Edmund and Betsy Fernald and bro. of Stephen L., and was the W. H. Fernald who d. Feb., 1864, and was buried at Camp Nelson, Jessamine Co., Ky."

William H., b. a. 1830, of Bakersville, Me. Enlisted in U. S. Navy, 30 July, 1863 for three years as Substitute for Isaac Flint. Another Record declared enlisted 11 Nov., 1864. There was another William H., who enlisted in the Navy, date unknown to me, residence St. Albans, Me.





WILLIAM (H) FERNALD, b. 8 March, 1823, s. William and Lydia (Clements) Fernald, brother of aforesaid Joseph of Medford, Mass., that wore the Oak Leaf of Fort Fisher, b. at Durham, N. H. Residence at Peterborough, N. H. Enlisted in Co. G. 2d N. H. Regt. 24 May, 1861. Discharged 21 June, 1864. He was named William and his bro. who d. in infancy was called Wm. Henry, as I copied from Mr. Joseph Fernald's mammoth Bible at 8 Hastings Lane, Medford, Mass.

William H. H., b. at Charlestown, Mass., a. 1833. Enlisted in Co. I. 12th N. H. Regt. 15 Aug., 1862. Appointed 1st Lieut. 8 Sept., 1862. Promoted to Capt. 4 May, 1863.

William H. H., b. a. 1841 at Barrington, N. H. Enlisted in Co. G., 8th N. H. Vol. Inf., 27 Dec., 1861. Promoted to Corporal: wounded 14 June, 1863 at Port Hudson, La. Reinstated 4 Jan., 1864. Transferred to Co. B. Veteran Battalion 8th N. H. Vol. Inf., 1 Jan., 1865. Discharged 24 June, 1865. Died at Dover, N. H., 28 Oct., 1865.

William L., Enlisted from Me. in the U. S. Engineers, 4 Jan., 1864. Transferred to Veteran Reserve Corps.

Lieut. A. E. Fernald, 30 Sept., 1864 in Front of Petersburg, People's Farm. The Confederate strong line of earthworks, well manned by infantry, and a Four-Gun Fort in a very formidable position commanded the road and field, across which our Brigade charged in the face of grape and canister at close range, firing their last volley into our faces, killing many and riddling our flag. The terrific Spartan charge drove all before except the Fourth Cannon captured by Lt. Fernald who in advance of his command dashed through an opening in the Fort commanded the men to Halt! They hesitated till presentation of a revolver aimed at Drivers head enforced it. Fire was opened on Lt. who held the prize. A Mass. Officer was second on spot, and attempted to claim the honor for his Regt. unsuccessfully. Lt. A. E. Fernald held his own for "Uncle Sam."

CAPTAIN FERNALD, at Five Forks, during the supreme moment of the conflict, rushed in and captured the rebel Flag. Previously Morrison, Gilmore, Hickey and the slight built young man dashed on to capture the Flag, were surrounded by about 400 foes: they formed a square, fought, pounded their way through reaching clear space and the enemy poured a volley into them. Morrison jumped high in the air and fell dead, Gilmore sank on ground as if dead, Hickey reeled and staggered the fourth reached and joined his Regt. Genl. Sheridan captured 5000. Morrison was shot through the body, Gilmore two balls through the heart. Hickey slight injury. Two shallow graves beneath a great Oak Tree rest their remains.

At Hatchers Run a Confederate Sergeant South Carolina Regt. after all his comrades had fled, gathered up their rifles, took his stand behind a tree in angle of Fort. The stream was deep, and crossing on fallen trunk of a tree. Seven Union soldiers sprang upon the log to cross and fell. The Surgeant was shot from tree top, buried in fort and his effects sent to friends in S. C. Graves marked by heroic deed.

Dr. G. F. Walker, Med. Director of Dept. Mass. and Natl. Med. Direct. of L. S. U. V. U. Vt. Vet. Association, 483 Beacon St., Boston, Mass., courteously supplied information relative to Lt. A. E. F. and Captain Fernald with Mass. at large see "Gerrish—Reminiscences of the War."



F

Pl. 1346.

Chapter XVIII.



Pl. 1347.

The primitive alphabet Banner is Monogrammic. Sent to THE HAGUE in 1907, American Delegates, opposed by Pope and Vatican.

It is in the power of all men to preserve their probity; no one is powerful enough to preserve reputation while there are so many evil tongues ready to blast the fairest character, and so many open ears ready to receive their reports.

The opinions of men are as many and different as their persons. The greatest diligence, and most prudent conduct can never please them all.

No man is wise or safe, but he that is honest. Sir W. Raleigh.



Plate 1348. Peter Faneuil: His ships in Boston Harbor. He was a man of virtue, an honor to his country, a glory to humanity, a satisfaction to himself and a benefactor to the whole world. He was rich without ostentation, courteous, without deceit and brave without vice. Patriotic. Those who secretly and cowardly insulted his tomb and U. S. Flag Rob Nations.

Crest of Coat of Arms Declares GOD King of Kings. Our Universal Commander-in-Chief.

A wise man is provided for occurrence of any kind; the good he manages, the bad he vanquishes; in prosperity he betrays no presumption, in adversity he feels no despondency.

To be perfectly just is an attribute of divine nature; to be so to the utmost of our abilities, is the glory of mankind.

When Alexander heard any one accused he would stop one ear with his hand, thereby reserving audience for the defendant.

There is a heroic innocence, as well as a heroic courage.

Comines said that good sense which nature affords us is preferable to most of the knowledge that we can acquire.

Fidelity and truth is the foundation of all justice.

It is a Spanish maxim that he who loses wealth, loses much; he who loseth a friend, loseth more; but he that loseth his spirits, loseth all.

The defending a bad cause is worse than the cause itself. . . . To delay justice is injustice. Not to have a right, and not to come at it, differ little.

The greatest of all injustice is that which goes under the name of the law; and of all sorts of tyranny the forcing the letter of the law against the equity, is the most insupportable. Sir R. L'Estrange.



RECORD NOT MADE LAWS LIKE SPIDER webs, that catch the small flies, but let the great ones break through. THE GREAT CICERO complained, that many worthy ordinances were settled by laws; but those, for the most part, were corrupted and depraved by lawyers' inventions.

There are many laws made by men, which swerve from honesty, reason, and the dictates of nature. By the law of arms, he is degraded from all honor, who puts up with an affront; and by the civil law, he that takes vengeance for it incurs capital punishment. He that seeks redress by the law for an affront, is disgraced; and he that does not seek redress in this way, is punished by law. This wrong only excelled by Boston, Divorce laws of 1896 which justice was made injustice by protection of the criminal for saving a Bishop, one representative, three Drs., and 3 Attys., 37 killed with three attempts to involve U. S. in a war defeated, cities larceny, continual upholding of the proved criminal in crimes all nations righteously punish and good abhor.

Let our watchword be dispatch and practice what we preach and that for exigencies of the time.

Parmenio, a friend of Alexander, hearing the great offers Darius had made, said, "Were I Alexander, I would accept them." "So would I," replied Alexander, "were I Parmenio. Many speak ill, because they never learned to speak well.



ILL.
PLATE 1349.



PLATE 1350.
Arms of Peter Faneuil



PLATE 1351.

HAGUE! WITH YOU IN MOST WISE, RIGHT-EOUS ACTIONS IS OMNIPOTENT GOD, and all the best of earth.

It was the wise saying of a certain Prince that we must dispense justice in small matters in order to keep it pure justice in great ones. OUR THREE GREAT LAWS PREVENT THE EVIL THAT HAS CAUSED THE DOWNFALL OF STATES AND NATIONS FOR THEY ARE THE COMMANDS OF DIETY OMNISCIENT.

It will be observed that Peter Faneuil, or Funal, or another way of spelling Fernald has one less star on his coat-of-arms than on his tomb. For like Abraham of old he counted ancestors by the stars, and they were: Rev. Peter, Rev. Daniel, Rev. Francis, Dr. Jean Fernel, Charles VIII and Louis XI of France.

Is judgment the throne of prudence and silence its sanctuary?

It is much better to reprove than to be angry secretly.

When Darius offered Alexander 10,000 talents, to divide Asia with him equally he answered: "The earth cannot bear two suns, nor Asia two kings."



PLATE 1352. Rev. Peter Faneuil and his signature is above. Fr. of P. F.



PLATE 1353. Rev. Daniel Faneuil, the Father of Rev. Peter Faneuil.

FOR Peter Faneuil Universal Genealogy Monument Fund

God's United States and Foreign Alliance:

Unto the Nations in Purity;

INTERNATIONAL



IN HONORARIUM

AN APPEAL FOR CONSTITUTIONAL JUSTICE

PLATE 1364

/ **It will be** whereof the said President & Council have to the one pt of this great Indenture set their seals • And to th other pt hereof the said John Parke in the name of himself and his said Associates have set to his seal given the day and yeres first above written /

Isaac *Stanton*

John C. Corcoran *John C. Corcoran*

John C. Corcoran Secretary to Foreign Agent
Fernald by Associates

Plate 1360

O. K. K. I. X. & P. G. A. V. T. OF STRENGTH OVA.

Plate 1361

REJOICE AND BE GLAD FOR GOD AND NATIONS ARE WITH US! THEREFORE WE SHALL TRIUMPH!! WITH EVERY OBSTACLE TO OPPOSE ENACTMENT BY THE POES OF ALL LAWFUL NATIONS FOURTEEN YEARS HAVE OPOSED US AND THEY ANNUALLY GROWING WEAKER NOTWITHSTANDING THEIR MONEY & INFLUENCE.

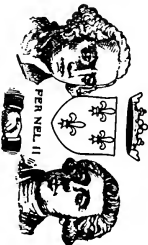

Plate 1365. Fernald Coat of Arms



Plate 1367

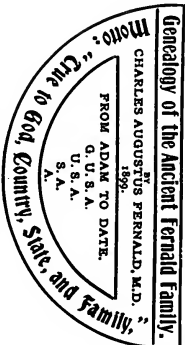

Plate 1366. Transferred from an old Chart.



Plate 1368

Henry VIII Cal. Roman. The
Fertile seedling of this is
very strange and unusual.
Vide the U.S. Cal.

Plate 1369

William Phelps *Bellmont*
W. Dudley *Sam'l Shute*
W. B. Baker *A. Bennett*
Whitney *Bernal*
Whitcomb *Fra. Bernard*

PLATE 1364.

William Bradford *Thos. Deane*
Jos. Benson *Walter M. Weston*
William Brewster *Thomas Cuyler*
Nyles Standish *Fox Wyllow*
Joac. F. Weston *Constable Southworth*
John Bradford *Thos. Southworth*

PLATE 1365.

James Keely, 131 Bet St.
Amos L. Hatheway, Attorney at Law 10 *Trumost St*
Francis Juggins, Attorney at Law 10 *" "*
Quarrel A. Haly, *" "*
Lester W. Ingram, *" "*
Charles A. Jewell, *" "*
John X. Lyon, Real Estate *" "*
J. H. Allen, Attorney at Law *" "*
Thomas F. Egan, *Clerk* *" "*
Robert H. Sumner, Atty. at Law *" "*
Wm. L. Seavey, Atty. at Law

PLATE 1366. Signers of Our Three Laws.

Let reason go before enterprise, and counsel before action.
 Rest satisfied with doing well and leave others to talk about you as they please.
 Always take part with, and defend the unfortunate.
 In the morning think of what you have to do; at night what you have done.

SEE NAMES WE HONOR. FOR THEIR GOOD DEEDS, PERPETUATE!

There seems to be so near an affinity betwixt wisdom, philosophy, and good counsels, that it is a matter of curiosity more than of profit to divide them. Seneca.

Those who start for human glory, like the mettled hounds of Actæon, must pursue the game not only where there is a path but where there is none.

There are two things which ought to teach us to think slightly of human glory; the very best have their calumniators, the very worst their panegyrist.

It is an insult to an honest man to force on him a loud ringing ticket punch to prevent self-respect by announcing he has not stolen that ticket. Boston El. Cars.

Think before you speak, and consider before you promise. Take time to deliberate and advise; but lose no time in executing your resolutions.

Never expect any assistance or consolation in your necessities from drinking companions!

OUR GOOD DEEDS Bless Others and cast a halo of Dignity and Grace around and U. S.

Good counsel is cast away by the arrogant, the self conceited and the stupid; who are either too proud to take it, or too heavy to understand it. Sir R. L'Estrange.

The martyrs to vice far exceed the martyrs to virtue, both in endurance and in number. So blinded are we by our passions that we suffer more to be destroyed than saved.

It goes a great way towards making a man faithful to let him know that you think him so: and he who suspects that I will deceive him, gives me a kind of right to cozen him. Seneca.

Classmate Adams can be a general of Gibraltar, Consul of Sicily, a Caravan, or Vice Consul of Uruguay

Joseph Morgan, Consul for Cuba
W. L. Williams, Vice Consul of Santiago & Bogota
Philip Williams, Consul of Santiago & Bogota
Joseph Williams, Consul of Bogota



PLATE 1371. TO HONOR. 1876-1877

W. L. Williams, Vice Consul of Santiago & Bogota
Philip Williams, Consul of Santiago & Bogota
Joseph Williams, Consul of Bogota

CERTIFICATES have been issued to the following FOR PEACE ON EARTH AND GOOD WILL TO ALL:—America, Argentine Republic, Austria-Hungary, Belgium, Brazil, China, Costa Rica, Cuba, Denmark, England, France, Germany, Greece, Italy, Liberia, Mexico, Netherlands, Nicaragua, Norway, Peru, Portugal, Spain, Sweden, and Venezuela.

T. W. F. ...

NOT THAT WE ARE SUFFICIENT OF OURSELVES TO THINK ANYTHING AS OF OURSELVES: OUR SUFFICIENCY IS OF GOD: but even unto this day, when Moses is read, the veil is—upon their hearts. Which it shall be taken from opponents that stole 1909 Rolls of Hon. signatures by 22 consulates and others.

Stephen M. Nickerson, Imperial Chinese Consul

Charles K. Adams, Consul of Gibraltar

S. S. Smay, Consul of Santiago & Bogota

Stephen M. Nickerson, Imperial Chinese Consul



Stephen M. Nickerson, Imperial Chinese Consul

Imperial Chinese Consul

Imperial Chinese Consul

(12 years) (Name 2 yrs in Am) PLATE 1373. MOST ILLUSTRIOUS HONORING NATIONS SIGNATURES REPRESENTING 141,171,381 people acknowledging our genealogy, history new data true: for our three great moral reform. God's laws and commands. With only 138,828,619 requested to join us for universal good. All brothers! We From Ava and Adam, Our Mother and Father.

Imperial Chinese Consul

Imperial Chinese Consul

Imperial Chinese Consul

Imperial Chinese Consul

Imperial Chinese Consul

Imperial Chinese Consul

Imperial Chinese Consul

Imperial Chinese Consul

Imperial Chinese Consul

PLATE 1374

PLATE 1372. HONOR THOSE TO WHOM IT IS DUE.



PLATE 1381.
Arms.

GOD giving me the power I fight till we are triumphant.

If compatriots, the honorable Attorneys, of our vow; that my health and pecuniary means fail in completion of this printed book! I, as agreed, leave for you result of 54 years work as aid to its triumph.

With the story of a world made to save from those men, created images, that pretend they are the chosen lights to show and are teaching the way but walk to destroy HIS children by that evil which is ever the fore runner of NATIONAL RUIN.

FOR Peter Faneuil Universal Genealogy Monument Fund



God's United States and Foreign Alliance:

IN HONORARIUM

Unto the Nations in Purity;

INTERNATIONAL

FROM THE PETITIONS OF
HONORABLE PATRIOTS

AN APPEAL FOR CONSTITUTIONAL JUSTICE

WITH C. A. FERNALD, M.D.,
PRINCIPAL OF G.U.S. & F.A.



for Righteousness, Purity,
my God given power and hand,
Charles Augustus Fernald, M.
D., Principal of God's United
States and Foreign Alliance:

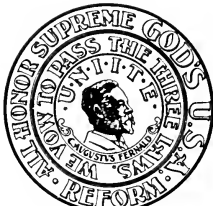

PLATE 1380. Our Vow, around a caricature of my face, made by Suffolk Eng. Co. of foes to State and Nations, God, Churches, Purity and Virtue. Faithfully I have kept my Word and Vow.

Zechariah VI, 12-15. "Thus speaketh the Lord of hosts, saying, Behold the man whose name is the BRANCH; and he shall grow up out of his place, and he shall build the Temple of the Lord. And they that are far off shall come and build in the Temple of the Lord, and ye shall know the Lord of hosts hath sent me unto you. And this shall come to pass, if ye will diligently obey the voice of the Lord thy God." One thousand and one have subscribed their names for building Universal International Genealogy TEMPLES or MONUMENTS representing 1,160,000,000 people, and FOR ENACTMENT 1,411,171,381. See U. S. Congress Document 190 read and act for Liberty and Right, Honor and Charity.

5810 A. M., B. C. MAN, 4376,
LIGHT 5397, B. C.
TRUE DATES,

Thursday, 3 Dec., 6284.
UNTO LAWFUL RULERS;
Cordial Courteous Greetings:

On to the HAGUE and all Legislative assemblies for Enactment of our three Laws in one, Isaiah's, God's Commands to hold in reverence. Our honor maintain in the solution of the problem of Nations, most honoring you by conferring the greatest blessings upon all others? Thereby recipients of the greatest one "it is more blessed to give than to receive." WHEREOF UNTO GOD GIVETH GRACE, POWER; I affix name, dates and Seal by

Encyclyia Universalis Americana; xx.

UNTO

Hon. Legislators; For God's Commands and our Constitutions. ISAAH, Chap. LI. v. 4 & 7 "Hearken unto me, my people; and give ear unto me, O my Nation: for—LAW(S) shall proceed from me, and I will make my judgment to rest for a light of the (1,411,171,381) people. Hearken unto me, ye that know righteousness, the people in whose heart—(are) my law(s); fear ye not the reproach of men, neither be ye afraid of their revilings." Enactment is national safety, removing cause of the downfall of God's nations. "Thou shalt not kill."

Return to godliness all ye corrupt of 360 churches, whose best is derived from the Primitive Church of God. And corrupt managers ordered three protestant ministers to refused to sign against crimes; "as we will be removed not want for bread;" Roman Catholic Jesuits and others refused from Order of Pope and Vatican. ← Nations clean sweep from all office the corrupt by Justice' sword. Save yourselves and them!



REAT WISDOM IS SHOWN BY ALL GOVERNMENTS THAT OUGHT TO ASPIRE TO PRODUCE THE HIGHEST happiness by the least objectionable means. To produce good without some admixture of ill, is the prerogative of the DEITY alone. In a state of nature, each individual would strive to preserve the whole of his liberty, but then he would also be liable to the encroachments of others, who feel equally determined to preserve the whole of theirs. In a state of civilization each individual voluntarily sacrifices a part of his liberty. to increase the general good stock. It may be said in respect to the goods of this world, that Parsons are preaching for them—Lawyers are pleading for them—Physicians are prescribing for them—Authors are writing for them—Soldiers are fighting for them—but, that true Philosophers alone are enjoying them. NO destruction of NATIONS! Be our war cryor to pass our 3 LAWS.

FOR WRONG* DIPLOMACY** THE FREE UNIVERSAL CHOICE*** WISDOM FOR RIGHT****

"Huguenot Emigrants to America, pr. Chas. W. Baird, N. Y., 1885. Vol. 1, p. 28. Faneuil fam. of La Rochelle per M. Louis Marie Meschinot de Richmond archiviste, etc.

Benjamin Faneuil, b. 1593. d. 1677: m. Susanne de L'Espine 1616: 2d Pierre, b. 1618, d—m. Marie Cousseau 1640; 3d Benjamin, b. d. 3d Pierre, b—d—m. Marie Depont. Faneuil family arrives in Boston from London by Autumn 1688. Gabriel Berusa, arrived 5th July, 1688, where he settled with his connections Benjamin and Andre Faneuil. 3d. Pierre 4th Jean, b. d. in La Rochelle, 24 June, 1737. 4th Andre, b. d. in Boston, 13 Feb., 1737. 4th Benjamin, b. Sept., 1668; d. in N. Y. 31 March, 1719, Aet. 50 years, 8mos. m. Annie Bureau, 28 July, 1699. 4th Susanne, b. d. m. Abraham de La Croix. 4th Jeanne, b. d. m. Pierre Cossart. 4th Benjamin.

"5th Peter, b. July, 1700: d. Thur., Mar. 3, 1743." Noble form, beautiful features, perfect typical Roman, like King Pepin.

"Peter Faneuil—A fat corpulent brown squat man, hips short and lame from childhood. Notes on a copy of Dr. Wm. Douglass' Almanack for 1743, by Saml. S. Abbott Green, M.D. Notes 2, ditto, Peter Faneuil, Esq, between 2 and 3 o'clock in the afternoon died of a dropsical complication (In my opinion a great loss to this town Aged 42-8 m.) and I think by what I have heard has done more charitable than any man yet ever lived in this town for whom I am very sorry.

For Right!!

Peter Faneuil's ancestor Louis XI., King of France, (but XII. counting a Louis not a king found in one Record) had his body removed from the grave and insulted by the Huguenots, as he, an honorable man was not protected, but made a persecuted dupe and tool of Roman Catholic Church.

Charles VIII., quarrelled with Pope and with Chn. except Jean, killed by poison, after Dr. Jean and wife, Finally Peter Faneuil poisoned by Antimony! No signature on the alleged gift to City of Boston, of Faneuil Hall and Market.

Latin Phanuel = $\odot - \odot \Delta \diamond = \text{פִּנְאוּל} = \text{פִּנְאוּל}$
Faneuil, = "Peniel and Penuel" in Genesis Chap. XXXII. Verses 30 and 31 in English and 31 and 32 in Hebrew Bibles. The points were interpolated erroneously in the Hebrew changing F. to P., therefore the Heb. is FNFAL which is the same spelling in the ancient Egyptian.

PETER FANEUIL TRUE ANCESTORS FROM THE CYPHER. UNCHANGED WRITINGS ON HIS TOMB!! & RECORDS!!! Louis XI. Fr. of Charles VIII., Fr. of Dr. Jean Fernel, Fr. Francis Junius Fernal, Chaplin, Atty Warrior, the Fr. of Rev. DANIEL Jureau Fernel, m. Mary de Moulin, b. 22 March, 1583, m. 1 June 1600

Had descendants: Rev. Peter Jureau Funal, b. 24 December, 1637 at Mer. Blois, where his fr. was minister of the reformed religion—Taught in part by uncle Peter de Moulin, who was in England, ordained: Prof. Hebrew at Sedan called Protestant Goliath: 1681 retired to Holland, and divinity Prof. of Rotterdam and minister of Walloon Church, as gr. fr. was before him: persecuted and d. a martyr 1713 at Rotterdam: m. chn.

Anthony Dodine de Haute Forre, Atty. b. 1602, d. 1682. Francisco Furini, b. 1604, And 12 daughters, m. Lewis Charles John Francis Jureau Funel, b. 13 May, 1632, m. Joan Henault (thus keeping ancestral foreparents names) Had:—Charles John Francis Henault, b. at Paris 8 Feb., 1685, d. 24. Dec. 1771. He was 7th child and adopted as his own his sisters three sons and 2 das. that were all well married.

Sixteen, Rev. Peter Jureau Funal, above, m. Susanna Fernald da. John and Mary, 1657: Had Twelve children: 1 Charles, 2 John, 3 Annie, 4 Francis, 5 Magdalene, 6 Anne, 7 Parker Jureau Funel, m. Gen. Zebulon Pike. Emanueil, 8 Rachel, 9 Daniel, 10 Peter, b. 20 June, 1700, d. s. 3 March, 1743 at Boston, buried Old Granery Cemetery. (Adopted Benjamin and Andrew) 11, Marv, 12, Joanna Sarah, 13, Susanna m. La Croix. THOSE THAT GOD HONORETH MAY THEY ALL HONOR THEMSELVES BY AGGRANDIZING.

L

INE OF JOHN THE SECOND SON OF DR. JEAN FERNEL THAT WAS BORN THIRD OF FEBRUARY, 1535, married ELIZABETH, (da. Sir Richard Berkley and wife Elizabeth, da. Sir William Read, of Gloucester: Sir Richard was son of Sir John and Isabel da. Sir Wm. Dennis: Sir John, s. Sir Richard and Elizabeth, da. Sir

Humphrey Coningsby:) 1 Jan., 1552: 2d m. Mary (Washington) Arden: Had descendants—John Fernel, b. 31 Dec., 1552, m. Anne, b. 29 Nov. 1553, m. Magdalen, b. 5 April, 1556, m. George H. U. Fagnel, b. at Antwerp 1545 d. 1600: (5 chn.), Edward, b. 17 June, 1559: Amand Tolan or Folan b. 5 Oct., 1561 d. 17 July, 1610, m. 4 chn. Francis Vanni, b. at Suena 19 May, 1563 and d. at Rome 1609, m. 7 chn. Amand Tolan or Folan b. 5 Oct., 1561 d. 17 July, 1610 m. Thomas, b. at Antwerp 23 Oct., 1566, and his wife having died 3 Sept., 1566. He married Mary, eldest da. of Edward and Mary Arden, da. Sir George Throgmorton; Edward Arden and his son-in-law Somerville, a rash, thoughtless young man, was drawn into a supposed conspiracy against the Queen's life with Hale a priest, tortures were inflicted on Arden and Hale without any evidence appearing except a letter that Arden burnt of Somerville who was strangled the night before his expected execution. Arden expired 20 Dec., 1585 amidst the tears of pitying thousands and their heads mangled placed on London bridge. The dignity of these respectable families became restored by the prudence of the two next heirs Fernels and the Fieldings, became nearly allied to the earls of Denbigh. From Collins Baronetage. p. 32 and 33 Richard, son and heir of John Isham, before mentioned, was the husband of Isabella, daughter to Drago Brudenel, or Drago Furnal Esq.: who had a rent charge of 10 marks given by her father (c) out of the manors of Chalfont St. Peter, and Burnham, in the county of Bucks. William Isham, the eldest son of Robert, before mentioned, was one of those gentlemen of Northamptonshire, to whom Richard III. sent a letter, requiring a loan of forty pounds (d) his name likewise occurs upon other accounts on the lists (e) of the nobility and gentry of the county. He married Elizabeth, daughter of (Rev. Peter Jureau or Fureau, as sometimes spelled), widow of Thomas Braunspath (f), who 20 Sept., 18 Edward IV. and he died 13 June, 2 Hen. VIII. 1510, leaving Thomas Isham, of Pichely, Esq: their son, who was about 54 years of age at his fathers death. He married Elena, daughter of Richard Vere, of Addington, Esq: (by Isabella, his wife, daughter, and at length heir to John Green, of Drayton, Esq.) and sister of Sir Henry Vere, Sheriff of Northamptonshire, 1 Hen. VII. who being the last heir male of that ancient and martial family, descended from Sir Robert de Vere, second son of Aubrey de Vere, chief Justiciary of England, and brother to Asbrey de Vere, first of the name, Earl of Oxford: his eldest daughter and co-heir, Elizabeth, became the wife of John, the first Lord Mordaunt, ancestor to the present Earl of Peterborough.

By this match there accrued to the family a very considerable alliance, and a descent in blood from those NOBLE AND GREAT HOUSES of FURNELL, de Bosco, Wake, Seagrave, Fitzwarren, Zouch, of Harringworth, Drayton, Manduit, Basset, of Weldon, ARDEN, etc. The issue that came of it were Euesby, John and according to circumstances, Henry: Henry Isham was in that unfortunate expedition of the Emperor Charles V. to Algiers, 1541 (a) with Sir Henry Knevit, Ambassador from Henry VIII. Thomas Chaloner and Henry Knolles (Knowles), and we look on him as being the same person who was of Walmer Castle in Kent, and married Anne, relict of William Scot, daughter and co-heir to Thomas Fogge, Serjeant Porter, of Calais, by whom he had Edward Isham, whose daughter and heir Mary, was the wife of Sir George Parkins (Perkins of America said to be descendants) of Bunny in Nottinghamshire, Knt. Euseby Isham, eldest son of Thomas, married Anne eldest da. of Gyles Pulton (Giles Fulton, from whom America's Fultons descend) of Desborough, Esq: and Catharine, his wife, daughter of Thomas Lovet, Sen. of Astwell, Esq: by her in one and twenty years he had twenty children; the names of ten are transmitted down to us, viz. Gyles, Robert, Gregory, John, ancestor of the Lamport line, and Henry, Catherine, wife to Richard Pagitt, of Cranford, Student of the Law, from whom descended, by eldest son, James Pagitt, one of the Barons of the Exchequer, temp. Charles I. and by Euseby, a Clergyman, old father Ephraim Pagitt, above 40 years.

F T was said and written, Rector of St. Edmond, Lombard Street, (upon breaking out of the civil war, he was forced to quit merely for quietness' sake.) Elena, first married to Thomas Hoysse, 2d. Thomas Boseworth, of great Oakley: Ely, wife to Henry Bellamy, Citizen and Mercer, of London, afterwards of Hadley, near Barnet, in Middlesex, where they lie buried: Edith to Richard Slatier of Braunston, and Isabella to Thomas Barker, Merchant, whose sister was married to his wife's brother John Isham. They trace their descent at the Norman Epoch, Azor, Azo, Hugh, Roger, Henry, Henry and Thomas, Henry, John, William, sd. Thomas, Robert, sd. Henry, had Robert, Robert, William, eldest son and Richard and John, last sd. Robt. heir to bro., and a da. named Dorothy.

The King grants, 18 Edw. IV. to John Isham, of Broughton, m. Jane, da. Robert Kynnesman, of Loddington. Richard, aforesaid first mentioned, etc., Arms: Gules, a Fess, and in chief three Piles, wavy, Argent. Crest: Upon a Torce of the colors, A Swans Neck and Breast, with Wings displayed, Proper. Motto over Crest: Ostendo non Ostento. Motto to the Arms: On things transitory resteth no glory. Seats: At Lamport, six miles from Northampton, and Shangton, in Leicestershire, four miles from Harboro.

In Aston, of Aston, Cheshire, temp. Hen. II. Thomas, son of Ernald (Fernald, probably the ancestor of Petrus Darius Fernel, the adopting father of Dr. Jean Fernel) in a clear out of ancient. The children of John and Elizabeth all married and his wife having died he m. Mary Ardern or Arden 22 June, 1569 and had Anthony Fenley or Henley b. 9 Aug., 1572, an English, whig, Senator m. da. Hon. Peregrine Bertie 1698 and had chn. He was persecuted by Tories, and d. 1711 universally lamented. His second son became Lord Northington, and chancellor of England.

John Fernel, son of above John and wife Elizabeth Berkley, b. 1552 m. Anne Bacon, da.

1581 March, 10: Had Anne, b. 12 Sept., 1583, m. Gregory Horstius, an author Dr. Prof., and called Æsculapius of Germany, he d. 1636 in Aug. at Ulm, Germany. By his first wife m. 1615 he had four sons, three physicians, John, Daniel and Gregory, authors Medical Tracts, etc., that were born after his two das. m. 2d. 13mos. before his death, as Anne d. 1634.

Bernard Frenicle, b. Oct. 11, 1585 and d. 1675: m. and had Charles du Cange; du Fresne, b. at Amiens 1610 and d. 1688, leaving four children who, for policy, were honorably pensioned by Lewis XIV. He was an advocate of the parliament of Paris: engaged in his native town in pursuit of literature and philosophy, moved to Paris, where, in 1688 he was engaged in making (engaged by Colbert?) a collection from all authors, secret and public, written on the history of France. As his labors, however, did not please the minister, as they contained too much of the truth heretofore set forth in this work, which every effort has been put forth by powerful foes to prevent, he resigned all engagements in the undertaking. He afterwards wrote a Greek Glossary of the middle ages, 2 vols. folio, also the history of Constantinople under the French emperors, and published besides, editions of Nicephoras, Cinnamus, Anna Comena, Zonarus, etc. His nephew, Charles Alphonso du Fresnoy, son of Dr. Ferneaux, b. 1611, educated him for a physician, being a surgeon. The love of poetry was superior to paternal authority, and he became a student of Perrier and Vouet, 1634 went to Rome. He wrote De Arte Graphica and d. 1665. After the poem with notes appeared by de Piles, then its excellent precepts were made known to the English by the translations of Dryden; Graham and Mason

Charles du Cange du Fresne b. 1610, m. ; had four descendants that were pensioned "for merits of father," and fifth the Eldest, Charles Rivere du Fresnoy or Ferny; Fernel, b. at Paris 1648 and died 1724, m.

Bacon, da. Nathl., s. Nathaniel, s. Sir Nicholas and Jane Fernely his first wife, who by 2d Anne Cook, left sons Anthony and Francis. A French poet, celebrated for dramatic writings, musician, painter and sculptor, and had great knowledge of gardening and was appointed overseer of kings' gardens that he sold to prevent persecutions from being a descendant of Dr. Jean Fernel. Courteous France can supply the 4 other children.





IVEN to his first son PHANEUIL BACON FERNEL, who doubtless is the same Phaneul Bacon that is recorded in the "Universal Biography" by J. LEMPRIERE, printed at London, 1808, who was born , died at Baldon, Oxfordshire 2 January, 1783: m.

He graduated at Magdalen College, Oxford. Took his degree 1735 as D.D. Rector of Baldon. Wrote five plays published in 1757; an elegant poem, "The Artificial Kite," printed 1719, and inserted in the Gentleman's Magazine, 1758; and he was admired for the ready flashes of his wit and for his punning. His gt. gt. gr. fr., Sir Nicholas Bacon, keeper of the great seal under Queen Elizabeth, succeeding Archbishop Heath of York; he was of Corpus Christi Col., Cambridge, o which he became a munificent benefactor, and after traveling in France he studied law at Gray's Inn. He was employed under Henry VIII. to whom he proposed a plan, which, however, was never adopted in England (but has been in Boston by Jesuit Col.) for the erecting a College to instruct young statesmen in all the branches of political knowledge; probably the wise foresight of King Henry VIII., saved England from suffering from the like political corruption which has stolen about \$125,000,000,000.00, when justice has been given by our courts for the righteous acknowledged claim against the city in the Commonwealth of Massachusetts whose Sovereign state has witnessed the great wrong that soon ceases or will be settled, by civil war—the curse of all nations from indifference to its commonweal. Jane Fernel (ey and cy,) added to her namo, as I found), has properly enough been claimed as as a descendant of Dr. Jean Fernel, whose three das, names unknown to me, and three sons, viz. Nicholas, Nathaniel, and Edward; also from his 2d wife Anne Cook, da. 2d of Sir Anthony Cook (sd. to be ancestor of Cook who owned Farm at Wolfboro, Centre, N. H.) preceptor to King Edward VI. worthily succeeded the incomparable lady Jane, for she too was eminent for her learning, piety and virtue. She continued and completed the translation from the Italian into the English Oehines sermons, and Jewel's apology for the Church of England from the Latin: and died about the beginning of the reign of James I at Gorchambury near St. Albans. Lady Anne had Anthony, and Francis named for Francis Junius Fernel the son of Dr. Jean Fernel. The worthy husband of these perfect wives died the 20 Feb. 1579. He was buried at St. Pauls, and his monument was destroyed by the great London Fire of 1666. As it has been frequently been asked when and where was Dr. Renald or Reginald Fernald appointed a Lieut I may here repeat again—Item. Collins' Peerage, Vol. II p. 177 "The Information of Lieut. R. F. taken as aforesaid (supposed to be at Daventry.)" etc. "Deputy Lieut. of the county of Northampton" in the Official discharge of his duty. Bible Records "Dr. Lt. Captn." King Charles I, England statement of his descent from Charles VIII of France, "Captain of Militia" etc.

The children of Phaneul Bacon Fernel and wife as above named were as follows:— John Bacon Fernel (last name said to have been omitted due to persecution) was born at Southwark, 24 Nov. 1740 and he died, it was alleged, poisoned,) from inflammation of the bowels, 4th Aug. 1799. At 15 yrs. of age he was bound to a china manufacturer at Lambeth: and in this employment he so distinguished himself by his assiduity and genius that in a little time his efforts gave excellent improvement. From the various models that were presented to his view, he laid the foundation of future fame; and in his executions displayed such taste and correctness, that he obtained nine premiums from the society for the encouragement of arts. He formed and carried into perfection the designs of making statue of artificial stone, and in 1763, he began first to use the instrument, since improved, by which he transfered the form of the model to the marble. He obtained in 1769, the gold medal of the royal society, and was admitted an associate; and his manly figure of Mars increased, if possible, the high reputation which he had already acquired. HIS ADMIR-



E
R
E
1
2
3
4
5
6
7
8

D BUST OF THE KING, FOR DR. MARKHAM, TO PLACE IN CHRIST CHURCH-HALL, OXFORD. PROCURED HIM THE ROYAL PATRONAGE. ANOTHER BUST WAS MADE FOR GOTTINGEN UNIVERSITY: and he was now considered the only artist whose genius could delineate the group of LORD CHATHAM'S MONUMENT IN GUILD HALL., and that of the celebrated GUY, for his noble HOSPITAL.

THE other more remarkable productions of his chisel are MRS. DRAPER'S MONUMENT IN BRISTOL CATHEDRAL, TWO GROUPS AT THE TOP OF SOMERSET HOUSE, A STATUE OF HENRY VI. FOR EATON COLLEGE, JUDGE BLACKSTONE'S STATUE FOR ALL-SOUL'S COLLEGE, GRATHAM'S MONUMENT IN WESTMINSTER ABBEY, AND THE STATUES OF JOHNSON AND OF HOWARD IN ST. PAUL'S CATHEDRAL.

The article on sculpter in Ree's Encyclopedia, his elegant production. Will Mother England give U. S. names of wife and children with their histories for good will to them. THE AFORESAID JOHN BACON & A FERNALD m. Their 8 Descendants Were:

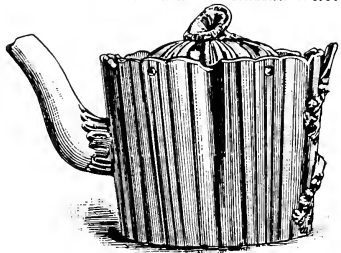

PLATE 1449. A

Plates A. B. C. D. F. THIS TEAPOT WAS GIVEN BY GOOD

QUEEN TO ELIZABETH AND A DA. OF GIRDARD AND WIFE ELIZABETH WASHINGTON UPON HER MARRIAGE TO CAPTN. W. FERNALD, S. DR JOHN AND ANNETTA, DA. OF ADMIRAL. G. de COLIGNY.

Elizabeth B

PLATE 1450. B

TON UPON HER MARRIAGE TO CAPTN. W. FERNALD, S. DR JOHN AND ANNETTA, DA. OF ADMIRAL. G. de COLIGNY.

His sig. C NAME.

William

PLATE 1451. C

Renald Fernald D WITH HER COIN, 1575,

DATE, DEATH OF THIRD DR. JOHN—, THAT WAS BY DR. RENALD FERNALD BROUGHT TO STRAW-

BERY BANK. THESE RELICS WERE GIVEN TO DESCENDANT'S, OLDEST LINE FROM DR. JEAN, SON CHARLES VIII, WITH CYPHER RECORD MADE IN IT TO K.C., By GR. DUKE, TUSCANY, FROM THOS. 4 JOHNS, Wm., AUNT DEBORAH, A.S.C. FERNALD, WRITER.



The inscription over his grave declares, in his own words, that whatever he might have been as an artist, his belief in Christ is the only important thing now." For God is just. HONOR THOU THYSELVES AND ME! THAT ALL FUTURE POSTERITY MAY ARISE, HONOR AND BLESS THEE!! There is one GOD and Father of all who is above all, and through all, and in you all. That we henceforth be no more children, tossed to and fro, and carried about with every word of doctrine by the light of man, and cunning craftiness, whereby they lie in wait to deceive us.

Chapters IV=XX

AMERICA'S FERNALDS CHRONOLOGICAL REGAL INDEX FOR INTERNATIONAL UNIVERSAL GENEALOGY.

“**W**INE IS A MOCKER, STRONG DRINK (Opium) IS RAGING: AND WHOSEVER IS DECEIVED THEREBY IS NOT WISE.”

Chapter IV

The Nine Great Commandments of the Chinese translated into the Ancient Egyptian Language, gives, 5810 B. C. creation of our world, Lights 5397, and date 4376 coming of promised Christ.

(These dates are from the semi-circles and lines of Hemisphere (Mundus=the World)

Generation F. Noah

& Gen. F. Fut, the founder

& Gen. F. Confucius

Secret Name, U. S. A.
Plate 74



of China
Secret Name
Plate 75



Secret Name
Plate 76



I.
GLORIFY, Honor, Worship, Omnipotent, Omnipresent, Omniscient just GOD thy FATHER.

II.
LABOR six days: Honor the Sacred Sabbath: Do NOT EVIL: Partake NOT of Alcoholics, VILE POISONS and fall from GOD and Heavenly Mansions: Be HOLY, PURE, Worship GOD only.

III.
ALL GOD'S daughters and sons from Fur Ava and Fna Adam marry chastely line begetting in unison holy children on broad lines of land and waters for poopling Earth for Heaven GOD the FATHER GOD the HOLY SPIRIT ONE IS complete Creator of Meastah, Mrit and Joel to whom HIS SON CHRIST is given the Brother and Saviour of all Mankind ONE with TRINITY, Angela, Woman and Mankind Honor: Chisel, Engrave, Write the COMMANDMENTS, LAWS of TRINITY GOD on the Square, Rola, Leavca, and Shella of Oceans: PRAISE GOD with dignified speech, voice, music, instruments, acts, deeds in spirit, truth, thought, mind, heart, and in all thy members piously preparing for THE JUST Judgment with rewards proportionate to Merits: punishment from exact JUSTICE for the evil practices done by, in and from the earthly body THAT GOD ENDOWED WITH FREE MORAL AGENCY FOR CHOOSING AND REFUSING GOOD. TO THE WAR FOR GOD, HEAVEN, Mansions, Paradise, TRUTH, HOLINESS, RULER, COUNTRY, STATE, EARTHLY PARENTS, LONG LINE OF BEAUTY, LIFE, LAWS, ORDERS, COMMANDMENTS OF THY FATHER GOD WHOSE SWORD WILL BE WITH THY SWORD TO TRIUMPH AGAINST THE VILE DESTROYERS OF HAPPINESS, HOME, MERCY AND PURITY: FINALLY when PURE to GO TO GOD and dwell in God for you are the Children from God and part of God that destroys not GOD.

III.
DO LOVE one another with Godly Love: GOD is PURITY LOVE.

V.
THOU shalt NOT KILL ANY MADE in God's Likeness: GOD only GIVETH LIFE and THE SEED OF LIFE and GOD alone has the RIGHT TO TAKE LIFE, and destroy THE SEED OF LIFE ETERNAL: LIVING bury thy dead, MARK their graves with Tablets: Returning thy Bodies to Earth and the Waters, GO Soul and Spirit to GOD that GAVE IT PERFECT.

VI.
HOLY IS TRINITY, all possessing Creator gave to the Womankind LIGHT: the Sun, Moo, Stars, Planets, inhabited Land, Waters, Earth Food, Animated Life, Power, Dominion, and Possession: DO NOT STEAL from any, Do not LIE, Do NOT DECEIVE: Be TRUTHFUL, PURE, HOLY, CHASTE: ALL belongs to God of Heaven who IS JUSTICE GOD OMNIPOTENT.

VII.
IN A SQUARE thou art ONE WITH TRINITY, LOVE, HONOR and OBEY thy FATHER in Heaven: HONOR, Love, Obey, Respect THY MOTHER AND FATHER, OF GOD, on Earth and Land and the Waters.

VIII.
SEEK for Justice WISDOM FROM GOD: Heaven, Air, Waters, Earth, Planets and all things pure and clean, THEREIN the CREATOR GOD IS OMNIPOTENT AND OMNISCIENT.

IX.
God's Commandments, Honor, Justice, Labor Law: Love, Mercy, Obedience, Probity, Respect, Righteousness, Truth, Wisdom from unchangeable OMNIPRESENT GOD: To do unto all others that which you would have them do unto you, the children made by the merciful Creator, Image of purity TRINITY GOD.

See Plates No. 10, 52 and 53
The O=Fa which was the primitive name God the Benign Father of all Wo Man Kind on Earth.

THE PATRIARCHS.
AGES OF WO-MAN-KIND

GOVERNORS AND *JUDGES OF ISRAELITES
INHABITATING THE WORLD 1434
AFTER ITS CREATION.

B.C.		B.C.		B.C.	
4376	Creation of Ava and Adam.	2311	Birth of Salah.	1491	Birth of Moses.
4349	Birth of Cain—Kanafatafar.	2281	" Eber.	1451	" Joshua.
4316	" Abel-Zana, '86.	2247	" Peleg.	1405	" Othniel.
130-200	" Seth-Sana.	2217	" Reu.	1323	" Ehud.
235-238	" Enos-F. Saio.	2185	" Serug.	1305	" Shamgar.
325-350	" Cainan-Nasata.	2155	" Nahor.	1285	" Deborah.
					" Barak.
395-431	" Mahalaleel-Lalar.	2126	" Terah.	1245	" Gideon.
460-459	" Jarad-Santa.	1996	" Abram.	1236,	" Abilelech.
			m. Sara da.	Haran=Faran=Fara,	king of Egypt.
622-621	" Enoch-Sara.	1232	" Tola.		Jonathan.
				*The History of the Judges differs with	
687-701	" Methuseleh-Salah.	1896	" Isaac.	Chronologers. Accurate dates in part is to	
874-883	" Lamech-F. Ladar.	1836	" Jacob.	be found in this list as correctly has been	
1056-1033	" Noah-F. Lamr.	1745	" Joseph.	discovered in the lost Ægyptian language	
1536-1535	" Ham-F. Anr.	1574	" Aron.	when this is translated into the modern Eng-	
1538-1530	" Shem-Rabakah.	1571	" Moses.	lish language.	
1530	" Japeth-Falaimar.	the great Historian THE WORLD WAS CREATED 5810. The			
1631-1635	" Mizraim-Laza.	& Laws giver, con- dates are true to Salah b. 234 and all may			
1765-1750	" Anmimim=	versant with Ægypt. be madetruce by changing 4004 to-4376.			
	Anm=M'na=				
1793	" F. Ynm=Menes-Adr.	THE KINGS OF THE JEWS.			
1791	" F. Tta m. Fnr. Lyr.				

1095 (?) Saul 1055 David and Ishbosheth. 1048 David. 1015 Solomon.

975 B.C. DIVISION OF THE KINGDOM OF THE HEBREWS.

KINGS OF JUDAH TWO OF THE TRIBES.

975 Rehoboam.	958 Abijam.	955 ASA.	914 Jehoshaphat.
889 Jehoram.	885 Ahaziah.	884 Athaliah.	878 Jehosh.
839 Amaziah.	810 Azariah.	758 Jotham.	742 Ahaz.
727 Hezekiah.	698 Manasseh.	643 Amon.	641 Josiah.
610 Jehoahaz.	610 Jehoiakim.	600 Jehoiachin.	598 Zedekiah.

NEBUCHADNEZZAR DESTROYS JERUSALEM. 588. *Old Chronology.



PLATE 1453. Generation 13. FNA TTA.
ASSYRIA.

KINGS OF ISRAEL THE TEN TRIBES.

2245 Nimrod founded Babylon.	975 Jeroboam I.	954 Nadab.	953 Baasha.	930 Ela.
2245 Ashur founded Ninevah.	929 Zimri.	929 Omri.	917 Ahab.	897 Ahaziah.
2124 Belus reigned in Babylon.	896 Jehoram.	884 Jehu.	856 Jehoahaz.	841 Jehoash.
2059 Ninus united Ninevah and Babylon, forming the Assyrian Empire.	826 Jeroboam.	773 Zachariah.	772 Shallum.	772 Menahem.
Old History.	761 Pekahiah.	759 Pekah.	730 Hoshea.	721 Shalmanezzer, king of Assyria, takes Samaria. END OF THE KINGDOM.

KINGS OF ASSYRIA BEFORE THE DIVISION

KINGS OF ASSYRIA.

2059 Fna Ninus.	2017 Semiramis. ?	1937 Arabs.	747 Tiglath - pilsar=Arbaces.	Fna.
1446 Belochus.	1433 F. Artossa.	1421 Belatores.	728 Shalmanezzer.	717 Sennacherib,
1183 Tutæus.	1139 Thinxæus.	840 Sardanapalus.	712 Esarhaddon.	680 takes Babylon.
820 Burned.	790 Pul.	After the burning of Sardanapalus in his Palace the ASSYRIAN EMPIRE ENDS. Divided into the Assyrian, BABYLONIAN, AND MEDIAN KINGDOMS.		

*The Chronology below the star on this page is copied from the untire data of 4004 B. C. Instead of the true one 4376 with the dates, true to Saul and Salah.



KINGS OF BABYLON.

KINGS OF MEDIA.

B. C.		
747	Nabonassar.	734 Merodac Baladan
680	Esarhaddon.	667 Saosduchinus.
647	Chinaldon, or Saracus.	626 Nabopolassar.
605	Nebuchadnezzar.	561 Evil Merodach.
559	Neriglissar.	556 Laborosoarchod.
555	Belshazzar.	538 Cyrus takes Babylon.

B. C.		
747	Arbaces, Governs	709 Dejoces. (?)
657	Phraortes.	634 Cyaxares I.
596	Scythians expelled.	595 Astyages.
559	Cyaxares II. or Darius.	536 Cyrus the Great, forms MEDO-PERSIAN EMPIRE.



PLATE G. 1454



PLATE H. 1455

TEMPERANCE WASHINGTON FERNALD, on U. S. Coin: C. J. Peters, Makers, Boston.

CYPHER TEMPERANCE WASHINGTON FERNALD lines! U. S. One of 5 readings of this gives Cyrus, Darius, on long lines from edge of 1798 SILVER DOLLAR also records Philip I.k. of France as ancestor of Pikes family and his trouble with Pope Urban with fact of his being a Free and Accepted Mason. It has many more important Genealogical and Historical facts and data therein and on, properly Recorded, to preserve Truth, Liberty, Justice and Happiness.

KINGS OF THE PERSIANS.

559	Cyrus the Great.	529 Cambyses or Ahasuerus.	522 Artaxerxes (Smerdis.)
521	Darius or Hystaspes.	486 Xerxes the Great.	465 Artaxerxes Longimanus,
425	Xerxes II.	425 Sogdianus.	424 Ochus or Darius Nothus.
404	Artaxerxes Mnemon.	361 Artaxerxes Gchus.	338 Arses.
336	Darius Codomanius.	330 Alexander the Great conquers Darius.	END OF PERSIAN EMPIRE.

THE PHARAOS=FARAOS KINGS OF ÆGYPT PRECEED THIS. GREECE.

3030	"a. Fna Græcus founds Greece	2089 Fna Chus Egialus founds Sic- yon.	2042 Uranus. ar. in Greece	1856 Fna Chus founds Argos (Eusebius.)
1764	Deluge Ogyges.	1711 Argus built city Argos.	1710 CEnotrus emigrates to Italy.	1641 Criarus.
1582	Arundel Marbles Chronology.	1556 Cecrops founds Athens.	1552 Triopas k. Argos.	1520 Corinth built.
1516	Lelex founded Sparta.	1507 Athens Areopagus.	1506 Crotopas k. Argos.	1503 Deucalion (Eusebius)
1493	Cadmus, Thebes	1490 Lacedæmon Sparta.	1474 Danaus, k. Argos.	1457 Perseus builds Mycene.
1438	Pandion k. Athens.	1397 Sisyphus k. Corinth.	1383 Ceres in Attica.	1283 Ægæus, Attica.
1266	Edipus k. Thebes.	1263 Argonautic exp.	1263 Adrastus k. Argos.	1213 Helen R.—. Theseus.
1204	Helen R. Paris.	1182 Æneas sails, Italy.	1176 Teucer, f. Salamis.	1170 Neoptolemus k. Epirus
1104	Eurysthenes, Procles ks. Lacedæmon.	104	END OF THE KINGDOM OF MYCENE. END OF THE KINGDOM OF SICYON, 1088.	
1068	Codrus K. Athens.	935 Bacchus k. of Corinth.	884 Laws of Lycurgus.	814 Macedonia founded.
659	Cypselus k. of Corinth.	594 Solon Archon, Athens.	568 Mycene in ruins.	560 Pisistratus Sov. Master, Athens.
510	Democracy, Athens.	491 Leonidas k. Sparta.	409 Abolition of 400.	404 Sparta rules Greece.
362	Theban Supremacy ends in Greece.	336 Alexander conquers all Greece.	335 Thrace to Macedon.	284 Achæan League.
268	Antigonus Gonatus 12 yrs. master Athens.	191 Sparta joins League.	147 League defeated.	146 Corinth demolished.

GREECE BECAME A ROMAN PROVINCE UNDER THE NAME OF ACHAIA.

KINGS OF MACEDON.

814	Caranus or Far-nus.	786 Fœnus or Cœnus.	774 Furimas or Thurimas.	729 Perdiccas I.
678	Argæus.	640 Philip I.	602 Eropas.	576 Alectas.
547	Amyntas I.	497 Alexander I.	454 Perdiccas II.	413 Archelaus.
399	Amyntas II.	398 Pausanias.	397 Amyntas II.	390 Argæus.
390	Amyntas II.	371 Alexander II.	370 Ptolemy Alorites.	366 Perdiccas.

B. C.	KINGS OF MACEDON (Continued).		B. C.
360 Philip II.	336 Alexander III. the Great.	323 Philip Aridaeus.	317 Cassander.
298 Alexander Antipater.	294 Demetrius Poliorcetes.	287 Pyrrhus.	286 Lysimachus.
280 Ptolemy Ceraunus.	278 Sosthenes.	277 Antigonos Gonatus.	242 Demetrius.
232 Antigonos Doson.	220 Philip.	179 Perseus.	168 End of THE

KINGDOM OF MACEDON. 148 MACEDON BECOMES A ROMAN PROVINCE. OUR LAWS PREVENT DOWNFALL.

KINGS OF SYRIA.

312 Seleucus I. Nicator.	281 Antiochus I. Sotor. (Saviour line Christ.)	261 Antiochus II. Theus: God-like Traits & Record Christ, b. Nh. Hm. Sm. & Japeth.
242 Seleucus II. Callinicus Thuderer.	226 Seleucus III. Ceraunus.	223 Antiochus III. the Great.
187 Seleucus IV. Philopater.	175 Antiochus IV. Epi-Fanes.	164 Antiochus V. Eupator.
162 Demetrius I. Sotor.	150 Alexander I. Balas.	145 Demetrius II. Nicator.
144 Antiochus VI. Theus.	143 Diodotus or Try-Fon.	139 Antiochus VII. Sidetes.
130 Demetrius II. Nicator.	126 Alexander II. Zebina.	124 Seleucus V.
123 Antiochus VIII. Grypus.	97 Seleucus VI. Nicator.	93 Antiochus Eusebes.
92 Antiochus IX. Grypus.	91 Philip.	90 Demetrius Euchares.
85 Antiochus Dionysius.	83 Tigranes.	69 Antiochus Asiaticus.

85 SYRIA NOW BECOMES A ROMAN PROVINCE WHOSE WEALTH AND PROSPERITY FOREWARN ITS DOWNFALL.

PRINCES OF JUDEA,

CALLED THE MACCABEES, Or ASMONEAN PRINCES.

166 Judas Maccabeus, great-gt. grandson of Asmoneus.	161 JONATHAN.	143 Simon.	135 John Hyrcanus.
--	---------------	------------	--------------------

KINGS OF JUDEA.

107 Aristobolus.	106 Alexander Fan-neus.	79 Alexandra.	70 Hyrcanus.	70 Aristobulus.
63 Hyrcanus Restored.	40 Antigonos.	37 Herod the Great.	3 Archelaus.	A. D. 8 ROMAN PROVINCE. JUDEA WEEPS TO AGAIN REJOICE.

B. C. KINGS OF ROME.

1700 FNA FNE founded Rome, m. FNR ANONR of OMO Land of Serpent Mound Declareth ÆGYPTIANS.

It is interesting to find a picture of the American Wolf on Coin typical of Mother Country of Romulus.

753 Romulus, 𐤓𐤍𐤗𐤏𐤗𐤏 translated:— "Pure Ava God over the waters made at OMO where the Sun of God maketh first shone on pure Ava whose man line sinned: God punished: right."

716 Interregnum of one 715 Numa Pompilius. 672 Tullius Hostilius. 640 Ancus Martius. year.

616 Tarquinius Priscus. 578 Servius Tullius. 534 Tarquinius Superbus. 509 The Tarquins.

expelled from ROMA. CONSULAR GOVERNMENT BEGINS, and continues independent 461 years till the battle of Pharsalia.

B. C. EMPERORS OF ROMA.

45 Julius Cæsar. 44 J. C. Slain in Senate House. 27 Augustus Cæsar & Marcus Agrippa Lucius Furnius Anarchy.

A. D.

14 Tiberius. 37 Caligula. 41 Claudius. 54 Nero. 68 Galba. 69 Otho. 69 Vitellius. 70 Vespasian. 79 Titus. 81 Domitian. 96 Nerva. 98 Trajan. 117 Adrian. 138 Anton P.

161 Marcus Aurelius Antonius. 161 Lucius Verus. 170 Marcus Aurelius alone. 180 Commodus. Decline of Roman Empire.

193 Pertinax. 193 Julian. 193 Septimius Severus. 211 Caracalla and Geta. 217 Macrinus.

218 Heliogabalus. 222 Alexander Severus. 235 Maximus. 236 Gordon, Sr.

236 His Son. 236 Pupienus. 236 Balbinus. 238 Gordian, Jr., 244 Philip.

249 Decius. 251 Gallus. 253 Emilianus, 3 months. =Gordon. 254 Valerian & his son Gallienus.

260 Gallienus. 268 Claudius II. 270 Quintilius, 17 days. 270 Aurelian. 283 Carinus-Nume-275 Tacitus.

275 Florianus. 276 Probus. 282 Carus. rianus.

286 Diocletian. 286 Maximian. 304 Constantius & Galerius. 306 Constantine the Great. 284 Diocletian.

337 Constantine II., Constantius II., and Constans. 361 Julian. 363 Jovian, at whose death, 364, THE EMPIRE IS DIVIDED.

ROMAN EMPERORS OF THE EAST.

A. D.				A. D.	
364	Valens.	378	Interregnum 5 mos.	379	Theodosius the Great.
408	Theodosius II.	450	Marcianus.	457	Leo the Great.
474	Zeno=Fna Fna.	491	Anastatius I.	518	Justin I.
565	Justin II.	578	Tiberius II.	582	Maurice.
610	Heraclius	641	Constantine III.	641	Constans II.
685	Justinian II.	695	Leontius.	698	Tiberius III.
711	Philip Bardanes.	713	Anastatius II.	716	Theodosius III.
741	Constantine V.	775	Leo IV.	780	Constantine VI, Irene.
802	Nicephorus I.	811	Stauracius.	811	Michael I.
821	Michael II.	829	Theophilus.	842	Michael III.
886	Leo VI. Philosopher	911	Alexander: Constantine VII, Porphyrogenitus	919	Romanus I. Lecapenus, and Constantine VIII.
945	Constantine VII.	959	Romanus II.	963	Nicephorus, Focas II.
975	Basil II. Constantine IX.	1025	Constantine alone.	1028	Romanus III, Argyrus.
1041	Michael V.	1042	Zoe and Theodora.	1042	Constantine X, Mono.
1056	Michael VI. Stratioticus.	1057	Isaac, Comnenus I.	1059	Constantine XI, Ducas.
1067	Diogenes, Romanus III.	1071	Michael VII, Parapinaces, Andronicus I.	1071	Constantine XII.
1081	Alexius Comenus I.	1118	Andronicus.	1118	John Comnenus I.
1180	Alexius Comenus II.	1183	Andronicus.	1185	Isaac Angelus.
1203	Isaac Angelus, s. Alexius.	1204	Alexius Mourzoufle.	1204	Baldwin I.
1217	Peter de Courtenay.	French descent.		1220	Robert de Courtenay.
1237	Baldwin.	1261	Michael Palæologus.	1283	Andronicus II.
1341	John Cantacuzene.	1355	John Palæologus.	1391	Manuel.
1448	Constantine XIII.	IN 1453 CONSTANTINOPLE TAKEN BY MAHOMET II END OF THE EASTERN EMPIRE.			

A. D.		ROMAN EMPERORS OF THE WEST.		A. D.	
364	Valentinian.	367	Valentinian & Gratian.	375	Valentinian II & Gratian.
392	Eugenius.	394	THEODOSIUS master of the whole Roman Empire, d. Jan. 17.	395	Sons heirs
395	Honorius.	423	Valentinian III.	454	Petronius Maximus.
455	Interregnum.	456	Majorian.	461	Severus.
472	Olybius.	473	Glycerius.	474	Julius Nepos.
476	Rome taken by Odoacer,	and the WESTERN EMPIRE ends with the beginning KINGDOM OF ITALY.			

A. D.		KINGS OF ITALY.		A. D.		
476	Odoacer.	493	Theodoric.	526	Amalasontha and Athalaric.	
540	Interregnum. End of the Gothic kingdom in Italy.	541	Totila.	534	Theodotus.	
				552	Interregnum.	
					553	Tejas.

A. D.		KINGS OF SCOTLAND.				A. D.		
503	Fergus.	843	Kenneth Mac Alpine.	943	Malcolm I.	953	Indulf.	
970	Kenneth II.	987	Constantine III.	995	Kenneth III.	1002	Malcolm II.	
1057	Malcolm III.	1093	Donald III.	1094	Duncan II.	1098	Edgar.	
1127	David I.	1153	Malcolm IV.	1165	William.	1214	Alexander II.	
1286	Margaret.	1292	John Baliol.	1306	Robert I.	1329	David II.	
1390	Robert III.	1406	James I.	1437	James II.	1460	James III.	
1513	James V.	1542	Mary.	1567	James VII.	1603	James I of England.	
						959	Duff.	
						1033	Duncan I.	
						1107	Alexander I.	
						1249	Alexander III.	
						1371	Robert II.	
						1488	James IV.	
							1039	Macbeth.

KINGS OF ENGLAND.

ENGLAND UNDER THE ROMANS FROM 55 B.C. TO 449 A.D. THIS BY
OLD CRONOLOGERS.

B.C.		A.D.
55	Julius Cæsar invades Britain.	43 Claudius Cæsar in Britian.
A. D.		
49	London founded.	51 Caractacus taken to Rome.
61	Suetonius Paulinus.	85 Julius Agricola.
209	Severus.	306 Constantius dies at York.
ENGLAND UNDER THE SAXONS FROM 449 TO 827		
AND SAXON HEPTARCHY 457 A. D.		
457	Hengist founded Kent.	490 Ella founded Sussex.
519	Cerdic founded Wessex.	527 Erecwin founded Essex.
575	Uffa founder East Anglia.	586 Cridda founded Mercia.
688	INA=FNA king of Wessex.	827 Saxon Heptarchy 7 kingdoms united as ENGLAND.
827	Egbert.	838 Ethelwolf.
860	Ethelbert.	866 Ethelred I.
901	Edward the Elder.	925 Athelstan.
946	Edred.	955 Edwy.
975	Edward II., the Martyr.	978 Ethelred II.
UNDER THE DANES FROM 1013 TO 1041.		
1013	Sweyn.	1016 Canute.
1039	Hardicanute.	
UNDER THE SAXONS FROM 1041 TO 1066.		
1041	Edward III., Confessor.	1066 Harold II.
THE NORMAN MONARCHS.		
1066	William I., Conqueror.	1087 William II. Rufus.
1135	Stephen, House of Blois.	1141 Matilda, or Maud, 4mos.
HOUSE OF PLANTAGENET OR ANJOU.		
1154	Henry II. Plantagenet.	1189 Richard I. Lion-Hearted.
1216	Henry III.	1272 Edward I.
1327	Edward III.	1377 Richard II.
HOUSE OF LANCASTER, CALLED THE RED ROSE.		
1399	Henry IV. of Lancaster.	1413 Henry V.
HOUSE OF YORK, CALLED THE WHITE ROSE.		
1461	Edward IV.	1483 Edward V.
1485	Union of the two Roses.	
THE HOUSE OF TUDOR.		
1485	Henry VII. Tudor.	1509 Henry VIII.
1553	Marv I., The Bloody.	1554 Philip and Mary.
HOUSE OF STUART.		
1603	James I. Stuart.	1625 Charles I.
1653	Oliver Cromwell, Protector.	1658 Richard Cromwell, Protector.
1660	Charles II.	1685 James II.
HOUSE OF ORANGE AND NASSAU.		
1689	William III. and Mary II.	1694 William alone.
HOUSE OF STUART.		
1702	Anne.	
HOUSE OF BRUNSWICK, OR THE HANOVERIAN DYNASTY.		
1714	George I.	1727 George II.
1820	George IV.	1830 William IV.
GREATEST AND BEST QUEEN OF ENGLAND: EDWARD VII. SUCCEEDED		
JAN., 1901.		
KINGS OF FRANCE BEFORE RECORDED. PRESIDENTS.		
1852	Napoleon III. Last EMPEROR OF FRANCE THAT BECOMES A REPUBLIC	1871. Thiers, 1872.
1874	MacMahon, 1876-7 & 1882 1891 Grevy 1891 Carnot and 1893 1893 Faure, 1898.	
1898	and 1902 Loubet.	

A CHURCH THAT INVOLVES ITS NATION IN WAR IS NOT A CHURCH OF GOD. IT IS A FOE TO MANKIND, ITSELF AND ALL GODLIKE WORK. AID ENRICH THY COUNTRY IN PURITY, SHUN ALL EVIL. LABOR FOR RIGHTEOUSNESS' SAKE. KEEP THE TRUE COMMANDMENTS. HAGUE FOR PEACE.

EMPERORS OF GERMANY.

A. D.				A. D.			
800	Charlemagne or Charles the Great.	814	Louis the Gentle.	840	Lothaire I.	855	Louis II.
875	Charles II. the Bald.	877	Interregnum.	878	Louis III.	879	Charles III.
887	Arnould.	899	Louis IV.	912	Conrad I.	919	Henry I.
936	Otho I.	973	Otho II.	983	Otho III.	1002	Henry II.
1024	Conrad I.	1039	Henry III.	1055	Henry IV., deposed.	1077	Rodolphus.
1080	Henry IV. Reinstated.	1106	Henry V.	1125	Lothaire II.	1138	Conrad III.
1152	Frederic I. Barbarossa.	1190	Henry VI.	1198	Philip.	1208	Otho IV.
1212	Frederic II.	1250	Conrad IV.	1273	Rudolph of Hapsburg.	1291	Adolphus of Nassau.
1298	Albert of Austria.	1308	Henry VII., Luxemburg.	1314	Louis V.		
1347	Charles IV.	1378	Wenceslaus.	1400	Robert, Ct. Palatine.	1410	Sigismund.
1438	Albert II. Austria.	1440	Frederic III.	1493	Maximilian I.	1519	Charles V.
1556	Ferdinand I.	1564	Maximilian II.	1576	Rudolph II.	1612	Matthias.
1619	Ferdinand II.	1637	Ferdinand III.	1658	Leopold I.	1705	Joseph I.
1711	Charles VI.	1742	Charles VII.	1745	Francis I., D. Lorraine.	1765	Joseph II.
1790	Leopold II.	1792	Francis II., to 1806.	1806	CONFEDERATION OF THE RHINE. Francis II. takes the title of EMPEROR OF AUSTRIA.		

1815 GERMANIC CONFEDERATION.

1835 Ferdinand I. of Austria. 1848 Francis Joseph. 1888 William II.

A. D.	KINGS OF SPAIN.				A. D.				
406	Alaric, king of the Goths.	411	Athalsus.	415	Wallia.	420	Theodoric I.	450	Torrismund.
452	Theodoric II.	468	Euric.	484	Alaric II.	507	Gesalric.	511	Amalaric.
548	Theodisele.	549	Agila.	554	Athanagild I	603	Witteric.	567	Liuva I.
587	Recared I.	601	Liuva II.	603	Witteric.	610	Gundemar.	612	Sisebert.
612	Recared II.	621	Swintila.	631	Sisenand.	636	Chintilla.	640	Tulga.
642	Chindaswind.	649	Receswind.	672	Wamba.	680	Ervigor.	687	Egica or Egiza.
697	Vitizza.	710	Roderic.	718	Pelagius.	737	Favila.	738	Alphonsus I.
757	Froila I.	768	Aurelius.	774	Silo.	783	Mauregat.	789	Veremond or Feremond.
791	Alphonsus II.	824	Ramiro I.	860	Ordogno I.	862	Alphonsus III.	910	Garcias.
914	Ordogno II.	923	Froila II.	924	Alphonsus IV.	931	Ramiro II.	950	Ordogno III
955	Ordogno IV.	956	Sancho I.	967	Ramiro III.	982	Veremund II.	999	Alphonsus V.
1028	Veremund III.	1035	Ferdinand the great.	1065	Sancho II.	1072	Alphonsus VI.		
1109	Alphonsus VII.	1122	Alphonsus VIII.	1157	Sancho III.	1158	Alphonsus IX.		
1214	Henry I.	1236	Ferdinand III.	1252	Alphonsus X.	1284	Sancho IV.		
1295	Ferdinand IV.	1312	Alphonsus XI.	1350	Peter.	1368	Henry II.		
1379	John I.	1390	Henry III.	1406	John II.	1454	Henry IV.	1474	Ferdinand V. & Isabella:
1504	Philip I.	1506	Joan.	1516	Charles I.	1555	Philip II.	1598	Philip III.
1621	Philip IV.	1665	Charles II.	1700	Philip V.	1724	Lewis.	1724	Philip V.
1745	Ferdinand VI.	1759	Charles III.			1788	Charles IV.	1808	Ferninand VII.
1833	Isabella II.	1868	Isabella II. dep.			1886	Alphonse XIII.		

KINGS OF PORTUGAL.

1093	King of Lorraine Count of Portugal.	1139	Alphonsus I.	1185	Sancho I.	1212	Alphonsus II.
1224	Sancho II.	1247	Alphonsus III.	1279	Dennis.	1325	Alphonsus IV.
1357	Peter.	1367	Ferdinand I.	1385	John I.	1433	Edward.
1438	Alphonsus V.	1481	John II.	1495	Emanuel.	1521	John III.
1557	Sebastian.	1578	Henry.	1580	Anthony.	1640	John IV.

KINGS OF PORTUGAL (Continued).

1656	Alphonsus VI.	1668	Peter II.	1707	John V.	1750	Joseph.	1777	Mary Frances Isabella.
1799	John VI.	1826	Don Pedro.	1826	Maria de Glo- ria.	1828	Don Miguel.	1908	Manuel II.
1834	Maria II.	1853	Peter V. (Don Pedro) king.	1853	King-consort Regnt.	1861	Louis Philip.		

KINGS OF SWEDEN.

825	Regnard Lobrock.	***	Reigns uncertain.	966	Eric the Victor.	994	Olaf.
1026	Edmund Jacobson.	1035	Amand III. or Ed- mund.	1041	Haquin.	1056	Stenkell.
1060	Tugo I.	1064	Halstan.	1080	Philip.	1100	Iugo II.
1130	Ragwald.	1133	Magnus I.	1144	Suercher II.	1150	Eric X.
1162	Charles VII.	1168	Canute.	1192	Suercher III.	1211	Eric XI.
1220	John I.	1223	Eric XII.	1250	Waldemar.	1276	Magnus II.
1290	Virger II.	1318	Magnus III.	1365	Albert.	1397	Margaret.
1411	Eric XIII.	1441	Christopher.	1448	Charles VIII.	1458	Christian I.
1497	John II.	1520	Christian II.	1528	Gustavus I. Vasa.	1556	Eric XIV.
1569	John III.	1592	Sigismund I.	1606	Charles IX.	1611	Gustavus Adolphus II.
1632	Christina.	1654	Charles X.	1660	Charles XI.	1697	Charles XII.
1718	Ulrica Eleanora.	1720	Frederic.	1751	Adolphus Frederic	1771	Gustavus Adolphus III.
1792	Gustavus Adolphus iv.	1809	Charles XIII.	1818	Charles John XIV.	1844	Oscar Frederic.
1859	Charles XV.	1851	Princess Louise. born.	1907	Gustaf V.		

KINGS OF DENMARK.

714	Gormo I.	750	Ragnor Lodbrog.	770	Sigefrid.	801	Godefrid.
809	Olaus I.	811	Hemming.	812	Siward & Ringon	814	Harold & Regner.
849	Siward II.	856	Eric.	858	Eric II.	863	Gormo the Old.
873	Canute I.	915	Frothon.	920	Gormo II.	925	Harold.
928	Hardicanuts.	930	Gormo III.	935	Harold III.	980	Suenon.
1014	Canute II.	1036	Hardicanute.	1041	Magnus I.	1048	Suenon II.
1079	Harold IV.	1080	Canute III.	1086	Olaus II.	1097	Eric III.
1106	Nicholas.	1135	Eric IV.	1138	Eric V.	1147	Suenon III.
1157	Waldemar.	1182	Canute V.	1202	Waldemar II.	1240	Eric VI.
1250	Abel I.	1252	Christopher I.	1259	Eric VII.	1286	Eric VIII.
1319	Christopher II.	1340	Waldemar III.	1375	Olaus III.	1375	Margaret I. Queen Denmark and Norway.
1411	Eric IX.	1439	Christopher III.	1448	Christian I.	1481	John.
1513	Christian II.	1523	Frederic I.	1534	Christian III.	1559	Frederic II.
1588	Christian IV.	1648	Frederic III.	1670	Christian V.	1699	Frederic IV.
1730	Christian VI.	1756	Frederic V.	1766	Christian VII.	1808	Frederic VI.
1839	Christian VIII.	1849	Frederic VII.	1863	Christian IX.	1906	Frederic VIII.

SOVEREIGNS OF RUSSIA. GRAND DUKES.

862	Rurick.	955	Olga.	988	Woladimer.	1156	Jurie, or George I.
1157	Andrew.	1395	Tartar Invasion.	1462	Ivan or John III.	CZARS OR KINGS.	
1534	Ivan IV.	HOUSE OF ROMANOFF.		1613	Michael Theodore Romanoff.		
1645	Alexis.	1676	Theodore.	1682	Ivan V.	1689	Peter I. the Great.
1725	Catharine I.	1727	Peter II.	1730	Anne.	1740	Ivan VI.
1741	Elizabeth.	FAMILY OF HOLSTEIN.		1762	Peter III.	1762	Catharine II.
1796	Paul.	1801	Alexander.	1825	Nicholas.	1855	Alexander II.
1843	Nicholas. born.	1894	Nicholas II.				

A.D.		TURKISH OR OTTOMAN EMPIRE.				A.D.			
1299	Ossman or Othoman I.	1325	Orcham.	1359	Amurath I.	1388	Bajazet I.	1397	Isa Belis.
1403	Solyman.	1410	Musa.	1413	Mahomet I.	1421	Amurath II.	1451	Mahomet II.
1481	Cortacus.	1481	Xemin.	1481	Bajazet.	1512	Selim I.	1520	Solyman.
1566	Selim II.	1574	Amurath III.	1595	Mahomet III.	1604	Achmet.	1617	Mustapha I.
1617	Osman I.	1622	Mustapha I. Restored.	1623	Amurath IV.	1640	Ibrahim.	1655	Mahomet IV.
1687	Solyman III.	1691	Achmet II.	1695	Mustapha II.	1703	Achmet III.	1730	Mahomet V.
1754	Osman II.	1757	Mustapha III.	1774	Abelhamet or Achmet IV.	1789	Selim III.	1807	Mustapha IV.
1808	Mahmo u d II.	1839	Abdul-Mejid.	1861	Abdul-Azis.	1876	AbdulHamid II.		
MARGRAVES AND ELECTORS OF BRANDENBURG, AND KINGS OF PRUSSIA.									
927	Sifroi.	***	Geron of Lusatia.	1416	Frederick IV.	1417	Made Elector of Bradenburg.		
1440	Frederick II.	1470	Albert I.	1476	John.	1499	Joachim I.	1535	Joachim, II.
1571	John George.	1598	Joachim Freder- ick.	1608	John Sigismund.	1619	George William.		
1640	Frederick William the Great.			1688	Frederick made king of Prussia 1701.				
KINGS OF PRUSSIA.									
1701	Frederick I.	1713	Frederick William I.			1740	Frederick II. the Great.		
1786	Frederick William II.	1797	Frederick William III.						
1840	Frederick William IV.	1861	William I.			1888	William II.		
KINGS OF HUNGARY.									
997	Stephen.	1038	Peter I. deposed.	1041	Otto.	1044	Peter, restored.		
1047	Andrew.	1059	Bela.	1063	Solomon.	1073	Geiga I.	1076	St. Ladislaus.
1095	Coloman.	1114	Stephen II.	1131	Bela II.	1141	Geiga II.	1161	Stephen III.
1173	Bela III.	1191	Emeric.	1200	Ladislaus II.	1201	Andrew II.	1235	Bela IV.
1275	Stephen IV.	1278	Ladislaus III.	1291	Andrew III.	1301	Wenceslaus.	1304	Otho.
1309	Charles Robert.	1342	Louis I the Gt.	1383	Mary.	1389	Mary and Sigismund.		
1437	Albert.	1440	Ladislaus IV.	1444	Ladislaus V.	1458	Matthias I.	1490	Ladislaus VI.
1516	Louis II.	1526	John Sepusius, deposed.	1527	Ferdinand k. of Bohemia.	1534	John Sepusius, again.		
1539	John II.	1561	Maximilian.	1573	Rodolphus.	1609	Matthias II.		
1618	Ferdinand II.	1625	Ferdinand III.	1647	Ferdinand IV.	1656	Leopold.	1687	Joseph.
1711	Charles VI.	1740	Maria Teresa.	1780	Joseph, her son.				
THE PRESIDENTS AND VICE-PRESIDENTS OF THE UNITED STATES, OF AMERICA OMO LAND.									
1789	George Washington, Virginia, President			1797	John Adams of Massachusetts, President.				
	John Adams, Massachusetts, Vice-President.				Thomas Jefferson, Virginia, Vice-President.				
1801	Thomas Jefferson, Virginia, President.			1809	James Madison, Virginia, President.				
	Aaron Burr, New York, Vice-President.				George Clinton, New York, Vice-President.				
1805	George Clinton, New York, Vice-President.			1813	Elbridge Gerry, Massachusetts, Vice-President.				
1817	James Monroe, Virginia, President.			1825	John Q. Adams, Massachusetts, President.				
	Daniel D. Tompkins, New York, Vice-Pres.				John C. Calhoun, S. Carolina, Vice-President.				
1829	Andrew Jackson, Tennessee, President.			1837	Martin Van Buren, New York, President.				
	John C. Calhoun, S. Carolina, Vice-Pres.				Richard M. Johnson, Kentucky, Vice-President.				
1833	Martin Van Buren, New York, Vice-Pres.								
1841	William H. Harrison, Ohio, President.			1845	James K. Polk, Tennessee, President.				
	John Tyler, Virginia, V., became President.				George M. Dallas, Pennsylvania, Vice-President.				
1849	Zachary Taylor, Louisiana, President.			1853	Franklin Pierce, New Hampshire, President.				
1850	Millard Fillmore, N. Y., V. Pres., became Pres.				William R. King, Alabama, V. Pres. (d. Ap. 18.)				

PRESIDENTS OF UNITED STATES (Continued).

- | | |
|--|---|
| 1857 James Buchanan, Pennsylvania, President. | 1861 Abraham Lincoln, Ill., Pres., assassinated 1865. |
| John C. Breckenridge, Kentucky, Vice-Pres. | Hannibal Hamlin, Maine, Vice-Pres. |
| | 1865 Andrew Johnson, Tenn., Vice-Pres., became Pres. |
| 1869 Ulysses S. Grant, Ohio, President. | 1872 Ulysses S. Grant, Ill., b. Ohio, President. |
| Schuyler Colfax, New York, Vice-Pres. | Henry Wilson, Massachusetts, Vice-Pres. |
| 1876 Rutherford B. Hayes, Ohio, President. | 1880 James A. Garfield, Ohio, Pres., assassinated. |
| William A. Wheeler, New York, Vice-Pres. | Chester A. Arthur, New York, Vice-Pres. became Pres. |
| 1884 Grover Cleveland, New York, President. | 1888 Grover Cleveland, New York, President. |
| T. A. Hendricks, Indiana, Vice-Pres. | Levi P. Morton, New York, Vice-Pres. |
| 1892 Grover Cleveland, New York, President. | 1896 William McKinley, Ohio, President. |
| Adlai E. Stevenson III., Vice-Pres. | Garret A. Hobart, New Jersey, Vice-Pres. |
| 1900 William McKinley, Ohio, Pres., killed Sept. 14, 1901. | 1904 Theodore Roosevelt, New York, President. |
| Theodore Roosevelt, New York, Vice-Pres. | Charles W. Fairbanks, Indiana, Vice-Pres. |
| 1908 William S. Taft, Ohio, President of the GREATER UNITED STATES OF AMERICA. | |
| James S. Sherman, New York, Vice-Pres. | |

THE EMPIRE OF CHINA HWA HSIA ASIA, THE FLOWERY ASIA.

FUT the founder of China = 𠄎 | | - Δ that was named for his son Ching-Hong = 𠄎 | | - 1 0 - thus keeping in the last sign symbol letter of Ching the picture of anatomical generation designated in China by A=Δ- or the initial letter of Adam and Ava, his first foreparents. In his second name Hong is retained a picture of upright man = 1. and O = 1 F = the name of Deity, God. See preceding pages for more particulars and 2nd edition.

THE EMPIRE OF JAPAN, A CORRUPTION OF MARCO POLO'S ZIPANGU, A

corruptive of the Chinese pronunciation of the native name Nihon = - 1 1 0 = in the primitive language translated into English, "Noah upright man of God line of earth and waters: the NIPPON = 1 0 0 0 -. translated:—"Land of the Rising Sun of the picture name of God the Father and God the Holy One of Ham = 𠄎 = 1 - = Hm: 1 𠄎 line of the earth and waters.

It is pleasing to know that the most ancient Japanese had the primitive religion and the "Sun God" is a survival of the knowledge that families of Noah, Ham, Shem and Japheth retained the spelling in its earliest form, which was not the worship of the SUN, but God, that emblem gloriously spelt in brightness.

It is to be found in the history of Creation written by Fnr Lamr. also on the Map and Historical Chart of Hm and Nh with such clear picture illustrations that no person of intelligence of any languages can fail to understand it when once possessing the key, that is in the Primitive Language shown with such repetition for fixing facts and data that conduce to the general welfare of each herein.

In Charles MacFarlane's book "JAPAN—on its Courts, Laws and Police with Punishment, as "a principal, Death for all offences."

"It does not, however, appear to have been adopted either from caprice, or through wanton disregard of human life, but may be traced rather to an erroneous conception of the means of doing equal justice. It is maintained that justice would be violated, unless all persons, whatever their rank, quality of similar offences, were punished in an equal manner; and it is conceived that death is the only penalty that affects alike prince and peasant. 'Justice' says William Adams, 'is very severe, having no respect to persons.'"

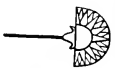

FANEUIL COAT OF ARMS.

Symbolic.

INTERNATIONAL

BY G. U. S. AND F. A.

Peter Faneuil Universal Genealogy Monument Fund.

Gen. M.
FRANCIS J. FERNEL,
Manager.

* Membership *

Certificate:

For Peace on Earth and Good Will to All: HONORING MY ANCESTORS:

Cents: 9

Dollars:

Donor: Subscribers Received, IN HONORARIUM AND MEMORIAM, Duly Acknowledged HEREOF:

CHARLES AUGUSTUS FERNALD



Principal of GOD'S UNITED STATES AND FOREIGN ALLIANCE.

General Office, 1483 Washington Street, Boston, Massachusetts, U. S. A.

FACSIMILE OF THIS CERTIFICATE EXCEPT PLATES OF CHARLE VIII. DR. JEAN FERNEL, FANEUIL ETC. WAS GIVEN TO HONORABLE CONSULATE AND OTHER GENTLEMEN AND LADIES REPRESENTING 1,600,000 PEOPLE FOR BUILDING HISTORIC MONUMENTS IN EVERY NATION WITH A HEROIC BUST OF THEIR LAWFUL RULERS THEREON. NAMES OF DONORS ON SUITABLE TABLETS WITH FOREPARENTS- ALL ARE INVITED TO JOIN OF GOOD CHARACTER. SMALLEST DONATIONS \$5. NOW 1001 SUBSCRIBERS.

Two sons of whom nothing further is recorded. Peche, 1321, of Wormleighton b. Peche Joan Peche, granddaughter and eventually heir of John Peche, grandson and heir of the 1st baron, m. sir William Montfort, and among her descendants this barony is in abeyance. Unless it has reverted to the Crown.

GENERATION VI.

GILBERT, the 1st, s. Hamon and his wife, m. Had: Gilbert: Hamon: Hugh:
Robert: Thomas: William and died 1261. (Eng. Records). The names Peache,—Peake,—Pike
are of same family. See U. S. Census, 1790.

GENERATION VII.

GILBERT PECHE of Brunc 1st baron, s. of Gilbert married and died 1323: Had: Robert:
John:

GENERATION VIII.

ROBERT, s. Gilbert (1261) and wife, m. Had: Alexander: Joan: may have had
others.

GENERATION VII.

ALEXANDER, s. Robert and his wife, m. AVICE. Had: Nicholas: John: Jo-
anne or Joan, gr. da., h. of John, gr. s. 1st baron m. Sir. William Contfort, among whose heirs in the
14 century it was held in abeyance, notwithstanding the many Pikes. The will of Alexander, dated
A. D. 25 Nov., 1329 Court of Hustings, London, England, leaves to Avice, his wife, capital tenement
in the Parish St. Dunstons, or Dustin and remainder to Nicholas and John, his sons. Katherine,
widow of William Furnivall mentions Avice and Alice her sisters in will 30 Sept., 1340.

GENERATION VIII.

NICHOLAS PYKE, 1332, s. of Alexander and Avice, m. Beatrice: Had: Joanna and John.
Nicholas is mentioned in the will of Richard Gaunt, March, 1340. "To Nicholas—a tenement in
Ismaygeres Lane, so that the said Nicholas pay his executors forty-two marks to discharge his debts
and fulfil his last will, otherwise the same to be sold and Beatrix, his wife, to have a moiety of the
aforesaid forty-two marks, Joanna the daughter of the aforesaid Nicholas to have twenty shillings.
The residue," etc. I have written by Pike, Hebrew Grammar, Arithmetic and Spelling Book.

GENERATION IX.

JOHN PIKE, s. Nicholas and Beatrice, m. and 1385, went to Spain with the Duke
of Lancaster and died 1386. Weever in his work on Heraldry p. 822, mentions Joannes Pike, who
may, or not have m. a cousin of Worthy (Washington) Pike that m. Beatrix St. Maur whose ances-
ter was also the ancestor of Sir John and Sir Thomas More. (See Fernald Chart of his Genealogy)
Much would be printed of this generation but in a manner unknown to me very many of my Pike
Records have disappeared as also the plate of my ancestors, General Zebulon Pike, which repeated
and prolonged search at great cost have failed thus far to obtain, even the copy of his features in
the books that were said to contain it, as also is the same of the plate of the plaster cast of King Francis
of France that in his features was an exact resemblance of my honored father as I saw his deposit in
the last earthly resting place at Wolfboro Centre, N. H., where fanatics did not hesitate to break his
grave stone, which was history repeating itself. This insult ceased by sending a sword to mend
grave tablet.

In 1380 Archbishop Richard Pique crowned Charles VI. the Good Friend, king of France,
from whom descended Lauren e Washington Firnel, the line of Charles VIII. and his lawful wife,
Anne of Britany, da. Duke Francis II, and Margaret de Foix, the lawful wife of said Francis, of
Britian. Church history may give his parentage as son of Worthy Washington Pike and wife,
Beatrix St. Maur, with the relationship to the kings of France, which can militate against the stolen
records of the eminent Lawyer John Pike and his wife Sarah, da. Charles Washington, the father of
Robert who was the ancestor of General George Washington, whose legitimate children were the
Thirteen States of United States of America.





GENERATION XVII.

←"ET GENERATIO RECTORIAM BENEDICTUM."→

MR. JOHN PIKE, b. 15 May 1653, a minister and historian, s. Major Robert Pike and wife, m. 2d Sarah, da. Mr. Joshua Moody, a clergyman, 5 May 1631. This was a second m. and the first child was John. See records of Pike Family Association Historical Address, delivered at U. S. Hotel, Boston, 1902, p. 27, also, another at American House, 1904, p. 77, later some of best parts omitted of great value, by writer of the Mss. From the former, reprint: "nor have I the lost record, except by will at Boston's new court house from which it appears his son was John and appointed as executor: the Mass. Hist. Society-containing Rev. John Pike," Dover, N. H., "Journal-I, quote"—My fr. son was born Mar. 30, 1682, Had: 1st m. in 1670 Mary Sophronia Furneaux *who d. 1671 at birth of John, Jan. 17, mariner, m., d. John was ancestor of Genl. Zebulon Pike.

- | | |
|---------------------------------------|---|
| 1 Anouymous (said) b. 30 Mar. 1682: | on old record "anonymous" |
| 2 Nathaniel, mariner, b. 3 June 1683: | 7 Joshua, b. 14 June 1693: The record referred to in my |
| 3 Robert, b. 6 Feb. 1685: | 8 Samuel, b. 1 April 1695: Historical Address mysteri- |
| 4 Abigail, b. 3 April 1688: | 9 Abigail, b. 22 Dec. 1697: ously disappeared and as the |
| 5 Hannah, & | 10 Margaret, b. 31 Jan. 1698: one recorded here was found |
| 6 Mary (Twins) b. 18 May 1691: | 11 Solomon, b. 23 May 1700: it was thus entered. |

Reverend John Pike of Dover, N. H., the fr. of above children was b. in Salisbury; educated at Harvard Col. by his fr. graduated 1675; ordained in Dover, 31 Aug. 1681; d. 10 March, 1709, 10, Aet. 57. Mrs. Sarah (Moody) Pike died 24 January 1703. She was da. of Rev. Joshua Moody of Portsmouth, N. H.

←GENERATION XVIII.→

"OMNIS VIA VIRI RECTASITIVIDETUI; APPENDA AUTEN CORDA DOMINUS-FACERE MISERICORDIAM ET JUDICUM, MAJIS PLACET DOMINO QUAM VICTIMAS."

JOHN PIKE, s. Rev. John and Sarah Pike was born 17 Jan. 1671 and m. Mary Hooke, 31 Oct., 1728, went to Almatunk, New Jersey and was among the first settlers, named afterwards, Lam berton. Their descendants were 8 children:

- | | |
|---------------------------|--|
| 1 Jacob, b. 29 Dec. 1729: | 5 Elias, b. 25 Sept. 1737: John Pike, mariner midshipman (as |
| 2 John, b. 4 Aug. 1731: | 6 Israel, b. 15 Aug. 1743: may when a boy have been, his father) |
| 3 Mary, b. 16 Aug. 1733: | 7 James, b. 27 Aug. 1745: that records were found as different |
| 4 Caleb, b. 3 Aug. 1735: | 8 Elizabeth, 2 Oct. 1748: persons, perhaps from an errata. |

←GENERATION XIX.→

"THOU BREAKETH THE SHIPS OF TARSHISH. WITH AN EAST WIND."

JOHN PIKE of Almatunk, s. of John Pike and Mary, m. Sarah of New Jersey 16 March 1750: Had descendants:

- | | |
|--|-------------------------------|
| 1 Zebulon b. 1 Jan. 1751: d. 27 July, 1834: m. Anna Parker Jureau Funel, da. Rev. Peter: (Had Robert,) et als. | m. 5 William b. 29 July 1761. |
| 2 Mary, b. 26 July 1754: d. | 6 Martha b. 19 April 1763. |
| 3 Henry, and | 7 Sarah b. 11 Feb. 1765. |
| 4 Caleb(Twins) b. 15, Aug. 1755: | |

d. 14 Aug. 1825: Mr. Henry Pike's widow Mrs. Dorothy Pike d. 23 Nov. 1841 ages 67 yrs. He d. 78 yrs. 7 mos. bur. at Middleton, N. H. Captain John Pike had a historic reputation of being a gallant soldier in the French and Indian wars. He was living 1790 at Mount Desert Town with wife, 4 sons and da. at Maine, name spelled Peache in the U. S. Census of 1790.

HENRY, of Middleton, N. H., wife, s. da. and Jacob, w. 2 s. 2 das in U. S. Census of 1790.

←GENERATION XX.→

"AND HE INCREASED HIS PEOPLE GREATLY AND MADE THEM STRONGER THAN THEIR ENEMIES."

ZEBULON PIKE, s. Captain J. hn, b. 1 Jan. 1751: m. ANNA PARKER JUREAU FUNEL Peter, b. 20 May 1752, married 18 Feb. 1769 and their descendants were as follows:—

- | | |
|--|--|
| 1 Robert, b. 5 Aug. 1772: m. Mary, da. Col. William and wife Mary (Clark) Cotton May 1797. Mr. Robert Pike, d. 19 June 1843; Aet 70 yrs. 10 mos. 11 days: Mrs. Mary(Cotton)Pike, d. 23 Sept. 1832. | |
| 2 Sarah, b. 8 Sept. 1773: | |
| 3 Anna b. June 1775: | |
| 4 Henry b. 15 Oct. 1777. | |
| 5 Zebulon Montgomery Pike was b. 5 Jan. 1779 at Lamberton, south of Trenton, N. J. No records kept in N. J. prior to 1848. There may have been other chn. *da. Anthony Furnace 2s, 4 das. of Marblehead. | |



Major Zebulon Pike who served in the Revolutionary Wars, again entered the army of the United States as a Captain of Infantry, in 1792, having, as the Records of the Executive Journal state—"served with reputation in the levies" during the preceding year, promoted to rank of Major, 1800. Although called General in the Pike Records and silver engraving I do not find Government promotion. The family had resided in New Jersey several years, but like all families, moved, to better their condition. Sons marrying, buying homesteads; daughters marrying and following their husbands to their homesteads; repeated in generations.

HENRY of Middleton, N. H., wife, s. da. recd. was s. Zebulon or fr. John's Henry U. S. Census, 1790. Robert Pike, husbandman or Farmer, sometimes Lawyer, moved to Middleton, N. H., after 1790 was at Senter's location, Grafton Co., N. H., Sarah, Anne, Mary or Martha at Portsmouth, Town and William Pike at Stoddard Town, 2 sons and 2 das. It will be seen they loved to travel.

Cousin Zebulon Montgomery Pike, traveler up Pikes' Peak, a Government Observatory, was born in Lambertson, N. J., now south part of Trenton where:

"In Trenton and in Monmouth ground,
The grass grows green, the harvest bright, above each Soldier's mound.
The Bugle's wild and war-like blast, shall muster them no more.
An Army now might thunder past, and they not heed its roar."

GENERATION XXI.

"HE THAT ANSWERETH A MATTER BEFORE HE HEARETH IT, IT IS FOLLY AND A SHAME UNTO HIM."

ROBERT PIKE, s. Genl. Zebulon and Anna, was b. 1772: m. MARY COTTON, b. Oct. 3, 1779: da. of Col. William Cotton and wife Mary (Clark) Cotton: s. Josiah of Plymouth, married May , 1797. Ten children. Their descendants were:—

1. Jacob G., b. 19 Feb., 1799: d. 14 July, 1867: m. Hannah Burnham, b. 9 Mar., 1799: d. 3 Mar., 1876.
2. MARY C., b. 12 Dec., 1800: d. 14 Feb., 1887: m. JONATHAN P. F I R N A L D , b. 1797: d. 21 Apr., 1893.
3. Henry, b. 27 Mar. 1803: d. Wolfboro. Cen., m. Maria Downing, bur. at Wolfboro. Centre, N. H.
4. Joanna M., b. 14 Apr., 1805: d. 4 Mar., 1881: m. Calvin Tibbetts: had several descendants, m.
5. Robert, b. 23 July, 1807: d. m. Elizabeth Piper.
6. William, b. 29 Sept., 1809: d. m. Went away. Not heard from.
7. Dudley, b. 25 March, 1812: d. m. Sarah Pinkham.
8. Hannah S., b. 23 Sept., 1814: d. m. David Chamberlain, b. d. 14 Feb., 1881.
9. George C., b. 15 Apr., 1817: d. 28 Oct., 1889: m. Maria S. Cook; descendant of Navigator ancestor of Dr. Cook, that was the first to discover the North Pole, persecuted for noble traits.
10. Thomas C., b. 20 Oct., 1820.

GENERATION XXI.

"A WONDERFUL AND HORRIBLE THING IS COMMITTED IN THE LAND."

BRIGADIER-GENERAL ZEBULON MONTGOMERY PIKE, s.; Genl. Zebulon and Anna, m. Clara, da. Captain John Brown of Cincinnati, Ohio, of Revolutionary fame and had several daughters, all but two tradition declared "died young." The daughter Clarissa Harlowe Pike married John Cleves Symmes Harrison, son of the HERO of TIPPECANOE, ninth President of the United States. Do not know in what year. Information from Mrs. Bertie Harrison Eaton of El Paso, Texas, July 2, 1894. Tradition is strengthened. Ex-President Benj. Harrison wrote my Uncle Symmes Harrison, m. Mar., 1801, the daughter of General Pike and had several children. Cannot give the names. Son. One daughter married General More-au of France. American genealogists this is your opportunity for facts and data. He was commissioned as Ensign, 3 March, 1799, having previously entered his father's Co. as Cadet: Promoted to Lieut. Apr. 24, 1800, 1st Regt. Inf. 1802. Ascends the Missouri. Sent to New Mexico. Commended by the Secretary of War, promoted to Captain: Promoted to Major 1809: Lieut. Col. of Infantry, 1810: July, 1812, raised to Col. Appointed by President a Brigadier General Feb.

1813. Did not have time to go before the Senate in time to be confirmed before General Pike was killed in battle at York Upper Canada, now Toronto, April 27th, 1813 while leading on his troops to victory. His mottoes were: I. "PRESERVE YOUR HONOR FREE FROM BLEMISH." II. "BE ALWAYS READY TO DIE FOR YOUR COUNTRY." One of our Pike Coat of Arms. He beareth Argent a Chevron between Three Crescents VERT. Crest. Three pikes proper: One Erect, the two Sature, by the name of Pike. Motto: L'AMOUR LA VERTU & LA PAIX. This Pike name was omitted in a historical atlas. Notwithstanding his blood washed out the foul disgrace of Commander Hull who saw his troops cut to pieces. And was properly cashiered for cowardice.

GENERATION XXII.

"A LITTLE ONESHALL BECOME A THOUSAND, AND A SMALL ONE A STRONG NATION: I THE LORD WILL HASTEN IT IN HIS TIME."

Mr. JONATHAN POOR FIRNALD, s. William and wife, Betsey (Elizabeth) Johnson, b. 1497; m. Miss MARY COTTON PIKE, da. Robert Pike and his wife Mary (Clark) Cotton: 11 Chn. See previous pages.

GENERATION XXII.

"DAVID LOVED JONATHAN!"

Mr. DAVID CHAMBERLAIN, b. 27 Jan. 1837; married Miss HANNAH S. PIKE, d a. Robert and Mary Pike, b. 23d September, 1814; had descendants three (4) children; son George of Rochester, N. H., m. Miss Christina A. Williard, March 8th, 1870; (John, m. at Wolfboro, N.H.) Two daughters remained single.

GENERATION XXII.

"THERE IS NONE LIKE UNTO THE GOD OF CREATION WHO RIDETH UPON THE HEAVEN IN THY HELP, AND IN HIS EXCELLENCY ON THE SKY."

GEORGE C. PIKE, s. Robert and Mary Pike, b. 15 April, 1817; m. MARIA S. COOK, b. 1st November, 1827; after died of Mrs. Abigail Pike, 6 May, 1851; They lived at Union Village, N. H.; had eight descendants:

- 1 George Harrison Pike, b. 1 Nov., 1847, by first wife Abigail Pike; named for relationship.
- 2 Robert Seth Pike, b. 5 Oct., 1851. by 2d m. gt. gr. da. Joseph Cook, U.S. Census 1790: son of Capt. James, 1728
- 3 Nancy Jane Pike, b. 21 Dec., 1852. m. da. of Capt. Furneaux, a Middlecott, grad. H. Col., s. Elsha, s. Richard,
- 4 Mary Abby Pike, b. 12 Feb., 1853. Rep. Dover, N. H., s. Francis of Plymouth, 1620, son of Robert, Educated at
- 5 Emma F. Pike, b. 19 July, 1857. Oxford, son of Sir Anthony, Baronet who died 1576. "Dr. Frederiak A. Cook,
- 6 Nancy M. Pike, b. 4 June, 1892. discoverer of North Pole, a descendant." 2 Baronies in abeyance, unless
- 7 David Chamberlain Pike, b. 16 Aug., 1885. forfeited to government.
- 8 Minnie H. Pike, b. 28 Aug., 1871; d. 29 Aug. 1873.

It is to be regretted that Cook records, as also, of these last two families have been, with many others, very valuable, stolen, protected by those in the city who have had ample proof from me to prevent bankruptcy of Boston; protect its best citizens who have only to be uncorruptible to be persecuted, unless they become Papists. Is this just or a shame? You have the remedy to cure the disease.

Courteously acknowledging aid and Pikes Records from Mr. Robert H. Pike, Union, N H., Hotel Proprietor. The following part I have of his records:

Mr. ROBERT H. PIKE, b. 19 Mar. 1831; m. ELIZABETH GILLMAN, b. 15 Feb. 1831; m. 24 Nov. 1851. Descendants: 1. Charles Herman Pike, b. 19 Nov., 1859; d. 28 Aug., 1882. Andrew Gillman, m. Dolley Pike, da. Joseph Pike, son of Robert Pike.

GENERATION XXII.

"TO ME BELONGETH VENGEANCE AND RECOMPENCE."

Mr. CALVIN TIBBETTS, who d. 4 March, 1881, m. Miss JOANNA MORE PIKE, da. Robert and Mary, b. 1805.

Taken with above were these Records. Another gives part. They had several descendants:

GENERATION XXII.

"THEIR FOOT SHALL SLIDE IN DUE TIME; THE DAY OF THEIR CALAMITY IS AT HAND."

Mr. HENRY PIKE, s. Robert and Mary, b. 27 Mar., 1903; m. Miss MARIA DOWNING. Had four descendants: 1. Hannah Pike, m. Bennett, chn. 2. Kimball Pike; 3. Lydia Jane (?), m. Mr. Gillman. Mr. Henry Pike and wife were buried at Wolfboro Centre, N. H. The record of fourth child taken, with others. Pleasant, was our love. The Roman Coin of Kaisar Pike stolen. 1909.



NATHANIEL G. PIKE, b. 13 Jan. 1783 d. 9 May 1858: m. BETSEY WALLINGFORD 9 Oct. 1778: d. 5 Jan. 1879.

First Generation.

1 Martha, b. 1 Jan. 1816

Second Generation

JOHN G. PIKE, m. MARY A. CRESSEY of Gorham, Maine.

Their descendants:—

2 John G. b. 17 Aug. 1817 m. 1 Francis: d. Dr. John Pike, an excellent and hospitable gentleman
3 Amos W. b. 15 Dec. 1819 m. 2 Fanny A. d. Bowdoin Coll. 2 yrs. Graduated in Medical Col. and
4 Phoebe b. 7 April 1824 3 Nathaniel H. Pike, m. A. D. Collins. Practiced at Durham.
Salmon Falls, Boston and Dover, where he now resides.

After the death of his wife Mary; he m. Alice Home of Dover where he now lives and extended to writer of this many most courteous tokens of good will from a noble, soldiery gentleman: afflicted with blindness: having dined with him and accepted the night's repose.

He took me to Rollingsford and showed me the room the Divine Whitfield slept in and birth place of Dr. John G. Pike bro. of Amos W., b. at Rollingsford, N. H. Taught 115 Schools in 36 yrs. and the Author of several hundred poems of merit. Showed to me the locality of the Massacre by the Indians—the stone, flat, that covered their last earthly remains. His Nephew Judge Robert G. Pike, then practicing law at Dover, kindly sent or loaned to me many valuable Records, which I copied for printing, that our light fingered Boston politicians may be able to tell their whereabouts. Never have I passed a day more replete with pleasure, memory of which will last with life. While under the Drs. roof he showed some old Pikes Family Records entrancingly beautiful in design and finish. Long may these excellent families flourish, a happiness to themselves, and a blessing to all.

AMOS W. PIKE, s. of Nathaniel and Betsey, m. Eliz. M. Chadbourne of South Berwick, Maine, 20 May 1844. He teaches school all the time, but lives on the farm they had. Their descendants were:—John F. b. 3 Aug. 1847: Dart. Coll. grad. class 1870, Boston University Law and School Class Robert S. b. 28 July 1851: Practiced law in Boston. Died 17 Dec. 1875. Lilla J. b. 15 Oct. 1866: Judge Robert G. Pike, I have not the Records of his studies. Mrs. Elizabeth M. Pike died 8 April 1850.

Reprint, AN OLD PIKE DOGGERELL READ AT UNITED STATES HOTEL, U. S. Flag Floating.

"In ye battyle front before break o daye lyte knelte Simeon Pyke
With Phineas Johnson, ye Moses Poor and Foster wythe braves all alyke,
On ye B. Hill with eyes glittering hearts and strong hands to fyte,
Ye Brytisher, Romayne and Saxeon Red coates marched up ye heights.
Shute not tyll ye whyte of ye eyes ye see and ye commands I give,
Then ayme as youre fathers at Red Skync Devyles befoure ye did.

Galyently up and up, nearer and nearer marched ye foe in brighte arraye.

Fire! With Bills, slugs, shotts, peese, sworde byronettes, they were swept away,

Balls, slugs, shotte, peese, and powder spente on ye seventeenth B. Hill daye.

Retreat! The command, slowlye, obstinately did the brave yeomen obey.

Ran one, ran all, except those who desired to staye, preferring in death as laye

Moses Poore, Symeon Peake, carnage drefuld and this for liberty against ye taye.

Last to run was Phineas Johnson, and Pluckeye Foster ye last theye saye.

We see P. Johnson stop and his cote laye o'er his fr. Moses Poor by S. Pyke;

Foster's cote tales may behynde Phineas a bit straye yet so nere alyke

No man knoweth to this daye. Great wail ye mother of Moses Poor bye Sara

Poor Appleton. Greater the sorrow of his beloved wyfe Hanna More and da.

Hannah Poor, blessed ye wyfe of Phineas Johnson, who mayde a better coate

Longer tale than the one so sacredlye layed o'er Moses Poor, ye hero

Wythe Symeone Pyke ye brave sonne of ye Captyne John, Indlans foe."

An Anecdote. Sand Piper Courtesy: Love. In 1858 while engaged on the borders of beautiful Lake Wentworth at mouth of Fernald' called Willey brook, removing the tuft of centuries to better other land by J. P. Fernald, a shy Piper came and with many peaceful bows invited adoption, kindly treated, he became confident and lost all fear, watching every tuft turned for its food, ate relishingly to repletion, remained a long time after gratefully performing its toilet and with many graceful bows, musical notes, peeps, slowly departed: continued the repetition till labor was completed.



Plate 1434. TEMPERANCE WASHINGTON FERNALD MEDAL whose features were taken from her Medalion for the U. S. A. Silver Dollar of 1798 that on its circumference was a line of ancient language as may be seen surrounding medal which was carefully copied by my Swedish Artist. The original was probably kept by the Philadelphia Mint or returned to Dr. John Fernal, gr. son of Dr. Renald Fernald; under it added by Deacon John Fernald that m. Miss Sarah Hincks the da. of Hon. Justice John Hincks. On a large silver spoon is the Vessel of War on which in 1575 was slain the gr. fr. of Dr. Renald Fernald that in its broad side, and oval of spoon is the date of the death of Mrs. Temperance, wife of Mr. Thomas Fernald and da. of Robert Washington of Va. At top of medal is pyramid point with oak leaf below and the name primitive of God between two oak leaves over the acorn that in turn is over our and Samuel Washington's coat of arms by marriage to Anne, da. of Rev. Francis J. Fernal and wife Marie Commenius. Under this in the third inverted Crescent is the primitive alphabet with the letter R=which indicates woman, etc. The oak leaves above her face count 20 the family of Rev. F. J. Fernal



PLATE 1434.

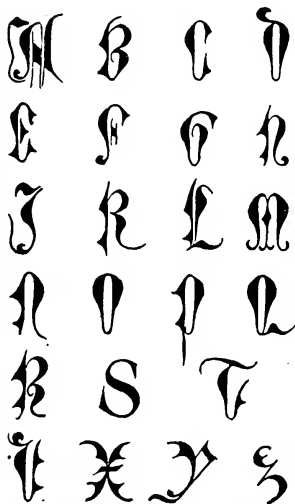

PLATE 1435.

ABCDEF GHIJKL MN
OPQRSTUVWXYZ &

PLATE 1436

as is in the E's over Saml. Washington's grave where he at Avon, Eng., was known as Wm. Shakespere. It is found to contain 13 stars and 13 acorns surrounded by Oak Ratan, 10 Palm branches and 14 oak leaves below the Ship.

Plate 1435. Pontifical Anatomical Capitals of Geoffrey Tory, A. D. 1529, Ægyptian: Dr. Jean Fernel, æt. 32.

Plate 1436. The American Roman Washington Fernald Historic Alphabet that was written Recording past, present, and foretelling future events.

2 First letters are the initials of Annie of Britiany, 3, of Charles VIII Rex= King. R has four marks for sons in upright part, remove the curves, of R which marks count all his children, 6, and find in former 1 F the initials of Jean Fernel also the F of Francis J. F., whose da. Anne married Sa n u e l Washington that was known as William Shakespere. Eighteen black lines on the A (18 white on B) is a correct count of the family of Francis Junius Fernel, whose son-in-law beareth for Arms the Spear which spear is to be observed in plate of Rev. Francis J. Fernel. The & has our most ancient war Seal with its body darkened with three white, TRINITY, lines.

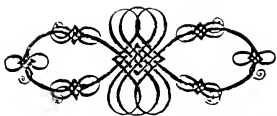

A B C D E F G H H
 H K L M N O P Q
 R S T W W X Y Z

PLATE 1438. Casper Nef. German Type. 549

A B C D E
 F G H I K
 L M N O P
 Q R S T U
 V W X Y Z

A B C D E
 F G H I K

PLATE 1437. The American Types. Prophetic. Microscopically examining a large glass of apparently Boston pure water, by the unaided eyes unseen, a large Microbe was found. Inserting a clean glass rod three times with sugar upon it the Microbe rushed eagerly to and fed from it. Inserting it twice without the sugar, he went to it, third time he ignored it. If we show less reason than he, what is our end? Support true, lawmakers, the just, constitutions, and religions.

A B C

D E F G

I M N O

P R S T

V W X

PLATE 1439. From English Bells. Early 16th Century.

Abundus B D

A B C D E F

F J K X

PLATE 1440.

PLATE 1441.

Gothic Capitals from Tomb Richard II. Westminster Abbey, England, A. D., 1400. Two C's.

A B C D E F G H I L
 M N O P Q R R
 S I V X Y.

PLATE 1442. Fifth Century. Rustic Capitals.

A B C D E F
 G H I K L M N
 O P Q R S T U X
 Y Z

PLATE 1443. German Capitals. Gothic and Monogramic Types.

A A A B B C C
 O O O R R R
 I K K L L O O N O
 P Q R S T U W Z

PLATE 1444. The Wise Germanal Versal Types.

A B C O E F G H I K L L
 S I D E U S N O B I S C U Q U I S C O N C R I N O
 M O N O P O Q R S C U
 X Y Z

PLATE 1445. German Lombadio Capitals.



PLATE 1446. SHELLS AT DAMARIS COVE RIVER, LINCOLN COUNTY, MAINE U. S. A., Oyster Bed. An inlet of the Sea off Monhegan Island. The Indians called, "Ped-auk-go-whack, (in deed to Walter Philips), place of Thunder." Dr. Jackson in 1838 Geological Measure, found it 180 rods long by 80 to 100 rods wide, 25 or 26 feet deep, containing 44,906, 000 cubic feet.

Relics

Human animal and fish bones. Charcoal, chisels, stone hatchets, tools of Art and Chase. Ornamental Pottery. Deep-sea sinkers, bone silettos, together with what may have been a potters wheel. "These heaps were begun by prehistoric man." Now historic

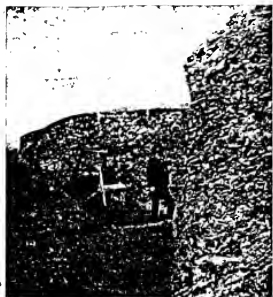
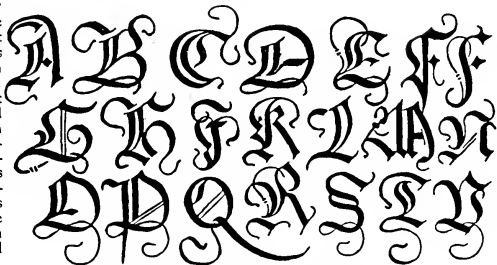
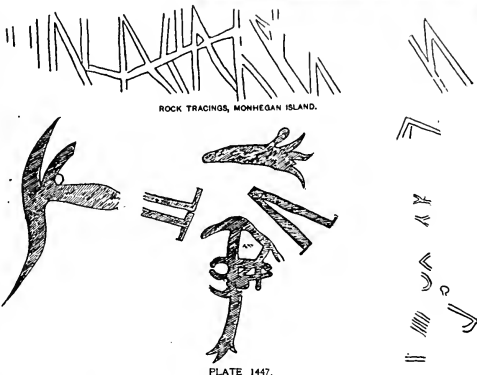

Plate 1447 of Rock Chisellings on Monhegan and Damaris Gove Islands are a most valuable continuation of the inscriptions on Dighton Rock, Taunton River, Mass. Translations First of Five. "On the waters from Roma came Fna Marcus Agrippa Lucius Furnius 29 B. C. to Orno Land of lake pyramid and commenced Tower at Auona, finished by Chia and Bahman, eleventh generation after with the name of God above it and Christ his Son. Agrippa named the country Augusti for Emperor Augustus. Foes of 6th tribe of Indians came down on them and they fought, son, daughter of wife of Agrippa line a Chief Otar's went to and m. F. Animin 2nd at Mina, now called Maine, where they formed and grew a large family. The largest part of one of the two ships went N. East and a branch to the S. The former m. into line of Ann who went to the East S. E. and formed a mighty Nation, from which descended four Nations and these five inter-married with Agrippa's lines and peopled the territory in many directions as is clearly shown by the line Language inscriptions on Monhegan Rock Island and their faces to this time.



Damaris Cove Island Rock Writings Translated. := "Theos Christ from Roma sailed XV to Oma the Lake Pyramid Land to teach the Sacred Roll, Squares of Ava writing and engraving given by Father God and I Christus write on this Rock and Return 10 plus X plus $\Delta \Delta \Delta = 23A$. D. to Roma. I Theos the Christ," etc. "I Christ honor my Parents Mary and Joseph. I Fna Christ One with Trinity and Brother of Thecla my sister of the long line of Ava and Adam's descendants nourished by our Mothers Breasts." See Plate 31 for similar inverted V. that here shows going to and from, and there the feet simply going forth.



PLATE 1344 FERNALD RELICS. AT RIGHT THE ROLL OF 8,000. HON. CONSULATE WITH ALL OUR BEST CITIZENS SEEN NAMES OVER PIKE'S COAT OF ARMS. PRESENTED BY HON. SENATE OF COMMONWEALTH OF MASSACHUSETTS TO AUTHOR 1908. PETITIONERS FOR ENACTMENT OF OUR THREE LAWS, REMOVING CAUSE OF THE DOWNFALL OF NATIONS.

Chapter XXII.



FERNALD LAW in PHILOLOGY

From straight —  curved line
all lines

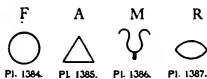

From translating the ancient Hebrew letters into their corresponding Ægyptian symbols was found the primitive letters Symbols hieroglyphics that The Supreme GOD gave unto Ava, woman and man, Adam and and descendants. They were as

seen by above—F, A, M and R, and from the first two are evolved all lines, known as curved and straight lines and most resplendant for they are the name of God, kept by the Chinese and Japanese even unto this day.

From this Alphabet descends all Alphabets that ever was or ever will be.

The first O, letter is the name of one God only. It represents power, glory, brightness (as heaven, planets, sun, moon, stars, light by day and night, pupil of the eye, etc.,) and was the seal that God gave to our first parents, which was used by Noah and his family as may be seen by the history of Creation written by Fnr Lamar and inscribed on the first pyramid that was an altar built unto the Lord in the land of Ægypt. (See pl. p. 25, 60, 65, 70.) When mankind unwisely departed from keeping the commandments and God's Laws, it was still kept as the letter O, which it is called to-day and found on most ancient map.

The second letter, Δ, represents Trinity; form of pyramid of Ægypt and our A, by moving the base line upwards. By Greeks it is retained and called Delta.





IT is our triangle and in anatomy the name is used as Scarper's triangle. By inverting it and attaching the removed base line to its apex of the V, is=γ and is called by the Hebrews Ayin or the "eye." In Schrift der Tinne-Indianer, ∇, s, and Δ=Α in other alphabets,

as Welsches Barden. In Angelsächsische Runen the F is 1st letter of the alphabet; also in Nordische and Markomannische Runen, with Gothicse.

The third letter symbol is kept by the Canadian Indians in 4th line of the Lord's prayer, first in third line 2d in fifth line. (See p. 69 plate). In this interesting letter symbol, monogramic, we have the whole names of trinity and the promise of Christ the Messiah to be born of Mary and Joseph. The origin of the numerals 1, 2, 3, 4, 5, 6, 7, 8, 9, 10, 11, 100 & 1000. It is the letter M which by removing the two short lines and invert is the Greek letter Omega, hence the meaning literally of Christ when he said, "I am Alpha and Omega the beginning and the ending" for the Alpha in Egyptian from Greek that were co-existent spelling γ = Δ = Fa = God Ḥ = OOC, the initials of God the father and God the Holy One and C the Christ.



THIS fourth letter appears to be parts of the first and third and employed to show that God gave the rolls to woman with the commands and laws. Anatomically the third and fourth indicate the nose and eyebrows outline and fourth the mouth, etc. Third is in shape much like the nipple on the infant's nursing bottles, also to be found on the seal ring of Samuel Washington, whose nom de plume was William Shakespeare.

God said, "These letters, signs, symbols I give unto thee Ava and Adam and thy descendants, my Holy Name, Commands, Laws, to write, read, for speech, music, to communicate, practice, preach, record and transmit unto all my children of earth that I have created perfect in my likeness."

Again God said: "The date of thy creation shalt thou bear upon thy features, thy ears shall counted be two to hear, thy eyes art two to see and thy eyebrows and nose is M which shall be called 1000, therefore it is 4000. Thy nose hath two openings to smell and breathe through, and thy mouth hath one opening for breath and speech and these openings shall be called three hundred and marked with C therefore 4300; thou shalt count all of these again and it shall be seven O, therefore 4370; count again the ears that hear, the eyes that see, the nostrils that I breathed the breath into and thou hast six and the whole shall be 4376 and thy mouth, tongue shalt tell it. Four thousand three hundred and seventy-six years before my son Christ the Messiah is to be born I created thee woman and man Sunday, December 7th. Sunday was found to be on Friday as now it is called. The origin of numerals and letters, symbols, hieroglyphics, as it readily can be seen is from the first primitive

1 2 3 4 5 6 7 8 9 10
 11 12 13 14 15 16 17 18 19 20
 21 22 23 24 25 26 27 28 29 30
 31 32 33 34 35 36 37 38 39 40
 41 42 43 44 45 46 47 48 49 50
 51 52 53 54 55 56 57 58 59 60
 61 62 63 64 65 66 67 68 69 70
 71 72 73 74 75 76 77 78 79 80
 81 82 83 84 85 86 87 88 89 90
 91 92 93 94 95 96 97 98 99 100
 PTATE 1388.

alphabet the gift of Deity to hischn. Much honor is due the Arabs for keeping it so

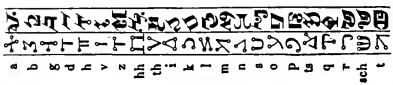

PLATE 1389. From Benajah J. Antrim search. In central column may have been used by Ffr Lyra & Fna Tia.

near the perfect Primitive that was engraved on the two Golden Squires of Commands and Laws that I found in the Bible "shall not be destroyed," for God wrote them and "I, God will save them even when Christ my son, women & men with the Earth passeth away." ωε□ψοά Ezra; Chap. I., V. 1:6. Decree of Cyrus, 6th line, 2 to 8th symbol by reading from right to left (See plate 403). The figures from the beginning, exhibit a neatness of shape, nicety of method, not to be surpassed by any nation, for brevity, quickness and effect. Five changes are noted from very early to present date in PL. 1388. 1st Egyptian.



The most ancient Arabic letters are the Kufic, so named from the city of Kufa, on the Euphrates, but they do not appear to be used at this time. They are as follows:

The Kufic letters designated by a, d, v and m = the primitive M: l, r, and z the primitive A: k, h, v, m and ph of English F the primitive O named Fa or F, A, M = O. Δ. Ψ.

The disputes among the learned concerning antiquity of the HEBREW alphabet is at last happily laid at rest and fast is disappearing: the animosity among the most wise and best of the churches that truly worship God and not mammon, power and self: thus ushering into the pure minds of the godly, a peace that passeth all understanding. —N, —M

The writings of Moses, who was conversant with the Egyptian, 12 and the Book of Job have a collection of letters, symbols of the primitive religion for all.

Mr. Nathaniel Dearborn Text Book of Letters, a very rare book, beautifully artistic, shows much of interesting cy-

language for removing ancient true history by ungodly priest-craft. Which great wrong was and is copied by the good and even astute scholars, as are untrue Records, innocently. For during the dark ages almost all true knowledge was lost.

The Hebrew letters are all monogramic: A=N in English, Ægyptian=O=o whose religious meaning is God the Father, line of God the Holy One. The B=Trinity. G=One God and His chn. women and men. D=Line of Heaven for earth came down. H=Fa and as preceding. V= F and Fohi, Fo, and of God. h. h.=l—l=Fnf. t=the hand of God wrote the Tablet of Commands and Laws. y=da. son child. k=C etc. I=God's fnar line, etc. m=Trinity, Mary and Joseph and God wrote the Golden Squares as seen at terminal. □=m. =Christ to come and go, also interchangeable with m. n=God's Noah. a=m, y, eyes. f=f and not p, Ψ=z=s=m Ψ and FFan. k=Hand and serpent. r=line of woman. S=ship on sea, etc. t=Fnh, etc. □=Ψ. etc.

l c i t c h z v h d g b a
t s p h h h s n m l a g e t h z d z d h

pher history and is worthy of adoption for a national work. One page is here inserted and card, see plate.

ch th tz sc r k

The Hebrew Coin Symbols in the first letter gives its name, F, called by some writers Oolef, and is equivalent to ayin O O and is called a—to first. The 3d symbol Δ=A is found in the 1st, 3d, 6th, 9th. The third of the primitive alphabet is found at 6th letter of Coin and called h. h. or hhaith, Ψ, but is inverted, taking the form of the Greek Omega with an o oblique line engraved through it. Students have from fancied resemblance given the following names Aleph=ox, Beth=house, gimmel=camel, Daleth=door, Vav=hook, Zayin=armour, Heth=traveling script, Tet=serpent, Kaph=hollow hand, Lamedh=ox-goad, Mem=water, Samekh=prop, Ayin=eye, Pe=mouth, Tsade=screech locust, Quoph=ear, resh=head, shin=tooth, Tav=(which is evidence of the religion of written A. C.) cross. The implication, or to coin a word, interlopation of points was to alter the whole language

Ancient Hebrew.	Hebrew Coin letters.	Later Hebrew alphabet.
א. aw-lef.	א	א
ב. bath.	ב	ב
ג. gee-mel.	ג	ג
ד. daw-leth.	ד	ד
ה. hay.	ה	ה
ו. vaww;	ו	ו
ז. z-yin.	ז	ז
ח. hhaith.	ח	ח
ט. tait.	ט	ט
י. yoadh.	י	י
כ. kaf.	כ	כ
ל. law-medh.	ל	ל
מ. msim.	מ	מ
נ. noon.	נ	נ
ס. saw-mekh,	ס	ס
ע. ayin.	ע	ע
פ. pay.	פ	פ
צ. ts-w-dhey.	צ	צ
ק. goaf.	ק	ק
ר. raish.	ר	ר
ש. sheen.	ש	ש
ת. twv.	ת	ת

PLATE 1392. Contains Primitive Alphabet.



1393. Nathaniel Dearborn's American Text Book, 1842.

THE SAMARITAN ALPHABET.

That the Chaldeans and Phœnicians or Fœnicians had never lost all of the primitive alphabet is self-evident from the study of their hieroglyphics. Fœnicia furnished probably more letters to a greater number of languages than the former.

There is reason to believe that the Samaritan continued a living language for many centuries.

If in ancient Rome, as Cicero informs us, the boys were obliged to learn the twelve tables by heart, as a *carmen necessarium*, or indispensable lesson, to imprint on their tender minds an early knowledge of the laws and the constitutions of their country, *Nocturna versate manu, versate diurna*. Is it not equally required that they and we should be systematically taught the science of letters, primitive religion, a personal gift from Diety, the only perfect Laws Maker and first giver of the primitive alphabet from whose straight and curved lines all religions, laws, constitutions, lines, letters emanate.

To possess knowledge, support the constitutions, keep inviolate the laws of Nations and his Country first by his talents, best services, life if required is the firm, irrevocable duty of every patriot.

This generally received

The first alphabet of the Samaritans is called, by Furnier, Idumean; and he says that it was used by many nations in Asia. The second is a character as remarkable as the former, and said to have been delineated after the course and movements of nature, and contains a queer looking animal. The third, given, as follows, is also said, by Theophrastus Ambrosius, to have been formed from the same as the preceding.

"It was proved and received in use at Rome, and called ancient Greek." The fourth is a skeleton alphabet, exhibiting the small circles as before given; and taken from the Samaritan coins, by Walton. The fifth is one found in the French Encyclopedica, pl. I, and is as follows —

There is another kind, differing from this somewhat, copied by Dr. Morton, from a manuscript in the Cottonian library, in the British museum.

PLATE 1396 From page 142 Science of Letters.

ORIGINAL GREEK ALPHABET FURNIER'S NAME	A	B	Γ	Δ	E	F	Z	H	Θ	I	K
alpha	beta	gamma	delta	epsilon	zeta	eta	theta	iota	kappa		
bull	test	camel	door	window	book	lace	palis	serpent	baob		
NEUMERICAL POWER IN GREEK.	1	2	3	4	5	6	7	8	9	10	100

ORIGINAL GREEK ALPHABET FURNIER'S NAME	A	M	N	Ξ	O	Π	Ψ	Φ	Σ	Τ
lambled	lamed	mem	nan	xi	o	pi	psi	phi	sigma	tau
prick-sick	water	fish	prop	eye	mouth	qap	rib	shin	bread	
NEUMERICAL POWER IN GREEK.	30	40	50	60	70	80	90	100	200	300

PLATE 1397.

Duplicate part Plate 1396.

PLATE 1398. The Northmans Alphabet.

Normans characters, whose language is spoken in many nations of Europe, Asia and America.

It was deemed essential in the earlier days of British liberty, long after (see pl. 1130A, p. 227) Livrus 60-l taught Christ should be born I A. D., and ascend 4IV to the Lord of Heaven. $\Delta \equiv$ Fa Universally Heaven and Earth's one God of freedom to men and women Christ connecting them to God, transmitted to the better days of that country and that "Magna Carta" should be authoritatively promulgated and read to the people which, if conjoined to a properly kept primitive religion for all, from with American Constitutions their best parts were de-

riated, history never would have recorded the downfall of States and Nations, nor the hideous spectacle of 250,000,000 martyrs reduced to 150,000,000.

Every intelligent person should by his *own will and authority* aided by the wisdom and liberality of Governments and Nations

own a copy of their Declaration of Rights, Constitutions, Laws, and all the Primitive Religion, which still survives in inscriptions, letters, alphabets, picture symbols, religions, sciences and arts. Even ON THE GOLDEN SQUARES ENGRAVED BY THE HAND OF FA OR GOD. ALL this should

be taught for universal good, without bigotry in the public school and by sectarian and non-sectarians fairly without any compulsion. Copies of Magna Carta was sent to all Cathedral Churches and read twice a year. "Lex est mens sine officitus et quasi Deus. Plato and Aristotle." "God approved and ratified constitutions" "Cane's Grotius. and Demosthenes declared them gift of Heaven." They, Pl. 1393, emigrated from Denmark, Sweden and Norway. It is well illustrated with parts of the primitive language, being evidence of the antiquity of its national use.

GERMAN ALPHABET.

The German language is original and was said to be the basis of Swedish, Danish and English; but corroborative evidence I cannot find.

Very many of our most choice or finest works have been translated from the German. Two books I do highly prize, viz:—Carl Faulmann Buch Der Schrift and Grimm's Laws. The twenty-six radical letters are replete with the extensive wisdom of their constructor. Every word of their language has a meaning. For the long continuance of eyesight it is to be regretted that all languages are not in a very clear, distinct, easily to be read type.

The Emperor of Germany is a descendant of Charlemagne which great Emperor restored learning to Italy, France and Germany, encouraging the formation of good letters in his dominions, those in use having degenerated into bad imitations of the shape of the Lombard, Saxon and Franco-Gallic. Three bear his name, which appeared in the ninth century. He did not distinguish capitals from small letters. From primitive language reading it foretold events to the present and to come with names born this and succeeding generations. It is very valuable for proof of heretofore written long line true of the only genealogy that can be sworn to as correct reaching back to *creation* and

path.) There are compound letters in the German, that are to be learned only by some little practice such as ch, ph, sch, sp, st, qu, kk, ss, ts, sh, etc., with many important and nice distinctions. This language is extended extensively over the United States and northern and western Europe.

A	a	awe.
B	b	ba.
C	c	'ray.
D	d	da.
E	e	a.
F	f	cf.
G	g	ghay.
H	h	hab.
I	i	e.
J	j	ya.
K	k	kah.
L	l	el.
M	m	cm.
N	n	en.
O	o	oh.
P	p	payh.
Q	q	koo.
R	r	er.
S	s	es.
T	t	tay.
U	u	oo.
V	v	fou.
W	w	wayh.
X	x	ks.
Y	y	ipsiloni.
Z	z	uset.

ACCENTED LETTERS.
 ä = a; ö = o; ø = o.

DOUBLE LETTERS.
 Ch, dt, ff, ff, ff, ff, ff, ff, ff.

PLATE 1399.

the Universal Father God.

This GEORGIAN alphabet is properly said to have been formed from the Greek by Postellus, who says that the Georgians use that language in their prayers, but on other occasions they employ the Tartarian and Armenian letters. Further it can be said some of theirs are used in the English alphabet of to-day with different names and O the same. S=, sc and hho when turned from left to right= B=f and two curves of it, o, b=q and d= the omega of the Greeks by turning it upside down and as it is a part of the third letter M of the primitive alphabet, the v=two Gk. P's by separation, sz=b and h=ff which is an important bit of evidence in our I=J,=n, th=Eng. D; f=when cut apart in perpendicular line q & P, etc. Their capitals are termed sacred, used for Holy Books.

Of these letters, five are vowels thus expressed: a=awe, e=ea, o=oh, oo=U.

Their pronunciation is in most cases the same, which recommends the German language for richness and native fluency. Their consonants are pronounced just as the English, except g, v, and w. The g hard, as in give; v is pronounced f; and w, is a sound between oo and f; the h is sometimes pronounced d very soft, as in roo hen, (to rest), and in many cases it is silent in the middle of a word, Bahn; is pronounced bawn, (a

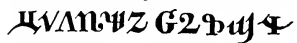

PLATE 1400. Alphabet of Charles Augustus called Charlemagne This is first class.

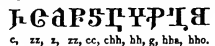
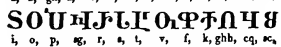
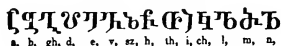

PLATE 1401 Georgian Alphabet.

"General Valency, in his essay on the antiquity of the Irish language is decidedly of the opinion that it is through the Fœni or Cathagenians, derived from the Fœnicians or Phœnician: that, on a collation of this language with the Celtic, Punic Fœnician and Hebrew, the strongest affinity,—in fact, a perfect identity of words exists. It may, therefore, be deemed a Punic-Celtic compound."

These letters in this plate was given to Mr. Antrim by the gentleman who taught them in Ireland by consent of Queen Victoria.

Oban in Welsh is augury, divination, etc. The third kind has a systematical arrangement of straight lines derived from the second letter of primitive alphabet. 4th kind is the Marcomannic Runes: 5th is Bethluisnion na Ogma, or the magical and mysterious, and 6th Bethluisnion, etc.

The original mode of writing among the ancient Britons was by cutting letters with knife on sticks, either squared to keep in mind the Commandments of God (see Log of Fnr Chia), or Triangular in remembrance of the three Primitive letters that God gave.

The Phœnician or Fœnician language was derived from their ancestors the Ægyptian, and "said was used in Tyre, Sidon and Carthage; and from it Cadmus "constructed" the GREEK ALPHABET. The ancient Greeks called the Fœnicians, Pelasgi quasi Pelagii, or wanderers, from Pe-

lagic, or wanderers, from Pelagic. Monks alphabet was called Coelbren y Mynaic. It will be seen they adopted the second letter of the primitive alphabet and kept in the name all three letters, viz:—O, A, M=F, A. M=O, Δ, Ψ.

a	U	A
b	B	b
c	C	c
d	D	d
e	E	e
f	F	f
g	G	g
i	I	i
l	L	l
m	M	m
n	N	n
o	O	o
p	P	p
r	R	r
s	S	s
t	T	t
u	U	u

PLATE 1402. Irish Alphabet.

lagus, the sea. Although no writings, except isolated letters have descended we have sufficient authority to give (six alphabets from inscription in Malta is given) the number and form of their letters which it will be seen is richly endowed by the Primitive Alphabet. The first letter O=F, the a=the second, and v and c=M which invert and of vv we have W that the scholars have above erroneously designated as s and vv=ΔΔ the two pyramids of Ægypt and the Altars that were built unto the Lord God before Christ came in the Land-of Ægypt.

This alphabet does imperfect or only part justice to the many, and most ancient "Babeloth" from its two first letters, the second is more remarkable, was derived from the Roman notes and the third are called the Irish Ogums, from Oga-Ogum, the old Celtic words that imply letters written in cypher. My Gaelic or Irish Bible, that I have given many lectures from, is remarkably filled with evidence of the admixture of the many languages during the gradual changes of tongues that were not confounded at the building of the Tower of Babel, which has erroneously been taught for nearly 2000 years.

It is written in these alphabets, but contains a large number of Hebrew letters of Resh. Am unable to discover any positive proof, although there is a possibility that the lost Tribe of Israel may with the ancient Furni have been settled here, a cause of Furni choosing and a branch colonizing there, hence the geographical names. Furni, Ferney, etc.



PLATE 1403. SAMARITAN.



PLATE 1404 Alphabet of the Monks.

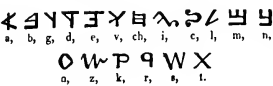

PLATE 1405. FœNICIAN ALPHABET.

Gaelic is taught in Boston and their works in largest cities in United States.





Many nations, both in language and in the United grants that during the Ex- America have chosen this condition. The language parts of Europe, except lachia; but these nations This one is the generally re- and b may be observed po-



PLATE 1406. SCLAVONIAN ALPHABET.

Europe and Asia, speak this State, we have many emi- odus of desirable citizens to country to make better their is used in all the Eastern Greece, Hungary and Wal- have a variety of charactrs. ceived Sclavonion. In a tions of the primitive M, in



c the v united to I, and d an ancient A, and f the letter n, in g two horizontal and two curved lines, which in the primitive religion language means "Christ to come from heaven to earth and return from earth to heaven, h=picture symbol of Serpent, mounds, and I; the i is the primitive letter A with three additions keeping the names of Deity—Fa and Fo with the letter C the initial of Christ: l and m evolved from primitive M; n portion of Gk. P; o=our T and was anciently used to designate Theos or the Gk. name of God; p means in Ægyptian Christ the son of God came from God of heaven; q is a double FF and e; the he shows union of I and E with changed position and is the θ T, J reversed pi retains the third letter of the primitive alphabet with the drawing from second and one of the lines placed above forming the trident. It also forms two white squares—the Commandments of God and white two openings to them indicate—God sees—the black line below—mankind acts. Z=the t as was read remotely from right two left monogram of Cain, Abel and Zana.

FROM THE STRAIGHT AND  CURVED LINE, ALL LINES

MULTIPLY, FILL, REPLENISH THE EARTH WITH GOOD; THY FORM, TALENTS, IMPROVE, INCREASE, HONOR- ING GOD THAT HAS HONORED, INSTRUCTED, THY FOREPARENTS, PERFECTLY, AND IS THE RIGHTEOUS JUDGE.

GOD made all the great and small and gave to them blessed labors, recreations, symbols, mental ca- pacity that he taught to it pure religion in its perfection that has sacrilegiously been changed into about three hundred and sixty, containing parts of pure that HE ordered taught unto all his children the human race, that rebellious changed the first that was hid but can never die: the good reward, and the evil—that we may know good—punish. It is the wisdom of God to conceal a thing, and the honor of kings, all men, to discover. Every Symbol engraved on Golden Squares glorified God and honored men.

A is the first letter of our alphabet, and the corresponding symbol also stands first in many other alphabets. It was changed from second place to the first by priest craft and those in authority, the point is like unto the point of Furni sword, the Fœnicians, appear to be the first to change it after their exodus from Ægypt in making the picture of the same as the Altar, viz: the pyramid that was built unto the Lord in the land of Ægypt, that in the symbol they threw down and raised the base line to represent our A when righted, which we clipped the projecting ends of base line showing forth the point of the sword, that with fire, cross, halter, torture has laid low over 150,000,000 martyrs. In the Ethiopic it occupies the thirteenth place, lost in Runic by an inverted Y or the Ayin of Hebrews; the numerous alphabets of India and the Trans-Gangetic peninsula, which have been rearranged on phonological principals.

The form of the letter has undergone curious transmutations in the various alphabets into which it has passed since its change from the primitive and sacred A that God gave to Ava and Adam and all their descendants. In Ægyptian  and Hebrew terminal  a is each point, Δ pyramid.





THE third letter of our alphabet is Ψ the right and left upper portion of the sacred letter M of God's gift alphabet to Ava and Adam and is the Initial of CHRIST the son of GOD, Mary and Joseph; a glance above shows it the arch of heaven, a view of the moon before its full that for 7105 years this C has given its mild golden light to all the inhabitants of earth women and men and their daughters and sons: the Crescent of Turkey, who practice all they preach and teach that Allah (Turkish language for the name of God) is one God: remotely it had the sound of g and then the C took the sound of k, and finally in some languages has the sound of S. which when separated in centre gives two letters of c, one reading to the right and the other to the left. In the hieratic character it bore some resemblance to the kneeling camel, hence, the Fœnicians called it gimel the camel, whence the Greek gamma Γ was derived, representing the head and neck of the camel. After the Greek letter had passed over into Italy the form was rounded, and became C. In the oldest inscriptions in Italy this letter still retains its original value of g, but as the Etruscans had no soft mutes it hardened into the sound of the letter k, which, being superfluous fell into disuse. The Romans had both sounds, but had lost the letter k, hence in the earliest Roman inscriptions C is used to denote the sound of G as well as of k; the words legiones and Gaius, for instance, being written Leciones & Caius. In the 3d century B. C., the form G was evolved by differentiation out of C to denote the soft sound, and placed 7th in alphabet taking the vacant place of z that had fallen into disuse. After G was invented, C took the sound of k in classical Latin. From this fact Cicero written in Gk. Jikero and Germany in the time of the empire borrowed the words Kaiser and Keller from Cæsar and cellarium.

How the letter acquired the sound of s is now to be explained: and it is instructive to note the process by which same letter comes in English to have sounds so different as those heard in call and civil. The beginning of the transition may be traced to the effect produced on certain consonants when they stand before i, followed by another vowel. Thus, there is a tendency to shorten the word nation by pronouncing it as two syllables instead of three, and it is easy to see how the sound tion would slide into the easier sound shon.

The same in the case with the k sound. The change began in Gaul about the 7th century A.D. such names as Marcius being pronounced Martius and Marshius, instead of Markius. In Italy the change did not go so far; Lucia, pronounced as Lutshia, instead of Lushia or Lusia.

Combinations like ceo and cea differ so little from cio and cia that they followed the same course, and ultimately the s sound of c was extended to cas as where ce or ci was not followed by a vowel. In Anglo-Saxon as in Latin, the letter c was originally sounded as k, a letter which we do not find in Anglo-Saxon, as it was not required. The soft sound of c began to come in use about the 8th century in words borrowed from Gaul, and afterward the easier sound was extended to English words, the letter retaining its old sound before the vowels a, o, u, but passing through ch to s before e, i, and y. When in Anglo-Saxon e followed s it tended to beccre h, the common suffix isc having changed to ish. When the k sound was retained before e, i or y, the letter k was ultimately substituted for c to avoid confusion and thus the Anglo-Saxon cyning and cene are now written king and keen. The Anglo-Saxon alphabet was also without q, for which cw was used, quick being spelt cwic. Latin C has become ch in many English words owing to their having passed through the French: thus the Latin carminus and carmen have become chimney and charm in English. In German the Latin c is k. An Indo-European primitive c sometimes becomes h, s, or g. Thus, Latin culmus by Eng. haulm. Sometimes c disappears before l or r, which explains how Clovis has become Louis. C, in Music is a note of the gamut and the sound on which the system of music is founded.





D IS the 4th letter in our alphabet, as well in the Foenician, Hebrew, "Greek and Latin from which last it was immediately derived." Its origin was from the primitive $\text{O}=\text{O}=\text{Fa}$ and $\Psi=\Psi=\square=\Delta\Delta=\text{AA}=\text{M}$ and $\text{D}=\text{D}$, from the D and $\text{D}=\text{T}$ of the Ægyptians, which from those sacred symbols it was taken to spell the name of God in other languages, as Dieu, Dieu, Dia, Divinity, etc. In astronomy that "God taught to Ava & Adam," it is seen in the form of T by the rising and setting sun and moon over the water and beyond the mountains, while the part concealed by waters and land is the typical Ægyptian D, which we use by changing the horizontal line to a perpendicular the former signify land and waters, and later Deity line of heaven and earth, removing from half circle, the remaining C (read from right to left,) is the initial of Christ that is cut into Dighton Rock. How modern scholars have confounded it with the picture of the hand I do not understand, unless they took the last letter D, and n for waters, a, for Fa as shown in upright line which is I, J, H, F, and the point cut off an $\text{a}=\text{D}=\text{Fa}$. The Foenicians call it dalet=door: Hebrew ד : Gk. Δ =delta-showing the straight lines of 2d letter of primitive alphabet is substituted for the curve. In cursive Gk. d. From $\text{B}=\text{D}=\text{D}$ in Hebrew not clear, but in the Ægyptian inscriptions it only requires change of position for our letter, as before herein shown in plate and stated —it is the first word of Genesis=Brasf= H א תשרית

The sound of D is a soft dental mute. It has an affinity for m. It is intrusive in some words and disappears in others, also it is often replaced by l, r, or b. It is often assimilated to the following consonant. By Grimm's Law a primitive d becomes t in English and z in German. A primitive dh becomes θ in Gk. th in German, f in Latin, and d in English: as the words ther, their, fera, and deer. Di followed by a vowel sometimes becomes j, as in journal from diurnal.



D, the Roman numeral for 500, arose out of IJ, the half of CIJ, which was the old way of writing, θ the direct descendant of the primitive sign O found on most ancient map of the world indicating 1000 (see plate Map) page 278 which was afterwards written M= \square .

D was added to Dr. Jean Fernel's descendants name as a memoranda of the deaths by religious fanatic assassins of Charles VIII, and several of his chn. and Dr. Jean Fernel & wife, his son Francis & gr. son Dr. John Fernel, and Admiral Gasparde de Coligny, Henry son of Captain William Fernald continuing through the nations by same organization. D, in Music, is the second note in the natural scale.

E IS the fifth letter of our own and cognate alphabets. The original Ægyptian symbols were E with $\text{T}=\text{E}=\text{E}$, and not \square as usually described. The Foenicians kept it in e, y and m with additions that do not destroy its constituents. Charlemagne or Charles Augustus kept it intact anatomically (as is every letter a likeness to the human form made perfect in God's image), but thrown down, as is seen in the Greek or Roman small omega, it was called epsilon by the Greeks, or bare e, to distinguish it from eta. In Latin it has two sounds which are heard in the French etc. In English or Anglaise it has four sounds. The normal sound is heard in get, bed, met. The name ee is usually expressed by the double letter, as in see, feet, heel, but it expressed by a single e in evil the component part of devil. In some monesyllabic words, such as he, me, we, be. It has the sound of i in England, and of u in the last syllable of eleven and better, and also when followed by r, as in fero, pert. When followed by y, as in grey, prey, it has the sound of Italian e, which is our a in fate. Custom will not allow any English word to end in v, and hence a mute e has been appended as in give, live. The fashionable use of subscript e is now generally used to elongate the vowel etc. E, in Music is the third note or sound of the natural diatonic scale, and is a third above the tonic C.

(From preponderance of evidence in Authors possession Dr. F. A. Cook and lady wife victims Martyrs. Beautiful plate of N. H. State House and Cook genealogical records stolen from author.)

F IS the sixth letter in the English and Latin alphabets. The original symbol is in each letter of the primitive alphabet and from arrangements of their component monogrammic, sacred, physiological, anatomical parts, reveal the primitive names of deity, and his children and descendants, Fnl Ava and Fna Adam, who, after their union from commands of God were designated as Fnr=Mrs Ava and Fna=Mr. Adam in our English nomenclature of today.

The Miss=Fnl=O-= without the star as first created but with it after the fall of Adam. These hieroglyphics literally meant God's earth and waters line created pure, or virgins before the sin of Adam and not Eve or Ava (the serpent story is a myth and the facts pictured out demonstrates it in the plate of Adam and (Eve) Noah copied it, which illustration true removes the subtle attempt by Darwinian theories to take from the universe Creator and the Messiah Christ. As heretofore stated there are five or more true translations of each Ægyptian symbol. The Fnl above should be without the star when applied to Ava and with it when applied to their descendants to whom was transmitted the predisposition of Adam that is applied the above to as he was after his sin a fallen star, and no more should it be applied to man, but reserved for single pure women as to day is used the word Miss, and to man is proper to give of every age Mr.= O-Δ=Fna and married women O-=Fnr and our Mrs. The F n r of today=in our most modern hieroglyphic in purity O- which in impartial justice gives her the great honor—that is due the noble woman and mother, who 10 Oct. 4376, from lawful wedlock with Joseph, became the parents of Christ the Messiah our redeemer.

In the Ægyptian "hieroglyphs was the picture of a cerastes or horned asp; the horns (was this by Ava's traducers?) being represented by the two horizontal bars in our F, and the body by the verticle stroke. When the sign was adopted by the Foenicians it received the name of Vau from the resemblance to a nail or peg. From them it passed into the Greek as a semi-vowel, but at sometime previous to the earliest Gk. inscriptions it was differentiated into two characters, F had the sound of w, and the other Y called upsilon, became a vowel.

As early as the 7th century B. C. the character F became obsolete as a letter in the Eastern Greek alphabet, being retained only as a numeral 6." (amusing contradiction). "It must, however, as Bently proved, have been in use when the earlier portions of the Hemic poems were written. In the Western alphabet, which was chiefly in the Peloponnesus, F was retained as a letter till the 5th century B. C. From the Chalcidian alphabet it was transmitted to Italy, retaining its position as the sixth letter, but acquiring the Latin sound of f instead of v and w.

This sound of f is called a labio-dental fricative, and is formed by bringing the lower lip into contact with the upper teeth. Hence it is one of the easiest of the consonants to pronounce, and may take the place, under certain circumstances, of any of the mutes. Thus, a primitive bh, gh, dh, which become b, g, and d, in English, may be represented by f in Latin, (which in proof is great along the line works of primitive alphabet.) For instance, the San-skirt bhar corresponds to the English bear and the Latin Fero; while the Sanskirt bhratar is the English brother and Latin frater. The Sanskirt dhuma corresponds to the Greek thumos and Latin fumus; the Sanskiit dvara to the Greek thura, the Latin forces, and the English door: the Gk. ther to Lat. fera & Eng. deer. The gk. chole is Eng. gall and Lat. fel. Other correspondences are exhibited in the Latin fremo, which ans. the Gk. bremo; and in frango, where the f ans. to the aspirate in the GK. rhegnumi. An f easily lapses into an h, as it seen in the Italic equivalences faba and haba, fircus and hircus. So the Spanish hembra represents the Latin femina. A English f usually represents a primitive p, as is seen by comparing father with pater, fish with piscis, or foot with pes. In four and five the English f corresponds to a guttural.



F IN the Latin quator and quinque. The words enough, cough, and laugh, in which gh is pronounced as f, exemplifies the tendency of gutturals to lapse into the easier sound. The Russians regularly change the difficult sound of th into f, the name of Theodore, for instance, becoming Feodor. In a like manner children say free and fun for three and thumb.

The Anglo-Saxon f is sometimes lost in modern English. Thus, hlford, hafoc, wis-man, and hus-wife become lord, hawk, woman, and hussy. Or f may become v, as in vixen, which is merely the feminine of fox. It is found that Fernel=Furneux=Furnace, etc.

The Greek $\phi = \psi = \chi$ and ρ should be pronounced as fuh, or fu and nearly silent h: a primitive bh becomes ϕ in Greek and f in Latin and English. Adolphus=the Teutonic Adolph and is written Adolphe by the French. The Hebrew terminal M=□, is in Ægyptian, F, I, C, G, h, A, J, and V, =F; I, F, G, H, A, Δ, J, V, v. F, in Music, is the fourth note of the natural diatonic scale of C. See Music, Scale, Key.

G IS the seventh letter in the Roman alphabet, and the modern alphabets derived from it. For the history of its character and its differentiation out of F and C. B, and primitive Alphabet with its descendants. The earliest picture symbol of it is the planet we call the Moon that was with the sun picture spelling of the name of God, when that knowledge was lost possibly, but exceedingly doubtful, may have been worshiped more probable that they were used, as we do letters and pictures to honor God the Trinity. It is true that the different churches called Idolotry much that they did not know or understand, and some of them condemned to purgatory, hades, hell, many more worthy of heaven than themselves, and preach damnation to the vast majority of mankind that God did not, but will reward and punish in exact impartial justice. In different nations the Mani=Moon is feminine and Sol=the Sun is masculine. In Germany the genders are reversed, as also with the Anglo-Saxons, although the English has followed the classic mythology. Grimm (Deutsche Mythologie, p. 666) quotes an old invocation to the "New Moon, gracious lord" (Neur Mon, Holder Herr), for increase of wealth; and down to recent times the German people appeared fond of speaking of "Frau Sonne and Herr Mond (lady sun and lord moon), which appears to me as simply a trace of the nearly forgotten significant pictures of the alphabet God gave to our first foreparents, which throws light on past history as brilliant as the lights of day and night, gave blessings to the mind, and organs of vision. The same inversion or traces appeared among the Lithuanians, Arabians and Mexicans anciently called the moon Meztle also of masculine gender, that shows an intent to honor Ava who did not sin, by comparing her to the sun, and Adam who did sin to the moon: thus complimenting them as receivers of the sacred ALPHABET GIFT OF GOD, which sweeps away much of the nonsensical dust of the ages for perceiving true history that degenerates would make so low as to deprive man of God, lower than the baboon place human race progenitors, that all authority from authentic history declareth were made in the likeness of the Universal Creator.

Among the Slavs, according to Grimm, the moon is masculine, a star feminine, and the sun neuter. Thus showing some remembrance concerning the count of men and descendants from the planets, similar to that of the very ancient Ægyptians, as was found.

In the epitaph of Scipio Barbatus about 234 B. C. was supposed the earliest G and in the school of Spurius Carvilius was supposed the substitution of G for Z, which occupied the 7th place in the Old Italic alphabet, at close of 3d century B.C. In our miniscule g from Car do not belong to majascul G, except little crook at top of g. In initial English and Latin the sound of g is hard, when soft in Eng. it is due to French influence. The Normans substi—



GTUTED for our sound of w, gu. Hence we have such doublets as guardian and warden guarantee, and warranty. Conversely a French g sometimes become w in English.

Thus the old French gauffre has given us our word wafer. G is often softened to y, e, i, or a. Thus Old English genoh is now enough, gelic is alike, git is yet, geong is young, handgeweore is handiwork, soeling is silly. A final or medial g often becomes w or ow; thus the Old Eng. fugol is fowl, maga is maw, sorg is sorrow, lagu is law, elnboga is elbow. Sometimes g disappears altogether, as in the Old English gif, which is now if; is-gicel, which is icicle: or magisteh which is master and mister. Before n we have often an intrusive g, as in the words foreign, feign, sovereign, and impregnable. An Old English h sometimes becomes gh and then lapses to f, as in enough and draught. In the case of many words, such as gate, again, we owe to Caxton, under Mercian influences, the restoration of the Old English g, which for three hundred years had in Wessex been gradually lapsing into y.

HTHE eight letter in our alphabet is derived from the primitive M at the lower portion and is also F, I, J, and Phoenician letter cheth. The Semetic or Hametic name which means the Golden Sqr. fence or palisade is explained by the form $m = \beta$ of the letter. The sound probably was of a strongly marked continuous guttural, produced at the back of the palate, which does not exist in English, but is heard in the Scotch loch and the German lachen. In Greek it became eta. As early as the 7th century B. C. this sign had two values among the Greeks, e and used for the simple aspirate h. In the alphabet of Italy it was used for h: but later in Greece the two sounds came to be represented by a differentiation of the symbol, the form H being used for the vowel, and the so called mutilated F, L, forms d or the aspirate. Hence we see how the symbol H stands for h in the Latin and for e in the Greek alphabets.

In Old English h was guttural, or throat sound, but it gradually softened down to a spirant, and now has become almost a vowel. No letter is more misused, and this misuse is of ancient date, probably due to its anatomical counterpart. In Latin MSS. and inscriptions it is sometimes improperly inserted, as in the words harena, harundo, hauctoritas, or improperly omitted, as in omni, abitat, onustus-spellings, which prove the uncertainty of its usage. In English as early as the 12th century we find it written as hard, and hold as old. Americans as a rule rarely misuse it, and in England an untaught peasant is usually more correct than a self made man. It has long disappeared from the Italian, and is now rapidly vanishing from the French. The Spaniards substitute h for a Latin f, the Spanish hijo representing the Latin filius, just as the Latin hordeum represented the Sabine fordeum. Not only f, but c and s are frequently represented by h. Thus, hundred and century, heartiness and cordiality, hall and cell are true doublets, while the Latin canis, centuc and cafut correspond to the English hound, hundred and head, and the first syllables of hexagon and heptarcy, which are derived from the Greek, correspond to the English numerals six and seven. We get hemi-sphere from the Greeks, and semi-circle from the Latin, hyper-critical from Gk. and super-ficial from Latin. The Irish have retained s, which in the Welsh has faded down to h, the Welsh hen=old, being the Irish sen and Latin senex. In English h has been lost in the words it, loaf, neck, ring, tear, fee, which were formerly written hit, hlaf, hnecca, hring, taker, and feoh, while in droht and genoh, now written draft & enough, it has become f, and in the words huge, wharf, wheel, and whelm it is intrusive. In whit, hweol, and in many other words, the decay of the aspirate caused them to be written white and wheel, and except in the North of England the h in these words is hardly heard. In the West and South of Eng. which are Saxon the aspirate as a rule is fainter, and more liable to be lost than in East Anglia, Yorkshire, and Scotland where we have the descendants of Angles and Danes.

H

The correct pronunciation of this difficult letter is one of the most delicate tests of good breeding. The quality of the sound depends partly on that of the following vowel, and its intensity to some extent on the accentuation. The aspiration is stronger in humble than in humility, in human than in humane, in history than in historical, in hostile than in hostility, but it is the same in happy and happiness, since the accent rests on the same syllable. It is stronger in "who" than in "when," in "hole" than in "whole". In "honor" it is very faint, in "honorable" and "honesty" it is almost inaudible. It is stronger in "host" than in "hospital," while in "hostler" it has so completely disappeared that the spelling "ostler" has become usual. It is retained in "harbour" but lost in "arbour." It is retained in "hair" and "hare," but is evanescent in "heir" and "hour," though retained in "heredity" and "horologe." No general rule can be laid down for the pronunciation it depends on the usage of good society, which changes from generation to generation. In good French society the aspirate is disappearing; in England and America the reverse is probably the case. The reasons why persons who omit "h" where it should be inserted and commonly insert it where it should be omitted are obscure, or lapsis mentalis. Mr. Douse in his book on Grimm's Law to what he designates as the Principal of Cross Compensation.

In German musical notation the letter "H" is used to denote B natural, the letter "B" being applied to our B flat. This anomalous distinction is derived from the ancient notation by letters, before the invention of the stave, in which B natural was written in the square form (B quadratum), like a small black letter "b", while B flat was written as a Roman "b," (B rotundum). The awkwardness of having two "B's" led to the introduction of the "H," which in small black letter (h) resembles (G) closely. In French and Italian system the same note is denoted by the syllable "Si."

I



is the ninth letter in our alphabet and was prominent in the second and third of the primitive alphabet, in second it was the three lines of the pyramid A, and third is the two upright lines of the M; also, it is the 9th in Western Europe alphabets and called by the Greeks iota from its Semitic name of yod. From being the smallest in Hebrew, we get the name 'jot a tittle (St. Matt. v: 18), and jottings or small notes. It was j, f, h. and the Egyptian yod "a hand" the form in the character in the hieratic from which the Phœnician was taken. On the oldest Map of earth it is taken as the hand and after an "O," which=10 in the date thereon of Creation of the World 5810 B. C., also there on the date of Creation of woman 4376 B. C. = ○○○○****** *10 & ●●●●*C****** plus three hands and three heads. See pl. 1337 p. 278

In early Greek inscriptions the form of the letter was angular, similar to our Z, then came to resemble S and this about the 7th century B. C., was straightened out to resemble our I. On Dighton Rock it is in form like the pupil of the eye. From the vertical it has varied less in form than any other letter. The dot in our minuscule "i" first came into use in the 11th century and was taken from the pupil of the eye. It was supposed to have come from the accented "i" incorrectly and employed to distinguish "ii" from "u." It became universal after the invention of printing when it was found convenient to use two forms of type. In the 14th century a dot was substituted for the accent, but at time of Christ the picture symbol dot of eye was used, hence it was supposed from the dot the age of MSS. could be estimated. In Italian, and in most European languages, the sound of the letter is that of the Latin long "i," the name sound of our "e," which we have in the English words "machine" and "marine." The long "i" in Latin was always thus pronounced, and never like "i" in "fine." The normal sound of "I" in English is that heard in "bit, dip, sit or short Latin." Sound is represented in cymbal by "y, u" in "busy," "o" in "women," "ei" in "forfeit," "ie" in "sieve," "ui" in "guilt," "ee" in "breeches," "ia" in "carriage." Washington did not dot i of Mss.

□ ❁ ❁ ❁ □

J IS the tenth letter of our alphabet which strangely enough is marked $\Psi = J$ in the primitive alphabet given to Ava and Adam by the ancient numeral. In the Arabic Nishki it is alif, ra, and za comprising three letters corresponding to 3d section of primitive and in most ancient Arabic it is a, and i, in Abyssinian I, and on sepulchral of king Bazen is found 1st and 3d parts of primitive letter M and 6th the I or J, 6th in "Chaldee," also the I and perfect J, i of Coptic, and Cherokee, and French l, s of Georgian by changing its position, also i of Gothic, iota of Gk. yod of Hebrew, I of Irish, I of Monks, alif, ra, za, fa, las, nun, vau of the Persian, I of Roman and Runic, a of "Saracen, I of Saxon, awe, z and r of Syriac, are the same J or component parts of it and I in the old English. In the middle of the 17th century it became universal in English books. In 1611. King James's Bible had Iesus for Jesus, iudge for judge. The dot over the i and j is curious continuance of the part made o in the primitive M. In English the symbol j is used to denote the sound dzh, as in journal; in French of zh, as in jour; in Spanish it represents the hard ch, heard in the Scotch loch, as in Jerez; in German it retains the original y sound of the Latin consonantal i, as in Jahr. Thus, while German geographers write Jenissei and Jakut, English maps have Yenissei and Yakut. The consonantal sound of the English j is frequently expressed by g, as in gem or by ge as in knowledge. The sound i did not exist in early Eng., but was introduced from France after the Norman conquest. Hence in the middle English, before the symbol came into use, we find the sound represented by other devices. Thus, we have Giwes for Jews, geste for jest, chaw for jaw, and cham for jam. Chaucer has gailer for jailor as in the Bible. The use of J is still extending, and we find jibe, jail, and jeffrey for gibe, goal, and Geoffrey. We have unfortunately introduced our acquired French sound of j into Latin words which had the consonantal i, which the Romans pronounced y; and Hebrews Ayin, the eye, and we say jam, jugum, juvenis, jupiter, juncus, jacio, hujus, and mayor. In some inscriptions in the early imperial age the consonantal sound of i is denoted either by doubling the letter or writing it as a capital: huius, or hulius representing the older huius. In inscriptions of the later empire we find Giove for Jove, a usage adopted in modern Italian, in which we have Gesu, Giovanni, Giuseppe, and maggiore, from Jesus, Johannes, Josephus, and major, the use of the new letter j being evaded in the same manner as the Middle English.

K IS the 11 letter in our alphabet and is derived from the primitive $\Delta = A$ which in the line the ancient sacred alphabet denoted Trinity and after the fall of Adam and sin had entered into the acts of men, and even Ægypt the most and best religious country in the world gave license with political trust to the wicked that embraced evil, the primitive A was changed to represent a falling pyramid, the altar pyramid that was built unto the Lord in the land of Ægypt—the base line "I was placed across the apex of pyramid turned on its side," thus evolved K, and the perpendicular live pointing to heaven and earth, also part of third lower part; and it is found in Coptic, Cherokee, French, Gothic, Greek, Hebrew by changing position of part of [qoaf, Runic h, and y, Russian, Saracen l=k: part of si in Slavonian that is a compound letter of part of R or B forming P on right of K: K is also 10th in Saxon; in Thibetian Kha is constructed of I Δ , thus * , and K= * * , both retaining the pyramidal letter 2d primitive; when read by primitive language it declares fall of Ægypt from their sin, but promised the rise of the greater country Anglia and Amarica the letter of which is mentioned in Genesis, as Amarica. * * * See alphabet.



KWHEN taken over by the Fœnicians it was called kaph=hand, the two slanting strokes representing the thumb and forefinger: as written in Chambers Encyclopediæ, here copied in the primitive language is Fa line, etc. With little change of form it was transmitted to Greece as kappa, and with the other Greek letters passed into the early alphabet of Italy, where it was retained by the Umbrians and Oscans, but ultimately discarded by the Etruscans and Romans. It occurs in three of the earliest Latin inscriptions, and by its retention in certain conventional archaic abbreviations, as KAL. for calendæ. It was not used in the classical Latin, since after the invention of G it was superfluous, the letter C having acquired precisely the same sound, that of the soft guttural mute, which is formed by raising the tongue to the back of the palate. Hence this sound came to be denoted by C in the Latin alphabet and all the alphabets derived directly from it, such as the Italian, French, and Spanish with Portuguese: while the symbol k was retained by Greek, Coptic, Russian, Wallacian, Servian, Runic, Gothic, and German. Thus in French the letter k is only used in modern loan-words, such as kepi, or kilometre; while in German is confined for this most part, to words derived from the Latin or French, such as criminal, civil, consul, and canal. In England, where the two influences met and encountered each other, the usage is conflicting. In the Southern or Saxon shires, into which the alphabet was introduced by Roman monks, c was at first universal, k being unknown before the 12th century. In the Northern or Anglian shires, which possessed the runes, a script ultimately of Greek origin, k is found in very early MSS., such as the Rushworth Gospels. To the Northumbrian missionaries, to whom the conversion of Germany is chiefly due, may be attributed the use of k instead of c in the German alphabet. After the Norman Conquest of England the phonetic power of c became uncertain, owing to the introduction of its French value of s in such words as city, and in the 12th and 13th centuries the use of k began to be spread from the northern counties to the east midlands, and then to East Anglia, being employed in the first instance before the vowels e and i, where the value of c was most ambiguous. Hence in Middle English we find k in the words Kent, keen, kith, kin, king, keep, and key: and also before n in the words knave, knee, knead, know, knot, and knight, in all of which c had formerly been employed. It is also used in the words of Scandinavian, Dutch, or northern origin, such as ken, keg, kid, kill, kilt, kindle, kirk, kippered, kink, and in such modern loan-words as Koran, kangaroo, and kaleidoscope, but on the whole the usage in English accords more with the Latin and French than with Greek, German, and Russian.

LTHE 12th letter of our alphabet is descended from the sacred primitive, 3d letter, $\Psi=M=m=\square=AA$, and formed by removal of the two base lines and lower the right hand one to a horizontal position, and later by retaining the upright and horizontal one of the Hebrews terminal square m. It is commonly described as descended from the Fœnician lamed=ox goads: a glance at the, described at last, Fœnician alphabet, it is found to be an exact resemblance to a portion of b, m, n, by severing the parts and raising upright the horizontal portion, the lamed, scepter, whip, or engraver if correctly described would require reconstruction by lowering one oblique part and raising another; while the scientific trend of philology is toward the easiest course, yet for honoring the many students who desire to aid all men, we give the following:—"The letter lamed was probably a degraded form of the Hieroglyphic picture of a recumbant lioness, from which the hind quarters have disappeared, leaving two straight lines, one of which represents the outstretched fore-paws and the other the chest.

L

The early Greek λ form passed over into Italy, where it became L. From the former through the intermediate stage F the Greeks got the form Λ , transmitted to the Runes, and this finally became \mathcal{A} in the Greek capitals (corresponding to the primitive A), and λ in the minuscules, which is an inverted Ayin φ of the Hebrews, $\lambda=1$ of Egyptians, $\lambda=eye=a=1$ interchangeable with r. Our own minuscule form l, was derived from the old Roman cursive. The Roman numeral for 50 was L, but this is not the letter of the same form, but was obtained from the Western form of the Greek letter chi, the successive stages being χ , φ , λ , L.

The letter l is usually designated as a liquid, but is more correctly designated as a frontal palatal. It has great affinity with r, the positions of the vocal organs for forming l and r being nearly the same. In sounding r the breath escapes over the tip of the tongue, while for l the tip of the tongue touches the front palate or base of the gums, the breath escaping from the two sides of the tongue, and the vibrations of the soft lateral edges producing slight oscillations in the force of the breath, whereas in the case of r a stronger trill is caused by the vibrations of the tip of the tongue. In the Spanish ll, the Italian gli, and in the English word glory, the contact with the palate is made by the middle of the tongue instead of by the tip.

Owing to the affinity between l and r they are frequently interchanged. In some languages the same sign was used for both sounds, and the most ancient Egyptian the two λ φ l and r were heard alike, but in the history of Creation written by Fnr Lamr, the wife of Noah, the Tablet of Abydus gives the φ , and in other languages the l or r is wanting: in old Pali the signs were interchanged: the Japanese sign for r was borrowed from a character which represented l in the Chinese: while the Polynesians substitute l for r in foreign words as plum, (prunus), turtle, (turtur), purple, (purpura), marble, (marmor), and pilgrim (peregrinus). We have the converse change in chapter from capitulum, and lavender from lavendula, while colonel is now pronounced cornel.

The letters d and n have also an affinity with l. We have the change of d to l in lacruma for dacruma, lingua for dingua, lapillus from lapidulus, sella from sedula, alloquor from adloquor. In the numerals 11 and 12 the l is also believed to represent a primitive d. We find the change of n to l in asellus dor asinulus, collegium for conlegium, and Bologna from Bononia. In the spelling of several English words the letter l has fallen out, as in such and each, from the Old English swile and aec. Though preserved in the spelling, it is not heard in the words alms, palm, calm, yolk, half, would and should. A final l is often mute in the Scotch dialect, as in a for all, fa for fall, fu for full. In modern French it sometimes fades to u, as in aux for a les, du for de le, chevaux for chevaux: the French changed al to Eaux. In Italian it may become i, as in piano from planus. On the other hand the l is intrusive in windless from O. E. windass, and in myrtle for myrtus, participle from participium. From a false analogy with would and should, where the l, derived from will and shall, is radical, it has crept into the spelling, though not into the pronunciation, of could, which is the past tense of can. The M. E. form coude has no l, while the Dutch konde and the German konnte have preserved the n which belongs to the root.

The Furnal=Firnald=Furnel is found in Rome during the 4th & 3d century B. C., as Furnius (two are specially mentioned as C Furnii, father and son, orators and historians,) another, (a martyr of the Roman Senate, was falsely accused and executed for crime of senate to prevent establishment of reform,) u. changed into a, i, e, a into l, and d.



M

the thirteenth letter of our alphabet was directly derived from the primitive Ψ m the 3d letter symbol which of the three contains one curved and two straight lines although it is described as taken from the hieroglyphic picture of the owl, which was typical of the erudition and proclivities of its describers whose owlish ears equaled the bird's characteristics. "In the capital letter M the two peaks are the lineal descendants of the two ears of the bird, retaining between them a not in apt representation of the beak, the first of the verticle strokes corresponding to the beast."

It is in fact the 2d letter A without the base line and the two lines of 3d letter m brought to a point, thus, Λ = two pyramids, which, when inverted is our letter W., for Washington to day from Δ gyptian, and again, I prophecy, to be the altar built unto the Lord in the land of the Nations: from the Pharaohs scepters the two such constitute M: from the Hebrew terminal square $m = \square$ it is but the points cut off and placed into position, also the said m is the top of the step pyramid of Δ gypt whose lines thereto of steps give M on one side and W on the other as the outline is traced; the alpha ancient of the Greeks were Δ thus delienated which indicated that the language remotely read both ways, as did the Δ gyptian, Chinese, Hebrew and others, the two alpha banner tops put in position is with the base lines removed the typical M and W of this epoch, the upright lime is an F and the flag part an a, which gives Fa the names of God as in its primitive name is kept by the Chinese and Japanese now. When taken over by the Fenicians in the form of rum it was supposed by modern writers to resemble ripples, hence the name mem = the waters, in Gk. mu, and nu—which indicated waters applied to Nile and mare, the ocean.— | and | — is the letter symbols in the line language of spelling the names of Noah and Ham with the two Hebrew symbols that are in each $n = Nh$, and $m = Hm$, which in the line language is simply one of the two names read forward gives the father and the other the son by reading from right to left—1. And continuing our minuscule may be traced through the Irish semi-uncial and the Caroline minuscule from the old Roman cursive, and other alphabet (that more properly should be read alphabets). The line of B = ∞ , is an m and n, interchangeable, also F, I, J, H.

The sound of m is defined as a labial of the nasal class: that is, if the vocal organs are placed in the position to pronounce the labial b, and the breath is allowed to pass into the nose, the sound produced is that of m. Hence m had great attraction for b, as in limb, nimble, from A. S. lim and nimol, or in number, from Latin numerus. Sometimes m becomes b, as in marble from marmor. So also we find the two nasals, m and n, interchanging according to the nature of the contiguous consonants. Thus n changes to m before a labial, as in inperator for imperator, while m changes to n before gutturals and dentals, as in conjux and concordia, ih in ant from O. E. aemetete, ransom from redemptionem, and count from computare.

N

the fourteenth letter in our alphabet language made up of all languages on earth, is derived from the primitive O in its first change to B = ∞ = B, from Δ primitive and M = Ψ from which is waters, as mA from sin and shin of Arabs, and older s an s c: from Abyssinian, Chaldee, Charlemagne r, m, k, i, Chinese radical 47, Hebrew Olcf, m, a, f and s, Irish m, Illyrian z, x, m, s, and f, Japanese oop-pah = a basin and tsoon = common, Monks N, Norman B, Fenician C, Persian sin, shin, Russian ze-mlia, Samaritan a, h, hh, s, t, sch, r the tidal wave Swedish hh, s, and f, Tamulic na by comparison with those symbols that most resemble water and N. The sound of N is a nasal dental and produced when the organs are in position to pronounce d, and breath passed into nose. Hence n attracts d, as in expound from expono, sound from sonus, thunder from thunor, hind from O. E. hine, M and N are interchanged according to



the nature of the following consonant. If it is a labial n it changes to m, as in hemp from Old English hancp, or comfort from comfotare: but if it is a dental m changes to n, as in ant from O. E. æmete, or count from computare. We also find an intrusive n before gutturals and dentals, as in nightingale from Old English nihtegale, messenger from messenger, passenger from passager, or lantern from laterna.



is the first letter symbol GOD gave to Ava and Adam in the garden of Eden and is very prominent on the Egyptian tombs and other inscriptions its divine meaning is ONE GOD for all sons and daughters of mankind; its count is 1000 as a numeral—it is the end of the Roll of laws and Commandments written by Deity's own hand; its name is F and pronounced Fa=β in the Chinese language and is FA=) in Japanese script. The heavens by day display its picture that we call Sun and at night it is seen in the planets of the Moon and Stars. It is the first letter of Omnipresent, Omniscient and Omnipotent GOD.

God's Prayer for mankind and creation has inside of it the numeral II which, when counted with the circle denotes Trinity.

It is called Ayin the eye in Semetic language and is anatomically the pupil of the eye an old form $\circ = \text{r} = \text{l}$ that was called incorrectly the oldest is a picture of the eye of cats, and designates sex; mouth, and was used for the name of the Lord in the history of creation. The Fœnicians who transmitted it to the Greeks that used the symbol for \circ and ou, and \circ , which they required. In the earliest Greek that were co-existent with the pyramid builders as were the Hebrews, and probably conversant with the primitive alphabet, used \circ to represent all three sounds. About 550 B. C., "the symbol was differentiated the closed form \circ called omicron, or little \circ , being appropriate for the short \circ , while it was opened out at the bottom for long \circ or Omega," is not correct but they copied the three small \circ 's in a part of the primitive M= Ψ and retained the upper portion which they turned upside down forming the Omega= Ω , or great Ω . In the Italic alphabets said to have been obtained from Greece before the invention of the omega, only the first of these symbols appears, whereas in the Runes, which were obtained at a somewhat later date, the vowel \circ is expressed by a symbol derived from omega. In our English alphabet, returning to primitive, this letter has been more stable than in any other, except the primitive. Its form is the same as found on the Moabite stone whose nation was conversant with the primitive alphabet, commands and laws, and its value agrees with the same in Greek and Latin, while it is the only English vowel which normally possesses the same sound which it has in French, German, and other modern continental tongues or languages. The sound is intermediate between a and u, and may arise out of either—i. e. it may represent an Anglo-Saxon a or u as well as an Anglo-Saxon \circ . In English it has three values: the name-sound heard in note, which is described without knowledge as the original sound, the shorter sound heard in not, and the neutral sound heard in son, which is not strictly correct as the sound was from Fa Fo Fa. In English the name sound may be represented in ten ways, as in the words pile, goat, the, yeoman, sow, sew, hautboy, beau, owe, and through. The Egyptian numeral 10, its literal meaning is ONE GOD.

See p. 381. This book in every home a test by which to separate the wheat from the chaff, tares and cockle, a crucible by which to separate the gold from the dross and base metal, or the cupel by which to try the current course of politics, and a school Text Book by which to judge of the orthodoxy or political disquisitions, orthodoxy of Church teachings that usurp attributes of Deity.

I. Sir Anthony Cook, Preceptor to Edward VI. m. Had: Mildred, m. Burleigh: Anne, m. Sir Nicholas Bacon: Elizabeth, m. Sir John Russell: Catherine, m. Sir Henry Killigrew: II. Robert, educated at Oxford, as able Divine, m. Elizabeth, da. Wm. & Jane (Haynes) Samwell: d. 1614: Had: III. Francis of Plymouth 1620, m. Had: IV. Richard (Aaron) Rep. Dover, m. Had: V. Elisha, (Elkanah) m. Had: VI. Meddlecott, Grad. 1723, Har. Coll., m. Had: VII, Capt. James, b. Nov. 1728, the Navigator, m. da. Capt. Furnace=Furneaux=Fernel of Marble Head, Had chn. He was given a Medal of Honor. Pensioned by the king, £200: chn. £25 each: VIII. Joseph Coock, of Middleton Town, U. S. A., C. m. Had chn. IX. Robert Joseph m. da. Samuel Jones, Had: X. Louis, m. Had: XI. Maria, m. Uncle George C. Pike. Part of facts in stolen, MSS. Records showing relationship of the hon. F. A. Cook, discoverer of North Pole to line, recovered too late to print on page 392. 44 by name Grad. in N. E. Coll. 11 were ministers.



P is the sixteenth letter in our alphabet. The symbol was derived from the hieroglyphic picture of Trinity in the 3d letter of the Primitive Alphabet by removing the left upper portions of the arch and the straight line below and then placing them in position, as $\Psi = \text{p}$; from the Arabic he and lam, but not in old Arabic: Chaldean q: 2. Radical of Chinese; Old English P, English, French P, Georgian b and zz, German p and Rho of the Greek: quof of Hebrew; P of Irish, right part of v, andy, in Illyrian; Japanese 14 symbol ka, or, me, may, can, a moscheto also by addition of two more lines or crowns=ga, a goose; Monks P; Norman c, n, r, Fenician k, Persian dal, and zal, Roman p, Saracen m, Slavonic part of a, m, s, and si; Saxon P. It is the base line and half circle of the B in Genesis of first word Brasft. The sound of p is the sharp labial mute. Hence it is interchangeable with other labials, especially with the flat labial mute. Most languages gives a preference to one of these two sounds. Thus the Etruscans preferred p and have no b in their alphabet, whereas the teutonic dislike p, especially as a n initial. Only six primitive Teutonic words, probably loan words, begin with p, and in Beowulf and Cædmon, taken together, only three such words are found. In Moeso-Gothic the Greek p was used by Ulphilas, but only for foreign words, such as Paul, Pontius Pilate, prophet and presbyter. Most of our English words begin with p, such as plough, parish, people or princes are loan words from Greek, Latin or Celtic. A "primitive Aryan p corresponds to a Teutonic f, and it is only a primitive b, a very rare letter, which can correspond to a Teutonic p. A Welsh p corresponds to a Gaelic c and an English F. Thus, the Gaelic mac=son, is the Welsh map or ap. The Gaelic cethair is the Welsh pedwar, and the English four; and the Gaelic coic is the Welsh pump and English five. Owing to French influence the English prejudice against p begins to disappear in the 13th century, and we get gossip instead of older godsib, apricot for abricot, and purse for borse, though even here the b is retained in disburse. A p also intrudes between m and t, as in empty for O. E. oemtig, and tempt from the Old French tenter. In Latin p intrudes also between m and l, as in the words exemplum and templum. In like cases, as in humble for humilis, b is usually the intrusive letter in English words.

Q is the seventeenth letter of our alphabet. The symbol was derived from the Primitive Sacred O=F and only changed by adding in the capital a reversed letter s which is formed by union of two c's; it was taken over by the Fenicians (supposed) as the letter quoph, which became koppa among the Greeks. It was disused among the Ionian Gks. before the middle of the 5th century B. C., keeping its place only as a numeral. It was retained for a while in the Dorian alphabet, lingering longest on the coins of Corinth. On the coins of Syracuse it was replaced by k about 480 B. C. In the Italian alphabet that was obtained from the Greeks or Greece before the letter was disused, the symbol was appropriated Latin sound of the velar gutural kw. The letter q is absent from the Anglo-Saxon alphabet, in which the sound was expressed by the cw as in cwen for queen, and cwic for quick. It makes its appearance about 1160, and at first was only used for Latin or French words, such as quarter or quarrel. Before the close of the 13th century it was adopted in genuine English words, such as qualm, quell, quick and queen. In Scotland it replaced the hw, as in quhat for hwat (what). It is also derived as heretofore stated from the Greek old ph which by separating gives the modern q and p. In English it is always followed by u.

R is the eighteenth letter of our alphabet and is a descendant of sections of the first primitive O, also of 3d primitive M after which I find it in the Bible of





the three primitive letters in form of an egg or oval. It is employed to represent Lord God: mouth, eye, etc. In ancient Ægyptian the distinction was a dot in the centre, causing it to more perfectly resemble the eye, and on the history of creation it has three upright lines that read double, viz: Lord God Trinity, and Fo instructions to Noah to build the Ark three stories high. Both sounds of l and r are liquid trills, the breath escaping over the vibrating edges of the tongue-tip and sides. Consequently the hieroglyphic picture of the lioness from which our letter l was derived, or stated to be, was used interchangeable with r ¶ l = Δ, which we moderns have here differentiated. In the early Greek as in the Fœnician the forms of b, d and r differed but little, and confusion arose. Hence the sign was differentiated in various ways. In the early Greek which found its way into Italy, the tail of the P was curved towards it, giving form of B, while for d the tail was shortened and finally disappeared, giving D. For r a short tail was added, giving P abbreviated, which ultimately became R, while the form P was retained to represent r in the Eastern alphabets and in the Western to represent p. The tail of R began to make its appearance in the Greek alphabet before it was transmitted to Italy, but subsequently disappeared, other ways of avoiding the confusion having been invented. For the lapidary and capital forms the old R has been retained, but in minuscule writing we use r and r, the first of which is an uncial form derived from R; the second, called the r rotunda, coming from the old Roman cursive, in which the vertical stroke of P has nearly disappeared, being represented by the small tag at the top of r. (Author is not responsible for typographical errors in this book.)

The sound of r is a true consonant in the north of England, where it is exaggerated in the Northumberland burr. In Sanskrit it is vocalic; in the South of England it is often reduced to a semi-vowel or even to a vowel; while in the Midlands, in Scotland and in France it preserves the proper sound of a trilled liquid which it had in Latin and Anglo-Saxon. After a guttural vowel it is hardly heard, father being almost indistinguishable from farther. The Irish r is a survival of the old English sound, the pronunciation harum for harm, arum for arm, and boren for born reproducing, it is believed, mediæval English sound, which is now resonant less than formerly. The sounds of r and l are often interchanged. In the Indian alphabet the Semitic or Hamitic symbol for r represents l. The Japanese sign for r was obtained from the Chinese l, and some Polynesian and South African people replace r for the easier sound of l, as is also done by English children, who, however, often prefer w, saying vewy for very. The sound of r is usually the last which children learn to pronounce. In English l frequently replaces r and occasionally r replaces l, as in turban from tolibant. Sometimes r disappears as in speak from O. E. spræcan, pin from preon, palsy from paralysie, and cockade from O. Fr. cocart. It is intrusive in shrill from O. E. schill, in hoarse from hos, in partridge from Lat. pedrix, in cartridge from Fr. cartouche, in corporal from Fr. caporal, and in culprit from Lat. Culpa. It is also intrusive in Iron and in Bridegroom. There is modern tendency to insert a final r, as in taters for potatoes and Victoriar for Victoria. In the words our, your, their, her, the r is transposed, as in horse from hross. In Latin r supplants s between two vowels and sometimes at the end of words, as arena for asena, dari for dasi, plurima for plusima, honor for honos, arbor for arbos.

“Salus populi est lex suprema.” Judge Blackstone says: “Every man, when he enters into society, gives up a part of his natural liberty; as a price of so valuable purchase; and in consideration of receiving the advantages of mutual commerce obliges himself to conform to those laws which the community has thought proper to establish.” □ Proof of □ four-LINES GENEALOGY corresponds.



S the nineteenth letter in our own and most western alphabet is descended from the right side of the 3d primitive letter Ψ and found continued in the Greek sigma from shin, the twenty-first Semitic letter. The Fœnician symbol ω supposed to have arisen out of the hieratic form of the hieroglyphic picture of plants in an inundated garden. It came down from the steps pyramid of Ægypt and Roman cursive into our long S, the tick on the left of f being a surviving vestige of the lower curve of s which when separated in the center horizontally gives two letters C, and G, which are the initials of Creator God and son Christ. The sound of S is the hard open sibilant—a hiss formed by bringing the blade of the tongue near the front of the palate—the sound of z being the corresponding soft open sibilant. In Latin the sound of z does not exist, consequently the letter disappeared, and in its place in the alphabet was taken by the new letter g. In the time of Cicero it was reintroduced for the transliteration of Greek words. Anglo-Saxon, also, had no z, the letter being introduced for the representation of Greek and French words, such as zone, zest, or zeal. But, although we now possess the letter we are chary of its use, and its sound is constantly represented by s, as in reason, rose, rise. We use s both in hiss and his, in hearse and hers, in curse and curs, in loose and lose, though in one case the sound is that of s and the other of z. Few English genuine words have z, though in some cases, such as freeze and dizzy, owing to Norman influence, a z has replaced an old English s. Sometimes, as in sugar and sure, s has the sound of sh or zh, a sound that usually arises from the softening of the Anglo-Saxon sc, as in shall from sceal, shame from scamu, fish from fisc, shade from scadu, or sheep from scep. This change is characteristic of southern dialects, the northern Skipton (sheeptun) answering to the southern Shipton. So skipper and Shipper are doublets, obtained from the northern and southern forms of the same word. Occasionally the Anglo-Saxon form is preserved, as in scar and score, or is replaced by sk, as in skin. Owing to French influence c acquires a sibilant sound before e and i, and hence in a few words an Anglo-Saxon s has been replaced by c, as in mice, from A. S. mys, or once from ones. A final s sometimes disappears owing to its having been mistaken for the sign of the plural, as in pea from the O. F. peis (Latin pisum), peas or pease being regarded as a plural, of which pea was erroneously supposed to be the singular. In the same way the French cerise and relais have given us cherry and relay, the final s in cherries and relays being regarded as the plural sign. Occasionally s is intrusive as in island, from A. S. e-a-land, an error due to the false analogy of isle which comes from insula; or in aisle from the French aile, or in splash for plash, where the s seems to be an intensive. In Greek and Welsh s weakens to h, as is seen by comparing the Greek hepta with the Latin septem, or the Welsh hen with the Irish sen. A German s may represent an English t, as in wasser for water, or heiss for hot. In Latin an s changed a preceding b to f and m to n, as in scripsi from scribo, and consul from cemsul; and it assimilated a preceding t or d, as in cessum for cedsum, and mons for monts. Before m, n, d, l, r a medial s disappears, as in judex for jusdex, or idem for isdem. A final s sometimes disappears, as in ipse for ipsus; and between two vowels it becomes r, as in aurum for ausum, or aurora for ausosa.

SS, Color of, a collar composed of a series of the letter S in gold, either linked together or set in close order. Such collars have been worn much in England by persons holding great offices in the State—Ancestor Sir Thomas More! (See plate 1234, p. 240) Genealogy line in Chart. pi-US x & vat. refused to sign with representatives of 1,160,000,000 for MONUMENTS, & 1,411,171,381 for PURITY.





T is the twentieth letter in our alphabet which is derived from the second, also the third primitive Sacred Symbols of A and M by placing the horizontal line at the top of A, also by raising one of the upright lines to a horizontal position thus, A. T. which the Greeks give the name tau. It is found on the Moabite Stone of Genealogy, the Baal Lebanon Inscription, and those from Thera with the form T, in Arabic ta and da, and old Arabic in a, Chaldean d, z, q, Charlemagne l, 3 letters in Cherokee, French T, Georgian hha, German tay, Gothic g, t, w, Hebrew Coin v, h, hh, Irish minuscule F, i, r, l, and a line writing, Illyrian s, i, s, f, Japanese l meaning the gall, Monks t, Norman z, Saracen v. r, Sclavonian o, z, he, pi, Saxon t, Syriac tamulic ta, Thibetian k, are all samples of like descendant formation.

The sound of T is that of a hard dental mute, and is produced by the tip of the tongue being brought into contact with the base of the upper teeth, or, as in trance, with the front of the hard palate. The difference between d and t is that the first is voiced soft, and the second voiceless or hard. By Grimm Law a primitive t becomes th in Low German which is proved by 3d primitive alphabet Symbol T=∞=S T=Th, from √=∞=∞=□, and d in Old High German. Thus the Latin tu and tres, becomes thou and three in Eng., and du, and drei in German A primitive d becomes t in Low Ger., and t in Old High German.

Thus the Latin duo, decem and dens become two ten and tooth in Eng., and qwei, zehn and zahn in German. A primitive th (dh) becomes d in Low German, and t in Old High G. Thus the Gk. thugater is daughter in English, and tochter in German. The primitive T is in the Ægyptian is our D with the arch above, and a D with the arch pointing down.

A final, n, s or r often attracts an intrusive t, as in the words tyrant, parchment, cormorant, ancient, pheasant, against, amongst, acicid, behest or thuart. A final t sometimes disappears, as in anvil or petty. A t followed by i or y may lapse into the sound of sh, as in nation; or if followed by u, sounded as iu, it may become tsh, as in nature. A final c may also become tch, as in thatch or watch. A t may become d, as has happened with the words proud, bud diamond and card; or d may become t, as in clot, abbot and partridge. In Latin a t is assimilated before s, as in missi, from mitto, and at the end of a word only one s is retained, thus giving virtus for virtut-s, sors for sort-s, or compos for compot-s. English, Welsh, Spanish and Greek are the only languages that possess the difficult aspirated sound of th. In French loan-words, as the and theologie, the th is pronounced as t, and the same is now the case in German, as in the words thal, their and thun (now often spelt tal, tier, tun.)

V is the twenty-first letter in our own alphabet that was derived from the Sacred Primitive Alphabet, 3d letter Symbol, which only consists of cutting off the top and bottom parts. Also from the 2d by removing base line and inverting it which forms the historic vau whose direct ancestor and descendant is F, which will continue to retain its place as the sixth letter of our own alphabet. The vau was affixed to "the Ægyptian hieroglyphic picture of the Cerastes or horned asp which the writers give the value of f that was applied to the Fabi family. The two bars equal to the authors are the horns and the upright line the body of the snake," which trash with the absurdities of mythological history it is about time to be expunged by properly educated persons. i, In Y we have the degraded part of 3d symbol of primitive alphabet, as one in the line and the portions representing God and Christ is removed, to be followed in this century



❁ ❁ ❁

Why removal of Hebrew, Roman Catholic and Protestant Bibles from our Schools in harmony with the hypocrites that profess to worship God live in contention with better christians than they are themselves, which I leave to be settled by God. From the Fœnician symbol, whose form was intermediate between F and y, the Greeks evolved two characters,—one was the

Diagamma which had a consonantal sound, and was carried to Italy before it fell out of alphabetical use in Greece, and survives as our F; the other was a sign called upsilon, which at first resembled our y, but soon lost its tail, and took the form of v, which had the value of V, and VV, also U. The form v was carried to Italy, where it represented the sound u and our w. From the form V, the lapidary and capital, the cursive and uncial forms U and u were developed. In the 10th century the capital V began to be preferred for initials, and the uncial form for medials, and the consonant being more common at the beginning of Latin words, and the vowel in the middle, the initial form V gradually appropriated as the symbol for the consonant, and the medial form u as the symbol for the vowel. But the old usage long survived. Thus as late as 1611 v and u were still used in King James's Bible merely as initials and medials, as is shown by such spelling as vnto and hauce. In modern English the letter has three sounds, the long u, short u, and the neutral vowel. The long u, heard in the word rude, has the sound of the A. S. u, which in southern English has usually become a diphthong, represented by ou, as in the words thou, house, mouse, written thu, hus, mus in A. S., or by ow, as in the words how, now, cow, prow, town, written, hu, nu, cu, bru and tun in A. S. In northern English the old sound is frequently retained cow, house, town, as coo, hoose and toon. The short A. S. u has in a few cases retained its sound, as in full, bollock, but, like the long u, it has frequently lapsed into the neutral vowel, as in sun and hunger (A. S. sunne and hungor). This sound is more commonly represented by o, as in son and some, A. S. sunu, and sum. Here again the old sound is occasionally retained in the northern English, as in come, A. S. cuman, pronounced coom. In French (as in du) and in Welsh u has a narrow sound unknown in English (though common among the lower classes in some parts of Scotland), which is nearly the same as that in the German u of Muller. The peculiar sound of u in duke is due to the fact it is a loan-word from the French duc. The German and Italian u is the long u in brute.

White the twenty-second letter of our alphabet was derived from the 2d of Sacred Primitive Alphabet, the A inverted without the cross line. The English sounds of f and v are closely related: they are both labio-dentals, formed by bringing the lower lip into contact with the upper teeth, v being the soft or voiced sound, and f the hard or unvoiced sound. This close relation of the sounds explains the derivation of one form from the other, and accounts for the fact that in the Anglo-Saxon alphabet there was no separate sound for v, the symbol of f representing both sounds as indicated by the fact that in A. S. the Latin words Virgilius and leviticum were transliterated Firgilius and lufestice. It is believed that a medial f was pronounced as v, and an additional f as f. Thus in A. S. the words over, heaven and five are written ofer, hefon and fif. The symbol use of v is to denote the voiced labio-dental, is believed to be due to French influence, as it came soon after the Norman Conquest. Thus in the Peterborough Ms. of the Saxon Chronicle which was written before 1131, we find silver and lufe (love) replacing the seofor and lufe of the earlier copies. In Latin the consonantal sound of v was that of our w, as is shown among other proofs by the name of the letter which is ve. If the sound had been that of our v, which is a continuant, the name would have been ev, following the analogy of ef, es, and the



other continuants. But the name *ve*, originally pronounced *we*, follows the analogy of *be*, *pe*, and the other explosives, and hence the sound must have been that of *w*, an explosive. The change from the explosive to the continuant sound must have taken place in France before the Frankish conquest, and from France it came to us. In Germany the symbol *v* normally retains the old value *f*, our *v* sound being represented by *w*, (310 hours taken to correct a small error in Mss. by Author.)



the twenty-third letter of our alphabet is derived from the primitive sacred alphabet Δ that God made a counterpart of in Pyramid Lake, Oregon "In the land of Omo=Annona=America" U. S. A., which is the same picture symbolic, picture united with a pyramid of Δ gypt, indicative of the fall of the country of the antediluvians and Δ gypt by the same being turned upside down forming two V's completing our own sign of this

country's capitol Washington's initials, the father of the people after God, who has placed in the minds and desires of all his children to labor and aid with and for purity and universal good in impartial justice for all the descendants of ever, pure Ava; and Adam.

The V serpent story is a lineal descendant of the Serpent Mound earthly records at Adams county Ohio and Pyramid Lake memoranda and its pure deep waters without visible outlet. We may trace the *w* as kept by the primitive 2d and 3d letters of the alphabets of the world and its hidden histories made in prime essentials clear. *W* is like *ae*, a ligature-rather than a simple letter as is implied by the name *w*, or double *u*=double *vv*=*uu*, and minuscule omega of Greeks. In the very early West Saxon MSS. the sound is represented by *uu*, a digraph for which the Northumbrian rune *P*, called *wen* is a primitive representation of the Lake waters 2nd symbolic mounds of antediluvians; the sound under certain conditions is represented by the Ocean, whose mysterious voices, fill the mind with ideas of the grandure of our Creator, Omnipotent, -scient, -present GOD; the *wen* was used till the 13th century, except in Anglo-Norman MSS. such as Domesday Book, where the French scribes use *uu* for medials, and for initials the capital form *VV*, which, when ligatured, became our *W*. The sound, which is nearly that of the Greek digamma and of the Roman consonantal *V*, is produced by rounding the lips as in uttering *u*, and at the same time contracting the aperture and drawing in the cheeks, so that the breath cannot escape without friction.

When the sound is voiced we have *w*, as in the words *we* or *wen*, the corresponding unvoiced sound being *wh*, as in *when*, *which*, or *what*. The A. S. *hw* has now become *wh*, the aspiration being almost lost in the southern English, but in the north the old sound has been preserved, and we still hear *hwich* and *hwat* instead of *which* and *what*. In the old combination *wr* the symbol *w* has been preserved, but the sound has been lost, as in the words *wright*, *wrench*, *wrong*, *wrist*. The combination *cw* has become *qu*, as in *quo*th from *cwaeth*, *queen* for *cwen*. and *quench* from *cwencan* The *w* is occasionally intrusive, as in *whole* from *hal*, "and *whore* from *hore*." The intrusive *w* is probably due from analogy, and is useful as distinguishing the words from the homophones *hole* and *hoar*. A final *w* is vocalic, as in *few* and *new*, where the spellings are survivals from the A.S., *feawa*, and *niwe*, in which the *w* was a consonant. Here the consonantal sound has been lost, owing to the loss of the final colliding vowel. The lips were rounded to pronounce *u*, and then contracted to pronounce the following vowel, and when this disappeared only the sound of *u* was left. So in the French *oui* the sound of *w* is produced by rounding the lips to pronounce *ou* (our *u*) and by then narrowing them for the *i*. We find *w* in a few modern, French loan-words, such as *whist* and *whiskey*, but the sound is usually represented by *ou*, as in *Edouard*. In the old French loan-words an initial *w* was represented by *gu*, as *Guillaume* for *William*. In modern (history vs. superstitions)



Welsh a vocalic w, when short, has the sound of oo in good: when long, oo in boon.

X is the twenty-fourth letter in our alphabet and derived from the primitive A of the Sacred Alphabet symbol and V indicative of the fall of Adam, who opposed the Commands of God, also, it indicates the pyramid of Lake Oregon, and Ægypt: the point of the sword of evil opposed to the point of the sword of God: Affinity, etc.

In its descent we find more or less distinct forms in the following alphabets:—In the Arabic Nishki 24th called he and in the older 20th gc: Armenian 30th view and 35 pure=Gk. ph.: Seth alphabet a and ph; perfect q: Charlemagne less perfect y, in Chinese Radicals 11th, 24, 41, 52, 54, 56; Coptic ch; Cherokee X, and next letter is Δ the picture symbol of Oregon L. pyramid; Dalmatian i perfect with base lines: X of Abbe Barthalemi, called Ægyptian; Old English perfect: French X: Gothic ch, perfect: Greek Chi; Hebrew coin taww X; (when perfect or nearly so it is indicated by the letter) Japanese, noo, or noog=embroidery: Norman h: Foenician t; Persian min and ha; Runic, a part of h, and y; Russian khier X; Samaritan v; Saracen y=X; Saxon X. In the Greek the sound is ch. In the original Italic the letter existed, disused, and readopted, it was xi and in 15th place Quintilian proved the preceding facts; it is found in an inscription written 186 B. C., and in an undated inscription that was supposed to have been 30 years earlier. In modern English it, x, has the value of ks, which it had in the Anglo Saxon; except at the beginning of a word, where it is pronounced like z. In Italian x has been replaced by ss, parts of 3d primitive M, as in massimo for maximus. In French ss sometimes replaces x, as in cuisine, and laisser, from coxa, and laxare, while as may become ux, as in yeux, eux, deux, and epoux. In Spanish x had the power of the German ch, but the Spanish Academy has decreed its replacement by j; Mexico, Xalapa, and Don Quixote being now spelt Mejico, Jalapa, and Don Quijote. As a numeral X stands for 10. X is an abbreviation taken from the PIKES* name, one date on a Lamp, 200 years B. C., that is erroneously used to represent Christ—hence Xian, Xmas: x in Algebra is the first of the unknown quantities: and the use of X, XX, and XXX on barrels of alcoholics is a well-known way of indicating its quality. All of which has toxicological constituents, degrading men, destroying nations

U is the twenty-fifth letter of our alphabet and derived from the 3d symbol of the Primitive Sacred Alphabet, and the 2d, with the base of the pyramid attached to its apex lines. The Greek letter upsilon two, form of V, and Y; **the first was taken over into Italy with original value of u in rude, which it still retains, the U which resembles a bason, being analogous to Pyramid Lake without visible outlet. In the classical age the Greek upsilon had acquired a thinner sound, nearly that of the French ü, or the German U in über, the digraph ou being employed by the Greeks to represent the older sound, wh which had been preserved in Latin. In the time of Cicero the symbol Y was borrowed by the Romans from Grecian order to transliterate the upsilon in Greek loan-words, if their knowledge of the primitive alphabet had been lost, which is exceedingly doubtful, as on Dighton Rock was photographed by me characters that Marcus Agrippa Lucius Furnius was conversant with as is found in his chiseled inscription containing primitive language that Christ used when he conversed in "tongues." The Greek ou and o being transliterated by U, as in the word Lycurgus. The following alphabets contain some, and many all, of the Y parts or forms:—Arabic in dal and dhal: Old Arabic in g, and ch by raising them into position: Armenian in tzhah by placing it in Y position: Abyssinian, a part of 3d primitive M:

*See Plates 1216, page 234: **59 p. 26. To convince a stupid, bigoted man against his will leaves him of the same mind still.





in "Chaldian" o and Seth's n: Charlemagne in part of z: Chinese 9 & 11th Radicals: Babylonish a as arranged in Plate of Chinese Seals: in Cherokee; Dalmatian in n; French Y: Gothic in W: Greek y: Hebrew a, and q: Japanese, a part in 1 is, iro, a paint, 2 is iro, =various 3 is irodor, to paint, 4 idom=to excite, 5ii=to boil, 6 is lo=—a read, 7 hatsi—a bee; Monks Y; Persian dal, and zal Runic E, and k: Russian Y: Saxon Y;

That Y was introduced into Italy before O is shown by the relative position of the two letters in the alphabet. Our English use of y is unique. Save in a few exceptional cases where it is used, as in Latin, to transcribe literate Greek words, such as hypocritola, hydrostatics, tyrant, or hypocrite, it is not descended from the upsilon, but from the Greek gamma; g in middle English assuming a form which became so nearly identical with that of y that ultimately it replaced it, just as the resemblance of y to the rune thorn has led to our writing ye instead of the. The history of the change is curious. With the other Latin letters y was properly introduced into the Anglo-Saxon alphabet, retaining its Latin value, an i pronounced with the lips somewhat rounded; a sound which has passed into i or the neutral vowel, as in the words birth, wright, hill, king, evil, her, or worm, which were originally spelt with y. Hence as a matter of fact the Anglo-Saxon y has left no lineal descendants in any modern English word. Meanwhile another letter resembling the form of y, but representing a different sound, was being evolved out of the Anglo-Saxon g, which weakened before or after front vowels; and having thus acquired two values, its Anglo-Saxon form 3 was conveniently used to denote the weak sound, the Caroline form, g, being reserved for the stopped g. In Middle English this decayed sound was represented 3, and in the 15th century the written form of 3 and y approximated so closely as to be almost indistinguishable. Hence early in the 16th century, after the introduction of printing, the form y came to be generally used instead of 3, the Anglo-Saxon vocalic y being ultimately replaced by i, or some other vowel. Thus we obtained the double value of y in modern English. In such words as ye, yes, yea, yet, year, which represents the Anglo-Saxon ge, gese, gea, git, gear, the sign y is not really a y, but stands for the Middle English 3, which is the Anglo-Saxon form of g. A y appears before back vowels in young and yard owing to the loss of the front vowel in the Anglo-Saxon geong geard. It has also been introduced by analogy into the words yon and yew, from the Anglo-Saxon eow and cow, but not into the homophone ewe, from the Anglo-Saxon cowu. In some modern loan-words, such as yacht, yawl, and Yakut, it has been introduced to transliterate the continental j. The common English final y, also represents an Anglo-Saxon g, as in the words lady, army, many, busy, empty, body, day, key, may, say, gray, eye. By analogy it has crept into words of a different origin, such as Jolly (O. F. jolif) tardy (Fr. tardif) crockery, jetty, nunnery, and mummy. In by and my, and perhaps in sky, it has been introduced from analogy with such words as dry, fly, shy, where the y is really Middle English 3. In the 14th century a fashion set in of substituting the vocalic y for i.

This fashion disappeared in the 16th century, leaving a trace in the y of rhyme, a misspelling for rime, which has been retained owing to the erroneous notion that it was a loan-word from the Greek rythmos, and not the Anglo-Saxon rim. Also by analogy y represents the final vowel in such Greek loan-words as academy or irony. Our peculiar consonantal sound of v, due as we have seen to the weakening of the Anglo-Saxon g, is unknown on the Continent, where its place has been taken by the evolution of a consonantal j, as in jule and jahr, our yule and year. Our j is due to French influence as in the words Journey, jest, jewel, Jane. Italy replaced y by i. In other continental languages, few exceptions, it is normally used, as in Latin, for transliterating upsilon in Greek loan-words.





Z the twenty-sixth letter of our own alphabet was derived from the Universal Primitive Sacred Alphabet=AL—FA—B—ET Second Δ =A Symbol and consists of an equal division of the Noah and family inscription Pyramid and the God built Pyramid of Oregon Lake, United States of North America and the letter hieroglyphic is the initial of Zana da.twin Cain and Ca na fa ta far born daughter that united or married godly Abel, whose daughter Sana married ST =as we have the name SETH.

Component parts of this letter exist in every alphabet of the world that hath a straight or oblique line, and their blood flows in every human being upon the earth: that we call by the name Globe, which is in form like unto the symbol of the name of God in the first letter of the first alphabet whose *Ægyptian* meaning in our English is—"God the Pure God, the Trinity Created Woman and Man to Beget Christ the Son of God."

Now as the faithful and erudite Philologist has given us a harvest of excellent facts and data to honor him is our pleasure that all may be conversant with the many good and great things he has gleaned in the study of his fore parents graneries of wisdom and knowledge that the harvest might benefit and gladden his worthy descendants.

Therefore! But though in form and station zeta corresponds to zayin, yet through some confusion san acquired the name of zayin (ds), and zeta that of tsade (ts). In the old Italic "abecedaria" the letter Z occupies, like zeta, the seventh place, and the letter survived in Oscan, Umbrian, and Etruscan: but, as the sound did not exist in Latin, the letter was discarded, not later than the 3d century B. C., when its alphabetic station was usurped by the new letter G. In the first century B. C. it was reintroduced from Greece in the uncial form Z, in order to transliterate Greek words. Together with the symbol, the name zed was borrowed from the Greek zeta, whereas if the letter had been continuously retained in the Latin alphabet the name, following the analogy of the other Latin letters, would have been ez. It is curious that zed, the only Semetic letter came that we retain, should have belonged originally to the Fœnician letter which has disappeared in every European alphabet. It can hardly be said that z was an Anglo-Saxon letter, as it is only used in Biblical names, such as Zaccheus: even now it appears in very few native English words, the sound, when we have it, being usually represented by s, as in the words Wednesday, thousand, tongs, weeds, tease, cheese, knees, these, his, and is. We use it for words of Greek, Hebrew, and Arabic origin, such as zoology, zephyr, zeal, zany, Zedekiah, Zebulon, azure, zenith, magazine, gauze, zero, zodiac, or gazelle. Owing to French influence it has taken the place of s in a few English words, such as dizzy, frozen, hazel, squeeze, and sneeze: and it represents a French s in hazard, lizard, and buzzard. It is intrusive in citizen, from the French citizen. The sound of our z is a voiced sibilant, either a voiced s as in zeal, or a voiced sh as in azure, French sounds which we borrowed. The value in Latin and Greek is doubtful: probably it was either dz or zd. By Grimm's law a German z answers to an English t and a Latin d, as in the words zw ei, two, duo: or zahn, tooth, dens. The cedilla (ç) is a little zed, as is implied by the Italian name zediglia, from zeticula.

History is the preserver of the records of sciences, the latter often repaying the boon by verifying the annals of the former; and how beautiful do the examples we have given illustrate the truth, that all fragments of varied knowledge are but

"parts of one stupendous whole.
Whose body Nature is, and God the soul."



Chapter XXXII.

OUR TEARFULLY WE EARNESTLY GIVE THE THREE GREAT PETITIONS ALL OF THE GREAT WISDOM AND ACT THEM AT CONSTITUTIONS

TO THE HONORABLE SENATORS AND REPRESENTATIVES IN COMMONWEALTH OF MASSACHUSETTS.

THE NATIONAL AS FULLY ENJOY THIS BEST PROBLEM AND IN THEIR POWER TO ENFORCE THE HAGUE BY PERFECT LAWS.

Gentlemen:—

1. We, who have affixed our signatures, do most respectfully petition and pray for the framing and enactment of a law to constitutionally protect the majority of citizens and residents in and on our respectable streets against the evils of alcoholic beverages, stimulants, depressants and poisons that are derogatory to health, morality and happiness, and that are productive of lawlessness and crime and contrary to the Sixth commandment.

Double price charged, sworn to as pure alcohols, United States Dispensatory standard, on Stamp and names with value.

That unconstitutional license be revoked and tax with inspection be substituted.

All liquor saloons and places where alcoholic beverages are sold or dispensed shall be closed, sale and dispensation stopped by a petition of the majority of the persons engaged in a legitimate business within 250 yards of place of sale or dispensation and no sale within 100 yards of depot of Railroad Corporation: the petitioners for and against to be of eighteen years of age or more, and residents or doing business on the respectable street. That the law promptly go into effect upon its passage by revoking all the licenses and substituting a permit to sell until the expiration of time for said license, the petition Act to at once go into effect. All previous acts, declared and to be, null and void.

2. We, the people, do further petition and pray that a portion of the city may be set off for inmates of houses of ill fame, and all other persons of like character, and that each shall be inspected and treated, when found diseased, in a suitable place isolated from the other occupants, by a reputable physician, who may thus have the power to protect the health of innocent people, without condoned or licensed prostitution, as now exists. These persons who were all "born free and equal," shall pay a suitable tax for rental, clothes and maintenance. The real estate used for these persons taxed shall pay double, of its assessed value. All taxes payable to the state monthly. A religious church shall be formed in the reformatory. Each occupant of said house shall wear an insignia (not concealed) indicative of vocation. Upon reformation, the person shall be located one year before being allowed to appear in public without the emblem or insignia. This act shall go into effect upon its passage.

3. We, the people loyal and true to the Country and State, left in sacred trust to us by WASHINGTON and LAFAYETTE, do most respectfully petition and pray that an act or law may be framed for the protection of the innocent and helpless and for the dispensation of EQUAL AND IMPARTIAL JUSTICE, in accordance with the Sixth COMMANDMENT AND OUR CONSTITUTIONS.

That any person or persons aiding or abetting by requesting, advertising, giving or advising drugs, instruments, douches, applying for surgical examinations per vagina or in utero, giving the address of any person or place, or in any manner whatsoever assisting the destruction of the fetus or infant in any of the stages of uterine fecundation and ovum impregnation with criminal intent, shall be subjected to and sentenced as the principal in a fatal case of malpractice.

Absolutely necessary surgical operations for saving the life of the mother, unavoidable accidents, are to confer exemption from the penalty.

All applicants for the crime shall be promptly reported in writing by the person receiving the application and promptly prosecuted.

The infants may be wards of the State till twenty-one years old, unless the parent or parents do give satisfactory security for proper moral education and maintenance, and pay all expenses. Adoption may be permitted by the State any time; no claim by either parent for infant, unless by full and free consent by the adopting parent: all shall give satisfactory security to the State for the infant's proper moral education and support. The indigent married parent and the one wronged may be received and allowed to depart with confidence kept inviolate. A RELIGIOUS CHURCH AND HOSPITAL SHALL BE FORMED OF ALL DENOMINATIONS.

This act shall go properly into effect upon its passage.

Without bigotry, all brotherly kindness and love, honor, peacefully, wisely glean all the best from the declarations of rights, constitutions, laws, customs and habits of every nation, cull the most perfect parts to construct and frame a mutually satisfactory constitution for The Hague empowered to arbitrate in all cases of armaments, wars, rights, impartial, just, regulate commerce. Establish a Supreme Court for peace and good. From which there shall be no appeal. Its act final and unchangeable wisely conferring decrees.

The highest officials chosen from the most wise, just and honest of the world whose works, deeds, acts, private and national meet with the general or majority approval. Endowed with such authority and power requisite for maintaining peace on earth and having good will towards all mankind in impartial and enforced perfect justice. A plea honoring Uncle Sam for honorable peace against war.

Puerto Rico	1898,	sq. M.	3600
Panama	1897,	"	882
Philippines	1898,	"	143,000
Samoa Is.	1899,	"	73
A. S. Islands	1901,	"	68
Total			106,000
America of all nations is inhabited.			\$87,039,768

Panama	\$15,000,000	875,875	Sq. Miles,
Philippines	5,499,768	70,107	"
Samoa Is.	208,469	1846	"
A. S. Islands	523,802	1848	"
Total	18,250,000	1850	"
America of all nations is inhabited.	10,000,000	36,211	"
	7,200,000	394,436	"
		6,740	"

Florida	1803	purchase,
Louisiana	1819	"
Texas	1846	"
Oregon Territory	1846	"
California	1848	"
Mexican cession	1848	"
Texas	1850	"
California	1850	"
Alaska	1867	"
Hawaiian Islands	1897	"

ASSASSINATION GRACE GAVE

CHUSETTS ORABLE TORS FULLY UNTO ME

A

L

The Great Seal of

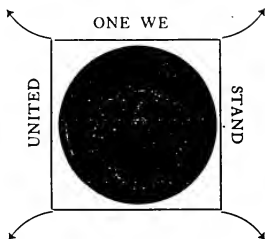

The Commonwealth
of Massachusetts to
Author in Honorium Et Memorium!

S

U

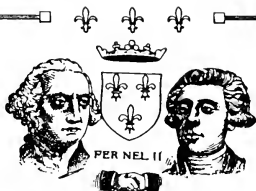

For Honorable Peace On Earth and Goodwill Toward All Mankind.

Addenda Et Corrigena

→Any errata within this book are the works of the quadruple Rum, Social, Evil and Malpractice Vile Ring in their unholy works to destroy the Nations, finally themselves.←



Esto Perpetua

→PATRIOTS, ONE AND ALL, READ, PONDER, REFLECT ON MATTERS IN THIS BOOK, THEN RESPLENDENT STAND BRAVELY, NOBLY FORTH: TRUE TO GOD, COUNTRY, STATE AND FAMILY, THUS WISELY REAP THE REWARD.←

Finis
The First Edition



HECKMAN
BINDERY INC.



NOV 87

N. MANCHESTER,
INDIANA 46962



