

LIBRARY USE ONLY.

BORA LASZIN LAW LIBRARY

NOV - 3 1992

FACULTY OF LAW
UNIVERSITY OF TORONTO



**REVISED REGULATIONS
OF ONTARIO, 1990**

**RÈGLEMENTS REFONDUS
DE L'ONTARIO DE 1990**

VOLUME 4

PRINTED BY THE
©QUEEN'S PRINTER FOR ONTARIO

IMPRIMÉ PAR
©L'IMPRIMEUR DE LA REINE POUR L'ONTARIO

TORONTO

1992

The Revised Regulations of Ontario, 1990 were prepared by the Commissioners appointed under the *Regulations Revision Act, 1989*.

Les Règlements refondus de l'Ontario de 1990 ont été préparés par les commissaires nommés en vertu de la *Loi de 1989 sur la refonte des règlements*.

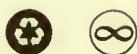

USER'S GUIDE TO THE REVISED REGULATIONS OF ONTARIO, 1990

Contents of the Revised Regulations of Ontario, 1990

The Revised Regulations of Ontario, 1990 contain the Regulations of Ontario filed before January 1, 1991, as arranged, consolidated and revised in accordance with the *Regulations Revision Act, 1989*. Regulations that are not of general application but that are still in force are listed in the Schedule contained in the final volume of these Revised Regulations. Obsolete regulations have been omitted from both the Revision and the Schedule. They have no further effect.

Regulations which have been amended or remade

Amendments made to the Regulations of Ontario on or after January 1, 1991, are not contained in the Revised Regulations of Ontario, 1990. Regulations which were in force on December 31, 1990 but which were revoked or remade between that date and September 1, 1991 are not contained in the Revised Regulations of Ontario, 1990. Amendments and remade regulations will be published as a supplementary revision in *The Ontario Gazette*.

To determine if a regulation contained in the Revised Regulations of Ontario, 1990 has been amended, refer to the Table of Regulations published in the most recent annual statute volume and in *The Ontario Gazette*. The table lists all of the regulations contained in the Revised Regulations of Ontario, 1990, and all regulations filed on or after January 1, 1991, and shows whether or not a regulation has been amended, remade or revoked.

To determine if a regulation has been amended, remade, or revoked since the publication of the latest Table of Regulations, reference should be made to the weekly publications of *The Ontario Gazette*.

Arrangement of the Revised Regulations of Ontario, 1990

The Table of Regulations in each volume lists the statutes alphabetically in English and shows for each statute the regulations made under it.

A reader who knows the English title of an Act may find the regulations made under that Act by consulting the Table of Regulations. A reader who knows the French language subject-matter of an Act under which

GUIDE D'UTILISATION DES RÈGLEMENTS REFONDUS DE L'ONTARIO DE 1990

Contenu des Règlements refondus de l'Ontario de 1990

Les Règlements refondus de l'Ontario de 1990 rassemblent les règlements de l'Ontario déposés avant le 1^{er} janvier 1991, tels qu'ils ont été arrangés, codifiés et refondus conformément à la *Loi de 1989 sur la refonte des règlements*. Les règlements qui ne sont pas de portée générale, mais qui demeurent en vigueur, sont énumérés dans l'annexe qui se trouve dans le dernier volume du présent recueil. Les règlements caducs ont été omis du recueil et de l'annexe; ils n'ont plus d'effet juridique.

Règlements modifiés ou pris de nouveau

Les modifications apportées aux règlements de l'Ontario depuis le 1^{er} janvier 1991 ne figurent pas dans les Règlements refondus de l'Ontario de 1990. Les règlements qui étaient en vigueur le 31 décembre 1990 mais qui ont été abrogés ou pris de nouveau entre cette date et le 1^{er} septembre 1991 ne figurent pas non plus dans le recueil. Les modifications et les règlements pris de nouveau seront publiés à part à titre de refonte supplémentaire dans la *Gazette de l'Ontario*.

Pour déterminer si un règlement figurant dans les Règlements refondus de l'Ontario de 1990 a été modifié, il suffit de se reporter à la Table des règlements contenue dans le plus récent volume annuel des lois ainsi que dans la *Gazette de l'Ontario*. Cette table énumère tous les règlements contenus dans les Règlements refondus de l'Ontario de 1990 ainsi que tous les règlements déposés depuis le 1^{er} janvier 1991; elle indique également si un règlement a été modifié, pris de nouveau ou abrogé.

Pour déterminer si un règlement a été modifié, pris de nouveau ou abrogé depuis la publication de la plus récente Table des règlements, il faut se reporter aux publications hebdomadaires dans la *Gazette de l'Ontario*.

Agencement des Règlements refondus de l'Ontario de 1990

La *Table of Regulations* qui se trouve dans chaque volume énumère les Lois refondues de l'Ontario de 1990 par ordre alphabétique anglais et indique, à la suite de chaque loi, les règlements pris en application de celle-ci.

L'utilisateur qui connaît le titre anglais d'une loi peut trouver les règlements pris en application de celle-ci en consultant cette table. L'utilisateur qui connaît le titre français d'une loi en application de laquelle un règlement peut

a regulation may have been made may find the English title of the Act by consulting the *Table alphabétique des matières* in volume 9 and then cross-referencing to the Table of Statutes of the Revised Statutes of Ontario, 1990 which is also set out in volume 9.

Title Changes

The Revised Statutes of Ontario, 1990 changed the titles of several statutes. These include the *Agricultural Development Finance Act* (now *Province of Ontario Savings Office Act*), the *Apprenticeship and Tradesmen's Qualification Act* (now *Trades Qualification Act*) and the *Dog Licensing and Live Stock and Poultry Protection Act* (now *Livestock, Poultry and Honey Bee Protection Act*).

Minor changes have been made to the titles of other Acts. Regulations made under the former Act appear under the new title where the Commissioners are of the opinion the regulations still have effect.

Rules of Civil Procedure

The Rules of Civil Procedure made under the *Courts of Justice Act* are published in Volume 9.

Volume 9 of the Revised Regulations of Ontario, 1990

In addition to the Rules of Civil Procedure, Volume 9 of the Revised Regulations of Ontario, 1990 contains the following items that may be of interest:

1. A copy of the report of the Regulation Revision Commissioners on the Revised Regulations of Ontario, 1990.
2. The *Regulations Revision Act, 1989*, S.O. 1989, c. 82 under which the Revised Regulations of Ontario, 1990 were prepared is included for purposes of convenient reference.
3. A Schedule to the Revised Regulations of Ontario, 1990, which shows those regulations which remain in force until revocation or expiry but which are not set forth in full because they are not of general application.
4. A copy of the Table of Statutes from the Revised Statutes of Ontario, 1990 and a copy of the *Table alphabétique des matières*.

English and French Versions of Regulations

Regulations that were made in English and French appear in bilingual form in the Revised Regulations of Ontario, 1990. Regulations which were made in English only and

avoir été pris, peut trouver le titre anglais de la loi en consultant la Table alphabétique des matières qui se trouve dans le volume 9, puis en se reportant à la *Table of Statutes* contenue dans les Lois refondues de l'Ontario de 1990 qui est également reproduite dans le volume 9.

Changement de titres

Les Lois refondues de l'Ontario de 1990 ont modifié le titre anglais de plusieurs lois; par exemple : la loi intitulée *Agricultural Development Finance Act* (maintenant intitulée *Province of Ontario Savings Office Act*), *Apprenticeship and Tradesmen's Qualification Act* (maintenant *Trades Qualification Act*) et *Dog Licensing and Live Stock and Poultry Protection Act* (maintenant *Livestock, Poultry and Honey Bee Protection Act*).

Des modifications mineures ont aussi été apportées au titre d'autres lois. Les règlements pris en application des anciennes lois figurent sous le nouveau titre lorsque les commissaires sont d'avis que les règlements ont encore un effet juridique.

Règles de procédure civile

Les Règles de procédure civile prises en application de la *Loi sur les tribunaux judiciaires* sont publiées dans le volume 9.

Le volume 9 des Règlements refondus de l'Ontario de 1990

Outre les Règles de procédure civile, le volume 9 des Règlements refondus de l'Ontario de 1990 présente certains documents d'intérêt connexe :

1. Le rapport des commissaires chargés de préparer les Règlements refondus de l'Ontario de 1990.
2. Le texte de la *Loi de 1989 sur la refonte des règlements*, L.O. 1989, chap. 82, en vertu de laquelle les Règlements refondus de l'Ontario de 1990 ont été préparés, qui est reproduit à titre indicatif.
3. Une annexe aux Règlements refondus de l'Ontario de 1990 indiquant les règlements qui demeurent en vigueur jusqu'à leur abrogation ou leur expiration et qui ne sont pas reproduits en entier parce qu'ils ne sont pas de portée générale.
4. Le texte de la *Table of Statutes* figurant dans les Lois refondues de l'Ontario de 1990 ainsi que le texte de la *Table alphabétique des matières*.

Versions anglaise et française des règlements

Les règlements qui ont été pris en français et en anglais paraissent sous forme bilingue dans les Règlements refondus de l'Ontario de 1990. Les règlements qui n'ont été pris qu'en

for which there was no official French version on December 31, 1990, appear in English only. French versions of regulations are being prepared on a regular basis. To see if a French version has been made, the reader should follow the procedures described above under the heading "Regulations which have been amended or remade".

Citation of Regulations

A regulation in the Revised Regulations of Ontario, 1990, may be cited as "Revised Regulations of Ontario, 1990, Regulation (*number*)", as "Règlements refondus de l'Ontario de 1990, Règlement (*number*)", as "R.R.O. 1990, Reg. (*number*)" or as "R.R.O. 1990, Règl. (*number*)".

Organization of a Regulation

Every regulation is composed of numbered sections, cited as section 1, 2, 3, etc. Many sections are further divided into two or more subsections, cited as subsection (1), (2), (3), etc. Some sections and subsections also contain clauses (cited as clause (a), (b), (c), etc.), subclauses (cited as subclause (i), (ii), (iii), etc.), paragraphs (cited as paragraph 1, 2, 3, etc.) and subparagraphs (cited as subparagraph i, ii, iii, etc.). Further levels of division are possible, although they are rare.

Some regulations are divided into numbered Parts, cited as Part I, II, III, etc.

Some regulations contain a definition section that lists, in alphabetical order, definitions of terms used in the regulation. The definition section is usually at the beginning of the regulation, although definitions sometimes appear elsewhere. In a regulation that is divided into Parts, the first section of a Part often contains definitions of terms used in that Part.

Forms and Schedules to regulations usually appear at the end unless they are quite short.

Some regulations may contain a Table of Contents at the beginning of the regulation and in addition may have an index to Forms or Schedules if there are a large number of these items.

Headings

Headings in the body of a regulation do not form part of the regulation and should not be relied on as a means of interpreting the regu-

anglais et pour lesquels il n'existait aucune version française officielle le 31 décembre 1990, ne paraissent qu'en anglais. Une version française des règlements est en voie de préparation. Pour déterminer si une version française a été prise, l'utilisateur peut se reporter à la marche à suivre décrite ci-dessus sous la rubrique «Règlements modifiés ou pris de nouveau».

Citation des règlements

La citation d'un règlement des Règlements refondus de l'Ontario de 1990 peut se faire selon l'une des formules suivantes: «Règlements refondus de l'Ontario de 1990, Règlement (*numéro*)», «Revised Regulations of Ontario, 1990, Regulation (*numéro*)», «R.R.O. 1990, Règl. (*numéro*)», «R.R.O. 1990, Reg. (*numéro*)».

Division d'un règlement

Chaque règlement se compose d'articles numérotés que l'on cite ainsi: article 1, 2, 3, etc. Ces articles se divisent souvent en paragraphes cités ainsi: paragraphe (1), (2), (3), etc. Certains articles et certains paragraphes contiennent également des alinéas (cités ainsi: alinéa a), b), c), etc.), des sous-alinéas (cités ainsi: sous-alinéa (i), (ii), (iii), etc.), des dispositions (citées ainsi: disposition 1, 2, 3, etc.) et des sous-dispositions (citées ainsi: sous-disposition i, ii, iii, etc.). Des divisions plus poussées sont rares dans les textes législatifs.

Certains règlements sont également divisés en parties numérotées, citées ainsi: partie I, II, III, etc.

Certains règlements comportent une disposition qui énonce, par ordre alphabétique, la définition de certains termes utilisés dans les textes. Cette disposition se présente habituellement sous la forme d'un article placé au début du règlement, bien que certaines définitions puissent être placées ailleurs dans le texte. Dans un règlement qui est divisé en parties, le premier article d'une partie contient souvent la définition de termes utilisés dans celle-ci.

Les formules et les annexes qui font partie d'un règlement se trouvent généralement à la fin de celui-ci, à moins qu'elles ne soient très courtes.

Un sommaire figure parfois au début du règlement, ainsi qu'un index des formules ou des annexes s'il y en a un grand nombre.

Intertitres

Les intertitres d'un règlement ne font pas partie de celui-ci et ne doivent pas servir à l'interpréter. Ils ne servent qu'à faciliter l'utilisation du texte.

lation. They are included only for convenience of reference.

Historical references

Every section of every regulation in the Revised Regulations of Ontario, 1990, contains information to assist in tracing the history of the section. This historical information appears in the form of a citation, found at the end of every section and at the end of some subsections. A citation indicates the origin of the provisions between that citation and the previous citation.

For example, the historical reference "R.R.O. 1980, Reg. 1, s. 1" appears at the end of section 1 of Regulation 1, General, made under the *Abandoned Orchards Act*. This means that the provision has been carried forward without amendment from section 1 of Regulation 1 of the Revised Regulations of Ontario, 1980.

The historical reference "R.R.O. 1980, Reg. 1, s. 2, Sched. 1" appears at the end of section 2 of Regulation 1. This means that section 1 and Schedule 1 of Regulation 1 of the Revised Regulations of Ontario, 1980 have been combined.

The historical reference "O. Reg. 172/90, s. 1(1); O. Reg. 294/90, s. 1" appears at the end of subsection 1(1) of Regulation 5, Fees and Expenses — Justices of the Peace, made under the *Administration of Justice Act*. This means that subsection 1(1) of Regulation 5 as it was made by subsection 1(1) of Ontario Regulation 172/90 appears as it was amended by subsection 1(1) of Ontario Regulation 294/90.

Some historical references contain the word "revised". This means that the language of the former provision was significantly changed by the Commissioners who prepared the Revised Regulations of Ontario, 1990.

The historical references do not form part of the regulation and are included only for convenience of reference.

Interpretation Act

Readers of the Revised Regulations of Ontario, 1990, should be aware of the *Interpretation Act*, R.S.O. 1990, c. I.11. The Act contains a number of provisions that apply to the interpretation of regulations. For example, the Act contains definitions that apply to particular words and phrases used in all regulations, unless the context otherwise requires. It also contains provisions that may apply when a regulation is revoked and replaced by another regulation.

Notes historiques

Les articles de chaque règlement des Règlements refondus de l'Ontario de 1990 contiennent des renseignements qui permettent d'en retracer l'historique. Ces renseignements se trouvent, sous forme de citation, à la fin de chaque article et à la fin de certains paragraphes. La note historique indique l'origine des dispositions placées entre elle et la note précédente.

Par exemple, la note historique «R.R.O. 1980, Reg. 1, s. 1» paraît à la fin de l'article 1 du Règlement 1, «General», pris en application de la *Loi sur les vergers abandonnés*. Ceci signifie que cette disposition a été tirée sans modification de l'article 1 du Règlement 1 des Règlements refondus de l'Ontario de 1980.

La note historique «R.R.O. 1980, Reg. 1, s. 2, Sched. 1» paraît à la fin de l'article 2 du Règlement 1. Ceci signifie que l'article 1 et l'annexe 1 du Règlement 1 des Règlements refondus de l'Ontario de 1980 ont été combinés.

La note historique «Règl. de l'Ont. 172/90, par. 1 (1); Règl. de l'Ont. 294/90, art. 1» paraît à la fin du paragraphe 1 (1) du Règlement 5, «Fees and Expenses — Justices of the Peace», pris en application de la *Loi sur l'administration de la justice*. Ceci signifie que le paragraphe 1 (1) du Règlement 5 tel qu'il a été pris par le paragraphe 1 (1) du Règlement de l'Ontario 172/90 paraît tel qu'il a été modifié par le paragraphe 1 (1) du Règlement de l'Ontario 294/90.

Certaines notes historiques comportent le mot «révisé». Ceci signifie que la formulation de l'ancienne disposition a été remaniée sensiblement par les commissaires qui ont préparé les Règlements refondus de l'Ontario de 1990.

Les notes historiques ne font pas partie du texte des règlements et ne sont incluses que pour faciliter la consultation de ceux-ci.

Loi d'interprétation

Les usagers des Règlements refondus de l'Ontario de 1990 sont priés de tenir compte de la *Loi d'interprétation*, L.R.O. 1990, chap. I.11. Cette loi contient certaines dispositions qui s'appliquent à l'interprétation des règlements. Elle comporte, par exemple, des définitions qui s'appliquent aux termes et expressions utilisés dans tous les règlements, sauf lorsque le contexte exige un sens différent. Elle contient également des dispositions qui peuvent s'appliquer lorsqu'un règlement est abrogé et remplacé par un autre.

Other Laws

Readers are reminded that, in addition to Ontario regulations, particular legal issues may be affected by other kinds of laws, including the Constitution of Canada, statutes of the Parliament of Canada and the Legislature of Ontario, municipal by-laws and the common law.

Ministerial Responsibility for Regulations

Regulations are laws of Ontario. A validly made regulation has as much force in law as a statute. Regulations are all made under statutes that authorize their making. With the exception of a few statutes that are administered directly by the Legislative Assembly, every Act of the Legislature is administered through a ministry of the Ontario Government. The Ministry of Government Services publishes a brochure detailing which statutes are administered by each ministry. The brochure is entitled "Ministerial Responsibility for Acts".

Publications Ontario

Copies of the Revised Regulations of Ontario, 1990, individual regulations and other Government of Ontario publications may be obtained from Publications Ontario. Personal shopping is available at 880 Bay Street, Toronto. Customers may write to Publications Ontario, 5th Floor, 880 Bay Street, Toronto M7A 1N8. Orders may be placed by telephone at (416) 326-5300 or, toll-free in Ontario, 1-800-668-9938. Telephone Service for the hearing impaired is available at (416) 325-3408 or, toll-free in Ontario, 1-800-268-7095. Mastercard and Visa are accepted. Cheques and money orders should be made payable to the Treasurer of Ontario. Prepayment is required.

Autres lois

Certaines questions d'ordre juridique peuvent nécessiter, outre la consultation des Règlements de l'Ontario, celle d'autres textes, y compris la Constitution du Canada, les lois du Parlement du Canada et de la Législature de l'Ontario, les règlements municipaux, ainsi que le recours à la common law.

Responsabilité ministérielle pour les règlements

Les règlements sont des textes législatifs de l'Ontario. Un règlement valide a tout autant d'effet juridique qu'un texte de loi. Les règlements sont tous pris en application d'une loi qui autorise leur prise. À l'exception de quelques lois dont l'application relève directement de l'Assemblée législative, l'application des lois de la Législature se fait par l'entremise d'un ministère du gouvernement de l'Ontario. Le ministère des Services gouvernementaux publie une brochure intitulée «La responsabilité ministérielle pour les lois», qui fournit tous les renseignements utiles à cet égard.

Publications Ontario

On peut se procurer des exemplaires des Règlements refondus de l'Ontario de 1990, de règlements particuliers ainsi que d'autres publications du gouvernement de l'Ontario à Publications Ontario, 880, rue Bay, Toronto. On peut également écrire à Publications Ontario, 880, rue Bay, 5^e étage, Toronto (Ontario) M7A 1N8. Pour les commandes téléphoniques, composer le (416) 326-5300 ou, sans frais en Ontario, le 1-800-668-9938. Les malentendants peuvent composer le (416) 325-3408 ou, sans frais en Ontario, le 1-800-268-7095. Les cartes de crédit Mastercard et Visa sont acceptées. Faire le chèque ou le mandat à l'ordre du trésorier de l'Ontario. Le paiement est exigé d'avance.

TABLE OF REGULATIONS

REVISED REGULATIONS OF ONTARIO, 1990

The listings in this Table are, with few exceptions, in English only. As of the date of the revision (December 31, 1990), very few regulations had an official French version. The French and English titles are shown for those regulations adopted in both languages.

VOLUME 1	Reg.
Abandoned Orchards Act	
General	1
Administration of Justice Act	
Court Reporters and Court Monitors	2
Fee Payable to Small Claims Court Referees	3
Fees and Expenses—	
Jurors and Crown Witnesses	4
Justices of the Peace	5
Sheriff's Officers, Process Servers, Escorts and Municipal Police Forces	6
Fees—	
Construction Liens	7
Repair and Storage Liens Act	8
Unified Family Court	9
Investigation Fee—Official Guardian	10
Kilometre Allowances	11
Ontario Court (General Division)—Fees	12
Sheriffs—Fees	13
Small Claims Court—Fees and Allowances	14
Aggregate Resources Act	
General	15
Agricultural and Horticultural Organizations Act	
General	16
Names	17
Agricultural Tile Drainage Installation Act	
General	18
Ambulance Act	
General	19
Amusement Devices Act	
General	20
Anatomy Act	
General	21
Animals For Research Act	
General	22
Pounds	23
Research Facilities and Supply Facilities	24
Transportation	25
Apprenticeship and Tradesmen's Qualification Act	
— See Trades Qualification Act	
Arbitrations Act	
Fees Chargeable by Arbitrators	26
Architects Act	
General	27
Artificial Insemination of Livestock Act	
General	28
Assessment Act	
Application for Direction of School Support	29
Assessment Areas and Regions	30

TABLE DES RÈGLEMENTS

RÈGLEMENTS REFONDUS DE L'ONTARIO DE 1990

Les entrées de la présente Table sont, à peu d'exceptions près, en anglais seulement. En effet, seuls quelques règlements avaient, le 31 décembre 1990, une version française officielle. Les règlements pris sous forme bilingue sont indiqués sous leurs titres français et anglais.

	Reg.
Assessment Notices	31
Assessment Notices of Supplementary or Omitted Assessment	32
Equalization of Assessments (Various Municipalities) Under Subsection 63 (3) of the Act	33
Interior Information Questionnaire	34
Pipe Line Rates	35
Pipe Line Rates	36
Pipe Line Rates	37
Pipe Line Rates	38
Pipe Line Rates	39
Pipe Line Rates in Muskoka and Parry Sound	40
Pipe Line Rates in Part of the District of Algoma and Part of The Regional Municipality of Ottawa-Carleton	41
Pipe Line Rates in Parts of the Counties of Hastings and Simcoe and Parts of the United Counties of Prescott and Russell and Stormont, Dundas and Glengarry	42
Pipe Line Rates in Parts of the Counties of Peterborough, Simcoe and Victoria and in Parts of the Districts of Sudbury and Algoma	43
Pipe Line Rates in the County of Huron and Parts of the Counties of Haliburton, Hastings, Peterborough, Simcoe and Victoria and Part of the District of Timiskaming	44
Pipe Line Rates in The Regional Municipality of Sudbury	45
Pipe Line Rates Under Subsection 25 (16) of the Act	46
Pipe Line Rates Under Subsection 25 (17) of the Act	47
Property Income Questionnaire	48
Revision and Certification of Assessment Commissioner's List	49
Assessment Review Board Act	
Procedure	50
Athletics Control Act	
Amount of Tax	51
General	52
Bailiffs Act	
General	53
Beef Cattle Marketing Act	
Licence Fees	54
Weighing of Carcasses	55
Weighing of Live Cattle	56
Bees Act	
General	57
Blind Persons' Rights Act	
Guide Dogs	58
Boilers and Pressure Vessels Act	
General	59
Boundaries Act	
General	60

TABLE OF REGULATIONS

	Reg.		Reg.
Building Code Act		Condominium Act	
General	61	General	96
Business Corporations Act		Surveys and The Description	97
General	62	Conservation Authorities Act	
Cemeteries Act		Conservation Areas—	
Closings	63	Ausable-Bayfield	98
General	64	Catarqui Region	99
Trust Funds	65	Catfish Creek	100
Centennial Centre of Science and Technology Act		Central Lake Ontario	101
Fees	66	Credit Valley	102
Certification of Titles Act		Crowe Valley	103
General	67	Essex Region	104
Change of Name Act		Ganaraska Region	105
<i>Loi sur le changement de nom</i>		Grand River	106
General	68	Grey Sauble	107
Dispositions générales	68	Halton Region	108
Charitable Institutions Act		Hamilton Region	109
General	69	Kawartha Region	110
Child and Family Services Act		Kettle Creek	111
General	70	Lake Simcoe Region	112
Register	71	Lakehead Region	113
Children's Law Reform Act		Long Point Region	114
Forms	72	Lower Thames Valley	115
Chiropody Act		Lower Trent Region	116
General	73	Maitland Valley	117
Collection Agencies Act		Mattagami Region	118
General	74	Metropolitan Toronto and Region	119
Commercial Concentration Tax Act		Mississippi Valley	120
General	75	Moirra River	121
Commissioners for Taking Affidavits Act		Napanee Region	122
Fees	76	Niagara Peninsula	123
Commodity Boards and Marketing Agencies Act		Nickel District	124
Levies—		North Bay-Mattawa	125
Cream	77		
Milk	78		
Levies or Charges—			
Chicken	79		
Chicken (Over Quota)	80		
Cream	81		
Eggs	82		
Eggs (Over Quota)	83		
Fowl	84		
Hatching Eggs	85		
Hatching Eggs and Chicks (Over Quota)	86		
Milk	87		
Tobacco	88		
Turkeys	89		
Commodity Futures Act			
General	90		
Community Psychiatric Hospitals Act			
General	91		
Grants	92		
Community Recreation Centres Act			
General	93		
Compulsory Automobile Insurance Act			
Certificate of Insurance	94		
Exemptions	95		

VOLUME 2

Conservation Authorities Act (Continued)	
Conservation Areas—(Continued)	
North Grey Region	126
Nottawasaga Valley	127
Otonabee Region	128
Prince Edward Region	129
Rideau Valley	130
St. Clair Region	131
Sauble Valley	132
Saugeen Valley	133
Sault Ste. Marie Region	134
South Nation River	135
Upper Thames River	136
Fill—	
Grand Valley	137
Moirra River	138
Spencer Creek	139
Fill and Alteration to Waterways—	
Raisin Region	140
Sault Ste. Marie Region Conservation Authority	141
Fill, Construction and Alteration to Waterways—	
Ausable-Bayfield	142
Catarqui Region	143
Catfish Creek	144
Central Lake Ontario	145
Credit Valley	146
Essex Region	147
Ganaraska Region Conservation Authority	148
Grand River	149
Halton Region Conservation Authority	150
Hamilton Region	151
Kettle Creek	152
Lake Simcoe Region	153
Long Point Region Conservation Authority	154
Lower Thames Valley	155

TABLE DES RÈGLEMENTS

	Reg.		Reg.
Lower Trent Region	156	Rules of the Ontario Court (General Division) in Estate Proceedings	197
Mattagami Region	157	Rules of the Ontario Court (Provincial Division) in Appeals Under Section 135 of the Provincial Offences Act	198
Metropolitan Toronto and Region	158	Rules of the Ontario Court (Provincial Division) in Family Law Proceedings	199
Mississippi Valley (The)	159	Rules of the Ontario Court (Provincial Division) in Provincial Offences Proceedings	200
Napanee Region Conservation Authority	160	Rules of the Small Claims Court	201
Nickel District	161	Rules of the Unified Family Court	202
North Bay-Mattawa Conservation Authority	162	Salaries and Benefits of Masters	203
North Grey	163	Salaries and Benefits of Provincial Judges	204
Nottawasaga Valley	164	Small Claims Court Jurisdiction	205
Otonabee Region	165	Territorial Divisions for the Small Claims Court	206
Rideau Valley	166		
St. Clair Region	167		
Sauble Valley	168		
Saugeen Valley	169		
Upper Thames River	170		
Consolidated Hearings Act			
Aggregate Resources Act	171		
Conservation Authorities Act	172		
Hearings	173		
Lakes and Rivers Improvement Act	174		
Construction Lien Act			
General	175		
Consumer Protection Act			
General	176		
Consumer Reporting Act			
General	177		
Co-operative Corporations Act			
General	178		
Co-operative Loans Act			
General	179		
Coroners Act			
General	180		
Corporations Act			
General	181		
Corporations Information Act			
General	182		
Corporations Tax Act			
General	183		
Costs of Distress Act			
Costs	184		
Courts of Justice Act			
<i>Loi sur les tribunaux judiciaires</i>			
Bilingual Proceedings	185		
Designation of Regions	186		
District of Algoma Civil Case Management Rules	187		
Règles de gestion des causes civiles du district d'Algoma	187		
Duties of Clerks and Bailiffs of the Small Claims Court	188		
Essex Civil Case Management Rules	189		
Règles de gestion des causes civiles d'Essex	189		
Money Paid Into Court	190		
Number of Judges	191		
Part-Time Provincial Judges Authorized to Practise Law	192		
Provincial Judges Benefits	193		
Rules of Civil Procedure (See Volume 9)	194		
Règles de procédure civile (Voir Volume 9)	194		
Rules of the Court of Appeal in Appeals Under the Provincial Offences Act	195		
Rules of the Ontario Court (General Division) and the Ontario Court (Provincial Division) in Appeals Under Section 116 of the Provincial Offences Act	196		
		VOLUME 3	
		Credit Unions and Caisses Populaires Act	
		<i>Loi sur les caisses populaires et les credit unions</i>	
		Annual Premium	207
		Credit Union Leagues	208
		Fédérations de caisses	208
		Designations Under Section 85 of the Act	209
		General	210
		Dispositions générales	210
		Matching Assets	211
		Éléments d'actif correspondants	211
		Membership in Credit Union Leagues	212
		Adhésion aux fédérations de caisses	212
		Membership in Credit Unions	213
		Adhésion aux caisses	213
		Stabilization Funds	214
		Crop Insurance Act (Ontario)	
		Arbitration Proceedings	215
		Crop Insurance Plan—	
		Apples	216
		Asparagus	217
		Black Tobacco	218
		Burley Tobacco	219
		Carrots	220
		Coloured Beans	221
		Corn	222
		Cucumbers	223
		Flue-Cured Tobacco	224
		Forage Seeding Establishment	225
		Grapes	226
		Green and Wax Beans	227
		Greenhouse Vegetables	228
		Hay and Pasture	229
		Honey	230
		Lima Beans	231
		Oil Seed	232
		Onions	233
		Peaches	234
		Peanuts	235
		Pears	236
		Peas	237
		Peppers	238
		Plums	239
		Popping Corn	240
		Potatoes	241
		Pumpkins and Squash	242
		Red Beets	243
		Red Spring Wheat	244
		Rutabagas	245
		Seed Corn	246
		Sour Cherries	247
		Specialty Crops	248
		Spring Grain	249
		Sunflowers	250
		Sweet Cherries	251

TABLE OF REGULATIONS

	Reg.		Reg.
Sweet Corn	252	Fees for Ministry Courses	292
Tomatoes	253	Fees For Transcripts and Statements of Standing and for Duplicates of Diplomas, Certificates and Letters of Standing	293
White Beans	254	James Bay Lowlands Secondary School Board	294
Winter Wheat	255	Northern District School Area Board	295
Crop Insurance Plans—General	256	Ontario Schools for the Blind and the Deaf	296
Designation of Insurable Crops	257	Ontario Teacher's Qualifications	297
Crown Employees Collective Bargaining Act		Operation of Schools—General	298
General	258	Payment of Legislative Grants	299
Rules of Procedure	259	Practice and Procedure—Boards of Reference	300
Crown Timber Act		Pupil Records	301
General	260	Purchase of Milk	302
Dangerous Goods Transportation Act		Regional Tribunals	303
General	261	School Year and School Holidays	304
Day Nurseries Act		Special Education Identification Placement and Review Committees and Appeals	305
General	262	Special Education Programs and Services	306
Dead Animal Disposal Act		Special Grant	307
General	263	Supervised Alternative Learning for Excused Pupils	308
Dental Technicians Act		Supervisory Officers	309
General	264	Teachers' Contracts	310
Denture Therapists Act		Territory Without Municipal Organization Attached to a District Municipality	311
General	265	Training Assistance	312
Deposits Regulation Act		Trustee Distribution	313
General	266	Elderly Persons Centres Act	
Development Charges Act		General	314
Development Charges	267	Election Act	
Education Development Charges	268	Fees and Expenses	315
Development Corporations Act		Elevating Devices Act	
Innovation Ontario Corporation	269	General	316
Ontario Film Development Corporation (The)	270	Employee Share Ownership Plan Act	
Ontario International Corporation	271	Forms	317
Developmental Services Act		General	318
General	272	Employer Health Tax Act	
District Welfare Administration Boards Act		General	319
Application for Grant Under Section 10 of the Act	273	Employment Agencies Act	
Drainage Act		General	320
Forms	274	Employment Standards Act	
Rules of Practice and Procedure to be Followed in All Proceedings Before the Referee	275	Benefit Plans	321
Drugless Practitioners Act		Domestics, Nannies and Sitters	322
Chiropractors	276	Forms	323
Classifications	277	Fruit, Vegetable and Tobacco Harvesters	324
General	278	General	325
Masseurs	279	Residential Care Workers	326
Osteopaths	280	Termination of Employment	327
Physiotherapists	281	Endangered Species Act	
Edible Oil Products Act		Endangered Species	328
General	282	Energy Act	
Education Act		Fuel Oil Code	329
Calculation of Amount of Reserve or Reduction in Requirement Resulting from Strike or Lock-out	283	Gas Pipeline Systems	330
Conditions for Extended Funding	284	Gas Utilization Code	331
Continuing Education	285	Oil Pipeline Systems	332
County Combined Separate School Zones	286	Propane Storage, Handling and Utilization Code	333
Designation of School Divisions	287	Environmental Assessment Act	
Designation of Support Staff	288	General	334
Designation of Teachers	289	Rules of Practice—Environmental Assessment Board	335
District Combined Separate School Zones	290	Environmental Protection Act	
District School Areas	291	Air Contaminants From Ferrous Foundries	336
		Ambient Air Quality Criteria	337
		Boilers	338
		Classes of Contaminants—Exemptions	339

TABLE DES RÉGLEMENTS

	Reg.		Reg.
Containers	340	Plan	388
Deep Well Disposal	341	Arbitration of Disputes	389
Designation of Waste	342	Asparagus—	
Discharge of Sewage From Pleasure Boats	343	Marketing	390
Disposable Containers for Milk	344	Plan	391
Disposable Paper Containers for Milk	345	Beans—	
General—Air Pollution	346	Marketing	392
General—Waste Management	347	Plan	393
Hauled Liquid Industrial Waste Disposal Sites	348	Berries for Processing—	
Hot Mix Asphalt Facilities	349	Marketing	394
Lambton Industry Meteorological Alert	350	Plan	395
Marinas	351	Broiler Hatching Eggs and Chicks—	
Mobile PCB Destruction Facilities	352	Marketing	396
Motor Vehicles	353	Plan	397
Municipal Sewage and Water and Roads Class Environmental Assessment Project	354	Burley Tobacco—	
Ontario Hydro	355	Marketing	398
Ozone Depleting Substances—General	356	Plan	399
Refillable Containers for Carbonated Soft Drink	357	By-Laws for Local Boards	400
Sewage Systems	358	Chicken—Extension of Powers of the Canadian Chicken Marketing Agency	401
Sewage Systems—Exemptions	359	Chickens—	
Spills	360	Marketing	402
Sulphur Content of Fuels	361	Plan	403
Waste Management—PCB's	362	Designation—	
Expropriations Act		Ontario Canola Growers' Association	404
Forms	363	Ontario Coloured Bean Growers' Association	405
Rules to be Applied for the Purposes of Subsection 32 (1) of the Act	364	Eggs—	
Extra-Provincial Corporations Act		Extension of Powers of the Canadian Egg Marketing Agency	406
General	365	Marketing	407
Family Benefits Act		Marketing Limitations	408
General	366	Plan	409
Family Law Act		Fresh Grapes—	
<i>Loi sur le droit de la famille</i>		Marketing	410
Designation of Matrimonial Home—Forms	367	Plan	411
Election of Surviving Spouse	368	Fresh Potatoes—	
Choix du conjoint survivant	368	Marketing	412
Farm Implements Act		Plan	413
General	369	Grapes for Processing—	
Farm Income Stabilization Act		Marketing	414
Fresh Market Potato Stabilization, 1989-1992—Plan	370	Plan	415
Grain Stabilization, 1988-1990—Plan	371	Greenhouse Vegetables—	
Farm Products Containers Act		Appointment of Trustee	416
Containers—Fruit and Vegetables	372	Marketing	417
Farm Products Grades and Sales Act		Plan	418
Burley Tobacco	373	Hogs—	
Flue-Cured Tobacco	374	Marketing	419
Fruit—Controlled-Atmosphere Storage	375	Plan	420
Grades—		Local Boards	421
Beef Carcasses	376	Potatoes—	
Christmas Trees	377	Marketing	422
Fruit and Vegetables	378	Plan	423
Hog Carcasses	379	Processing Tomato Seedling Plants—	
Lamb and Mutton Carcasses	380	Marketing	424
Poultry	381	Plan	425
Veal Carcasses	382	Rutabagas—Marketing	426
Grain	383	Seed-Corn—	
Honey	384	Marketing	427
Licences	385	Plan	428
Maple Products	386	Sheep—	
		Marketing	429
		Plan	430
		Soybeans—	
		Marketing	431
		Plan	432
		Tender Fruit—	
		Marketing	433
		Plan	434
		Tobacco—	
		Marketing	435
		Plan	436
		Turkeys—	
		Marketing	437
		Marketing Limitations	438

VOLUME 4

Farm Products Marketing Act	
Apples—	
Marketing	387

TABLE OF REGULATIONS

	Reg.		Reg.
Plan	439	Black Bear Management Areas	478
Vegetables for Processing—		Bows and Arrows	479
Marketing	440	Bullfrogs	480
Plan	441	Calton Swamp Hunting Area	481
Wheat—		Camden Lake Hunting Area	482
Marketing	442	Copeland forest Hunting Area	483
Plan	443	Crown Game Preserves	484
Farm Products Payments Act		Discharge of Firearms From or Across Highways and Roads	485
Fund for Egg Producers	444	Discharge of Firearms on Sunday	486
Fund for Livestock Producers	445	Fingal Hunting Area	487
Fund for Milk and Cream Producers	446	Firearms—Aulneau Peninsula	488
Fund for Producers of Canola	447	Fishing Huts	489
Fund for Producers of Grain Corn	448	Fishing Licences	490
Fund for Producers of Potatoes for Processing	449	Fur Harvest, Fur Management and Conservation Course	491
Fund for Producers of Soybeans	450	Furs	492
Fund for Producers of Vegetables for Processing	451	Game Bird Hunting Preserves	493
Fire Departments Act		Game Birds—Captivity, Propagation or Sale	494
Filing in Ontario Court (General Division) of Decision of Arbitrator or Arbitration Board	452	Guides	495
Standards for Pumps	453	Hullett Hunting Area	496
Fire Marshals Act		Hunter Safety Training Course	497
Fire Code	454	Hunting in Lake Superior Provincial Park	498
General	455	Hunting in Long Point National Wildlife Area	499
Fish Inspection Act		Hunting Licences	500
Quality Control	456	Hunting on Crown Lands in the Geographic Townships of Bruton and Clyde	501
Forest Fires Prevention Act		Hunting on Designated Crown Land and in Provincial Parks	502
Fire Regions	457	Lake St. Lawrence Hunting Area	503
Forestry Act		Licence to Chase Raccoon at Night and Fox, Coyote or Wolf During the Day	504
Nurseries	458	Licence to Possess Nets	505
Freedom of Information and Protection of Privacy Act		Luther Marsh Hunting Area	506
<i>Loi sur l'accès à l'information et la protection de la vie privée</i>		Nashville Tract Hunting Area	507
Disposal of Personal Information	459	Navy Island Hunting Area	508
General	460	Open Seasons—	
Dispositions générales	460	Black Bear	509
French Language Services Act		Fur-Bearing Animals	510
<i>Loi sur les services en français</i>		Game Birds	511
Exemptions	461	Moose and Deer	512
Exemptions	461	Rabbits and Squirrels	513
General	462	Snapping Turtles	514
Dispositions générales	462	Orangeville Reservoir Hunting Area	515
Freshwater Fish Marketing Act (Ontario)		Petroglyphs Provincial Park Hunting Area	516
General	463	Polar Bears	517
Fuel Tax Act		Prohibition of Hunting and Possession of Firearms	518
General	464	Reporting and Registering Possession of Certain Game	519
Miscellaneous	465	Reptiles	520
Refunds	466	Sale of Bass and Trout and Fishing Preserves	521
Funeral Directors and Establishments Act		Snares	522
Board—Composition and Remuneration	467	Stag Island Hunting Area	523
Compensation Fund	468	Tiny Marsh Hunting Area	524
Equipment and Premises	469	Trade in Game Animal Hides and Cast Antlers	525
Licensing and Business Practices	470	Trap-Line Areas	526
Fur Farms Act		Traps	527
General	471	Traps—Order Under Subsection 30 (4) of the Act	528
Game and Fish Act		Waters Set Apart—Frogs	529
Amphibians	472	Wildlife Management Units	530
Animals Declared to be Fur-Bearing Animals	473	Wolves and Black Bears in Captivity	531
Aylmer Hunting Area	474	Gasoline Handling Act	
Aylmer Lagoon Hunting Area	475	Gasoline Handling Code	532
Bag Limit for Black Bear	476	Gasoline Tax Act	
Beaver Meadow Hunting Area	477	General	533
		Returns and Refunds	534
		General Welfare Assistance Act	
		Civil Legal Aid	535
		Dental Services	536
		General	537
		Indian Bands	538

TABLE DES RÈGLEMENTS

	Reg.		Reg.
Grain Corn Marketing Act		Exemption from Section 7 of the Act—American States	588
Licence Fees	539	Exemption from Sections 7 and 11 of the Act—States of the United States of America	589
Grain Elevator Storage Act		State of Illinois	590
General	540	State of Michigan	591
Guarantee Companies Securities Act		State of South Dakota	592
Approved Guarantee Companies	541	Exemption from Subsection 85 (1) of the Act—Province of Alberta	593
Healing Arts Radiation Protection Act		State of New York	594
Hospitals Prescribed for the Installation and Operation of Computerized Axial Tomography Scanners	542	Garage Licences	595
X-Ray Safety Code	543	General	596
Health Care Accessibility Act		Gross Vehicle Weights	597
Administrative Charge	544	Gross Weight on Bridges	598
Health Disciplines Act		Highway Closings	599
Child Resistant Packages	545	Hours of Work	600
Dental Hygienists	546	Motor Vehicle Inspection Stations	601
Dentistry	547	Notice to Have Motor Vehicle(s) Examined and Tested	602
Medicine	548	Over-Dimensional Farm Vehicles	603
Nursing	549	Parking	604
Optometry	550	Parking of Vehicles in Territory Without Municipal Organization	605
Pharmacy	551	Portable Lane Control Signal Systems	606
Health Insurance Act		Reciprocal Suspension of Licences	607
General	552	Restricted Use of Left Lanes by Commercial Motor Vehicles	608
Health Protection and Promotion Act		Restricted Use of the King's Highway	609
Areas Comprising Health Units	553	Safety Helmets	610
Camps in Unorganized Territory	554	Safety Inspections	611
Capital Assistance Grants for Boards of Health	555	School Buses	612
Clinics for Sexually Transmitted Diseases	556	Seat Belt Assemblies	613
Communicable Diseases—General	557	Security of Loads	614
Designation of Communicable Diseases	558	Signs	615
Designation of Municipal Members of Boards of Health	559	Slow-Moving Vehicle Sign	616
Designation of Reportable Diseases	560	Special Permits	617
Exemption—Subsection 38 (2) of the Act	561	Specifications and Standards for Trailer Couplings	618
Food Premises	562	Speed Limits	619
Grants for Health Promotion Projects and Initiatives	563	Speed Limits in Provincial Parks	620
Grants to Boards of Health	564	Speed Limits in Territory Without Municipal Organization	621
Public Pools	565	Stopping of Vehicles on Parts of the King's Highway	622
Qualifications of Boards of Health Staff	566	Stop Signs at Intersections	623
Rabies Immunization	567	Stop Signs in Territory Without Municipal Organization	624
Recreational Camps	568	Tire Standards and Specifications	625
Reports	569	Traffic Control Signal Systems	626
School Health Services and Programs	570	Use of Controlled-Access Highways by Pedestrians	627
Slaughterhouses and Meat Processing Plants	571	Vehicle Permits	628
Warrant	572	Vehicles for the Transportation of Physically Disabled Passengers	629
		Vehicles on Controlled-Access Highways	630
		Yield Right-of-Way Signs in Territory Without Municipal Organization	631
		Historical Parks Act	
		Historical Parks—Fees	632
		Parks	633
		Homemakers and Nurses Services Act	
		General	634
		Homes for Retarded Persons Act	
		General	635
		Homes for Special Care Act	
		General	636
		Homes for the Aged and Rest Homes Act	
		General	637
		Hospital Labour Disputes Arbitration Act	
		Remuneration of Chairs and Members of Arbitration Boards	638
		Rules of Procedure	639

VOLUME 5

Highway Traffic Act	
Allowable Gross Weight for Designated Class of Vehicle	573
Appeals	574
Commercial Motor Vehicle Inspections	575
Commercial Vehicle Operator's Registration Certificates	576
Covering of Loads	577
Demerit Point System	578
Designation of Highways	579
Designation of Paved Shoulders on King's Highway	580
Disabled Person Parking Permits	581
Driver Improvement Program	582
Driver Licence Examinations	583
Driver's Licence Suspension for Default of Payment of Fine	584
Drivers' Licences	585
Driving Instructor's Licence	586
Equipment	587

TABLE OF REGULATIONS

	Reg.		Reg.
Hotel Fire Safety Act		Laboratory and Specimen Collection Centre Licensing Act	
General	640	Laboratories	682
Housing Development Act		Specimen Collection Centres	683
General	641	Labour Relations Act	
Human Rights Code Act		General	684
Search and Entry Warrants	642	Office of the Board	685
Hunter Damage Compensation Act		Rules of Procedure	686
General	643	Land Registration Reform Act	
Hypnosis Act		Automated Recording and Property Mapping	687
Application of Section 2 of the Act	644	Documents	688
Immunization of School Pupils Act		Land Titles Act	
General	645	Fees	689
Income Tax Act		Forms, Records and Procedures	690
Amounts Deducted or Withheld By Employers	646	Land Titles Divisions	691
Ontario Tax Reduction	647	Surveys and Descriptions of Land	692
Tax Table for Individuals	648	Transfer of Functions	693
Independent Health Facilities Act		Land Transfer Tax Act	
Application and Exemptions	649	Delegation of Authority	694
General	650	Exemptions—	
Industrial Standards Act		For Certain Easements Granted to Oil or Gas	
Designation of Industries and Zones	651	Pipe Lines	695
Duties of Employers and Advisory Committees	652	For Certain Inter-Spousal Transfers	696
Interprovincially Competitive Industries	653	For Conveyance to Family Farm Corporation	
Publication Costs	654	or Family Business Corporation	697
Schedule—		For Conveyance to Non-Resident Persons	
Bricklaying and Stonemasonry		and Persons Who Are Not Non-Resident	
Industry—Ottawa	655	Persons	698
Bricklaying and Stonemasonry		Forms	699
Industry—Toronto	656	Leases	700
Electrical Repair and Construction		Notice of Purchaser's Lien for Default	701
Industry—Toronto	657	Rates of Interest	702
Fur Industry—Ontario	658	Taxation of Mineral Lands	703
Ladies' Cloak and Suit Industry—Ontario	659	Transfers Between Related Corporations	704
Ladies' Dress and Sportswear Industry	660	Landlord and Tenant Act	
Men's and Boys' Clothing Industry—Ontario	661	Classes of Accommodation Deemed not to be	
Plastering Industry—Ottawa	662	Residential Premises	705
Insurance Act		Forms	706
Agents' Licences	663	Summary of Part IV of the Act	707
Automobile Insurance	664	Law Society Act	
Calculations Under Clause 60 (1) (b) of the Act	665	General	708
Classes of Insurance	666	Law Foundation	709
Compensation Corporations	667	Legal Aid Act	
Fault Determination Rules	668	General	710
Financial Statements	669		
General	670	VOLUME 6	
Life Companies Special Shares—Investment	671	Legislative Assembly Retirement Allowances Act	
No-Fault Benefits Schedule	672	General	711
Order Under Paragraph 1 of Subsection 108 (2) of the		Lightning Rods Act	
Act—Rates of Interest	673	General	712
Replacement of Life Insurance Contracts	674	Limited Partnerships Act	
Schedule of Fees	675	General	713
Uninsured Automobile Coverage	676	Line Fences Act	
Variable Insurance Contracts of Life Insurers	677	Appeals	714
Interpretation Act		Forms	715
Fees Payable Under Various Acts	678	Land in Territory Without Municipal Organization	716
Investment Contracts Act		Liquor Control Act	
Registration	679	General	717
Juries Act		Liquor Licences Act	
General	680	General	718
Justices of the Peace Act			
Salaries and Benefits	681		

TABLE DES RÈGLEMENTS

	Reg.		Reg.
Licences to Sell Liquor	719	Levies—Milk	755
Manufacturers' Licences	720	Marketing Boards	756
Possession of Liquor in Conservation Areas Operated by the Halton Region Conservation Authority	721	Marketing of Milk to Fluid Milk Processors	757
Possession of Liquor in Parks Managed or Controlled by the Niagara Parks Commission and the St. Clair Parkway Commission	722	Milk—	
Possession of Liquor in Provincial Parks	723	Marketing	758
Livestock and Livestock Products Act		Transportation	759
Eggs	724	Milk and Cheese—Plan	760
Livestock	725	Milk and Milk Products	761
Processed Egg	726	Milk Producers, Licences, Quotas, Pools and Transportation	762
Wool	727	Milk Products—Extension of Powers	763
Livestock Branding Act		Reconstituted Milk—General	764
Forms and Fees	728	Mining Act	
Livestock Community Sales Act		Exploratory Licences and Leases for Oil and Natural Gas North of the Fifty-first Parallel of Latitude	765
General	729	Exploratory Licences and Production Leases for Natural Gas in Lake Erie	766
Livestock Medicines Act		Mining Divisions	767
General	730	Surveys of Mining Claims	768
Livestock, Poultry and Honey Bee Protection Act		Mining Tax Act	
Application for Payment of a Grant	731	General	769
Dogs at Large in Unorganized Areas	732	Ministry of Colleges and Universities Act	
Loan and Trust Corporations Act		Colleges of Applied Arts and Technology— Boards of Governors and Council of Regents	770
General	733	Colleges	771
Local Roads Boards Act		Graduate Scholarship Awards	772
Establishment of Local Roads Areas—		Ontario Special Bursary Program	773
Northern and Eastern Regions	734	Ontario Student Loans	774
Northwestern Region	735	Ontario Study Grant Plan	775
General	736	Ministry of Community and Social Services Act	
Local Services Boards Act		Social Assistance Review Board	776
Local Services Boards	737	Ministry of Consumer and Commercial Relations Act	
Marriage Act		Fees	777
General	738	Ministry of Correctional Services Act	
Meat Inspection Act (Ontario)		General	778
General	739	Intermittent Sentences	779
Members' Conflict of Interest Act		Ministry of Health Act	
<i>Loi sur les conflits d'intérêts des membres de l'Assemblée</i>		Bursaries and Fellowships for Health Study	780
General	740	Chest Diseases Control Clinics	781
Dispositions générales	740	Chiropody Bursaries	782
Mental Health Act		Dental Bursaries	783
Application of Act	741	District Health Councils	784
Grants	742	Grants—Health Resources	785
Mental Hospitals Act		Grants to Accredited Nursing Homes	786
Application of Section 13 of the Public Hospitals Act	743	Grants to University Faculties of Medicine	787
General	744	Medical Bursaries	788
Milk Act		Nursing Bursaries	789
By-Laws for Marketing Boards	745	Nursing Innovation Fund	790
Cheese—		Occupational Therapy Bursaries	791
Exchange	746	Physiotherapy Bursaries	792
Information to be Furnished	747	Speech Pathology and Audiology Bursaries	793
Marketing	748	Standard Ward Accommodation	794
Marketing—Exemptions	749	Ministry of Natural Resources Act	
Cream for Processing—		Mining and Lands Commissioner to Hear and Determine Appeals Under Subsection 28 (5) of the Conservation Authorities Act	795
Marketing	750	Ministry of Tourism and Recreation Act	
Plan	751	Grants for Non-Profit Camps	796
Cream Producers—Licences	752	Recreation Programs	797
Grades, Standards, Designations, Classes, Packing and Marking	753	Mortgage Brokers Act	
Industrial Milk—Marketing	754	General	798
		Motor Vehicle Accident Claims Act	
		Designated Insurers	799

TABLE OF REGULATIONS

	Reg.		Reg.
General	800	Occupational Health and Safety Act	
Motor Vehicle Dealers Act		Control of Exposure to Biological or Chemical Agents ..	833
General	801	Critical Injury—Defined	834
Motor Vehicle Repair Act		Designated Substance—	
General	802	Acrylonitrile	835
Motorized Snow Vehicles Act		Arsenic	836
Designations	803	Asbestos	837
General	804	Asbestos on Construction Projects and in	
Motorized Snow Vehicle Operators' Licences	805	Buildings and Repair Operations	838
Municipal Act		Benzene	839
Designation—		Coke Oven Emissions	840
Agricultural Research Stations	806	Ethylene Oxide	841
Correctional Institutions	807	Isocyanates	842
Facilities Under Developmental Services Act	808	Lead	843
Municipalities	809	Mercury	844
Provincial Education Institutions	810	Silica	845
Provincial Mental Health Facilities and Public		Vinyl Chloride	846
Hospitals	811	Designations Under Clause 16 (1) (n) of the Act	847
Universities	812	Diving Operations	848
Pension Plan for Municipal Employees	813	Firefighters—Protective Equipment	849
Small Business Programs	814	Hazardous Materials Inventories	850
Waste Management	815	Industrial Establishments	851
Municipal Affairs Act		Inventory of Agents or Combinations of Agents for the	
Tax Arrears and Tax Sale Procedures	816	Purpose of Section 34 of the Act	852
Municipal and School Board Payments Adjustment Act		Joint Health and Safety Committees—Exemption From	
General	817	Requirements	853
Municipal Elections Act		Mines and Mining Plants	854
Use of Central Vote Tabulators	818	Oil and Gas—Offshore	855
Use of Vote Tabulators	819	Roll-Over Protective Structures	856
Use of Voting Recorders	820	Teachers	857
Municipal Extra-Territorial Tax Act		University Academics and Teaching Assistants	858
Assessment Equalization Factor	821	Window Cleaning	859
General	822	Workplace Hazardous Materials Information System	
Municipal Freedom of Information and Protection of		(WHMIS)	860
Privacy Act		X-Ray Safety	861
<i>Loi sur l'accès à l'information municipale et la</i>		Official Notices Publication Act	
<i>protection de la vie privée</i>		Rates	862
General	823	Off-Road Vehicles Act	
Dispositions générales	823	General	863
Municipal Tax Sales Act		Oleomargarine Act	
<i>Loi sur les ventes pour impôts municipaux</i>		General	864
Municipal Tax Sales Rules	824	Ombudsman Act	
Règles concernant les ventes pour impôts municipaux ..	824	General Rules	865
Municipality of Metropolitan Toronto Act		Ontario Agricultural Museum Act	
Ward Boundaries	825	Fees	866
Niagara Escarpment Planning and Development Act		General	867
Designation of Area of Development Control	826	Ontario Drug Benefit Act	
Designation of Planning Area	827	General	868
Development Within the Development Control Area	828	Ontario Energy Board Act	
Niagara Parks Act		General	869
General	829	Rules of Procedure	870
Non-Resident Agricultural Land Interests		Ontario Food Terminal Act	
Registration Act		Composition and Procedure of Board	871
General	830	Conduct of Business	872
Notaries Act		Ontario Guaranteed Annual Income Act	
Fees	831	Forms	873
Nursing Homes Act		General	874
General	832	Ontario Heritage Act	
		Archaeological Sites	875
		Grants and Loans	876
		Grants for Museums	877
		Grants for Plaquing	878
		Grants to Incorporated Historical Societies and	
		Associations	879

TABLE DES RÉGLEMENTS

	Reg.		Reg.
Historic Sites	880	Personal Property Security Act	
Licences	881	Branch Offices	910
Ontario Highway Transport Board Act		Fees	911
Rules of Procedure	882	General	912
Ontario Home Ownership Savings Plan Act		Personal Property Security Assurance Fund	913
General	883	Pesticides Act	
Ontario Institute for Studies in Education Act		General	914
General	884	Petroleum Resources Act	
Ontario Lottery Corporation Act		Exploration Drilling and Production	915
General	885	Protection of Designated Gas Storage Areas	916
Ontario Mineral Exploration Program Act		Planning Act	
Ontario Mineral Incentive Program	886	Notice Requirements—	
Ontario Prospectors' Assistance Program	887	Interim Control By-Laws	917
Ontario Municipal Board Act		Official Plans and Community Improvement	
Fees	888	Plans	918
Rules of Procedure	889	Removal of Holding Symbol from Zoning	
Ontario Municipal Employees Retirement System Act		By-Law	919
General	890	Zoning By-Laws	920
Ontario Municipal Improvement Corporation Act		Planning Board Fees	921
Procedure	891	Rules of Procedure—	
Ontario New Home Warranties Plan Act		Consent Applications	922
Administration of the Plan	892	Minor Variance Applications	923
Designation of Corporation	893	Plant Diseases Act	
Terms and Conditions of Registration of Builders and		General	924
Vendors	894	Police Services Act	
Ontario Pensioners Property Tax Assistance Act		Arbitration	925
Amount—Clause 2 (2) (a) of the Act	895	Equipment	926
General	896	General—Discipline	927
Grants	897	Members' Duty to Prepare Informations	928
Ontario Place Corporation Act		Municipal Police Forces	929
Fees	898	Responsibility of Policing	930
Ontario Telephone Development Corporation Act		Power Corporation Act	
Composition and Procedures of Corporation	899	Debt Guarantee Fees	931
		Fees	932
		Water Heaters	933
		Prepaid Services Act	
		General	934
		Prescription Drug Cost Regulation Act	
		General	935
		Notice to Patients	936
		Private Hospitals Act	
		General	937
		Private Investigators and Security Guards Act	
		General	938
		Private Vocational Schools Act	
		General	939
		Proceedings Against the Crown Act	
		Garnishment	940
		Professional Engineers Act	
		General	941
		Province of Ontario Savings Office Act	
		Interest Rate	942
		Provincial Land Tax Act	
		Forms	943
		General	944
		Provincial Offences Act	
		Costs	945
		Extensions of Prescribed Times	946

VOLUME 7

Ontario Water Resources Act	
Municipal Sewage and Water and Roads Class	
Environmental Assessment Projects	900
Plumbing Code	901
Rate of Interest	902
Wells	903
Operating Engineers Act	
General	904
Ophthalmic Dispensers Act	
General	905
Paperback and Periodical Distributors Act	
General	906
Parks Assistance Act	
General	907
Parkway Belt Planning and Development Act	
Parkway Belt Planning Area	908
Pension Benefits Act	
General	909

TABLE OF REGULATIONS

	Reg.		Reg.
Fee for Late Payment of Fine	947	Reciprocal Enforcement of Judgments Act	
Fine Option Program	948	Application of Act	987
Parking Infractions	949	Reciprocal Enforcement of Support Orders Act	
Proceedings Commenced by Certificate of Offence	950	Reciprocating States	988
Provincial Parks Act		Registered Insurance Brokers Act	
Designation of Parks	951	Composition and Election of Council	989
General	952	Exemptions	990
Guides in Quetico Provincial Park	953	General	991
Mining in Provincial Parks	954	Registry Act	
Psychologists Registration Act		Canada Lands	992
General	955	Certification Areas	993
Public Accountancy Act		Fees	994
Licence Fee	956	Forms and Records	995
Public Hospitals Act		Registry Divisions	996
Capital Grants for the Amalgamation of Hospital Services	957	Surveys, Plans and Descriptions of Land	997
Capital Grants for Ambulance Facilities	958	Transfer of Functions	998
Capital Grants for Capital Expenditures that will Produce Savings in Operating Costs	959	Regulations Act	
Capital Grants for Hospital Construction and Renovation	960	General	999
Capital Grants for Local Rehabilitation and Crippled Children's Centres	961	Rental Housing Protection Act	
Capital Grants for Regional Rehabilitation Hospitals	962	General	1000
Capital Grants for Teaching Hospitals	963	Repair and Storage Liens Act	
Classification of Hospitals	964	Fees	1001
Hospital Management	965	Forms	1002
Oil Conversion Grants	966	General	1003
Special Grants—		Residential Rent Regulation Act	
Acquisition of Hospital Facilities	967	General	1004
Correction of Hazardous Conditions	968	Regions	1005
Management of Biomedical Waste	969	Rent Determination	1006
Public Institutions Inspection Act		Rent Registry	1007
Fees and Allowances to Panel Members	970	Rental Housing Maintenance Standards	1008
Public Lands Act		Rules Under Sections 60, 61 and 62 of the Act for Applications and Justifications	1009
Crown Land Camping Permit	971	Suite Hotel	1010
Fees for Certificates and Orders	972	Retail Sales Tax Act	
Land Use Permits	973	Definitions	1011
Sale and Lease of Public Lands	974	Definitions by Minister	1012
Work Permits	975	General	1013
Public Libraries Act		Riding Horse Establishments Act	
Grants for Public Libraries	976	General	1014
Public Service Act			
General	977	VOLUME 8	
Public Transportation and Highway Improvement Act		Securities Act	
Intersections in Unorganized Territory	978	General	1015
Permits	979	Seed Potatoes Act	
Use of Rest, Service or Other Areas	980	General	1016
Public Trustee Act		Shoreline Property Assistance Act	
General	981	General	1017
Public Vehicles Act		Small Business Development Corporations Act	
General	982	Additional Material to be Furnished with Grant Applications	1018
Race Tracks Tax Act		Forms	1019
Forms	983	General	1020
General	984	Terms and Conditions Relating to Beneficial Ownership of Equity Shares	1021
Radiological Technicians Act		St. Clair Parkway Commission Act	
General	985	General	1022
Real Estate and Business Brokers Act		St. Lawrence Parks Commission Act	
General	986	Parks	1023

TABLE DES RÈGLEMENTS

	Reg.		Reg.
Stock Yards Act		Plumber	1073
Management	1024	Printer	1074
Surveyors Act		Radio and Television Service Technician	1075
Certificates of Registration	1025	Refrigeration and Air-Conditioning Mechanic	1076
General	1026	Sheet Metal Worker	1077
Surveys Act		Sprinkler and Fire Protection Installer	1078
Monuments	1027	Steamfitter	1079
Ontario Co-ordinate System	1028	Tool and Die Maker	1080
Survey Methods	1029	Transmission Mechanic	1081
Technology Centres Act		Truck-Trailer Repairer	1082
Ontario Centre for Resource Machinery Technology	1030	Watch Repairer	1083
Theatres Act		Transboundary Pollution Reciprocal Access Act	
General	1031	Reciprocating Jurisdictions	1084
Tile Drainage Act		Travel Industry Act	
Borrowing By-Laws, Debentures and Loans	1032	General	1085
Tobacco Tax Act		Truck Transportation Act	
Forms	1033	Conditions of Carriage—	
General	1034	Carriers of 01 41—Livestock and 01	
Refunds	1035	92—Animal Specialties	1086
Toronto Area Transit Operating Authority Act		General Freight Carriers	1087
General	1036	Household Goods Carriers	1088
Tourism Act		Intermediaries	1089
General	1037	Obligations of Licensees	1090
Trades Qualification Act		Operating Licences	1091
Air Cooled and Marine Engine Mechanic	1038	Upholstered and Stuffed Articles Act	
Alignment and Brakes Mechanic	1039	General	1092
Auto Body Repairer	1040	Veterinarians Act	
Automatic Machinist	1041	General	1093
Automotive Machinist	1042	Vital Statistics Act	
Automotive Painter	1043	General	1094
Baker	1044	Vocational Rehabilitation Services Act	
Brick and Stone Mason	1045	General	1095
Cement Mason	1046	Weed Control Act	
Construction Boilermaker	1047	General	1096
Construction Millwright	1048	Wild Rice Harvesting Act	
Cook	1049	General	1097
Dry Cleaner	1050	Wilderness Areas Act	
Electrician	1051	Wilderness Areas	1098
Farm Equipment Mechanic	1052	Wine Content Act	
Fitter (Structural Steel/Platework)	1053	Wine Blending Requirements	1099
Fuel and Electrical Systems Mechanic	1054	Woodlands Improvement Act	
General	1055	General	1100
General Carpenter	1056	Workers' Compensation Act	
General Machinist	1057	First Aid Requirements	1101
Glazier and Metal Mechanic	1058	General	1102
Heavy Duty Equipment Mechanic	1059	Pension Plan	1103
Hoisting Engineer	1060		
Horticulturist	1061	VOLUME 9	
Industrial Electrician	1062	Rules of Civil Procedure	
Industrial Mechanic (Millwright)	1063	(Courts of Justice Act)	194
Industrial Woodworker	1064	Règles de procédure civile	
Ironworker	1065	(Loi sur les tribunaux judiciaires)	194
Lather	1066		
Lineworker	1067		
Motor Vehicle Mechanic	1068		
Motorcycle Mechanic	1069		
Mould Maker	1070		
Painter and Decorator	1071		
Plasterer	1072		

Farm Products Marketing Act *Loi sur la commercialisation des produits agricoles*

REGULATION 387

LICENCES

APPLES—MARKETING

1. In this Regulation,

“Apple Commission” means The Ontario Apple Marketing Commission;

“apples” means apples of every variety produced in Ontario;

“buyer” means a person who buys apples from a producer;

“plan” means The Ontario Apple Marketing Plan;

“processing” means,

- (a) baking, canning, dehydrating, drying, freezing, slicing or pressing and includes making juice or cider from apples, or
- (b) processing with sugar or another substance including, but not limited to, sulphur dioxide;

“processor” means a person engaged in the processing of apples;

“producer” means the person who, on the 1st day of October in any year, is the beneficial owner of a property on which apple trees are growing, except where the property is being rented to a tenant on the 1st day of October in that year, in which case “producer” means the tenant;

“retailer” means any person who offers for sale or sells apples directly to a consumer. R.R.O. 1980, Reg. 341, s. 1; O. Reg. 736/86, s. 1; O. Reg. 431/88, s. 2.

2. This Regulation provides for the control and regulation in any or all respects of the producing and marketing within Ontario of apples, including the prohibition of such producing and marketing in whole or in part. R.R.O. 1980, Reg. 341, s. 2.

3.—(1) The Commission exempts from this Regulation apples produced,

- (a) in the territorial districts of Ontario; and
- (b) in the County of Haliburton. R.R.O. 1980, Reg. 341, s. 3 (1); O. Reg. 736/86, s. 2 (1); O. Reg. 431/88, s. 1.

(2) The Commission exempts from clause 14 (f),

- (a) acreages of apple trees of spy variety where the trees are under seven years of age; and
- (b) acreages of apple trees of all varieties other than spy where the trees are under four years of age. R.R.O. 1980, Reg. 341, s. 3 (2); O. Reg. 260/85, s. 1; O. Reg. 431/88, s. 1.

(3) The Commission exempts from subsection 6 (1) a producer who makes less than 7,500 gallons of cider per year from apples produced by him, her or it in so far as the making of cider from such apples is concerned. O. Reg. 736/86, s. 2 (2); O. Reg. 431/88, s. 1.

4. On or before the 21st day of October in each year, each producer shall complete a return in Form 1 and file it with the Apple Commission at its office, 7195-B Millcreek Drive, Mississauga, Ontario, L5N 3R3. O. Reg. 194/86, s. 1; O. Reg. 431/88, s. 1.

5.—(1) No person shall commence or continue to engage in the producing of apples except under the authority of a licence as a producer from the Commission.

(2) Every producer shall be deemed to be the holder of a licence as a producer while not in default of payment of licence fees required to be paid to the Apple Commission. O. Reg. 431/88, s. 3, *part*.

6.—(1) No person shall commence or continue to engage in the processing of apples except under the authority of a licence from the Commission and except in compliance with the terms and conditions of the licence. O. Reg. 431/88, s. 3, *part*; O. Reg. 513/89, s. 1.

(2) A licence as a processor expires on the 15th day of July following the date on which it was issued.

(3) A licence as a processor shall be issued without charge. O. Reg. 431/88, s. 3, *part*.

7. The Commission may refuse to grant or renew or may suspend or revoke a licence as a processor,

(a) where the applicant or licensee is not qualified by experience, financial responsibility or equipment to properly engage in the business for which the application was made or the licence granted; or

(b) where the applicant or licensee has failed to comply with or has contravened the Act, the regulations, the plan or any order or direction of the Commission or Apple Commission. O. Reg. 431/88, s. 3, *part*.

8. The Commission may impose such terms and conditions upon a licence as the Commission considers proper. O. Reg. 513/89, s. 2, *part*.

9. Where, after a hearing, the Commission is of the opinion that the applicant or licensee has failed to comply with or has contravened any term or condition of the licence or the Act, the regulations, the plan or any order or direction of the Commission, the Commission may impose a penalty on the applicant or licensee. O. Reg. 513/89, s. 2, *part*.

10.—(1) The Commission may require that a processor furnish a performance bond that shall not exceed 10 per cent of the price payable to producers for apples processed during the immediately preceding twelve-month period by the processor.

(2) The Commission may determine that the performance bond is forfeited when the processor who furnished the bond fails to comply with or contravenes any term or condition of the processor's licence or the Act, the regulations, the plan or any order or direction of the Commission. O. Reg. 513/89, s. 2, *part*.

11.—(1) If a penalty is imposed under section 9 or a performance bond is forfeited under subsection 10 (2), the Commission shall pay the penalty or the proceeds of the performance bond, or both, to the local board for distribution proportionately among the producers of apples who sold apples to the processor and who did not receive the minimum price for the apples.

(2) If there are no producers as described in subsection (1), the Commission shall pay the penalty or the proceeds of the perfor-

mance bond, or both, into the Consolidated Revenue Fund. O. Reg. 513/89, s. 2, *part*.

12.—(1) Every producer shall pay licence fees at the following rate per year per acre of apple trees in respect of which the producer is a producer in the district:

District 1, 2, 3 or 4	— \$42.60
District 5	— \$36.78
District 6	— \$38.37
District 7, 8 or 9	— \$35.40

O. Reg. 400/90, s. 1.

(2) The producer shall pay the licence fees to the Commission at its office, 7195-B Millcreek Drive, Mississauga, Ontario, L5N 3R3, in three equal instalments, the first instalment to be paid on or before the 15th day of November, the second instalment to be paid on or before the 15th day of February of the next following year and the third instalment to be paid on or before the 15th day of May next thereafter. O. Reg. 604/88, s. 1, *part*.

POWERS OF APPLE COMMISSION

13. The Commission delegates to the Apple Commission the power,

- (a) to require persons engaged in producing or marketing apples to register their names, addresses and occupations with the Apple Commission;
- (b) to require persons engaged in producing or marketing apples to furnish such information relating to the production or marketing of apples, including the completing and filing of returns, as the Apple Commission determines;
- (c) to appoint persons to,
 - (i) inspect the books, records, documents, lands and premises and any apples of persons engaged in producing or marketing apples, and
 - (ii) enter on lands or premises used for producing apples and measure the area of land used to produce apples;
- (d) to stimulate, increase and improve the marketing of apples by such means as it considers proper;
- (e) to co-operate with a marketing board, a local board or a marketing agency of any other province for the purpose of marketing apples;
- (f) to do such acts and make such orders and issue such directions as are necessary to enforce the due observance and carrying out of the Act, the regulations and the plan. R.R.O. 1980, Reg. 341, s. 9; O. Reg. 331/82, s. 2; O. Reg. 431/88, s. 1; O. Reg. 628/89, s. 1.

14. Subject to section 3 the Commission delegates to the Apple Commission its power to make regulations with respect to apples,

- (a) providing for the licensing of any or all persons before commencing or continuing to engage in the marketing of apples;
- (b) prescribing or providing for classes of licences and for the imposition of terms and conditions on any class of licence;
- (c) prohibiting persons from engaging in the marketing of apples except under the authority of a licence and except in compliance with the terms and conditions of the licence;
- (d) providing for the refusal to grant or renew or the suspension or revocation of a licence,

- (i) where the applicant or licensee is not qualified by experience, financial responsibility or equipment to properly engage in the business for which the application was made or the licence granted, or
- (ii) where the applicant or licensee has failed to comply with or has contravened the Act, the regulations, the plan or any order or direction of the Commission or Apple Commission;
- (e) providing for the imposition, amount, disposition and use of penalties where, after a hearing, the Apple Commission is of the opinion that the applicant or licensee has failed to comply with or has contravened any term or condition of the licence or the Act or the regulations, the plan or any order or direction of the Apple Commission;
- (f) providing for the fixing of licence fees and the payment thereof by any or all persons marketing apples;
- (g) providing for the collection of licence fees from any or all persons producing or marketing apples and the recovering of such licence fees by suit in a court of competent jurisdiction;
- (h) requiring any person who receives apples to deduct from the money payable for the apples any licence fees payable to the Apple Commission by the person from whom the person receives the apples and to forward such licence fees to the Apple Commission;
- (i) prescribing the form of licences;
- (j) requiring any person who produces and processes apples to furnish to the Apple Commission statements of the amounts of apples that the person produced in any year and used for processing;
- (k) providing for the exemption from any or all of the regulations, orders or directions under the plan of any class, variety, grade or size of apples, or any person or class of persons engaged in the producing or marketing of apples or any class, variety, grade or size of apples;
- (l) requiring the furnishing of security or proof of financial responsibility by any person engaged in the marketing of apples and providing for the administration and disposition of any money or securities so furnished;
- (m) authorizing the fixing of prompt payment discounts, delayed payment penalties and interest on licence fees owing by any person engaged in the marketing of apples;
- (n) providing for the control and regulation of the marketing of apples including the times and places at which apples may be marketed;
- (o) providing for the control and regulation of agreements entered into by producers of apples with persons engaged in marketing or processing apples and the prohibition of any provision or clause in such agreements;
- (p) requiring any person who produces apples to offer to sell and to sell the apples through the Apple Commission; and
- (q) providing for the making of agreements relating to the marketing of apples by or through the Apple Commission and prescribing the forms and terms and conditions of such agreements. R.R.O. 1980, Reg. 341, s. 10; O. Reg. 331/82, s. 3; O. Reg. 68/85, s. 1; O. Reg. 431/88, ss. 1, 5; O. Reg. 628/89, s. 2.

15. The Apple Commission may impose such conditions upon a licence as the Apple Commission considers proper. O. Reg. 628/89, s. 3.

16.—(1) The Commission authorizes the Apple Commission to use any class of licence fees and other money payable to it for the purposes of paying the expenses of the Apple Commission, carrying out and enforcing the Act and the regulations and carrying out the purposes of the plan. R.R.O. 1980, Reg. 341, s. 11 (1); O. Reg. 431/88, s. 1.

(2) The Commission authorizes the Apple Commission to establish a fund in connection with the plan for the payment of any money that may be required for the purposes mentioned in subsection (1). R.R.O. 1980, Reg. 341, s. 11 (2); O. Reg. 431/88, s. 1.

APPOINTMENT OF AGENTS

17. The Commission authorizes the Apple Commission to appoint agents, to prescribe their duties and conditions of employment and to provide for their remuneration. O. Reg. 188/90, s. 1.

MARKETING BY APPLE COMMISSION

18.—(1) All apples shall be marketed by or through the Apple Commission. R.R.O. 1980, Reg. 341, s. 12 (1); O. Reg. 431/88, s. 1.

(2) No person shall market apples except by or through the Apple Commission. R.R.O. 1980, Reg. 341, s. 12 (2); O. Reg. 431/88, s. 1.

19. The Commission vests in the Apple Commission the following powers:

- 1. To direct and control, by order or direction, either as principal or agent, the marketing of apples, including the times and places at which apples may be marketed.
2. To determine the quality of each class, variety, grade and size of apples that shall be marketed by each producer.
3. To prohibit the marketing of any class, variety, grade or size of apples.
4. To purchase or otherwise acquire such quantity or quantities of apples as the Apple Commission considers advisable. R.R.O. 1980, Reg. 341, s. 13; O. Reg. 431/88, s. 1.

20. The Commission vests in the Apple Commission the following powers:

- 1. To determine from time to time the price or prices that shall be paid for apples, or any class, variety, grade or size of apples, to persons engaged in the producing, marketing or processing of apples and to determine different prices for different parts of Ontario.
2. To require the price or prices payable or owing to any person for apples to be paid to or through the Apple Commission.
3. To collect from any person by suit in a court of competent jurisdiction the price or prices or any part thereof of apples owing to any person engaged in the producing, marketing or processing thereof. R.R.O. 1980, Reg. 341, s. 14; O. Reg. 431/88, s. 1.

Form 1

Farm Products Marketing Act

ANNUAL APPLE ACREAGE REPORT

To: The Ontario Apple Marketing Commission, 7195-B Millcreek Drive, Mississauga, Ontario, LSN 3R3.

(name of producer)
(corporation or orchard name)
(state whether owner or tenant)
(mailing address)
(person responsible for orchard(s))

This is the annual survey for assessment of apple acreage within the Province of Ontario for the current crop year.

Your acreage for the 19..... crop year was as follows based on your estimate or official measurement:

- 1. Total Apple Acreage
2. Exemptions (young trees)
i. Spy acreage planted since August 19.....
ii. All other apple acreage planted since August 19.....
3. Total Exemptions
4. Total Assessable Acres

If there is no change in your acreage as shown above please sign and return.

(signature)
(phone number)

If there have been changes during the past year, please complete the following:

DEDUCT:

- 5. Apple Trees removed acres
6. Orchards no longer rented acres
-owner of orchard previously rented
(name)
(address)

- 7. Orchards sold or rented acres
-Sold or rented to
(name)
(address)
8. TOTAL acres

- ADD:
9. Young trees reaching maturity
 Spy variety planted between
 August 1, 19..... and August 1,
 19.....
 All other varieties planted
 between August 1, 19..... and
 August 1, 19.....
10. Orchard previously rented by
 you to another producer but
 not rented this year acres
11. Orchards purchased or rented acres
 —Location
 —Purchased, rented or leased
 from

 (name)

 (address)
12. TOTALacres
13. TOTAL ASSESSABLE ACRES 19.....
 CROP YEAR
14. 19..... Crop Year Plantings
 Young Apple Trees Planted during
 the year August 1, 19..... to
 July 31, 19.....
 i. Spy variety acres
 ii. All other varieties acres

This acreage will *not* be assessable this year but will be added to your total apple acreage and to the exemptions for your trees.

.....
 (signature)

.....
 (phone number)

Dated at, this day of, 19.....

R.R.O. 1980, Reg. 341, Form 4; O. Reg. 331/82, s. 4; O. Reg. 618/84, s. 1; O. Reg. 194/86, s. 3.

REGULATION 388

APPLES—PLAN

1. The plan in the Schedule is continued for the control and regulation of the producing and marketing within Ontario of apples. O. Reg. 735/86, s. 1.

2. The local board named in the Schedule is given the powers set out in subsection 15 (1), in paragraphs 1, 2, 3, 4, 5, 6, 7, 8, 10, 11, 12, 13, 14, 15, 16, 17, 18, 19 and 26 of subsection 15 (2) and in sections

50 and 110 of the *Co-operative Corporations Act*. R.R.O. 1980, Reg. 340, s. 2.

3. The members of the local board shall be deemed to be the shareholders and directors thereof in the exercise of any of the powers mentioned in section 2. R.R.O. 1980, Reg. 340, s. 3.

Schedule

Farm Products Marketing Act

PLAN

1. This plan may be cited as “The Ontario Apple Marketing Plan”.

2. In this plan,

“apples” means apples of every variety produced in Ontario;

“buyer” means a person who buys apples from a producer;

“dealer” means a person who is engaged in the marketing of apples in Ontario;

“plan” means The Ontario Apple Marketing Plan;

“processing” means,

(a) baking, canning, dehydrating, drying, freezing, slicing or pressing and includes making juice or cider from apples, or

(b) processing with sugar or another substance including, but not limited to, sulphur dioxide;

“processor” means a person engaged in the processing of apples;

“producer” means the person who, on the 1st day of October in any year, is the beneficial owner of a property on which apple trees are growing, except where the property is being rented to a tenant on the 1st day of October in that year, in which case “producer” means the tenant;

“retailer” means any person who offers for sale or sells apples directly to a consumer.

3. The plan provides for the control and regulation in any or all respects of the producing and marketing within Ontario of apples, including the prohibition of such producing and marketing in whole or in part.

4. There shall be a local board, designated for the purposes of clause 5 (1) (b) of the Act, as “The Ontario Apple Marketing Commission”, hereinafter referred to as the “Apple Commission”.

5. The Apple Commission shall be composed of twenty-three members as follows:

1. Twelve members shall be producers.
2. One member shall be a retailer.
3. One member shall be a consumer who is a member of the Consumers’ Association of Canada.
4. Five members shall be dealers.
5. Four members shall be processors.

6. Members of the Apple Commission shall be elected or appointed in accordance with the provisions of the plan and shall hold office until their successors are elected or appointed.

7. Producers are divided into nine districts as follows:

1. District 1, comprising the regional municipalities of Hamil-

ton-Wentworth and Niagara and that part of The Regional Municipality of Haldimand-Norfolk that on the 31st day of March, 1974 was the County of Haldimand.

2. District 2, comprising the counties of Wellington and York, as it existed on the 31st day of December, 1970, and the regional municipalities of Halton, Peel and Waterloo.
3. District 3, comprising the County of Brant and that part of The Regional Municipality of Haldimand-Norfolk that on the 31st day of March, 1974 was the County of Norfolk.
4. District 4, comprising the counties of Elgin, Huron, Middlesex, Oxford, Perth and that part of the County of Lambton lying north of that part of the King's Highway known as No. 80.
5. District 5, comprising the counties of Essex, Kent and that part of the County of Lambton lying south of that part of the King's Highway known as No. 80.
6. District 6, comprising the counties of Bruce, Dufferin, Grey and Simcoe.
7. District 7, comprising the counties of Northumberland, Peterborough and Victoria and The Regional Municipality of Durham.
8. District 8, comprising the counties of Frontenac, Hastings, Lennox and Addington and Prince Edward.
9. District 9, comprising the counties of Dundas, Glengarry, Grenville, Lanark, Leeds, Prescott, Renfrew, Russell and Stormont and The Regional Municipality of Ottawa-Carleton.

8.—(1) The producer in each district mentioned in section 7 forms a district group of producers.

(2) A producer in the County of Haliburton or in a territorial district not included in a district mentioned in section 7 may become a member of the district group of producers nearest his or her place of production.

9. There shall be a committee of five producer-members in each district to be known as the "District Apple Producers' Committee".

10. On or before the 10th day of August in each year, producers in each district shall elect from their members representatives to the District Apple Producers' Committee.

11.—(1) On or before the 15th day of August in each year, each District Apple Producers' Committee shall elect from among themselves one member to the Apple Commission.

(2) On or before the 15th day of August in each year, the members of all District Apple Producers' Committees shall together elect from among themselves three additional members to the Apple Commission, but not more than two members of the Apple Commission may be elected from any one district.

(3) No producer is eligible for election to the Apple Commission who has not been elected a representative to the District Apple Producers' Committee in the same year as that in which his or her term commences as a member of the Apple Commission.

(4) No producer is eligible for election in a district to the Apple Commission unless he or she resides within the district.

12. On or before the 15th day of August in each year, the Minister shall appoint a retailer in Ontario as a member of the Apple Commission.

13. On or before the 15th day of August in each year, the Minister

shall appoint a member from Ontario of the Consumers' Association of Canada as a member of the Apple Commission.

14. Dealers are divided into five districts as follows:

1. District 1, comprising the counties of Elgin, Essex, Huron, Kent, Lambton, Middlesex, Oxford and Perth.
2. District 2, comprising the counties of Brant and Wellington and the regional municipalities of Haldimand-Norfolk, Halton, Hamilton-Wentworth, Niagara and Waterloo.
3. District 3, comprising the counties of Bruce, Dufferin, Grey and Simcoe and The Regional Municipality of Peel.
4. District 4, comprising the counties of Northumberland, Peterborough, Prince Edward, Victoria and York, as it existed on the 31st day of December, 1970, and The Regional Municipality of Durham.
5. District 5, comprising the counties of Dundas, Frontenac, Glengarry, Hastings, Lanark, Leeds, Lennox and Addington, Prescott, Renfrew, Russell, Stormont and The Regional Municipality of Ottawa-Carleton.

15. On or before the 15th day of August in each year, the Apple Marketers' Association of Ontario shall conduct an election to elect one dealer from among all dealers in each of the districts referred to in section 14 as a member of the Apple Commission.

16. On or before the 15th day of August in each year, the Ontario Food Processors' Association shall conduct an election to elect from among all processors in Ontario four members to the Apple Commission.

17. Subject to section 6, the members of the Apple Commission elected or appointed under this Regulation shall hold office until the 15th day of August in the year next following.

18. No member elected or appointed to the Apple Commission shall be eligible, during the term of such election or appointment, for further election or appointment to the Apple Commission in any other representative capacity.

19. Where any District Apple Producers' Committee fails to elect a member to the Apple Commission in accordance with the provisions of subsection 11 (1), the Apple Commission shall, at its first meeting after the 15th day of August, appoint such producer-members as are necessary to complete the Apple Commission.

20. Where the members of all District Apple Producers' Committees fail to elect the three additional members to the Apple Commission in accordance with subsection 11 (2), the Apple Commission shall, at its first meeting after the 15th day of August, appoint such producer-members as are necessary to complete the Apple Commission.

21. When the dealers or the processors fail to elect a member to the Apple Commission in accordance with this Regulation, the Apple Commission shall, at its first meeting after the 15th day of August, appoint such representative members as are necessary to complete the Apple Commission.

22.—(1) Where a member elected to or appointed by the Apple Commission dies or resigns before his or her term has expired, the Apple Commission may appoint a person as a member to fill such vacancy for the unexpired term in accordance with the scheme of representation as set out in section 5.

(2) Where a member appointed to the Apple Commission by the Minister dies or resigns before his or her term has expired, the Minister shall appoint a person as a member within thirty days thereafter to fill such vacancy for the unexpired term in accordance with the scheme of representation as set out in section 5.

(3) Where the Apple Commission fails to appoint a person for the unexpired term of a member under subsection (1) within thirty days after the death or resignation of the member, the Commission may appoint a person for the unexpired term. R.R.O. 1980, Reg. 340, Sched.; O. Reg. 490/82, s. 1; O. Reg. 735/86, s. 2; O. Reg. 501/88, s. 1; O. Reg. 663/90, s. 1.

REGULATION 389

ARBITRATION OF DISPUTES

1.—(1) Where,

- (a) an agreement is made by a negotiating agency established in connection with a plan under paragraph 25 of subsection 7 (1) of the Act; or
- (b) an award is made by a board under paragraph 27 of subsection 7 (1) of the Act,

and a dispute arises out of that agreement or that award, any party to the dispute or the local board may refer the matters in dispute to the Commission and request that the matters in dispute be settled by an arbitrator or a board of arbitration.

(2) Where matters in dispute are referred to the Commission under subsection (1), the reference shall be accompanied by a statement of matters in dispute in writing signed by the party or by a person authorized so to do on the party's behalf or by the secretary or other officer of the local board, showing,

- (a) the names and addresses of the parties to the dispute;
- (b) particulars of the matters in dispute, including the times when and places where and the circumstances under which the dispute arose;
- (c) the provisions of the agreement or award out of which the dispute arose; and
- (d) the matters to be settled by an arbitrator or a board of arbitration. R.R.O. 1980, Reg. 342, s. 1.

2.—(1) Where the Commission receives a statement of matters in dispute, the Commission, if it is of the opinion that the dispute is in respect of matters arising out of an agreement or award in force at the time the dispute arose and no provision is made in the agreement or award for the settlement of such dispute, shall appoint an arbitrator or a board of arbitration and shall refer the matters in dispute to the arbitrator or board of arbitration, as the case may be.

(2) A board of arbitration shall consist of three members, one of whom shall be a member of the negotiating committee appointed by the local board, and one of whom shall be a member of the negotiating committee appointed other than by the local board. R.R.O. 1980, Reg. 342, s. 2.

3. An arbitrator or a board of arbitration appointed by the Commission under subsection 2 (1) shall make an award in respect of the matters submitted to it. R.R.O. 1980, Reg. 342, s. 3.

REGULATION 390

ASPARAGUS—MARKETING

1. In this Regulation,

“asparagus” means asparagus produced in Ontario;

“fresh asparagus” means asparagus, except asparagus that is used by a processor for processing;

“local board” means The Ontario Asparagus Growers' Marketing Board;

“processing” means canning, dehydrating, drying, freezing or processing with sugar or sulphur dioxide or any other chemical;

“processor” means a person engaged in the business of processing asparagus;

“producer” means a person who, on the 1st day of May in any year, is the beneficial owner of a property on which two acres or more of asparagus are growing. R.R.O. 1980, Reg. 344, s. 1; O. Reg. 537/90, s. 1.

2. This Regulation provides for the control and regulation, in any or all respects, of the producing and marketing within Ontario of asparagus, including the prohibition of such producing and marketing in whole or in part. R.R.O. 1980, Reg. 344, s. 2.

3. The Commission exempts from section 10 of this Regulation,

- (a) a producer who produces two acres of asparagus or less; and
- (b) a producer of asparagus in respect of any acreage of asparagus that has been planted for less than twenty-four months. O. Reg. 569/81, s. 1, *part*; O. Reg. 170/84, s. 1; O. Reg. 757/88, s. 1; O. Reg. 537/90, s. 2.

4.—(1) No person shall engage in the processing of asparagus except under the authority of and in accordance with a licence as a processor from the Commission.

(2) A licence expires with the 31st day of January in the year next following the year in which it was issued.

(3) A licence shall be issued to a processor of asparagus without charge. O. Reg. 225/89, s. 2.

5. The Commission may refuse to grant or renew a licence or may suspend or revoke a licence where the applicant or licensee,

- (a) is not qualified by experience, financial responsibility or equipment to properly engage in the business for which the application was made or the licence granted; or
- (b) has failed to comply with or has contravened the Act, the regulations, the plan or an order or direction of the Commission. O. Reg. 757/88, s. 3, *part*.

6. The Commission may impose such conditions on a licence as the Commission considers proper. O. Reg. 757/88, s. 3, *part*.

7. Where, after a hearing, the Commission is of the opinion that an applicant or licensee has contravened a condition of the licence or the Act, the regulations, the plan or an order or direction of the Commission, the Commission may impose a penalty on the applicant or licensee. O. Reg. 757/88, s. 3, *part*.

8.—(1) The Commission may require that a processor furnish a performance bond that does not exceed 10 per cent of the price payable to producers for asparagus processed during the immediately preceding twelve-month period by the processor.

(2) The Commission may determine that the performance bond is forfeited when the processor who furnished the bond contravenes a condition of the processor's licence or the Act, the regulations, the plan or an order or direction of the Commission. O. Reg. 757/88, s. 3, *part*.

9.—(1) If a penalty is imposed under section 7 or a performance bond is forfeited under subsection 8 (2), the Commission shall pay the penalty or the proceeds of the performance bond, or both, to the local board for distribution proportionately among the producers of

asparagus who sold asparagus to the processor and who did not receive the minimum price for the asparagus.

(2) If there are no producers to whom subsection (1) applies, the Commission shall make the payment to the Treasurer of Ontario. O. Reg. 757/88, s. 3, *part*.

10. Every producer shall pay to the local board the licence fees fixed by the local board. O. Reg. 506/85, s. 1 (3).

11. Every producer and person engaged in the marketing of asparagus shall pay to the local board interest on licence fees and service charges in arrears at the rate of 1.5 per cent per month. O. Reg. 757/88, s. 4.

12. The Commission delegates to the local board the power,

- (a) to require persons engaged in producing or marketing asparagus to register their names, addresses and occupations with the local board;
- (b) to require persons engaged in producing or marketing asparagus to furnish such information relating to the producing or marketing of asparagus, including the filing of completed returns, as the local board determines;
- (c) to appoint persons to,
 - (i) inspect the books, records, documents, lands and premises and any asparagus of persons engaged in producing or marketing asparagus, and
 - (ii) enter on land or premises used for the producing of asparagus and measure the area of land used to produce asparagus;
- (d) to stimulate, increase and improve the marketing of asparagus by such means as it considers proper;
- (e) to co-operate with a marketing board, local board, marketing commission or marketing agency of Canada or of any province of Canada for the purpose of marketing asparagus; and
- (f) to do such acts and make such orders and issue such directions as are necessary to enforce the due observance and carrying out of the Act, the regulations and the plan. R.R.O. 1980, Reg. 344, s. 7; O. Reg. 757/88, s. 1; O. Reg. 225/89, s. 3.

13. Every producer shall, not later than the 21st day of May in each year, complete and file with the local board at its head office, a return in Form 1. R.R.O. 1980, Reg. 344, s. 8.

14. The Commission delegates to the local board its powers to make regulations with respect to asparagus,

- (a) providing for the licensing of any or all persons before commencing or continuing to engage in the producing or marketing of asparagus;
- (b) prescribing or providing for classes of licences and the imposition of terms and conditions on any class of licence;
- (c) prohibiting persons from engaging in the producing or marketing of asparagus except under the authority of a licence and except in compliance with the terms and conditions of the licence;
- (d) providing for the suspension or revocation of, or the refusal to grant or renew, a licence where the applicant or licensee,
 - (i) is not qualified by experience, financial responsibility or equipment to properly engage in the business

for which the application was made or the licence granted, or

- (ii) has contravened the Act, the regulations, the plan or an order or direction of the Commission or local board;
- (e) providing for the imposition, amount, disposition and use of penalties where, after a hearing, the local board is of the opinion that the applicant or licensee has failed to comply with or has contravened any term or condition of the licence or the Act or regulations, the plan or any order or direction of the local board;
- (f) providing for the fixing of licence fees and the payment thereof by any or all persons producing or marketing asparagus;
- (g) providing for the control and regulation of the producing and marketing of asparagus including the times and places at which asparagus may be produced and marketed;
- (h) providing for the collection of licence fees from any or all persons producing or marketing asparagus and the recovering of such licence fees by suit in a court of competent jurisdiction;
- (i) requiring any person who receives asparagus to deduct from the money payable for the asparagus any licence fees payable to the local board by the person from whom the asparagus is received and to forward such licence fees to the local board;
- (j) prescribing the form of licences;
- (k) requiring any person who produces and processes asparagus to furnish to the local board statements of the amount of asparagus that the person produced in any year and used for processing;
- (l) subject to section 3, providing for the exemption from any or all of the regulations, orders or directions under the plan of any class, variety, grade or size of asparagus, or any person or class of persons engaged in the producing or marketing of asparagus or any class, variety, grade or size of asparagus;
- (m) requiring and providing for the furnishing of security or proof of financial responsibility or of a performance bond by a person or class of persons engaged in the marketing of asparagus and providing for the administration, forfeiture and disposition of any money or securities so furnished and the proceeds therefrom;
- (n) authorizing the fixing of prompt payments discounts, delayed payment penalties and interest on licence fees and service charges owing by any person engaged in the producing or marketing of asparagus;
- (o) providing for the control and regulation of agreements entered into by producers of asparagus with persons engaged in marketing or processing asparagus, and the prohibition of any provision or clause in such agreements;
- (p) requiring any person who produces asparagus to offer to sell and to sell the asparagus to or through the local board;
- (q) prohibiting any person from processing, packing or packaging any asparagus that has not been sold by or through the local board;
- (r) providing for the making of agreements relating to the marketing of asparagus by or through the local board and prescribing the forms and the terms and conditions of such agreements; and

- (s) providing for the making of such orders and the issuing of such directions as are necessary to ensure compliance with the Act, the regulations, the plan or any order or direction of the local board. R.R.O. 1980, Reg. 344, s. 9; O. Reg. 506/85, s. 1(4); O. Reg. 757/88, ss. 1, 5; O. Reg. 225/89, s. 4.
15. The local board may impose such terms and conditions upon a licence as the local board considers proper. O. Reg. 225/89, s. 5.
- 16.—(1) The Commission authorizes the local board to use any class of licence fees, service charges and other money payable to it for the purposes of paying the expenses of the local board, carrying out and enforcing the Act and the regulations and carrying out the purposes of The Ontario Asparagus Growers' Marketing Plan. R.R.O. 1980, Reg. 344, s. 10 (1); O. Reg. 757/88, s. 1.
- (2) The Commission authorizes the local board to establish a fund in connection with the plan for the payment of any money that may be required for the purposes mentioned in subsection (1). R.R.O. 1980, Reg. 344, s. 10 (2); O. Reg. 757/88, s. 1.
17. The Commission authorizes the local board to conduct a pool or pools for the distribution of all money received from the sale of asparagus and, after deducting all necessary and proper disbursements and expenses, to distribute the remainder of the money received from the sale in such manner that every producer receives a share of the remainder of the money received from the sale in relation to the amount, class, variety, grade or size of asparagus delivered, and authorizes such local board to make an initial payment on delivery of the asparagus and subsequent payments until all of the remainder of the money received from the sale is distributed to the producers. R.R.O. 1980, Reg. 344, s. 11; O. Reg. 757/88, s. 1.
18. The Commission authorizes the local board to appoint agents, to prescribe their duties and terms and conditions of employment and to provide for their remuneration. R.R.O. 1980, Reg. 344, s. 12; O. Reg. 757/88, s. 1.
19. The Commission vests in the local board the following powers:
1. To direct and control, by order or direction, either as principal or agent, the producing and marketing of asparagus including the times and places at which asparagus may be produced and marketed.
 2. To determine the quality of each class, variety, grade and size of asparagus that shall be marketed by each producer.
 3. To prohibit the marketing of any class, variety, grade or size of asparagus.
 4. To determine from time to time the price or prices that shall be paid to producers or to the local board, as the case may be, for asparagus or any class, variety, grade or size of asparagus and to determine different prices for different parts of Ontario.
 5. To fix and impose service charges from time to time for the marketing of asparagus.
 6. To require the price or prices payable or owing to the producer for asparagus to be paid to or through the local board.
 7. To collect from any person by suit in a court of competent jurisdiction the price or prices or any part thereof of asparagus.
 8. To purchase or otherwise acquire such quantity or quantities of asparagus as the local board considers advisable and to sell or otherwise dispose of any of the asparagus so purchased or acquired.
 9. To pay from service charges imposed under paragraph 5 its expenses in carrying out the purposes of the plan.
 10. To pay to the producers the price or prices for asparagus less service charges imposed under paragraph 5 and to fix the times at which or within which such payments shall be made. R.R.O. 1980, Reg. 344, s. 13; O. Reg. 757/88, ss. 1, 6.
 20. Each payment under paragraph 10 of section 19 shall be accompanied by a statement showing the grades and quantity of each grade of asparagus sold, the price or prices paid and the particulars of the service charges imposed by the local board. R.R.O. 1980, Reg. 344, s. 14.
 - 21.—(1) There shall be an advisory committee to be known as "The Asparagus Industry Advisory Committee" composed of seven members. R.R.O. 1980, Reg. 344, s. 15 (1).
 - (2) After the 1st day of January and before the 31st day of January in each year,
 - (a) the Commission shall appoint one member;
 - (b) the local board shall appoint three members; and
 - (c) the Ontario Food Processors' Association shall appoint three members,
 to The Asparagus Industry Advisory Committee. R.R.O. 1980, Reg. 344, s. 15 (2); O. Reg. 757/88, s. 1.
 - (3) Subject to subsections (4) and (5), the members of the advisory committee appointed under subsection (2) are and remain members thereof until the 31st day of January in the year following the year in which they were appointed.
 - (4) Where a member of the advisory committee dies or resigns or is unavailable to act before the expiration of his or her term, the person or persons who appointed him or her shall appoint a person for the unexpired term of the member who died or resigned or was unavailable to act. R.R.O. 1980, Reg. 344, s. 15 (3, 4).
 - (5) Where the local board or the Ontario Food Processors' Association, as the case may be, fails to appoint a member or members to the advisory committee in accordance with subsection (2) or (4), the Commission may appoint such members as are necessary to complete the advisory committee. R.R.O. 1980, Reg. 344, s. 15 (5); O. Reg. 757/88, s. 1.
 - (6) The Asparagus Industry Advisory Committee is empowered to advise and make representations to the local board or to the Ontario Food Processors' Association in respect of,
 - (a) the promotion of harmonious relationships between persons engaged in the production and marketing of asparagus for processing;
 - (b) the promotion of greater efficiency in the production and marketing of asparagus for processing;
 - (c) the prevention and correction of irregularities and inequities in the marketing of asparagus for processing;
 - (d) the improvement of the quality and variety of asparagus for processing;
 - (e) the improvement of the circulation of market information respecting asparagus for processing; and
 - (f) without limiting the generality of any of the foregoing, any matter with respect to which the Commission or the local board may be empowered to make regulations, relating to asparagus for processing, under the Act. O. Reg. 569/81, s. 2; O. Reg. 757/88, s. 1.

22.—(1) There shall be an advisory committee to be known as the “Fresh Asparagus Advisory Committee” composed of eight members. O. Reg. 569/81, s. 3, *part*.

(2) After the 1st day of January and before the 31st day of January in each year,

- (a) the local board shall appoint three members of the advisory committee to represent producers;
- (b) the Commission shall appoint one member of the advisory committee to represent consumers;
- (c) the Commission shall appoint one member of the advisory committee to represent retailers;
- (d) the Commission shall appoint one member of the advisory committee to represent wholesalers who do not carry on business at the Ontario Food Terminal at Toronto;
- (e) the Commission shall appoint one member of the advisory committee to represent wholesalers who carry on business at the Ontario Food Terminal at Toronto; and
- (f) the Commission shall appoint one member to be chair of the advisory committee. O. Reg. 569/81, s. 3, *part*; O. Reg. 757/88, s. 1.

(3) Subject to subsections (4) and (5), the members of the advisory committee appointed under subsection (2) are and remain members thereof until the 31st day of January in the year following the year in which they were appointed. O. Reg. 569/81, s. 3, *part*.

(4) Where a member of the advisory committee dies or resigns or is unavailable to act before the expiration of his or her term, the local

board or the Commission, as the case may be, shall appoint a person for the unexpired term of the member who dies or resigned or was unavailable to act. O. Reg. 569/81, s. 3, *part*; O. Reg. 757/88, s. 1.

(5) Where the local board fails to appoint a member or members to the advisory committee in accordance with subsection (2) or (4), the Commission may appoint such members as are necessary to complete the advisory committee. O. Reg. 569/81, s. 3, *part*; O. Reg. 757/88, s. 1.

(6) The advisory committee is empowered to advise and make representations to the local board in respect of,

- (a) the promotion of harmonious relationships between persons engaged in the production and marketing of fresh asparagus;
- (b) the promotion of greater efficiency in the production and marketing of fresh asparagus;
- (c) the prevention and correction of irregularities and inequities in the marketing of fresh asparagus;
- (d) the improvement of the quality and variety of fresh asparagus;
- (e) the improvement of the circulation of market information respecting fresh asparagus; and
- (f) without limiting the generality of any of the foregoing, any matter with respect to which the Commission or the local board may be empowered to make regulations, relating to fresh asparagus, under the Act. O. Reg. 569/81, s. 3, *part*; O. Reg. 757/88, s. 1.

Form 1

Farm Products Marketing Act

ANNUAL ASPARAGUS ACREAGE REPORT FOR 19..... CROP YEAR

PLEASE PRINT:

1. NAME AND ADDRESS OF OPERATOR (OWNER OR TENANT)

.....
Family or last name or name of corporation

.....
Usual first name and initials (if an individual)

.....
Address—P.O. Box No., R.R. No., or name of street or road

.....
Local Municipality

.....
County or Regional Municipality

.....
Postal Code

.....
Person Officially Responsible for the Asparagus Patch(es)

2. PLEASE CHECK IF FARM IS OWNED OR RENTED

.....
If rented, please give the owner's name and address.

3. This is the annual survey for Assessment of Asparagus acreage within Ontario for the current crop year.

Your acreage for the 19..... Crop Year is as follows; based on your assessment and/or acreage measurement.

Total Acres Planted in Asparagus

Less: Acreage Exemptions (Planted after May 1/..)

TOTAL ASSESSABLE ACREAGE

If There Is No Change, Please Sign Below and Return.

4. If your Assessment *Does Not Agree* With Your Records, Complete The Remainder of This Form.

TOTAL ASPARAGUS ACREAGE ON MAY 1, 19..... (FOR PROCESSING AND FRESH MARKET)

Variety	Planting in 19.....	1-2 Years	3-4 Years	5-10 Years	Over 10 Years	TOTAL
U.C. 66						
U.C. 72						
Viking						
Viking 2K						
Other						
Total						

ACRES DEDUCTED

Removed acres

No longer renting acres

Sold acres (to whom)

(name)

(address)

Dated at, this day of, 19.....

Telephone No.

ADDITIONAL ACRES

Acres reaching maturity

Acres previously rented out

Acres purchased (from whom)

(name)

(address)

Signature

R.R.O. 1980, Reg. 344, Form 4.

REGULATION 391

ASPARAGUS—PLAN

1. The plan in the Schedule is continued for the control and regulation of the producing and marketing within Ontario of asparagus. O. Reg. 633/88, s. 1.

2. The local board named in the Schedule is given the powers set out in subsection 15 (1), in paragraphs 1, 2, 3, 4, 5, 6, 7, 8, 10, 11, 12, 13, 14, 15, 16, 17, 18, 19 and 26 of subsection 15 (2) and in sections 50 and 110 of the *Co-operative Corporations Act*. R.R.O. 1980, Reg. 343, s. 2.

3. The members of the local board shall be deemed to be the shareholders and directors thereof in the exercise of any powers mentioned in section 2. R.R.O. 1980, Reg. 343, s. 3.

Schedule

Farm Products Marketing Act

PLAN

1. This plan may be cited as "The Ontario Asparagus Growers' Marketing Plan".

2. In this plan,

"asparagus" means asparagus produced in Ontario;

"fresh asparagus" means asparagus, except asparagus that is used by a processor for processing;

"processing" means canning, dehydrating, drying, freezing or processing with sugar or sulphur dioxide or any other chemical;

"processor" means a person engaged in the business of processing asparagus;

"producer" means a person who, on the 1st day of May in any year, is the beneficial owner of property on which two acres or more of asparagus are growing.

3.—(1) This Regulation provides for the control and regulation in any or all respects of the producing and marketing within Ontario of asparagus, including the prohibition of such producing and marketing in whole or in part.

(2) A person who is a producer in any year may, in that year, vote for or be elected or appointed a member of the local board or a District Asparagus Growers' Committee under sections 8, 9 and 10.

(3) A producer who is renting property to a tenant on the 1st day of May in any year may, in writing, assign to that tenant the producer's voting and membership privileges in respect of that year, in which case the tenant shall be deemed to be the producer.

(4) If the producer in respect of a property is a corporation, a person designated in writing for that property by the corporation shall be deemed to be the producer.

(5) If the producer in respect of a property is a firm or partnership of one or more persons carrying on the production and marketing under a trade name, farm name or other designation, a person designated in writing for that property by the owner or owners shall be deemed to be the producer.

(6) If the producer in respect of a property is comprised of two or more joint owners, the joint owner who first presents himself or herself to register the vote in respect of that property shall be deemed to be the producer.

4. There shall be a local board to be known as "The Ontario Asparagus Growers' Marketing Board".

5. The local board shall be composed of nine producer-members.

6. Producers are divided into five districts as follows:

1. District 1, comprising the counties of Essex, Kent, Lambton and Middlesex and that part of the County of Huron lying south of King's Highway No. 83.

2. District 2, comprising the counties of Elgin, Oxford and Perth, The Regional Municipality of Waterloo and that part of The Regional Municipality of Haldimand-Norfolk lying south of King's Highway No. 3.

3. District 3, comprising the counties of Bruce, Dufferin, Grey, Wellington and Simcoe, that part of the County of Huron lying north of King's Highway No. 83, The Regional Municipality of Peel and The Regional Municipality of York.

4. District 4, comprising those parts of Ontario that are not included in districts 1, 2, 3 and 5.

5. District 5, comprising the County of Brant, the regional municipalities of Halton, Hamilton-Wentworth and Niagara and that part of The Regional Municipality of Haldimand-Norfolk lying north of King's Highway No. 3.

7. There shall be a committee in each district to be known as the "District Asparagus Growers' Committee".

8. On or before the 15th day of December in each year the producers in each of the districts named in section 6 shall elect from their members one producer for each fifteen producers or fraction thereof in the district to the District Asparagus Growers' Committee for the district.

9.—(1) On or before the 31st day of December in each year, each District Asparagus Growers' Committee may elect from the producers in the district members to the local board as follows:

1. District 1, two members.
2. District 2, two members.
3. District 3, two members.
4. District 4, one member.
5. District 5, two members.

(2) No person is eligible for election from any district to the local board unless he or she resides within the district.

(3) Where in any year a District Asparagus Growers' Committee fails to elect one or more members to the local board in accordance with subsection (1), the members of all District Asparagus Growers' Committees may on or before the 31st day of December of that year elect the member or members from that district to the local board.

10.—(1) At its first meeting after the 31st day of December the members elected to the local board shall appoint such producer-members as are necessary to complete the local board.

(2) Where a member elected or appointed to the local board dies or resigns before the 31st day of December of the year next following the date of his or her election or appointment, the members of the local board may appoint a producer-member for the unexpired term.

(3) Each producer-member appointed as a member to the local board under subsection (1) or (2) shall be a producer in the district for which he or she is appointed.

11. The terms of office of members of a District Asparagus Growers' Committee or of the local board expire with the election or appointment of their successors. R.R.O. 1980, Reg. 343, Sched.; O. Reg. 633/88, s. 2; O. Reg. 536/90, ss. 1, 2.

REGULATION 392

BEANS—MARKETING

1. In this Regulation,

"beans" means white pea-beans produced in Ontario;

"dealer" means a person who buys beans from a producer as an agent of the local board;

"local board" means The Ontario Bean Producers' Marketing Board;

"plan" means The Ontario Bean Producers' Marketing Plan;

"processing" includes picking, polishing, drying and canning or processing with or without other ingredients or processing or manufacturing articles of food or drink in whole or in part from beans;

"producer" means a person engaged in the production of beans. R.R.O. 1980, Reg. 346, s. 1; O. Reg. 649/87, s. 1.

2. This Regulation provides for the control and regulation in any or all respects of the producing and marketing within Ontario of beans, including the prohibition of such producing and marketing in whole or in part. O. Reg. 506/85, s. 2 (1).

POWERS OF LOCAL BOARD

3.—(1) The Commission authorizes the local board to use the licence fees, service charges, and other money payable to it, for the purposes of paying the expenses of the local board, carrying out and enforcing the Act and the regulations and carrying out the purposes of the plan.

(2) The Commission authorizes the local board to establish a fund in connection with the plan for the payment of any money that may be required for the purposes mentioned in subsection (1). R.R.O. 1980, Reg. 346, s. 4.

4. The Commission authorizes the local board to prohibit the marketing of any grade or size of beans. R.R.O. 1980, Reg. 346, s. 5.

5. The Commission delegates to the local board the power,

(a) to require persons engaged in producing or marketing beans to register their names, addresses and occupations with the local board;

(b) to require persons engaged in producing or marketing beans to furnish such information relating to the production or marketing of beans including the completing and filing of returns, as the local board determines;

(c) to appoint persons to inspect the books, records, documents, lands and premises and any beans of persons engaged in the marketing of beans;

(d) to stimulate, increase and improve the marketing of beans by such means as it considers proper;

(e) to co-operate with a marketing board, local board, market-

ing agency of Canada or of any province in Canada for the purpose of marketing beans;

- (f) to do such acts and make such orders and issue such directions as are necessary to enforce the due observance and carrying out of the provisions of the Act, the regulations or the plan. R.R.O. 1980, Reg. 346, s. 6.

6. The Commission delegates to the local board its powers to make regulations with respect to beans,

- (a) providing for the licensing of any or all persons before commencing or continuing to engage in the producing or marketing of beans;
- (b) prohibiting persons from engaging in the producing or marketing of beans except under the authority of a licence;
- (c) providing for the refusal to grant a licence where the applicant is not qualified by experience, financial responsibility and equipment to engage in properly the business for which the application was made, or for any other reason that the local board considers proper;
- (d) providing for the suspension or revocation of, or the refusal to renew, a licence for failure to observe, perform or carry out the Act, the regulations, the plan or any order or direction of the Commission or local board;
- (e) providing for the fixing of licence fees payable yearly, half-yearly, quarterly or monthly at different amounts or in instalments from any or all persons producing or marketing beans and the collecting of the licence fees and the recovering of the licence fees by suit in a court of competent jurisdiction;
- (f) requiring any person who receives beans to deduct from the money payable for the beans any licence fees payable to the local board by the person from whom he, she or it receives the beans, and to forward such licence fees to the local board;
- (g) requiring any person who produces and processes beans to furnish to the local board statements of the amount of beans produced in any year and used for processing;
- (h) prescribing the form of licences;
- (i) providing for the exemption from any or all of the regulations, orders or directions under the plan of any class, variety, grade or size of beans, or any person or class of persons engaged in the producing or marketing of beans or any class, variety, grade or size of beans;
- (j) requiring the furnishing of security or proof of financial responsibility by any person engaged in the marketing of beans and providing for the administration and disposition of any money or securities so furnished;
- (k) providing for the control and regulation of the marketing of beans, including the times and places at which beans may be marketed;
- (l) providing for the control and regulation of agreements entered into by producers of beans with persons engaged in marketing or processing beans, and the prohibition of any provision or clause in such agreements;
- (m) requiring any person who produces beans to offer to sell and to sell the beans to or through the local board;
- (n) prohibiting any person from processing, packing or packaging any beans that have not been sold to, by or through the local board; and

- (o) providing for the making of agreements relating to the marketing of beans by or through the local board, and prescribing the forms and the terms and conditions of such agreements. R.R.O. 1980, Reg. 346, s. 7; O. Reg. 408/84, s. 1; O. Reg. 506/85, s. 2 (3).

APPOINTMENT OF AGENTS

7. The Commission authorizes the local board to appoint agents, to prescribe their duties and terms and conditions of employment and to provide for their remuneration. R.R.O. 1980, Reg. 346, s. 9.

MARKETING OF BEANS

8.—(1) All beans shall be marketed by or through the local board.

(2) No person shall market beans except by or through the local board. R.R.O. 1980, Reg. 346, s. 10.

9. The Commission vests in the local board the following powers:

1. To direct and control, by order or direction either as principal or agent, the marketing of beans, including the times and places at which beans may be marketed.
2. To determine the quality of each class, variety, grade and size of beans that shall be marketed by each producer.
3. To prohibit the marketing of any class, variety, grade or size of beans.
4. To determine from time to time the price or prices that shall be paid to producers or to the local board, as the case may be, for beans or any class, variety, grade or size of beans and to determine different prices for different parts of Ontario.
5. To fix and impose service charges from time to time for the marketing of beans.
6. To require the price or prices payable or owing to the producer for beans to be paid to or through the local board.
7. To collect from any person by suit in a court of competent jurisdiction the price or prices or any part thereof of beans.
8. To purchase or otherwise acquire such quantity or quantities of beans as the local board considers advisable and to sell or otherwise dispose of any beans so purchased or acquired.
9. To pay from service charges imposed under paragraph 5 its expenses in carrying out the purposes of the plan.
10. To pay to the producers the price or prices for beans less service charges imposed under paragraph 5 and to fix the times at which or within which such payments shall be made. R.R.O. 1980, Reg. 346, s. 11.

10. Each payment under paragraph 9 of section 9 shall be accompanied by a statement showing the class, variety, grade or size and the number or quantity of beans marketed, the price or prices paid and the particulars of the service charges imposed by it. R.R.O. 1980, Reg. 346, s. 12.

11. The Commission authorizes the local board to conduct a pool or pools for the distribution of all money received from the sale of beans and after deducting all necessary and proper disbursements and expenses, to distribute the remainder of the money received from the sale in such manner that every producer receives a share of the remainder of the money received from the sale in relation to the amount, class, variety, grade or size of beans delivered, and authorizes the local board to make an initial payment on delivery of the beans and subsequent payments until all of the remainder of the

money received from the sale is distributed to the producers. R.R.O. 1980, Reg. 346, s. 13.

BEAN INDUSTRY ADVISORY COMMITTEE

12. There shall be an advisory committee to be known as "The Bean Industry Advisory Committee" composed of a chair and eight members. R.R.O. 1980, Reg. 346, s. 14.

13. After the 1st day of January and on or before the 15th day of January in each year,

- (a) the Commission shall appoint the chair;
- (b) the local board shall appoint four members;
- (c) the dealers shall appoint three members; and
- (d) The Ontario Food Processors' Association shall appoint one member,

to The Bean Industry Advisory Committee. R.R.O. 1980, Reg. 346, s. 15.

14. Subject to section 15, the members of the advisory committee appointed under section 13 are and remain members thereof until the 15th day of January in the year next following the year in which they were appointed. R.R.O. 1980, Reg. 346, s. 16.

15. Where a member of The Bean Industry Advisory Committee dies or resigns or is unavailable to act before the expiration of his or her term, the person or persons who appointed him or her shall appoint a person for the unexpired term of the member who died, resigned or was unavailable to act. R.R.O. 1980, Reg. 346, s. 17.

16. Where any of the persons referred to in clauses 13 (a), (b), (c) and (d) fail to appoint a member to The Bean Industry Advisory Committee in accordance with section 13 or 15, the Commission may appoint such members as are necessary to complete the said committee. R.R.O. 1980, Reg. 346, s. 18.

17. The Bean Industry Advisory Committee is empowered to advise and make recommendations to the local board, the dealers or The Ontario Food Processors' Association in respect of any of the following matters:

1. The promotion of harmonious relationships between persons engaged in the production and marketing of beans.
2. The promotion of greater efficiency in the production and marketing of beans.
3. The prevention and correction of irregularities and inequities in the marketing of beans.
4. The improvement of the quality and variety of beans.
5. The improvement of the circulation of market information respecting beans.
6. Without limiting the generality of any of the foregoing, any matter with respect to which the Commission or the local board may be empowered to make regulations under the Act. R.R.O. 1980, Reg. 346, s. 19.

2. The local board named in the Schedule is given the powers set out in subsection 15 (1), in paragraphs 1 to 8, 10 to 19, 24 and 26 of subsection 15 (2) and in sections 50 and 110 of the *Co-operative Corporations Act*. O. Reg. 647/87, s. 1, *part*.

3. The members of the local board shall be deemed to be the shareholders and the directors thereof in the exercise of any of the powers mentioned in section 2. R.R.O. 1980, Reg. 345, s. 3.

Schedule

Farm Products Marketing Act

PLAN

1. This plan may be cited as "The Ontario Bean Producers' Marketing Plan".

2. In this plan,

"beans" means white pea-beans produced in Ontario;

"producer" means a person engaged in the production of beans.

3. This plan applies to the control and regulation in any or all respects of the producing and marketing within Ontario of beans.

4. There shall be a local board to be known as "The Ontario Bean Producers' Marketing Board".

5. The local board shall be composed of nine producer-members and the members in each district shall hold office until their successors are elected.

6. Producers are divided into four districts as follows:

1. District 1, comprising the Counties of Essex, Kent and Lambton.
2. District 2, comprising the Counties of Elgin, Middlesex and Oxford.
3. District 3, comprising the Counties of Grey, Perth and Wellington and The Regional Municipality of Waterloo.
4. District 4, comprising the Counties of Bruce and Huron.

7. There shall be a committee in each district to be known as the "District Bean Producers' Committee".

8.—(1) The District Bean Producers' Committees shall have the following number of members:

1. District 1, four members.
2. District 2, eight members.
3. District 3, eight members.
4. District 4, twelve members.

(2) A producer in a territorial district or in a county not mentioned in section 6 may for the purposes of the plan be deemed to be a producer in the district nearest to his, her or its place of production.

9. On or before the 15th day of December in each year producers in each district, at a meeting called by the local board for the purpose, shall elect from among themselves the members of the District Bean Producers' Committee for the district.

10.—(1) On or before the 31st day of December in each year, the producers in each district shall elect from among themselves members to the local board as follows, to hold office for one year from the 31st day of December of that year:

REGULATION 393

BEANS—PLAN

1. The plan in the Schedule is continued for the control and regulation of the producing and marketing within Ontario of beans. O. Reg. 647/87, s. 1, *part*.

1. District 1, one member.
2. District 2, two members.
3. District 3, two members.
4. District 4, four members.

(2) No person is eligible for election or appointment from any district to the local board unless he or she is a producer in the district, and in no case shall he or she be elected to represent more than one district.

11.—(1) At its first meeting after their term of office has commenced, the members elected to the local board shall appoint the producer-members that are necessary to complete the local board.

(2) Where a member of the local board dies or resigns before the expiration of his or her term of office, the members of the local board may appoint a producer-member for the unexpired term. R.R.O. 1980, Reg. 345, Sched.; O. Reg. 665/82, ss. 1-3; O. Reg. 647/87, s. 2; O. Reg. 648/87, s. 1.

REGULATION 394

BERRIES FOR PROCESSING—MARKETING

1. In this Regulation,

“berries” means strawberries and raspberries produced in Ontario that are used by a processor for processing;

“local board” means the Ontario Berry Growers’ Marketing Board;

“plan” means The Ontario Berry Growers’ Marketing-for-Processing Plan;

“processing” means canning, dehydrating, drying, freezing or processing with sugar or sulphur dioxide or any other chemical;

“processor” means a person engaged in the business of processing berries;

“producer” means a person engaged in the production of berries. R.R.O. 1980, Reg. 348, s. 1.

2. This Regulation provides for the control and regulation in any or all respects of the producing and marketing within Ontario of berries, including the prohibition of such producing and marketing in whole or in part. O. Reg. 506/85, s. 3 (1).

LICENCES

3.—(1) No person shall commence or continue to engage in the growing of berries except under the authority of a licence. R.R.O. 1980, Reg. 348, s. 3 (1); O. Reg. 506/85, s. 3 (2).

(2) Every producer, while not in default of the fees required to be paid under section 6, shall be deemed to be the holder of a licence. O. Reg. 506/85, s. 3 (3).

4.—(1) No person shall commence or continue to engage in the processing of berries except under the authority of a licence as a processor of berries in Form 2.

(2) No licence as a processor of berries shall be issued except upon application therefor in Form 1.

(3) A licence as a processor of berries expires with the 31st day of January next following the date on which the licence is issued.

(4) A licence shall be issued to a processor of berries without charge. R.R.O. 1980, Reg. 348, s. 4.

5.—(1) The Commission may refuse to grant a licence where the applicant is not qualified by experience, financial responsibility and equipment to engage in properly the business of a processor, or for any other reason that the Commission considers proper.

(2) The Commission may suspend or revoke or refuse to renew a licence as a processor of berries for failure to observe, perform or carry out the Act, the regulations, the plan or any order or direction of the Commission or local board. R.R.O. 1980, Reg. 348, s. 5.

6. Every producer shall pay to the local board the licence fees fixed by the local board. O. Reg. 506/85, s. 3 (4).

POWERS OF THE LOCAL BOARD

7. The Commission delegates to the local board the power,

(a) to stimulate, increase and improve the marketing of berries by such means as it considers proper;

(b) to co-operate with a marketing board, local board, marketing commission or marketing agency of Canada or of any province in Canada for the purpose of marketing berries;

(c) to do such acts and make such orders and issue such directions as are necessary to enforce the due observance and carrying out of this Act, the regulations and the plan. R.R.O. 1980, Reg. 348, s. 7.

8. The Commission delegates to the local board its powers to make regulations with respect to berries,

(a) providing for the fixing of licence fees payable yearly, quarterly or monthly at different amounts or in instalments from any or all persons producing berries and the collecting of the licence fees and the recovering of the licence fees by suit in a court of competent jurisdiction;

(b) requiring any person who receives berries to deduct from the money payable for the berries any licence fees payable to the local board by the person from whom the first mentioned person receives the berries, and to forward such licence fees to the local board; and

(c) requiring any person who produces and processes berries to furnish to the local board statements of the amounts of berries that the person produced in any year and used for processing. O. Reg. 506/85, s. 3 (5).

9.—(1) The Commission authorizes the local board to use any class of licence fees and other money payable to it, for the purpose of paying the expenses of the local board, carrying out and enforcing the Act and the regulations and carrying out the purposes of the Ontario Berry Growers’ Marketing-for-Processing Plan.

(2) The Commission authorizes the local board to establish a fund in connection with the plan for the payment of any money that may be required for the purposes mentioned in subsection (1). R.R.O. 1980, Reg. 348, s. 8.

10. The Commission authorizes the local board to require the price or prices payable or owing to the producers for berries to be paid to or through the local board. R.R.O. 1980, Reg. 348, s. 9.

11. The Commission authorizes the local board to prohibit the marketing locally within Ontario of any class, variety or grade of berries. R.R.O. 1980, Reg. 348, s. 10.

NEGOTIATING AGENCIES

12. (1) There shall be two negotiating agencies, to be known as,

(a) “The Negotiating Committee for Raspberries” and

(b) “The Negotiating Committee for Strawberries”.

(2) Each negotiating agency shall be composed of six persons, three of whom shall be appointed annually by the local board and three of whom shall be appointed annually by the processors.

(3) The local board and the processors shall appoint their respective members to the negotiating agencies and shall notify the Board in writing of the names and addresses of their respective members not later than the 5th day of June in each year.

(4) Where the local board or the processors fail to appoint the persons required by subsection (2), the Board shall appoint such persons as are necessary to complete the negotiating agency.

(5) Subject to subsection (6), the members of the negotiating agencies appointed under subsection (2) are and remain members until the 1st day of August of the year in which the members were appointed.

(6) Where a member of a negotiating agency dies or resigns or is unavailable to act on any committee before the expiration of his or her term of membership, the local board or the processors, as the case may be, shall appoint a person for the unexpired term of the member who died, resigned or was unavailable to act.

(7) Where the local board or the processors fail to make an appointment under subsection (6) within seven days after a vacancy occurs, the Commission may appoint such persons as are necessary to complete the negotiating agency. R.R.O. 1980, Reg. 348, s. 11.

13. Each negotiating agency named in subsection 12 (1) is empowered to adopt or settle by agreement in respect of berries,

- (a) minimum prices for strawberries or raspberries, as the case may be, or for any class, variety, grade or size thereof;
- (b) terms, conditions and forms of agreements relating to the producing or marketing of strawberries or raspberries, as the case may be; and
- (c) any charges, costs or expenses relating to the production or marketing of strawberries or raspberries, as the case may be. R.R.O. 1980, Reg. 348, s. 12.

14. A meeting of a negotiating agency may be convened by a notice in writing given by the three members of the negotiating agency appointed by the local board, or by the processors, to the other members of the negotiating agency at least seven days, but not more than ten days, before the date of the meeting stating the time and place of the meeting. R.R.O. 1980, Reg. 348, s. 13.

ARBITRATION

15.—(1) Where a meeting of the negotiating agency is not held in accordance with the notice required by section 14, or where a meeting is held and the negotiating agency does not arrive at an agreement respecting all matters that it is empowered to adopt or settle by agreement,

- (a) in the case of strawberries, on or before the 5th day of June; or
- (b) in the case of raspberries, on or before the 20th day of June,

the matters in dispute shall be referred by the Commission to an Arbitration Board.

(2) Where the negotiating agency decides,

- (a) in the case of strawberries, on or before the 5th day of June; or
- (b) in the case of raspberries, on or before the 20th day of June,

in any year that agreement cannot be reached, it shall so notify the Commission.

(3) Where a negotiating agency does not arrive at an agreement on all matters that it is empowered to adopt or settle by agreement, it may submit in writing to the Commission a statement or statements of the matters in dispute. R.R.O. 1980, Reg. 348, s. 14.

16.—(1) The Arbitration Board shall be composed of three members.

(2) One member may be appointed by the three members of the negotiating agency appointed by the local board and one other member may be appointed by the three members of the negotiating agency appointed by the processors.

(3) Where two members are appointed to the Arbitration Board in accordance with subsection (2), the two members so appointed may appoint a third member to the Arbitration Board, but, where the two members fail to agree on the third member within seven days after the date mentioned in clause 15 (2) (a) or (b), in any year, the Commission shall appoint the third member.

(4) Where the three members of the negotiating agency appointed by the local board, or the three members of the negotiating agency appointed by the processors, fail to appoint a member to the Arbitration Board in accordance with subsection (2) within seven days after the date mentioned in clause 15 (2) (a) or (b), the Commission shall appoint such members as are necessary to complete the Arbitration Board.

(5) The Commission shall submit to the Arbitration Board any statement or statements of the matters in dispute received from a negotiating agency under subsection 15 (3).

(6) The Arbitration Board shall meet forthwith after the appointment of the three members thereof and shall make an award in respect of the matters referred to it, or all matters that the negotiating agency is empowered to adopt or settle by agreement, as the case may be. R.R.O. 1980, Reg. 348, s. 15.

Form 1

Farm Products Marketing Act

APPLICATION FOR LICENCE AS A PROCESSOR OF BERRIES

To: Ontario Farm Products Marketing Commission:

.....
 (name of applicant)

 (address)

makes application for a licence as a processor of berries under the *Farm Products Marketing Act*.

Dated at, this day of, 19.....

.....
(signature of applicant)

.....
(where applicant is a corporation or partnership, signature of person authorized to sign)

.....
(office)

Form 2*Farm Products Marketing Act***LICENCE AS A PROCESSOR OF BERRIES**

Under the *Farm Products Marketing Act* and the regulations, and subject to the limitations thereof, this licence is issued

to
(name)

.....
(address)

to engage in the processing of berries.

This licence expires with the 31st day of January next following the date of issue.

Issued at Toronto, this day of, 19.....

ONTARIO FARM PRODUCTS MARKETING COMMISSION:

.....
Chair

.....
Secretary

R.R.O. 1980, Reg. 348, Form 3.

REGULATION 395**BERRIES FOR PROCESSING—PLAN**

1. The plan in the Schedule is continued for the control and regulation of the marketing within Ontario of berries. R.R.O. 1980, Reg. 347, s. 1, *revised*.

2. The local board named in the Schedule is given the powers set out in subsection 15 (1), in paragraphs 1, 2, 3, 4, 5, 6, 7, 8, 10, 11, 12, 13, 14, 15, 16, 17, 18, 19 and 26 of subsection 15 (2) and in sections 50 and 110 of the *Co-operative Corporations Act*. R.R.O. 1980, Reg. 347, s. 2.

3. The members of the local board shall be deemed to be the shareholders and directors thereof in the exercise of the powers mentioned in section 2. R.R.O. 1980, Reg. 347, s. 3.

Schedule*Farm Products Marketing Act***PLAN**

1. This plan may be cited as “The Ontario Berry Growers’ Marketing-for-Processing Plan”.

2. In this plan,

“berries” means strawberries and raspberries produced in Ontario that are used by a processor for processing;

“processing” means canning, dehydrating, drying, freezing or processing with sugar or sulphur dioxide or any other chemical;

“processor” means a person engaged in the business of processing berries;

“producer” means a person engaged in the production of berries.

3. This plan applies to the regulation and control of the marketing of berries locally within Ontario.

4. There shall be a local board to be known as “The Ontario Berry Growers’ Marketing Board”.

5. The local board shall be composed of eight producer-members.

6. The Minister shall appoint the members of the local board and shall appoint one of the members to be its chair and another of the members to be its vice-chair.

7. The Minister may revoke any appointment made under section 6.

8. The terms of office of the members appointed under section 6 shall expire one year after the date of their appointment. R.R.O. 1980, Reg. 347, Sched.

REGULATION 396**BROILER HATCHING EGGS AND CHICKS—MARKETING**

1. In this Regulation,

“breeder chick” means a chick other than a chick not intended to be used for producing hatching eggs;

“breeder cockerel” means a cockerel other than a cockerel not used for breeding purposes for hatching eggs;

“breeder hen” means a hen other than a hen not used for producing hatching eggs;

“breeder pullet” means a pullet that is less than twenty-four weeks of age other than a pullet not intended to be used for producing hatching eggs;

“chick” means a chick other than a chick not intended to be grown into a chicken as defined in Regulation 403 of Revised Regulations of Ontario, 1990;

“Egg and Chick Commission” means the Ontario Broiler Hatching Egg and Chick Commission;

“fowl” means a breeder hen or breeder cockerel that is twenty-four weeks of age or older;

“hatching egg” means an egg other than an egg not intended to be hatched as a chick;

“plan” means the Ontario Broiler Hatching Egg and Chick Marketing Plan;

“producer” means a person engaged in the production of a regulated product, and “produces” and “producing” have corresponding meanings;

“regulated product” means a breeder chick, breeder cockerel, breeder hen, breeder pullet, chick, fowl or hatching egg. O. Reg. 436/83, s. 1; O. Reg. 70/85, s. 1; O. Reg. 118/90, s. 4; O. Reg. 277/90, s. 1.

2. This Regulation provides for the control and regulation in any or all respects of the producing and marketing within Ontario of breeder chicks, breeder cockerels, breeder hens, breeder pullets, chicks, fowl and hatching eggs, including the prohibition of such producing and marketing in whole or in part. O. Reg. 436/83, s. 2.

3. The Commission delegates to the Egg and Chick Commission the power,

- (a) subject to the regulations, to investigate, adjust or otherwise settle any dispute relating to the marketing of a regulated product between producers of hatching eggs and persons engaged in marketing such hatching eggs;
 - (b) after a hearing, to prohibit a person engaged in marketing a regulated product from terminating or varying, without just cause, the buying or the selling, as the case may be, of the regulated product;
 - (c) to require persons engaged in producing or marketing a regulated product to register their names, addresses and occupations with the Egg and Chick Commission;
 - (d) to require persons engaged in producing or marketing a regulated product to furnish such information relating to the production or marketing of the regulated product, including the completing and filing of returns, as the Egg and Chick Commission determines;
 - (e) to appoint persons to inspect the books, records, documents, lands and premises and any regulated product of persons engaged in producing or marketing a regulated product;
 - (f) to stimulate, increase and improve the marketing of regulated products by such means as it considers proper; and
 - (g) to co-operate with a marketing board, local board, marketing commission or marketing agency of Canada or of any province in Canada for the purpose of marketing a regulated product. O. Reg. 436/83, s. 3; O. Reg. 118/90, ss. 2, 3.
4. The Commission delegates to the Egg and Chick Commission its powers to make regulations,
- (a) providing for the licensing of any or all persons before commencing or continuing to engage in the producing or marketing of a regulated product;
 - (b) prescribing or providing for classes of licences and the imposition of conditions on any class of licence; and
 - (c) prohibiting persons from engaging in the producing or marketing of a regulated product except under the authority of a licence and except in compliance with the conditions of the licence;
 - (d) providing for the refusal to grant or renew a licence or for the suspension or revocation of a licence,
 - (i) where the applicant or licensee is not qualified by experience, financial responsibility or equipment to properly engage in the business for which the application was made or the licence granted, or
 - (ii) where the applicant or licensee has failed to comply with or has contravened the Act, the regulations, the plan or an order or direction of the Commission, Director or local board or of a marketing agency of Canada;
 - (e) providing for the imposition, amount, disposition and use of penalties where, after a hearing, the local board is of the opinion that the applicant or licensee has failed to comply or has contravened any condition of a licence or the Act or the regulations, the plan or an order or direction of the local board;
 - (f) providing for the fixing of licence fees and their payment by any or all persons producing or marketing a regulated product and the collecting of the licence fees and their recovery by suit in a court of competent jurisdiction;
 - (g) requiring any person who receives a regulated product to deduct from the money payable for the regulated product any licence fees payable to the Egg and Chick Commission by the person from whom the person receives the regulated product, and to forward such licence fees to the Egg and Chick Commission;
 - (h) requiring any person who produces and processes a regulated product to furnish to the Egg and Chick Commission statements of the amounts of the regulated product that the person produced in any year and used for processing;
 - (i) prescribing the form of licences;
 - (j) providing for the exemption from any or all of the regulations, orders or directions under the plan of any class, variety, grade or size of regulated product, or any person or class of persons engaged in the producing or marketing of the regulated product or any class, variety, grade or size of the regulated product;
 - (k) requiring the furnishing of security or proof of financial responsibility by any person engaged in the marketing of a regulated product and providing for the administration and disposition of any money or securities so furnished;
 - (l) providing for the control and regulation of the marketing of a regulated product, including the times and places at which the regulated product may be marketed;
 - (m) providing for the control and regulation of agreements entered into by producers of a regulated product with persons engaged in marketing the regulated product, and the prohibition of any provision or clause in such agreements;
 - (n) requiring any person who produces a regulated product to offer to sell and to sell the regulated product to or through the Egg and Chick Commission;
 - (o) prohibiting any person from packing or packaging a regulated product that has not been sold to, by or through the Egg and Chick Commission;
 - (p) providing for the making of agreements relating to the marketing of a regulated product by or through the Egg and Chick Commission, and prescribing the forms and the terms and conditions of such agreements;
 - (q) providing for the making of such orders and the issuing of such directions as are necessary to enforce the due observance and carrying out of the Act, the regulations, the plan or any order or direction of the Commission or the Egg and Chick Commission. O. Reg. 436/83, s. 4; O. Reg. 118/90, ss. 2, 3, 5.
5. The local board may impose such conditions on a licence as it considers proper. O. Reg. 118/90, s. 6.
- 6.—(1) The Commission authorizes the Egg and Chick Commission to use any class of licence fees, service charges and other money payable to it for the purposes of paying the expenses of the Egg and Chick Commission, carrying out and enforcing the Act and the regulations and carrying out the purposes of the plan. O. Reg. 436/83, s. 5 (1); O. Reg. 118/90, ss. 2, 3.
- (2) The Commission authorizes the Egg and Chick Commission to establish a fund in connection with the plan for the payment of any money that may be required for the purposes mentioned in subsection (1). O. Reg. 436/83, s. 5 (2); O. Reg. 118/90, ss. 2, 3.
- 7.—(1) The Commission vests in the Egg and Chick Commission power,
- (a) to direct and control, by order or direction, either as principal or agent, the marketing of the regulated products,

including the times and places at which the regulated products may be marketed;

- (b) to determine the quality of each class, variety, grade and size of the regulated products that shall be marketed by each producer;
- (c) to prohibit the marketing of any class, variety, grade or size of regulated product;
- (d) to determine from time to time the price or prices that shall be paid to producers or to the Egg and Chick Commission, as the case may be, for a regulated product or any class, variety, grade or size of the regulated product and to determine different prices for different parts of Ontario;
- (e) to fix and impose service charges from time to time for the marketing of a regulated product;
- (f) to purchase or otherwise acquire and to sell or otherwise dispose of a regulated product; and
- (g) to pay from service charges imposed under clause (e) its expenses in carrying out the purposes of the plan. O. Reg. 436/83, s. 6 (1); O. Reg. 118/90, ss. 2, 3.

(2) The Egg and Chick Commission shall not exercise the power vested in it by clause (1) (c) except for just cause. O. Reg. 436/83, s. 6 (2); O. Reg. 118/90, s. 2.

8.—(1) All regulated products shall be marketed by or through the Egg and Chick Commission. O. Reg. 436/83, s. 7 (1); O. Reg. 118/90, s. 2.

(2) No person shall market a regulated product except by or through the Egg and Chick Commission. O. Reg. 436/83, s. 7 (2); O. Reg. 118/90, s. 2.

QUOTAS

9.—(1) The Commission authorizes the Egg and Chick Commission,

- (a) to require that hatching eggs be marketed on a quota basis;
- (b) to prohibit any person to whom a quota has not been fixed and allotted for the marketing of hatching eggs or whose quota has been cancelled from marketing any hatching eggs;
- (c) to prohibit any person to whom a quota has been fixed and allotted for the marketing of hatching eggs from marketing any hatching eggs in excess of such quota; and
- (d) to prohibit any person to whom a quota has been fixed and allotted for the marketing of hatching eggs produced on lands or premises in respect of which such quota was fixed and allotted from marketing any hatching eggs other than hatching eggs produced on such lands or premises. O. Reg. 22/84, s. 1, *part*; O. Reg. 118/90, ss. 2, 3.

(2) The Commission authorizes the Egg and Chick Commission,

- (a) to fix and allot to persons quotas for the marketing of hatching eggs on such basis as the Egg and Chick Commission considers proper;
- (b) to refuse to fix and allot to any person a quota for the marketing of hatching eggs for any reason that the Egg and Chick Commission considers proper;
- (c) to cancel or reduce, or refuse to increase, a quota fixed and allotted to any person for the marketing of hatching eggs for any reason that the Egg and Chick Commission considers proper; and

- (d) to permit any person to whom a quota has been fixed and allotted for the marketing of hatching eggs to market any hatching eggs in excess of such quota on such terms and conditions as the Egg and Chick Commission considers proper. O. Reg. 22/84, s. 1, *part*; O. Reg. 118/90, ss. 2, 3.

(3) The Commission authorizes the Egg and Chick Commission,

- (a) to require that hatching eggs be produced on a quota basis;
- (b) to prohibit any person to whom a quota has not been fixed and allotted for the producing of hatching eggs or whose quota has been cancelled from producing any hatching eggs;
- (c) to prohibit any person to whom a quota has been fixed and allotted for the producing of hatching eggs from producing any hatching eggs in excess of such quota; and
- (d) to prohibit any person to whom a quota has been fixed and allotted for the producing of hatching eggs on lands or premises in respect of which such quota was fixed and allotted from producing any hatching eggs other than hatching eggs produced on such lands or premises. O. Reg. 22/84, s. 1, *part*; O. Reg. 118/90, ss. 2, 3.

(4) The Commission authorizes the Egg and Chick Commission,

- (a) to fix and allot to persons quotas for the producing of hatching eggs on such basis as the Egg and Chick Commission considers proper;
- (b) to refuse to fix and allot to any person a quota for the producing of hatching eggs for any reason that the Egg and Chick Commission considers proper;
- (c) to cancel or reduce, or refuse to increase, a quota fixed and allotted to any person for producing hatching eggs for any reason that the Egg and Chick Commission considers proper, and, without limiting the generality of the foregoing, to cancel or reduce any such quota as a penalty where the Egg and Chick Commission believes on reasonable grounds that the person to whom the quota was fixed and allotted has contravened any provision of the Act or the regulations; and
- (d) to permit any person to whom a quota has been fixed and allotted for the producing of hatching eggs to produce any hatching eggs in excess of such quota on such terms and conditions as the Egg and Chick Commission considers proper. O. Reg. 22/84, s. 1, *part*; O. Reg. 118/90, ss. 2, 3.

10.—(1) The Commission authorizes the Egg and Chick Commission,

- (a) to require that breeder pullets be marketed on a quota basis;
- (b) to prohibit any person to whom a quota has not been fixed and allotted for the marketing of breeder pullets or whose quota has been cancelled from marketing any breeder pullets;
- (c) to prohibit any person to whom a quota has been fixed and allotted for the marketing of breeder pullets from marketing any breeder pullets in excess of such quota; and
- (d) to prohibit any person to whom a quota has been fixed and allotted for the marketing of breeder pullets produced on lands or premises in respect of which such quota was fixed and allotted from marketing any breeder pullets other than breeder pullets produced on such lands or premises. O. Reg. 70/85, s. 2, *part*; O. Reg. 118/90, ss. 2, 3.

(2) The Commission authorizes the Egg and Chick Commission,

- (a) to fix and allot to persons quotas for the marketing of breeder pullets on such basis as the Egg and Chick Commission considers proper;
 - (b) to refuse to fix and allot to any person a quota for the marketing of breeder pullets for any reason that the Egg and Chick Commission considers proper;
 - (c) to cancel or reduce, or refuse to increase, a quota fixed and allotted to any person for the marketing of breeder pullets for any reason that the Egg and Chick Commission considers proper; and
 - (d) to permit any person to whom a quota has been fixed and allotted for the marketing of breeder pullets to market any breeder pullets in excess of such quota on such terms and conditions as the Egg and Chick Commission considers proper. O. Reg. 70/85, s. 2, *part*; O. Reg. 118/90, ss. 2, 3.
- (3) The Commission authorizes the Egg and Chick Commission,
- (a) to require that breeder pullets be produced on a quota basis;
 - (b) to prohibit any person to whom a quota has not been fixed and allotted for the producing of breeder pullets or whose quota has been cancelled from producing any breeder pullets;
 - (c) to prohibit any person to whom a quota has been fixed and allotted for the producing of breeder pullets from producing any breeder pullets in excess of such quota; and
 - (d) to prohibit any person to whom a quota has been fixed and allotted for the producing of breeder pullets on lands or premises in respect of which such quota was fixed and allotted from producing any breeder pullets other than breeder pullets produced on such lands or premises. O. Reg. 70/85, s. 2, *part*; O. Reg. 118/90, ss. 2, 3.
- (4) The Commission authorizes the Egg and Chick Commission,
- (a) to fix and allot to persons quotas for the producing of breeder pullets on such basis as the Egg and Chick Commission considers proper;
 - (b) to refuse to fix and allot to any person a quota for the producing of breeder pullets for any reason that the Egg and Chick Commission considers proper;
 - (c) to cancel or reduce, or refuse to increase, a quota fixed and allotted to any person for producing breeder pullets for any reason that the Egg and Chick Commission considers proper, and, without limiting the generality of the foregoing, to cancel or reduce any such quota as a penalty where the Egg and Chick Commission believes on reasonable grounds that the person to whom the quota was fixed and allotted has contravened the Act or the regulations; and
 - (d) to permit any person to whom a quota has been fixed and allotted for the producing of breeder pullets to produce any breeder pullets in excess of such quota on such terms and conditions as the Egg and Chick Commission considers proper. O. Reg. 70/85, s. 2, *part*; O. Reg. 118/90, ss. 2, 3.

REGULATION 397

BROILER HATCHING EGGS AND CHICKS—PLAN

1. The plan in the Schedule is established for the control and regulation of the producing and marketing within Ontario of breeder chicks, breeder cockerels, breeder hens, breeder pullets, chicks, fowl and hatching eggs. O. Reg. 429/83, s. 1.

2. The local board named in the Schedule is given the powers set out in subsection 15 (1), paragraphs 1, 2, 3, 4, 5, 6, 7, 8, 10, 11, 12, 13, 14, 15, 16, 17, 18, 19 and 26 of subsection 15 (2) and sections 50 and 110 of the *Co-operative Corporations Act*. O. Reg. 429/83, s. 2.

3. The members of the local board shall be deemed to be the shareholders and directors thereof in the exercise of any of the powers mentioned in section 2. O. Reg. 429/83, s. 3.

Schedule

Farm Products Marketing Act

PLAN

1. This plan may be cited as the "Ontario Broiler Hatching Egg and Chick Marketing Plan".

2. In this plan,

"breeder chick" means a chick other than a chick not intended to be used for producing hatching eggs;

"breeder cockerel" means a cockerel other than a cockerel not used for breeding purposes for hatching eggs;

"breeder hen" means a hen other than a hen not used for producing hatching eggs;

"breeder pullet" means a pullet that is less than twenty-four weeks of age other than a pullet not intended to be used for producing hatching eggs;

"chick" means a chick other than a chick not intended to be grown into a chicken as defined in Regulation 403 of Revised Regulations of Ontario, 1990;

"Egg and Chick Commission" means the Ontario Broiler Hatching Egg and Chick Commission established under section 4;

"fowl" means a breeder hen or breeder cockerel that is twenty-four weeks of age or older;

"hatching egg" means an egg other than an egg not intended to be hatched as a chick.

3. This plan provides for the control and regulation in any or all respects of the producing and marketing within Ontario of breeder chicks, breeder cockerels, breeder hens, breeder pullets, chicks, fowl and hatching eggs, including the prohibition of such producing and marketing in whole or in part.

4. There shall be a local board to be known as the "Ontario Broiler Hatching Egg and Chick Commission".

5. The Egg and Chick Commission shall be composed of nine members.

6. Members of the Egg and Chick Commission shall be appointed in accordance with this plan for a term of one year.

7. Members of the Egg and Chick Commission hold office until their successors are appointed.

8.—(1) On or before the 31st day of March in each year, the Ontario Broiler Chicken Hatching Egg Producers' Association shall appoint four persons to be members of the Egg and Chick Commission.

(2) No person is eligible to be appointed under subsection (1) unless the person holds a licence as a producer of hatching eggs or is a licence holder's officer or employee.

9.—(1) On or before the 31st day of March in each year, the

Ontario Hatcheries Association shall appoint four persons to be members of the Egg and Chick Commission.

(2) No person is eligible to be appointed under subsection (1) unless the person holds a licence to operate a hatchery or is a licence holder's officer or employee.

10.—(1) A person appointed under section 8 or 9 takes office on the 1st day of April next following the appointment.

(2) Where a person appointed under section 8 or 9 dies, resigns or becomes unavailable to act before his or her term has expired, the association that appointed him or her may appoint a person to fill the vacancy for the unexpired term and subsection 8 (2) or 9 (2), as the case may be, applies.

11.—(1) At its first meeting after the 1st day of April, in each year, the Egg and Chick Commission shall appoint a person to be the ninth member and chair of the Egg and Chick Commission.

(2) The members of the Egg and Chick Commission may elect from among themselves one or more vice-chairs.

(3) Where the chair of the Egg and Chick Commission dies, resigns or becomes unavailable to act before his or her term has expired, the Egg and Chick Commission may appoint a person to fill the vacancy for the unexpired term.

12.—(1) Where an association fails to appoint a person under section 8 or 9 or to make an appointment under subsection 10 (2) within two weeks of the time the right to appoint arises, the Egg and Chick Commission may make the appointment and subsection 8 (2) or 9 (2), as the case may be, applies.

(2) Where the Egg and Chick Commission fails to make an appointment under section 11 within two weeks of the time its right to appoint arises, the Commission may make the appointment. O. Reg. 429/83, Sched.; O. Reg. 98/90, ss. 2, 3.

REGULATION 398

BURLEY TOBACCO—MARKETING

1. In this Regulation,

“burley tobacco” means unmanufactured burley tobacco produced in Ontario;

“local board” means The Ontario Burley Tobacco Growers' Marketing Board;

“plan” means The Ontario Burley Tobacco Growers' Marketing Plan;

“producer” means a person engaged in the production of burley tobacco in Ontario. R.R.O. 1980, Reg. 352, s. 1.

2. This Regulation provides for the control and regulation in any or all respects of the producing and marketing within Ontario of burley tobacco, including the prohibition of such producing and marketing in whole or in part. O. Reg. 506/85, s. 4 (1).

3. The Commission delegates to the local board the power,

(a) to require persons engaged in producing or marketing burley tobacco to register their names, addresses and occupations with the local board;

(b) to require persons engaged in producing or marketing burley tobacco to furnish such information relating to the production or marketing of burley tobacco, including the completing and filing of returns, as the local board determines;

(c) to appoint persons to inspect the books, records, documents, lands and premises and any burley tobacco of persons engaged in producing or marketing burley tobacco;

(d) to stimulate, increase and improve the marketing of burley tobacco by such means as it considers proper;

(e) to co-operate with a marketing board, local board, marketing commission or marketing agency of Canada or of any province in Canada for the purpose of marketing burley tobacco;

(f) to do such acts and make such orders and issue such directions as are necessary to enforce the due observance and carrying out of the Act, the regulations or the plan. R.R.O. 1980, Reg. 352, s. 3; O. Reg. 758/88, s. 1.

4. The Commission delegates to the local board its powers to make regulations with respect to burley tobacco,

(a) providing for the licensing of any or all persons before commencing or continuing to engage in the producing or marketing of burley tobacco;

(b) prohibiting persons from engaging in the producing or marketing of burley tobacco except under the authority of a licence;

(c) providing for the refusal to grant a licence where the applicant is not qualified by experience, financial responsibility and equipment to engage in properly the business for which the application was made, or for any other reason that the local board considers proper;

(d) providing for the suspension or revocation of, or the refusal to renew, a licence for failure to observe, perform or carry out the Act, the regulations, the plan or any order or direction of the local board;

(e) providing for the fixing of licence fees payable yearly, half-yearly, quarterly or monthly at different amounts or in instalments from any or all persons producing or marketing burley tobacco and the recovering of such licence fees by suit in a court of competent jurisdiction;

(f) requiring any person who produces and processes burley tobacco to furnish to the local board statements of the amounts of burley tobacco produced by the person in any year and used for processing;

(g) prescribing the form of licences;

(h) providing for the exemption from any or all of the regulations, orders or directions under the plan of any class, variety or grade of burley tobacco;

(i) requiring the furnishing of security or proof of financial responsibility by any person engaged in the marketing of burley tobacco and providing for the administration and disposition of any money or securities so furnished;

(j) providing for the control and regulation of the marketing of burley tobacco, including the times and places at which burley tobacco may be marketed;

(k) providing for the control and regulation of agreements entered into by producers of burley tobacco with persons engaged in marketing or processing burley tobacco and the prohibition of any provision or clause in such agreements;

(l) requiring any person who produces burley tobacco to offer to sell and to sell burley tobacco through the local board;

(m) prohibiting any person from processing, packing or packag-

ing any burley tobacco that has not been sold through the local board;

- (n) providing for the making of agreements relating to the marketing of burley tobacco through the local board and prescribing the forms and the terms and conditions of such agreements. R.R.O. 1980, Reg. 352, s. 4; O. Reg. 506/85, s. 4 (2); O. Reg. 758/88, s. 1.

5.—(1) The Commission authorizes the local board,

- (a) to require that burley tobacco be marketed on a quota basis;
- (b) to prohibit any person to whom a quota has not been fixed and allotted for the marketing of burley tobacco or whose quota has been cancelled from marketing any burley tobacco;
- (c) to prohibit any person to whom a quota has been fixed and allotted for the marketing of burley tobacco from marketing any burley tobacco in excess of such quota;
- (d) to prohibit any person to whom a quota has been fixed and allotted for the marketing of burley tobacco produced on lands or premises in respect of which such quota was fixed and allotted from marketing any burley tobacco other than the burley tobacco produced on such lands and premises. R.R.O. 1980, Reg. 352, s. 5 (1); O. Reg. 758/88, s. 1.

(2) The Commission authorizes the local board,

- (a) to fix and allot to persons quotas for the marketing of burley tobacco on such basis as the local board considers proper;
- (b) to refuse to fix and allot to any person a quota for the marketing of burley tobacco for any reason that the local board considers proper; and
- (c) to cancel or reduce, or refuse to increase, a quota fixed and allotted to any person for the marketing of burley tobacco for any reason that the local board considers proper. R.R.O. 1980, Reg. 352, s. 5 (2); O. Reg. 758/88, s. 1.

6.—(1) The Commission authorizes the local board to use any class of licence fees, service charges and other money payable to it for the purposes of paying the expenses of the local board, carrying out and enforcing the Act and the regulations and carrying out the purposes of the plan. R.R.O. 1980, Reg. 352, s. 6 (1); O. Reg. 758/88, s. 1.

(2) The Commission authorizes the local board to establish a fund in connection with the plan for the payment of any money that may be required for the purposes mentioned in subsection (1). R.R.O. 1980, Reg. 352, s. 6 (2); O. Reg. 758/88, s. 1.

7. The Commission authorizes the local board to conduct a pool or pools for the distribution of all money received from the sale of burley tobacco and, after deducting all necessary and proper disbursements and expenses, to distribute the remainder of the money received from the sale in such manner that every producer receives a share of the remainder of the money received from the sale in relation to the amount, class, variety or grade of burley tobacco delivered, and authorizes the local board to make an initial payment on delivery of the burley tobacco and subsequent payments until all of the remainder of the money received from the sale is distributed to the producers. R.R.O. 1980, Reg. 352, s. 7; O. Reg. 758/88, s. 1.

8. The Commission authorizes the local board to require the price or prices payable or owing to the producers for burley tobacco to be paid to or through the local board and to recover such price or prices by suit in a court of competent jurisdiction. R.R.O. 1980, Reg. 352, s. 8; O. Reg. 758/88, s. 1.

9. The Commission authorizes the local board to prohibit the marketing of any class, variety or grade of burley tobacco. R.R.O. 1980, Reg. 352, s. 9; O. Reg. 758/88, s. 1.

10. The Commission authorizes the local board to appoint agents, to prescribe their duties and terms and conditions of employment and to provide for their remuneration. R.R.O. 1980, Reg. 352, s. 10; O. Reg. 758/88, s. 1.

11.—(1) There shall be a negotiating agency to be known as the "Negotiating Committee for Burley Tobacco" composed of the persons who are appointed members of the negotiating agency under subsection (2).

(2) The Negotiating Committee for Burley Tobacco shall be comprised of,

- (a) not more than four members appointed by the buyers of burley tobacco; and
- (b) not more than four members appointed by the local board. R.R.O. 1980, Reg. 352, s. 11 (1,2).

(3) The persons entitled to appoint members under subsection (2) shall appoint the members and shall notify the Commission of the members' names and addresses prior to the 1st day of December in each year. R.R.O. 1980, Reg. 352, s. 11 (3); O. Reg. 758/88, ss. 1, 2 (1).

(4) The persons who are members of the Negotiating Committee for Burley Tobacco under subsection (2) remain members thereof until their successors become members.

(5) Where a member of the Negotiating Committee for Burley Tobacco appointed under subsection (2), dies or resigns or is unavailable to act prior to the expiration of his or her membership, the person who appointed him or her shall appoint a person for the unexpired term of such member. R.R.O. 1980, Reg. 352, s. 11 (5, 6).

12. The Negotiating Committee for Burley Tobacco is empowered to adopt or settle by agreement,

- (a) minimum prices for burley tobacco or any class, variety or grade of burley tobacco;
- (b) terms, conditions and forms of agreements relating to the producing or marketing of burley tobacco; and
- (c) any charges, costs or expenses relating to the production or marketing of burley tobacco. R.R.O. 1980, Reg. 352, s. 12.

13. A meeting of the Negotiating Committee for Burley Tobacco may be convened by a notice in writing given by the members appointed under clause 11 (2) (a) or appointed under clause 11 (2) (b) to the other members, at least seven days but not later than ten days, before the date of the meeting, stating the time and place of the meeting. R.R.O. 1980, Reg. 352, s. 13.

14.—(1) Where a meeting of the Negotiating Committee for Burley Tobacco is held and the negotiating agency does not arrive at an agreement respecting all matters that it is empowered to adopt or settle by agreement, and where not less than two-thirds of the members of the negotiating agency vote in favour thereof, the negotiating agency may refer the matters in dispute to a conciliation board. R.R.O. 1980, Reg. 352, s. 14 (1).

(2) Where the Negotiating Committee for Burley Tobacco refers matters in dispute to a conciliation board, it shall so notify the Commission. R.R.O. 1980, Reg. 352, s. 14 (2); O. Reg. 758/88, s. 1.

15.—(1) The conciliation board shall be composed of three members of whom,

- (a) one member shall be appointed by the persons appointed under clause 11 (2) (a);
 - (b) one member shall be appointed by the persons appointed under clause 11 (2) (b); and
 - (c) one member shall be appointed by the Commission. R.R.O. 1980, Reg. 352, s. 15 (1); O. Reg. 758/88, s. 1.
- (2) The members of the conciliation board shall be appointed within one week of the time that notice was given under subsection 14 (2).
- (3) The conciliation board is empowered,
- (a) to endeavour to effect agreement on any matter referred to in section 12 that the negotiating agency has failed to adopt or settle by agreement; and
 - (b) to recommend adoption of any agreement effected under clause (a) to the negotiating agency.
- (4) The recommendation of the conciliation board made under clause 3 (b) may include a minority report disagreeing in whole or in part with the recommendation of the majority of the conciliation board.
- (5) The conciliation board shall submit its recommendations to the Negotiating Committee for Burley Tobacco within two weeks of the time that notice was given under subsection 14 (2). R.R.O. 1980, Reg. 352, s. 15 (2-5).

REGULATION 399

BURLEY TOBACCO—PLAN

1. The plan in the Schedule is continued for the control and regulation of the producing and marketing within Ontario of burley tobacco. O. Reg. 259/85, s. 1.
2. The local board named in the Schedule is given the powers set out in subsection 15 (1), in paragraphs 1, 2, 3, 4, 5, 6, 7, 8, 10, 11, 12, 13, 14, 15, 16, 17, 18, 19 and 26 of subsection 15 (2) and in sections 50 and 110 of the *Co-operative Corporations Act*. R.R.O. 1980, Reg. 351, s. 2.
3. The members of the local board shall be deemed to be the shareholders and the directors thereof in the exercise of any of the powers mentioned in section 2. R.R.O. 1980, Reg. 351, s. 3.

Schedule

Farm Products Marketing Act

PLAN

1. This plan may be cited as “The Ontario Burley Tobacco Growers’ Marketing Plan”.
2. In this plan,
- “burley tobacco” means unmanufactured burley tobacco produced in Ontario;
- “producer” means a person engaged in the production of burley tobacco in Ontario.
3. This plan applies to the control and regulation in any or all respects of the producing and marketing within Ontario of burley tobacco, including the prohibition of such producing and marketing in whole or in part.

4. There shall be a local board to be known as “The Ontario Burley Tobacco Growers’ Marketing Board”.
5. The local board shall be composed of four members elected or appointed in accordance with this plan.
6. Producers are divided into two districts as follows:
- 1. District 1, comprising the County of Essex.
 - 2. District 2, comprising the Province of Ontario, other than the County of Essex.
7. An annual meeting of producers shall be held on the third Tuesday in November in each year.
- 8.—(1) The producers in each district shall elect, from the producers in the district, members to the local board as follows:
- 1. District 1, one member.
 - 2. District 2, three members.
- (2) No person is eligible for election or appointment from any district to the local board unless,
- (a) the person resides within the district;
 - (b) a quota is fixed and allotted to the person; and
 - (c) he or she is an active producer.
- (3) Where a producer is a corporation or partnership, the person eligible to vote, nominate for election or be elected shall be the person, if any, designated in writing by the corporation or partnership for that purpose.
- (4) The local board shall appoint a returning officer and such other persons as are required to assist in the nomination and voting and shall furnish ballots as are required.
- 9.—(1) On the third Tuesday in November in 1989, 1990 and in every second year thereafter, the producers in District 1 shall hold a meeting to nominate and elect a member to the local board.
- (2) On the third Tuesday in November in 1989 and in every second year thereafter, the producers in District 2 shall hold a meeting to nominate and elect three members to the local board.
- (3) Any producer residing in the district may nominate one or more eligible persons for election as members of the local board.
- (4) The returning officer, on being satisfied that nominations under subsection (3) are complete, shall so declare and, after giving each of the persons nominated an opportunity to decline the nomination, shall, where not more than one person is nominated for District 1 or not more than three persons are nominated for District 2, declare such person or persons elected.

- 10.—(1) The local board shall give producers at least seven days prior written notice of the day, time and place of the nomination and election.
- (2) A producer is not eligible to vote unless a quota is fixed and allotted to the producer.
- (3) No individual is entitled to cast more than one ballot in any election.
- 11.—(1) Voting shall be by secret ballot.

- (2) Where the greatest number of votes for membership in the local board in District 1 or the third greatest number of votes for membership in the local board in District 2 are received by more

than one person, the local board shall hold such further elections as are necessary to break the tie.

12.—(1) The term of office of each member of the local board commences on the 1st day of December in the year in which the member is elected or appointed.

(2) Where a member elected or appointed to the local board dies, resigns, is unable or unwilling to act or ceases to be eligible for election or appointment before the expiration of his or her term of membership, the other members of the local board may appoint a person to replace that member for the unexpired term. R.R.O. 1980, Reg. 351, Sched.; O. Reg. 259/85, ss. 2-6; O. Reg. 31/89, s. 1.

REGULATION 400

BY-LAWS FOR LOCAL BOARDS

1. The head office of a local board shall be in such place in Ontario as the local board from time to time determines by by-law. R.R.O. 1980, Reg. 353, s. 1.

2. The fiscal year of a local board shall commence on the 1st day of April in each year but the local board may, by by-law, specify another date. R.R.O. 1980, Reg. 353, s. 2.

3. The local board, after every general election or appointment of its members, shall by by-law specify the period of time within which its first meeting shall be held. R.R.O. 1980, Reg. 353, s. 3.

4. In this Regulation,

“secretary” means an officer appointed to perform the functions of a secretary; and

“treasurer” means an officer appointed to perform the functions of a treasurer. O. Reg. 283/85, s. 1, *revised*.

OFFICERS

5.—(1) A local board shall, at the first meeting after every general election or appointment of its members, elect from its members a chair and a vice-chair.

(2) The chair shall, when present, preside at all meetings of the local board.

(3) During the absence of the chair or his or her inability to act, the chair’s duties may be performed by the vice-chair.

(4) Where the chair and vice-chair are absent from a meeting, the local board may elect a chair for the purpose of that meeting from among the members present at the meeting.

(5) The chair and vice-chair of a local board shall hold office until their successors are elected. R.R.O. 1980, Reg. 353, s. 4.

6. A majority of the members of a local board constitute a quorum for the transaction of business. R.R.O. 1980, Reg. 353, s. 5.

7.—(1) A local board shall appoint a secretary and a treasurer.

(2) The same person may be appointed secretary and treasurer.

(3) A local board may appoint such officers and employees as it considers necessary.

(4) Subject to subsection 5 (1), no local board shall appoint a member of the local board as an officer or employee thereof. R.R.O. 1980, Reg. 353, s. 6.

8. The secretary of a local board shall,

(a) attend all meetings of the local board and keep true minutes thereof and shall send a copy of the minutes to every member of the local board within ten days, excluding Saturdays and holidays, after the meeting;

(b) conduct the correspondence of the local board;

(c) keep a record of,

(i) all business transactions of the local board,

(ii) all orders, directions or determinations of the local board,

(iii) all reports of committees that are from time to time appointed by the local board, and

(iv) all annual statements and financial auditor’s reports;

(d) maintain at the head office of the local board true copies of all regulations, orders and policy statements of the local board and an index identifying all regulations, including amendments, by subject-matter, and shall during the normal business hours of the local board,

(i) permit any person to inspect the copies and index without charge, and

(ii) provide to any person upon request copies of the regulations, orders and policy statements; and

(e) perform such other duties as may be prescribed from time to time by the local board. R.R.O. 1980, Reg. 353, s. 7; O. Reg. 283/85, s. 2.

9. The treasurer of a local board shall,

(a) under the direction of the local board, provide for the deposit of money, the safekeeping of securities and the disbursement of the funds of the local board;

(b) maintain separate accounts for the deposit of,

(i) money received by the local board in trust for any other person, and

(ii) levies or charges imposed by the local board pursuant to powers exercised under authority granted under the *Agricultural Products Marketing Act* (Canada);

(c) keep full and accurate books of account in which shall be recorded all receipts and disbursements of the local board;

(d) prepare reports showing the financial position of the local board as the local board may direct from time to time; and

(e) perform such other duties as may be prescribed from time to time by the local board. R.R.O. 1980, Reg. 353, s. 8.

10.—(1) Any of the powers and duties of an officer to whom an assistant has been appointed by the local board may be exercised and performed by the assistant.

(2) A local board may add to or limit the powers and duties of an officer or his or her assistant. R.R.O. 1980, Reg. 353, s. 9.

MEETINGS OF LOCAL BOARDS

11.—(1) Meetings of a local board shall be held from time to time at such place, at such time and on such day as the chair or vice-chair or any two members of the local board may determine and the secretary, when directed or authorized by either of the said officers or by any two members of the local board, shall give or cause to be given notice of the meeting.

(2) Unless otherwise stated in the notice calling the meeting, meetings of the local board shall be held at the head office. R.R.O. 1980, Reg. 353, s. 10 (1, 2).

(3) Notice of a meeting shall,

- (a) include the date and time of the meeting; and
- (b) be given,
 - (i) in writing by mail or electronic transmission, or
 - (ii) orally or by telephone. R.R.O. 1980, Reg. 353, s. 10 (3); O. Reg. 350/90, s. 1 (1).

(4) Notice of a meeting shall be given such period or periods of time in advance of the meeting as the local board provides by by-law.

(5) No notice of a meeting is required to be given, where, in addition to the members of the local board present, those absent waive notice of the meeting either before or after the meeting. R.R.O. 1980, Reg. 353, s. 10 (4, 5).

(6) Notice in writing by mail or by electronic transmission shall be sufficiently given if mailed or transmitted to a member at his or her last address as recorded in the books of the local board. O. Reg. 350/90, s. 1 (2).

12. All questions arising at a meeting of a local board shall be decided by the majority of the votes of the members present and in the event of a tie vote the chair of the meeting shall have the deciding vote. R.R.O. 1980, Reg. 353, s. 11.

TRANSACTION OF BUSINESS OTHER THAN AT A MEETING

13.—(1) A local board may transact business matters other than at a meeting called and conducted in accordance with sections 11 and 12 upon condition that,

- (a) the chair of the local board is of the opinion that the matter of business should be decided sooner than a meeting can be called;
- (b) the chair submits the matter to be decided to the secretary of the local board;
- (c) the chair or the secretary submits the matter for decision to at least two-thirds of the members of the local board,
 - (i) by mail or electronic transmission,
 - (ii) by telephone, or
 - (iii) orally; and
- (d) the secretary makes a record in the minute book of the local board of the matter to be decided and the decision of each member. R.R.O. 1980, Reg. 353, s. 12 (1); O. Reg. 283/85, s. 3; O. Reg. 350/90, s. 2.

(2) Where the conditions prescribed in subsection (1) have been complied with and the record shows a majority of members in favour of, or against, the matter of business, it shall be decided accordingly.

(3) Where the secretary of a local board makes a record in the minute book under subsection (1), the record shall be read and confirmed at the next meeting of the local board. R.R.O. 1980, Reg. 353, s. 12 (2, 3).

FINANCES

14.—(1) A by-law passed by a local board,

- (a) for borrowing money on the credit of the local board;

- (b) for issuing, selling or pledging securities of the local board;
- (c) for charging, mortgaging, hypothecating or pledging all or any of the real or personal property of the local board, including book debts and unpaid calls, rights, powers, franchises and undertakings; or
- (d) to negotiate for any securities or any money borrowed, or other debt, or any other obligation or liability of the local board,

shall state the purpose or purposes for which the money, credit, debt or liability are to be used.

(2) No by-law referred to in subsection (1) is effective unless it is passed at a meeting of the members of the local board called for the purpose of considering the by-law and not less than two-thirds of the members are present and vote in favour thereof. R.R.O. 1980, Reg. 353, s. 13.

15.—(1) A local board shall require the treasurer to furnish a bond for the faithful discharge of his or her duties in such form and with such security as the local board may from time to time prescribe.

(2) A local board may require such other officers and such employees and agents as the local board considers advisable to furnish bonds for the faithful discharge of their duties in such form and with such security as the local board may from time to time prescribe.

(3) A local board shall pay the cost of any bond required under subsection (1) or (2). R.R.O. 1980, Reg. 353, s. 14.

16.—(1) Subject to section 9, no local board shall invest any surplus funds of the local board other than in,

- (a) those classes of securities in which a trustee may invest money in under section 26 of the *Trustee Act*, other than first mortgages, charges or hypothecs upon real estate in Canada;
- (b) investment certificates of a chartered bank; and
- (c) paid up shares of,
 - (i) any credit union league to which the *Credit Unions and Caisses Populaires Act* applies, and
 - (ii) The Ontario Co-operative Credit Society. R.R.O. 1980, Reg. 353, s. 15.

(2) A local board may lend money to a fund established under the *Farm Products Payments Act*. O. Reg. 283/85, s. 4.

17.—(1) A local board shall cause its accounts to be audited annually by one or more auditors within three months after the end of the fiscal year of the local board.

(2) The auditor shall make a report to the local board based on the accounts examined by him or her and on every balance sheet laid before the local board at a general meeting and in the report shall state whether, in the auditor's opinion, the balance sheet referred to in the report is properly drawn up so as to exhibit a true and correct view of the state of the local board's affairs as shown by its books and the treasurer's financial statement.

(3) The secretary of the local board shall file the report of the auditor. R.R.O. 1980, Reg. 353, s. 16.

SEAL

18.—(1) A local board shall have a corporate seal.

(2) The seal shall be in the form of two concentric circles with the name of the local board inserted in the space between the two circles.

(3) The secretary shall have custody of the seal. R.R.O. 1980, Reg. 353, s. 17.

MEETING OF PRODUCERS

19.—(1) A local board shall call,

- (a) an annual meeting of the producers under the plan; or
- (b) annual area meetings of the producers under the plan in each area and an annual meeting of delegates from all annual area meetings.

(2) Where the local board calls annual area meetings under clause (1) (b), the local board may determine the boundaries of every area for the purposes of the annual area meetings and the method of electing or appointing delegates from the annual area meetings to the annual meeting of delegates.

(3) Where the local board calls annual area meetings under clause (1) (b), the local board shall include every part of Ontario to which the plan applies in areas for which annual area meetings are called.

(4) The annual meeting referred to in clause (1) (a) or the annual area meetings and annual meeting of delegates referred to in clause (1) (b), as the case may be, shall be held at such time and at such place, in every year, as the local board determines.

(5) At every annual meeting referred to in clause (1) (a) and at every annual meeting of delegates referred to in clause (1) (b), the local board shall present, at the meeting, the auditor's report referred to in subsection 17 (2) and shall announce the appointment of auditors for the next succeeding annual meeting. R.R.O. 1980, Reg. 353, s. 18.

20.—(1) Where a local board receives a petition or request from at least ten per cent of the producers under the plan requesting that a special meeting of the producers be held for discussion of matters respecting the operation of the plan or of the local board, the local board shall call a special meeting of the producers within thirty days of receipt of the petition or request.

(2) A petition or request shall contain or be accompanied by a statement of the matters for discussion at the special meeting. R.R.O. 1980, Reg. 353, s. 19.

21.—(1) A meeting referred to in section 19 or 20 may be called,

- (a) by giving notice thereof to each producer or delegate who is entitled to attend; or
- (b) by publication of a notice in at least one newspaper or magazine having a general circulation among the producers.

(2) Notice of a meeting referred to in section 19 shall be given or published at least two weeks before the date of the meeting. R.R.O. 1980, Reg. 353, s. 20.

22.—(1) Every member or officer of a local board and his or her heirs, executors or administrators, and estate and effects respectively shall, from time to time and at all times, be indemnified and saved harmless out of the money of the local board, from and against any action, suit or proceeding that is brought, commenced or prosecuted against the member or officer in respect of any matter to which subsection 3 (6) of the Act applies.

(2) Where any member or officer of a local board or his or her heirs, executors or administrators or estate and effects receives any money from any person on account of any matter with respect to which the member or officer has already received money from the local board under subsection (1), the member or officer shall forth-

with pay to the local board the amount of money that he or she received respecting that matter from the local board or the amount of money that he or she received respecting that matter from the other person, whichever is the lesser amount. R.R.O. 1980, Reg. 353, s. 21.

REGULATION 401

CHICKEN—EXTENSION OF POWERS OF THE CANADIAN CHICKEN MARKETING AGENCY

1. In this Regulation, "chicken" means chicken and parts thereof produced in Ontario. R.R.O. 1980, Reg. 354, s. 1, *revised*.

2. The Lieutenant Governor in Council hereby grants authority to the Canadian Chicken Marketing Agency to regulate the marketing within Ontario of chicken in the manner set out in section 3. R.R.O. 1980, Reg. 354, s. 2, *revised*.

3. For the purpose of regulating the marketing within Ontario of chicken, the Canadian Chicken Marketing Agency may exercise, with respect to chicken so marketed, the powers that it may exercise with respect to chicken marketed in interprovincial or export trade under paragraph 22 (1) (a) of the *Farm Products Marketing Agencies Act* (Canada). R.R.O. 1980, Reg. 354, s. 3, *revised*.

REGULATION 402

CHICKENS—MARKETING

1. In this Regulation,

"chicken" means a chicken or any class or part thereof produced from the egg of a domestic hen;

"local board" means The Ontario Chicken Producers' Marketing Board;

"plan" means The Ontario Chicken Producers' Marketing Plan;

"processor" means a person who slaughters chickens, and "processing" has a corresponding meaning;

"producer" means a person engaged in the production of chickens. O. Reg. 737/84, s. 1.

2. This Regulation provides for the control and regulation in any or all respects of the producing and marketing within Ontario of chickens, including the prohibition of such producing and marketing in whole or in part. O. Reg. 737/84, s. 2.

3. The Commission exempts from this Regulation a chicken where the live chicken is more than six months of age. O. Reg. 737/84, s. 3.

POWERS OF LOCAL BOARD

4. The Commission delegates to the local board the power,

(a) to require persons engaged in producing or marketing chickens to register their names, addresses and occupations with the local board;

(b) to require persons engaged in producing or marketing chickens to furnish such information relating to the production or marketing of chickens, including the completing and filing of returns, as the local board determines;

(c) to appoint persons to,

- (i) inspect the books, records, documents, lands and premises and any chickens of persons engaged in producing or marketing chickens, and
- (ii) enter on lands or premises used for the producing of chickens and perform a count of chickens;
- (d) to stimulate, increase and improve the marketing of chickens by such means as it considers proper;
- (e) to co-operate with a marketing board, local board, marketing commission or marketing agency of Canada or of any province in Canada for the purpose of marketing chickens;
- (f) to do such acts and make such orders and issue such directions as are necessary to enforce the due observance and carrying out of the Act, the regulations and the plan. O. Reg. 737/84, s. 4.
5. The Commission delegates to the local board its powers to make regulations with respect to chickens,
- (a) providing for the licensing of any or all persons before commencing or continuing to engage in the producing, marketing or processing of chickens;
- (b) prohibiting persons from engaging in the producing, marketing or processing of chickens except under the authority of a licence;
- (c) providing for the refusal to grant a licence where the applicant is not qualified by experience, financial responsibility and equipment to engage in properly the business for which the application as made, or for any other reason that the local board considers proper;
- (d) providing for the suspension or revocation of, or the refusal to renew, a licence for failure to observe, perform or carry out the Act, the regulations, the plan or any order or direction of the Commission or local board;
- (e) prescribing the form of licences;
- (f) subject to section 3, providing for the exemption from any or all of the regulations, orders or directions under the plan of any class, variety, grade or size of chickens, or any person or class of persons engaged in the producing or marketing of chickens or any class, variety, grade or size of chickens;
- (g) providing for the fixing of licence fees payable yearly, half-yearly, quarterly or monthly at different amounts or in instalments from any or all persons producing or marketing chickens and the collecting of the licence fees and the recovering of such licence fees by suit in a court of competent jurisdiction;
- (h) requiring any person who receives chickens to deduct from the money payable for the chickens any licence fees payable to the local board by the person from whom he, she or it receives the chickens, and to forward such licence fees to the local board;
- (i) requiring the furnishing of security or proof of financial responsibility by any person engaged in the marketing of chickens and providing for the administration and disposition of any money or securities so furnished;
- (j) providing for the control and regulation of the marketing of chickens, including the times and places at which chickens may be marketed;
- (k) providing for the control and regulation of agreements entered into by producers of chickens with persons engaged in marketing or processing chickens, and the prohibition of any provision or clause in such agreements;
- (l) requiring any person who produces chickens to offer to sell and to sell the chickens through the local board;
- (m) prohibiting any person from processing, packing or packaging any chickens that have not been sold by or through the local board;
- (n) providing for the making of agreements relating to the marketing of chickens by or through the local board, and prescribing the terms and conditions of such agreements; and
- (o) providing for the making of such orders and the issuing of such directions as are necessary to enforce the due observance and carrying out of the Act, the regulations, the plan or any order or direction of the local board. O. Reg. 737/84, s. 5.
- 6.—(1) All chickens shall be marketed through the local board.
- (2) No person shall market chickens except through the local board. O. Reg. 737/84, s. 6.
7. The Commission vests in the local board the following powers:
1. To direct and control by order or direction, either as principal or agent, the marketing of chickens, including the times and places at which chickens may be marketed.
 2. To prohibit the marketing of any class, variety, grade or size of chickens.
 3. To determine from time to time the price or prices that shall be paid to producers or to the local board, as the case may be, for chickens or any class, variety, grade or size of chickens and to determine different prices for different parts of Ontario.
 4. To fix and impose service charges from time to time for the marketing of chickens.
 5. To purchase or otherwise acquire such quantity or quantities of chickens as the local board considers advisable and to sell or otherwise dispose of any chickens so purchased or acquired. O. Reg. 737/84, s. 7.
- 8.—(1) Any person who produces and processes chickens shall, not later than the 31st day of January in any year, furnish to the local board a statement of the amount of chicken produced and used for processing in the preceding year.
- (2) Any person who produces and processes chickens shall pay licence fees monthly to the local board in the same amounts as are prescribed by the local board under clause 5 (g) for every kilogram of chicken produced and processed.
- (3) Any person who produces and processes chickens shall forward to the local board the licence fees payable in any month not later than the 15th day of the following month. O. Reg. 737/84, s. 8.
9. The local board may recover from any person by suit in a court of competent jurisdiction any licence fees payable to the local board. O. Reg. 737/84, s. 9.
- QUOTAS
- 10.—(1) The Commission authorizes the local board,
- (a) to require that chickens be marketed on a quota basis;
 - (b) to prohibit any person to whom a quota has not been fixed

and allotted for the marketing of chickens or whose quota has been cancelled from marketing any chickens;

- (c) to prohibit any person to whom a quota has been fixed and allotted for the marketing of chickens from marketing any chickens in excess of such quota; and
- (d) to prohibit any person to whom a quota has been fixed and allotted for the marketing of chickens produced on lands or premises in respect of which such quota has fixed and allotted from marketing any chickens other than chickens produced on such lands or premises.

(2) The Commission authorizes the local board,

- (a) to fix and allot to persons quotas for the marketing of chickens on such basis as the local board considers proper;
- (b) to refuse to fix and allot to any person a quota for the marketing of chickens for any reason that the local board considers proper; and
- (c) to cancel or reduce, or refuse to increase, a quota fixed and allotted to any person for the marketing of chickens for any reason that the local board considers proper. O. Reg. 737/84, s. 10.

11.—(1) The Commission authorizes the local board,

- (a) to require that chickens be produced on a quota basis;
- (b) to prohibit any person to whom a quota has not been fixed and allotted for the producing of chickens or whose quota has been cancelled from producing any chickens;
- (c) to prohibit any person to whom a quota has been fixed and allotted for the production of chickens from producing any chickens in excess of such quota; and
- (d) to prohibit any person to whom a quota has been fixed and allotted for the producing of chickens on lands or premises in respect of which such quota was fixed and allotted from producing any chickens other than chickens produced on such lands and premises.

(2) The Commission authorizes the local board,

- (a) to fix and allot to persons quotas for the producing of chickens on such basis as the local board considers proper;
- (b) to refuse to fix and allot to any person a quota for the producing of chickens for any reason that the local board considers proper;
- (c) to cancel or reduce, or refuse to increase, a quota fixed and allotted to any person for producing chickens for any reason that the local board considers proper, and without limiting the generality of the foregoing, to cancel or reduce any such quota as a penalty where the local board believes on reasonable grounds that the person to whom the quota was fixed and allotted has contravened the Act or the regulations; and
- (d) to permit any person to whom a quota has been fixed and allotted for the producing of chickens to produce any chickens in excess of such quota on such terms and conditions as the local board considers proper. O. Reg. 737/84, s. 11.

12.—(1) The Commission authorizes the local board to use any class of licence fees, service charges and other money payable to it, for the purpose of paying the expenses of the local board, carrying out and enforcing the Act and the regulations and carrying out the purposes of the plan.

(2) The Commission authorizes the local board to establish a

fund in connection with the plan for the payment of any money that may be required for the purposes mentioned in subsection (1). O. Reg. 737/84, s. 12.

13.—(1) There shall be an advisory committee to be known as the "Chicken Processors' Market Committee".

(2) The Chicken Processors' Market Committee shall be composed of four members as follows:

- 1. Three members shall be persons elected by the Chicken Processors' Market Committee Panel.
- 2. One member shall be a person employed by the Chicken Processors' Market Committee Panel and appointed to the Committee by the Panel.

(3) Every processor of chickens in Ontario shall be a member of a body to be known as the "Chicken Processors' Market Committee Panel".

(4) A person elected to the Chicken Processors' Market Committee under paragraph 1 of subsection (2),

- (a) must be a processor of chickens in Ontario or the representative of a processor of chickens in Ontario;
- (b) shall be elected to hold office for a period of ninety days following his or her election;
- (c) ceases to be a member of the Committee if the person ceases to be a processor or a representative of a processor, as the case may be; and
- (d) is not eligible to succeed himself or herself as a member of the Committee.

(5) The Chicken Processors' Market Committee shall make recommendations to the local board in respect of,

- (a) prices and other matters relating to the marketing of chickens;
- (b) the determining from time to time of the price or prices that shall be paid to producers for chickens or any class, variety, grade or size of chickens.

(6) Despite clause (4) (b), one first member of the Chicken Processors' Market Committee shall be elected for a term of sixty days and one first member shall be elected for a term of thirty days. O. Reg. 737/84, s. 13.

POWER TO CONDUCT POOLS

14. The Commission authorizes the local board to conduct a pool or pools for the distribution of all money received from the sale of chickens and, after deducting all necessary and proper disbursements and expenses, to distribute the remainder of the money received from the sale in such manner that every producer receives a share of the remainder of the money received from the sale in relation to the amount, class, variety, grade or size of chickens delivered by the producer, and authorizes the local board to make an initial payment on delivery of the chickens and subsequent payments until all of the remainder of the money received from the sale is distributed to the producers. O. Reg. 737/84, s. 14.

15. The Commission authorizes the local board to require the price or prices payable or owing to the producers for chickens to be paid to or through the local board and to recover such price or prices by suit in a court of competent jurisdiction. O. Reg. 737/84, s. 15.

16. The Commission authorizes the local board to appoint agents, to prescribe their duties and terms and conditions of employment and to provide for their remuneration. O. Reg. 737/84, s. 16.

REGULATION 403

CHICKENS—PLAN

1. The Plan in the Schedule is continued for the control and regulation of the producing and marketing within Ontario of chickens. O. Reg. 736/84, s. 1.

2. The local board named in the Schedule is given the powers set out in subsection 15 (1), in paragraphs 1 to 8, both inclusive, 10 to 19, both inclusive, and 26 of subsection 15 (2) and in sections 50 and 110 of the *Co-operative Corporations Act*. O. Reg. 736/84, s. 2.

3. The members of the local board shall be deemed to be the shareholders and the directors thereof in the exercise of any of the powers mentioned in section 2. O. Reg. 736/84, s. 3.

Schedule

Farm Products Marketing Act

PLAN

1. This plan may be cited as “The Ontario Chicken Producers’ Marketing Plan”.

2. In this plan,

“chicken” means a chicken or any class or part thereof produced from the egg of a domestic hen;

“processor” means a person who slaughters chickens, and “processing” has a corresponding meaning;

“producer” means a person to whom a quota is fixed and allotted for the producing of chickens.

3. For the purpose of electing producer-representatives to the District Chicken Producers’ Committee and eligibility for membership in a District Chicken Producers’ Committee or the local board, a producer is the owner of a property on which chickens are produced other than a property rented to a tenant who produces and markets chickens on the tenant’s own account, in which case the tenant, during the currency of the lease, is the producer, and,

- (a) where the producer is a corporation, the person, if any, designated in writing in respect of that property by the corporation shall be deemed to be the producer;
- (b) where the producer is a firm or partnership or one or more persons carrying on the production and marketing under a trade name, farm name or other designation, the person, if any, designated in writing in respect of that property by the owner or owners shall be deemed to be the producer; and
- (c) where the producer is comprised of two or more persons who are joint owners, the one of such joint owners who first presents himself or herself to register the vote in respect of that property shall be deemed to be the producer.

4. This plan provides for the control and regulation in any or all respects of the producing and marketing within Ontario of chickens, including the prohibition of such producing and marketing in whole or in part.

5. There shall be a local board to be known as “The Ontario Chicken Producers’ Marketing Board”.

6. The local board shall be composed of nine producer-members.

7. Producers are divided into nine districts as follows:

1. District 1, comprising the counties of Bruce, Dufferin and Grey, The District Municipality of Muskoka and the

County of Simcoe other than the townships of West Gwillimbury and Innisfil.

2. District 2, comprising the counties of Huron and Perth.

3. District 3, comprising the counties of Elgin, Essex, Kent, Lambton, Middlesex and Oxford.

4. District 4, comprising The Regional Municipality of Haldimand-Norfolk.

5. District 5, comprising The Regional Municipality of Niagara.

6. District 6, comprising the County of Brant, the regional municipalities of Halton and Hamilton-Wentworth and that part of the Regional Municipality of Waterloo that on the 31st day of December, 1972 was in the County of Wentworth.

7. District 7, comprising the County of Wellington and The Regional Municipality of Waterloo except that part that on the 31st day of December, 1972 was in the County of Wentworth.

8. District 8, comprising the County of York as it existed on the 31st day of December, 1970, the townships of West Gwillimbury and Innisfil in the County of Simcoe, that part of The Regional Municipality of Durham that on the 31st day of December, 1973 was in the County of Ontario, and The Regional Municipality of Peel.

9. District 9, comprising the counties of Dundas, Frontenac, Glengarry, Grenville, Hastings, Lanark, Lennox and Addington, Northumberland, Peterborough, Prescott, Prince Edward, Renfrew, Russell, Stormont and Victoria, The Regional Municipality of Ottawa-Carleton, the County of Haliburton, and that part of The Regional Municipality of Durham that on the 31st day of December, 1973 was in the County of Durham.

8.—(1) The producers in each district mentioned in section 7 form a district group of producers.

(2) A producer in a territorial district or county not included in a district mentioned in section 7 may become a member of the district group of producers nearest to the producer’s place of production.

9.—(1) There shall be a committee of not less than four producer-members in each district to be known as the “District Chicken Producers’ Committee”.

(2) Subject to subsection (1), the number of producer-member representatives comprising each District Chicken Producers’ Committee shall be determined on the basis of one producer-member representative for every twenty producers or part thereof in the district at the time of the election referred to in section 10.

10.—(1) On or before the 15th day of March, 1990 and subsequently in every second year, the producers in each of Districts 1 to 5 shall elect from among themselves representatives to the District Chicken Producers’ Committee and one representative to the local board.

(2) On or before the 15th day of March, 1991 and subsequently in every second year, the producers in each of Districts 6 to 9 shall elect from among themselves representatives to the District Chicken Producers’ Committee and one representative to the local board.

(3) The term of office of each person elected under subsection (1) or (2) shall commence on the day of the annual meeting of the local board after the election and shall expire when the person’s successor takes office.

(4) No person is eligible for election to the local board who has

not been elected a representative to the District Chicken Producers' Committee for the same term as that for which he or she is proposed to be elected to the local board.

(5) No person is eligible for election from any district to the local board unless he or she resides within the district.

11.—(1) Where the producers in any district fail to elect a representative to the local board in accordance with section 10, the members of the local board shall, at its first meeting after the 15th day of March, appoint such producer-members as are necessary to complete the local board.

(2) When a member elected or appointed to the local board dies, resigns, becomes unavailable to act or ceases to be a producer before his or her term has expired, the members of the local board may appoint a producer-member for the unexpired term.

(3) Each producer-member appointed as a member to the local board under subsection (1) or (2) shall be a producer in the district for which he or she is appointed.

(4) Where the members of the local board fail to appoint a person for the unexpired term of a member under subsection (2) within seven days from the death, resignation or date on which the member becomes unavailable to act or ceases to be a producer, the Commission may appoint a producer for the unexpired term. O. Reg. 736/84, Sched.; O. Reg. 297/87, s. 1; O. Reg. 97/90, s. 1.

REGULATION 404

DESIGNATION—ONTARIO CANOLA GROWERS' ASSOCIATION

1. In this Regulation, "association" means the Ontario Canola Growers' Association. O. Reg. 429/88, s. 1.

2. The Ontario Canola Growers' Association is designated as the representative association of producers of canola within Ontario for the carrying out of a program for stimulating, increasing and improving the producing and marketing locally within Ontario of canola by advertising, education, research and other means. O. Reg. 429/88, s. 2.

3. Every producer who sells canola shall pay licence fees of \$2 a tonne to the association. O. Reg. 429/88, s. 3.

4.—(1) Every person who buys canola from a producer shall deduct, from the money payable to the producer, the licence fees payable by the producer to the association respecting the canola.

(2) On or before the fifteenth day of each month, every person shall forward to the association all licence fees deducted by the person under subsection (1) during the preceding month. O. Reg. 429/88, s. 4.

5. The association is authorized to use the licence fees for the purposes of defraying the expenses of the association in carrying out its objects. O. Reg. 429/88, s. 5.

6. The association shall furnish to the Commission such information and financial statements as the Commission determines. O. Reg. 429/88, s. 6.

REGULATION 405

DESIGNATION—ONTARIO COLOURED BEAN GROWERS' ASSOCIATION

1. In this Regulation,

"association" means the Ontario Coloured Bean Growers' Association;

"coloured beans" means any of Adzuki, cranberry, dark red kidney, Dutch brown, great northern, light red kidney, pinto, black turtle, white kidney or yellow-eye. O. Reg. 430/88, s. 1.

2. The Ontario Coloured Bean Growers' Association is designated as the representative association of producers of coloured beans within Ontario for the carrying out of a program for stimulating, increasing and improving the producing and marketing locally within Ontario of coloured beans by advertising, education, research and other means. O. Reg. 430/88, s. 2.

3. Every producer who sells coloured beans shall pay licence fees of \$5 a tonne to the association. O. Reg. 430/88, s. 3.

4.—(1) Every person who buys coloured beans from a producer shall deduct, from the money payable to the producer, the licence fees payable by the producer to the association respecting the coloured beans.

(2) On or before the fifteenth day of each month, every person shall forward to the association all licence fees deducted by the person pursuant to subsection (1) during the preceding month. O. Reg. 430/88, s. 4.

5. The association is authorized to use the licence fees for the purposes of defraying the expenses of the association in carrying out its objects. O. Reg. 430/88, s. 5.

6. The association shall furnish to the Commission such information and financial statements as the Commission determines. O. Reg. 430/88, s. 6.

REGULATION 406

EGGS—EXTENSION OF POWERS OF THE CANADIAN EGG MARKETING AGENCY

1. In this Regulation "eggs" means eggs of a domestic hen produced in Ontario other than hatching eggs. R.R.O. 1980, Reg. 355, s. 1, *revised*.

2. The Lieutenant Governor in Council hereby grants authority to The Canadian Egg Marketing Agency to regulate the marketing within Ontario of eggs in the manner set out in section 3. R.R.O. 1980, Reg. 355, s. 2, *revised*.

3. For the purpose of regulating the marketing within Ontario of eggs, The Canadian Egg Marketing Agency may exercise, with respect to eggs so marketed, the powers that it may exercise with respect to eggs marketed in interprovincial or export trade under paragraph 22 (1) (a) of the *Farm Products Marketing Agencies Act* (Canada). R.R.O. 1980, Reg. 355, s. 3, *revised*.

REGULATION 407

EGGS—MARKETING

1. In this Regulation,

"chicks-for-placement" means female chickens twenty weeks of age or less or any class thereof;

"eggs" means eggs of a domestic hen produced in Ontario other than hatching eggs;

"fowl" means a domestic hen more than twenty weeks of age;

"hatching eggs" means eggs of a domestic hen produced in Ontario

for the purpose of hatching into chicks not intended to be grown into broiler chickens or roasted chickens;

“local board” means The Ontario Egg Producers’ Marketing Board;

“producer” means a person engaged in the production of chicks-for-placement, eggs, hatching eggs or fowl. R.R.O. 1980, Reg. 357, s. 1; O. Reg. 435/83, s. 1.

2. This Regulation provides for the control and regulation in any or all respects of the producing and marketing within Ontario of chicks-for-placement, eggs, hatching eggs and fowl, including the prohibition of such producing and marketing in whole or in part. O. Reg. 610/81, s. 1.

3. The Commission exempts from sections 5 to 12 hatching eggs that are marketed for hatching purposes. O. Reg. 435/83, s. 2.

POWERS OF LOCAL BOARD

4. The Commission delegates to the local board the power,

- (a) to require persons engaged in producing or marketing chicks-for-placement, eggs, hatching eggs or fowl to register their names, addresses and occupations with the local board;
- (b) to require persons engaged in producing for marketing chicks-for-placement, eggs, hatching eggs or fowl to furnish such information relating to the production or marketing of chicks-for-placement, eggs, hatching eggs or fowl, including the completing and filing of returns, as the local board determines;
- (c) to appoint persons to,
 - (i) inspect the books, records, documents, lands and premises and any chicks-for-placement, eggs, hatching eggs and fowl of persons engaged in producing or marketing chicks-for-placement, eggs, hatching eggs or fowl, and
 - (ii) enter on lands or premises used for the producing of chicks-for-placement, eggs, hatching eggs or fowl and perform a count of chicks-for-placement, eggs, hatching eggs or fowl;
- (d) to stimulate, increase and improve the marketing of chicks-for-placement, eggs, hatching eggs and fowl by such means as it considers proper;
- (e) to co-operate with a marketing board, local board, marketing commission or marketing agency of Canada or of any province in Canada for the purpose of marketing chicks-for-placement, eggs, hatching eggs or fowl; and
- (f) to do such acts and make such orders and issue such directions as are necessary to enforce the due observance and carrying out of the Act, the regulations or the plan. R.R.O. 1980, Reg. 357, s. 4.

5. The Commission delegates to the local board its powers to make regulations with respect to eggs and hatching eggs,

- (a) providing for the licensing of any or all persons before commencing or continuing to engage in the producing, marketing or processing of eggs or hatching eggs;
- (b) prohibiting persons from engaging in the producing, marketing or processing of eggs or hatching eggs except under the authority of a licence;
- (c) subject to section 15, providing for the refusal to grant a licence where the applicant is not qualified by experience, financial responsibility and equipment to engage in prop-

erly the business for which the application was made, or for any other reason that the local board considers proper;

- (d) providing for the suspension or revocation of, or the refusal to renew, a licence for failure to observe, perform or carry out the Act, the regulations, the plan or any order or direction of the Commission or local board;
- (e) providing for the fixing of licence fees payable yearly, half-yearly, quarterly or monthly at different amounts or in instalments from any or all persons producing or marketing eggs or hatching eggs and the collecting of licence fees and the recovering of such licence fees by suit in a court of competent jurisdiction;
- (f) requiring any person who receives eggs or hatching eggs to deduct from the money payable for the eggs or hatching eggs any licence fees payable to the local board by the person from whom the eggs or hatching eggs are received, and to forward such licence fees to the local board;
- (g) requiring any person who produces and processes eggs or hatching eggs to furnish to the local board statements of the amounts of eggs and hatching eggs produced by the person in any year and used for processing;
- (h) prescribing the form of licences;
- (i) providing for the exemption from any or all of the regulations, orders or directions under the plan of any class, variety, grade or size of eggs or hatching eggs or any person or class of persons engaged in the producing or marketing of eggs or hatching eggs or any class, variety, grade or size of eggs or hatching eggs;
- (j) requiring the furnishing of security or proof of financial responsibility by any person engaged in the marketing of eggs or hatching eggs and providing for the administration and disposition of any money or securities so furnished;
- (k) providing for the control and regulation of the marketing of chicks-for-placement, eggs and hatching eggs, including the times and places at which chicks-for-placement, eggs and hatching eggs may be marketed;
- (l) providing for the control and regulation of agreements entered into by producers of chicks-for-placement, eggs or hatching eggs with persons engaged in marketing or processing chicks-for-placement, eggs or hatching eggs, and the prohibition of any provision or clause in such agreements;
- (m) requiring any person who produces eggs or hatching eggs to offer to sell and to sell eggs or hatching eggs to or through the local board;
- (n) prohibiting any person from processing, packing or packaging any eggs or hatching eggs that have not been sold to, by or through the local board;
- (o) providing for the making of agreements relating to the marketing of eggs or hatching eggs by or through the local board and prescribing the forms and the terms and conditions of such agreements; and
- (p) providing for the making of such orders and the issuing of such directions as are necessary to enforce the due observance and carrying out of the Act, the regulations, the plan or any order or direction of the Commission or the local board. R.R.O. 1980, Reg. 357, s. 5.

6. The Commission vests in the local board the following powers:

1. To direct and control, by order or direction, either as principal or agent, the marketing of eggs and hatching eggs,

including the times and places at which eggs or hatching eggs may be marketed.

2. To determine the quality of each class, variety, grade and size of eggs or hatching eggs that shall be marketed by each producer.
3. To prohibit the marketing of any class, variety, grade or size of eggs or hatching eggs.
4. To determine from time to time the price or prices that shall be paid to producers or to the local board, as the case may be, for eggs or any class, variety, grade or size of eggs and to determine different prices for different parts of Ontario.
5. To fix and impose service charges from time to time for the marketing of eggs and hatching eggs.
6. To require the price or prices payable or owing to the producer for eggs or hatching eggs to be paid to or through the local board.
7. To collect from any person by suit in a court of competent jurisdiction the price or prices or any part thereof of eggs or hatching eggs.
8. To purchase or otherwise acquire such quantity or quantities of eggs or hatching eggs as the local board considers advisable and to sell or otherwise dispose of any eggs or hatching eggs so purchased or acquired.
9. To pay from service charges imposed under paragraph 5 its expenses in carrying out the purposes of the plan.
10. To pay to the producers the price or prices for eggs or hatching eggs less service charges imposed under paragraph 5 and to fix the times at which or within which such payments shall be made. R.R.O. 1980, Reg. 357, s. 6; O. Reg. 687/81, s. 2.

7.—(1) The Commission authorizes the local board,

- (a) to require that eggs be marketed on a quota basis;
 - (b) to prohibit any person to whom a quota has not been fixed and allotted for the marketing of eggs or whose quota has been cancelled from marketing any eggs;
 - (c) to prohibit any person to whom a quota has been fixed and allotted for the marketing of eggs from marketing any eggs in excess of such quota; and
 - (d) to prohibit any person to whom a quota has been fixed and allotted for the marketing of eggs produced on lands or premises in respect of which such quota was fixed and allotted from marketing any eggs other than eggs produced on such lands or premises.
- (2) The Commission authorizes the local board,
- (a) to fix and allot to persons quotas for the marketing of eggs on such basis as the local board considers proper;
 - (b) to refuse to fix and allot to any person a quota for the marketing of eggs for any reason that the local board considers proper;
 - (c) to cancel or reduce, or refuse to increase, a quota fixed and allotted to any person for the marketing of eggs for any reason that the local board considers proper; and
 - (d) to permit any person to whom a quota has been fixed and allotted for the marketing of eggs to market any eggs in excess of such quota on such terms and conditions as the local board considers proper.

(3) The Commission authorizes the local board,

- (a) to require that hatching eggs be marketed on a quota basis;
- (b) to prohibit any person to whom a quota has not been fixed and allotted for the marketing of hatching eggs or whose quota has been cancelled from marketing any hatching eggs;
- (c) to prohibit any person to whom a quota has been fixed and allotted for the marketing of hatching eggs from marketing any hatching eggs in excess of such quota; and
- (d) to prohibit any person to whom a quota has been fixed and allotted for the marketing of hatching eggs produced on lands or premises in respect of which such quota was fixed and allotted from marketing any hatching eggs other than hatching eggs produced on such lands or premises.

(4) The Commission authorizes the local board,

- (a) to fix and allot to persons quotas for the marketing of hatching eggs on such basis as the local board considers proper;
- (b) to refuse to fix and allot to any person a quota for the marketing of hatching eggs for any reason that the local board considers proper;
- (c) to cancel or reduce, or refuse to increase, a quota fixed and allotted to any person for the marketing of hatching eggs for any reason that the local board considers proper; and
- (d) to permit any person to whom a quota has been fixed and allotted for the marketing of hatching eggs to market any hatching eggs in excess of such quota on such terms and conditions as the local board considers proper.

(5) The Commission authorizes the local board,

- (a) to require that chicks-for-placement be marketed on a quota basis;
- (b) to prohibit any person to whom a quota has not been fixed and allotted for the marketing of chicks-for-placement or whose quota has been cancelled from marketing any chicks-for-placement;
- (c) to prohibit any person to whom a quota has been fixed and allotted for the marketing of chicks-for-placement from marketing any chicks-for-placement in excess of such quota; and
- (d) to prohibit any person to whom a quota has been fixed and allotted for the marketing of chicks-for-placement produced on lands or premises in respect of which such quota was fixed and allotted from marketing any chicks-for-placement other than chicks-for-placement produced on such lands or premises.

(6) The Commission authorizes the local board,

- (a) to fix and allot to persons quotas for the marketing of chicks-for-placement on such basis as the local board considers proper;
- (b) to refuse to fix and allot to any person a quota for the marketing of chicks-for-placement for any reason that the local board considers proper;
- (c) to cancel or reduce, or refuse to increase, a quota fixed and allotted to any person for the marketing of chicks-for-placement for any reason that the local board considers proper; and

- (d) to permit any person to whom a quota has been fixed and allotted for the marketing of chicks-for-placement to market any chicks-for-placement in excess of such quota on such terms and conditions as the local board considers proper. R.R.O. 1980, Reg. 357, s. 7.

8.—(1) The Commission authorizes the local board to use any class of licence fees, service charges, and other money payable to it, for the purpose of paying the expenses of the local board, carrying out and enforcing the Act and the regulations and carrying out the purposes of the plan.

(2) The Commission authorizes the local board to establish a fund in connection with the plan for the payment of any money that may be required for the purposes mentioned in subsection (1). R.R.O. 1980, Reg. 357, s. 8.

9.—(1) There shall be a committee to be known as “The Egg Industry Advisory Committee”. R.R.O. 1980, Reg. 357, s. 9 (1).

(2) The Egg Industry Advisory Committee shall be composed of a chair and thirteen members. O. Reg. 435/83, s. 3 (1).

(3) In each year after the 1st day of April and before the 30th day of April,

- (a) the Commission shall appoint the chair;
- (b) the local board shall appoint five members;
- (c) the Ontario Pullet Growers’ Association shall appoint two members;
- (d) The Ontario Hatcheries Association shall appoint three members, one of whom shall be a representative of a hatchery that markets chicks for meat production and the remaining two of whom shall be representatives of a hatchery that markets chicks for commercial egg production;
- (e) the Ontario Grain and Feed Dealers Association shall appoint one member;
- (f) the Ontario Egg Processors Association shall appoint one member; and
- (g) the Commission shall appoint one member to represent the operators of egg breaking plants in Ontario,

to The Egg Industry Advisory Committee. R.R.O. 1980, Reg. 357, s. 9 (3); O. Reg. 687/81, s. 3 (2); O. Reg. 435/83, s. 3 (2).

(4) The members of The Egg Industry Advisory Committee are and remain members thereof until the 30th day of April in the year following the year in which they were appointed.

(5) Where a member of The Egg Industry Advisory Committee dies or resigns or is unavailable to act before the expiration of his or her term, the person or persons who appointed him or her shall appoint a person for the unexpired term of the member who died, resigned or was unavailable to act.

(6) The Egg Industry Advisory Committee may advise and make recommendations to the local board or to any person or organization represented on the committee in respect of,

- (a) the promotion of harmonious relationships between persons engaged in the production and marketing of eggs, hatching eggs, chicks-for-placement or fowl;
- (b) the promotion of greater efficiency in the production and marketing of eggs, hatching eggs, chicks-for-placement and fowl;
- (c) the prevention and correction of irregularities and inequi-

ties in the marketing of eggs, hatching eggs, chicks-for-placement and fowl;

- (d) the improvement of the quality and variety of eggs, hatching eggs, chicks-for-placement and fowl;
- (e) the improvement of the circulation of market information respecting eggs, hatching eggs, chicks-for-placement and fowl; and
- (f) without limiting the generality of any of the foregoing, any matter with respect to which the Commission or the local board may be empowered to make regulations under the Act.

(7) The local board shall forthwith provide the Commission with full particulars of any recommendations made to the local board by The Egg Industry Advisory Committee. R.R.O. 1980, Reg. 357, s. 9 (4-7).

10. The Commission authorizes the local board to conduct a pool or pools for the distribution of all money received from the sale of eggs and hatching eggs and, after deducting all necessary and proper disbursements and expenses, to distribute the remainder of the money received from the sale in such manner that every producer receives a share of the remainder of the money received from the sale in relation to the amount, class, variety, grade or size of eggs or hatching eggs delivered by the producer, and authorizes the local board to make an initial payment on delivery of the eggs or hatching eggs and subsequent payments until all of the remainder of the money received from the sale is distributed to the producers. R.R.O. 1980, Reg. 357, s. 10.

11. The Commission authorizes the local board to appoint agents, to prescribe their duties and terms and conditions of employment and to provide for their remuneration. R.R.O. 1980, Reg. 357, s. 11.

12.—(1) All eggs and hatching eggs shall be marketed through the local board.

(2) No person shall market eggs or hatching eggs except through the local board. R.R.O. 1980, Reg. 357, s. 12.

13. The local board shall give statements to every person engaged in producing eggs or hatching eggs showing the class, variety, grade or size and the number or quantity of eggs or hatching eggs marketed, the price or prices paid and particulars of the service charges imposed by it. R.R.O. 1980, Reg. 357, s. 13.

14. The Commission vests in the local board the power to make regulations,

- (a) providing for the seizure and detention of the whole or any part of any chicks-for-placement, eggs, fowl or hatching eggs or any class, variety, grade or size thereof by any person appointed under clause 3 (1) (g) of the Act where the person believes on reasonable grounds an offence against the Act or the regulations has been committed in respect of the chicks-for-placement, eggs, fowl or hatching eggs;
- (b) providing for the release from detention of the whole or any part of any chicks-for-placement, eggs, fowl or hatching eggs or any class, variety, grade or size thereof where the local board is satisfied that the owner of the chicks-for-placement, eggs, fowl or hatching eggs that have been seized and detained comply with the Act and the regulations respecting the chicks-for-placement, eggs, fowl or hatching eggs;
- (c) providing for the disposal of the whole or any part of any chicks-for-placement, eggs, fowl or hatching eggs or any class, variety, grade or size thereof that have been seized and detained and providing for the administration and disposition of any money derived from any such disposal; and

- (d) prescribing the manner in which the chicks-for-placement, eggs, fowl or hatching eggs shall be seized, detained, released and disposed of. R.R.O. 1980, Reg. 357, s. 14.
15. The Commission delegates to the local board its powers to make regulations, despite clause 5 (c), providing for the refusal to grant a licence for the producing of chicks-for-placement or eggs or hatching eggs for any reason that the local board considers proper. R.R.O. 1980, Reg. 357, s. 15.
- 16.—(1) The Commission authorizes the local board,
- (a) to require that chicks-for-placement be produced on a quota basis;
- (b) to prohibit any person to whom a quota has not been fixed and allotted for the producing of chicks-for-placement or whose quota has been cancelled from producing any chicks-for-placement;
- (c) to prohibit any person to whom a quota has been fixed and allotted for the producing of chicks-for-placement from producing any chicks-for-placement in excess of such quota; and
- (d) to prohibit any person from producing chicks-for-placement in premises other than premises in respect of which a quota for producing chicks-for-placement has been fixed and allotted to such person.
- (2) The Commission authorizes the local board,
- (a) to fix and allot to persons quotas for producing chicks-for-placement on such basis as the local board considers proper;
- (b) to refuse to fix and allot to any person a quota for producing chicks-for-placement for any reason that the local board considers proper;
- (c) to cancel or reduce, or refuse to increase, a quota fixed and allotted to any person for producing chicks-for-placement for any reason that the local board considers proper, and, without limiting the generality of the foregoing, to cancel or reduce any such quota as a penalty where the local board has reasonable grounds for belief that the person to whom the quota was fixed and allotted has contravened the Act or the regulations; and
- (d) to permit any person to whom a quota has been fixed and allotted for the producing of chicks-for-placement to produce any chicks-for-placement in excess of such quota on such terms and conditions as the local board considers proper.
- (3) The Commission authorizes the local board,
- (a) to require that eggs be produced on a quota basis;
- (b) to prohibit any person to whom a quota has not been fixed and allotted for the producing of eggs or whose quota has been cancelled from producing any eggs;
- (c) to prohibit any person to whom a quota has been fixed and allotted for the producing of eggs from producing any eggs in excess of such quota; and
- (d) to prohibit any person from producing eggs in premises other than premises in respect of which a quota for producing eggs has been fixed and allotted to such person.
- (4) The Commission authorizes the local board,
- (a) to fix and allot to persons quotas for producing eggs on such basis as the local board considers proper;
- (b) to refuse to fix and allot to any person a quota for producing eggs for any reason that the local board considers proper;
- (c) to cancel or reduce, or refuse to increase, a quota fixed and allotted to any person for producing eggs for any reason that the local board considers proper, and, without limiting the generality of the foregoing, to cancel or reduce any such quota as a penalty where the local board has reasonable grounds for belief that the person to whom the quota was fixed and allotted has contravened the Act or the regulations; and
- (d) to permit any person to whom a quota has been fixed and allotted for the producing of eggs to produce any eggs in excess of such quota on such terms and conditions as the local board considers proper.
- (5) The Commission authorizes the local board,
- (a) to require that hatching eggs be produced on a quota basis;
- (b) to prohibit any person to whom a quota has not been fixed and allotted for the producing of hatching eggs or whose quota has been cancelled from producing any hatching eggs;
- (c) to prohibit any person to whom a quota has been fixed and allotted for the producing of hatching eggs from producing any hatching eggs in excess of such quota; and
- (d) to prohibit any person from producing hatching eggs in premises other than premises in respect of which a quota for producing hatching eggs has been fixed and allotted to such person.
- (6) The Commission authorizes the local board,
- (a) to fix and allot to persons quotas for producing hatching eggs on such basis as the local board considers proper;
- (b) to refuse to fix and allot to any person a quota for producing hatching eggs for any reason that the local board considers proper;
- (c) to cancel or reduce, or refuse to increase, a quota fixed and allotted to any person for producing hatching eggs for any reason that the local board considers proper, and without limiting the generality of the foregoing, to cancel or reduce any such quota as a penalty where the local board has reasonable grounds for belief that the person to whom the quota was fixed and allotted has contravened the Act or the regulations; and
- (d) to permit any person to whom a quota has been fixed and allotted for the producing of hatching eggs to produce any hatching eggs in excess of such quota on such terms and conditions as the local board considers proper.
- (7) The Commission authorizes the local board,
- (a) to require that fowl be possessed on a quota basis;
- (b) to prohibit any person to whom a quota has not been fixed and allotted for the possession of fowl or whose quota has been cancelled from possessing any fowl;
- (c) to prohibit any person to whom a quota has been fixed and allotted for possessing any fowl in excess of such quota; and
- (d) to prohibit any person from possessing fowl in premises other than premises in respect of which a quota for possessing fowl has been fixed and allotted to such person.
- (8) The Commission authorizes the local board,

- (a) to fix and allot to persons quotas for possessing fowl on such basis as the local board considers proper;
- (b) to refuse to fix and allot to any person a quota for possessing fowl for any reason that the local board considers proper;
- (c) to cancel or reduce, or refuse to increase, a quota fixed and allotted to any person for possessing fowl for any reason that the local board considers proper, and without limiting the generality of the foregoing, to cancel or reduce any such quota as a penalty where the local board has reasonable grounds for belief that the person to whom the quota was fixed and allotted has contravened the Act or the regulations; and
- (d) to permit any person to whom a quota has been fixed and allotted for possessing fowl to possess any fowl in excess of such quota on such terms and conditions as the local board considers proper. R.R.O. 1980, Reg. 357, s. 16.

REGULATION 408

EGGS—MARKETING LIMITATIONS

1. The Commission considers it necessary and advisable and requires that the local board carry out the purposes of The Ontario Egg Producers' Marketing Plan in accordance with the Schedule. R.R.O. 1980, Reg. 358, s. 1.

2. Sections 1, 2 and 3 of Regulation 407 of Revised Regulations of Ontario, 1990 apply to this Regulation with necessary modifications. R.R.O. 1980, Reg. 358, s. 2.

Schedule

1. In this Schedule,

"Agency" means the Canadian Egg Marketing Agency;

"quota" means a quota fixed and allotted to a producer under section 7 of Regulation 407 of Revised Regulations of Ontario, 1990;

"quota system" means the method by which the quota fixed and allotted to any producer is determined.

2. The local board shall establish a quota system in order to fix and allot quotas to all producers of eggs or hatching eggs in Ontario in such manner that the number of dozens of eggs and hatching eggs produced in Ontario and authorized to be marketed in intraprovincial trade in the year 1973, when taken together with the number of dozens of eggs and hatching eggs produced in Ontario and authorized to be marketed in interprovincial and export trade in the same year, pursuant to quotas assigned by the Agency and the number of dozens of and hatching eggs produced in the Province and anticipated to be marketed in the same year other than as authorized by a quota assigned by the Agency or fixed and allotted by the local board, will equal the number of dozens of eggs and hatching eggs set out in section 3 of this Schedule.

3. For the purposes of section 2 of this Schedule the number of dozens of eggs and hatching eggs set out in this section is as set out in the Table and represents the percentage of total Canadian production shown in the Table.

TABLE

181,267,000 dozens	:	38.161 per cent
--------------------	---	-----------------

4.—(1) No order or regulation shall be made where the effect thereof would be to increase the aggregate of,

- (a) the number of dozens of eggs and hatching eggs produced

in Ontario and authorized by quotas fixed and allotted by the local board and by quotas assigned by the Agency to be marketed in intraprovincial, interprovincial and export trade; and

- (b) the number of dozens of eggs and hatching eggs produced in Ontario and anticipated to be marketed in intraprovincial, interprovincial and export trade other than as authorized by quotas fixed and allotted by the local board and by quotas assigned by the Agency,

to a number that exceeds, on a yearly basis, the number of dozens of eggs and hatching eggs set out in section 3 of this Schedule unless the local board has taken into account,

- (c) the principle of comparative advantage of production in respect of each province in Canada;
- (d) any variation in the size of the market for eggs or hatching eggs;
- (e) any failures by producers to market the number of dozens of eggs or hatching eggs authorized to be marketed;
- (f) the feasibility of increased production in each province to be marketed; and
- (g) comparative transportation costs to market areas from alternative sources of production,

and the Agency is making a similar order or regulation.

(2) No order or regulation shall be made where the effect thereof would be to decrease the aggregate of,

- (a) the number of dozens of eggs and hatching eggs produced in Ontario and authorized by quotas fixed and allotted by the local board and by quotas assigned by the Agency to be marketed in intraprovincial, interprovincial and export trade; and
- (b) the number of dozens of eggs and hatching eggs produced in Ontario and anticipated to be marketed in intraprovincial, interprovincial and export trade other than as authorized by quotas fixed and allotted by the local board and by quotas assigned by the Agency,

to a number that, on a yearly basis is less than the number of dozens of eggs and hatching eggs set out in section 3 of this Schedule unless at the same time the number of dozens of eggs or hatching eggs produced in each other province of Canada and authorized to be marketed in intraprovincial, interprovincial and export trade is decreased proportionately.

(3) Where the Agency has made an order or regulation pursuant to provisions of a marketing plan similar to subsection (1) or (2), the local board shall make a similar order or regulation.

5. Subject to section 10 of Regulation 407 of Revised Regulations of Ontario, 1990, the local board, in the exercise of its powers under clauses 7 (2) (d) and 7 (4) (d) of the said Regulation may require eggs or hatching eggs to be sold to the local board or its agent at a price not exceeding the difference, if any, between the price realized by the local board or its agent on the marketing of such eggs or hatching eggs and its expenses related to such marketing.

6. The local board shall not market any quantity of eggs or hatching eggs made available to it in excess of the number of eggs referred to in sections 2 and 3 or as modified under section 4 of this Schedule, without prior consultation with the Agency.

7. The local board shall, with the concurrence of the Agency, administer, on its behalf, all orders and regulations made by the Agency for the purpose of establishing and implementing a quota

system or any such orders or regulations necessary to implement the provisions of the Canadian Egg Marketing Agency Proclamation.

8. The local board shall make, approve and implement any order or regulation necessary to give effect to this Schedule.

9. The local board shall make available to the Agency any document or extract of documents establishing the registration or licensing of producers.

10. The local board shall, with the concurrence of the Agency, collect on the Agency's behalf any levies imposed by the Agency.

11.—(1) In implementing clauses 4 (a) and (b) of Regulation 407 of Revised Regulations of Ontario, 1990, the local board shall require of producers, producer-graders, dealers, wholesalers and processors all information necessary to monitor sales of eggs and hatching eggs.

(2) The local board shall establish a system for verification of sales.

(3) The local board shall provide all information obtained from the system referred to in subsection (2) to the Agency when so requested by the Agency.

12. The local board shall take all reasonable steps to promote a high degree of co-operation between itself and the Agency, and without limiting the generality of the foregoing shall,

- (a) make available to the Agency the records, minutes and decisions of the local board in relation to any matter that is of concern to the Agency;
- (b) allow an officer or employee of the Agency who is designated by the Agency for such purpose to attend meetings of the local board at which any matter that is of concern to the Agency is likely to be discussed and for such purpose shall give notice of all such meetings to the officer or employee so designated; and
- (c) give notice to the Agency of each order or regulation that it proposes to make that is likely to affect the Agency in its operations.

13. The authority and powers referred to in Regulation 407 of Revised Regulations of Ontario, 1990 are limited by and subject to this Schedule. R.R.O. 1980, Reg. 358, Sched., *revised*.

REGULATION 409

EGGS—PLAN

1. The plan in the Schedule is continued for the control and regulation of the marketing within Ontario of chicks-for-placement, eggs, hatching eggs and fowl. R.R.O. 1980, Reg. 356, s. 1.

2. The local board named in the Schedule is given the powers set out in subsection 15 (1), paragraphs 1, 2, 3, 4, 5, 6, 7, 8, 10, 11, 12, 13, 14, 15, 16, 17, 18, 19 and 26 of subsection 15 (2) and in sections 50 and 110 of the *Co-operative Corporations Act*. R.R.O. 1980, Reg. 356, s. 2.

3. The members of the local board shall be deemed to be the shareholders and the directors thereof in the exercise of any of the powers mentioned in section 2. R.R.O. 1980, Reg. 356, s. 3.

Schedule

Farm Products Marketing Act

PLAN

1. This plan may be cited as "The Ontario Egg Producers' Marketing Plan".

2. In this plan,

"chicks-for-placement" means female chickens twenty weeks of age or less or any class thereof;

"eggs" means eggs of a domestic hen produced in Ontario other than hatching eggs;

"fowl" means a domestic hen more than twenty weeks of age;

"hatching eggs" means eggs of a domestic hen produced in Ontario for the purpose of hatching into chicks not intended to be grown into broiler chickens or roaster chickens;

"Minister" means the Minister of Agriculture and Food;

"producer" means a person engaged in the production of chicks-for-placement, eggs, hatching eggs or fowl.

3. This plan provides for the control and regulation in any or all respects of the producing and marketing within Ontario of chicks-for-placement, eggs, hatching eggs and fowl, including the prohibition of such producing and marketing in whole or in part.

4. The local board known as The Ontario Egg Producers' Marketing Board is continued.

5. The local board shall be composed of not more than fifteen producer-members, thirteen of whom shall be elected by egg producers and two of whom shall be elected by chicks-for-placement producers, who shall hold office until their successors are elected or appointed.

6. Producers are divided into thirteen districts as follows:

1. District 1, comprising the counties of Essex and Kent.

2. District 2, comprising the County of Lambton.

3. District 3, comprising the County of Middlesex.

4. District 4, comprising the counties of Elgin and Oxford and that part of The Regional Municipality of Haldimand-Norfolk that, on the 31st day of March, 1974, was the County of Norfolk.

5. District 5, comprising the county of Brant, the regional municipalities of Hamilton-Wentworth and Niagara and that part of The Regional Municipality of Haldimand-Norfolk that, on the 31st day of March, 1974, was the County of Haldimand.

6. District 6, comprising the County of Huron.

7. District 7, comprising the County of Perth and the townships of Wellesley and Wilmot in The Regional Municipality of Waterloo.

8. District 8, comprising the County of Wellington, the regional municipalities of Halton and Peel and the townships of North Dumfries and Woolwich and the City of Waterloo in The Regional Municipality of Waterloo.

9. District 9, comprising the counties of Bruce, Dufferin, Grey and Simcoe and The District Municipality of Muskoka.

10. District 10, comprising the counties of Hastings, Northumberland, Peterborough, Prince Edward and Victoria, the Provi-

- sional County of Haliburton and the regional municipalities of Durham and York.
11. District 11, comprising the counties of Dundas, Frontenac, Grenville, Lanark, Leeds, Lennox and Addington and Renfrew and The Regional Municipality of Ottawa-Carleton.
12. District 12, comprising the counties of Glengarry, Prescott, Russell and Stormont.
13. District 13, comprising the territorial districts of Ontario except The District Municipality of Muskoka.

7.—(1) The producers in each district mentioned in section 6 form a district group of producers.

(2) A producer in an area not included in a district mentioned in section 6 may become a member of the district group of producers nearest the producer's place of production.

8.—(1) There shall be a committee of producer-members in each district to be known as the District Egg Producers' Committee.

(2) The number of producers on each District Egg Producers' Committee shall be as follows:

1. District 1,	Essex	— 6 members
	Kent	— 6 members
	Total	— 12 members
2. District 2,	Total	— 11 members
3. District 3,	Total	— 17 members
4. District 4,	Elgin	— 4 members
	Oxford	— 9 members
	Norfolk	— 2 members
	Total	— 15 members
5. District 5,	Brant	— 2 members
	Hamilton-	
	Wentworth	— 3 members
	Niagara	— 6 members
	Haldimand	— 2 members
	Total	— 13 members
6. District 6,	Total	— 14 members
7. District 7,	Perth	— 8 members
	West Waterloo	— 5 members
	Total	— 13 members
8. District 8,	Wellington	— 6 members
	Halton	— 2 members
	Peel	— 1 member
	East Waterloo	— 3 members
	Total	— 12 members
9. District 9,	Bruce	— 3 members
	Dufferin	— 1 member
	Grey	— 3 members
	Simcoe and	
	Muskoka	— 3 members
	Total	— 10 members

10. District 10,	Hastings and	— 1 member
	Haliburton	
	Northumber-	— 2 members
	land	
	Ontario	— 2 members
	Peterborough	— 1 member
	Prince Edward	— 1 member
	Victoria and	
	Durham	— 2 members
	York	— 3 members
	Total	— 12 members
11. District 11,	Dundas	— 2 members
	Frontenac	— 1 member
	Grenville	— 2 members
	Lanark	— 1 member
	Leeds	— 1 member
	Lennox and	
	Addington	— 1 member
	Renfrew	— 1 member
	Ottawa-	
	Carleton	— 3 members
	Total	— 11 members
12. District 12,	Glengarry	— 2 members
	Prescott	— 7 members
	Russell	— 2 members
	Stormont	— 1 member
	Total	— 12 members
13. District 13,	Algoma	— 1 member
	Cochrane	— 1 member
	Kenora and	
	Rainy River	— 1 member
	Sudbury and	
	Timiskaming	— 1 member
	Thunder Bay	— 1 member
	Total	— 5 members

(3) There shall be a committee of producer-members in each district to be known as the District Chicks-for-Placement Producers' Committee.

(4) The number of producers on each District Chicks-for-Placement Producers' Committee shall be as follows:

- District 1 — one member.
- District 2 — two members.
- District 3 — three members.
- District 4 — one member.
- District 5 — four members.
- District 6 — two members.
- District 7 — two members.
- District 8 — three members.
- District 9 — one member.
- District 10 — one member.
- District 11 — one member.
- District 12 — one member.
- District 13 — one member.

9.—(1) On or before the 1st day of March in each year, the egg producers in each district shall, subject to subsection (2), elect from

among themselves members to each District Egg Producers' Committee on the basis referred to in subsection 8 (2).

(2) No egg producer is eligible to be elected a member of a District Egg Producers' Committee unless,

- (a) the egg producer has been allotted a basic quota for the production of eggs by the local board; or
- (b) the egg producer is a tenant and has been allotted a quota for the production of eggs by the local board.

(3) Members of District Egg Producers' Committees hold office from the 1st day of March in each year.

(4) The terms of office of members of each District Egg Producers' Committee expire on the last day of February of the year next following the year in which they were elected.

(5) No person is eligible to be elected a member of more than one District Egg Producers' Committee.

(6) Where an election has taken place that results in the contravention of subsection (5), the local board may declare void any election of a person necessary to prevent a contravention of the said subsection (5) and such election is thereupon wholly void and of no effect.

(7) On or before the 1st day of March in each year, the chicks-for-placement producers in each district shall, subject to subsection (8), elect from among themselves members to each District Chicks-for-Placement Committee on the basis referred to in subsection 8 (4).

(8) No chicks-for-placement producer is eligible to be elected a member of a District Chicks-for-Placement Producers' Committee unless the chicks-for-placement producer,

- (a) is the holder of a valid subsisting licence as a producer of chicks-for-placement issued by the local board;
- (b) is not engaged in the hatchery business;
- (c) is not the holder of a quota for the possession of fowl or the production of eggs;
- (d) is not engaged in the production of chicks-for-placement for breeding stock; and
- (e) is a producer of more than 500 chicks-for-placement per crop.

(9) Members of District Chicks-for-Placement Producers' Committees hold office from the 1st day of March in each year.

(10) The terms of office of members of each District Chicks-for-Placement Committee expire on the last day of February of the year next following the year in which they were elected.

(11) No person is eligible to be elected a member of more than one District Chicks-for-Placement Producers' Committee.

(12) Where an election has taken place that results in a contravention of subsection (11), the local board may declare void any election of a person necessary to prevent a contravention of the said subsection (11) and such election is thereupon wholly void and of no effect.

10.—(1) On or before the 1st day of April in each year, the members of each District Egg Producers' Committee shall elect from among themselves one person to be a member of the local board for the district.

(2) On or before the 1st day of April in each year, the members of the District Chicks-for-Placement Producers' Committees in Dis-

tricts 1 to 7, inclusive, shall elect from among themselves one person to be a member of the local board for those districts, and the members of the District Chicks-for-Placement Producers' Committees in Districts 8 to 13, inclusive, shall elect from among themselves one person to be a member of the local board for those districts.

(3) Members of the local board shall hold office from the 1st day of April in each year.

(4) The terms of office of members of the local board expire on the 31st day of March of the year next following the year in which they were elected.

11.—(1) Where the producers in any district fail to elect representatives to the District Egg Producers' Committee or the District Chicks-for-Placement Producers' Committee in accordance with section 9, the local board may, at its first meeting after the date for commencement of the terms of office of members of District Egg Producers' Committees or District Chicks-for-Placement Producers' Committees, appoint such eligible producers as are necessary to complete any District Egg Producers' Committee or District Chicks-for-Placement Producers' Committee.

(2) Where the members of a District Egg Producers' Committee or District Chicks-for-Placement Producers' Committee fail to elect a member to the local board in accordance with the provisions of section 10, the members of the local board shall, at its first meeting after the date for commencement of the terms of office of members of the local board, appoint such eligible producers as are necessary to complete the local board.

(3) Where a member elected or appointed to the local board dies or resigns before the member's term has expired, the members of the local board may appoint an eligible producer for the unexpired term.

(4) Where the members of the local board fail to appoint a person under subsection (2) or (3),

- (a) at the meeting referred to in subsection (2); or
- (b) within seven days of the death or resignation of a member,

as the case may be, the Commission may appoint a person for the unexpired term. R.R.O. 1980, Reg. 356, Sched.; O. Reg. 570/81, s. 1; O. Reg. 31/82, ss. 1-3; O. Reg. 430/83, s. 1, *revised*.

REGULATION 410

FRESH GRAPES—MARKETING

1. In this Regulation,

“fresh grapes” means grapes produced in Ontario, other than grapes that are used by a processor for processing;

“local board” means The Ontario Fresh Grape Growers' Marketing Board;

“plan” means The Ontario Fresh Grape Growers' Marketing Plan;

“processing” means the manufacture of grape products or juice, beverage, spirits or wine from grapes and includes bottling, distilling or fermenting with sugar or sulphur dioxide or any other chemical;

“processor” means a person engaged in the business of processing grapes;

“producer” means a person engaged in the production of fresh grapes. R.R.O. 1980, Reg. 360, s. 1.

2. This Regulation provides for the control and regulation in any or all respects of the producing and marketing within Ontario of

fresh grapes, including the prohibition of such producing and marketing in whole or in part. O. Reg. 692/84, s. 1.

POWERS OF LOCAL BOARD

3. The Commission delegates to the local board the power,
- (a) to require persons engaged in producing or marketing fresh grapes to register their names, addresses and occupations with the local board;
 - (b) to require persons engaged in producing or marketing fresh grapes to furnish such information relating to the production or marketing of fresh grapes, including the completing and filing of returns as the local board determines;
 - (c) to appoint persons to inspect the books, records, documents, lands and premises and any fresh grapes of persons engaged in the marketing of fresh grapes;
 - (d) to stimulate, increase and improve the marketing of fresh grapes by such means as it considers proper;
 - (e) to co-operate with a marketing board, local board, marketing commission or marketing agency of Canada or of any province in Canada for the purpose of marketing fresh grapes;
 - (f) to do such acts and make such orders and issue such directions as are necessary to enforce the due observance and carrying out of the Act, the regulations and the plan. R.R.O. 1980, Reg. 360, s. 3.
4. The Commission delegates to the local board its powers to make regulations with respect to fresh grapes,
- (a) providing for the licensing of any or all persons before commencing or continuing to engage in the producing or marketing of fresh grapes;
 - (b) prohibiting persons from engaging in the producing or marketing of fresh grapes except under the authority of a licence;
 - (c) providing for the refusal to grant a licence where the applicant is not qualified by experience, financial responsibility and equipment to engage in properly the business for which the application was made, or for any other reason that the local board considers proper;
 - (d) providing for the suspension or revocation of, or the refusal to renew, a licence for failure to observe, perform or carry out the Act, the regulations, the plan or any order or direction of the local board;
 - (e) providing for the fixing of licence fees payable yearly, half-yearly, quarterly or monthly at different amounts or in instalments from any or all persons producing or marketing fresh grapes and the collecting of the licence fees and the recovering of such licence fees by suit in a court of competent jurisdiction;
 - (f) prescribing the form of licences;
 - (g) providing for the exemption from any or all of the regulations, orders or directions under the plan of any class, variety, grade or size of fresh grapes, or any person or class of persons engaged in the producing or marketing of fresh grapes or any class, variety, grade or size of fresh grapes;
 - (h) requiring the furnishing of security or proof of financial responsibility from any person engaged in the marketing of fresh grapes and the disposition of any money or securities so furnished;

- (i) providing for the control and regulation of the marketing of fresh grapes, including the times and places at which fresh grapes may be marketed;
- (j) providing for the control and regulation of agreements entered into by producers of fresh grapes with persons engaged in marketing or processing fresh grapes, and the prohibition of any provision or clause in such agreements;
- (k) requiring any person who produces fresh grapes to offer to sell and to sell the fresh grapes through the local board;
- (l) prohibiting any person from packing or packaging any fresh grapes that have not been sold by or through the local board; and
- (m) providing for the making of agreements relating to the marketing of fresh grapes through the local board, and prescribing the forms and the terms and conditions of such agreements. R.R.O. 1980, Reg. 360, s. 4.

LICENCE FEES

5.—(1) The Commission authorizes the local board to use any class of licence fees, service charges and other money payable to it for the purposes of paying the expenses of the local board, carrying out and enforcing the Act and the regulations and carrying out the purposes of the plan.

(2) The Commission authorizes the local board to establish a fund in connection with the plan for the payment of money that may be required for the purposes mentioned in subsection (1). R.R.O. 1980, Reg. 360, s. 5.

POOLING

6. The Commission authorizes the local board to conduct a pool or pools for the distribution of all money received from the sale of fresh grapes and, after deducting all necessary and proper disbursements and expenses, to distribute the remainder of the money received from the sale in such manner that every producer receives a share of the remainder of the money received from the sale in relation to the amount, class, variety, grade or size of fresh grapes delivered by the producer, and authorizes the local board to make an initial payment on delivery of the fresh grapes and subsequent payments until all of the remainder of the money received from the sale is distributed to the producers. O. Reg. 692/84, s. 2.

APPOINTMENT OF AGENTS

7. The Commission authorizes the local board to appoint agents, to prescribe their duties and terms and conditions of employment and to provide for their remuneration. R.R.O. 1980, Reg. 360, s. 6.

MARKETING BY LOCAL BOARD

8.—(1) All fresh grapes shall be marketed by or through the local board.

(2) No person shall market fresh grapes except by or through the local board. R.R.O. 1980, Reg. 360, s. 7.

9.—(1) The Commission vests in the local board the following powers:

1. To direct and control, by order or direction, either as principal or agent, the marketing of fresh grapes including the times and places at which fresh grapes may be marketed.
2. To determine the quality of each class, variety, grade and size of fresh grapes that shall be marketed by each producer.

3. To prohibit the marketing of any class, variety, grade or size of fresh grapes.
4. To determine from time to time the price or prices that shall be paid to producers or to the local board, as the case may be, for fresh grapes or any class, variety, grade or size of fresh grapes and to determine the different prices for different parts of Ontario.
5. To fix and impose service charges from time to time for the marketing of fresh grapes.
6. To require the price or prices payable or owing to the producer for fresh grapes to be paid to or through the local board.
7. To collect from any person by suit in a court of competent jurisdiction the price or prices or any part thereof of fresh grapes.
8. To pay from service charges imposed under paragraph 5 its expenses in carrying out the purposes of the plan.
9. To pay to the producers the price or prices for fresh grapes, less service charges imposed under paragraph 5, and to fix the times at which or within which such payments shall be made. R.R.O. 1980, Reg. 360, s. 8.

(2) Each payment under paragraph 9 of subsection (1) shall be accompanied by a statement showing the varieties, grades of each variety and the quantity of each grade of fresh grapes sold, and the price or prices paid and the particulars of the service charges imposed by the local board. R.R.O. 1980, Reg. 360, s. 9.

REGULATION 411

FRESH GRAPES—PLAN

1. The plan in the Schedule is continued for the control and regulation of the marketing within Ontario of fresh grapes. R.R.O. 1980, Reg. 359, s. 1.

2. The local board named in the Schedule is given the powers set out in subsection 15 (1), in paragraphs 1, 2, 3, 4, 5, 6, 7, 8, 10, 11, 12, 13, 14, 15, 16, 17, 18, 19 and 26 of subsection 15 (2) and in sections 50 and 110 of the *Co-operative Corporations Act*. R.R.O. 1980, Reg. 359, s. 2.

3. The members of the local board shall be deemed to be the shareholders and directors thereof in the exercise of any of the powers mentioned in section 2. R.R.O. 1980, Reg. 359, s. 3.

Schedule

Farm Products Marketing Act

PLAN

1. This plan may be cited as "The Ontario Fresh Grape Growers' Marketing Plan".

2. In this plan,

"fresh grapes" means grapes produced in Ontario, other than grapes that are used by a processor for processing;

"processing" means the manufacture of grape products or juice, beverage, spirits or wine from grapes and includes bottling, distilling or fermenting with sugar or sulphur dioxide or any other chemical;

"processor" means a person engaged in the business of processing grapes;

"producer" means a person engaged in the production of fresh grapes.

3. This plan applies to the control and regulation in any or all respects of the marketing within Ontario of fresh grapes, including the prohibition of such marketing in whole or in part.

4. There shall be a local board to be known as "The Ontario Fresh Grape Growers' Marketing Board".

5. The local board shall be composed of seven producer-members.

6. Producers are divided into seven districts as follows:

1. District 1, consisting of the City of Niagara Falls, the City of Welland and the Town of Pelham.
2. District 2, consisting of the Town of Niagara-on-the-Lake.
3. District 3, consisting of the City of St. Catharines.
4. District 4, consisting of that part of the Town of Lincoln lying to the east of Road number 24 in The Regional Municipality of Niagara.
5. District 5, consisting of that part of the Town of Lincoln lying to the west of Road number 24 in The Regional Municipality of Niagara.
6. District 6, consisting of the Town of Grimsby and the Township of West Lincoln.
7. District 7, consisting of The Regional Municipality of Hamilton-Wentworth.

7.—(1) Producers in each of the districts named in section 6 form a district group.

(2) A producer in a municipality not included in a district mentioned in subsection (1) may become a member of the district group of producers nearest to the place of production.

8. There shall be a committee in each district to be known as the "District Fresh Grape Growers' Committee".

9. On or before the 15th day of March in each year, producers in each district shall elect from producers in the district one representative for each fifty producers or fraction thereof in the district to the District Fresh Grape Growers' Committee for the district.

10.—(1) On or before the 15th day of April in each year, each District Fresh Grape Growers' Committee may elect from the producers in the district one member to the local board.

(2) No person is eligible for election from any district to the local board unless he or she resides within the district.

(3) Where in any year, a District Fresh Grape Growers' Committee fails to elect a member to the local board in accordance with subsection (1), the members of all District Fresh Grape Growers' Committees may, on or before the 30th day of April of that year, elect a member from that district to the local board.

11.—(1) At its first meeting after the 30th day of April, the members elected to the local board shall appoint such producer-members as are necessary to complete the local board.

(2) When a member elected or appointed to the local board dies or resigns before the 30th day of April of the year next following the date of his or her election or appointment, the members of the local board may appoint a producer-member for the unexpired term.

(3) Each producer-member appointed as a member of the local board under subsection (1) or (2) shall be a producer in the district for which he or she is appointed.

(4) Where the members of the local board fail to appoint a person for the unexpired term of a member under subsection (2) within seven days from the death or resignation of the member, the Commission may appoint a person for the unexpired term. R.R.O. 1980 Reg. 359, Sched.

REGULATION 412

FRESH POTATOES—MARKETING

1. In this Regulation,

“fresh potatoes” means potatoes produced in Ontario other than potatoes that are used by a processor for processing or potatoes that are sold as certified seed;

“local board” means The Ontario Fresh Potato Growers’ Marketing Board;

“packer” means a person who packs fresh potatoes of a grade recognized under the *Farm Products Grades and Sales Act* or the *Canada Agricultural Products Act*;

“plan” means The Ontario Fresh Potato Growers’ Marketing Plan;

“processing” means,

- (a) canning, dehydrating, chipping, drying, freezing or processing with any chemical or by heat and combining or mixing potatoes with one or more other vegetables, or
- (b) entering into a contract for the purchase of potatoes for the purpose of performing on the potatoes any of the operations mentioned in clause (a);

“processor” means a person engaged in the business of processing fresh potatoes;

“producer” means a person engaged in the production of fresh potatoes;

“producer-packer” means a person who is engaged in the production of fresh potatoes and who packs fresh potatoes of a grade recognized under the *Farm Products Grades and Sales Act* or the *Canada Agricultural Products Act*. R.R.O. 1980, Reg. 362, s. 1.

2. This Regulation provides for the control and regulation in any or all respects of the producing and marketing within Ontario of fresh potatoes, including the prohibition of such producing and marketing in whole or in part. O. Reg. 506/85, s. 5.

3. The Commission exempts from this Regulation any person or persons who produce less than five acres of potatoes. R.R.O. 1980, Reg. 362, s. 3; O. Reg. 759/88, s. 1.

4. The Commission delegates to the local board the power,

- (a) to require persons engaged in producing or marketing fresh potatoes to register their names, addresses and occupations with the local board;
- (b) to require persons engaged in producing or marketing fresh potatoes to furnish such information relating to the production or marketing of fresh potatoes, including the completing and filing of returns, as the local board determines;
- (c) to appoint persons to,
 - (i) inspect the books, records, documents, lands and premises and any fresh potatoes of persons engaged in producing or marketing fresh potatoes,
 - (ii) to enter on lands or premises used for the producing

of any fresh potatoes and measure the area of land used to produce fresh potatoes;

(d) to stimulate, increase and improve the marketing of fresh potatoes by such means as it considers proper; and

(e) to co-operate with a marketing board, a local board, marketing commission or marketing agency of Canada or of any province of Canada for the purpose of marketing fresh potatoes. R.R.O. 1980, Reg. 362, s. 4; O. Reg. 759/88, s. 1.

5. The Commission delegates to the local board its powers to make regulations with respect to fresh potatoes,

- (a) providing for the licensing of any or all persons before commencing or continuing to engage in the producing or marketing of fresh potatoes;
- (b) prohibiting persons from engaging in the producing or marketing of fresh potatoes except under the authority of a licence;
- (c) providing for the suspension or revocation of, or the refusal to grant or renew, a licence where the applicant or licensee,
 - (i) is not qualified by experience, financial responsibility or equipment to properly engage in the business for which the application was made or the licence granted, or
 - (ii) has contravened the Act, the regulations, the plan or an order or direction of the Commission or local board;
- (d) providing for the fixing of licence fees and the payment thereof by any or all persons producing or marketing fresh potatoes and the collecting of the licence fees including recovery by suit in a court of competent jurisdiction;
- (e) prescribing the form of licences; and
- (f) providing for the control and regulation of agreements entered into by producers of fresh potatoes with persons engaged in marketing fresh potatoes and the prohibition of any provision or clause in such agreements. R.R.O. 1980, Reg. 362, s. 5; O. Reg. 526/81, s. 1; O. Reg. 759/88, ss. 1, 2.

6. Any producer-packer or packer who receives fresh potatoes shall deduct from the money payable for the fresh potatoes any licence fees payable to the local board by the person from whom the fresh potatoes are received and shall forward such licence fees to the local board. R.R.O. 1980, Reg. 362, s. 6.

7. Every producer and person engaged in the marketing of fresh potatoes shall pay to the local board interest on licence fees in arrears at the rate of 1.5 per cent per month. O. Reg. 759/88, s. 3.

8.—(1) The Commission authorizes the local board to use any licence fees and other money payable to it for the purposes of paying the expenses of the local board, carrying out and enforcing the Act and the regulations and carrying out the purposes of the plan. R.R.O. 1980, Reg. 362, s. 7 (1); O. Reg. 759/88, s. 1.

(2) The Commission authorizes the local board to establish a fund in connection with the plan for the payment of any money that may be required for the purposes mentioned in subsection (1). R.R.O. 1980, Reg. 362, s. 7 (2); O. Reg. 759/88, s. 1.

9. The Commission authorizes the local board to conduct a pool or pools for the distribution of all money received from the sale of fresh potatoes and, after deducting all necessary and proper disbursements and expenses, to distribute the remainder of the money received from the sale in such a manner that every producer receives

a share of the remainder of the money received from the sale in relation to the amount, class, variety, grade or size of fresh potatoes delivered by the producer, and authorizes the local board to make an initial payment on delivery of the fresh potatoes and subsequent payments until all of the remainder of the money received from the sale is distributed to the producers. O. Reg. 419/83, s. 1, *part*; O. Reg. 759/88, s. 1.

10. The Commission authorizes the local board to appoint agents, to prescribe their duties and terms and conditions of employment and to provide for their remuneration. O. Reg. 419/83, s. 1, *part*; O. Reg. 759/88, s. 1.

11. The Commission vests in the local board the following powers:

1. To direct and control, by order or direction, either as principal or agent, the producing and marketing of fresh potatoes including the times and places at which fresh potatoes may be produced and marketed.
2. To determine from time to time the price or prices that shall be paid to producers for fresh potatoes or any class, variety, grade or size of fresh potatoes and to determine different prices for different parts of Ontario. O. Reg. 419/83, s. 2; O. Reg. 759/88, ss. 1, 3.

12. There shall be three advisory committees to be known as the "Pricing Advisory Committee", the "Packing Advisory Committee" and the "Grading and Quality Advisory Committee". O. Reg. 526/81, s. 2, *part*.

13.—(1) The Pricing Advisory Committee shall be composed of fifteen members.

(2) The local board shall appoint, to the Pricing Advisory Committee,

- (a) seven persons to represent growers;
- (b) two persons to represent grower-packers;
- (c) three persons to represent packers; and
- (d) one person to represent brokers. O. Reg. 526/81, s. 2, *part*.

(3) The Commission shall appoint to the Pricing Advisory Committee,

- (a) one person to represent retailers; and
- (b) one person to represent consumers. O. Reg. 526/81, s. 2, *part*; O. Reg. 759/88, s. 1.

(4) The Pricing Advisory Committee is empowered to advise and make recommendations to the local board in respect of the price or prices that shall be paid to producers for fresh potatoes or any class, variety, grade or size of fresh potatoes. O. Reg. 526/81, s. 2, *part*.

14.—(1) The Packing Advisory Committee shall be composed of seven members.

(2) The local board shall appoint to the Packing Advisory Committee,

- (a) four persons to represent producers; and
- (b) three persons to represent packers.

(3) The Packing Advisory Committee is empowered to advise and make recommendations to the local board in respect of the terms of agreements entered into by producers of fresh potatoes with persons engaged in marketing fresh potatoes. O. Reg. 526/81, s. 2, *part*.

15.—(1) The Grading and Quality Advisory Committee shall be composed of ten members.

(2) The local board shall appoint to the Grading and Quality Advisory Committee four persons to represent producers. O. Reg. 526/81, s. 2, *part*.

(3) The Commission shall appoint to the Grading and Quality Advisory Committee,

- (a) one person to represent grower-packers;
- (b) one person to represent packers;
- (c) one person to represent retailers;
- (d) one person to represent consumers;
- (e) one person who is a potato extension specialist; and
- (f) one person who is a public servant in the Farm Products Quality Branch of the Ministry of Agriculture and Food. O. Reg. 526/81, s. 2, *part*; O. Reg. 759/88, s. 1.

(4) The Grading and Quality Advisory Committee is empowered to advise and make recommendations to the local board or to any person or organization represented on the committee in respect of the improvement of the quality of fresh potatoes. O. Reg. 526/81, s. 2, *part*.

16.—(1) The local board and the Commission shall appoint the members of the advisory committees referred to in section 12 after the 1st day of April and before the 30th day of April in every year. O. Reg. 526/81, s. 2, *part*; O. Reg. 759/88, s. 1, *revised*.

(2) Subject to subsections (3) and (4) the members of the advisory committees are and remain members thereof until the 30th day of April in the year following the year in which they are appointed. O. Reg. 526/81, s. 2, *part*.

(3) Where a member of an advisory committee dies or resigns or is unavailable to act before the expiration of his or her term, the local board or the Commission, as the case may be, shall appoint a person for the unexpired term of the member who died, resigned or was unavailable to act. O. Reg. 526/81, s. 2, *part*; O. Reg. 759/88, s. 1.

(4) Where the local board fails to appoint a member or members to an advisory committee, the Commission may appoint such members as are necessary to complete the advisory committee. O. Reg. 526/81, s. 2, *part*; O. Reg. 759/88, s. 1.

REGULATION 413

FRESH POTATOES—PLAN

1. The plan in the Schedule is continued for the control and regulation of the marketing within Ontario of fresh potatoes. R.R.O. 1980, Reg. 361, s. 1.

2. The local board named in the Schedule is given the powers set out in subsection 15 (1), in paragraphs 1, 2, 3, 4, 5, 6, 7, 8, 10, 11, 12, 13, 14, 15, 16, 17, 18, 19 and 26 of subsection 15 (2) and in sections 50 and 110 of the *Co-operative Corporations Act*. R.R.O. 1980, Reg. 361, s. 2.

3. The members of the local board named in the Schedule shall be deemed to be the shareholders and directors of the local board in the exercise of the powers vested in the local board under section 2. R.R.O. 1980, Reg. 361, s. 3.

Schedule

Farm Products Marketing Act

PLAN

1. This plan may be cited as "The Ontario Fresh Potato Growers' Marketing Plan".

2. In this plan,

"fresh potatoes" means potatoes produced in Ontario other than potatoes that are used by a processor for processing or potatoes that are sold as certified seed;

"packer" means a person who packs fresh potatoes of a grade recognized under the *Farm Products Grades and Sales Act* or the *Canada Agricultural Products Act*;

"processing" means,

(a) canning, dehydrating, chipping, drying, freezing or processing with any chemical or by heat and combining or mixing potatoes with one or more other vegetables, or

(b) entering into a contract for the purchase of potatoes for the purpose of performing on the potatoes any of the operations mentioned in clause (a);

"processor" means a person engaged in the business of processing fresh potatoes;

"producer" means a person engaged in the production of fresh potatoes;

"producer-packer" means a person who is engaged in the production of fresh potatoes and who packs fresh potatoes of a grade recognized under the *Farm Products Grades and Sales Act* or the *Canada Agricultural Products Act*.

3. This plan provides for the control and regulation in any or all respects of the marketing within Ontario of fresh potatoes including the prohibition of such marketing in whole or in part.

4. There shall be a local board to be known as "The Ontario Fresh Potato Growers' Marketing Board".

5.—(1) The local board shall be composed of nine producer-members.

(2) For the purpose of electing producer representatives to and eligibility to hold office as a member of the local board or a District Fresh Potato Growers' Committee under sections 9 to 13, a producer who is exempted from the application of Regulation 412 of Revised Regulations of Ontario, 1990 shall be deemed not to be a producer for the purpose of such election or eligibility.

6. Members of the local board shall be elected or appointed in accordance with the plan and shall hold office until their successors are elected or appointed.

7. Producers are divided into seven districts as follows:

1. District 1, comprising the counties of Essex and Kent.
2. District 2, comprising the counties of Elgin, Huron, Lambton, Middlesex and Perth.
3. District 3, comprising the counties of Brant and Oxford and the regional municipalities of Haldimand-Norfolk, Hamilton-Wentworth and Niagara.
4. District 4, comprising the counties of Bruce, Dufferin, Grey and Wellington and the regional municipalities of Halton, Peel and Waterloo.

5. District 5, comprising the County of Simcoe and The Regional Municipality of York.

6. District 6, comprising the counties of Dundas, Frontenac, Glengarry, Grenville, Hastings, Lanark, Leeds, Lennox and Addington, Northumberland, Peterborough, Prescott, Prince Edward, Renfrew, Russell, Stormont and Victoria, the Territorial District of Parry Sound, The District Municipality of Muskoka, the regional municipalities of Durham and Ottawa-Carleton and the Provisional County of Haliburton.

7. District 7, comprising the territorial districts of Algoma, Cochrane, Kenora, Manitoulin, Nipissing, Rainy River, Sudbury, Thunder Bay and Timiskaming.

8. Producers in each of the districts named in section 7 form a district group of producers.

9.—(1) There shall be a committee in each district to be known as the "District Fresh Potato Growers' Committee".

(2) The number of producer representatives on each District Fresh Potato Growers' Committee shall be determined on the basis of one representative for each twenty producers or fraction thereof.

10. On or before the 1st day of December in each year, the producers in each district shall elect representatives to the District Fresh Potato Growers' Committee.

11.—(1) On or before the 15th day of December in each year, the members of each District Fresh Potato Growers' Committee shall elect from among themselves members to the local board as follows:

1. District 1, one member.
2. District 2, one member.
3. District 3, one member.
4. District 4, one member.
5. District 5, three members.
6. District 6, one member.
7. District 7, one member.

(2) No person is eligible for election from any district to the local board unless he or she is a producer in the district.

(3) The terms of office of members of the local board expire on the 15th day of December in the year next following the date of their election or appointment.

12.—(1) Where in any year a District Fresh Potato Growers' Committee fails to elect one or more members to the local board in accordance with subsection 11 (1), the members of the local board shall, at its first meeting after the 15th day of December in that year, appoint such producer-members as are necessary to complete the local board.

(2) Where a member elected or appointed to the local board dies, resigns or otherwise ceases to be a member before the 15th day of December in the year next following the date of his or her election or appointment, the members of the District Fresh Potato Growers' Committee may, within fourteen days thereafter, appoint a producer-member for the unexpired term and in default of such appointment the local board shall appoint a producer-member for the unexpired term in the same manner as under subsection (1).

(3) Each producer-member appointed a member of the local board under subsection (1) or (2) shall be a producer eligible under subsection 11 (2). R.R.O. 1980, Reg. 361, Sched.

REGULATION 414**GRAPES FOR PROCESSING—MARKETING**

1. In this Regulation,

“grapes” means grapes produced in Ontario, except grapes used for any purpose other than processing by a processor;

“local board” means The Ontario Grape Growers’ Marketing Board;

“plan” means The Ontario Grape Growers’ Marketing-for-Processing Plan;

“processing” means the manufacture of grape products or juice, beverage spirits or wine from grapes and includes bottling, distilling or fermenting or processing with sugar or sulphur dioxide or any other chemical;

“processor” means a person engaged in the business of processing grapes;

“producer” means a person engaged in the production of grapes. R.R.O. 1980, Reg. 364, s. 1.

2. This Regulation provides for the control and regulation in any or all respects of the producing and marketing within Ontario of grapes, including the prohibition of such producing and marketing in whole or in part. O. Reg. 506/85, s. 6.

LICENCES

3.—(1) No person shall commence or continue to engage in the processing of grapes except under the authority of a licence as a processor of grapes in Form 2.

(2) No licence in Form 2 shall be issued except upon application thereof in Form 1.

(3) A licence in Form 2 expires with the 31st day of January next following the date on which the licence is issued.

(4) A licence in Form 2 shall be issued without charge. R.R.O. 1980, Reg. 364, s. 3.

4.—(1) The Commission may refuse to grant a licence where the applicant is not qualified by experience, financial responsibility and equipment to engage in properly the business for which the application was made, or for any other reason that the Commission considers proper.

(2) The Commission may suspend or revoke or refuse to renew a licence for failure to observe, perform or carry out the Act, the regulations, the plan or any order or direction of the Commission or the local board. R.R.O. 1980, Reg. 364, s. 4.

POWERS OF LOCAL BOARD

5. The Commission delegates to the local board the power,

- (a) to require persons engaged in producing or marketing grapes to register their names, addresses and occupations with the local board;
- (b) to require persons engaged in producing or marketing grapes to furnish such information relating to the production or marketing of grapes, including the completing and filing of returns as the local board determines;
- (c) to appoint persons to inspect the books, records, documents, lands and premises and any grapes of persons engaged in the marketing of grapes;

- (d) to stimulate, increase and improve the marketing of grapes by such means as it considers proper;
- (e) to co-operate with a marketing board, local board, marketing commission or marketing agency of Canada or of any province in Canada for the purpose of marketing grapes;
- (f) to do such acts and make such orders and issue such directions as are necessary to enforce the due observance and carrying out of the Act, the regulations and the plan. R.R.O. 1980, Reg. 364, s. 5.

6. The Ontario Farm Products Marketing Commission delegates to the local board its powers to make regulations with respect to grapes,

- (a) providing for the licensing of any or all persons other than processors before commencing or continuing to engage in the producing or marketing of grapes;
- (b) prohibiting persons other than processors from engaging in the producing or marketing of grapes except under the authority of a licence issued by the local board;
- (c) providing for the refusal to grant a licence where the applicant is not qualified by experience, financial responsibility and equipment to engage in properly the business for which the application was made, or for any other reason that the local board considers proper;
- (d) providing for the suspension or revocation of, or the refusal to renew, a licence for failure to observe, perform or carry out the Act, the regulations, the plan or any order or direction of the local board;
- (e) providing for the fixing of licence fees payable yearly, half-yearly, quarterly or monthly at different amounts or in instalments from any or all persons producing or marketing grapes other than processors and the collecting of the licence fees and the recovering of such licence fees by suit in a court of competent jurisdiction;
- (f) requiring any person who receives grapes to deduct from the money payable for the grapes any licence fees payable to the local board by the person from whom he, she or it receives the grapes, and to forward such licence fees to the local board;
- (g) requiring any person who produces and processes grapes to furnish to the local board statements of the amounts of grapes produced in any year and used for processing;
- (h) prescribing the form of licences;
- (i) requiring the furnishing of security or proof of financial responsibility by any person engaged in the marketing of grapes and providing for the administration and disposition of any money or securities so furnished;
- (j) providing for the control and regulation of the marketing of grapes, including the times and places at which grapes may be marketed;
- (k) providing for the control and regulation of agreements entered into by producers of grapes with persons engaged in marketing or processing grapes, and the prohibition of any provision or clause in such agreements;
- (l) requiring any person who produces and processes grapes to furnish to the local board statements of the amounts of grapes produced in any year and used for processing;
- (m) requiring any person who produces grapes to offer to sell and to sell the grapes through the local board;

- (n) prohibiting any person from processing, packing or packaging any grapes that have not been sold through the local board;
- (o) providing for the making of agreements relating to the marketing of grapes through the local board, and prescribing the forms and the terms and conditions of such agreements. R.R.O. 1980, Reg. 364, s. 6.

7.—(1) The Commission authorizes the local board to use any class of licence fees and other money payable to it, for the purposes of paying the expenses of the local board, carrying out and enforcing the Act and the regulations and carrying out the purposes of the plan.

(2) The Commission authorizes the local board to establish a fund in connection with the plan for the payment of any money that may be required for the purposes mentioned in subsection (1). R.R.O. 1980, Reg. 364, s. 7.

8. The Commission authorizes the local board to conduct a pool or pools for the distribution of all money received from the sale of grapes and, after deducting all necessary and proper disbursements and expenses, to distribute the remainder of the money received from the sale in such manner that every producer receives a share of the remainder of the money received from the sale in relation to the amount, class, variety, grade or size of the grapes delivered, and authorizes the local board to make an initial payment on delivery of the grapes and subsequent payments until all of the remainder of the money received from the sale is distributed to the producers. R.R.O. 1980, Reg. 364, s. 8.

9. The Commission authorizes the local board to require the price or prices payable or owing to the producers for grapes to be paid to or through the local board and to recover such price or prices by suit in a court of competent jurisdiction. R.R.O. 1980, Reg. 364, s. 9.

10. The Commission authorizes the local board to prohibit the marketing of any class, variety, grade or size of grapes. R.R.O. 1980, Reg. 364, s. 10.

11. The Commission vests in the local board the power to purchase or otherwise acquire such quantity or quantities of grapes as the local board considers advisable and to sell or otherwise dispose of any of the grapes so purchased or acquired. R.R.O. 1980, Reg. 364, s. 11.

APPOINTMENT OF AGENTS

12. The Commission authorizes the local board to appoint agents, to prescribe their duties and terms and conditions of employment and to provide for their remuneration. R.R.O. 1980, Reg. 364, s. 12.

NEGOTIATING AGENCIES

13.—(1) There shall be a negotiating agency to be known as "The Negotiating Committee for Grapes for Processing" composed of six persons, three of whom shall be appointed annually by the local board and three of whom shall be appointed annually by the processors.

(2) The local board and the processors shall appoint their respective members of The Negotiating Committee for Grapes for Processing and shall notify the Commission in writing of their names and addresses not later than the 1st day of August in each year.

(3) Subject to subsections (4) and (5), the members of the negotiating agency are and remain members until the 31st day of December of the year in which the members were appointed.

(4) Where a member of the negotiating agency dies or resigns or is unavailable to act before the expiration of his or her term of membership, the local board or the processors, as the case may be, who

appointed him or her shall appoint a person for the unexpired term of the member who died, resigned or was unavailable to act.

(5) Where the local board or the processors, as the case may be, fail to appoint the persons under subsection (2), the Commission shall appoint such persons as are necessary to complete the negotiating agency.

(6) Where the local board or the processors, as the case may be, fail to make an appointment under subsection (4) within seven days after a vacancy occurs, the Commission may appoint such persons as are necessary to complete the negotiating agency. R.R.O. 1980, Reg. 364, s. 13.

14. The Negotiating Committee for Grapes for Processing is empowered to adopt or settle by agreement minimum prices for grapes or for any class, variety, grade or size of grapes. R.R.O. 1980, Reg. 364, s. 14.

15. A meeting of the negotiating agency may be convened by a notice in writing given by the three members of the negotiating agency appointed by the local board, or by the processors, to the other members of the negotiating agency at least seven days, but not more than ten days, before the date of the meeting stating the time and place of the meeting. R.R.O. 1980, Reg. 364, s. 15.

ARBITRATION

16.—(1) Where a meeting of a negotiating agency is not held in accordance with the notice required by section 15, or where a meeting is held and the negotiating agency does not arrive at an agreement respecting all matters that it is empowered to adopt or settle by agreement, on or before the 20th day of August in any year, the matters in dispute shall be referred by the Commission to an Arbitration Board.

(2) Where a negotiating agency decides before the 20th day of August that an agreement on all matters that it is empowered to adopt or settle by agreement cannot be reached, it shall so notify the Commission.

(3) Where the negotiating agency does not arrive at an agreement under subsection (1) or (2), it may submit in writing to the Commission a statement or statements of the matters in dispute. R.R.O. 1980, Reg. 364, s. 16.

17.—(1) The Arbitration Board shall be composed of three members.

(2) One member may be appointed by the three members of the negotiating agency appointed by the local board and one other member may be appointed by the three members of the negotiating agency appointed by the processors.

(3) Where two members are appointed to the Arbitration Board in accordance with subsection (2), the two members so appointed may appoint a third member to the Arbitration Board, but, where the two members fail to agree on the third member within seven days after the Commission was notified under subsection 16 (2), or the 20th day of August, as the case may be, the Commission shall appoint the third member.

(4) Where the three members of the negotiating agency appointed by the local board or the three members of the negotiating agency appointed by the processors, as the case may be, fail to appoint a member to the Arbitration Board in accordance with subsection (2) within seven days after the Commission was notified under subsection 16 (2), or the 20th day of August, as the case may be, the Commission may appoint such members as are necessary to complete the Arbitration Board.

(5) The Commission shall submit to the Board of Arbitration any statement or statements of the matters in dispute received from the negotiating agency under subsection 16 (3).

(6) The Arbitration Board shall meet forthwith after the appointment of the three members thereof and shall make an award in respect of the matters referred to it, or all matters that the negotiating agency is empowered to adopt or settle by agreement, as the case may be. R.R.O. 1980, Reg. 364, s. 17.

ADVISORY COMMITTEE

18.—(1) There shall be an advisory committee to be known as "The Grapes for Processing Industry Advisory Committee" composed of a chair and eight members. R.R.O. 1980, Reg. 364, s. 18 (1).

(2) After the 1st day of April and before the 30th day of April in each year,

- (a) the Commission shall appoint the chair;
- (b) the local board shall appoint four members;
- (c) the Wine Council of Ontario shall appoint three members; and
- (d) the Ontario Food Processors Association shall appoint one member,

of The Grapes for Processing Industry Advisory Committee. R.R.O. 1980, Reg. 364, s. 18 (2); O. Reg. 189/85, s. 1 (1).

(3) Subject to subsections (4) and (5), the members of the Advisory Committee appointed under subsection (2) are and remain members thereof until the 30th day of April in the year next following the year in which they were appointed.

(4) Where a member of the Advisory Committee dies or resigns or is unavailable to act before the expiration of his or her term, the person or persons who appointed him or her shall appoint a person for the unexpired term of the member who died or resigned or was unavailable to act. R.R.O. 1980, Reg. 364, s. 18 (3, 4).

(5) Where the Wine Council of Ontario, the Ontario Food Processors Association, or the local board, as the case may be, fail to appoint a member or members to the Advisory Committee in accordance with subsection (2) or (4), the Commission may appoint such members as are necessary to complete the Advisory Committee. R.R.O. 1980, Reg. 364, s. 18 (5); O. Reg. 189/85, s. 1 (2).

(6) The Grapes for Processing Advisory Committee is empowered to advise and make recommendations to the local board, the Wine Council of Ontario, or to the Ontario Food Processors Association in respect of,

- (a) the promotion of harmonious relationships between persons engaged in the production and marketing of grapes for processing;
- (b) the promotion of greater efficiency in the production and marketing of grapes for processing;
- (c) the prevention and correction of irregularities and inequities in the marketing of grapes for processing;
- (d) the improvement of the quality and variety of grapes for processing;
- (e) the improvement of the circulation of market information respecting grapes for processing; and
- (f) without limiting the generality of any of the foregoing, any matter with respect to which the Commission or the local board may be empowered to make regulations under the Act. R.R.O. 1980, Reg. 364, s. 18 (6); O. Reg. 189/85, s. 1 (3).

Form 1

Farm Products Marketing Act

APPLICATION FOR LICENCE AS A PROCESSOR OF GRAPES

To: The Ontario Farm Products Marketing Commission:

.....
 (name of applicant)

 (address)

makes application for a licence as a processor of grapes under the *Farm Products Marketing Act*.

Dated at, this day of, 19.....

 (signature of applicant)

.....
 (where applicant is a corporation or partnership, signature of person authorized to sign)

.....
 (office)

R.R.O. 1980, Reg. 364, Form 1.

Form 2

Farm Products Marketing Act

LICENCE AS A PROCESSOR OF GRAPES

Under the *Farm Products Marketing Act* and the regulations and subject to the limitations thereof, this licence is issued to

.....
 (name)

 (address)

to engage in the processing of grapes.

This licence expires with the 31st day of January next following the date of issue.

Issued at Toronto, this day of, 19.....

THE ONTARIO FARM PRODUCTS MARKETING COMMISSION:

.....
 Chair

.....
 Secretary

R.R.O. 1980, Reg. 364, Form 2.

REGULATION 415

GRAPES FOR PROCESSING—PLAN

1. The plan in the Schedule is continued for the control and regulation of the marketing within Ontario of grapes. R.R.O. 1980, Reg. 363, s. 1.

2. The local board named in the Schedule is given the powers set out in subsection 15 (1), in paragraphs 1, 2, 3, 4, 5, 6, 7, 8, 10, 11, 12, 13, 14, 15, 16, 17, 18, 19 and 26 of subsection 15 (2) and in sections 50 and 110 of the *Co-operative Corporations Act*. R.R.O. 1980, Reg. 363, s. 2.

3. The members of the local board shall be deemed to be the shareholders and the directors thereof in the exercise of any of the powers mentioned in section 2. R.R.O. 1980, Reg. 363, s. 3.

Schedule

Farm Products Marketing Act

PLAN

1. This plan may be cited as "The Ontario Grape Growers' Marketing-for-Processing Plan".

2. In this plan,

"grapes" means grapes produced in Ontario, except grapes used for any purpose other than processing by a processor;

"processing" means the manufacture of grape products or juice, beverage spirits or wine from grapes and includes bottling, distilling or fermenting or processing with sugar or sulphur dioxide or any other chemical;

"processor" means a person engaged in the business of processing grapes;

"producer" means a person engaged in the production of grapes.

3. This plan applies to the control and regulation in any or all respects of the marketing within Ontario of grapes.

4. There shall be a local board to be known as "The Ontario Grape Growers' Marketing Board".

5. The local board shall be composed of seven producer-members.

6. Members of the local board shall be elected or appointed in accordance with the provisions of this plan and shall hold office until their successors are elected or appointed.

7.—(1) Producers are divided into the following four districts:

1. District 1, consisting of the Town of Niagara-on-the-Lake, in The Regional Municipality of Niagara.
2. District 2, consisting of the City of St. Catharines and the Judicial District of Niagara South, in The Regional Municipality of Niagara.
3. District 3, consisting of the Town of Lincoln, in The Regional Municipality of Niagara.
4. District 4, consisting of the Town of Grimsby and the Township of West Lincoln, in The Regional Municipality of Niagara and The Regional Municipality of Hamilton-Wentworth.

(2) A producer in an area of Ontario not included in a district mentioned in subsection (1) may become a member of the district group of producers nearest to his place of production.

8. Producers in each of the districts named in section 7 form a district group.

9. There shall be a committee which shall be known as "The Grape Growers' Committee".

10. On or before the 15th day of April in each year each district group shall elect representatives to The Grape Growers' Committee

on the basis of one representative for each thirty producers or fraction thereof.

11. On or before the 30th day of April in each year, The Grape Growers' Committee may elect producer-members to the local board from the districts mentioned in subsection 7 (1) on the following basis:

1. Two producer-members from District 1.
2. One producer-member from District 2.
3. Two producer-members from District 3.
4. One producer-member from District 4.
5. One producer-member as a director at large from any of the districts mentioned in subsection 7 (1).

12.—(1) If a district group fails to hold a meeting for the purpose mentioned in section 10 on or before the 15th day of April in any year, the Board shall fix a day as soon as is practicable for that purpose.

(2) If The Grape Growers' Committee fails to hold a meeting for the purposes mentioned in section 11 on or before the 30th day of April in any year, the Board shall fix a day as soon as is practicable for that purpose.

13.—(1) At its first meeting after the 30th day of April the members elected to the local board shall appoint such producer-members as are necessary to complete the local board.

(2) When a member elected or appointed to the local board dies or resigns before the 30th day of April of the year next following the date of his or her election or appointment, the members of the local board may appoint a producer-member for the unexpired term.

(3) Each producer-member appointed a member to the local board under subsection (1) or (2) shall be a producer in the district for which he or she is appointed. R.R.O. 1980, Reg. 363, Sched.; O. Reg. 478/90, s. 1.

REGULATION 416

GREENHOUSE VEGETABLES— APPOINTMENT OF TRUSTEE

1. In this Regulation, "board" means The Ontario Greenhouse Vegetable Producers' Marketing Board. O. Reg. 558/90, s. 1.

2. Coopers & Lybrand Limited is appointed to act as trustee of the board until the 31st day of October, 1991. O. Reg. 558/90, s. 2.

3. The trustee shall act as an interim administrator and has all the powers of the board except the power to determine the price to be paid to producers. O. Reg. 558/90, s. 3.

4. The members of the board in office on the 20th day of September, 1990 remain in office until the 31st day of October, 1991. O. Reg. 558/90, s. 4.

REGULATION 417

GREENHOUSE VEGETABLES—MARKETING

1. In this Regulation,

"greenhouse vegetables" means tomatoes, cucumbers and lettuce produced in Ontario in a greenhouse or any other enclosure under

glass, plastic or other material used for the purpose of controlling temperature and providing protection for the growing plants;

“local board” means The Ontario Greenhouse Vegetable Producers’ Marketing Board;

“plan” means The Ontario Greenhouse Vegetable Producers’ Marketing Plan;

“producer” means a person engaged in the production of greenhouse vegetables. R.R.O. 1980, Reg. 366, s. 1.

2. This Regulation provides for the control and regulation in any or all respects of the producing and marketing within Ontario of greenhouse vegetables, including the prohibition of such producing or marketing in whole or in part. O. Reg. 612/88, s. 2.

3. The Commission exempts from this Regulation, other than clauses 4 (a), (b) and (c),

- (a) lettuce produced in Ontario in a greenhouse or any other enclosure under glass, plastic or other material used for the purpose of controlling temperature and providing protection for the growing plants; and
- (b) persons engaged in the producing or marketing of lettuce mentioned in clause (a). R.R.O. 1980, Reg. 366, s. 3; O. Reg. 612/88, s. 1.

POWERS OF LOCAL BOARD

4. The Commission delegates to the local board the power,

- (a) to require persons engaged in producing or marketing greenhouse vegetables to register their names, addresses and occupations with the local board;
- (b) to require persons engaged in producing or marketing greenhouse vegetables to furnish such information relating to the production or marketing of the greenhouse vegetables including the completing and filing of returns as the local board determines;
- (c) to appoint persons to inspect the books, records, documents, lands and premises, and any greenhouse vegetables of persons engaged in producing or marketing greenhouse vegetables;
- (d) to stimulate, increase and improve the marketing of greenhouse vegetables by such means as it considers proper;
- (e) to co-operate with a marketing board, local board, marketing commission or marketing agency of Canada or of any province in Canada for the purpose of marketing greenhouse vegetables; and
- (f) to do such acts and make such orders and issue such directions as are necessary to enforce the due observance and carrying out of the Act, the regulations and the plan. R.R.O. 1980, Reg. 366, s. 4; O. Reg. 612/88, s. 1.

5. The Commission delegates to the local board its powers to make regulations with respect to greenhouse vegetables,

- (a) providing for the licensing of any or all persons before commencing or continuing to engage in the producing or marketing of greenhouse vegetables;
- (b) prohibiting persons from engaging in the producing or marketing of greenhouse vegetables except under the authority of a licence;
- (c) providing for the refusal to grant a licence where the applicant is not qualified by experience, financial responsibility and equipment to engage in properly the business for which

the application was made, or for any other reason that the local board considers proper;

- (d) providing for the suspension or revocation of, or the refusal to renew, a licence for failure to observe, perform or carry out the Act, the regulations, the plan or any order or direction of the Commission or local board;
- (e) providing for the fixing of licence fees payable yearly, half-yearly, quarterly or monthly at different amounts or in instalments from any or all persons producing or marketing greenhouse vegetables and the collecting of the licence fees and the recovering of such licence fees by suit in a court of competent jurisdiction;
- (f) prescribing the form of licences;
- (g) subject to section 3, providing for the exemption from any or all of the regulations, orders or directions under the plan of any class, variety, grade or size of greenhouse vegetables, or any person or class of persons engaged in the producing or marketing of greenhouse vegetables or any class, variety, grade or size of greenhouse vegetables;
- (h) requiring the furnishing of security or proof of financial responsibility by any person engaged in the marketing of greenhouse vegetables and providing for the administration and disposition of any money or securities so furnished;
- (i) providing for the control and regulation of the producing or marketing of greenhouse vegetables, including the times and places at which greenhouse vegetables may be produced and marketed;
- (j) providing for the control and regulation of agreements entered into by producers of greenhouse vegetables with persons engaged in marketing greenhouse vegetables, and the prohibition of any provision or clause in such agreements;
- (k) requiring any person who produces greenhouse vegetables to offer to sell and to sell the greenhouse vegetables to or through the local board;
- (l) prohibiting any person from packing or packaging any greenhouse vegetables that have not been sold to, by or through the local board; and
- (m) providing for the making of agreements relating to the marketing of greenhouse vegetables by or through the local board, and prescribing the forms and the terms and conditions of such agreements. R.R.O. 1980, Reg. 366, s. 5; O. Reg. 473/85, s. 2; O. Reg. 612/88, ss. 1, 3.

LICENCE FEES

6.—(1) The Commission authorizes the local board to use any class of licence fees, service charges and other money payable to it for the purposes of paying the expenses of the local board, carrying out and enforcing the Act and the regulations and carrying out the purposes of the plan. R.R.O. 1980, Reg. 366, s. 6 (1); O. Reg. 612/88, s. 1.

(2) The Commission authorizes the local board to establish a fund in connection with the plan for the payment of any money that may be required for the purposes mentioned in subsection (1). R.R.O. 1980, Reg. 366, s. 6 (2); O. Reg. 612/88, s. 1.

AGENTS

7. The Commission authorizes the local board to appoint agents, to prescribe their duties and terms and conditions of employment and to provide for their remuneration. R.R.O. 1980, Reg. 366, s. 7; O. Reg. 612/88, s. 1.

MARKETING BY LOCAL BOARD

8.—(1) All greenhouse vegetables shall be marketed by or through the local board.

(2) No person shall market greenhouse vegetables except by or through the local board. R.R.O. 1980, Reg. 366, s. 8.

9. The Commission vests in the local board the following powers:

1. To direct and control, by order or direction, either as principal or agent, the producing or marketing of greenhouse vegetables, including the times and places at which greenhouse vegetables may be produced or marketed.
 2. To determine the quality of each class, variety, grade and size of greenhouse vegetables that shall be marketed by each producer.
 3. To prohibit the marketing of any class, variety, grade or size of greenhouse vegetables.
 4. To determine from time to time the price or prices that shall be paid to producers or to the local board, as the case may be, for greenhouse vegetables or any class, variety, grade or size of greenhouse vegetables and to determine different prices for different parts of Ontario.
 5. To fix and impose service charges for the marketing of greenhouse vegetables.
 6. To require the price or prices payable or owing to the producer for greenhouse vegetables to be paid to or through the local board.
 7. To collect from any person by suit in a court of competent jurisdiction the price or prices or any part thereof of greenhouse vegetables.
 8. To pay from service charges imposed under paragraph 5 its expenses in carrying out the purposes of the plan.
 9. To pay to the producer the price or prices for greenhouse vegetables, less service charges imposed under paragraph 5, and to fix the times at which or within which such payments shall be made.
 10. To purchase or otherwise acquire such quantity or quantities of greenhouse vegetables as the local board deems advisable, and to sell or otherwise dispose of any greenhouse vegetables so purchased or acquired. R.R.O. 1980, Reg. 366, s. 9; O. Reg. 772/83, s. 1; O. Reg. 473/85, s. 3; O. Reg. 612/88, ss. 1, 4.
10. Each payment made under paragraph 9 of section 9 shall be accompanied by a statement showing the classes, varieties, grades of each variety and the quantity of each grade of greenhouse vegetables sold, and the price or prices paid and the particulars of the service charges imposed by the local board. R.R.O. 1980, Reg. 366, s. 11.

GREENHOUSE VEGETABLE INDUSTRY
ADVISORY COMMITTEE

11.—(1) In this section,

“retailer” means a person in Ontario engaged in the retail selling of greenhouse vegetables for consumption;

“shipper” means a person in Ontario engaged in purchasing greenhouse vegetables from the producers thereof for resale.

(2) There shall be a committee to be known as the “Greenhouse Vegetable Industry Advisory Committee”.

(3) The Greenhouse Vegetable Industry Advisory Committee

shall be composed of a chair and eight members. R.R.O. 1980, Reg. 366, s. 12 (1-3).

(4) After the 1st day of November and before the 30th day of November in each year,

- (a) the Commission shall appoint the chair;
- (b) the local board shall appoint four members;
- (c) the shippers shall appoint two members; and
- (d) the retailers shall appoint two members,

to the Greenhouse Vegetable Industry Advisory Committee. R.R.O. 1980, Reg. 366, s. 12 (4); O. Reg. 612/88, s. 1.

(5) Subject to subsection (6), the members of the Greenhouse Vegetable Industry Advisory Committee are and remain members thereof until the 30th day of November in the year next following the year in which they were appointed.

(6) Where a member of the Greenhouse Vegetable Industry Advisory Committee dies or resigns or is unavailable to act before the expiration of his or her term, the person or persons who appointed him or her shall appoint a person for the unexpired term of the member who dies, resigned or was unavailable to act. R.R.O. 1980, Reg. 366, s. 12 (5, 6).

(7) Where the person or persons who are required to appoint any member to the Greenhouse Vegetable Industry Advisory Committee fail to do so in accordance with subsection (3) or (5), the Commission may appoint such members as are necessary to complete the said committee. R.R.O. 1980, Reg. 366, s. 12 (7); O. Reg. 612/88, s. 1.

(8) The Greenhouse Vegetable Industry Advisory Committee may advise and make recommendations to the local board or to any person or organization represented on the committee in respect of,

- (a) the promotion of harmonious relationships between persons engaged in the production and marketing of greenhouse vegetables;
- (b) the promotion of greater efficiency in the production and marketing of greenhouse vegetables;
- (c) the prevention and correction of irregularities and inequities in the marketing of greenhouse vegetables;
- (d) the improvement of the quality and variety of greenhouse vegetables;
- (e) the improvement of the circulation of market information respecting greenhouse vegetables; and
- (f) without limiting the generality of any of the foregoing, any matter with respect to which the Commission or the local board may be empowered to make regulations under the Act. R.R.O. 1980, Reg. 366, s. 12 (8); O. Reg. 612/88, s. 1.

12. The local board shall forthwith provide the Commission with full particulars of any recommendations made to the local board by the Greenhouse Vegetable Industry Advisory Committee. R.R.O. 1980, Reg. 366, s. 13; O. Reg. 612/88, s. 1.

13. The Commission authorizes the local board to conduct a pool or pools for the distribution of all money received from the sale of greenhouse vegetables and after deducting all necessary and proper disbursements and expenses, to distribute the remainder of the money received from the sale in such manner that every producer receives a share of the remainder of the money received from the sale in relation to the amount, class, variety, grade or size of the greenhouse vegetables delivered by the producer, and authorizes the local board to make an initial payment on delivery of the greenhouse

vegetables and subsequent payments until all of the remainder of the money received from the sale is distributed to the producers. R.R.O. 1980, Reg. 366, s. 14; O. Reg. 612/88, s. 1.

REGULATION 418

GREENHOUSE VEGETABLES—PLAN

1. The plan in the Schedule is continued for the control and regulation of the producing and marketing within Ontario of greenhouse vegetables. O. Reg. 634/88, s. 1.

2. The local board named in the Schedule is given the powers set out in subsection 15 (1), in paragraphs 1, 2, 3, 4, 5, 6, 7, 8, 10, 11, 12, 13, 14, 15, 16, 17, 18, 19 and 26 of subsection 15 (2) and in sections 50 and 110 of the *Co-operative Corporations Act*. R.R.O. 1980, Reg. 365, s. 2.

3. The members of the local board shall be deemed to be the shareholders and the directors thereof in the exercise of any of the powers mentioned in section 2. R.R.O. 1980, Reg. 365, s. 3.

Schedule

Farm Products Marketing Act

PLAN

1. This plan may be cited as "The Ontario Greenhouse Vegetable Producers' Marketing Plan".

2. In this plan,

"greenhouse vegetables" means tomatoes, cucumbers and lettuce produced in Ontario in a greenhouse or any other enclosure under glass, plastic or other material used for the purpose of controlling temperature and providing protection for the growing plants;

"producer" means a person engaged in the production of greenhouse vegetables.

3. This plan applies to the control and regulation in any or all respects of the producing and marketing within Ontario of greenhouse vegetables, including the prohibition of such producing or marketing in whole or in part.

4. There shall be a local board to be known as "The Ontario Greenhouse Vegetable Producers' Marketing Board".

5. The local board shall be composed of eleven members who shall be elected or appointed in accordance with the provisions of this plan.

6. Producers are divided into four districts as follows:

1. District 1, comprising the County of Essex.
2. District 2, comprising the counties of Brant, Elgin, Kent, Lambton, Middlesex and Oxford and that part of The Regional Municipality of Haldimand-Norfolk that, on the 31st day of March, 1974, was the County of Norfolk.
3. District 3, comprising The Regional Municipality of Niagara and that part of The Regional Municipality of Haldimand-Norfolk that, on the 31st day of March, 1974, was the County of Haldimand.
4. District 4, comprising the County of Simcoe, the County of York as it existed on the 31st day of December, 1969, and the regional municipalities of Durham, Halton, Hamilton-Wentworth and Peel.

7. There shall be a committee in each district to be known as the "District Greenhouse Vegetable Producers' Committee".

8. Each District Greenhouse Vegetable Producers' Committee shall be composed of five members except that where there are more than 250 producers in a district, the Committee shall be composed of one member for each fifty producers or fraction thereof.

9. For the purposes of eligibility to hold office and for the purposes of voting to elect or appoint members to the local board or to a District Greenhouse Vegetable Producers' Committee, the following rules apply:

1. The producer must be an individual,
 - i. who produces greenhouse vegetables on his or her own account,
 - ii. who is designated in writing as the producer by the corporation, partnership or firm which produces the greenhouse vegetables on its own account, or
 - iii. who produces greenhouse vegetables with one or more persons on their own account and who presents himself or herself first to vote.
2. A producer in a part of Ontario not included in a district is deemed to be a producer in the district nearest to the producer's place of production.
3. A producer is eligible to be elected or appointed to the local board from a district only if the producer is or is deemed to be a producer in that district.
4. A producer may be a member of both the local board and a District Greenhouse Vegetable Producers' Committee.

10. On or before the 31st day of October in each year, the producers in each district shall elect the District Greenhouse Vegetable Producers' Committee from among the producers in the district.

11. On or before the 31st day of October in each year, the producers in each district shall elect from among the producers in the district members of the local board as follows:

1. District 1, five members.
2. District 2, two members.
3. District 3, two members.
4. District 4, two members.

12. Members of the local board and each District Greenhouse Vegetable Producers' Committee shall hold office from the date of their election or appointment until their successors are elected or appointed.

13.—(1) If the producers in a district fail to elect a member to the local board before the 1st day of November in any year, the District Greenhouse Vegetable Producers' Committee for that district may on or before the 15th day of November in that year appoint a producer from that district to be the member.

(2) The local board may appoint such producers as are necessary to fill any vacancies remaining on the local board after the 15th day of November.

14.—(1) If a member of the local board ceases to be a producer, resigns or is unable or unwilling to act, the local board shall declare the seat of the member vacant and appoint a producer to replace the member for the unexpired portion of the member's term.

(2) If the local board fails to fill any vacancy on the local board within seven days of the declaration referred to in subsection (1), the

Commission may appoint a producer to fill the vacancy for the unexpired portion of the term. O. Reg. 634/88, s. 2, *revised*.

REGULATION 419

HOGS—MARKETING

1. In this Regulation,

“hogs” means domestic swine produced in Ontario;

“local board” means The Ontario Pork Producers’ Marketing Board;

“plan” means the Ontario Pork Producers’ Marketing Plan;

“processing” means the slaughtering of hogs;

“processor” means a person who slaughters hogs or has hogs slaughtered and, for the purposes of sections 14 and 16, means a person who slaughters sows and boars;

“producer” means a producer engaged in the production of hogs;

“shipper of hogs” means a person who assembles hogs or transports hogs in any manner, but does not include,

- (a) a producer who transports in a vehicle owned by the producer only the hogs produced by the producer,
- (b) a person who is employed by and driving a vehicle owned by the holder of a licence as a shipper of hogs,
- (c) a railway company, or
- (d) a processor who bought the hogs under the plan and the regulations. R.R.O. 1980, Reg. 368, s. 1; O. Reg. 22/88, s. 1.

2. This Regulation provides for the control and regulation in any or all respects of the producing and marketing within Ontario of hogs, including the prohibition of such producing and marketing in whole or in part. O. Reg. 506/85, s. 7 (1).

3. The Commission exempts from this Regulation,

- (a) hogs marketed for any purpose except slaughter; and
- (b) hogs produced in the County of Haliburton and the territorial districts other than Cochrane and Timiskaming. R.R.O. 1980, Reg. 368, s. 3; O. Reg. 180/85, s. 1.

POWERS OF LOCAL BOARD

4. The Commission delegates to the local board the power,

- (a) to require persons engaged in the producing or marketing of hogs to register their names, addresses and occupations with the local board;
- (b) to require persons engaged in the producing or marketing of hogs to furnish such information in respect of hogs including the completing and filing of returns as the local board determines;
- (c) to appoint persons to inspect the books, records, documents, lands and premises and any hogs of persons engaged in marketing hogs;
- (d) to stimulate, increase and improve the marketing of hogs;
- (e) to co-operate with a marketing board, local board, marketing commission or marketing agency of Canada or any province in Canada for the purpose of marketing hogs;

- (f) to do such acts and make such orders and issue such directions as are necessary to enforce the due observance and carrying out of the Act, the regulations and the plan. R.R.O. 1980, Reg. 368, s. 4.

5. The Commission delegates to the local board its powers to make regulations with respect to hogs,

- (a) providing for the licensing of any or all persons before commencing or continuing to engage in the assembling, processing, shipping or transporting of hogs;
- (b) prohibiting persons from engaging in the assembling, processing, shipping or transporting of hogs except under the authority of a licence;
- (c) providing for the refusal to grant a licence where the applicant is not qualified by experience, financial responsibility and equipment to engage in properly the business for which the application was made, or for any other reason that the local board considers proper;
- (d) providing for the suspension or revocation of, or the refusal to renew, a licence for failure to observe, perform or carry out the Act, the regulations, the plan or any order or direction of the local board;
- (e) providing for the fixing of licence fees payable by any or all persons engaged in the assembling, processing, shipping or transporting of hogs;
- (f) prescribing the forms of licences;
- (g) requiring the furnishing of security or proof of financial responsibility by any person engaged in the marketing of hogs and providing for the administration and disposition of any money or securities so furnished;
- (h) providing for the control and regulation of the marketing of hogs, including the times and places at which hogs may be marketed;
- (i) requiring any person who produces and processes hogs to furnish to the local board statements of the amounts of hogs that the person produced in any year and used for processing;
- (j) requiring any person who produces hogs to offer to sell and to sell hogs through the local board;
- (k) prohibiting any person from processing, packing or packaging any hogs that have not been sold by or through the local board;
- (l) subject to section 3, providing for the exemption from any or all of the regulations, orders or directions under the plan of any class, variety or grade of hogs, or any person or class of persons engaged in the producing or marketing of hogs or any class, variety or grade of hogs; and
- (m) providing for the making of agreements relating to the marketing of hogs by or through the local board, and prescribing the forms and the terms and conditions of such agreements. R.R.O. 1980, Reg. 368, s. 5.

6.—(1) The Commission authorizes the local board to use any class of licence fees, service charges and other money payable to it, for the purposes of paying the expenses of the local board, carrying out and enforcing the Act and the regulations and carrying out the purposes of the plan.

(2) The Commission authorizes the local board to establish a fund in connection with the plan for the payment of any money that may be required for the purposes mentioned in subsection (1). R.R.O. 1980, Reg. 368, s. 6.

7. The Commission authorizes the local board to conduct a pool or pools for the distribution of all money received from the sale of hogs and, after deducting all necessary and proper disbursements and expenses, to distribute the remainder of the money received from the sale in such manner that every producer receives a share of the remainder of the money received from the sale in relation to the amount, class, variety, grade or size of hogs delivered by the producer, and authorizes the local board to make an initial payment on delivery of hogs and subsequent payments until all the remainder of the money received from the sale is distributed to the producers. R.R.O. 1980, Reg. 368, s. 7.

APPOINTMENT OF AGENTS

8. The Commission authorizes the local board to appoint agents, to prescribe their duties and terms and conditions of employment and to provide for their remuneration. R.R.O. 1980, Reg. 368, s. 8.

MARKETING BY LOCAL BOARD

9.—(1) All hogs shall be marketed by or through the local board.

(2) No person shall market hogs except by or through the local board. R.R.O. 1980, Reg. 368, s. 9.

POWERS OF LOCAL BOARD

10. The Commission vests in the local board the following powers:

1. To direct and control by order or direction either as principal or agent, the marketing of hogs, including the times and places at which hogs may be marketed.
2. To determine the quality of each class, variety, grade and size of hogs that shall be marketed by each producer.
3. To prohibit the marketing of any class, variety, grade or size of hogs.
4. To determine from time to time the price or prices that shall be paid to producers or to the local board, as the case may be, for hogs or for any grade of hogs and to determine different prices for different parts of Ontario.
5. To fix and impose service charges from time to time for the marketing of hogs.
6. To require the price or prices payable or owing to the producer for hogs to be paid to the local board.
7. To collect from any person by action in a court of competent jurisdiction the price or prices or any part thereof of hogs.
8. To pay to the producers the price or prices for hogs less service charges imposed under paragraph 5 and to fix the times at which or within which such payments shall be made. R.R.O. 1980, Reg. 368, s. 10 (1); O. Reg. 629/89, s. 1.

METHOD OF SALE

11. Where the local board sells hogs under the powers vested under section 10, the method or methods of selling hogs are subject to the following limitations:

1. Where the local board does not establish regular times and one or more regular places for the selling of the hogs, the local board shall give notice to every licensed processor of the time and place at which the hogs are to be sold so that the processors have a reasonable opportunity to bid at the time that each lot of hogs is offered for sale.
2. In the selling of the hogs, the local board shall offer lots of

hogs without discrimination in a manner that allows the processors to bid competitively on the hogs.

3. When hogs are sold, the buyer of the hogs shall be the processor who first bid the highest price bid at the sale.
4. The local board shall make and keep for at least one year a record of the sale of every lot of hogs sold showing,
 - i. the number of hogs in the lot,
 - ii. the location of the hogs at the time of the sale,
 - iii. the name and address of the buyer, and
 - iv. the price at which the hogs were sold. R.R.O. 1980, Reg. 368, s. 11.

STATEMENTS TO PRODUCERS

12. Each payment made under paragraph 8 of section 10 shall be accompanied by a statement showing the grades and quantity of each grade of hogs sold, the price or prices paid and the particulars of the service charges imposed by the local board. R.R.O. 1980, Reg. 368, s. 12.

ADVISORY COMMITTEE

13.—(1) There shall be an advisory committee to be known as "The Hog Industry Advisory Committee" composed of a chair and six members.

(2) After the 1st day of April and before the 30th day of April in each year,

- (a) the Commission shall appoint the chair;
- (b) the local board shall appoint the members;
- (c) the Ontario members of the Meat Packers Council of Canada shall appoint two members; and
- (d) the meat packers in Ontario who are not members of the Meat Packers Council of Canada shall appoint one member,

of the Advisory Committee.

(3) Subject to subsections (4) and (5), the members of the Advisory Committee appointed under subsection (2) are and remain members thereof until the 30th day of April in the year next following the year in which they were appointed.

(4) Where a member of the Advisory Committee dies or resigns or is unavailable to act before the expiration of his or her term, the person or persons who appointed the member shall appoint a person for the unexpired term of the member who died or resigned or was unavailable to act.

(5) Where the Ontario members of the Meat Packers Council of Canada, the meat packers in Ontario who are not members of the Meat Packers Council of Canada, or the local board, as the case may be, fail to appoint a member or members to the Advisory Committee in accordance with subsection (2) or (4), the Commission may appoint such members as are necessary to complete the Advisory Committee.

(6) The Advisory Committee is empowered to advise and make recommendations to the local board, the Meat Packers Council of Canada, or to the meat packers in Ontario who are not members of the Meat Packers Council of Canada in respect of,

- (a) the promotion of harmonious relationships between persons engaged in the production and marketing of hogs;

- (b) the promotion of greater efficiency in the production and marketing of hogs;
- (c) the prevention and correction of irregularities and inequities in the marketing of hogs;
- (d) the improvement of the quality and variety of hogs;
- (e) the improvement of the circulation of market information respecting hogs; and
- (f) without limiting the generality of any of the foregoing, any matter with respect to which the Commission or the local board may be empowered to make regulations under the Act. R.R.O. 1980, Reg. 368, s. 13.

SOWS AND BOARS

14.—(1) There shall be a negotiating agency to be known as the “Negotiating Committee for Sows and Boars”.

(2) The negotiating agency shall be composed of either two members or four members.

(3) Where the negotiating agency is composed of two members, the processors and the local board shall each appoint one member annually.

(4) Where the negotiating agency is composed of four members, the processors and the local board shall each appoint two members annually.

(5) The local board and the processors shall appoint their respective members to the negotiating agency and shall notify the Commission in writing of their names and addresses not later than the 31st day of December in each year.

(6) Subject to subsections (7) and (8), the members of the negotiating agency shall remain members until the 31st day of December of the year following the year in which they were appointed.

(7) Where a member of the negotiating agency dies, resigns or is unable or unwilling to act as a member, the local board or the processors who appointed the member shall appoint a person to replace the member for the unexpired part of the term.

(8) Where either the local board or the processors fail to make an appointment under subsection (7) within seven days after a vacancy occurs, the Commission shall appoint the members necessary to complete the negotiating agency.

(9) Where either the local board or the processors fail to make an appointment under subsection (3) or (4), the Commission shall appoint the members necessary to complete the negotiating agency. O. Reg. 22/88, s. 2, *part*.

15. The negotiating agency is empowered to adopt or settle by agreement,

- (a) minimum prices for sows and boars or for any class, variety, grade or size of sows and boars that are sold by the local board under paragraph 1 of section 10;
- (b) terms, conditions and forms of agreements relating to the producing or marketing of the sows and boars; and
- (c) any charges, costs or expenses relating to the production or marketing of the sows and boars. O. Reg. 22/88, s. 2, *part*.

16.—(1) The members of the negotiating agency appointed by the processors or by the local board may convene a meeting of the negotiating agency by giving written notice to the other members of the negotiating agency at least five days before the date of the meeting.

(2) The notice shall state the date, time and place of the meeting. O. Reg. 22/88, s. 2, *part*.

17.—(1) Where a meeting of the negotiating agency is not held in accordance with the notice given under section 16, or where a meeting is held and the negotiating agency does not arrive at an agreement respecting all matters that it is empowered to adopt or settle by agreement, the matters in dispute shall be referred by the Commission to an arbitration board.

(2) Where the negotiating agency does not arrive at an agreement respecting all matters that it is empowered to adopt or settle by agreement, it shall submit in writing to the Commission a statement of the matters in dispute and a statement of the final positions of the members of the negotiating agency. O. Reg. 22/88, s. 2, *part*.

18.—(1) An arbitration board shall be composed of one member.

(2) Subject to subsection (3), the member of the arbitration board shall be appointed by the members of the negotiating agency.

(3) Where the members of the negotiating agency cannot agree on a person to be appointed as the member of the arbitration board by the 7th day of April in any year, the Commission shall appoint the member of the arbitration board.

(4) Where the member of the arbitration board dies, resigns or is unable or unwilling to act as a member, the Commission shall appoint a person to replace the member.

(5) The Commission shall submit to the arbitration board any statement received from the negotiating agency under subsection 17 (2).

(6) The arbitration board shall make an award respecting matters not adopted or settled by agreement by the negotiating agency. O. Reg. 22/88, s. 2, *part*.

REGULATION 420

HOGS—PLAN

1. The plan in the Schedule is continued for the control and regulation of the producing and marketing of hogs within Ontario except that part thereof comprising the County of Haliburton and the territorial districts other than Cochrane and Timiskaming. O. Reg. 179/85, s. 1.

2. The local board named in the Schedule is given the powers set out in subsection 15 (1), in paragraphs 1, 2, 3, 4, 5, 6, 7, 8, 10, 11, 12, 13, 14, 15, 16, 17, 18, 19 and 26 of subsection 15 (2) and in sections 50 and 110 of the *Co-operative Corporations Act*. R.R.O. 1980, Reg. 367, s. 2.

3. The members of the local board shall be deemed to be the shareholders and the directors thereof in the exercise of any of the powers mentioned in section 2. R.R.O. 1980, Reg. 367, s. 3.

Schedule

Farm Products Marketing Act

PLAN

1. This plan may be cited as “The Ontario Pork Producers’ Marketing Plan”.

2. In this plan,

“county” includes a regional municipality and the area comprising the territorial districts of Cochrane and Timiskaming;

“hogs” means domestic swine produced in Ontario;

“processing” means the slaughtering of hogs;

“producer” means a person engaged in the production of hogs, and for the purpose of the nomination, election or appointment of persons under this plan means a person who is registered for such purposes.

3. This plan applies to the control and regulation in any or all respects of the producing and marketing within Ontario of hogs, including the prohibition of such producing and marketing in whole or in part.

4. There shall be a local board to be known as “The Ontario Pork Producers’ Marketing Board” to administer this plan.

5. The producers of hogs are divided into four areas as follows:

1. North Area, comprising the counties of Bruce, Grey, Huron, Perth and Wellington and The Regional Municipality of Waterloo.
2. Central Area, comprising the counties of Dufferin, Northumberland, Peterborough, Simcoe and Victoria, the regional municipalities of Durham, Halton, Peel and York and the territorial districts of Cochrane and Timiskaming.
3. South Area, comprising the counties of Brant, Elgin, Essex, Kent, Lambton, Middlesex and Oxford and the regional municipalities of Haldimand-Norfolk, Hamilton-Wentworth and Niagara.
4. East Area, comprising the counties of Dundas, Frontenac, Glengarry, Grenville, Hastings, Lanark, Leeds, Lennox and Addington, Prescott, Prince Edward, Renfrew, Russell and Stormont and The Regional Municipality of Ottawa-Carleton.

6. There shall be a council in each area to be known as “The Area Pork Producers’ Council”.

7. Each Area Pork Producers’ Council shall be composed of members who are producers of hogs in the counties of the area.

8.—(1) The nominal total membership for all Area Pork Producers’ Councils is 251 members of which,

- (a) one is allotted to the Timiskaming-Cochrane Pork Producers’ Association; and
- (b) 250 are allotted to the other County Pork Producers’ Associations.

(2) In each year, as soon as practicable after statistical information respecting the preceding year is available, the local board shall cause to be calculated the representation to be allotted to each County Pork Producers’ Association, other than the Timiskaming-Cochrane Pork Producers’ Association, on its respective Area Pork Producers’ Council.

(3) Each County Pork Producers’ Association, other than the Timiskaming-Cochrane Pork Producers’ Association, shall be allotted its proportionate share of 250 members based on that county’s proportionate share of the provincial total, calculated on a weighted basis of 60 per cent of the representation being based on the number of active producers in the county during the preceding year as a percentage of the provincial total and 40 per cent of the representation being based on the total number of hogs marketed from the county during the preceding year as a percentage of the provincial total.

(4) In those counties in which elections are scheduled in that year, the local board shall inform the County Pork Producers’ Association of the number of members on the Area Pork Producers’ Council allotted to that association prior to the meeting called under section 11.

9.—(1) No change in the number of members on an Area Pork Producers’ Council shall be made in any year in which there is no election of members to that Area Pork Producers’ Council regardless of whether or not the total number of members of all Area Pork Producers’ Councils is, by reason of such change not being made, other than 251.

(2) Upon expiry of the terms for which producer-members of the Area Pork Producers’ Councils were elected under section 9 of Regulation 367 of Revised Regulations of Ontario, 1980 as it read on July 1, 1991, their successors shall be elected for terms of three years.

(3) Election of producer-members of the Area Pork Producers’ Councils shall be by the methods set out in sections 10, 11, 12, 13, 14, 15, 16, 17, 18, 19, 20, 21, 22 and 23.

(4) No person shall be a member of an Area Pork Producers’ Council unless he or she is a producer of hogs in the county in which he or she resides and a member shall cease to be a member of an Area Pork Producers’ Council forthwith after ceasing to be a producer of hogs in the county in which he or she resides.

10.—(1) Subject to subsection (2), no person shall be nominated or elected to an Area Pork Producers’ Council or vote in an election of members to an Area Pork Producers’ Council unless he or she is registered as a producer of hogs with the local board.

(2) A producer who is not registered as a producer of hogs with the local board may apply for registration in the following Form, and if recognized by the Registrar or an assistant registrar as a producer for the year in which the nomination or election is to take place, may be nominated or elected to an Area Pork Producers’ Council or vote in an election of members to an Area Pork Producers’ Council:

Form

REGISTRATION OF PRODUCER FOR THE YEAR 19....

I hereby apply for registration as a producer of hogs on the farm located at Lot No., Conc. No., in the Township of, County of

Hogs are produced on the farm and I submit for examination by the Registrar the following settlement statement for hogs sold in my name during the past year under the Plan: No.

Date or I am qualified for registration as a producer by reason of qualification under Rule No. of the Rules stated below:

Date

 (signature)

.....
 (mailing address)

RULES FOR QUALIFICATION OF A PRODUCER

1. Hogs are produced on the property mentioned above and the applicant is the owner of the property and of the hogs.
2. Hogs are produced on the property mentioned above and the applicant is the tenant of the property and is the owner of the hogs.
3. Hogs are produced on the property mentioned above and the applicant has been designated in writing by a corporation, partnership or joint owners that sold hogs during the past year

under the plan as the person to be recognized as the producer by the Registrar.

4. Although hogs are not produced on the property at the time of this application, the applicant is the owner or tenant of the property and was a producer of hogs during the past year.

The applicant is recognized as a producer.

.....
(signature or initials of Registrar or Assistant Registrar)

- (3) The Registrar for,

- (a) a county other than the area comprising the territorial districts of Cochrane and Timiskaming shall be the Agricultural Representative appointed for the county; and
- (b) the area comprising the territorial districts of Cochrane and Timiskaming shall be the Agricultural Representative appointed for the District of Timiskaming.

(4) The Registrar for each county shall appoint such assistant registrars in the county as are required for the purpose of registration of producers in the county.

(5) The local board shall, not later than the 10th day of January in each year in which an election is required, furnish to each Agricultural Representative a supply of forms for registration of producers sufficient for the registration of producers who are not registered as such in the records of the local board.

11.—(1) The County Pork Producers' Association in each of the counties named in section 5 shall, not later than the fifteenth day of January, fix a place and date for the meeting of producers for the nomination in each county of the members and substitute members of the Area Pork Producers' Council.

(2) The date fixed under subsection (1) shall be not sooner than the 15th day of January or later than the 20th day of February in the same year.

(3) The time for the meeting shall be between 2 p.m. and 3 p.m. or between 8 p.m. and 9 p.m. on the date fixed.

(4) The County Pork Producers' Association shall notify the local board of the place and date of each meeting but, if the County Pork Producers' Association fails to notify the local board of the date and place of a meeting before the 5th day of February, the local board shall determine the date and place of the meeting and arrange the accommodation therefor.

12. At least ten days before the meeting, the County Pork Producers' Association shall give notice to the producers in each county of the day, time and place of the meeting,

- (a) in writing; or
- (b) by publication in one or more newspapers or periodicals having a general circulation among or distribution to producers,

but, where the County Pork Producers' Association fails to give the notice to producers in any county, the local board shall arrange for such publication or posting of notices as it considers necessary or advisable, at the expense of the local board.

13. If for any reason the nomination of members and substitute members to the Area Pork Producers' Council is not held on the date fixed, the local board shall fix a day as soon as is practicable for that purpose.

14.—(1) For the purpose of a nomination meeting and, where applicable, an election under subsection 16 (7), the registered producers of hogs present at the meeting shall elect a chair.

(2) The meeting shall be called to order by the chair.

15.—(1) If any objection is made at the meeting that any person nominated or present and taking part in the nominations is not a producer of hogs in the county, the chair may accept a majority decision of persons present at the meeting in respect of the objection and such decision upon acceptance by the chair is final.

(2) Every nomination shall be in writing, shall state the name and address of the nominee, shall be signed by the proposer and seconder, both of whom shall be producers of hogs in the county, and shall be filed with the chair within one hour after the opening of the meeting.

(3) Failure to comply with subsection (1) or (2) does not invalidate any nomination if it is received and accepted by the chair.

16.—(1) Where a proposed nominee is not present, his or her nomination paper is not valid unless the proposer and seconder confirm that the nominee consents to be so nominated.

(2) When the time for nomination at the meeting expires, the chair may require assurances from each nominee of his or her willingness to stand for election as a member or substitute member to the Area Pork Producers' Council from the county.

(3) Where the number of persons nominated and willing to stand for election as members and substitute members to the Area Pork Producers' Council is the number of persons mentioned in respect of the county in section 8 and the number of substitute members mentioned in subsection (8), the chair shall declare those persons elected as members and substitute members to the Area Pork Producers' Council.

(4) Where the number of persons nominated and willing to stand for election as members and substitute members to the Area Pork Producers' Council in respect of the county is fewer than the number of members mentioned for the county in section 8 and the number of substitute members mentioned for the county in subsection (8), the chair may extend the time for nominations for not more than one-half hour and if at the end of such extended time the number of persons nominated and willing to stand for election as members is fewer than or is the number of persons mentioned in respect of the county in section 8 or the number of persons nominated and willing to stand for election as substitute members is fewer than or is the number of persons mentioned in respect of the county in subsection (8), he or she shall then declare those persons to be members or substitute members, as the case may be, of the Area Pork Producers' Council for the county.

(5) Where the number of persons nominated and willing to stand for election as members mentioned in respect of a county in section 8 or substitute members mentioned in respect of a county under subsection (8), the chair shall prepare and post up at the meeting a list of names of the persons nominated at the meeting.

(6) The chair shall give each nominee at the meeting an opportunity to be identified.

(7) With the consent of the majority of the registered producers present at the meeting, the election to the Area Pork Producers' Council for the county shall be held at the meeting by secret ballot.

(8) Subject to subsection (9), with the consent of the majority of the registered producers present at the meeting substitute members may be elected to the Area Pork Producers' Council to serve during the absence of a member or members elected to the Area Pork Producers' Council under subsection (7) on the basis of one substitute member for every eight members elected thereto.

(9) Not fewer than one and not more than three substitute members may be elected from any county under subsection (8).

17.—(1) Where the majority of the registered producers of hogs present at the meeting do not consent to an election under subsection

16 (7), the first Tuesday in March is fixed as the day for the election in each county of the members of the Area Pork Producers' Council.

(2) The time of voting in an election under this section shall be from 11 a.m. to 6 p.m.

18.—(1) Where the number of persons nominated and willing to stand for election is more than the number of persons mentioned in respect of a county in section 8, the County Pork Producers' Association shall arrange for polling places as follows:

1. One polling place in each county mentioned in section 5 from which two members may be elected to the Area Pork Producers' Council.
2. At least one polling place but not more than two polling places in each county mentioned in section 5 from which three members may be elected to the Area Pork Producers' Council.
3. At least one polling place in each county in which more than three members may be elected to the Area Pork Producers' Council but not more polling places in each county than one for each three members or part thereof.
4. At least one polling place in each of the territorial districts of Cochrane and Timiskaming.

(2) The County Pork Producers' Association shall arrange accommodation for each polling place arranged under subsection (1) and not later than the 20th day of February shall notify the local board of the particulars of the accommodation arranged.

(3) Where the County Pork Producers' Association fails to notify the local board in accordance with subsection (2), the local board shall arrange the accommodation at the expense of the local board.

19. At least ten days before polling day the County Pork Producers' Association shall give notice to the producers of hogs in each county of the day, time and place of the election,

- (a) in writing; or
- (b) by publication in one or more newspapers or periodicals having a general circulation among or distribution to producers,

but, where the County Pork Producers' Association fails to give such notice to producers in any county, the local board shall arrange for such publication or posting of notices as it considers necessary or advisable.

20.—(1) The Commission shall appoint a Returning Officer for each county in which an election is to be held of the members of the Area Pork Producers' Council for that county.

(2) Where more than one polling place has been arranged in any county by the County Pork Producers' Association or the local board, as the case may be, the Returning Officer shall appoint a Deputy Returning Officer for each of the polling places in the county.

21.—(1) The Returning Officer shall arrange for,

- (a) a supply of ballot papers sufficient for the taking of the vote with the names of the nominees on each ballot paper;
- (b) ballot boxes;
- (c) compartments for voting; and
- (d) such other equipment and supplies as may be required for the taking of the vote.

(2) Each Returning Officer or Deputy Returning Officer shall

post up in each compartment printed directions for the guidance of voters in voting in the following Form:

Form

PRINTED DIRECTIONS FOR VOTERS IN VOTING

1. The voter will go into one of the compartments and, with the pencil provided in the compartment, place a mark opposite the name of each nominee for whom he or she desires to vote, but shall not mark the ballot paper for more nominations than the number of members and substitute members to be elected from the county in which he or she votes.
 2. The voter will then fold up the ballot paper so as to conceal the marks placed on the face of the ballot paper and shall then leave the compartment without delay and without showing the face of the ballot paper to anyone or so displaying it as to make known how he or she has marked it, and then deliver the ballot paper so folded to the Returning Officer or Deputy Returning Officer, as the case may be.
 3. If the voter inadvertently spoils a ballot paper, he or she may return it to the Returning Officer or Deputy Returning Officer, as the case may be, who will, if satisfied of such inadvertence, give the voter another ballot paper.
 4. If the voter places on the ballot paper any mark by which he or she may be afterwards identified or if the ballot paper has been torn, defaced or otherwise dealt with by the voter, so that he or she can thereby be identified, or if the voter marks the ballot paper for more nominees than the number of members or substitute members to be elected from the county in which he or she votes, it is void and will not be counted.
 5. No voter shall take a ballot paper out of the polling place or deposit anything in the ballot box.
- (3) The Returning Officer may appoint such persons as he or she considers necessary to assist him or her and the Deputy Returning Officers in the taking of the vote.
- (4) Every vote shall be by secret ballot.
- (5) No person shall apply for a ballot paper or vote who is not registered under subsection 10 (1) or (2) as a producer in the county in which he or she votes.
- (6) Upon receiving a ballot paper at a polling place the person receiving it shall vote in accordance with the printed directions for voting referred to in subsection (2).
- (7) The provisions of the printed directions to voters in subsection (2) have force and effect as part of this Regulation.

(8) The Deputy Returning Officer shall at once deposit the ballot paper in the ballot box in the presence of the voter without unfolding the ballot paper or in any way disclosing the marks made by the voter.

22.—(1) The Returning Officer or Deputy Returning Officer at a polling place may adjourn the voting for refreshments or other purposes and, where an adjournment is made, the ballot boxes shall be sealed and shall be kept in his or her custody and the sealing shall not be removed from the ballot boxes until the voting resumes.

(2) At 6 p.m., or so soon thereafter as the Returning Officer or Deputy Returning Officer is of the opinion that every person entitled to vote has been given an opportunity to cast a ballot, he or she may close the poll and proceed with the counting of the ballots.

23.—(1) The Returning Officer or Deputy Returning Officer shall count all the ballot papers in the presence of at least two producers of hogs known to him or her but shall reject all ballot papers,

- (a) that have not been supplied by him or her;
- (b) by which votes have been given for more nominees than are to be elected; or
- (c) upon which there is any writing or mark by which the voter can be identified, or that has been so torn, defaced or otherwise dealt with by the voter that he or she can thereby be identified,

and shall make a record of the number of votes given and allowed for each nominee.

(2) Each Deputy Returning Officer shall forthwith forward a copy of the record to the Returning Officer.

(3) The Returning Officer shall declare elected those nominees who obtained the largest number of votes up to the number of persons to be elected in respect of the county and shall notify elected nominees of their election.

(4) The Returning Officer shall retain the ballots and such other records as were furnished during the voting for such period of time as the Commission determines and shall forward to the Commission and the local board the names of the members elected to the Area Pork Producers' Council for the county.

(5) Where, by reason of a tie vote or other cause, the election of all members to an Area Pork Producers' Council from a county is not complete upon the counting of the ballots, the Commission may, by mail, submit to all producers who voted in the county a ballot to complete the election.

24.—(1) Where a member elected to an Area Pork Producers' Council ceases to be a producer or dies or resigns before his or her term of membership expires, the local board may appoint a producer in the county in which the vacancy occurred to complete the term of membership.

(2) Where a member elected to an Area Pork Producers' Council notifies the County Pork Producers' Association that he or she is temporarily unable to act as such member, the County Pork Producers' Association shall forthwith after receipt of the notice, furnish the local board with the name of a substitute member elected under subsection 16 (8) to act as a member of the Area Pork Producers' Council in the place of the member who is temporarily unable to act.

25. The local board shall be composed of fifteen producer-members.

26.—(1) The North Area Pork Producers' Council shall elect six producer-members to the local board.

(2) The Central Area Pork Producers' Council shall elect three producer-members to the local board.

(3) The East Area Pork Producers' Council shall elect two producer-members to the local board.

(4) The South Area Pork Producers' Council shall elect four producer-members to the local board.

(5) No person may be elected as a member of the local board unless he or she is a member of the Area Pork Producers' Council for the area in which he or she resides.

(6) No person shall be a member of the local board unless he or she is a producer of hogs in the area in which he or she resides and the member ceases to be a member of the local board forthwith after the member ceases to be a producer.

(7) Election of producer-members of the local board shall be by the method set out in section 27.

27.—(1) The local board shall fix a place, date and time for a

meeting of the members of an Area Pork Producers' Council and shall name a person to be the chair of each meeting of each Area Pork Producers' Council.

(2) The person named by the local board under subsection (1) shall conduct by secret ballot the election of the members to be elected to the local board by the Area Pork Producers' Council and shall forthwith after the election declare the persons elected who received the highest number of votes of the members of the Area Pork Producers' Council present and voting.

28.—(1) Each member elected to the local board under section 26 shall hold office for a term of three years.

(2) The term of office for a member elected to the local board begins on the 1st day of April in the year of his or her election and continues until the 31st day of March in the year in which his or her term of office expires.

(3) When a member elected to the local board ceases to be a producer or dies or resigns before his or her term of office expires, the Area Pork Producers' Council that elected him or her may elect a producer-member in the area to complete the term of office.

29.—(1) An election of a member to an Area Pork Producers' Council or of a member to the local board is not invalid by reason of,

- (a) non-compliance with the provisions of this plan as to the taking of a poll or anything preliminary thereto or as to the counting of the votes; or
- (b) a mistake or irregularity in the proceedings at or in relation to the election,

where it appears that the election was conducted in substantial conformity with the procedures laid down in sections 10 to 27 and it does not appear that such non-compliance, mistake or irregularity affected the result of the election of the member or substitute members.

(2) A decision of the Returning Officer or a Deputy Returning Officer, or of a Registrar or an Assistant Registrar or of a chair, under sections 10 to 27 is not open to question in respect of the validity of an election.

30.—(1) Where all or a majority of the members of the local board resign, the Commission may appoint at least three persons who shall constitute the local board and shall as soon as practicable,

- (a) take over and administer the affairs of the local board; and
- (b) conduct such elections of members of the local board as are necessary to replace the members who resigned.

(2) The Commission may at any time terminate the appointments of persons appointed by the Commission under subsection (1), and shall terminate their appointments upon the election of the successors to the members who resigned. R.R.O. 1980, Reg. 367, Sched.; O. Reg. 179/85, ss. 2-9; O. Reg. 93/88, s. 1, revised.

REGULATION 421

LOCAL BOARDS

1. Each local board shall within ten days after holding a meeting, excluding Saturdays and holidays, file with the Commission a copy of the minutes of the meeting. O. Reg. 322/83, s. 1.

2.—(1) Where the local board issues a direction or makes an order, regulation or policy statement, the local board shall within five days of issuance or making, excluding Saturdays and holidays, file with the Commission a true copy of the direction, order, regulation or policy statement. O. Reg. 322/83, s. 2.

(2) The local board shall file with the Commission a true copy of the index to the local board's regulations and, where the local board amends a regulation, the local board shall within five days of amendment, excluding Saturdays and holidays, file with the Commission a true copy of the amended page or pages of the index. O. Reg. 284/85, s. 1.

3. Where a local board receives a copy of any agreement or award filed with the Commission and an order of the Commission under subsection 7 (4) of the Act declaring the agreement or award or part thereof in force, the local board shall file with its secretary the copy of the agreement or award and the order made by the Commission. R.R.O. 1980, Reg. 369, s. 3.

4. Within four months after the close of the fiscal year of a local board, the local board shall file with the Commission a true copy of all reports of its operations in the fiscal year. R.R.O. 1980, Reg. 369, s. 4.

5.—(1) Each local board shall file with the Commission a true copy of the annual financial statement and audited report for each fiscal year of the local board within ten days, excluding Saturdays and holidays, after the local board receives the audited report. O. Reg. 322/83, s. 3.

(2) The annual financial statement of a local board shall include the amount of each grant or other like payment of money made by the local board to any person or association or body of persons during the fiscal year and the name of the person or association or body of persons to whom the grant or other like payment of money was made. R.R.O. 1980, Reg. 369, s. 5 (2).

6. Where a local board appoints an agent, the local board shall file with the Commission a true copy of the appointment and the terms thereof within twenty-one days after the appointment is made. R.R.O. 1980, Reg. 369, s. 6.

7. Where the Commission requires from a local board true copies of statements and reports other than those provided for in sections 1, 2, 3, 4, 5 and 6, the local board shall, as soon as is practicable, but not later than thirty days from the date that the request is received from the Commission, file with the Commission true copies of the statements and reports. R.R.O. 1980, Reg. 369, s. 7.

8. Subject to section 9, within four months after the end of its fiscal year, each local board shall furnish to the producers of the regulated product during the fiscal year copies of the annual statement of operations and the financial report of the local board. R.R.O. 1980, Reg. 369, s. 8.

9. Where, within four months of the close of its fiscal year, a local board publishes in one issue of at least one edition of a newspaper or magazine having a general circulation among its producers its annual statement of operations and its financial report, the local board is not required to comply with section 8. R.R.O. 1980, Reg. 369, s. 9.

REGULATION 422

POTATOES—MARKETING

1. In this Regulation,

“Fund” means the Fund for Producers of Potatoes established under the *Farm Products Payments Act*;

“local board” means The Ontario Potato Growers' Marketing Board;

“plan” means The Ontario Potato Growers' Marketing-for-Processing Plan;

“potatoes” means potatoes produced in Ontario and used or intended to be used for processing;

“processing” means,

- (a) canning, dehydrating, chipping, drying, freezing or peeling,
- (b) adding a substance or heat,
- (c) combining or mixing with another vegetable, or
- (d) entering into a contract for the purchase of potatoes;

“processor” means a person engaged in the business of processing potatoes;

“producer” means a person engaged in the production of potatoes. R.R.O. 1980, Reg. 371, s. 1; O. Reg. 272/89, s. 1.

2. This Regulation provides for the control and regulation in any or all respects of the producing and marketing within Ontario of potatoes, including the prohibition of such producing and marketing in whole or in part. O. Reg. 506/85, s. 8.

3.—(1) The Commission exempts from this Regulation, other than clauses 11 (a), (b) and (c), small whole potatoes processed by canning or freezing. R.R.O. 1980, Reg. 371, s. 3; O. Reg. 291/88, s. 1.

(2) A processor is exempt from section 4 in respect of potatoes processed on the processor's premises and sold directly to the consumer from those premises. O. Reg. 272/89, s. 2.

4.—(1) No person shall commence or continue to engage in the processing of potatoes except under the authority of a licence from the Director and except in compliance with the terms and conditions of the licence. O. Reg. 291/88, s. 2, *part*; O. Reg. 272/89, s. 4, *part*.

(2) A licence expires on the 31st day of January following the date on which it was issued. O. Reg. 291/88, s. 2, *part*.

(3) Where the Director issues a licence to a processor, the Director shall not charge a licence fee to the processor. O. Reg. 291/88, s. 2, *part*; O. Reg. 272/89, s. 4, *part*.

5. A licence is issued on the condition that the licensee,

- (a) where any payment is made from the Fund to a producer under the *Farm Products Payments Act* and the regulations thereunder, complies with those regulations regarding repayment; and
- (b) complies with the regulations under the *Farm Products Payments Act* respecting,
 - (i) the payment of fees to the board constituted to administer the Fund, and
 - (ii) the collection of fees and forwarding them to The Ontario Potato Growers' Marketing Board. O. Reg. 272/89, s. 3.

6. The Director may refuse to grant or renew a licence or may suspend or revoke a licence,

- (a) where the applicant or licensee is not qualified by experience, financial responsibility or equipment to properly engage in the business for which the application was made or the licence granted; or
- (b) where the applicant or licensee has failed to comply with or has contravened the Act, the regulations, the plan or any order or direction of the Director. O. Reg. 291/88, s. 2, *part*; O. Reg. 272/89, s. 4, *part*.

7. The Director may impose such terms and conditions upon a

licence as the Director considers proper. O. Reg. 291/88, s. 2, *part*;
O. Reg. 272/89, s. 4, *part*.

8. Where, after a hearing, the Director is of the opinion that the applicant or licensee has failed to comply with or has contravened any term or condition of the licence or the Act, the regulations, the plan or any order or direction of the Director, the Director may impose a penalty on the applicant or licensee. O. Reg. 291/88, s. 2, *part*; O. Reg. 272/89, s. 4, *part*.

9.—(1) The Director may require that a processor furnish a performance bond that shall not exceed 10 per cent of the price payable to producers for potatoes processed during the immediately preceding twelve-month period by the processor. O. Reg. 291/88, s. 2, *part*; O. Reg. 272/89, s. 4, *part*.

(2) The Director may determine that the performance bond is forfeited when the processor who furnished the bond fails to comply with or contravenes any term or condition of the processor's licence or the Act, the regulations, the plan or any order or direction of the Director. O. Reg. 291/88, s. 2, *part*; O. Reg. 272/89, s. 4, *part*.

10.—(1) If a penalty is imposed under section 8 or a performance bond is forfeited under subsection 9 (2), the Director shall pay the penalty or the proceeds of the performance bond, or both, to the local board for distribution proportionately among the producers of potatoes who sold potatoes to the processor and who did not receive the minimum price for the potatoes. O. Reg. 291/88, s. 2, *part*; O. Reg. 272/89, s. 4, *part*.

(2) If there are no producers as described in subsection (1), the Director shall pay the penalty or the proceeds of the performance bond, or both, into the Consolidated Revenue Fund. O. Reg. 291/88, s. 2, *part*; O. Reg. 272/89, s. 4, *part*.

11. The Commission delegates to the local board power,

- (a) to require persons engaged in producing or marketing potatoes to register their names, addresses and occupations with the local board;
- (b) to require persons engaged in producing or marketing potatoes to furnish such information relating to the production or marketing of potatoes, including the completing and filing of returns, as the local board determines;
- (c) to appoint persons to inspect the books, records, documents, lands and premises and any potatoes of persons engaged in producing or marketing potatoes;
- (d) to stimulate, increase and improve the marketing of potatoes by such means as it considers proper;
- (e) to co-operate with a marketing board, local board, marketing commission or marketing agency of Canada or any province in Canada for the purpose of marketing potatoes;
- (f) to do such acts and make such orders and issue such directions as are necessary to enforce the due observance and carrying out of the Act, the regulations or the plan. R.R.O. 1980, Reg. 371, s. 6; O. Reg. 291/88, s. 1.

12. Every producer and person engaged in the marketing of potatoes shall pay to the local board interest on licence fees and service charges in arrears at the rate of 1.5 per cent per month. O. Reg. 760/88, s. 1.

13. The Commission delegates to the local board its powers to make regulations with respect to potatoes,

- (a) providing for the licensing of any or all persons before commencing or continuing to engage in the producing or marketing of potatoes;

- (b) prohibiting persons from engaging in the producing or marketing of potatoes except under the authority of a licence;
- (c) providing for the suspension or revocation of, or the refusal to grant or renew, a licence where the applicant or licensee,
 - (i) is not qualified by experience, financial responsibility or equipment to properly engage in the business for which the application was made or the licence granted, or
 - (ii) has contravened the Act, the regulations, the plan or an order or direction of the Commission or local board;
- (d) providing for the fixing of licence fees and the payment thereof by any or all persons producing or marketing potatoes and the collecting of the licence fees including recovery by suit in a court of competent jurisdiction;
- (e) requiring any person who receives potatoes to deduct from the money payable for the potatoes any licence fees payable to the local board by the person from whom the person receives the potatoes, and to forward such licence fees to the local board;
- (f) requiring any person who produces and processes potatoes to furnish to the local board statements of the amounts of the potatoes that the person produced in any year and used for processing;
- (g) prescribing the form of licences;
- (h) subject to section 3, providing for the exemption from any or all of the regulations, orders or directions under the plan of any class, variety, grade or size of potatoes, or any person or class of persons engaged in the producing or marketing of potatoes or any class, variety, grade or size of potatoes;
 - (i) providing for the control and regulation of the marketing of potatoes, including the times and places at which potatoes may be marketed;
 - (j) requiring any person who produces potatoes to offer to sell and to sell the potatoes through the local board; and
 - (k) prohibiting any person from processing, packing or packaging any potatoes that have not been sold through the local board. R.R.O. 1980, Reg. 371, s. 7; O. Reg. 291/88, s. 1; O. Reg. 760/88, s. 2.

14.—(1) The Commission authorizes the local board to use any class of licence fees and other money payable to it for the purpose of paying the expenses of the local board, carrying out and enforcing the Act and the regulations and carrying out the purposes of the plan. R.R.O. 1980, Reg. 371, s. 8 (1); O. Reg. 291/88, s. 1.

(2) The Commission authorizes the local board to establish a fund in connection with the plan for the payment of any money that may be required for the purposes mentioned in subsection (1). R.R.O. 1980, Reg. 371, s. 8 (2); O. Reg. 291/88, s. 1.

15. The Commission authorizes the local board to require the price or prices payable or owing to producers for potatoes to be paid to or through the local board. R.R.O. 1980, Reg. 371, s. 9; O. Reg. 291/88, s. 1.

16. The Commission authorizes the local board to prohibit the marketing of any class, variety, grade or size of potatoes. R.R.O. 1980, Reg. 371, s. 10; O. Reg. 291/88, s. 1.

17.—(1) There shall be a committee to be known as "The Potato Industry Advisory Committee".

(2) The Potato Industry Advisory Committee shall be composed of a chair and not fewer than six members. R.R.O. 1980, Reg. 371, s. 11 (1, 2).

(3) After the 1st day of November and before the 30th day of November in each year,

- (a) the Commission shall appoint the chair;
- (b) the processors shall appoint not fewer than three members; and
- (c) the local board shall appoint, from among its members, a number of members equal to the number appointed under clause (b),

to The Potato Industry Advisory Committee. R.R.O. 1980, Reg. 371, s. 11 (3); O. Reg. 291/88, s. 1.

(4) Subject to subsections (3) and (6), the members of The Potato Industry Advisory Committee hold office until the 30th day of November in the year following the year in which they are appointed.

(5) Where a member of The Potato Industry Advisory Committee dies or resigns or is unavailable to act before the expiration of his or her term of office, the processors or the local board, as the case may be, shall appoint a person for the unexpired term of the member who died, resigned or was unavailable to act. R.R.O. 1980, Reg. 371, s. 11 (4, 5).

(6) Where the processors or the local board, as the case may be, fail to appoint a member or members to The Potato Industry Advisory Committee in accordance with subsection (3) or (5), the Commission may appoint such members as are necessary to complete the said committee. R.R.O. 1980, Reg. 371, s. 11 (6); O. Reg. 291/88, s. 1.

(7) The Potato Industry Advisory Committee may make recommendations to the local board in respect of,

- (a) the promotion of harmonious relationships between persons engaged in the production and marketing of potatoes;
- (b) the promotion of greater efficiency in the production and marketing of potatoes;
- (c) the prevention and correction of irregularities and inequities in the marketing of potatoes;
- (d) the improvement of the circulation of market information respecting potatoes;
- (e) without limiting the generality of the foregoing, any matter with respect to which the Commission or the local board may be empowered to make regulations under the Act respecting potatoes. R.R.O. 1980, Reg. 371, s. 11 (7); O. Reg. 291/88, s. 1.

18.—(1) In this section,

“potatoes for chips” means potatoes used to produce potato chips;

“potatoes for dehydration” means potatoes used to produce dehydrated potatoes;

“potatoes for frozen french fries” means potatoes used to produce frozen french fries;

“potatoes for soups and stews” means potatoes used to produce soups or stews;

“potatoes for unfrozen pre-cooked french fries” means potatoes used to produce unfrozen pre-cooked french fries;

“prepeeled potatoes” means potatoes that are prepeeled and used to produce products other than those mentioned in the above definitions.

(2) There shall be negotiating agencies appointed for each class of potatoes to be known as,

- (a) “The Negotiating Committee for Potatoes for Chips”;
- (b) “The Negotiating Committee for Potatoes for Dehydration”;
- (c) “The Negotiating Committee for Potatoes for Frozen French Fries”;
- (d) “The Negotiating Committee for Potatoes for Soups and Stews”;
- (e) “The Negotiating Committee for Potatoes for Unfrozen Pre-cooked French Fries”; and
- (f) “The Negotiating Committee for Prepeeled Potatoes”. O. Reg. 195/86, s. 1 (1).

(3) Each negotiating agency named in subsection (2) shall be composed of six persons, of whom three shall be appointed by the local board and three shall be appointed by the processors who purchase potatoes for the purpose for which the negotiating agency is established. R.R.O. 1980, Reg. 371, s. 12 (2); O. Reg. 195/86, s. 1 (2); O. Reg. 291/88, s. 3 (1).

(4) The local board and the processors shall appoint their respective members to the negotiating agencies named in subsection (2) and shall notify the Commission in writing of their names and addresses not later than the 10th day of January in every year. R.R.O. 1980, Reg. 371, s. 12 (3); O. Reg. 195/86, s. 1 (3); O. Reg. 291/88, ss. 1, 3 (2).

(5) Subject to subsections (6) and (7), the members of the negotiating agencies appointed under this section are and remain members until the 31st day of December of the year in which the members were appointed.

(6) Where a member of a negotiating agency appointed under this section dies or resigns or is unavailable to act before the expiration of his or her term of membership, the local board or the processors, as the case may be, who appointed him or her shall appoint a person for the unexpired term of the member who died, resigned or was unavailable to act. R.R.O. 1980, Reg. 371, s. 12 (4, 5).

(7) Where the local board or the processors, as the case may be, fails to make an appointment, in the case of an appointment referred to in subsection (4) in any year by the 10th day of January or, in the case of an appointment referred to in subsection (6), within seven days after a vacancy occurs, the Commission shall appoint such persons as are necessary to complete the negotiating agency. R.R.O. 1980, Reg. 371, s. 12 (6); O. Reg. 291/88, s. 1.

19. Each negotiating agency named in subsection 18 (2) is empowered to adopt or settle by agreement, in respect of the class of potatoes for which it is appointed,

- (a) minimum prices for the potatoes or for any class, variety, grade or size of the potatoes;
- (b) terms, conditions and forms of agreements relating to the producing or marketing of the potatoes; and
- (c) any charges, costs or expenses relating to the production or marketing of the potatoes. R.R.O. 1980, Reg. 371, s. 13; O. Reg. 96/84, s. 1; O. Reg. 195/86, s. 2; O. Reg. 291/88, s. 4.

20. A meeting of a negotiating agency may be convened by a notice in writing given by the three members of the negotiating

agency appointed by the local board, or by the three members of the negotiating agency appointed by the processors, to the other members of the negotiating agency at least three days but not more than five days before the date of the meeting, stating the time and place of the meeting. R.R.O. 1980, Reg. 371, s. 14.

21.—(1) Where a negotiating agency has met and does not arrive at an agreement respecting all matters that it is empowered to adopt or settle by agreement, the negotiating agency may refer the matters in dispute to a conciliation board.

(2) A conciliation board shall be composed of three members.

(3) One member shall be appointed by the members of the negotiating agency appointed by the local board and one other member shall be appointed by the members of the negotiating agency appointed by the processors.

(4) Where two members are appointed to a conciliation board in accordance with subsection (3), the two members so appointed may appoint a third member to the conciliation board.

(5) The negotiating agency shall submit to the conciliation board a statement or statements of the matters in dispute.

(6) The conciliation board shall,

- (a) endeavour to effect agreement on any matter referred to it under subsection (5); and
- (b) recommend adoption of any agreement effected under clause (a) to the negotiating agency. O. Reg. 96/84, s. 2.

22.—(1) Where, on or before the second Friday of February in any year, a meeting of a negotiating agency is not held in accordance with the notice required by section 20, or a meeting is held and the negotiating agency does not arrive at an agreement respecting all matters it is empowered to adopt or settle by agreement, or the negotiating agency decides that an agreement cannot be reached and so notifies the Commission, the matters in dispute shall be referred by the Commission to an Arbitration Board.

(2) Where a negotiating agency does not arrive at an agreement on all matters that it is empowered to adopt or settle by agreement, the negotiating agency shall submit in writing to the Commission a statement or statements of the matters in dispute and a statement of the final position on each such matter of,

- (a) the members of the negotiating agency appointed by the local board; and
- (b) the members of the negotiating agency appointed by the processors. O. Reg. 79/89, s. 1.

23.—(1) An Arbitration Board shall be composed of three members.

(2) One member shall be appointed by the three members of the negotiating agency appointed by the local board, and one other member shall be appointed by the three members of the negotiating agency appointed by the processors. R.R.O. 1980, Reg. 371, s. 16 (1, 2).

(3) Where two members are appointed to an Arbitration Board in accordance with subsection (2), the two members so appointed may appoint a third member to the Arbitration Board but, where the two members do not appoint the third member within seven days after the date mentioned in subsection 22 (1), the Commission shall appoint the third member. R.R.O. 1980, Reg. 371, s. 16 (3); O. Reg. 291/88, s. 1.

(4) Where the three members of the negotiating agency appointed by the local board or the three members of the negotiating agency appointed by the processors do not appoint a member to the Arbitration Board in accordance with subsection (2) within three

days after the date mentioned in subsection 22 (1), the Commission shall appoint such members as are necessary to complete the Arbitration Board. R.R.O. 1980, Reg. 371, s. 16 (4); O. Reg. 291/88, s. 1.

(5) The Commission shall submit to the Arbitration Board any statement or statements of the matters in dispute received from the negotiating agency under subsection 22 (2). R.R.O. 1980, Reg. 371, s. 16 (5); O. Reg. 291/88, s. 1.

(6) The Arbitration Board shall meet forthwith after the appointment of the three members thereof and shall make an award in respect of each matter in dispute which is one of the final positions respecting such matter set out in the statements referred to in subsection 22 (2). O. Reg. 79/89, s. 2.

REGULATION 423

POTATOES—PLAN

1. The plan in the Schedule is continued for the control and regulation of the marketing within Ontario of potatoes. R.R.O. 1980, Reg. 370, s. 1.

2. The local board named in the Schedule is given the powers set out in subsection 15 (1), in paragraphs 1, 2, 4, 5, 6, 7, 8, 10, 11, 12, 13, 14, 15, 16, 17, 18, 19 and 26 of subsection 15 (2) and in sections 50 and 110 of the *Co-operative Corporations Act*. R.R.O. 1980, Reg. 370, s. 2.

3. The members of the local board named in the Schedule shall be deemed to be the shareholders and directors of the local board in the exercise of the powers vested in the local board under section 2. R.R.O. 1980, Reg. 370, s. 3.

Schedule

Farm Products Marketing Act

PLAN

1. This plan may be cited as “The Ontario Potato Growers’ Marketing-for-Processing Plan”.

2. In this plan,

“potatoes” means potatoes produced in Ontario, other than potatoes that are used for any purpose other than processing;

“processing” means,

- (a) canning, dehydrating, chipping, drying, freezing, peeling or processing with any chemical or by heat and combining or mixing potatoes with one or more other vegetables, or
- (b) entering into a contract for the purchase of potatoes for the purpose of performing on the potatoes any of the operations mentioned in clause (a);

“processor” means a person engaged in the business of processing potatoes;

“producer” means a person engaged in the production of potatoes.

3. This plan provides for the control and regulation in any or all respects of the marketing within Ontario of potatoes, including the prohibition of such marketing in whole or in part.

4. There shall be a local board to be known as “The Ontario Potato Growers’ Marketing Board”.

5. The local board shall be composed of not more than eight producer-members.

6. Members of the local board shall be elected or appointed in accordance with the provisions of the plan and shall hold office until their successors are elected or appointed.

7. Producers are divided into five districts as follows:

1. District 1, comprising the counties of Essex and Kent.
2. District 2, comprising the counties of Elgin, Huron, Lambton, Middlesex and Perth.
3. District 3, comprising the counties of Brant and Oxford and the regional municipalities of Haldimand-Norfolk, Hamilton-Wentworth and Niagara.
4. District 4, comprising the counties of Bruce, Dufferin, Grey and Wellington and the regional municipalities of Halton, Peel and Waterloo.
5. District 5, comprising the County of Simcoe and The Regional Municipality of York.

8.—(1) Producers in each of the districts named in section 7 form a district group of producers.

(2) A producer in a part of Ontario not included in a district mentioned in section 7 may become a member of the district group of producers nearest to the producer's place of production.

9. There shall be a committee in each district to be known as the "District Potato Growers' Committee".

10. On or before the 15th day of November in each year, the producers in each of districts 1, 2 and 3 shall elect not fewer than three and not more than five members and the producers in each of districts 4 and 5 shall elect five members to the District Potato Growers' Committee for the district.

11.—(1) On or before the 1st day of December in each year, the members of each District Potato Growers' Committee shall elect from among themselves members to the local board as follows:

1. District 1, one member.
2. District 2, one member.
3. District 3, one member.
4. District 4, two members.
5. District 5, three members.

(2) No person is eligible for election from any district to the local board unless he or she is a producer in the district or a member of the district group of producers under subsection 8 (2).

(3) The terms of office of members of the local board expire on the 1st day of December in the year next following the year in which they were elected or appointed.

12.—(1) Where, in any year, a District Potato Growers' Committee fails to elect one or more members to the local board in accordance with subsection 11 (1), the members of the local board shall, at its first meeting after the 1st day of December of that year, appoint such producer-members as are necessary to complete the local board.

(2) Where a member elected or appointed to the local board dies, resigns or otherwise ceases to be a member before the 1st day of December in the year next following the date of his or her election or appointment, the members of the District Committee may within fourteen days thereafter appoint a producer-member for the unexpired term and in default of such appointment the local board shall appoint a producer-member for the unexpired term in the same manner as under subsection (1).

(3) Each producer-member appointed a member to the local board under subsection (1) or (2) shall be a producer eligible under subsection 11 (2). R.R.O. 1980, Reg. 370, Sched.

REGULATION 424

PROCESSING TOMATO SEEDLING PLANTS—MARKETING

1. In this Regulation,

"local board" means The Ontario Processing Tomato Seedling Plant Growers' Marketing Board;

"plan" means The Ontario Processing Tomato Seedling Plant Growers' Marketing Plan;

"processing" means processing as defined in section 2 of The Ontario Vegetable Growers' Marketing-for-Processing Plan;

"processing tomato seedling plants" means seedling tomato plants produced in Ontario except seedling tomato plants used for any purpose other than the production of tomatoes for processing;

"producer" means a person engaged in the production of processing tomato seedling plants. R.R.O. 1980, Reg. 373, s. 1.

2. This Regulation provides for the control and regulation in any or all respects of the producing and marketing within Ontario of processing tomato seedling plants, including the prohibition of such producing and marketing in whole or in part. O. Reg. 506/85, s. 9 (1).

3. The Commission delegates to the local board the power,

- (a) to require persons engaged in producing or marketing processing tomato seedling plants to register their names, addresses and occupations with the local board;
- (b) to require persons engaged in producing or marketing processing tomato seedling plants to furnish such information relating to the production or marketing of processing tomato seedling plants, including the completing and filing of returns, as the local board determines;
- (c) to appoint persons to inspect the books, records, documents, lands and premises and any processing tomato seedling plants of persons engaged in the marketing of processing tomato seedling plants;
- (d) to stimulate, increase and improve the marketing of processing tomato seedling plants by such means as it considers proper;
- (e) to co-operate with a marketing board, local board, marketing commission or marketing agency of Canada or of any province in Canada for the purpose of marketing processing tomato seedling plants;
- (f) to do such acts and make such orders and issue such directions as are necessary to enforce the due observance and carrying out of the Act, the regulations and the plan. R.R.O. 1980, Reg. 373, s. 4.

4. The Commission delegates to the local board its powers to make regulations with respect to processing tomato seedling plants,

- (a) providing for the licensing of any or all persons before commencing or continuing to engage in the producing of processing tomato seedling plants;
- (b) prohibiting persons from engaging in the producing of processing tomato seedling plants except under the authority of a licence;

- (c) providing for the refusal to grant a licence where the applicant is not qualified by experience, financial responsibility and equipment to engage in properly the business for which the application was made, or for any other reason that the local board considers proper;
- (d) providing for the suspension or revocation of, or the refusal to renew, a licence for failure to observe, perform or carry out the Act, the regulations, the plan or any order or direction of the local board;
- (e) providing for the fixing of licence fees payable yearly, half-yearly, quarterly or monthly at different amounts or in instalments, from any or all persons producing or marketing processing tomato seedling plants and the collecting of the licence fees and the recovering of such licence fees by suit in a court of competent jurisdiction;
- (f) prescribing the form of licences;
- (g) requiring any person who receives processing tomato seedling plants to deduct from the money payable for the processing tomato seedling plants, any licence fees payable to the local board by the person from whom he, she or it receives the processing tomato seedling plants, and to forward such licence fees to the local board. R.R.O. 1980, Reg. 373, s. 5; O. Reg. 506/85, s. 9 (2).

5.—(1) The Commission authorizes the local board to use any class of licence fees, service charges and other money payable to it, for the purposes of paying the expenses of the local board, carrying out and enforcing the Act and the regulations and carrying out the purposes of the plan.

(2) The Commission authorizes the local board to establish a fund in connection with the plan for the payment of any money that may be required for the purposes mentioned in subsection (1). R.R.O. 1980, Reg. 373, s. 6.

6.—(1) There shall be a negotiating agency to be known as “The Negotiating Agency for Processing Tomato Seedling Plants”.

(2) The negotiating agency named in subsection (1) shall be composed of,

- (a) the members of the local board; and
- (b) one representative from each processor of tomatoes.

(3) The processors shall, not later than the 31st day of December in each year, appoint the persons referred to in clause (2) (b) and shall notify the Commission in writing of the names and addresses of those persons appointed.

(4) Subject to subsections (5) and (6), the members of the negotiating agency appointed under this section are and remain members from the 1st day of January until the 31st day of December of the year next following the year in which the members were appointed.

(5) Where a member of a negotiating agency appointed under this section by a processor dies or resigns or is unavailable to act before the expiration of his or her term of membership, the processor who appointed him or her shall appoint a person for the unexpired term of the member who died, resigned or was unavailable to act.

(6) Where a processor fails to make an appointment under subsection (3) or (5) within seven days after a vacancy occurs, the Commission shall appoint such persons as are necessary to complete the negotiating agency. R.R.O. 1980, Reg. 373, s. 7.

7. The negotiating agency named in subsection 6 (1) is empowered to adopt or settle by agreement,

- (a) minimum prices for processing tomato seedling plants or for any class, variety, grade or size thereof;
- (b) terms, conditions and forms of agreements relating to the producing or marketing of processing tomato seedling plants; and
- (c) any charges, costs or expenses relating to the production or marketing of processing tomato seedling plants. R.R.O. 1980, Reg. 373, s. 8.

8. A meeting of the negotiating agency may be convened by a notice in writing given by the members of the local board or by the members of the negotiating agency appointed by the processors, to the other members of the negotiating agency at least five days but not more than seven days before the date of the meeting stating the time and place of the meeting. R.R.O. 1980, Reg. 373, s. 9.

9.—(1) Where a meeting of the negotiating agency is not held in accordance with the notice required by section 8, or where a meeting is held and the negotiating agency does not arrive at an agreement respecting all matters that it is empowered to adopt or settle by agreement, or where the negotiating agency decides that an agreement cannot be reached and so notifies the Commission on or before the 28th day of February in any year, the matters in dispute shall be referred by the Commission to an Arbitration Board.

(2) Where the negotiating agency does not arrive at an agreement on all matters that it is empowered to adopt or settle by agreement, it may submit in writing to the Commission a statement or statements of the matters in dispute. R.R.O. 1980, Reg. 373, s. 10.

10. (1) An Arbitration Board shall be composed of three members.

(2) One member shall be appointed by the members of the local board and one member shall be appointed by the members of the negotiating agency appointed by the processors.

(3) Where two members are appointed to the Arbitration Board in accordance with subsection (2), the two members so appointed may appoint a third member to the Arbitration Board but, where the two members do not appoint a third member within seven days after the date mentioned in subsection 9 (1) in any year, the Commission shall appoint the third member.

(4) Where the members of the local board or the members of the negotiating agency appointed by the processors do not appoint a member to the Arbitration Board in accordance with subsection (2) within seven days after the date mentioned in subsection 9 (1), the Commission shall appoint such members as are necessary to complete the Arbitration Board.

(5) The Commission shall submit to the Arbitration Board any statement or statements of the matters in dispute received from the negotiating agency under subsection 9 (2).

(6) The Arbitration Board shall meet forthwith after the appointment of the three members thereof and shall make an award in respect of the matters referred to it, or all matters that the negotiating agency was empowered to adopt or settle by agreement, as the case may be. R.R.O. 1980, Reg. 373, s.11.

REGULATION 425

PROCESSING TOMATO SEEDLING PLANTS—PLAN

1. The plan in the Schedule is continued for the control and regulation of the marketing within Ontario of processing tomato seedling plants. R.R.O. 1980, Reg. 372, s. 1.

2. The local board named in the Schedule is given the powers set

out in subsection 15 (1), in paragraphs 1, 2, 3, 4, 5, 6, 7, 8, 10, 11, 12, 13, 14, 15, 16, 17, 18, 19 and 26 of subsection 15 (2) and in sections 50 and 110 of the *Co-operative Corporations Act*. R.R.O. 1980, Reg. 372, s. 2.

3. The members of the local board shall be deemed to be the shareholders and the directors thereof in the exercise of any of the powers mentioned in section 2. R.R.O. 1980, Reg. 372, s. 3.

Schedule

Farm Products Marketing Act

PLAN

1. This plan may be cited as "The Ontario Processing Tomato Seedling Plant Growers' Marketing Plan".

2. In this plan,

"processing" means processing as defined in section 2 of The Ontario Vegetable Growers' Marketing-for-Processing Plan;

"processing tomato seedling plants" means seedling tomato plants produced in Ontario except seedling tomato plants used for any purpose other than the production of tomatoes for processing;

"producer" means a person engaged in the production of processing tomato seedling plants.

3. This plan applies to the control and regulation in any or all respects of the marketing within Ontario of processing tomato seedling plants including the prohibition of such marketing in whole or in part.

4. There shall be a local board to be known as "The Ontario Processing Tomato Seedling Plant Growers' Marketing Board".

5. The local board shall be composed of four producer-members.

6. The local board shall, on the last Tuesday of October in each year, conduct a meeting at which all producers of processing tomato seedling plants for that year in the records of the local board are eligible to attend.

7. At the meeting referred to in section 6, the producers present at the meeting shall elect producers to be members of the local board as follows:

1. One producer to be elected as a member and chair of the local board.

2. One producer to be elected as a member and vice-chair of the local board.

3. Two producers to be members and directors of the local board.

8. The producers elected under section 7 take office at the conclusion of the meeting referred to in section 6.

9.—(1) Where the producers fail to elect any members to the local board, the members elected to the local board shall, as soon thereafter as may be practicable, appoint such producer-members as are necessary to complete the local board.

(2) Where a member elected or appointed to the local board dies, resigns or is unavailable to act before the last Tuesday of October in the year next following the date of his or her election or appointment, the members of the local board may appoint a producer-member for the unexpired term. R.R.O. 1980, Reg. 372, Sched.

REGULATION 426

RUTABAGAS—MARKETING

1. In this Regulation,

"local board" means The Ontario Rutabaga Producers' Marketing Board;

"plan" means The Ontario Rutabaga Producers' Marketing Plan;

"producer" means a person engaged in the production of rutabagas;

"rutabagas" means rutabagas produced in Ontario. R.R.O. 1980, Reg. 375, s. 1.

2. This Regulation provides for the control and regulation in any or all respects of the marketing within Ontario of rutabagas, including the prohibition of such marketing in whole or in part. R.R.O. 1980, Reg. 375, s. 2.

3. The Commission exempts from this Regulation rutabagas produced in the territorial districts of Algoma, Cochrane, Kenora, Manitoulin, Nipissing, Rainy River, Sudbury, Thunder Bay and Timiskaming. R.R.O. 1980, Reg. 375, s. 3.

4. The Commission delegates to the local board the power,

(a) to require persons engaged in producing or marketing rutabagas to register their names, addresses and occupations with the local board;

(b) to require persons engaged in producing or marketing rutabagas to furnish such information relating to the production or marketing of rutabagas, including the completing and filing of returns, as the local board determines;

(c) to appoint persons to inspect the books, records, documents, lands and premises and any rutabagas of persons engaged in producing or marketing rutabagas;

(d) to stimulate, increase and improve the marketing of rutabagas by such means as it considers necessary;

(e) to co-operate with a marketing board, a local board, a marketing commission or a marketing agency of Canada or of any province in Canada for the purpose of marketing rutabagas;

(f) to do such acts and make such orders and issue such directions as are necessary to enforce the due observance and carrying out of the Act, the regulations and the plan. R.R.O. 1980, Reg. 375, s. 4.

5. The Commission delegates to the local board its powers to make regulations with respect to rutabagas,

(a) providing for the licensing of any or all persons before commencing or continuing to engage in the producing or marketing of rutabagas;

(b) prohibiting persons from engaging in the producing or marketing of rutabagas except under the authority of a licence;

(c) providing for the refusal to grant a licence where the applicant is not qualified by experience, financial responsibility and equipment to engage in properly the business for which the application was made, or for any other reason that the local board considers proper;

(d) providing for the suspension or revocation of, or the refusal to renew, a licence for failure to observe, perform or carry out the Act, the regulations, the plan or any order or direction of the Commission or local board;

- (e) providing for the fixing of licence fees, not exceeding 3 per cent of the amount paid to the producer, payable yearly, half-yearly, quarterly or monthly at different amounts or in instalments from any or all persons producing or marketing rutabagas and the collecting of the licence fees and the recovering of such licence fees by suit in a court of competent jurisdiction;
- (f) prescribing the form of licences;
- (g) subject to section 3, providing for the exemption from any or all of the regulations, orders or directions under any plan of any class, variety, grade or size of rutabagas, or any person or class of persons engaged in producing or marketing of rutabagas or any class, variety, grade or size of rutabagas;
- (h) requiring the furnishing of security or proof of financial responsibility by any person engaged in the marketing of rutabagas and providing for the administration and disposition of any money or securities so furnished;
- (i) providing for the control and regulation of the marketing of rutabagas, including the times and places at which rutabagas may be marketed;
- (j) providing for the control and regulation of agreements entered into by producers of rutabagas with persons engaged in marketing rutabagas and the prohibition of any provision or clause in such agreements;
- (k) requiring any person who produces rutabagas to offer to sell and to sell rutabagas to or through the local board;
- (l) prohibiting any person from packing or packaging any rutabagas that have not been sold by or through the local board; and
- (m) providing for the making of agreements relating to the marketing of rutabagas through the local board, and prescribing the forms and the terms and conditions of such agreements. R.R.O. 1980, Reg. 375, s. 5.
- 6.—(1) The Commission authorizes the local board to use any class of licence fees, service charges and other money payable to it for the purposes of paying the expenses of the local board, carrying out and enforcing the Act and the regulations and carrying out the purposes of the plan.
- (2) The Commission authorizes the local board to establish a fund in connection with the plan for the payment of any money that may be required for the purposes mentioned in subsection (1). R.R.O. 1980, Reg. 375, s. 6.
7. The Commission authorizes the local board to appoint agents, to prescribe their duties and terms and conditions of employment and to provide for their remuneration. R.R.O. 1980, Reg. 375, s. 7.
- 8.—(1) All rutabagas shall be marketed by or through the local board.
- (2) No person shall market rutabagas except by or through the local board. R.R.O. 1980, Reg. 375, s. 8.
9. The Commission vests in the local board the following powers:
1. To direct and control, by order or direction, either as principal or agent, the marketing of rutabagas, including the times and places at which rutabagas may be marketed.
 2. To determine the quantity of each class, variety, grade and size of rutabagas that shall be marketed by each producer.
 3. To prohibit the marketing of any class, variety, grade or size of rutabagas.
 4. To determine from time to time the price or prices that shall be paid to producers or to the local board, as the case may be, for rutabagas or any class, variety, grade or size of rutabagas and to determine different prices for different parts of Ontario.
 5. To fix and impose service charges from time to time for the marketing of rutabagas.
 6. To require the price or prices payable or owing to the producer for rutabagas to be paid to or through the local board.
 7. To collect from any person by suit in a court of competent jurisdiction the price or prices or any part thereof of rutabagas.
 8. To pay from service charges imposed under paragraph 5 its expenses in carrying out the purposes of the plan.
 9. To pay to the producers the price or prices for rutabagas less service charges imposed under paragraph 5 and to fix the times at which or within which such payments shall be made. R.R.O. 1980, Reg. 375, s. 9.
10. Each payment under paragraph 9 of section 9 shall be accompanied by a statement showing the variety, grades of each variety and quantity of each grade of rutabagas sold and the price or prices paid and the particulars of the service charges imposed by the local board. R.R.O. 1980, Reg. 375, s. 10.

REGULATION 427

SEED-CORN—MARKETING

1. In this Regulation,

“dealer” means a person who buys seed-corn from a producer for resale;

“local board” means The Ontario Seed-Corn Growers’ Marketing Board;

“plan” means The Ontario Seed-Corn Growers’ Marketing Plan;

“producer” means a person engaged in the production of seed-corn; and

“seed-corn” means the seed of hybrid corn or open-pollinated corn of every kind or variety produced in Ontario for seed purposes, but does not include the seed of sweet corn and popcorn. R.R.O. 1980, Reg. 377, s. 1.

2. This Regulation provides for the control and regulation in any or all respects of the producing and marketing within Ontario of seed-corn, including the prohibition of such marketing in whole or in part. O. Reg. 67/83, s. 1.

LICENCES

3.—(1) No person shall commence or continue to engage in the production of seed-corn except under the authority of a licence. R.R.O. 1980, Reg. 377, s. 3 (1); O. Reg. 506/85, s. 10 (1).

(2) Every producer, while not in default of the fees required to be paid under section 7, shall be deemed to be the holder of a licence. O. Reg. 506/85, s. 10 (2).

4.—(1) No producer shall sell seed-corn to any person other than

a licensed dealer except under the authority of a licence issued by the Commission.

(2) A licence referred to in subsection (1) is valid from the 1st day of July until the 30th day of June of the following year.

(3) A licence referred to in subsection (1) shall be issued without fee. O. Reg. 81/89, s. 2, *part*.

5.—(1) No person shall deal in seed-corn except under the authority of a licence issued by the Commission.

(2) A licence referred to in subsection (1) expires on the 30th day of June next following the date on which it is issued.

(3) A licence referred to in subsection (1) shall be issued without fee. O. Reg. 81/89, s. 2, *part*.

6. The Commission may refuse to grant or renew a licence or may suspend or revoke a licence,

- (a) where the applicant or licensee is not qualified by experience, financial responsibility or equipment to properly engage in the business for which the licence is applied for; or
- (b) where the applicant or licensee has failed to comply with or has contravened the Act, the regulations, the plan or any order or direction of the Commission. O. Reg. 81/89, s. 2, *part*.

7. Every producer shall pay to the local board the licence fees fixed by the local board. O. Reg. 506/85, s. 10 (3).

POWERS OF THE LOCAL BOARD

8.—(1) The Commission authorizes the local board to use the licence fees, and other money payable to it, for the purpose of paying the expenses of the local board, carrying out and enforcing the Act and the regulations and carrying out the purposes of the plan. R.R.O. 1980, Reg. 377, s. 9 (1); O. Reg. 81/89, s. 1.

(2) The Commission authorizes the local board to establish a fund in connection with the plan for the payment of any money that may be required for the purposes mentioned in subsection (1). R.R.O. 1980, Reg. 377, s. 9 (2); O. Reg. 81/89, s. 1.

9. The Commission delegates to the local board the power,

- (a) to require persons engaged in producing or marketing seed-corn to register their names, addresses and occupations with the local board;
- (b) to require persons engaged in producing or marketing seed-corn to furnish such information relating to the production or marketing of the seed-corn as the local board determines;
- (c) to appoint persons to inspect the books, records, lands and premises and any seed-corn of persons engaged in the marketing of seed-corn;
- (d) to stimulate, increase and improve the marketing of seed-corn by such means as it considers proper;
- (e) to co-operate with a marketing board, a local board or a marketing agency of any other province for the purpose of marketing seed-corn;
- (f) to do such acts and make such orders and issue such directions as are necessary to enforce the due observance and carrying out of the Act, the regulations and the plan;
- (g) to make regulations with respect to seed-corn providing for the fixing of licence fees payable yearly, quarterly or

monthly at different amounts or in instalments from any or all persons producing seed-corn and the collecting of the licence fees and the recovering of the licence fees by suit in a court of competent jurisdiction;

- (h) to make regulations with respect to seed-corn requiring any person who receives seed-corn to deduct from the money payable for the seed-corn any licence fees payable to the local board by the person from whom the first mentioned person receives the seed-corn, and to forward such licence fees to the local board;
- (i) to make regulations with respect to seed-corn requiring any person who produces and processes seed-corn to furnish to the local board statements of the amounts of seed-corn that the person produced in any year and used for the processing; and
- (j) to make regulations with respect to seed-corn providing for the control and regulation of agreements entered into by producers of seed-corn with persons engaged in marketing or processing seed-corn, and the prohibition of any provision or clause in such agreements. R.R.O. 1980, Reg. 377, s. 10; O. Reg. 506/85, s. 10 (4, 5); O. Reg. 81/89, s. 1.

NEGOTIATING AGENCY

10.—(1) There shall be a negotiating agency to be known as "The Negotiating Committee for Seed-Corn" composed of eight persons, four of whom shall be appointed annually by the local board and four of whom shall be appointed annually by the dealers. R.R.O. 1980, Reg. 377, s. 11 (1).

(2) The local board and the dealers shall appoint their respective members of the negotiating agency after the 1st day of January and before the 15th day of February and shall notify the Commission in writing of the names and addresses of their appointees not later than the 1st day of March in each year. O. Reg. 81/89, s. 3.

(3) Where the local board or the dealers fail to appoint the persons in accordance with subsection (2), the Commission may appoint such representatives as are necessary to complete the negotiating agency. R.R.O. 1980, Reg. 377, s. 11 (3); O. Reg. 81/89, s. 1.

(4) Subject to subsections (5) and (6), the members of the negotiating agency are and remain members until the 31st day of December of the year in which the members were appointed.

(5) Where a member of the negotiating agency dies or resigns or is unavailable to act before the expiration of his or her term of membership, the local board or the dealers, as the case may be, who appointed the member shall appoint a person for the member's unexpired term. R.R.O. 1980, Reg. 377, s. 11 (4, 5).

(6) Where the local board or the dealers, as the case may be, fail to make an appointment under subsection (5) within seven days after a vacancy occurs, the Commission may appoint such persons as are necessary to complete the negotiating agency. R.R.O. 1980, Reg. 377, s. 11 (6); O. Reg. 81/89, s. 1.

11. The Negotiating Committee for Seed-Corn is empowered to adopt or settle by agreement,

- (a) minimum prices for seed-corn or for any class, variety or grade of seed-corn;
- (b) terms, conditions and forms of agreements relating to the producing or marketing of seed-corn; and
- (c) any charges, costs or expenses relating to the production or marketing of seed-corn. R.R.O. 1980, Reg. 377, s. 12.

12. A meeting of the negotiating agency may be convened by a notice in writing given by the four members appointed by the local board, or by the dealers, to the other members of the negotiating

agency at least seven days, but not more than ten days, before the date of the meeting and stating the time and place of the meeting. R.R.O. 1980, Reg. 377, s. 13.

13.—(1) Where the negotiating agency has met and does not arrive at an agreement respecting any matter referred to it or any matter that it is empowered to adopt or settle by agreement, the negotiating agency may refer the matters in dispute to a conciliation board. O. Reg. 67/83, s. 3, *part*.

(2) A conciliation board shall be composed of one member.

(3) Subject to subsection (4), the member of the conciliation board shall be appointed by the members of the negotiating agency.

(4) Where the members of the negotiating agency cannot agree on a person to be appointed as the member of the conciliation board, the Commission shall appoint the member of the conciliation board. O. Reg. 81/89, s. 4.

(5) The negotiating agency shall submit to the conciliation board a statement or statements of the matters in dispute.

(6) The conciliation board shall,

- (a) endeavour to effect agreement on any matter referred to it under subsection (5); and
- (b) recommend adoption of any agreement effected under clause (a) to the negotiating agency. O. Reg. 67/83, s. 3, *part*.

ARBITRATION

14.—(1) Where a meeting of the negotiating agency is not held in accordance with the notice required by section 12, or where a meeting is held and the negotiating agency does not arrive at an agreement respecting all matters that it is empowered to adopt or settle by agreement, on or before the 15th day of February in any year, the matters in dispute shall be referred by the Commission to an Arbitration Board. R.R.O. 1980, Reg. 377, s. 14 (1); O. Reg. 81/89, ss. 1, 5 (1, 2).

(2) Where the negotiating agency decides before the 28th day of February that an agreement on all matters that it is empowered to adopt or settle by agreement cannot be reached, it shall so notify the Commission. R.R.O. 1980, Reg. 377, s. 14 (2); O. Reg. 81/89, s. 1.

(3) Where the negotiating agency does not arrive at an agreement on all matters that it is empowered to adopt or settle by agreement, it shall submit in writing to the Commission a statement or statements of the matters in dispute and a statement of the final position on each matter of,

- (a) the members of the negotiating agency appointed by the local board; and
- (b) the members of the negotiating agency appointed by the dealers. O. Reg. 81/89, s. 5 (3).

15.—(1) The Arbitration Board shall be composed of one member.

(2) Subject to subsection (3), the member of the Arbitration Board shall be appointed by the members of the negotiating agency.

(3) Where the members of the negotiating agency cannot agree on a person to be appointed as the member of the Arbitration Board within seven days after the Commission is notified under subsection 14 (2) or by the 15th day of February, as the case may be, the Commission shall appoint the Arbitration Board. O. Reg. 81/89, s. 6 (1), *part*.

(4) The Commission shall submit to the Arbitration Board any

statement of the matters in dispute received from the negotiating agency under subsection 14 (3). R.R.O. 1980, Reg. 377, s. 15 (5); O. Reg. 81/89, s. 1.

(5) The Arbitration Board shall meet with the parties forthwith after the appointment of the Board and shall make an award in respect of each matter in dispute referred to the Board which is,

- (a) one of the final positions respecting the matter set out in the statements referred to in subsection 14 (3); or
- (b) a position between the final positions respecting the matter set out in the statements referred to in subsection 14 (3). O. Reg. 81/89, s. 6 (2).

16.—(1) Dealers as a group and the local board are the parties to the arbitration.

(2) Each party shall appoint a representative for purposes of the meeting and shall advise the Arbitration Board of its appointment prior to the meeting. O. Reg. 67/83, s. 3, *part*.

(3) The Arbitration Board shall give full opportunity to the parties to present their evidence and make their submissions but no evidence or submissions may be presented or made except under the direction of the party's representative. O. Reg. 67/83, s. 3, *part*.

(4) Upon the request of either party, witnesses shall be examined on oath. O. Reg. 81/89, s. 7 (2).

(5) Deliberations of the Arbitration Board prior to making an award shall be in private. O. Reg. 67/83, s. 3, *part*.

REGULATION 428

SEED-CORN—PLAN

1. The plan in the Schedule is continued for the control and regulation of the producing and marketing within Ontario of seed-corn. O. Reg. 66/83, s. 1.

2. The local board named in the Schedule is given the powers set out in subsection 15 (1), in paragraphs 1, 2, 3, 4, 5, 6, 7, 8, 10, 11, 12, 13, 14, 15, 16, 17, 18, 19 and 26 of subsection 15 (2) and in sections 50 and 110 of the *Co-operative Corporations Act*. R.R.O. 1980, Reg. 376, s. 2.

3. The members of the local board shall be deemed to be the shareholders and the directors thereof in the exercise of any of the powers mentioned in section 2. R.R.O. 1980, Reg. 376, s. 3.

Schedule

Farm Products Marketing Act

PLAN

1. This plan may be cited as "The Ontario Seed-Corn Growers' Marketing Plan".

2. In this plan,

"dealer" means a person who buys seed-corn from a producer for resale;

"producer" means a person engaged in the production of seed-corn;

"seed-corn" means the seed of hybrid corn, or open-pollinated corn, of every kind or variety produced in Ontario for seed purposes, but does not include the seed of sweet corn and popcorn.

3. This plan provides for the control and regulation in any or all respects of the producing and marketing within Ontario of seed-corn.

4. There shall be a local board to be known as "The Ontario Seed-corn Growers' Marketing Board".

5. The local board shall be composed of seven members.

6. No grower is entitled to vote at any election of the local board unless he or she is registered with the local board for the current year.

7. Producers are divided into three districts as follows:

1. District 1, comprising the County of Essex.
2. District 2, comprising the County of Kent.
3. District 3, comprising that part of Ontario other than the counties of Essex and Kent.

8. The registered producers in each district shall on or before the 31st day of March in each year elect a member or members to the local board as follows:

1. District 1, one member.
2. District 2, five members.
3. District 3, one member. R.R.O. 1980, Reg. 376, Sched.; O. Reg. 66/83, s. 2.

REGULATION 429

SHEEP—MARKETING

1. In this Regulation,

"local board" means the Ontario Sheep Marketing Agency;

"plan" means the Ontario Sheep Marketing Plan;

"processing" means the slaughtering of sheep;

"processor" means a person who slaughters sheep or has sheep slaughtered for him, her or it;

"producer" means a person engaged in the production of sheep or wool;

"sheep" includes rams, wethers, ewes and lambs;

"wool" means the wool of any sheep. O. Reg. 263/85, s. 1.

2. This Regulation provides for the control and regulation in any or all respects of the producing and marketing within Ontario of sheep and wool, including the prohibition of such producing and marketing in whole or in part. O. Reg. 263/85, s. 2.

3. The Commission exempts from this Regulation,

- (a) farm gate sales by a producer of sheep produced by that producer and sold live directly to the consumer;
- (b) farm gate sales of wool by the producer of wool derived from sheep produced by that producer sold directly to the consumer; and
- (c) sales of sheep sold for breeding purposes. O. Reg. 263/85, s. 3.

MARKETING BY LOCAL BOARD

4.—(1) All sheep and wool shall be marketed by or through the local board.

(2) No person shall market sheep or wool except by or through the local board. O. Reg. 263/85, s. 4.

POWERS OF LOCAL BOARD

5. The Commission delegates to the local board the power,

- (a) to require persons engaged in producing or marketing sheep or wool to register their names, addresses and occupations with the local board;
- (b) to require persons engaged in producing or marketing sheep or wool to furnish such information relating to the production or marketing of sheep and wool, including the completing and filing of returns, as the local board determines;
- (c) to appoint persons to inspect the books, records, documents, lands and premises and any sheep and wool of persons engaged in marketing sheep or wool;
- (d) to stimulate, increase and improve the marketing of sheep and wool;
- (e) to co-operate with a marketing board, local board, marketing commission or marketing agency of Canada or any province in Canada for the purpose of marketing sheep or wool;
- (f) to do such acts and make such orders and issue such directions as are necessary to enforce the due observance and carrying out of the Act, the regulations and the plan. O. Reg. 263/85, s. 5.

6. The Commission delegates to the local board its powers to make regulations with respect to sheep and wool,

- (a) providing for the licencing of any or all persons before commencing or continuing to engage in the marketing or processing of sheep or wool;
- (b) prohibiting persons from engaging in the marketing or processing of sheep or wool except under the authority of a licence;
- (c) providing for the refusal to grant a licence where the applicant is not qualified by experience, financial responsibility and equipment to properly engage in the business for which the application was made, or for any other reason that the local board considers proper;
- (d) providing for the suspension or revocation of, or the refusal to renew, a licence for failure to observe, perform or carry out the Act, the regulations, the plan or any order or direction of the Commission or local board;
- (e) providing for the fixing of licence fees payable yearly, half-yearly, quarterly or monthly at different amounts or in instalments from any or all persons marketing sheep or wool and the collecting of the licence fees;
- (f) requiring any person who receives sheep or wool to deduct from the money payable for the sheep or wool any licence fees payable to the local board by the person from whom the sheep or wool are received and to forward such licence fees to the local board;
- (g) requiring any person who produces and processes sheep or wool to furnish to the local board statements of the amounts of sheep or wool produced in any year and used for processing;
- (h) prescribing the form of licences;
- (i) providing for the exemption from any or all of the regula-

tions, orders or directions under the plan of any class, variety, grade or size of sheep or wool, or any person or class of persons engaged in the producing or marketing of sheep or wool or any class, variety, grade or size of sheep or wool;

- (j) requiring the furnishing of security or proof of financial responsibility by any person engaged in the marketing of sheep or wool and providing for the administration and disposition of any money or securities so furnished;
- (k) providing for the control and regulation of the marketing of sheep and wool, including the times and places at which sheep and wool may be marketed;
- (l) providing for the control and regulation of agreements entered into by producers of sheep or wool with persons engaged in marketing or processing sheep or wool and the prohibition of any provision or clause in such agreements;
- (m) requiring any person who produces sheep or wool to offer to sell and to sell the sheep or wool through the local board;
- (n) prohibiting any person from processing, packing or packaging any sheep or wool that has not been sold by or through the local board;
- (o) providing for the making of agreements relating to the marketing of sheep or wool by or through the local board, and prescribing the forms and the terms and conditions of such agreements; and
- (p) providing for the making of such orders and the issuing of such directions as are necessary to enforce the due observance and carrying out of the Act, the regulations, the plan or any order or direction of the Commission or the local board. O. Reg. 263/85, s. 6.

7. The local board may recover from any person by suit in a court of competent jurisdiction any licence fees payable to the local board. O. Reg. 263/85, s. 7.

8.—(1) The Commission authorizes the local board to use any class of licence fees, service charges, and other money payable to it, for the purposes of paying the expenses of the local board, carrying out and enforcing the Act and the regulations and carrying out the purposes of the plan.

(2) The Commission authorizes the local board to establish a fund in connection with the plan for the payment of any money that may be required for the purposes mentioned in subsection (1). O. Reg. 263/85, s. 8.

9. The Commission authorizes the local board to conduct a pool or pools for the distribution of all money received from the sale of sheep or wool and, after deducting all necessary and proper disbursements and expenses, to distribute the remainder of the money received from the sale in such manner that every producer receives a share of the remainder of the money received from the sale in relation to the amount, class, variety, grade or size of sheep or wool delivered by the producer, and authorizes the local board to make an initial payment on delivery of sheep or wool and subsequent payments until all the remainder of the money received from the sale is distributed to the producers. O. Reg. 263/85, s. 9.

10. The Commission authorizes the local board to appoint agents, to prescribe their duties and terms and conditions of employment and to provide for their remuneration. O. Reg. 263/85, s. 10.

11. The Commission vests in the local board the following powers:

- 1. To direct and control, by order or direction, either as principal or agent, the marketing of sheep and wool, including the times and places at which sheep and wool may be marketed.

- 2. To prohibit the marketing of any class, variety, grade or size of sheep and wool.
- 3. To determine from time to time the price or prices that shall be paid to producers or to the local board, as the case may be, for sheep and wool or any class, variety, grade or size of sheep and wool and to determine different prices for different parts of Ontario.
- 4. To fix and impose service charges from time to time for the marketing of sheep and wool.
- 5. To require the price or prices payable or owing to the producer for sheep and wool to be paid to or through the local board.
- 6. To collect from any person by suit in a court of competent jurisdiction the price or prices of any part thereof of sheep and wool.
- 7. To pay to the producers the price or prices for sheep and wool less service charges imposed under paragraph 4 and to fix the times at which or within which such payments shall be made. O. Reg. 263/85, s. 11.

STATEMENTS TO PRODUCERS

12. Each payment made under paragraph 7 of section 11 shall be accompanied by a statement showing the grades and quantity of each grade of sheep and wool sold, the price or prices paid and the particulars of the service charges imposed by the local board. O. Reg. 263/85, s. 12.

ADVISORY COMMITTEE

13.—(1) There shall be an advisory committee to be known as the "Sheep Industry Advisory Committee" composed of not fewer than nine members including a chair. O. Reg. 263/85, s. 13 (1).

(2) After the 1st day of December and before the 31st day of December in each year,

- (a) the Commission shall appoint the chair;
- (b) the local board shall appoint four members;
- (c) the sales agents of the local board shall appoint one member;
- (d) the meat-packing sector shall appoint two members;
- (e) the wool marketing sector shall appoint one member; and
- (f) the Commission may appoint such additional members as it deems advisable,

to the Sheep Industry Advisory Committee. O. Reg. 263/85, s. 13 (2); O. Reg. 584/87, s. 1.

(3) Subject to subsection (4), the members of the Sheep Industry Advisory Committee are and remain members thereof until the 15th day of December in the year next following the year in which they were appointed.

(4) Where a member of the Sheep Industry Advisory Committee dies, resigns or becomes unavailable to act before the expiration of his or her term, the person or persons who appointed him or her shall appoint a person for the unexpired term.

(5) Where the person or persons who are required to appoint any member of the Sheep Industry Advisory Committee fail to do so, the Commission may appoint such members as are necessary to complete the said Committee.

(6) The Sheep Industry Advisory Committee is empowered to

advise and make recommendations to any person or persons represented on the said Committee in respect of,

- (a) the promotion of harmonious relationships between persons engaged in the production and marketing of sheep and wool;
- (b) the promotion of greater efficiency in the production and marketing of sheep and wool;
- (c) the prevention and correction of irregularities and inequities in the marketing of sheep and wool;
- (d) the improvement of the quality and variety of sheep and wool;
- (e) the improvement of the circulation of market information respecting sheep and wool; and
- (f) without limiting the generality of any of the foregoing, any matter with respect to which the Commission or the local board may be empowered to make regulations under the Act. O. Reg. 263/85, s. 13 (3-6).

REGULATION 430

SHEEP—PLAN

1. The Plan in the Schedule is established for the control and regulation of the producing and marketing of sheep and wool within Ontario. O. Reg. 262/85, s. 1.

2. The local board named in the Schedule is given the powers set out in subsection 15 (1), in paragraphs 1 to 8, 10 to 19 and 26 of subsection 15 (2) and in sections 50 and 110 of the *Co-operative Corporations Act*. O. Reg. 262/85, s. 2.

3. The members of the local board shall be deemed to be the shareholders and the directors thereof in the exercise of any of the powers mentioned in section 2. O. Reg. 262/85, s. 3.

Schedule

Farm Products Marketing Act

PLAN

1. This plan may be cited as the "Ontario Sheep Marketing Plan".

2. In this plan,

"local board" means the Ontario Sheep Marketing Agency;

"processing" means the slaughtering of sheep;

"processor" means a person who slaughters sheep or has sheep slaughtered for him, her or it;

"producer" means a person engaged in the production of sheep or wool;

"sheep" includes rams, wethers, ewes and lambs;

"wool" means the wool of any sheep.

3. This plan applies to the control and regulation in any or all respects of the producing and marketing within Ontario of sheep and wool, including the prohibition of such producing and marketing in whole or in part.

4.—(1) The local board known as the Ontario Sheep Marketing Agency is continued.

(2) It shall be composed of eleven members.

5. The members of the local board shall be elected or appointed in accordance with this plan and shall hold office until their successors take office.

6. The producers are divided into eleven districts as follows:

1. District 1, comprising the counties of Essex, Kent, Lambton, Middlesex and Elgin.
2. District 2, comprising the counties of Grey and Bruce.
3. District 3, comprising the counties of Huron, Perth and Oxford and The Regional Municipality of Waterloo.
4. District 4, comprising the County of Brant and the regional municipalities of Hamilton-Wentworth, Haldimand-Norfolk and Niagara.
5. District 5, comprising the counties of Wellington and Dufferin and the regional municipalities of Halton and Peel.
6. District 6, comprising the County of Simcoe, the District Municipality of Muskoka and the District of Parry Sound.
7. District 7, comprising The Municipality of Metropolitan Toronto, the regional municipalities of York and Durham and the counties of Victoria, Peterborough, Northumberland and Haliburton.
8. District 8, comprising the counties of Lennox and Addington, Hastings, Prince Edward, Frontenac and Leeds.
9. District 9, comprising the counties of Renfrew and Lanark and the Township of West Carleton and the City of Kanata in The Regional Municipality of Ottawa-Carleton.
10. District 10, comprising the counties of Russell, Prescott, Glengarry, Stormont, Dundas and Grenville and The Regional Municipality of Ottawa-Carleton other than the Township of West Carleton and the City of Kanata.
11. District 11, comprising The Regional Municipality of Sudbury and the territorial districts other than Parry Sound.

7. There shall be a committee of not fewer than three nor more than seven producer-members in each district to be known as the "District Sheep Committee".

8.—(1) Not fewer than thirty days prior to the annual meeting of the local board, the producers in each district shall elect from among themselves,

- (a) the members of the District Sheep Committee;
- (b) a member of the local board, if required under section 9; and
- (c) one voting delegate for each thirty registered producers or fraction thereof in the district to the annual meeting of the local board.

(2) No person is eligible to vote or be elected unless he or she is registered as a producer with the local board.

(3) Where the registered producer is a corporation or partnership, it may designate the person eligible to vote and be elected on its behalf.

9.—(1) One person shall be elected to the local board from each district for a term of three years from the 15th day of December calculated from,

- (a) 1986 for Districts 2, 5, 8 and 11;
- (b) 1987 for Districts 3, 6 and 9; and
- (c) 1988 for Districts 1, 4, 7 and 10.

(2) At the first meeting of the local board after the 15th day of December in every year, the members of the local board shall elect a vice-chair from among themselves.

(3) At the first meeting of the local board after the 15th day of December, in every year, the members of the local board shall elect a chair from among themselves.

10.—(1) Where the producers in a district fail to elect a member to the local board under section 9, the members of the local board may appoint such member at their first meeting after the 15th day of December.

(2) Where a member elected to the local board or appointed under this section dies, resigns, becomes unavailable to act or ceases to be a producer in the district before his or her term has expired, the District Sheep Committee may appoint a producer from the district for the unexpired portion of the term.

(3) Where the District Sheep Committee fails to appoint a person for the unexpired portion of the term of a member under subsection (2) within fourteen days of the death, resignation or date on which the member becomes unavailable to act or ceases to be a producer in the district, the local board may appoint a producer for the unexpired portion of the term.

(4) Where the local board fails to appoint a producer for the unexpired portion of the term of a member under subsection (2) within twenty-eight days of the death, resignation or date on which the member becomes unavailable to act or ceases to be a producer in the district, the Commission may appoint a producer for the unexpired portion of the term.

11. Every person elected or appointed under this plan shall be a producer resident in the district for which he or she is elected or appointed. O. Reg. 262/85, Sched., revised.

REGULATION 431

SOYBEANS—MARKETING

1. In this Regulation,

“grain merchandiser” means a person who buys soybeans for resale;

“local board” means The Ontario Soybean Growers’ Marketing Board;

“plan” means The Ontario Soybean Growers’ Marketing Plan;

“processing” means cleaning, drying, processing with or without other ingredients or processing or manufacturing of products in whole or in part from soybeans;

“processor” means a person engaged in processing soybeans;

“producer” means a person engaged in the production of soybeans in Ontario;

“soybeans” means soybeans produced in Ontario. R.R.O. 1980, Reg. 379, s. 1; O. Reg. 640/84, s. 1; O. Reg. 539/90, s. 1.

2. This Regulation provides for the control and regulation in any or all respects of the producing and marketing within Ontario of soybeans, including the prohibition of such marketing in whole or in part. R.R.O. 1980, Reg. 379, s. 2; O. Reg. 640/84, s. 2; O. Reg. 539/90, s. 1.

3. The Commission delegates to the local board the power,

- (a) to require persons engaged in producing or marketing soybeans to register their names, addresses and occupations with the local board;
- (b) to require persons engaged in producing or marketing soybeans to furnish such information relating to the production or marketing of soybeans, including the completing and filing of returns, as the local board determines;
- (c) to appoint persons to inspect the books, records, documents, lands and premises and any soybeans of persons engaged in producing or marketing soybeans;
- (d) to stimulate, increase and improve the marketing of soybeans by such means as it considers proper;
- (e) to co-operate with a marketing board, a local board, marketing commission or marketing agency of Canada or any province in Canada for the purpose of marketing soybeans; and
- (f) to do such acts, make such orders and issue such directions as are necessary to enforce the due observance and carrying out of the Act, the regulations and the plan. R.R.O. 1980, Reg. 379, s. 8; O. Reg. 539/90, s. 1.

4. The Commission delegates to the local board its powers to make regulations with respect to soybeans,

- (a) providing for the licensing of any or all persons before commencing or continuing to engage in the producing or marketing of soybeans;
- (b) prohibiting persons from engaging in the producing or marketing of soybeans except under the authority of a licence issued by the local board;
- (c) subject to section 5, providing for the refusal to grant a licence for the producing or marketing of soybeans where the applicant is not qualified by experience, financial responsibility and equipment to engage properly in the producing or marketing of soybeans, or for any other reason that the local board considers proper;
- (d) providing for the suspension or revocation of, or the refusal to renew, a licence for the producing or marketing of soybeans for failure to observe, perform or carry out the Act, the regulations, the plan or any order or direction of the local board;
- (e) providing for the fixing of licence fees payable yearly, half-yearly, quarterly or monthly at different amounts or in instalments from any or all persons producing or marketing soybeans and the collecting of the licence fees and the recovering of such licence fees by suit in a court of competent jurisdiction;
- (f) requiring any person who receives soybeans to deduct from the money payable for the soybeans any licence fees payable to the local board by the person from whom the person receives the soybeans and to forward such licence fees to the local board;
- (g) requiring any person who produces and processes soybeans to furnish to the local board statements of the amounts of soybeans that the person produced in any year and used for processing;
- (h) prescribing the form of licences;
- (i) providing for the exemption from any or all of the regulations, orders or directions, under the plan of any class, variety or grade of soybeans, or any person or class of persons

engaged in the producing or marketing of soybeans, or any class, variety or grade of soybeans;

- (j) providing for the control and regulation of the marketing of soybeans, including the times and places at which soybeans may be marketed;
- (k) providing for the control and regulation of agreements entered into by producers of soybeans with persons engaged in marketing or processing soybeans and the prohibition of any provision or clause in such agreements;
- (l) providing for the making of agreements relating to the marketing of soybeans by or through the local board and prescribing the forms and the terms and conditions of such agreements. R.R.O. 1980, Reg. 379, s. 9; O. Reg. 640/84, s. 4; O. Reg. 539/90, s. 1.

5. The local board shall not refuse to grant a licence for the marketing of soybeans under clause 4 (c) on the ground that the applicant is not qualified by financial responsibility to engage properly in the marketing of soybeans unless the Director appointed under the *Farm Products Grades and Sales Act*,

- (a) has refused to issue a licence to the applicant to engage in business as a dealer in soybeans; or
- (b) has refused to renew or has suspended or revoked the applicant's licence to engage in business as a dealer in soybeans. O. Reg. 640/84, s. 5; O. Reg. 539/90, s. 1.

6.—(1) The Commission authorizes the local board to use any class of licence fees and other money payable to it for the purpose of paying the expenses of the local board, carrying out and enforcing the Act and the regulations and carrying out the purposes of the plan.

(2) The Commission authorizes the local board to establish a fund in connection with the plan for the payment of any money that may be required for the purposes mentioned in subsection (1). R.R.O. 1980, Reg. 379, s. 11.

7.—(1) The Commission authorizes the local board to appoint agents, to prescribe their duties and terms and conditions of employment and to provide for their remuneration. R.R.O. 1980, Reg. 379, s. 12 (1).

(2) The Commission vests in the local board the power to purchase or otherwise acquire such quantity or quantities of soybeans as the local board considers advisable and to sell or otherwise dispose of any of the soybeans so purchased or acquired. R.R.O. 1980, Reg. 379, s. 12 (2); O. Reg. 539/90, s. 1.

8.—(1) There shall be a negotiating agency to be known as "The Negotiating Agency for Soybeans" composed of ten persons appointed annually after the 1st day of February and before the 1st day of March, upon the request in writing of the Commission, of whom five shall be appointed by the local board, three shall be appointed by the processors and two shall be appointed by the Soybean Committee of The Ontario Grain and Feed Dealers' Association. R.R.O. 1980, Reg. 379, s. 13 (1); O. Reg. 117/90, s. 1; O. Reg. 539/90, s. 1.

(2) Upon receiving a request under subsection (1), the local board, the processors and the Soybean Committee of The Ontario Grain and Feed Dealers' Association shall also each appoint in writing one alternate who may attend meetings of the negotiating agency as an observer and, in the absence of a member of the negotiating agency representing the body that appointed the alternate, shall perform the absent member's functions. O. Reg. 163/85, s. 1; O. Reg. 539/90, s. 1.

(3) Where the local board or the processors or the Soybean Committee of The Ontario Grain and Feed Dealers' Association fails to appoint persons in accordance with subsection (1) within seven days

of receipt of the request in writing of the Commission, the Commission may appoint such representatives as are necessary to complete the negotiating agency. R.R.O. 1980, Reg. 379, s. 13 (2); O. Reg. 539/90, s. 1.

(4) Subject to subsections (5) and (6), the members of the negotiating agency are and remain members until the 31st day of December in the year in which the members were appointed. R.R.O. 1980, Reg. 379, s. 13 (3).

(5) Where a member of the negotiating agency dies or resigns or is unavailable to act before the expiration of his or her term of membership, the local board or the processors or the Soybean Committee of The Ontario Grain and Feed Dealers' Association, as the case may be, who appointed him or her shall appoint a person for the unexpired term of the member who died, resigned or was unavailable to act. R.R.O. 1980, Reg. 379, s. 13 (4); O. Reg. 539/90, s. 1.

(6) Where the local board, the processors or the Soybean Committee of The Ontario Grain and Feed Dealers' Association, as the case may be, fail to make an appointment under subsection (5) within seven days after a vacancy occurs, the Commission may appoint such persons as are necessary to complete the negotiating agency. R.R.O. 1980, Reg. 379, s. 13 (5); O. Reg. 539/90, s. 1.

9. The Negotiating Committee for Soybeans has the power to adopt or settle by agreement,

- (a) minimum prices for soybeans or for any class, variety, grade or size of soybeans;
- (b) terms, conditions and forms of agreement relating to the purchasing or marketing of soybeans; and
- (c) any charges, costs or expenses relating to the production or marketing of soybeans. R.R.O. 1980, Reg. 379, s. 14; O. Reg. 539/90, s. 1.

10. A meeting of the negotiating agency may be convened by a notice in writing given by the five members appointed by the local board or by the three members appointed by the processors or by the two members appointed by the Soybean Committee of The Ontario Grain and Feed Dealers' Association to the other members of the negotiating agency at least seven days but not more than ten days before the date of the meeting stating the time and place of the meeting. R.R.O. 1980, Reg. 379, s. 15; O. Reg. 117/90, s. 2; O. Reg. 539/90, s. 1.

11.—(1) Where a meeting of the negotiating agency is not held in accordance with the notice in section 10, or where a meeting is held and the negotiating agency does not arrive at an agreement respecting all matters that it is empowered to adopt or settle by agreement, on or before the 30th day of April in any year, the matters in dispute shall be referred by the Commission to an arbitrator. R.R.O. 1980, Reg. 379, s. 16 (1); O. Reg. 117/90, s. 3 (1).

(2) Where the negotiating agency decides before the 30th day of April that an agreement on all matters that it is empowered to adopt or settle by agreement cannot be reached, it shall so notify the Commission. R.R.O. 1980, Reg. 379, s. 16 (2).

(3) Where the negotiating agency does not arrive at an agreement under subsection (1) or (2), it shall submit in writing to the Commission a statement of the matters in dispute and a statement of the final position on each of these matters of,

- (a) the members of the negotiating agency appointed by the local board;
- (b) the members of the negotiating agency appointed by the processors; and
- (c) the members of the negotiating agency appointed by the Soybean Committee of The Ontario Grain and Feed Dealers' Association.

ers' Association. O. Reg. 117/90, s. 3 (2); O. Reg. 539/90, s. 1.

12.—(1) Subject to subsection (2), the members of the negotiating agency shall appoint the arbitrator.

(2) Where in any year the members of the negotiating agency cannot agree on the person to be appointed arbitrator within seven days after the Commission was notified under subsection 11 (1), or the 30th day of April, as the case may be, the Commission shall appoint the arbitrator.

(3) The Commission shall submit to the arbitrator any statement of each of the matters in dispute and any statement of the final position on each of these matters received under subsection 11 (3).

(4) Forthwith after his or her appointment, the arbitrator shall meet with the parties and make an award in respect of each matter in dispute that is one of the final positions respecting these matters set out in the statements received under subsection 11 (3). O. Reg. 117/90, s. 4.

13. There shall be an advisory committee to be known as The Soybean Industry Advisory Committee composed of a chair and eleven members. R.R.O. 1980, Reg. 379, s. 18; O. Reg. 117/90, s. 5; O. Reg. 539/90, s. 1.

14. After the 31st day of January, and on or before the 15th day of February, in each year,

- (a) the Commission shall appoint the chair;
- (b) the local board shall appoint five members;
- (c) the Soybean Committee of The Ontario Grain and Feed Dealers' Association shall appoint three members;
- (d) the processors shall appoint two members; and
- (e) the grain merchandisers shall appoint one member,

to The Soybean Industry Advisory Committee. R.R.O. 1980, Reg. 379, s. 19; O. Reg. 640/84, s. 6; O. Reg. 117/90, s. 6; O. Reg. 539/90, s. 1.

15. Subject to section 16, the members of the advisory committee appointed under section 14 are and remain members thereof until the 15th day of February in the year next following the year in which they were appointed. R.R.O. 1980, Reg. 379, s. 20.

16. Where a member of The Soybean Industry Advisory Committee dies or resigns or is unavailable to act before the expiration of his or her term, the person or persons who appointed him or her shall appoint a person for the unexpired term of the member who died, resigned or was unavailable to act. R.R.O. 1980, Reg. 379, s. 21; O. Reg. 539/90, s. 1.

17. Where any of the persons referred to in section 14 fail to appoint a member to The Soybean Industry Advisory Committee in accordance with section 14 or 16, the Commission may appoint such members as are necessary to complete the said committee. R.R.O. 1980, Reg. 379, s. 22; O. Reg. 539/90, s. 1.

18. The Soybean Industry Advisory Committee is empowered to advise and make recommendations to the local board, the Soybean Committee of The Ontario Grain and Feed Dealers' Association, the processors or the grain merchandisers in respect of any of the following matters:

- 1. The promotion of harmonious relationships between persons engaged in the production and marketing of soybeans.
- 2. The promotion of greater efficiency in the production and marketing of soybeans.

- 3. The prevention and correction of irregularities and inequities in the marketing of soybeans.
- 4. The improvement of the quality and variety of soybeans.
- 5. The improvement of the circulation of market information respecting soybeans.
- 6. Without limiting the generality of any of the foregoing, any matter with respect to which the Commission or the local board may be empowered to make regulations under the Act. R.R.O. 1980, Reg. 379, s. 23; O. Reg. 117/90, s. 7; O. Reg. 539/90, s. 1.

REGULATION 432

SOYBEANS—PLAN

1. The plan in the Schedule is continued for the control and regulation of the producing and marketing of soybeans within Ontario. O. Reg. 650/86, s. 1; O. Reg. 538/90, s. 1.

2. The local board named in the Schedule is given the powers set out in subsection 15 (1), in paragraphs 1, 2, 3, 4, 5, 6, 7, 8, 10, 11, 12, 13, 14, 15, 16, 17, 18, 19 and 26 of subsection 15 (2) and in sections 50 and 110 of the *Co-operative Corporations Act*. R.R.O. 1980, Reg. 378, s. 2.

3. The members of the local board shall be deemed to be the shareholders and directors thereof in the exercise of any of the powers mentioned in section 2. R.R.O. 1980, Reg. 378, s. 3.

Schedule

Farm Products Marketing Act

PLAN

1. This plan may be cited as "The Ontario Soybean Growers' Marketing Plan".

2. In this plan,

"producer" means a person engaged in the production of soybeans in Ontario;

"soybeans" means soybeans produced in Ontario.

3. This plan applies to the control and regulation in all respects of the producing and marketing within Ontario of soybeans, including the prohibition of such producing and marketing in whole or in part.

4. There shall be a local board to be known as "The Ontario Soybean Growers' Marketing Board".

5. The local board shall be composed of fifteen members who shall hold office until their successors take office.

6.—(1) There shall be eight districts, as follows:

- 1. District 1, comprising the County of Essex.
- 2. District 2, comprising the County of Kent.
- 3. District 3, comprising the County of Lambton.
- 4. District 4, comprising the County of Elgin.
- 5. District 5, comprising the County of Middlesex.
- 6. District 6, comprising the counties of Brant and Oxford and the regional municipalities of Haldimand-Norfolk, Hamilton-Wentworth and Niagara.

7. District 7, comprising the counties of Bruce, Grey, Huron, Perth and Wellington and The Regional Municipality of Waterloo.
8. District 8, comprising the counties of Dufferin and Simcoe and the regional municipalities of Halton and Peel, and the area east thereof to the Quebec border.

(2) A producer who resides in a district is a member of the group of producers for that district.

(3) A producer who does not reside in a district is a member of the group of producers for the district nearest to his or her place of residence.

7. There shall be a committee in each district to be known as the "District Soybean Growers' Committee".

8.—(1) On or before the 25th day of January, 1991, the members of each group of producers, except the group of producers for District 1, shall elect from among themselves one member for each 250 producers or fraction thereof to its District Soybean Growers' Committee.

(2) On or before the 25th day of January, 1991, the members of the group of producers for District 1 who do not reside on Pelee Island shall elect from among themselves one member for each 250 producers or fraction thereof to the District 1 Soybean Growers' Committee.

(3) On or before the 25th day of January, 1991, the members of the group of producers for District 1 who reside on Pelee Island shall elect from among themselves, to the District 1 Soybean Growers' Committee, the greater of,

- (a) one member for each 250 producers or fraction thereof; or
- (b) two members.

(4) The term of office of members elected at the elections mentioned in subsections (1), (2) and (3) shall be,

- (a) if the elected member receives a number of votes that ranks him or her in the top half of vote-getters, two years;
- (b) if the elected member receives a number of votes that ranks him or her in the bottom half of vote-getters, one year.

(5) If an odd number of members is elected under subsection (1), (2) or (3), the number of members elected for a two-year term shall be greater by one than the number elected for a one-year term.

(6) On or before the 25th day of January, 1992, and in each subsequent year, the members of each group of producers shall fill vacancies on each District Soybean Growers' Committee for a two-year term in accordance with subsections (1), (2) and (3).

9. On or before the 31st day of January in each year each District Soybean Growers' Committee shall elect members to the local board as follows:

1. District 1, three members.
2. District 2, four members.
3. District 3, three members.
4. Districts 4 to 8, one member each.

10.—(1) At its first meeting after the 31st day of January, the members elected to the local board shall appoint such members as are necessary to complete the local board.

(2) Where a member elected or appointed to the local board dies, resigns or is unable or unwilling to act as a member, the other mem-

bers of the local board may appoint a person to replace the member for the unexpired term.

11. No person is eligible for election or appointment to the local board from a district unless the person is a member of the group of producers for the district. R.R.O. 1980, Reg. 378, Sched.; O. Reg. 34/83, s. 1; O. Reg. 650/86, ss. 2, 3; O. Reg. 538/90, ss. 1, 2.

REGULATION 433

TENDER FRUIT—MARKETING

1. In this Regulation,

"local board" means The Ontario Tender Fruit Producers' Marketing Board;

"plan" means The Ontario Tender Fruit Producers' Marketing Plan;

"processing" means the manufacture of tender fruit products or juice, beverage spirits or wine from tender fruit, canning, bottling, distilling, fermenting, dehydrating, pitting, drying or freezing of tender fruit;

"processor" means a person engaged in the business of processing tender fruit;

"producer" means a person engaged in the production of tender fruit;

"tender fruit" means peaches, pears, plums, sour cherries and sweet cherries produced in Ontario. R.R.O. 1980, Reg. 381, s. 1; O. Reg. 611/90, s. 1.

2. This Regulation provides for the control and regulation in any or all respects of the producing and marketing within Ontario of tender fruit, including the prohibition of such producing and marketing in whole or in part. O. Reg. 506/85, s. 11.

3.—(1) Persons engaged in the production of tender fruit that is sold by a producer to a consumer are, in respect of the tender fruit that is sold to the consumer, exempt from this Regulation other than clauses 6 (a), (b) and (c). R.R.O. 1980, Reg. 381, s. 3 (1).

(2) Sweet cherries and sour cherries that are sold for any purpose other than processing by a processor are exempt from this Regulation. O. Reg. 611/90, s. 2.

4.—(1) No person shall commence or continue to engage in the processing of tender fruit except under the authority of a licence as a processor of tender fruit in Form 1.

(2) No licence in Form 1 shall be issued except upon application therefor in Form 2.

(3) A licence in Form 1 expires with the 31st day of January next following the date on which the licence is issued.

(4) A licence in Form 1 may be issued without charge. R.R.O. 1980, Reg. 381, s. 4.

5. The Commission may refuse to grant or renew, or suspend or revoke a licence as a processor,

(a) if the applicant or licensee is not qualified by experience, financial responsibility or equipment to properly engage in the business of a processor, or

(b) if the applicant or licensee has failed to comply with or has contravened the Act, the regulations, the Plan or any order or direction of the Commission or the local board. O. Reg. 611/90, s. 3.

6. The Commission delegates to the local board the power,
- (a) to require persons engaged in producing or marketing tender fruit to register their names, addresses and occupations with the local board;
 - (b) to require persons engaged in producing or marketing tender fruit to furnish such information relating to the production or marketing of tender fruit, including the completing and filing of returns, as the local board determines;
 - (c) to appoint persons to inspect the books, records, documents, lands and premises and any regulated product of persons engaged in producing or marketing tender fruit;
 - (d) to stimulate, increase and improve the marketing of tender fruit by such means as it considers proper;
 - (e) to co-operate with a marketing board, local board, marketing commission or marketing agency of Canada or of any province in Canada for the purpose of marketing tender fruit; and
 - (f) to do such acts and make such orders and issue such directions as are necessary to enforce the due observance and the carrying out of the Act, the regulations and the plan. R.R.O. 1980, Reg. 381, s. 6.
7. The Commission delegates to the local board its powers to make regulations with respect to tender fruit,
- (a) providing for the licensing of any or all persons before commencing or continuing to engage in the producing or marketing of tender fruit;
 - (b) prohibiting persons from engaging in the producing or marketing of tender fruit except under the authority of a licence issued by the local board;
 - (c) providing for the refusal to grant or renew, or the suspension or revocation of a licence,
 - (i) if the applicant or licensee is not qualified by experience, financial responsibility or equipment to properly engage in the business for which the application was made or the licence granted, or
 - (ii) if the applicant or licensee has failed to comply with or has contravened the Act, the regulations, the Plan or any order or direction of the Commission or the local board;
 - (d) authorizing the fixing of prompt payment discounts, delayed payment penalties and interest on licence fees and service charges owing by any person engaged in the producing or marketing of tender fruit;
 - (e) providing for the fixing of licence fees payable yearly, half-yearly, quarterly or monthly at different amounts or in instalments from any or all persons producing or marketing tender fruit and the collecting of the licence fees by suit in a court of competent jurisdiction;
 - (f) requiring any person who receives tender fruit to deduct from the money payable for the tender fruit any licence fees payable to the local board by the person from whom the tender fruit is received and to forward such licence fees to the local board;
 - (g) requiring any person who produces and processes tender fruit to furnish to the local board statements of the amounts of tender fruit that the person produced in any year and used for processing;
 - (h) prescribing the form of licences;
 - (i) subject to section 3, providing for the exemption from any or all of the regulations, orders or directions under the plan of any class, variety, grade or size of tender fruit, or any person or class of persons engaged in the producing or marketing of tender fruit or any class, variety, grade or size of tender fruit;
 - (j) requiring and providing for the furnishing of security or proof of financial responsibility or a performance bond by a person or class of persons engaged in the marketing of tender fruit and providing for the administration, forfeiture and disposition of money or securities furnished and the proceeds therefrom;
 - (k) providing for the control and regulation of the marketing of tender fruit, including the times and places at which tender fruit may be marketed;
 - (l) providing for the control and regulation of agreements entered into by producers of tender fruit with persons engaged in marketing or processing tender fruit, and the prohibiting of any provision or clause in such agreements;
 - (m) requiring any person who produces tender fruit to offer to sell and to sell the tender fruit to or through the local board;
 - (n) prohibiting any person from processing, packing or packaging any tender fruit that has not been sold by or through the local board; and
 - (o) providing for the making of agreements relating to the marketing of tender fruit through the local board, and prescribing the forms and the terms and conditions of such agreements. R.R.O. 1980, Reg. 381, s. 7; O. Reg. 611/90, s. 4.
- 8.—(1) The Commission authorizes the local board to use any class of licence fees, service charges and other money payable to it, for the purposes of paying the expenses of the local board, carrying out and enforcing the Act and the regulations and carrying out the purposes of the plan.
- (2) The Commission authorizes the local board to establish a fund in connection with the plan for the payment of any money that may be required for the purposes mentioned in subsection (1). R.R.O. 1980, Reg. 381, s. 8.
9. The Commission authorizes the local board to appoint agents, to prescribe their duties and terms and conditions of employment and to provide for their remuneration. R.R.O. 1980, Reg. 381, s. 9.
10. The Commission vests in the local board the following powers:
1. To direct and control, by order or direction, either as principal or agent, the marketing of tender fruit including the times and places at which tender fruit may be marketed.
 2. To determine the quality of each class, variety, grade and size of tender fruit that shall be marketed by each producer.
 3. To prohibit the marketing of any class, variety, grade or size of tender fruit.
 4. To determine from time to time the price or prices that shall be paid to producers or to the local board, as the case may be, for tender fruit or any class, variety, grade or size of tender fruit and to determine different prices for different parts of Ontario.
 5. To fix and impose service charges from time to time for the marketing of tender fruit.
 6. To require the price or prices payable or owing to the pro-

ducer for tender fruit to be paid to or through the local board.

7. To collect from any person by suit in a court of competent jurisdiction the price or prices or any part thereof of tender fruit.
8. To purchase or otherwise acquire such quantity or quantities of tender fruit as the local board considers advisable and to sell or otherwise dispose of any tender fruit so purchased or acquired.
9. To pay from service charges imposed under paragraph 5 its expenses in carrying out the purposes of the plan.
10. To pay to the producers the price or prices for tender fruit, less service charges imposed under paragraph 5 and to fix the times at which or within which such payments shall be made. R.R.O. 1980, Reg. 381, s. 10.

11. Each payment under paragraph 10 of section 10 shall be accompanied by a statement showing the kinds and the grades and quantity of each grade of tender fruit sold, the price or prices paid and the particulars of the service charges imposed by the local board. R.R.O. 1980, Reg. 381, s. 11.

12. The Commission authorizes the local board to conduct a pool or pools for the distribution of all money received from the sale of tender fruit and after deducting all necessary and proper disbursements and expenses, to distribute the remainder of the money received from the sale in such manner that every producer receives a share of the remainder of the money received from the sale in relation to the amount, class, variety, grade or size of tender fruit delivered by the producer and authorizes such local board to make an initial payment on delivery of the tender fruit and subsequent payments until all of the remainder of the money received from the sale is distributed to the producers. R.R.O. 1980, Reg. 381, s. 12.

13.—(1) There shall be three advisory committees to be known as the "Processing Advisory Committee" and the "Fresh Market Advisory Committee", each composed of a chair and six members, and the "Central Sales Policy Advisory Committee" composed of a chair and five members. O. Reg. 613/86, s. 1, *part*; O. Reg. 611/90, s. 5 (1).

(2) After the 1st day of April and before the 30th day of April in each year, appointments shall be made to the Processing Advisory Committee and the Fresh Market Advisory Committee as follows:

1. The Commission shall appoint the chair of each committee.
2. The local board shall appoint three members to each committee.
3. The Ontario Food Processors' Association shall appoint three members to the Processing Advisory Committee.
4. The Canadian Produce Marketing Association shall appoint three members to the Fresh Market Advisory Committee. O. Reg. 613/86, s. 1, *part*; O. Reg. 611/90, s. 5 (2).

(3) After the 1st day of April and before the 30th day of April in each year, appointments shall be made to the Central Sales Policy Advisory Committee as follows:

1. The Commission shall appoint the chair.
2. The local board shall appoint three members.
3. The Niagara Fruit Shippers Association Inc. shall appoint two members. O. Reg. 611/90, s. 5 (3).

(4) The members of the advisory committees remain members thereof until the 30th day of April in the year following the year in which they are appointed.

(5) Where for any reason a member of an advisory committee is unable or unwilling to act as a member, the body that appointed the member shall appoint a person to replace the member for the unexpired term.

(6) Where there is a failure to make an appointment to an advisory committee in accordance with subsection (2), (3) or (5), the Commission may appoint such members as are necessary to complete the committee.

(7) The Processing Advisory Committee is empowered, respecting tender fruit that is sold for processing, to advise and make recommendations to the local board or to the Ontario Food Processors' Association in respect of,

- (a) the promotion of harmonious relationships between persons engaged in the production and marketing of tender fruit;
- (b) the promotion of greater efficiency in the production and marketing of tender fruit;
- (c) the prevention and correction of irregularities and inequities in the marketing of tender fruit;
- (d) the improvement of the quality and variety of tender fruit;
- (e) the improvement of the circulation of market information respecting tender fruit; and
- (f) any matter in respect of which the Commission or the local board is empowered to make regulations under the Act.

(8) The Fresh Market Advisory Committee is empowered, respecting tender fruit that is sold for a purpose other than processing, to advise and make recommendations to the local board or to the Canadian Produce Marketing Association in respect of,

- (a) the promotion of harmonious relationships between persons engaged in the marketing of tender fruit;
- (b) the promotion of greater efficiency in the production and marketing of tender fruit;
- (c) the prevention and correction of irregularities and inequities in the marketing of tender fruit;
- (d) the improvement of the quality and variety of tender fruit;
- (e) the improvement of the circulation of market information respecting tender fruit; and
- (f) any matter in respect of which the Commission or the local board is empowered to make regulations under the Act. O. Reg. 613/86, s. 1, *part*; O. Reg. 611/90, s. 5 (4).

(9) The Central Sales Policy Advisory Committee is empowered, respecting tender fruit that is sold for a purpose other than processing, to advise and make recommendations to the local board regarding the operation of its central sales division in respect of,

- (a) the promotion of harmonious relationships between persons engaged in the marketing of tender fruit;
- (b) the promotion of greater efficiency in the production and marketing of tender fruit;
- (c) the prevention and correction of irregularities and inequities in the marketing of tender fruit;
- (d) the improvement of the quality and variety of tender fruit;
- (e) the improvement of the circulation of market information respecting tender fruit; and

(f) any matter in respect of which the Commission or the local board is empowered to make regulations under the Act. O. Reg. 613/86, s. 1, *part*.

Form 1

Farm Products Marketing Act

LICENCE AS A PROCESSOR OF TENDER FRUIT

Under the *Farm Products Marketing Act* and the regulations, and subject to the limitations thereof, this licence is issued

to
(name)

of.....
(address)

to engage in the processing of tender fruit.

This licence expires with the 31st day of January next following the date of issue.

Dated at, this day of, 19.....

THE FARM PRODUCTS MARKETING COMMISSION:

.....
Chairman

.....
Secretary

R.R.O. 1980, Reg. 381, Form 1.

Form 2

Farm Products Marketing Act

APPLICATION FOR LICENCE AS A PROCESSOR OF TENDER FRUIT

To: The Farm Products Marketing Commission:

.....
(name of applicant)

.....
(address)

makes application for a licence as a processor of tender fruit under the *Farm Products Marketing Act*.

Dated at, this day of, 19.....

.....
(signature of applicant)

.....
(where applicant is a corporation or partnership, signature of person authorized to sign)

R.R.O. 1980, Reg. 381, Form 2.

control of the marketing within Ontario of tender fruit. R.R.O. 1980, Reg. 380, s. 1.

2. The local board named in the Schedule is given the powers set out in subsection 15 (1), in paragraphs 1, 2, 3, 4, 5, 6, 7, 8, 10, 11, 12, 13, 14, 15, 16, 17, 18, 19 and 26 of subsection 15 (2) and in sections 50 and 110 of the *Co-operative Corporations Act*. R.R.O. 1980, Reg. 380, s. 2.

3. The members of the local board named in the Schedule shall be deemed to be the shareholders and directors of the local board in the exercise of the powers vested in the local board under section 2. R.R.O. 1980, Reg. 380, s. 3.

Schedule

Farm Products Marketing Act

PLAN

1. This plan may be cited as "The Ontario Tender Fruit Producers' Marketing Plan".

2. In this plan,

"processing" means the manufacture of tender fruit products or juice, beverage spirits or wine from tender fruit, canning, bottling, distilling, fermenting, dehydrating, pitting, drying or freezing of tender fruit;

"processor" means a person engaged in the business of processing tender fruit;

"producer" means a person engaged in the production of tender fruit;

"tender fruit" means peaches, pears, plums, sour cherries and sweet cherries produced in Ontario.

3. This plan provides for the control and regulation in any or all respects of the marketing within Ontario of tender fruit, including the prohibition of such marketing in whole or in part.

4. There shall be a local board to be known as "The Ontario Tender Fruit Producers' Marketing Board".

5. The local board shall be composed of eleven producer-members elected or appointed in accordance with sections 11 and 12.

6. Members of the local board shall be elected or appointed in accordance with the provisions of this plan and shall hold office until their successors are elected or appointed.

7. Producers are divided into four districts and the districts shall be comprised as follows:

1. District 1, comprising the Judicial District of Niagara North and the regional municipalities of Halton, Hamilton-Wentworth and Peel.

2. District 2, comprising the Judicial District of Niagara South.

3. District 3, comprising the counties of Essex, Kent and Lambton.

4. District 4, comprising The Regional Municipality of Haldimand-Norfolk and the counties of Brant and Elgin.

8.—(1) Producers in the Judicial District of Niagara South and in each of the regional municipalities and counties named in Districts 3 or 4 form a district or county group, as the case may be, but the producers in a regional municipality or county mentioned in Districts 3 and 4 may by order of the local board be joined with the producers of any other county in the same district to form a county group.

REGULATION 434

TENDER FRUIT—PLAN

1. The plan in the Schedule is continued for the regulation and

(2) A producer in an area of Ontario not included in a district mentioned in section 7 may become a member of the district or county group of producers nearest to his or her place of production.

9. There shall be a committee in each district to be known as the "District Tender Fruit Producers' Committee".

10.—(1) On or before the 31st day of March in each year the district group in the Judicial District of Niagara South and in each district or county group mentioned in Districts 3 and 4 shall elect a representative or representatives to the District Tender Fruit Producers' Committee on the basis of one representative for each thirty producers or fraction thereof.

(2) On or before the 31st day of March in each year the producers in the Town of Grimsby, the Township of West Lincoln, the Town of Lincoln, the City of St. Catharines, the Town of Niagara-on-the-Lake and the regional municipalities of Halton, Hamilton-Wentworth and Peel shall elect a representative or representatives to the District Tender Fruit Producers' Committee on the basis of one representative for each thirty producers or fraction thereof.

11.—(1) On or before the 15th day of April in each year, each District Tender Fruit Producers' Committee may elect, from the producers in the district, members to the local board as follows:

1. District 1, six members.
2. District 2, one member.
3. District 3, three members.
4. District 4, one member.

(2) No person is eligible for election from any district unless he or she is a producer in the district.

12.—(1) At its first meeting after the 15th day of April, the members elected to the local board shall appoint such producer-members as are necessary to complete the local board.

(2) Where a member elected or appointed to the local board dies or resigns, the members of the local board may appoint a producer-member for the unexpired term.

(3) Any person appointed a member to the local board under subsection (1) or (2) shall be a member of a district or county group for the district for which he or she is appointed. R.R.O. 1980, Reg. 380, Sched.; O. Reg. 610/90, s. 1.

REGULATION 435

TOBACCO—MARKETING

1. In this Regulation,

"buyer" means a person who buys tobacco;

"local board" means The Ontario Flue-Cured Tobacco Growers' Marketing Board;

"plan" means The Ontario Flue-Cured Tobacco Growers' Marketing Plan;

"producer" means a person engaged in the production of tobacco in Ontario;

"tobacco" means unmanufactured flue-cured tobacco produced in Ontario, including flue-cured tobacco purchased or otherwise acquired by and readied for storage and sale by the local board. R.R.O. 1980, Reg. 383, s. 1; O. Reg. 23/86, s. 1.

2. This Regulation provides for the control and regulation in any

or all respects of the producing and marketing within Ontario of tobacco, including the prohibition of such producing and marketing in whole or in part. R.R.O. 1980, Reg. 383, s. 2.

POWERS OF LOCAL BOARD

3. The Commission delegates to the local board the power,

- (a) to require persons engaged in producing or marketing tobacco to register their names, addresses and occupations with the local board;
- (b) to require persons engaged in producing or marketing tobacco to furnish such information relating to the production or marketing of tobacco, including the completing and filing of returns, as the local board determines;
- (c) to appoint persons to inspect the books, records, documents, lands and premises and any tobacco of persons engaged in the marketing of tobacco;
- (d) to appoint persons to inspect,
 - (i) the books, records and documents,
 - (ii) the lands and premises,
 - (iii) any tobacco, and
 - (iv) any growing plants or other development in the producing of tobacco,

of persons engaged in the producing of tobacco;

- (e) to stimulate, increase and improve the marketing of tobacco by such means as it considers proper; and
- (f) to co-operate with a marketing board, local board, marketing commission or marketing agency of Canada or of any province in Canada for the purpose of marketing tobacco;
- (g) to do such acts and make such orders and issue such directions as are necessary to enforce the due observance and carrying out of the Act, the regulations and the plan. R.R.O. 1980, Reg. 383, s. 3; O. Reg. 138/88, s. 1.

4. The Commission delegates to the local board its powers to make regulations with respect to tobacco,

- (a) providing for the licensing of any or all persons before commencing or continuing to engage in the producing or marketing of tobacco;
- (b) prohibiting persons from engaging in the producing or marketing of tobacco except under the authority of a licence issued by the local board;
- (c) providing for the refusal to grant a licence for the producing of tobacco for any reason that the local board considers proper;
- (d) providing for the refusal to grant a licence for the marketing of tobacco where the applicant is not qualified by experience, financial responsibility and equipment to engage in properly the business for which the application was made, or for any other reason that the local board considers proper;
- (e) providing for the suspension or revocation of, or the refusal to renew, a licence for failure to observe, perform or carry out the Act, the regulations, the plan, or any order or direction of the local board;
- (f) providing for the fixing of licence fees payable yearly, half-yearly, quarterly or monthly at different amounts or in

instalments from any or all persons producing or marketing tobacco and the collecting of the licence fees and the recovering of such licence fees by suit in a court of competent jurisdiction;

- (g) prescribing the form of licences;
- (h) providing for the exemption from any or all of the regulations, orders or directions under the plan of any class, variety or grade of tobacco, or any person or class of persons engaged in the producing or marketing of tobacco or any class, variety or grade of tobacco;
- (i) requiring the furnishing of security or proof of financial responsibility by any person engaged in the marketing of tobacco, and providing for the administration and disposition of any money or securities so furnished;
- (j) requiring any person who produces and processes tobacco to furnish to the local board statements of the amounts of tobacco that the person produced in any year and used for processing;
- (k) providing for the control and regulation of the producing of tobacco, including the times and places at which tobacco may be produced;
- (l) providing for the seizing, removing, destroying or otherwise disposing of any growing tobacco plants or tobacco produced or marketed in violation of the Act or the regulations and the retention or disposition by the local board of any of the proceeds of the sale thereof;
- (m) providing for the control and regulation of the marketing of tobacco, including the times and places at which tobacco may be marketed;
- (n) providing for the control and regulation of agreements entered into by producers of tobacco with persons engaged in marketing or processing tobacco, and the prohibition of any provision or clause in such agreements;
- (o) requiring any person who produces tobacco to offer to sell and to sell the tobacco through the local board;
- (p) prohibiting any person from processing, packing or packaging any tobacco that has not been sold by or through the local board;
- (q) providing for the regulating and the controlling of agreements entered into by producers of tobacco with persons engaged in marketing or processing tobacco, and the prohibition of any provision or clause in such agreements; and
- (r) providing for the making of agreements relating to the marketing of tobacco through the local board, and prescribing the forms and the terms and conditions of such agreements. R.R.O. 1980, Reg. 383, s. 4; O. Reg. 619/84, s. 1; O. Reg. 23/86, s. 2; O. Reg. 138/88, s. 1.

5. Subject to paragraph 6 of subsection 6 (1), no person shall market tobacco except through the local board. O. Reg. 23/86, s. 3, *part*.

6.—(1) The Commission vests in the local board the following powers:

- 1. To direct and control, by order or direction, either as principal or agent, the marketing of tobacco, including the times and places at which tobacco may be marketed.
- 2. To determine the quality of each class, variety, grade and size of tobacco that shall be marketed by each producer.

- 3. To prohibit the marketing of any class, variety, grade or size of tobacco.
- 4. To determine from time to time the price or prices that shall be paid to producers or to the local board, as the case may be, for any class, variety, grade or size of tobacco sold or otherwise disposed of pursuant to the power vested in the local board under paragraph 6.
- 5. To fix and impose from time to time service charges on producers for the marketing of tobacco.
- 6. Subject to subsections (2) and (3), to purchase or otherwise acquire at a tobacco exchange operated by the local board or from a person other than a producer such quantity or quantities of tobacco as the local board considers advisable and to sell or otherwise dispose of that tobacco.
- 7. To pay from service charges imposed under paragraph 5 its expenses in carrying out the purposes of the plan.
- 8. To pay to producers the price or prices for tobacco less service charges imposed under paragraph 5 and to fix the times at which or within which such payment shall be made. O. Reg. 23/86, s. 3, *part*; O. Reg. 138/88, s. 1.

(2) The power of the local board to purchase or otherwise acquire tobacco shall not be exercised except,

- (a) to purchase or otherwise acquire tobacco for the purposes of a transaction to sell tobacco where the local board has given the tobacco manufacturers, leaf dealers and processors the first right to enter into the transaction but they have been unwilling or unable to enter into the transaction in whole or in part; or
- (b) after the tobacco became available to be purchased on the exchange for the negotiated minimum grade price for that class, variety, grade or size of tobacco but was not purchased.

(3) Where the local board purchases tobacco under clause (2) (b), the purchase price shall be not less than the negotiated minimum grade price for that class, variety, grade or size of tobacco less the service charge imposed under paragraph 5 of subsection (1). O. Reg. 23/86, s. 3, *part*.

QUOTAS

6.—(1) The Commission authorizes the local board,

- (a) to require that tobacco be marketed on a quota basis;
- (b) to prohibit any person to whom a quota has not been fixed and allotted for the marketing of tobacco or whose quota has been cancelled from marketing any tobacco;
- (c) to prohibit any person to whom a quota has been fixed and allotted for the marketing of tobacco from marketing any tobacco in excess of such quota; and
- (d) to prohibit any person to whom a quota has been fixed and allotted for the marketing of tobacco produced on lands in respect of which such quota was fixed and allotted from marketing any tobacco other than the tobacco produced on such lands. R.R.O. 1980, Reg. 383, s. 6 (1); O. Reg. 138/88, s. 1.

(2) The Commission authorizes the local board,

- (a) to fix and allot to persons quotas for the marketing of tobacco on such basis as the local board considers proper;
- (b) to refuse to fix and allot to any person a quota for the mar-

keting of tobacco for any reason that the local board considers proper; and

- (c) to cancel or reduce, or refuse to increase, a quota fixed and allotted to any person for the marketing of tobacco for any person for the marketing of tobacco for any reason that the local board considers proper. R.R.O. 1980, Reg. 383, s. 6 (2); O. Reg. 138/88, s. 1.
- (3) The Commission authorizes the local board,
- (a) to require that tobacco be produced on a basis of tobacco acreage or other production quota;
- (b) to prohibit any person to whom a tobacco acreage or other production quota has not been fixed and allotted or whose tobacco acreage or other production quota has been cancelled from producing tobacco;
- (c) to prohibit any person to whom a tobacco acreage or other production quota has been fixed and allotted from producing any tobacco on acreage in excess of the tobacco acreage, or other production quota, fixed and allotted to such person; and
- (d) to prohibit any person from producing tobacco on land other than a tobacco farm in respect of which a tobacco acreage or other production quota has been fixed and allotted to such person. R.R.O. 1980, Reg. 383, s. 6 (3); O. Reg. 138/88, s. 1.
- (4) The Commission authorizes the local board,
- (a) to fix and allot to persons tobacco acreages or other production quotas on such basis as the local board considers proper;
- (b) to refuse to allot to any person a tobacco acreage or other production quota on such basis as the local board considers proper; and
- (c) to cancel or reduce, or refuse to increase, a tobacco acreage or other production quota fixed and allotted to any person for any reason that the local board considers proper. R.R.O. 1980, Reg. 383, s. 6 (4); O. Reg. 138/88, s. 1.

7.—(1) The Commission authorizes the local board to use any class of licence fees, service charges and other money payable to it for the purposes of paying the expenses of the local board, carrying out and enforcing the Act and the regulations and carrying out the purposes of the plan. R.R.O. 1980, Reg. 383, s. 7 (1); O. Reg. 23/86, s. 5; O. Reg. 138/88, s. 1.

(2) The Commission authorizes the local board to establish a fund in connection with the plan for the payment of any money that may be required for the purposes mentioned in subsection (1). R.R.O. 1980, Reg. 383, s. 7 (2); O. Reg. 138/88, s. 1.

8. The Commission authorizes the local board to require the price or prices payable or owing to the producers for tobacco to be paid to or through the local board and to recover such price or prices by suit in a court of competent jurisdiction. R.R.O. 1980, Reg. 383, s. 8; O. Reg. 138/88, s. 1.

9. The Commission authorizes the local board to prohibit the marketing of any class, variety or grade of tobacco. R.R.O. 1980, Reg. 383, s. 9; O. Reg. 138/88, s. 1.

POOLING

10. The Commission authorizes the local board to conduct a pool or pools for the distribution of all money received from the sale of tobacco and after deducting all necessary and proper disbursements and expenses, to distribute the remainder of the money received from the sale in such manner that every producer receives a share of

the remainder of the money received from the sale in relation to the amount, class, variety or grade of tobacco delivered, and authorizes the local board to make an initial payment on delivery of the tobacco and subsequent payments until all the remainder of the money received from the sale is distributed to the producers. R.R.O. 1980, Reg. 383, s. 10; O. Reg. 138/88, s. 1.

APPOINTMENT OF AGENTS

11. The Commission authorizes the local board to appoint agents, to prescribe their duties and terms and conditions of employment and to provide for their remuneration. R.R.O. 1980, Reg. 383, s. 11; O. Reg. 138/88, s. 1.

NEGOTIATING AGENCY

12.—(1) There shall be a negotiating agency to be known as the "Negotiating Committee for Tobacco" composed of such persons who are members of the negotiating agency under subsection (2). R.R.O. 1980, Reg. 383, s. 12 (1).

(2) The Negotiating Committee for Tobacco shall be comprised as follows:

1. Not more than two members appointed by Rothmans, Benson & Hedges Inc.
2. Not more than two members appointed by Imperial Tobacco Limited.
3. Not more than two members appointed by R.J.R. Macdonald Inc.
4. The members of the local board. R.R.O. 1980, Reg. 383, s. 12 (2); O. Reg. 652/85, s. 1; O. Reg. 298/87, s. 1.

(3) The persons entitled to appoint members under subsection (2) shall appoint the members and shall notify the Commission of the members' names and addresses before the 1st day of October in each year. R.R.O. 1980, Reg. 383, s. 12 (3); O. Reg. 138/88, s. 1.

(4) The persons who are members of the Negotiating Committee for Tobacco under subsection (2) remain members thereof until their successors become members.

(5) Where a member of the Negotiating Committee for Tobacco appointed under paragraphs 1 to 3 of subsection (2) dies or resigns or is unavailable to act before the expiration of his or her membership, the person who appointed him or her shall appoint a person for the unexpired term of such member. R.R.O. 1980, Reg. 383, s. 12 (4, 5).

13. The Negotiating Committee for Tobacco is empowered to adopt or settle by agreement,

- (a) minimum prices for tobacco;
- (b) terms and conditions relating to the marketing of tobacco; and
- (c) any charges relating to the marketing of tobacco. R.R.O. 1980, Reg. 383, s. 13.

14. A meeting of a negotiating agency may be convened by a notice in writing given by the members of the negotiating agency appointed by the local board or appointed by the buyers to the other members of the negotiating agency at least seven days, but not later than ten days, before the date of the meeting, stating the time and the place of the meeting. R.R.O. 1980, Reg. 383, s. 14.

CONCILIATION BOARD

15.—(1) Where a meeting of the negotiating agency is held and the negotiating agency does not arrive at an agreement respecting all matters that it is empowered to adopt or settle by agreement, the

negotiating agency may refer the matters in dispute to a conciliation board. R.R.O. 1980, Reg. 383, s. 15 (1).

(2) Where the negotiating agency refers the matters in dispute to a conciliation board, it shall so notify the Commission. R.R.O. 1980, Reg. 383, s. 15 (2); O. Reg. 138/88, s. 1.

16.—(1) The conciliation board shall be composed of three members of whom,

- (a) one shall be appointed by the members of the negotiating agency appointed by the local board;
- (b) one shall be appointed by the members of the negotiating agency appointed by the buyers; and
- (c) one shall be appointed by the Commission. R.R.O. 1980, Reg. 383, s. 16 (1); O. Reg. 138/88, s. 1.

(2) The members of the conciliation board shall be appointed within one week of the time that the negotiating agency notifies the Commission under subsection 15 (2). R.R.O. 1980, Reg. 383, s. 16 (2); O. Reg. 138/88, s. 1.

(3) The conciliation board is empowered,

- (a) to endeavour to effect agreement on any matter referred to in section 13 that the negotiating agency has failed to adopt or settle by agreement; and
- (b) to recommend adoption of any agreement effected under clause (a) to the negotiating agency.

(4) The recommendation of the conciliation board made under clause (3) (b) may include a minority report disagreeing in whole or in part with the recommendation of the majority of the conciliation board. R.R.O. 1980, Reg. 383, s. 16 (3, 4).

(5) The conciliation board shall submit its recommendations to the negotiating agency within two weeks of the time that the negotiating agency notifies the Commission under subsection 15 (2). R.R.O. 1980, Reg. 383, s. 16 (5); O. Reg. 138/88, s. 1.

ADVISORY COMMITTEE

17.—(1) There shall be a committee to be known as the "Tobacco Industry Advisory Committee". O. Reg. 23/86, s. 6, *part*.

(2) The Tobacco Industry Advisory Committee shall be composed of a chair and six members. O. Reg. 138/88, s. 2.

(3) After the 31st day of October and before the 30th day of November in each year, the following persons shall be appointed to the Tobacco Industry Advisory Committee:

- 1. The chair, who shall not be entitled to vote, to be appointed by the Commission.
- 2. Three members to be appointed by the local board.
- 3. Three members, one of whom is to be appointed by each of Rothmans, Benson & Hedges Inc., Imperial Tobacco Limited and R.J.R. Macdonald Inc. O. Reg. 23/86, s. 6, *part*; O. Reg. 298/87, s. 2; O. Reg. 138/88, s. 1.

(4) The members of the Tobacco Industry Advisory Committee hold office until the 30th day of November in the year following the year in which they are appointed.

(5) Where a member of the Tobacco Industry Advisory Committee dies, resigns or is unable or unwilling to act before the expiration of his or her term of office, the person or persons who appointed the member shall appoint a person for the unexpired term. O. Reg. 23/86, s. 6, *part*.

(6) The Tobacco Industry Advisory Committee may advise the local board and make recommendations to it in respect of,

- (a) the promotion of harmonious relationships between persons engaged in the production and marketing of tobacco;
- (b) the promotion of greater efficiency in the production and marketing of tobacco;
- (c) the prevention and correction of irregularities and inequities in the marketing of tobacco;
- (d) the improvement of the quality and variety of tobacco;
- (e) the improvement of the circulation of market information respecting tobacco; and
- (f) without limiting the generality of the foregoing, any matter with respect to which the Commission or the local board may be empowered to make regulations under the Act. O. Reg. 23/86, s. 6, *part*; O. Reg. 138/88, s. 1.

(7) The local board shall forthwith provide the Commission with full particulars of any recommendations made to the local board by the Tobacco Industry Advisory Committee. O. Reg. 23/86, s. 6, *part*; O. Reg. 138/88, s. 1.

REGULATION 436

TOBACCO—PLAN

1. The plan in the Schedule is continued for the control and regulation of the producing and marketing within Ontario of tobacco. O. Reg. 21/86, s. 1.

2. The local board named in the Schedule is given the powers set out in subsection 15 (1), in paragraphs 1, 2, 3, 4, 5, 6, 7, 8, 10, 11, 12, 13, 14, 15, 16, 17, 18, 19 and 26 of subsection 15 (2) and in sections 50 and 110 of the *Co-operative Corporations Act*. R.R.O. 1980, Reg. 382, s. 2.

3. The members of the local board named in the Schedule shall be deemed to be the shareholders and the directors of the local board in the exercise of the powers vested in the local board under section 2. R.R.O. 1980, Reg. 382, s. 3.

Schedule

Farm Products Marketing Act

PLAN

1. This plan may be cited as "The Ontario Flue-Cured Tobacco Growers' Marketing Plan".

2. In this plan,

"local board" means The Ontario Flue-Cured Tobacco Growers' Marketing Board;

"producer" means a person engaged in the production of tobacco in Ontario;

"tobacco" means unmanufactured flue-cured tobacco produced in Ontario, including flue-cured tobacco purchased or otherwise acquired and readied for storage and sale by the local board.

3.—(1) In this section,

"basic production quota" means a quota expressed as a specified number of pounds of tobacco fixed and allotted to a person by the local board and derived by the local board from a specified acreage;

“production quota” means a quota expressed as a specified number of pounds of tobacco fixed and allotted to a person by the local board to produce a specified number of pounds of tobacco in a year and derived by the local board from a basic production quota.

(2) For the purpose of electing producer representatives to the local board or The District Flue-Cured Tobacco Growers' Committee under sections 10 to 12, or for the purpose of being eligible to be a member thereof, a producer is an allottee of a basic production quota of not less than 10,000 pounds who produces tobacco on their own account pursuant to a production quota derived from that basic production quota, allotted for the year in which their qualification under sections 10 to 12 is at issue and who, subject to subsection (3), notifies the local board in writing prior to the 1st day of October in that year of the intention to market on their own account, pursuant to a marketing quota allotted by the local board, not less than the amount of tobacco that may be marketed pursuant to a marketing quota derived from a basic production quota of 10,000 pounds, and,

- (a) where the producer is a corporation, the person, if any, designated in writing by the corporation to be the producer, shall be deemed to be the producer;
- (b) where the producer is a firm or partnership or one or more persons carrying on the production and marketing under a trade name, farm name or other designation, the person, if any, designated in writing by the firm, partnership or persons to be the producer, shall be deemed to be the producer; and
- (c) where the producer is comprised of two or more persons who are joint allottees, the one of such joint allottees who first presents himself or herself to register to vote on behalf of the joint allottees shall be deemed to be the producer.

(3) Where the local board receives an affidavit of a producer, not later than the 1st day of October in any year in which elections are held in that district, that he or she would, but for adverse weather, be able to market the amount of tobacco referred to in subsection (2) but, owing to such adverse weather, will not be so able and where the local board is satisfied as to the truth of the matters stated in the affidavit, the local board may direct that the producer be eligible to elect producer representatives to the local board or The District Flue-Cured Tobacco Growers' Committee or be elected a member thereof in that year.

4. This plan provides for the control and regulation in any or all respects of the producing and marketing within Ontario of tobacco, including the prohibition of such producing and marketing in whole or in part.

5. There shall be a local board to be known as “The Ontario Flue-Cured Tobacco Growers' Marketing Board”.

6. The local board shall be composed of eleven members elected or appointed in accordance with sections 10 to 14 who shall hold office until their successors take office under subsection 14 (4).

7. There shall be ten districts determined as follows:

1. District 1, comprising the counties of Essex, Kent, Lambton and Bruce, the townships of Aldborough and Dunwich in the County of Elgin and the County of Middlesex except the Township of North Dorchester.
2. District 2, comprising the County of Brant except the Township of Oakland.
3. District 3, comprising the townships of Malahide, Southwold and Yarmouth in the County of Elgin and that part of the Township of Bayham west of the King's Highway known as No. 19 and the Township of North Dorchester in the County of Middlesex.
4. District 4, comprising the Township of Oakland in the

County of Brant and those parts of The Regional Municipality of Haldimand-Norfolk consisting of the former Township of Townsend and lots 1 to 12 in concessions 6 to 11 in the former Township of Windham, the counties of Northumberland, Simcoe and Dufferin and those parts of The Regional Municipality of Durham and the counties of Peterborough and Victoria formerly in the County of Durham.

5. District 5, comprising the County of Waterloo and the County of Oxford except lots 16 to 29 in Concession 12 in the Township of South Norwich and the former Township of Dereham.
6. District 6, comprising that part of The Regional Municipality of Haldimand-Norfolk consisting of the former Township of Windham in the former County of Norfolk except lots 1 to 12 in concessions 6 to 11.
7. District 7, comprising the Township of Middleton in The Regional Municipality of Haldimand-Norfolk and the former Township of Dereham and lots 16 to 29 in Concession 12 in the Township of South Norwich in the County of Oxford.
8. District 8, comprising that part of The Regional Municipality of Haldimand-Norfolk consisting of the former Township of North Walsingham in the former County of Norfolk.
9. District 9, comprising that part of The Regional Municipality of Haldimand-Norfolk consisting of the former Townships of Houghton and South Walsingham in the former County of Norfolk and that part of the Township of Bayham east of the King's Highway known as No. 19 in the County of Elgin.
10. District 10, comprising that part of The Regional Municipality of Haldimand-Norfolk consisting of the former townships of Charlotteville and Woodhouse in the former County of Norfolk.

8.—(1) Producers in each of the districts named in section 7 form a district group.

(2) A producer in a territorial district or in a county not included in a district mentioned in section 7 shall become a member of the district group of producers nearest to the producer's place of production.

9. There shall be a committee in each district to be known as “The District Flue-Cured Tobacco Growers' Committee” composed of not more than two members elected or appointed in accordance with sections 10 to 14 who shall hold office until their successors take office under subsection 14 (4).

10.—(1) On the first Wednesday in October in 1987, 1988 and in every second year thereafter, the members of the group of producers for Districts 1, 3, 5, 7 and 9 shall hold a meeting to nominate producers in those districts for election as a member of the local board and as members of The District Flue-Cured Tobacco Growers' Committee.

(2) On the first Wednesday in October in 1987 and in every second year thereafter, the members of the group of producers for Districts 2, 4, 6, 8 and 10 shall hold a meeting to nominate producers in those districts for election as a member of the local board and as members of The District Flue-Cured Tobacco Growers' Committee.

(3) Any producer in the district may nominate one producer in the district for election as a member of the local board.

(4) Any producer in the district may nominate one or more producers in the district, other than a producer nominated under subsection (3), for election as members of The District Flue-Cured Tobacco Growers' Committee.

(5) When the returning officer is satisfied that nominations under subsections (3) and (4) are complete, he or she shall so declare and, after giving each of the persons nominated an opportunity to decline his or her nomination, shall,

- (a) where not more than one person is nominated for election as a member of the local board, declare him or her elected; and
- (b) where not more than two persons are nominated for election as members of The District Flue-Cured Tobacco Growers' Committee, declare them elected.

11.—(1) In each district in which the member of the local board and the members of The District Flue-Cured Tobacco Growers' Committee were not elected by acclamation the local board shall arrange for such polling place or places as the local board determines.

(2) The third Tuesday in October in the year that nominations are held under subsection 10 (1) or 10 (2) is fixed as the day of the election of members of the local board and of The District Flue-Cured Tobacco Growers' Committee.

(3) The time of voting shall be from 10 a.m. to 8 p.m.

(4) At least seven days before the day for the election, the local board shall give notice in writing to the producers entitled to vote,

- (a) of the persons nominated under section 10;
- (b) of the day and time of the election; and
- (c) of the polling place or places at which the producers may vote.

12.—(1) The local board shall appoint a returning officer and such other persons as are required to assist him or her in the nominations and voting and shall furnish ballots as are required.

(2) Voting shall be by secret ballot.

(3) Where the second greatest number of votes for membership in The District Flue-Cured Tobacco Growers' Committee or the greatest number of votes for membership in the local board are received by more than one person, the local board shall hold such further elections as are necessary to break the tie.

(4) The member of the local board in a district is by virtue of his or her office a member of The District Flue-Cured Tobacco Growers' Committee for the district.

13.—(1) A producer is not eligible to vote for or hold office as a member of the local board or of The District Flue-Cured Tobacco Growers' Committee in more than one district.

(2) Where a producer is nominated for election as a member of the local board or The District Flue-Cured Tobacco Growers' Committee in more than one district, he or she shall, at least ten days before the date fixed for the election, notify the secretary of the local board in writing of the district for which he or she will be a candidate as a member of the local board or The District Flue-Cured Tobacco Growers' Committee.

(3) Where a producer fails to notify the secretary of the local board under subsection (2), the producer is not eligible for election as a member of the local board or The District Flue-Cured Tobacco Growers' Committee in any district other than the district in which he or she resides.

14.—(1) On the Thursday next following the fourth Tuesday in October in each year the members of the local board shall appoint,

- (a) the member not required to be elected under procedures in sections 10, 11 and 12; and

(b) such other members not elected under sections 10, 11 and 12 as are required to complete the local board.

(2) Each member appointed under clause (1) (b) shall be a producer in the district for which he or she is appointed.

(3) Where a member of the local board or of The District Flue-Cured Tobacco Growers' Committee dies, resigns or, except in the case of the member appointed under clause (1) (a), ceases to be a producer in the district for which he or she is elected or appointed, before the expiration of the term of membership, the members of the local board may appoint a person for the unexpired term and, except in the case of a person appointed to replace a member appointed under clause (1) (a), the person shall be a producer from the same district.

(4) Subject to subsection (3), the term of office of each member of the local board and of The District Flue-Cured Tobacco Growers' Committee shall commence with the Thursday next following the fourth Tuesday in October of the year in which the member is elected or appointed. R.R.O. 1980, Reg. 382, Sched.; O. Reg. 21/86, s. 2; O. Reg. 531/87, ss. 1-8.

REGULATION 437

TURKEYS—MARKETING

1. In this Regulation,

“dealer” means a person, other than a processor, who buys or receives turkeys from a producer;

“local board” means The Ontario Turkey Producers' Marketing Board;

“plan” means The Ontario Turkey Producers' Marketing Plan;

“processing” means the slaughtering of turkeys;

“processor” means a person engaged in the slaughtering of turkeys;

“producer” means a person engaged in the production of turkeys;

“turkey” means a turkey or any class or part thereof. R.R.O. 1980, Reg. 385, s. 1.

2. This Regulation provides for the control and regulation in any or all respects of the producing and marketing within Ontario of turkeys, including the prohibition of such producing and marketing in whole or in part. R.R.O. 1980, Reg. 385, s. 2.

LICENCES

3.—(1) No person shall commence or continue to engage in the processing of turkeys except under the authority of a licence as a processor of turkeys in Form 2.

(2) No licence in Form 2 shall be issued except on application therefor in Form 1. R.R.O. 1980, Reg. 385, s. 3.

4.—(1) A licence in Form 2 expires with the 31st day of March next following the date on which the licence is issued.

(2) A licence in Form 2 shall be issued without charge. R.R.O. 1980, Reg. 385, s. 4.

5.—(1) The Commission may refuse to grant a licence where the applicant is not qualified by experience, financial responsibility and equipment to properly engage in the business for which the application was made, or for any other reason that the Commission considers proper.

(2) The Commission may suspend or revoke or refuse to renew a

licence for failure to observe, perform or carry out the provisions of the Act, the regulations, the plan or any order or direction of the Commission or the local board. R.R.O. 1980, Reg. 385, s. 5.

POWERS OF LOCAL BOARD

6.—(1) The Commission authorizes the local board to use the licence fees and other money payable to it for the purpose of paying the expenses of the local board, carrying out and enforcing the Act and the regulations and carrying out the purposes of the plan.

(2) The Commission authorizes the local board to establish a fund in connection with the plan for the payment of any money that may be required for the purposes mentioned in subsection (1). R.R.O. 1980, Reg. 385, s. 6.

7. The Commission delegates to the local board the power,

- (a) to require persons engaged in producing or marketing turkeys to register their names, addresses and occupations with the local board;
- (b) to require persons engaged in producing or marketing turkeys to furnish such information relating to the production or marketing of turkeys, including the completing and filing of returns, as the local board determines;
- (c) to appoint persons to,
 - (i) inspect the books, records, documents, lands and premises and any turkeys of persons engaged in producing or marketing turkeys, and
 - (ii) enter on lands or premises used for the producing of turkeys and perform a count of turkeys;
- (d) to stimulate, increase and improve the marketing of turkeys by such means as it considers proper;
- (e) to co-operate with a marketing board, local board, marketing commission or marketing agency of Canada or of any province in Canada for the purpose of marketing turkeys;
- (f) to do such acts and make such orders and issue such directions as are necessary to enforce the due observance and carrying out of the Act, the regulations or the plan. R.R.O. 1980, Reg. 385, s. 7.

8. The Commission delegates to the local board its powers to make regulations,

- (a) providing for the licensing of any or all persons before commencing or continuing to engage in the producing or marketing of turkeys;
- (b) prohibiting persons from engaging in the producing or marketing of turkeys except under the authority of a licence;
- (c) providing for the refusal to grant a licence where the applicant is not qualified by experience, financial responsibility and equipment to engage in properly the business for which the application was made, or for any other reason that the local board considers proper;
- (d) providing for the suspension or revocation of, or the refusal to renew, a licence for failure to observe, perform or carry out the Act, the regulations, the plan or any order or direction of the Commission or local board;
- (e) providing for the fixing of licence fees payable yearly, half-yearly, quarterly or monthly at different amounts or in instalments from any or all persons producing or marketing turkeys and the collecting of the licence fees and the recovering of such licence fees in a court of competent jurisdiction;

- (f) requiring any person who receives turkeys to deduct from the money payable for the turkeys any licence fees payable to the local board by the person from whom the turkeys are received and to forward such licence fees to the local board;
- (g) requiring any person who produces and processes turkeys to furnish to the local board statements of the amounts of turkeys produced in any year and used for processing;
- (h) prescribing the form of licences;
- (i) providing for the exemption from any or all of the regulations, orders or directions under the plan of any class, variety, grade or size of turkeys, or any person or class of persons engaged in the producing or marketing of turkeys or any class, variety, grade or size of turkeys;
- (j) providing for the control and regulation of agreements entered into by producers of turkeys with persons engaged in marketing or processing turkeys, and the prohibition of any provision or clause in such agreements;
- (k) requiring any person who produces turkeys to offer to sell and to sell turkeys to or through the local board;
- (l) prohibiting any person from processing, packing or packaging any turkeys that have not been sold to, by or through the local board;
- (m) providing for the making of agreements relating to the marketing of turkeys by or through the local board, and prescribing the forms and the terms and conditions of such agreements. R.R.O. 1980, Reg. 385, s. 8; O. Reg. 506/85, s. 12 (1).

9.—(1) All turkeys shall be marketed through the local board.

(2) No person shall market turkeys except through the local board. R.R.O. 1980, Reg. 385, s. 10.

10. The Commission vests in the local board the following powers:

1. To direct and control, by order or direction, either as principal or agent, the marketing of turkeys, including the times and places at which turkeys may be marketed.
2. To determine the quality of each class, variety, grade or size of turkeys that shall be marketed by each producer.
3. To prohibit the marketing of any class, variety, grade or size of turkeys.
4. To determine from time to time the price or prices that shall be paid to producers or to the local board, as the case may be, for turkeys or any class, variety, grade or size of turkeys and to determine different prices for different parts of Ontario.
5. To require the price or prices payable or owing to the producer for turkeys to be paid to or through the local board.
6. To collect from any person by suit in a court of competent jurisdiction the price or prices or any part thereof of turkeys.
7. To purchase or otherwise acquire such quantity or quantities of turkeys as the local board considers advisable and to sell or otherwise dispose of any turkeys so purchased or acquired.
8. To pay to the producers the price or prices for turkeys and to fix the times at which or within which such payments shall be made. R.R.O. 1980, Reg. 385, s. 11.

11.—(1) The Commission authorizes the local board,

- (a) to require that turkeys be marketed on a quota basis;

ADVISORY COMMITTEE

- (b) to prohibit any person to whom a quota has not been fixed and allotted for the marketing of turkeys or whose quota has been cancelled from marketing any turkeys;
 - (c) to prohibit any person to whom a quota has been fixed and allotted for the marketing of turkeys from marketing any of the turkeys in excess of such quota; and
 - (d) to prohibit any person to whom a quota has been fixed and allotted for the marketing of turkeys produced on lands or premises in respect of which such quota was fixed and allotted from marketing any turkeys other than turkeys produced on such lands or premises.
- (2) The Commission authorizes the local board,
- (a) to fix and allot to persons quotas for the marketing of turkeys on such basis as the local board considers proper;
 - (b) to refuse to fix and allot to any person a quota for the marketing of turkeys for any reason that the local board considers proper;
 - (c) to cancel or reduce, or refuse to increase, a quota fixed and allotted to any person for the marketing of turkeys for any reason that the local board considers proper; and
 - (d) to permit any person to whom a quota has been fixed and allotted for the marketing of turkeys in excess of such quota on such terms and conditions as the local board considers proper. R.R.O. 1980, Reg. 385, s. 12.

12.—(1) The Commission authorizes the local board,

- (a) to require that turkeys be produced on a quota basis;
 - (b) to prohibit any person to whom a quota has not been fixed and allotted for the producing of turkeys or whose quota has been cancelled from producing any turkeys;
 - (c) to prohibit any person to whom a quota has been fixed and allotted for the producing of turkeys from producing any turkeys in excess of such quota; and
 - (d) to prohibit any person to whom a quota has been fixed and allotted for the producing of turkeys on lands or premises in respect of which such quota was fixed and allotted from producing any turkeys other than turkeys produced on such lands and premises.
- (2) The Commission authorizes the local board,
- (a) to fix and allot to persons quotas for the producing of turkeys on such basis as the local board considers proper;
 - (b) to refuse to fix and allot to any person a quota for the producing of turkeys for any reason that the local board considers proper;
 - (c) to cancel or reduce, or refuse to increase, a quota fixed and allotted to any person for producing turkeys for any reason that the local board considers proper, and, without limiting the generality of the foregoing, to cancel or reduce any such quota as a penalty where the local board believes on reasonable grounds that the person to whom the quota was fixed and allotted has contravened the Act or the regulations; and
 - (d) to permit any person to whom a quota has been fixed and allotted for the producing of turkeys to produce any turkeys in excess of such quota on such terms and conditions as the local board considers proper. R.R.O. 1980, Reg. 385, s. 13.

13.—(1) There shall be an advisory committee to be known as "The Turkey Industry Advisory Committee".

(2) The advisory committee shall be composed of nine members, one of whom shall be chair.

(3) After the 1st day of April and before the 30th day of April in each year,

- (a) the Commission shall appoint a person to be the chair of the advisory committee;
- (b) the local board shall appoint four persons to be members of the advisory committee;
- (c) the Ontario Poultry Processors' Association shall appoint two persons to be members of the advisory committee;
- (d) the Ontario Division of the Canadian Feed-Manufacturers' Association shall appoint one person to be a member of the advisory committee; and
- (e) the Ontario Hatcheries Association shall appoint one person to be a member of the advisory committee.

(4) The members of the advisory committee appointed under subsection (3) shall hold office until the 30th day of April in the year next following the year in which they were appointed.

(5) Where a member of The Turkey Industry Advisory Committee dies or resigns or is unavailable to act before the expiration of his or her term, the person or persons who appointed him or her shall appoint a person for the unexpired term of the member who died, resigned or was unavailable to act.

(6) Where the local board, the Ontario Poultry Processors' Association, the Ontario Division of the Canadian Feed Manufacturers' Association or the Ontario Hatcheries Association, as the case may be, fail to appoint a member or members to The Turkey Industry Advisory Committee in accordance with the provisions of subsection (3) or (5), the Commission may appoint such members as are necessary to complete the advisory committee.

(7) No person is excluded from being appointed a member of the advisory committee by reason solely of being a member of the negotiating agency referred to in section 14, and vice versa.

(8) A meeting of The Turkey Industry Advisory Committee may be convened by the chair thereof by giving notice to the members of the time and place and date of the meeting not less than seven days and not more than ten days prior to the date of the meeting.

(9) Subject to subsection (10), The Turkey Industry Advisory Committee may advise and make recommendations to the local board, the Ontario Poultry Processors' Association, the Ontario Division of the Canadian Feed Manufacturers' Association and the Ontario Hatcheries Association in respect of any of the following matters:

- 1. The promotion of harmonious relationships between persons engaged in the production and marketing of turkeys.
- 2. The promotion of greater efficiency in the production and marketing of turkeys.
- 3. The prevention and correction of irregularities and inequities in the marketing of turkeys.
- 4. The improvement of the quality and variety of turkeys.
- 5. The improvement of the circulation of market information respecting turkeys.

6. Without limiting the generality of any of the foregoing, any matter with respect to which this Regulation is made.

(10) The Turkey Industry Advisory Committee may recommend to the local board in advance, the total quotas for turkeys or any class, variety, grade or size of turkeys, for any period or periods of time up to but not exceeding one year.

(11) The local board shall forthwith provide the Commission with full particulars of any recommendations made to the local board by The Turkey Industry Advisory Committee respecting total quotas. R.R.O. 1980, Reg. 385, s. 14.

NEGOTIATING AGENCY

14.—(1) There shall be a negotiating agency to be known as "The Negotiating Committee for Turkeys" composed of seven persons to be appointed on or before the 1st day of April in each year of whom three shall be appointed by the local board, two shall be appointed by the Ontario Poultry Processors' Association, one shall be appointed by the Ontario Division of the Canadian Feed Manufacturers' Association, and the chair shall be appointed by the Commission.

(2) Each member of the negotiating agency shall hold office until the 31st day of March of the year next following his or her appointment.

(3) Where a member of The Negotiating Committee for Turkeys dies or resigns or is unavailable to act before the expiration of his or her term, the person or persons who appointed him or her shall appoint a person for the unexpired term of the member who died, resigned or was unavailable to act.

(4) Where the Ontario Poultry Processors' Association, the Ontario Division of the Canadian Feed Manufacturers' Association or the local board, as the case may be, fail to appoint a member or members to The Negotiating Committee for Turkeys in accordance with the provisions of subsection (1) or (2), the Commission may appoint such members as are necessary to complete the negotiating agency.

(5) A meeting of The Negotiating Committee for Turkeys may be convened by a notice in writing given by the three members appointed by the local board or by the three members appointed by the Ontario Poultry Processors' Association and the Ontario Division of the Canadian Feed Manufacturers' Association to the other members and the chair at least seven days but not more than ten days before the date of the meeting stating the time and place of the meeting. R.R.O. 1980, Reg. 385, s. 15.

15. The Negotiating Committee for Turkeys may settle by agreement,

- (a) terms, conditions and forms of agreements relating to the production or marketing of turkeys; and
- (b) any charges, costs or expenses relating to the production or marketing of turkeys. R.R.O. 1980, Reg. 385, s. 16.

16. The Commission authorizes the local board to conduct a pool or pools for the distribution of all money received from the sale of turkeys and, after deducting all necessary and proper disbursements and expenses, to distribute the remainder of the money received from the sale in such manner that every producer receives a share of the remainder of the money received from the sale in relation to the amount, class, variety, grade or size of turkeys delivered by the producer, and authorizes the local board to make an initial payment on delivery of the turkeys and subsequent payments until all of the remainder of the money received from the sale is distributed to the producers. R.R.O. 1980, Reg. 385, s. 17.

17. The Commission authorizes the local board to appoint agents, to prescribe their duties and terms and conditions of employment

and to provide for their remuneration. R.R.O. 1980, Reg. 385, s. 18.

18. The local board, in carrying out the powers vested in it under paragraph 4 of section 10, shall take into account levies, licence fees or service charges imposed on producers that are used by the local board to stimulate, increase or improve the marketing of turkeys. O. Reg. 325/81, s. 1.

Form 1

Farm Products Marketing Act

APPLICATION FOR LICENCE AS A PROCESSOR OF TURKEYS

To: The Farm Products Marketing Commission:

.....
(name of applicant)

.....
(address)

makes application for a licence as a processor of turkeys under the *Farm Products Marketing Act*.

Dated at, this day of, 19.....

.....
(signature of applicant)

.....
(where applicant is a corporation or partnership, signature of person authorized to sign)

.....
(office)

R.R.O. 1980, Reg. 385, Form 1.

Form 2

Farm Products Marketing Act

LICENCE AS A PROCESSOR OF TURKEYS

Under the *Farm Products Marketing Act* and the regulations, and subject to the limitations thereof, this licence is issued to:

.....
(name)

of
(address)

to engage in the processing of turkeys.

This licence expires with the 31st day of March next following the date of issue.

Dated at Toronto, this day of, 19.....

THE FARM PRODUCTS MARKETING COMMISSION:

.....
Chair

.....
Secretary

R.R.O. 1980, Reg. 385, Form 2.

REGULATION 438

TURKEYS—MARKETING LIMITATIONS

1. The Commission considers it necessary and advisable and requires that the local board carry out the purposes of The Ontario Turkey Producers' Marketing Plan established by Regulation 439 of Revised Regulations of Ontario, 1990 in accordance with the Schedule. R.R.O. 1980, Reg. 386, s. 1.

2. Sections 1 and 2 of Regulation 437 of Revised Regulations of Ontario, 1990 apply to this Regulation with necessary modifications. R.R.O. 1980, Reg. 386, s. 2.

Schedule

1. In this Schedule,

"Agency" means the Canadian Turkey Marketing Agency;

"quota" means a quota fixed and allotted to a producer under section 12 of Regulation 437 of Revised Regulations of Ontario, 1990;

"quota system" means the method by which the quota fixed and allotted to a producer is determined.

2. The local board shall establish a quota system in order to fix and allot quotas to all members of classes of producers in Ontario in such manner that the number of pounds of turkey meat produced in Ontario and authorized to be marketed in intraprovincial trade in the year 1973 when taken together with the number of pounds of turkey meat produced in Ontario and authorized to be marketed in interprovincial and export trade, in the same year under quotas assigned by the Agency and the number of pounds of turkey meat produced in Ontario and anticipated to be marketed in the same year, other than as authorized by a quota assigned by the Agency or fixed and allotted by the local board, will equal the number of pounds of turkey meat set out in section 3 of this Schedule.

3. For the purposes of section 2 of this Schedule, the number of pounds of turkey meat set out in this section is as set out in the Table:

TABLE

92,000,000 pounds.

4.—(1) No order or regulation shall be made where the effect thereof would be to increase the aggregate of,

- (a) the number of pounds of turkey meat produced in Ontario and authorized by quotas fixed and allotted by the local board and assigned by the Agency to be marketed in intraprovincial, interprovincial and export trade; and
- (b) the number of pounds of turkey meat produced in Ontario and anticipated to be marketed in intraprovincial, interprovincial and export trade other than as authorized by quotas fixed and allotted by the local board and assigned by the Agency,

to a number that exceeds, on a yearly basis, the number of pounds of turkey meat set out in section 3 of this Schedule unless the local board has taken into account,

- (c) the principle of comparative advantage of production in respect of each province in Canada;
- (d) any variation in the size of the market for turkeys;
- (e) any failures by turkey producers in Ontario or in other provinces of Canada to market the number of pounds of turkey meat authorized to be marketed;

- (f) the feasibility of increased production in each province of Canada available to be marketed;
- (g) existing production and storage facilities in each province of Canada; and
- (h) the comparative transportation costs to market areas from alternative sources of production,

and the Agency is making a similar order or regulation.

(2) Where the Agency has made an order or regulation under the provisions of a marketing plan similar to the provisions of subsection (1), the local board shall make a similar order or regulation.

5. The local board may require each turkey producer to whom a quota is fixed and allotted as a condition of the fixing and allotting thereof, to make available to the local board or its agent all turkeys produced and available to be marketed in excess of the quota fixed and allotted to the producer at a price not exceeding the difference, if any, between the price realized by the local board or its agent on the marketing of such turkeys and its expenses related to such marketing.

6. The local board shall not market any quantity of the products made available to it in excess of the number of pounds of turkey meat referred to in sections 2 and 3 of this Schedule, or as modified under section 4 of this Schedule, without prior consultation with the Agency.

7. The local board shall, with the concurrence of the Agency, administer on its behalf all orders and regulations made by it for the purpose of establishing and implementing a quota system or any such orders or regulations necessary to implement the provisions of the Canadian Turkey Marketing Agency Proclamation and similar provisions of this Schedule.

8. The local board shall make, approve and implement any orders or regulations necessary to give effect to any provisions of this Schedule.

9. The local board shall make available to the Agency any document or extract of documents establishing the registration or licensing of producers, when any such system is in force.

10. The local board shall, with the concurrence of the Agency, collect on its behalf any levies imposed by the Agency.

11.—(1) The local board shall make regulations and orders requiring of producers, processors, packers, dealers and wholesalers all information necessary to monitor sales of turkeys.

(2) The local board shall establish a system for verification of sales.

(3) The local board shall provide all information obtained from the implementation of the system referred to in subsection (2) to the Agency when so requested by the Agency.

12. The local board shall take all reasonable steps to promote a high degree of co-operation between itself and the Agency and, without limiting the generality of the foregoing, shall,

- (a) make available to the Agency the records, minutes and decisions of the local board in relation to any matter that is of concern to the Agency;
- (b) allow any officer or employee of the Agency who is designated by the Agency for such purpose to attend meetings of the local board at which any matter that is of concern to the Agency is likely to be discussed and for such purpose shall give notice of all such meetings to the officer or employee so designated; and
- (c) give notice of each order or regulation that it proposes to

make to the Agency that is likely to affect the Agency in its operations.

13. The authority and powers referred to in Regulation 437 of Revised Regulations of Ontario, 1990, are limited by and subject to this Schedule. R.R.O. 1980, Reg. 386, Sched.

REGULATION 439

TURKEYS—PLAN

1. The plan in the Schedule is continued for the control and regulation of the marketing within Ontario of turkeys. R.R.O. 1980, Reg. 384, s. 1.

2. The local board named in the Schedule is given the powers set out in subsection 15 (1), in paragraphs 1, 2, 3, 4, 5, 6, 7, 8, 10, 11, 12, 13, 14, 15, 16, 17, 18, 19 and 26 of subsection 15 (2) and in sections 50 and 110 of the *Co-operative Corporations Act*. R.R.O. 1980, Reg. 384, s. 2.

3. The members of the local board named in the Schedule shall be deemed to be the shareholders and the directors of the local board in the exercise of the powers vested in the local board under section 2. R.R.O. 1980, Reg. 384, s. 3.

Schedule

Farm Products Marketing Act

PLAN

1. This plan may be cited as "The Ontario Turkey Producers' Marketing Plan".

2. In this plan,

"dealer" means a person, other than a processor, who buys or receives turkeys from a producer;

"processing" means the slaughtering of turkeys;

"processor" means a person engaged in the slaughtering of turkeys;

"producer" means a person engaged in the production of turkeys;

"turkey" means a turkey or any class or part thereof.

3. This plan provides for the control and regulation in any or all respects of the producing and marketing within Ontario of turkeys, including the prohibition of such producing and marketing in whole or in part.

4. There shall be a local board to be known as "The Ontario Turkey Producers' Marketing Board".

5. The local board shall be composed of eight producer-members, of whom two shall be from District 5 and one from each of the other districts.

6. The members of the local board shall be elected or appointed in accordance with the provisions of this plan and shall hold office until their successors are elected or appointed.

7. Producers are divided into seven districts as follows:

1. District 1, comprising the counties of Essex, Kent and Lambton.
2. District 2, comprising the counties of Huron and Middlesex.

3. District 3, comprising the counties of Elgin, Oxford and Perth.

4. District 4, comprising the County of Brant, The Regional Municipality of Hamilton-Wentworth and that part of The Regional Municipality of Haldimand-Norfolk that, on the 31st day of March, 1974, was the County of Norfolk.

5. District 5, comprising The Regional Municipality of Niagara and that part of The Regional Municipality of Haldimand-Norfolk that, on the 31st day of March, 1974, was the County of Haldimand.

6. District 6, comprising the County of Wellington and The Regional Municipality of Waterloo.

7. District 7, comprising those parts of Ontario not included in Districts 1 to 6.

8. Producers in each of the districts named in section 7 form a district group.

9. For the purpose of elections in each year, there shall be a committee in each district to be known as the "District Turkey Producers' Committee" comprised of the following numbers of producer-members:

1. District 1, six members.
2. District 2, five members.
3. District 3, six members.
4. District 4, five members.
5. District 5, eleven members.
6. District 6, six members.
7. District 7, six members.

10.—(1) On or before the 1st day of May in every second odd-numbered year, the producers in Districts 1, 2, 3 and 4 shall elect from among themselves their representatives to the District Turkey Producers' Committee and to the local board, to hold office for two years from the 1st day of May.

(2) On or before the 1st day of May in every second even-numbered year, the producers in Districts 5, 6 and 7 shall elect from among themselves their representatives to the District Turkey Producers' Committee and to the local board, to hold office for two years from the 1st day of May.

(3) No person is eligible for election to the local board who is not an elected representative to the District Turkey Producers' Committee.

(4) No person is eligible for election from any district to the local board unless he or she resides within the district.

11.—(1) Where the producers in any district fail to elect a representative to the local board in accordance with the provisions of section 10, the members of the local board shall, at its first meeting after the 1st day of May, appoint such producer-members as are necessary to complete the local board.

(2) When a member elected or appointed to the local board dies or resigns before his or her term has expired, the members of the local board may appoint a producer-member for the unexpired term.

(3) Each producer-member appointed as a member to the local board under subsection (1) or (2) shall be a producer in the district for which he or she is appointed.

(4) Where the members of the local board fail to appoint a per-

son for the unexpired term of a member under subsection (2) within seven days from the death or resignation of the member, the Commission may appoint a person for the unexpired term. R.R.O. 1980, Reg. 384, Sched.; O. Reg. 100/83, ss. 1, 2, *revised*.

REGULATION 440

VEGETABLES FOR PROCESSING—MARKETING

1. In this Regulation,

“local board” means The Ontario Vegetable Growers’ Marketing Board;

“plan” means The Ontario Vegetable Growers’ Marketing-for-Processing Plan;

“processing” means,

- (a) canning, dehydrating, drying, freezing, pickling or processing with sugar or sulphur dioxide or any other chemical or by heat, and combining or mixing a vegetable with one or more other vegetables, or
- (b) entering into a contract for the purchase of vegetables for the purpose of performing on the vegetables any of the operations mentioned in clause (a);

“processor” means a person engaged in the business of processing vegetables;

“producer” means a person engaged in the production of vegetables;

“vegetables” means the following vegetables produced in Ontario and used for processing:

green and wax beans, lima beans, red beets, cabbage other than cabbage used for coleslaw, carrots, cauliflower, sweet corn, cucumbers, green peas, peppers, pumpkin and squash or tomatoes. R.R.O. 1980, Reg. 388, s. 1; O. Reg. 583/87, s. 1.

2. This Regulation provides for the control and regulation in any or all respects of the producing and marketing within Ontario of vegetables, including the prohibition of such producing and marketing in whole or in part. O. Reg. 506/85, s. 13.

LICENCES

3.—(1) No person shall commence or continue to engage in the processing of vegetables except under the authority of a licence from the Commission and except in compliance with the terms and conditions of the licence.

(2) A licence expires on the 28th day of February following the date on which it was issued.

(3) Where the Commission issues a licence to a processor, the Commission shall not charge a licence fee to the processor. O. Reg. 70/88, s. 2.

4. The Commission may refuse to grant or renew a licence or may suspend or revoke a licence,

- (a) where the applicant or licensee is not qualified by experience, financial responsibility or equipment to properly engage in the business for which the application was made or the licence granted; or
- (b) where the applicant or licensee has failed to comply with or has contravened the Act, the regulations, the plan or any order or direction of the Commission. O. Reg. 70/88, s. 3, *part*.

5. The Commission may impose such terms and conditions upon a licence as the Commission considers proper. O. Reg. 70/88, s. 3, *part*.

6. Where, after a hearing, the Commission is of the opinion that the applicant or licensee has failed to comply with or has contravened any term or condition of the licence or the Act, the regulations, the plan or any order or direction of the Commission, the Commission may impose a penalty on the applicant or licensee. O. Reg. 70/88, s. 3, *part*.

7.—(1) The Commission may require that a processor furnish a performance bond that shall not exceed 10 per cent of the price payable to producers for vegetables processed during the immediately preceding twelve-month period by the processor.

(2) The Commission may determine that the performance bond is forfeited when the processor who furnished the bond fails to comply with or contravenes any term or condition of the processor’s licence or the Act, the regulations, the plan or any order or direction of the Commission. O. Reg. 70/88, s. 3, *part*.

8.—(1) If a penalty is imposed under section 6 or a performance bond is forfeited under subsection 7 (2), the Commission shall pay the penalty or the proceeds of the performance bond, or both, to the local board for distribution proportionately among the producers of vegetables who sold vegetables to the processor and who did not receive the minimum price for the vegetables.

(2) If there are no producers as described in subsection (1), the Commission shall pay the penalty or the proceeds of the performance bond, or both, into the Consolidated Revenue Fund. O. Reg. 70/88, s. 3, *part*.

POWERS OF LOCAL BOARD

9. The Commission delegates to the local board the power,

- (a) to require persons engaged in producing or marketing vegetables to register their names, addresses and occupations with the local board;
- (b) to require persons engaged in producing or marketing vegetables to furnish such information relating to the production or marketing of vegetables, including the completing and filing of returns, as the local board determines;
- (c) to appoint persons to inspect the books, records, documents, lands and premises and any vegetables of persons engaged in producing or marketing vegetables;
- (d) to appoint persons to enter on lands or premises used for the producing of vegetables and measure the area of land used to produce vegetables;
- (e) to stimulate, increase and improve the marketing of vegetables by such means as it considers proper;
- (f) to co-operate with a marketing board, local board, marketing commission or marketing agency of Canada or of any province in Canada for the purpose of marketing vegetables; and
- (g) to do such acts and make such orders and issue such directions as are necessary to enforce the due observance and carrying out of the Act, the regulations and the plan.

R.R.O. 1980, Reg. 388, s. 5; O. Reg. 123/86, s. 1; O. Reg. 70/88, s. 1.

10. The Commission delegates to the local board its powers to make regulations with respect to vegetables,

- (a) providing for the licensing of any or all producers before

- commencing or continuing to engage in the producing or marketing of vegetables;
- (b) prescribing or providing for classes of licences and the imposition of terms and conditions on any class of licence;
- (c) prohibiting producers from engaging in the producing or marketing of vegetables except under the authority of a licence and except in compliance with the terms and conditions of the licence;
- (d) providing for the refusal to grant or renew a licence or for the suspension or revocation of a licence,
- (i) where the applicant or licensee is not qualified by experience, financial responsibility or equipment to properly engage in the business for which the application was made or the licence granted, or
- (ii) where the applicant or licensee has failed to comply with or has contravened the Act, the regulations, the plan or any order or direction of the Commission, Director or local board or of a marketing agency of Canada;
- (e) providing for the imposition, amount, disposition and use of penalties where, after a hearing, the local board is of the opinion that the applicant or licensee has failed to comply with or has contravened any term or condition of the licence or the Act or the regulations, the plan or any order or direction of the local board;
- (f) providing for the fixing of licence fees and the payment thereof by any or all producers who are engaged in the producing or marketing of vegetables and the collecting of the licence fees and their recovery by suit in a court of competent jurisdiction;
- (g) prescribing the form of licences;
- (h) authorizing the fixing of prompt payment discounts, delayed payment penalties and interest on licence fees and service charges owing by any producer or processor or by any person engaged in the marketing of vegetables;
- (i) providing for the control and regulation of the producing or marketing of vegetables, including the times and places at which vegetables may be produced or marketed;
- (j) providing for the control and regulation of agreements entered into by producers of vegetables with persons engaged in marketing or processing vegetables and the prohibition of any provision or clause in such agreements;
- (k) requiring any person who produces and processes vegetables to furnish to the local board statements of the amounts of vegetables that he produced in any year and used for processing;
- (l) requiring that no charges, costs or expenses relating to the production or marketing of a vegetable shall be made other than such charges, costs or expenses as are provided in the agreement or award or renegotiated agreement or award in force for the marketing of the vegetable;
- (m) requiring any person who produces vegetables to offer to sell and to sell the vegetables through the local board;
- (n) prohibiting any person from processing, packing or packaging any vegetables that have not been sold by or through the local board; and
- (o) requiring any person who receives vegetables to deduct from the money payable for the vegetables, any licence fees payable to the local board by the person from whom the

vegetables are received, and to forward the licence fees to the local board. R.R.O. 1980, Reg. 388, s. 6; O. Reg. 70/88, ss. 1, 4.

11. The local board may impose such terms and conditions upon a licence as the local board considers proper. O. Reg. 70/88, s. 5.

12. The Commission limits the powers of the local board under clause 10 (j) to matters that are not inconsistent with terms, conditions and forms of agreement settled under clause 17 (b) by a negotiating agency or awarded under subsection 21 (5) by an arbitration board. R.R.O. 1980, Reg. 388, s. 7; O. Reg. 70/88, s. 1.

13.—(1) The Commission authorizes the local board to use any class of licence fees, service charges and other money payable to it, for the purposes of paying the expenses of the local board, carrying out and enforcing the Act and the regulations and carrying out the purposes of the plan. R.R.O. 1980, Reg. 388, s. 8 (1); O. Reg. 70/88, s. 1.

(2) The Commission authorizes the local board to establish a fund in connection with the plan for the payment of any money that may be required for the purposes mentioned in subsection (1). R.R.O. 1980, Reg. 388, s. 8 (2); O. Reg. 70/88, s. 1.

14. The Commission authorizes the local board to require the price or prices payable or owing to the producers for vegetables to be paid to or through the local board. R.R.O. 1980, Reg. 388, s. 9; O. Reg. 70/88, s. 1.

15. The Commission authorizes the local board to prohibit the marketing locally within Ontario of any class, variety, grade or size of vegetables. R.R.O. 1980, s. 388, s. 10; O. Reg. 70/88, s. 1.

NEGOTIATING AGENCIES

16.—(1) There shall be twelve negotiating agencies to be known as,

- (a) "The Negotiating Committee for Green and Wax Beans";
- (b) "The Negotiating Committee for Lima Beans";
- (c) "The Negotiating Committee for Red Beets";
- (d) "The Negotiating Committee for Cabbage";
- (e) "The Negotiating Committee for Carrots";
- (f) "The Negotiating Committee for Cauliflower";
- (g) "The Negotiating Committee for Sweet Corn";
- (h) "The Negotiating Committee for Cucumbers";
- (i) "The Negotiating Committee for Green Peas";
- (j) "The Negotiating Committee for Peppers";
- (k) "The Negotiating Committee for Pumpkin and Squash"; and
- (l) "The Negotiating Committee for Tomatoes". R.R.O. 1980, Reg. 388, s. 11 (1).

(2) Each negotiating agency named in subsection (1) shall be composed of not more than six persons of whom not more than three shall be appointed annually by processors of the vegetable mentioned in the clause and of whom an equal number shall be appointed by the local board. R.R.O. 1980, Reg. 388, s. 11 (2).

(3) Not later than the 15th day of January in each year the local board and the processors shall notify the Commission in writing of the names and addresses of the persons they appointed under subsection (2). O. Reg. 174/85, s. 1, *part*; O. Reg. 70/88, s. 1.

(4) Subject to subsections (5) and (6), the members of the negotiating agencies appointed under subsection (2) are and remain members until the 14th day of January of the year next following the year in which they were appointed. O. Reg. 174/85, s. 1, *part*.

(5) Where a member of a negotiating agency appointed under subsection (2) dies or resigns or is unable to act because of injury, illness or circumstances beyond his or her control before the expiration of his or her term of membership, the local board or the processors, as the case may be, who appointed him or her shall appoint a person for the unexpired term of the member who died, resigned or was unable to act. R.R.O. 1980, Reg. 388, s. 11 (5).

(6) Where the local board or the processors, as the case may be, fail to make an appointment under subsection (5) within seven days after a vacancy occurs, the Commission shall appoint such persons as are necessary to complete the negotiating agency. R.R.O. 1980, Reg. 388, s. 11 (6); O. Reg. 70/88, s. 1.

(7) Where the local board or the processors, as the case may be, fail to appoint the persons under subsection (2), the Commission shall appoint such persons as are necessary to complete the negotiating agency. R.R.O. 1980, Reg. 388, s. 11 (7); O. Reg. 70/88, s. 1.

17. Each negotiating agency named in clauses 16 (1) (a) to (l) is empowered to adopt or settle by agreement in respect of the vegetable or vegetables for which it was appointed,

- (a) minimum prices for the vegetables or for any class, variety, grade or size thereof;
- (b) terms, conditions and forms of agreement relating to the producing or marketing of the vegetable or vegetables; and
- (c) any charges, costs or expenses relating to the production or marketing of the vegetable or vegetables. R.R.O. 1980, Reg. 388, s. 12.

18. A meeting of a negotiating agency may be convened by a notice in writing given by the members of the negotiating agency appointed by the local board, or by the members of the negotiating agency appointed by the processors, to the other members of the negotiating agency at least five days but not more than seven days before the date of the meeting, stating the time and place of the meeting. R.R.O. 1980, Reg. 388, s. 13.

19.—(1) Where a negotiating agency has met and does not arrive at an agreement respecting all matters that it is empowered to adopt or settle by agreement, the negotiating agency may refer the matters in dispute to a conciliation board. R.R.O. 1980, Reg. 388, s. 14 (1).

(2) A conciliation board shall be composed of one member.

(3) Subject to subsection (4), the member of the conciliation board shall be appointed by the members of the negotiating agency.

(4) Where the members of the negotiating agency cannot agree on a person to be appointed as the member of the conciliation board, the Commission shall appoint the member of the conciliation board. O. Reg. 80/89, s. 1.

(5) The negotiating agency shall submit to the conciliation board a statement or statements of the matters in dispute.

(6) The conciliation board shall,

- (a) endeavour to effect agreement on any matter referred to it under subsection (5); and
- (b) recommend adoption of any agreement effected under clause (a) to the negotiating agency. R.R.O. 1980, Reg. 388, s. 14 (5, 6).

ARBITRATION

20.—(1) Where a meeting of a negotiating agency is not held in accordance with the notice required by section 18, or where a meeting is held and the negotiating agency does not arrive at an agreement respecting all matters that it is empowered to adopt or settle by agreement, or where the negotiating agency decides that an agreement cannot be reached and so notifies the Commission by 6:00 p.m.,

- (a) in the case of tomatoes, green peas, sweet corn or cucumbers, on or before the 28th day of February;
- (b) in the case of cabbage, carrots, green and wax beans or peppers, on or before the 15th day of March; or
- (c) in the case of cauliflower, lima beans, red beets, pumpkin or squash, on or before the 25th day of March,

in any year, the matters in dispute shall be referred by the Commission to an Arbitration Board. R.R.O. 1980, Reg. 388, s. 15 (1); O. Reg. 115/82, s. 2; O. Reg. 116/84, s. 1; O. Reg. 86/87, s. 1 (1); O. Reg. 32/88, s. 1; O. Reg. 70/88, s. 1.

(2) When a day referred to in subsection (1) falls on a Saturday or holiday, the notification shall be on or before the day immediately preceding the said day that is not a Saturday or holiday. O. Reg. 20/83, s. 1.

(3) Where a negotiating agency does not arrive at an agreement on all matters that it is empowered to adopt or settle by agreement, it shall submit in writing to the Commission a statement or statements of the matters in dispute and a statement of the final position on each such matter of both,

- (a) the members of the negotiating agency appointed by the local board; and
- (b) the members of the negotiating agency appointed by the processors. R.R.O. 1980, Reg. 388, s. 15 (2); O. Reg. 70/88, s. 1.

21.—(1) An Arbitration Board shall be composed of one member.

(2) Subject to subsection (3), the member of the Arbitration Board shall be appointed by the members of the negotiating agency. O. Reg. 80/89, s. 2 (1).

(3) Where in any year the members of the negotiating agency cannot agree on a person to be appointed as the member of the Arbitration Board within seven days after the date mentioned in clause 20 (1) (a), (b) or (c), as the case may be, the Commission shall appoint the member of the Arbitration Board. O. Reg. 80/89, s. 2 (2), *part*.

(4) The Commission shall submit to the Arbitration Board any statement or statements received from the negotiating agency under subsection 20 (3). R.R.O. 1980, Reg. 388, s. 16 (7); O. Reg. 70/88, s. 1.

(5) Subject to subsection (6), the Arbitration Board shall meet with the parties forthwith after the appointment of the member and shall make an award in respect of the matters referred to it, or all matters that the negotiating agency for the vegetable or vegetables was empowered to adopt or settle by agreement, as the case may be. O. Reg. 80/89, s. 2 (3).

(6) Where a negotiating agency does not arrive at an agreement on all matters that it is empowered to adopt or settle by agreement, the Arbitration Board shall, with respect to each such matter, make its award only on the basis of one or the other of the final positions respecting such matter set out in the statement or statements referred to in subsection 20 (3). R.R.O. 1980, Reg. 388, s. 16 (9).

REGULATION 441**VEGETABLES FOR PROCESSING—PLAN**

1. The plan in the Schedule is continued for the control and regulation of the marketing within Ontario of vegetables. R.R.O. 1980, Reg. 387, s. 1.

2. The local board named in the Schedule is given the powers set out in subsection 15 (1), in paragraphs 1, 2, 3, 4, 5, 6, 7, 8, 10, 11, 12, 13, 14, 15, 16, 17, 18, 19 and 26 of subsection 15 (2) and in sections 50 and 110 of the *Co-operative Corporations Act*. R.R.O. 1980, Reg. 387, s. 2.

3. The members of the local board named in the Schedule shall be deemed to be the shareholders and the directors of the local board in the exercise of the powers vested in the local board under section 2. R.R.O. 1980, Reg. 387, s. 3.

Schedule*Farm Products Marketing Act***PLAN**

1. This plan may be cited as "The Ontario Vegetable Growers' Marketing-for-Processing Plan".

2. In this plan,

"processing" means,

- (a) canning, dehydrating, drying, freezing, pickling or processing with sugar or sulphur dioxide or any other chemical or by heat, and combining or mixing a vegetable with one or more other vegetables, or
- (b) entering into a contract for the purchase of vegetables for the purpose of performing on the vegetables any of the operations mentioned in clause (a);

"processor" means a person engaged in the business of processing vegetables;

"producer" means a person engaged in the production of vegetables;

"vegetables" means the following vegetables produced in Ontario and used for processing:

green and wax beans, lima beans, red beets, cabbage other than cabbage used for coleslaw, carrots, cauliflower, sweet corn, cucumbers, green peas, peppers, pumpkin and squash or tomatoes.

3. This plan provides for the control and regulation in any or all respects of the producing and marketing within Ontario of vegetables, including the prohibition of such producing and marketing in whole or in part.

4. There shall be a local board to be known as "The Ontario Vegetable Growers' Marketing Board".

5. The local board shall be composed of eleven producer-members.

6. Members of the local board shall be elected or appointed in accordance with the provisions of the plan and shall hold office until their successors are elected or appointed.

7. Producers are divided into five districts as follows:

- 1. District 1, comprising the County of Essex.
- 2. District 2, comprising the County of Kent.

3. District 3, comprising the counties of Bruce, Huron, Lambton, Middlesex, Oxford and Perth.

4. District 4, comprising the counties of Brant and Elgin and the regional municipalities of Haldimand-Norfolk and Niagara.

5. District 5, comprising the counties of Hastings, Northumberland and Prince Edward and The Regional Municipality of Durham.

8.—(1) A producer whose place of production is located in a district mentioned in section 7 is a member of that district.

(2) A producer whose place of production is not located in a district mentioned in section 7 is a member of the district nearest to the place of production.

9. There shall be a committee in each district to be known as the "District Vegetable Growers' Committee".

10. On or before the 1st day of December in each year, the members of each district shall elect from among themselves one member for each twenty-five producers or fraction thereof to the District Vegetable Growers' Committee.

11.—(1) On or before the 31st day of December in each year, each District Vegetable Growers' Committee may elect members to the local board as follows:

- 1. District 1, three members.
- 2. District 2, three members.
- 3. District 3, two members.
- 4. District 4, two members.
- 5. District 5, one member.

(2) No person is eligible for election to the local board from a district unless the person is a member of the district.

12.—(1) Where in any year a District Vegetable Growers' Committee fails to elect one or more members to the local board in accordance with subsection 11 (1), the members elected to the local board shall at its first meeting after the 31st day of December of that year appoint such producer-members as are necessary to complete the local board.

(2) When a member elected or appointed to the local board dies or resigns before the 31st day of December of the year next following the date of his or her election or appointment, the members of the local board may appoint a producer-member for the unexpired term.

(3) No person is eligible for appointment to the local board from a district unless the person is a member of the district. R.R.O. 1980, Reg. 387, Sched.; O. Reg. 389/83, ss. 1-3; O. Reg. 560/85, ss. 1-6; O. Reg. 649/86, s. 1; O. Reg. 650/87, s. 1; O. Reg. 624/89, s. 1.

REGULATION 442**WHEAT—MARKETING****INTERPRETATION**

1. In this Regulation,

"agent" means a person who receives wheat from a producer as an agent of the local board;

“local board” means The Ontario Wheat Producers’ Marketing Board;

“plan” means The Ontario Wheat Producers’ Marketing Plan;

“processing” includes cleaning, drying, treating, turning, washing, grinding, rolling, pulverizing, cracking, crimping or distilling, with or without other ingredients, and processing or manufacturing articles of food or drink in whole or in part from wheat;

“processor” means a person engaged in processing wheat;

“producer” means a person engaged in the production of wheat;

“wheat” means wheat of every variety produced in Ontario. R.R.O. 1980, Reg. 390, s. 1.

2. This Regulation provides for the control and regulation in any or all respects of the marketing within Ontario of wheat, including the prohibition of such marketing in whole or in part. R.R.O. 1980, Reg. 390, s. 2.

3. The Commission exempts from this Regulation,

- (a) wheat used on the farm on which it was produced; and
- (b) wheat sold by a producer directly to another producer and used by that other producer on his, her or its farm. R.R.O. 1980, Reg. 390, s. 3.

LICENCES

4.—(1) No person shall commence or continue to engage in the producing of wheat except under the authority of a licence. R.R.O. 1980, Reg. 390, s. 4 (1); O. Reg. 506/85, s. 14 (1).

(2) Every producer while not in default of payment of the fees required to be paid under section 5 shall be deemed to be the holder of a licence. R.R.O. 1980, Reg. 390, s. 4 (2); O. Reg. 506/85, s. 14 (2).

5. Every producer shall pay to the local board the licence fees fixed by the local board. O. Reg. 506/85, s. 14 (3).

POWERS OF LOCAL BOARD

6.—(1) The Commission authorizes the local board to use the licence fees and other money payable to it for the purpose of paying the expenses of the local board, carrying out and enforcing the Act and the regulations and carrying out the purposes of the plan.

(2) The Commission authorizes the local board to establish a fund in connection with the plan for the payment of any money that may be required for the purposes mentioned in subsection (1).

(3) The Commission delegates to the local board its power,

- (a) to require persons engaged in producing or marketing wheat to register their names, addresses and occupations with the local board;
- (b) to require persons engaged in producing or marketing wheat to furnish such information relating to the production or marketing of wheat, including completing and filing of returns, as the local board determines;
- (c) to appoint persons to inspect the books, records, documents, lands and premises and any wheat of persons engaged in the marketing of wheat;
- (d) to stimulate, increase and improve the marketing of wheat by such means as it considers proper;
- (e) to co-operate with a marketing board, local board, marketing commission or marketing agency of Canada or of any

province in Canada for the purpose of marketing wheat; and

- (f) to do such acts and make such orders and issue such directions as are necessary to enforce the due observance and carrying out of the Act, the regulations and the plan. R.R.O. 1980, Reg. 390, s. 8.

7. Subject to section 4, the Commission delegates to the local board its powers to make regulations with respect to wheat,

- (a) providing for the licensing of any or all persons before commencing or continuing to engage in the marketing of wheat;
- (b) prohibiting persons from engaging in the marketing of wheat except under the authority of a licence;
- (c) providing for the refusal to grant a licence where the applicant is not qualified by experience, financial responsibility and equipment to engage properly in the business for which the application was made, or for any other reason that the local board considers proper;
- (d) providing for the suspension or revocation of, or the refusal to renew, a licence for failure to observe or perform, or carry out the provisions of the Act, the regulations, the plan or any order or direction of the Commission or local board;
- (e) providing for the fixing of licence fees payable yearly, quarterly or monthly at different amounts or in instalments from any or all persons producing wheat and the collecting of the licence fees and the recovering of such licence fees by suit in a court of competent jurisdiction;
- (f) requiring any person who receives wheat to deduct from the money payable for the wheat any licence fees payable to the local board by the person from whom the first mentioned person receives the wheat, and to forward such licence fees to the local board;
- (g) requiring any person who produces and processes wheat to furnish to the local board statements of the amounts of wheat that the person produced in any year and used for processing;
- (h) prescribing the form of licences;
- (i) subject to section 3, providing for the exemption from any or all of the regulations, orders or directions under the plan of any class, variety, grade or size of wheat, or any person or class of persons engaged in the producing or marketing of wheat or any class, variety, grade or size of wheat;
- (j) requiring the furnishing of security or proof of financial responsibility by any person engaged in the marketing of wheat and providing for the administration and disposition of any money or securities so furnished;
- (k) providing for the control and regulation of the marketing of wheat, including the times and places at which wheat may be marketed;
- (l) requiring any person who produces wheat to offer to sell and to sell the wheat to or through the local board;
- (m) prohibiting any person from processing, packing or packaging any wheat that has not been sold to, by or through the local board;
- (n) providing for the control and regulation of agreements entered into by producers of wheat with persons engaged in marketing or processing wheat, and the prohibition of any provision or clause in such agreements; and
- (o) providing for the making of agreements relating to the mar-

keting of wheat by or through the local board and prescribing the forms and terms and conditions of such agreements. R.R.O. 1980, Reg. 390, s. 9; O. Reg. 506/85, s. 14 (5).

APPOINTMENT OF AGENTS

8. The Commission authorizes the local board to appoint agents, to prescribe their duties and terms and conditions of employment and to provide for their remuneration. R.R.O. 1980, Reg. 390, s. 10.

MARKETING OF WHEAT

9.—(1) All wheat shall be marketed by or through the local board.

(2) No person shall market wheat except by or through the local board. R.R.O. 1980, Reg. 390, s. 11.

10. The Commission vests in the local board the following powers:

1. To direct and control, by order or direction, either as principal or agent, the marketing of wheat including the times and places at which wheat may be marketed.
2. To determine the quality of each class, variety, grade and size of wheat that shall be marketed by each producer.
3. To prohibit the marketing of any class, variety, grade or size of wheat.
4. To determine from time to time the price or prices that shall be paid to producers or to the local board, as the case may be, for wheat or any class, variety, grade or size of wheat and to determine different prices for different parts of Ontario.
5. To fix and impose service charges from time to time for the marketing of wheat.
6. To require the price or prices payable or owing to the producer for wheat to be paid to or through the local board.
7. To collect from any person by suit in a court of competent jurisdiction the price or prices or any part thereof of wheat.
8. To purchase or otherwise acquire such quantity or quantities of wheat as the local board considers advisable and to sell or otherwise dispose of any wheat so purchased or acquired.
9. To pay from service charges imposed under paragraph 5 its expenses in carrying out the purposes of the plan.
10. To pay to the producers the price or prices for wheat less service charges imposed under paragraph 5 and to fix the times at which or within which such payments shall be made. R.R.O. 1980, Reg. 390, s. 12.

11. Each payment under paragraph 10 of section 10 shall be accompanied by a statement showing the class, variety, grade or size and the quantity of wheat marketed, the price or prices paid and the particulars of the service charges imposed. R.R.O. 1980, Reg. 390, s. 13.

12. The Commission authorizes the local board to conduct a pool or pools for the distribution of all money received from the sale of wheat, and after deducting all necessary and proper disbursements and expenses, to distribute the remainder of the money received from the sale in such manner that every producer receives a share of the remainder of the money received from the sale in relation to the amount, class, variety, grade or size of wheat delivered by the producer, and authorizes the local board to make an initial payment on delivery of the wheat and subsequent payments until all of the

remainder of the money received from the sale is distributed to the producers. R.R.O. 1980, Reg. 390, s. 14.

REGULATION 443

WHEAT—PLAN

1. The plan in the Schedule is continued for the control and regulation of the marketing within Ontario of wheat. R.R.O. 1980, Reg. 389, s. 1.

2. The local board named in the Schedule is given the powers set out in subsection 15 (1), in paragraphs 1, 2, 3, 4, 5, 6, 7, 8, 10, 11, 12, 13, 14, 15, 16, 17, 18, 19 and 26 of subsection 15 (2) and in sections 50 and 110 of the *Co-operative Corporations Act*. R.R.O. 1980, Reg. 389, s. 2.

3. The members of the local board named in the Schedule shall be deemed to be the shareholders and the directors of the local board in the exercise of the powers vested in the local board under section 2. R.R.O. 1980, Reg. 389, s. 3.

Schedule

Farm Products Marketing Act

PLAN

1. This plan may be cited as “The Ontario Wheat Producers’ Marketing Plan”.

2. In this plan,

“producer” means a person engaged in the production of wheat;

“wheat” means wheat of every variety produced in Ontario.

3. This plan provides for the control and regulation in any or all respects of the marketing within Ontario of wheat, including the prohibition of such marketing in whole or in part.

4.—(1) For the purpose of electing producer representatives to the local board or The District Wheat Producers’ Committee under sections 10 to 12, or for the purpose of being eligible to be a member thereof, a producer is the beneficial owner or tenant of a farm who,

(a) seeded wheat on the farm in the year preceding the year in which qualification under sections 10 to 12 is at issue; or

(b) marketed wheat through the local board that was produced on the farm in at least one of the two years preceding the year in which qualification under sections 10 to 12 is at issue.

(2) Where the producer is,

(a) a corporation, the person if any, designated in writing in respect of the farm by the corporation that is a producer as determined in subsection (1);

(b) a firm or partnership or one or more persons carrying on the production and marketing under a trade name, farm name or other designation, the person if any, designated in writing in respect of the farm by the owner or tenant who is a producer as determined under subsection (1); or

(c) comprised of two or more persons who are joint or common owners or tenants, the one of such joint or common tenants who first presents himself or herself to register the vote in respect of the farm,

shall be deemed to be the producer.

5. There shall be a local board to be known as "The Ontario Wheat Producers' Marketing Board".

6. The local board shall be composed of ten producer-members elected or appointed in accordance with sections 11 and 12.

7. Producers are divided into ten districts as follows:

1. District 1, comprising the County of Essex.
2. District 2, comprising the County of Kent.
3. District 3, comprising the County of Lambton.
4. District 4, comprising the counties of Elgin and Middlesex.
5. District 5, comprising the counties of Brant, Oxford, Perth and Wellington and The Regional Municipality of Waterloo.
6. District 6, comprising the regional municipalities of Haldimand-Norfolk, Halton, Hamilton-Wentworth and Niagara.
7. District 7, comprising the counties of Bruce, Grey and Huron.
8. District 8, comprising the counties of Dufferin and Simcoe and the regional municipalities of Durham, Peel and York.
9. District 9, comprising the counties of Hastings, Lennox and Addington, Northumberland, Peterborough, Prince Edward and Victoria.
10. District 10, comprising those parts of Ontario that are not included in districts 1 to 9.

8. Producers in each county, provisional county, regional municipality, district municipality or territorial district form a county group.

9. There shall be a committee in each district to be known as "The District Wheat Producers' Committee".

10. On or before the first day of March in each year, the producers in each county group may elect, from its members, one representative to the District Wheat Producers' Committee for the district in which the producers are located for each 250 producers or fraction thereof in the county group.

ELECTION OF MEMBERS TO LOCAL BOARDS

11.—(1) On or before the 15th day of March in each year, each District Wheat Producers' Committee may elect, from the producers in the district, one member to the local board.

(2) No person is eligible for election to the local board or The District Wheat Producers' Committee unless he or she is a producer, as determined under section 4, in the district and in no case shall a person be elected to represent more than one district nor shall any person be eligible for election who is under eighteen years of age.

(3) On or before the 31st day of March in each year, the members of all District Wheat Growers' Committees may elect the member from any district to the local board where an election for that district has not taken place under subsection (1).

12.—(1) At its first meeting after the 31st day of March the members elected to the local board shall appoint such producer-members as are necessary to complete the local board.

(2) When a member elected or appointed to the local board dies or resigns before the 31st day of March of the year next following the date of his or her election or appointment, the members of the local board may appoint a producer-member for the unexpired term.

(3) Each producer-member appointed a member to the local board under subsection (1) or (2) shall be a producer in the district for which he or she is appointed.

(4) Each producer-member of the local board shall be elected or appointed to hold office until the 31st day of March of the year next following his or her election or appointment. R.R.O. 1980, Reg. 389, Sched.; O. Reg. 224/82, ss. 1, 2.

Farm Products Payments Act

Loi sur le recouvrement du prix des produits agricoles

REGULATION 444

FUND FOR EGG PRODUCERS

1. In this Regulation,
- “Board” means the Egg Fund Board constituted by this Regulation;
- “dealer” means a person engaged in the business of buying eggs from producers;
- “eggs” means ungraded eggs of a domestic hen, other than hatching eggs;
- “Fund” means the Fund for Egg Producers established by this Regulation;
- “hatching eggs” means eggs of a domestic hen produced for the purpose of hatching into chicks;
- “local board” means The Ontario Egg Producers’ Marketing Board;
- “producer” means a person who produces eggs in Ontario. O. Reg. 828/81, s. 1; O. Reg. 491/82, s. 1.
2. The fund known as the Fund for Egg Producers is continued. O. Reg. 828/81, s. 2, *revised*.
3. Eggs are designated as a farm product for the purpose of the Act. O. Reg. 828/81, s. 3.
- 4.—(1) There shall be a board to be known as the “Egg Fund Board” to administer the Fund. O. Reg. 828/81, s. 4 (1), *revised*.
- (2) The Board shall consist of five members appointed by the Lieutenant Governor in Council under subsection 2 (2) of the Act.
- (3) The Board shall elect from among its members a chair and a vice-chair on or before the thirtieth day after the appointment of the Board in 1981 and on or before the 30th day of April in every year thereafter.
- (4) The chair and vice-chair hold office as such until the 30th day of April in the year next following the date of their election. O. Reg. 828/81, s. 4 (2-4).
5. Clause 3 (1) (a) of the Act does not apply in respect of the Fund. O. Reg. 828/81, s. 5.
- 6.—(1) Every dealer shall pay to the Board fees at the rate of two-tenths of a cent for each fifteen dozen eggs bought from a producer.
- (2) The local board shall deduct, from the money payable by it to a dealer, any fees payable by the dealer to the Board in respect of eggs bought in any month and shall pay such fees to the Board not later than the fifteenth day of the following month.
- (3) Every dealer shall pay to the Board any fees payable in respect of eggs bought in any month, that were not deducted and paid by the local board under subsection (2), not later than the thirtieth day of the following month. O. Reg. 828/81, s. 6.
- 7.—(1) Every producer shall pay to the Board fees at the rate of one cent for each fifteen dozen eggs sold to a dealer.
- (2) Every dealer who buys eggs from a producer shall deduct

from the money payable to the producer for the eggs bought in any month the fees payable by the producer to the Board in respect of such eggs and shall pay such fees to the Board not later than the fifteenth day of the following month.

(3) Every producer shall pay to the Board any fees payable in respect of eggs sold by him in any month that were not deducted and paid to the Board under subsection (2), not later than the thirtieth day of the following month. O. Reg. 828/81, s. 7.

8. The placing of the whole or any part of a dealer’s assets in the hands of a receiver pursuant to a debenture or like instrument is prescribed as an additional condition to those referred to in subsection 3 (1) of the Act under which a producer may apply for payment from a fund and such applications and payments shall be made in accordance with this Regulation. O. Reg. 828/81, s. 8.

9.—(1) An application for payment from the Fund shall be made to the Board in Form 1.

(2) A separate application shall be made to the Board in respect of each dealer against whom a producer has a claim.

(3) An application in Form 1 shall be made not later than thirty days next following the date on which the whole or any part of the dealer’s assets has been placed in the hands of a trustee for distribution under the *Bankruptcy Act* (Canada) or the *Bulk Sales Act* or in the hands of a receiver. O. Reg. 828/81, s. 9.

(4) All fees payable under subsection 7 (1), in respect of eggs for which payment is sought, shall be paid before an application for payment from the Fund is made. O. Reg. 491/82, s. 2.

10. On receipt of an application under section 9, the Board shall,

- (a) give notice to the dealer by registered mail of the producer’s claim for payment; and
- (b) notify the local board. O. Reg. 828/81, s. 10.

11. Where the Board determines that a claim is not valid, it shall refuse payment of the claim and shall give notice of the refusal by registered mail to the producer and to the dealer and shall also notify the local board. O. Reg. 828/81, s. 11.

12. Where the Board determines that a claim is valid it shall,

- (a) make payment to the producer from the Fund; and
- (b) notify the dealer and the local board. O. Reg. 828/81, s. 12.

13. The Board may refuse to make payment in respect of a claim,

- (a) where any cheque received by a producer from a dealer is dishonoured by non-acceptance or non-payment unless the producer has presented the cheque for payment within fifteen days of the date on which the producer received it;
- (b) where a producer has made an arrangement with the dealer whereby the time on which payment becomes due is extended;
- (c) where a producer fails to make an application in Form 1 within the time prescribed by subsection 9 (3); or

(d) where the applicant and the dealer are associated in any way and the conduct of the applicant or, where the applicant is a corporation, of an officer or director of the applicant or person having power to direct the management of the applicant, caused the default in payment and in the circumstances it would be inequitable to make a payment from the Fund. O. Reg. 828/81, s. 13; O. Reg. 99/90, s. 2.

14. The amount that may be paid out of the Fund to a producer on any application shall not exceed the payment due for eggs for the period of fourteen consecutive days prior to the day on which the whole or any part of the dealer's assets has been placed in the hands of a trustee for distribution under the *Bankruptcy Act* (Canada) or the *Bulk Sales Act* or in the hands of a receiver. O. Reg. 491/82, s. 3.

Form 1

Farm Products Payments Act

APPLICATION FOR PAYMENT FROM THE FUND FOR EGG PRODUCERS

To the Egg Fund Board:

.....
(name of applicant)

.....
(address)

hereby applies for payment from the Fund under the *Farm Products Payments Act* and the regulations, and in support of this application the following facts are stated:

- 1. I am a producer of eggs.
- 2. The name and address of the dealer to whom eggs were sold is
- 3. The period for which non-payment is claimed is from to
- 4. The whole or part of the dealer's assets was placed in the hands of a trustee for distribution under the *Bankruptcy Act* (Canada) or the *Bulk Sales Act* or in the hands of a receiver on the day of, 19.....
- 5. Additional information

Dated at, this day of, 19.....
.....
(signature of applicant)

NOTE

Where the whole or any part of the dealer's assets has been placed in the hands of a trustee for distribution under the *Bankruptcy Act* (Canada) or the *Bulk Sales Act* or in the hands of a receiver, payment will not exceed the amount due for eggs for a period of fourteen consecutive days before the placement. O. Reg. 828/81, Form 1; O. Reg. 491/82, s. 4.

REGULATION 445

FUND FOR LIVESTOCK PRODUCERS

1. In this Regulation,

"Commissioner" means the Livestock Commissioner;

"licensed dealer" means a dealer licensed under the *Livestock and Livestock Products Act*;

"livestock" means cattle sold for the purpose of,

- (a) slaughter for the production of beef, or
- (b) further feeding for the production of beef. O. Reg. 368/82, s. 1.

2. The Fund for Live Stock Producers is continued as The Fund for Livestock Producers, hereinafter referred to as the "Fund". O. Reg. 368/82, s. 2, *revised*.

3.—(1) The Live Stock Financial Protection Board is continued as the board to administer the Fund, under the name The Livestock Financial Protection Board, hereinafter referred to as the "Board". O. Reg. 368/82, s. 3 (1), *revised*.

(2) The Board shall be composed of not fewer than five members consisting of,

- (a) one member representing the Ontario Cattlemen's Association;
- (b) one member representing the Canadian Meat Council;
- (c) one member representing operators of community sales under the *Livestock Community Sales Act*;
- (d) one member representing the Toronto Livestock Exchange;
- (e) one or more members representing the Ministry of Agriculture and Food; and
- (f) such other members as the Minister considers necessary or advisable. O. Reg. 368/82, s. 3 (2), *revised*.

4. Livestock are designated as a farm product. O. Reg. 368/82, s. 4.

5. The following classes of persons engaged in selling livestock, as owners or otherwise, are designated as producers for the purpose of the Act and this Regulation:

- 1. Licensed dealers in respect of sales made to any other licensed dealer. O. Reg. 368/82, s. 5.

6.—(1) In the case of every sale of livestock made directly or on a consignment basis, the seller or consignor, as the case may be, and the person selling on behalf of the consignor, where applicable, shall each pay to the Board a fee of 5 cents per head of livestock.

(2) In the case of a direct sale of livestock, the buyer shall deduct, from the money payable to the seller, the fees payable to the Board by the seller.

(3) In the case of a sale of livestock on a consignment basis, the person selling on behalf of the consignor shall deduct, from the money payable to the consignor, the fees payable to the Board by the consignor.

(4) On or before the fifteenth day of each month, every buyer and every person selling on behalf of a consignor shall, with respect to livestock sold during the preceding month, forward to the Board,

- (a) the fees deducted under subsection (2) or (3);

- (b) in the case of a person selling on behalf of a consignor, the fees payable under subsection (1); and
- (c) a statement, in a form provided therefor by the Board, of the livestock sold.

(5) Every buyer shall, at the time the buyer deducts fees under subsection (2), provide the seller from whom fees are deducted with a statement of the fees deducted.

(6) Every person selling on behalf of a consignor shall, at the time the person deducts fees under subsection (3), provide the consignor with a statement of the fees deducted. O. Reg. 182/89, s. 1.

7. The following are prescribed as additional conditions to those set out in subsection 3 (1) of the Act under which a producer may apply for payment from the Fund:

- 1. The placing of the whole or any part of a dealer's assets in the hands of a receiver pursuant to a debenture or like instrument.
- 2. The ceasing by a dealer to carry on business. O. Reg. 182/89, s. 2.

8.—(1) An application for payment from the Fund shall be made to the Board not later than thirty days after the day upon which the earliest of the following events occurs:

- 1. The payment in respect of which the application is made is due.
- 2. The whole or any part of the dealer's assets is placed in the hands of a trustee for distribution under the *Bankruptcy Act* (Canada) or the *Bulk Sales Act* or in the hands of a receiver.
- 3. The dealer ceases to carry on business.

(2) An application for payment shall be made in a form satisfactory to the Board.

(3) A separate application shall be made in respect of each dealer against whom there is a claim. O. Reg. 182/89, s. 3.

9. On receipt of an application under section 8, the Board shall,

- (a) give notice to the dealer by registered mail of the claim for payment; and
- (b) notify the Commissioner. O. Reg. 368/82, s. 8.

10. Where the Board determines that a claim is not valid, it shall refuse payment of the claim and shall give notice of the refusal by registered mail to the person who made the claim and to the dealer and shall also notify the Commissioner. O. Reg. 368/82, s. 9.

11. Where the Board determines that a claim is valid, it shall,

- (a) make payment from the Fund to the person who made the claim; and
- (b) notify the dealer and the Commissioner. O. Reg. 368/82, s. 10.

12.—(1) Where the Board makes a payment from the Fund, the dealer in respect of whom the payment is made shall,

- (a) pay to the Board; or
- (b) commence to pay by instalments in accordance with an undertaking approved by the Board,

the amount paid from the Fund.

(2) Where a dealer fails,

- (a) to comply with subsection (1); or
- (b) to make any instalment payment as it becomes due under an undertaking referred to in clause (1) (b),

the Board shall notify the Commissioner. O. Reg. 368/82, s. 11.

13.—(1) The Board may refuse to make payment in respect of a claim,

- (a) subject to subsection (2), where the applicant claims payment in respect of a dealer who is not a licensed dealer;
- (b) where any cheque received by the applicant from a dealer is dishonoured by non-acceptance or non-payment unless the applicant has presented the cheque for payment within five banking days of the date on which the applicant received it;
- (c) where the applicant fails to make an application under section 8 within the time prescribed by subsection 8 (1);
- (d) where the applicant has made an arrangement with the dealer whereby the time on which payment becomes due is extended;
- (e) where the applicant has failed to notify the Commissioner forthwith of the default in payment by the dealer; or
- (f) where the applicant and the dealer are associated in any way and the conduct of the applicant or, where the applicant is a corporation, of an officer or director of the applicant or person having power to direct the management of the applicant, caused the default in payment and in the circumstances it would be inequitable to make a payment from the Fund. O. Reg. 368/82, s. 12 (1); O. Reg. 99/90, s. 3, *revised*.

(2) An applicant who sells livestock to a dealer who is unlicensed at the time of the sale may be paid from the Fund if the sale occurred before the applicant knew that the licence of the dealer had expired or been suspended or cancelled or that the dealer had been refused the renewal of the licence. O. Reg. 182/89, s. 4.

14. The Board, having regard to the circumstances of a case, may make payment from the Fund where a claim for payment is made in substantial conformity with subsection 8 (1). O. Reg. 368/82, s. 13, *revised*.

15. The amount that may be paid out of the Fund to an applicant on any application shall be 90 per cent of the amount of the claim. O. Reg. 368/82, s. 14.

REGULATION 446

FUND FOR MILK AND CREAM PRODUCERS

1. In this Regulation,

"cream" means cream separated from milk on the farm on which the milk is produced and supplied to a plant in Ontario;

"cream board" means The Ontario Cream Producers' Marketing Board as constitutes under the *Milk Act*;

"Director" means the Director appointed under the *Milk Act*;

"Fund" means The Fund for Milk and Cream Producers;

"marketing board" means The Ontario Milk Marketing Board as constituted under the *Milk Act*;

“milk” means milk from cows or goats;

“plant” means plant as defined in the *Milk Act*;

“producer” means a producer of milk or cream. O. Reg. 275/85, s. 2; O. Reg. 561/85, s. 1, *revised*.

2. The fund for producers of milk or cream known as The Fund for Milk and Cream Producers is continued. R.R.O. 1980, Reg. 391, s. 2, *revised*.

3. The Ontario Farm Products Marketing Commission is designated as the Board to administer the Fund, and is hereinafter referred to as the Board. R.R.O. 1980, Reg. 391, s. 3.

4. Milk and cream are designated as farm products. R.R.O. 1980, Reg. 391, s. 4.

5. The marketing board is designated as a producer. O. Reg. 275/85, s. 3, *part*.

6.—(1) In this section,

“product” means milk from cows, milk from goats or cream;

“year” means the period from the 1st day of June in one year to the 31st day of May in the following year.

(2) Every dealer who operates a plant shall pay to the Board 0.375 cents per hectolitre of milk and 0.1041667 cents per kilogram of milk-fat contained in cream purchased from the producers but the fees for each product purchased for processing in each plant shall not be less than \$100 per year nor more than \$4,000 per year.

(3) Every producer who sells milk or cream to a dealer shall pay to the Board 40 per cent of the amount payable by the dealer per year under subsection (2). O. Reg. 275/85, s. 3, *part, revised*.

(4) The dealer shall pay the amount due under subsection (2) in respect of the sale of milk from cows to the marketing board at the same time that payment for the milk is due.

(5) The marketing board shall forward to the Board the fees payable by the marketing board and the fees received from the dealer under subsection (4) by the 21st day of the month following the month of sale. O. Reg. 275/85, s. 3, *part*.

(6) In respect of the sale of milk from goats, the dealer shall deduct from the money payable to the producer the fees payable to the Board by the producer and forward this amount plus the fees payable by the dealer to the Board by the 10th day of the month following the month of sale. O. Reg. 275/85, s. 3, *part*; O. Reg. 561/85, s. 2 (1).

(7) The producer shall pay the amount due under subsection (3) in respect of the sale of cream to the cream board and the cream board shall forward this amount to the Board by the 21st day of the month following the month of sale.

(8) In respect of the sale of cream, the dealer shall forward the fees payable by the dealer to the Board by the 10th day of the month following the month of sale. O. Reg. 561/85, s. 2 (2).

7. The placing of the whole or any part of the assets of a dealer in the hands of a receiver pursuant to a debenture or like instrument is prescribed as an additional condition under which a producer may apply for payment from the Fund. O. Reg. 275/85, s. 4.

8.—(1) An application for payment from the Fund shall be made to the Board in a form satisfactory to the Board. O. Reg. 275/85, s. 5 (1).

(2) A separate application shall be made to the Board in respect of each dealer against whom a producer has a claim. R.R.O. 1980, Reg. 391, s. 7 (2).

(3) An application shall be made not later than the 30th day next following the date on which,

(a) the payment in respect of which the application is made became due; or

(b) the whole or any part of the dealer's assets has been placed in the hands of a trustee for distribution under the *Bankruptcy Act* (Canada) or the *Bulk Sales Act* or in the hands of the receiver. R.R.O. 1980, Reg. 391, s. 7 (3); O. Reg. 275/85, s. 5 (2, 3).

9. On receipt of an application under section 8, the Board shall,

(a) give notice to the dealer by registered mail of the producer's claim for payment; and

(b) notify the Director. R.R.O. 1980, Reg. 391, s. 8.

10. Where the Board determines that a claim is not valid, it shall refuse payment of the claim and shall give notice of the refusal by registered mail to the producer and to the dealer, and shall notify the Director. R.R.O. 1980, Reg. 391, s. 9.

11. Where the Board determines that a claim is valid, it shall,

(a) make payment to the producer from the Fund; and

(b) notify the dealer and the Director. R.R.O. 1980, Reg. 391, s. 10.

12.—(1) Where the Board makes a payment from the Fund, the dealer in respect of whom the payment is made shall,

(a) pay to the Board; or

(b) commence to pay by instalments in accordance with an undertaking approved by the Board,

the amount paid from the Fund less the amount, if any, paid to the Board from the sale of security deposited by the dealer with the Director under Regulation 761 of Revised Regulations of Ontario, 1990.

(2) The Board shall notify the Director if a dealer fails,

(a) to comply with the provisions of subsection (1); or

(b) to make any instalment payment as it becomes due under an undertaking referred to in clause (1) (b). R.R.O. 1980, Reg. 391, s. 11.

13.—(1) The Board may refuse to make payment in respect of a claim,

(a) subject to subsection (2), where a producer claims payment in respect of a dealer who is not the holder of a licence to operate the plant under Regulation 761 of Revised Regulations of Ontario, 1990;

(b) where any cheque received by a producer from a dealer is dishonoured by non-acceptance or non-payment unless the producer has presented the cheque for payment within ten days of the date on which the producer received it;

(c) where a producer fails to make an application within the time prescribed by subsection 8 (3);

(d) where a producer has made an arrangement with the dealer whereby the time on which payment becomes due is extended; or

(e) where the applicant and the dealer are associated in any way and the conduct of the applicant or, where the applicant is a corporation, of an officer or director of the appli-

cant or person having power to direct the management of the applicant, caused the default in payment and in the circumstances it would be inequitable to make a payment from the Fund. R.R.O. 1980, Reg. 391, s. 12 (1); O. Reg. 275/85, s. 6; O. Reg. 99/90, s. 1.

(2) A producer may be paid from the Fund where the producer's claim is made in respect of milk or cream delivered to a dealer prior to the date on which the producer received notice from the Director that the licence of the dealer had been suspended or revoked or had not been renewed. R.R.O. 1980, Reg. 391, s. 12 (2).

14. The Board, having regard to the circumstances of a case, may make payment from the Fund where a claim for payment is made in substantial conformity with subsection 8 (3). R.R.O. 1980, Reg. 391, s. 13.

15. The amount that may be paid out of the Fund to a producer on any application shall not exceed the payment due for milk or cream for a period of sixty days. R.R.O. 1980, Reg. 391, s. 14.

REGULATION 447

FUND FOR PRODUCERS OF CANOLA

1. In this Regulation,

"Association" means the Ontario Canola Growers' Association designated under the *Farm Products Marketing Act*;

"Board" means the Grain Financial Protection Board;

"Chief Inspector" means the Chief Inspector appointed under the *Grain Elevator Storage Act*;

"dealer" means a person engaged in the business of buying canola from producers or in selling canola on behalf of producers;

"Director" means the Director appointed under the *Farm Products Grades and Sales Act*;

"Fund" means the Fund for Canola Producers;

"licence" when referring to one held by a dealer means a licence under the *Farm Products Grades and Sales Act* and when referring to one held by an operator means a licence under the *Grain Elevator Storage Act* and "licensed" has a corresponding meaning;

"operator" means a grain elevator operator within the meaning of the *Grain Elevator Storage Act*;

"producer" means a person engaged in the production of canola. O. Reg. 404/89, s. 1, revised.

2. The fund known as the Fund for Canola Producers is continued. O. Reg. 404/89, s. 2, revised.

3. The Board shall administer the Fund. O. Reg. 404/89, s. 3.

4. Canola is designated as a farm product. O. Reg. 404/89, s. 4.

5.—(1) A fee of \$1 per tonne of canola sold by a producer to a dealer is payable by the producer to the Board at the time of sale.

(2) The dealer shall,

(a) deduct from the money payable to the producer the fees payable to the Board by the producer; and

(b) within fifteen days after the end of every month, forward to the Association the fees payable on all sales made during the month.

(3) The Association shall forward all the fees to the Board forthwith.

(4) The dealer shall provide the producer from whom fees are deducted with a statement of the fees at the time they are deducted.

(5) Every dealer shall keep for at least two years a record of all canola purchased by the dealer and fees deducted. O. Reg. 404/89, s. 5.

6.—(1) If canola is sold on a deferred pricing arrangement, payment becomes due,

(a) for the percentage of the market price payable on account,

(i) if the canola is stored under the *Grain Elevator Storage Act*, on the day the canola is sold, and

(ii) in any other case, on the day the canola is delivered to the purchaser; and

(b) for the balance of the amount unpaid after payment on account, on the day the producer prices the canola to close out the contract.

(2) If delivery of and payment for canola sold under a contract are concurrent, payment becomes due on the day of delivery.

(3) If subsection (1) or (2) does not apply, payment for the canola becomes due on the day of sale.

(4) If a dealer or operator ceases to carry on business, a contract to which the dealer or operator is a party shall be considered closed out on the day the other party to the contract became aware that the business was not being carried on. O. Reg. 404/89, s. 6.

7. A producer shall forthwith notify the Director or Chief Inspector, as the case may be, if,

(a) a dealer has not paid the producer the price of canola within fifteen days after payment became due;

(b) a producer has reason to believe that a dealer or operator has ceased to carry on business;

(c) a producer has not received payment in respect of a sale of canola in storage as provided in subsection 18 (3) of the *Grain Elevator Storage Act* and the regulations thereunder;

(d) an operator who is storing canola on behalf of a producer fails to deliver any of the canola upon demand therefor; or

(e) any of the assets of an operator who is storing canola on behalf of a producer have been placed in the hands of a trustee for distribution under the *Bankruptcy Act* (Canada) or the *Bulk Sales Act* or in the hands of a receiver pursuant to a debenture or like instrument and the trustee or receiver fails to deliver any of the canola upon demand therefor to the producer. O. Reg. 404/89, s. 7.

8. The following are prescribed as additional conditions to those referred to in subsection 3 (1) of the Act under which a producer may apply for payment from the Fund:

1. Placing of any of the assets of a dealer in the hands of a receiver pursuant to a debenture or like instrument.

2. Ceasing, by a dealer or operator, to carry on business. O. Reg. 404/89, s. 8.

9.—(1) An application for payment from the Fund must be made to the Board in a form satisfactory to the Board.

(2) A separate application must be made to the Board in respect

of each dealer against whom a producer has a claim and in respect of each operator against whom an owner has a claim.

(3) An application to the Board may be made only within the thirty-day period next following the day on which the grounds for making the claim arise. O. Reg. 404/89, s. 9.

10.—(1) On receiving an application under section 9 from a producer, the Board shall give notice of the claim, by registered mail, to the dealer and notify the Director of the application.

(2) On receiving an application under section 9 from an owner, the Board shall give notice of the claim, by registered mail, to the operator and notify the Chief Inspector of the application. O. Reg. 404/89, s. 10.

11. The Board shall refuse payment of a claim that it determines is invalid and it shall,

- (a) give notice of the refusal, by registered mail, to the person who made the claim and to the person against whom the claim was made; and
- (b) notify the Director, if a producer made the claim, or the Chief Inspector, if an owner made the claim. O. Reg. 404/89, s. 11.

12. The Board shall make payment from the Fund of a claim that it determines is valid to the person who made the claim and it shall notify,

- (a) the dealer and the Director, if a producer made the claim; or
- (b) the operator and the Chief Inspector, if an owner made the claim. O. Reg. 404/89, s. 12.

13.—(1) A dealer in respect of whom the Board makes a payment from the Fund shall pay the amount of that payment to the Board,

- (a) in a lump sum; or
- (b) by instalments in accordance with an undertaking approved by the Board.

(2) The Board shall notify the Director if a dealer fails to make a lump sum payment or to make an instalment payment as it becomes due under an undertaking referred to in subsection (1). O. Reg. 404/89, s. 13.

14.—(1) The Board may refuse to make payments in respect of a claim,

- (a) subject to subsection (2), if the applicant claims payment in respect of a dealer who is not a licensed dealer;
- (b) if any cheque received by the applicant from a dealer is dishonoured by non-acceptance or non-payment unless the applicant has presented the cheque for payment within five banking days after the date the applicant received it;
- (c) if the applicant fails to make the application to the Board within the time prescribed by subsection 9 (3);
- (d) if the applicant has made an arrangement with the dealer whereby the time within which payment is to be made under subsection 6 (1) of Regulation 540 of Revised Regulations of Ontario, 1990 or under subsection 7 (1) of Regulation 383 of Revised Regulations of Ontario, 1990 is extended;
- (e) if the applicant is not the producer of the canola in respect of which the claim is made;
- (f) if the deferred pricing arrangement referred to in subsec-

tion 6 (1) is not in writing and signed by the applicant and the dealer;

- (g) if the applicant has failed to notify the Director or Chief Inspector, as the case may be, in accordance with section 7; or
- (h) if the applicant and the dealer are associated in any way and the conduct of the applicant or, where the applicant is a corporation, of an officer or director of the applicant or person having power to direct the management of the applicant, caused the default in payment and in the circumstances it would be inequitable to make a payment from the Fund. O. Reg. 404/89, s. 14 (1); O. Reg. 99/90, s. 8.

(2) A payment from the Fund may be made to an applicant who makes a claim in respect of canola that was sold to or stored by a licensed dealer before the applicant learned that the dealer's licence had been suspended, revoked or refused renewal, or that it had expired. O. Reg. 404/89, s. 14 (2).

15.—(1) The Board, having regard to the circumstances of a case, may extend the period for making an application under subsection 9 (3).

(2) If the Board extends the period for making an application under subsection (1), it may make a payment from the Fund. O. Reg. 404/89, s. 15.

16.—(1) The amount that may be paid out of the Fund to an applicant on any one application is,

- (a) in the case of a claim under subsection 3 (2) of the Act, 90 per cent of the market value of the canola in respect of which the claim is made on the day the grounds for making the claim arose;
- (b) in the case of a claim made in respect of a deferred pricing arrangement mentioned in subsection 6 (1), 90 per cent of the market price payable on the day the contract is closed out or considered closed out, less 75 per cent of the market price of the canola on the day payment on account was made unless the amount is more than 75 per cent, in which case the actual amount is paid;
- (c) in the case of a claim by an applicant mentioned in subsection (3), 90 per cent of the amount determined in accordance with subsections (3) and (4); and
- (d) in a case not covered by clause (a), (b) or (c), 90 per cent of the amount of the claim.

(2) For the purpose of subsection (1), any default in payment by the applicant to the producer organization under the *Advance Payment for Crops Act* (Canada) arising from any default in payment by a dealer or a failure by an operator to deliver canola shall be included in the amount of the applicant's claim.

(3) The amount of canola in respect of which a claim may be paid out of the Fund shall not exceed the percentage, calculated under subsection (4), of the amount of canola in respect of which the claim is made if the applicant is a producer who,

- (a) holds a dealer's licence and has purchased canola before the day the claim arose; or
- (b) holds an operator's licence.

(4) The percentage referred to in subsection (3) shall be calculated by dividing the amount of canola produced by the applicant by the combined amount of canola produced by the applicant, purchased by the applicant in their capacity as a dealer and stored by the applicant in their capacity as an operator. O. Reg. 404/89, s. 16.

REGULATION 448

FUND FOR PRODUCERS OF GRAIN CORN

1. In this Regulation,

“Association” means the Ontario Corn Producers’ Association continued under the *Agricultural and Horticultural Organizations Act*;

“Board” means the Grain Financial Protection Board;

“Chief Inspector” means the Chief Inspector appointed under the *Grain Elevator Storage Act*;

“dealer” means a person engaged in the business of buying grain corn from producers or in selling grain corn on behalf of producers;

“Director” means the Director appointed under the *Farm Products Grades and Sales Act*;

“Fund” means the Fund for Grain Corn Producers;

“grain corn” does not include popping corn, seed corn or sweet corn;

“licence” when referring to one held by a dealer means a licence under the *Farm Products Grades and Sales Act* and when referring to one held by an operator means a licence under the *Grain Elevator Storage Act* and “licensed” has a corresponding meaning;

“operator” means a grain elevator operator within the meaning of the *Grain Elevator Storage Act*;

“producer” means a person engaged in the production of grain corn. O. Reg. 651/84, s. 1; O. Reg. 139/87, s. 1, *revised*.

2. The fund for producers of grain corn known as the Fund for Grain Corn Producers, is continued. O. Reg. 651/84, s. 2, *revised*.

3.—(1) The board known as the Grain Financial Protection Board, which shall be composed of not fewer than five members is continued to administer the Fund. O. Reg. 651/84, s. 3 (1), *revised*.

(2) The Lieutenant Governor in Council may designate one of the members of the Board as chair and one as vice-chair. O. Reg. 651/84, s. 3 (2).

4. Grain corn is designated as a farm product. O. Reg. 651/84, s. 4.

5.—(1) A fee of 2 cents per tonne of grain corn sold by a producer to a dealer is payable by the producer to the Board at the time of the sale. O. Reg. 139/87, s. 2 (1), *part*; O. Reg. 378/88, s. 1; O. Reg. 546/89, s. 1.

(2) The dealer shall,

- (a) deduct from the money payable to the producer the fees payable to the Board by the producer; and
- (b) within fifteen days after the end of every month, forward to the Association the fees payable on all sales made during that month. O. Reg. 651/84, s. 5, *part*; O. Reg. 139/87, s. 2 (2).

(3) The Association shall forward all such fees to the Board forthwith.

(4) The dealer shall provide the producer from whom fees are deducted with a statement of such fees at the time they are deducted.

(5) Every dealer shall keep at least for two years a record of all grain corn purchased and fees deducted. O. Reg. 651/84, s. 5, *part*.

6.—(1) Where grain corn is sold on a deferred pricing arrangement, payment becomes due,

- (a) for the percentage of the market price payable on account,
 - (i) where the grain corn is stored under the *Grain Elevator Storage Act* on the day on which the grain corn is sold, and
 - (ii) in any other case, on the day on which the grain corn is delivered to the purchaser; and
- (b) for the balance of the amount unpaid after payment on account, on the day on which the producer prices the grain corn to close out the contract.

(2) Where delivery and payment for grain corn sold under a contract are concurrent, payment becomes due on the date of delivery.

(3) Where subsection (1) or (2) does not apply, payment becomes due for the grain corn on the date of sale.

(4) Where a dealer or operator ceases to carry on business, a contract to which the dealer or operator is a party shall be considered to be closed out on the day that the other party to the contract became aware that the business was not being carried on. O. Reg. 139/87, s. 3.

7. Where,

- (a) a dealer has not paid the producer the price of grain corn within fifteen days after the time the payment became due;
- (b) a producer has reason to believe that a dealer or operator has ceased to carry on business;
- (c) a producer has not received payment in respect of a sale of grain corn in storage as provided in subsection 18 (3) of the *Grain Elevator Storage Act* and the regulations thereunder; or
- (d) a grain elevator operator who is storing grain corn on behalf of a producer fails to deliver the whole or any part of such grain corn upon demand therefor; or
- (e) the whole or any part of the assets of a grain elevator operator who is storing grain corn on behalf of a producer have been placed in the hands of a trustee for distribution under the *Bankruptcy Act* (Canada) or the *Bulk Sales Act* or in the hands of a receiver pursuant to a debenture or like instrument and the trustee or receiver fails to deliver to the producer the whole or any part of such grain corn upon demand therefor,

the producer shall forthwith notify the Director or Chief Inspector, as the case may be. O. Reg. 651/84, s. 6; O. Reg. 139/87, s. 4.

8. The,

- (a) placing of the whole or any part of the assets of a dealer in the hands of a receiver pursuant to a debenture or like instrument; or
- (b) ceasing, by a dealer or operator, to carry on business,

is prescribed as an additional condition to those referred to in subsection 3 (1) of the Act under which a producer may apply for payment from the Fund. O. Reg. 139/87, s. 5.

9.—(1) An application for payment from the Fund shall be made to the Board in a form satisfactory to the Board. O. Reg. 651/84, s. 8 (1).

(2) A separate application shall be made to the Board in respect of each dealer against whom a producer has a claim and in respect of

each operator against whom an owner has a claim. O. Reg. 139/87, s. 6.

(3) An application to the Board shall be made not later than thirty days next following the date on which the ground for making the claim arises. O. Reg. 651/84, s. 8 (3).

10.—(1) On receiving an application under section 9 from a producer, the Board shall give notice of the claim, by registered mail, to the dealer and notify the Director of the application.

(2) On receiving an application under section 9 from an owner, the Board shall give notice of the claim, by registered mail, to the operator and notify the Chief Inspector of the application. O. Reg. 139/87, s. 7, *part*.

11. Where the Board determines that a claim is not valid, it shall refuse payment of the claim and shall,

- (a) give notice of the refusal, by registered mail, to the person who made the claim and to the person against whom the claim was made; and
- (b) notify the Director, where a producer made the claim, or the Chief Inspector, where an owner made the claim. O. Reg. 139/87, s. 7, *part*.

12. Where the Board determines that a claim is valid, it shall make payment from the Fund to the person who made the claim and notify,

- (a) the dealer and the Director, if the claim is from a producer; or
- (b) the operator and the Chief Inspector, if the claim is from an owner. O. Reg. 139/87, s. 7, *part*.

13.—(1) Where the Board makes a payment from the Fund, the dealer in respect of whom the payment is made shall,

- (a) pay to the Board; or
- (b) commence to pay by instalments in accordance with an undertaking approved by the Board,

the amount paid from the Fund.

(2) Where a dealer fails,

- (a) to comply with subsection (1); or
- (b) to make any instalment payment as it becomes due under an undertaking referred to in clause (1) (b),

the Board shall notify the Director. O. Reg. 651/84, s. 12.

14.—(1) The Board may refuse to make payments in respect of a claim,

- (a) subject to subsection (2), where the applicant claims payment in respect of a dealer who is not a licensed dealer;
- (b) where any cheque received by the applicant from a dealer is dishonoured by non-acceptance or non-payment unless the applicant has presented the cheque for payment within five banking days of the date on which the applicant received it;
- (c) where the applicant fails to make an application to the Board within the time prescribed by subsection 9 (3);
- (d) where the applicant has made an arrangement with the dealer whereby the time on which payment shall be made under subsection 6 (1) of Regulation 540 of Revised Regulations of Ontario, 1990 or under subsection 7 (1) of Regu-

lation 383 of Revised Regulations of Ontario, 1990 is extended;

- (e) where the applicant is not the producer of the grain corn in respect of which the claim is made;
- (f) where the deferred pricing arrangement referred to in subsection 6 (1) is not in writing and signed by the applicant and the dealer;
- (g) where the applicant has failed to notify the Director in accordance with section 7; or
- (h) where the applicant and the dealer are associated in any way and the conduct of the applicant or, where the applicant is a corporation, of an officer or director of the applicant or person having power to direct the management of the applicant, caused the default in payment and in the circumstances it would be inequitable to make a payment from the Fund. O. Reg. 651/84, s. 13 (1); O. Reg. 139/87, s. 8 (1); O. Reg. 99/90, s. 5.

(2) An applicant may be paid from the Fund where the claim is made in respect of grain corn sold to or stored by a dealer or operator whose licence was suspended, revoked or not renewed or had expired, if at the time the sale or storage was made the applicant was unaware of that suspension, revocation, non-renewal or expiry. O. Reg. 139/87, s. 8 (2).

15. The Board, having regard to the circumstances of a case, may make payment from the Fund where a claim for payment is made in substantial conformity with subsection 9 (3). O. Reg. 651/84, s. 14.

16.—(1) The amount that may be paid out of the Fund to an applicant on any one application is,

- (a) in the case of a claim under subsection 3 (2) of the Act, 90 per cent of the market value of the grain corn in respect of which the claim is made on the day on which the grounds arose for making the claim;
- (b) in the case of a claim made in respect of a deferred pricing arrangement mentioned in subsection 6 (1), 90 per cent of the market price payable on the day the contract is closed out or considered to be closed out, less 75 per cent of the market price of the grain corn on the day payment on account was made unless the amount is more than 75 per cent in which case the actual amount paid;
- (c) in the case of a claim by an applicant mentioned in subsection (3), 90 per cent of the amount determined in accordance with subsections (3) and (4); and
- (d) in all cases not covered by clause (a), (b) or (c), 90 per cent of the amount of the claim.

(2) For the purpose of subsection (1), any default in payment by the claimant to the producer organization under the *Advance Payment for Crops Act* (Canada) arising from any default in payment by a dealer or a failure by an operator to deliver grain corn shall be included in the amount of the applicant's claim.

(3) Where the applicant is a producer who,

- (a) holds a licence as a dealer and has purchased grain corn prior to the day on which the claim arose; or
- (b) holds a licence as an operator and has stored grain corn for other owners prior to the day on which the claim arose,

the amount of grain corn in respect of which a claim may be paid out of the Fund shall not exceed the percentage calculated under subsection (4) of the amount of grain corn in respect of which the claim is made.

(4) The percentage prescribed by subsection (3) shall be calculated by dividing the amount of grain corn produced by the applicant by the combined amount of any grain corn produced by the applicant, purchased by the applicant in their capacity as a dealer and stored by the applicant in their capacity as an operator. O. Reg. 139/87, s. 9.

REGULATION 449

FUND FOR PRODUCERS OF POTATOES FOR PROCESSING

1. In this Regulation,

“Board” means the Potato Financial Protection Board;

“dealer” means a person engaged in the business of buying potatoes from producers or selling potatoes on behalf of producers;

“Director” means the Director appointed under the *Farm Products Marketing Act*;

“Fund” means the Fund for Producers of Potatoes;

“licence” means a licence under the *Farm Products Marketing Act* and “licensed” has a corresponding meaning;

“potatoes” means potatoes produced in Ontario and used or intended to be used for processing within or outside Ontario;

“processing” means,

- (a) canning, dehydrating, chipping, drying, freezing or peeling,
- (b) adding heat or any substance,
- (c) combining or mixing with one or more other vegetables, or
- (d) entering into a contract for the purchase of potatoes;

“producer” means a producer of potatoes. O. Reg. 528/87, s. 1; O. Reg. 273/89, s. 1.

2. Potatoes are designated as a farm product. O. Reg. 528/87, s. 2.

3. The Fund for Producers of Potatoes is continued. O. Reg. 528/87, s. 3, *revised*.

4.—(1) The Potato Financial Protection Board is continued to administer the Fund. O. Reg. 528/87, s. 4 (1), *revised*.

(2) The Board shall be composed of not fewer than five members appointed by the Lieutenant Governor in Council.

(3) The Lieutenant Governor in Council may designate one of the members of the Board as chair and one as vice-chair. O. Reg. 528/87, s. 4 (2, 3).

5.—(1) A fee of two cents for each 100 pounds of potatoes sold by a producer to a dealer is payable by the producer to the Board.

(2) The dealer shall,

- (a) deduct from the money payable to the producer the fees payable to the Board by the producer; and
- (b) forward the fees to The Ontario Potato Growers' Marketing Board by the twentieth day of the month following the month in which they were required to be deducted.

(3) The Ontario Potato Growers' Marketing Board shall forward all such fees to the Board forthwith.

(4) The dealer shall provide the producer from whom fees are deducted with a statement of such fees at the time they are deducted. O. Reg. 528/87, s. 5 (2-5).

(5) Every dealer shall keep for at least two years a record showing, in respect of all potatoes purchased or sold, as the case may be,

- (a) the names and addresses of the buyers and sellers;
- (b) the date of each purchase or sale;
- (c) the purchase or sale price;
- (d) the fees deducted; and
- (e) a description of the potatoes. O. Reg. 273/89, s. 2.

6. Payment for potatoes shall be made in accordance with the agreement or award or renegotiated agreement or award declared to be in force by the Farm Products Marketing Commission under the *Farm Products Marketing Act*. O. Reg. 273/89, s. 3.

7. Where,

- (a) a dealer has refused to accept potatoes in accordance with the dealer's agreement with a producer;
- (b) a producer has not received payment for potatoes in accordance with section 6; or
- (c) a producer is aware that the whole or any part of the dealer's assets are in the hands of a trustee or receiver or that the dealer has ceased to carry on business,

the producer shall forthwith notify the Director. O. Reg. 528/87, s. 6; O. Reg. 273/89, s. 4.

8. The,

- (a) placing of the whole or any part of a dealer's assets in the hands of a receiver pursuant to a debenture or like instrument; or
- (b) ceasing by a dealer to carry on business,

is prescribed as an additional condition to those referred to in subsection 3 (1) of the Act under which a producer may apply for payment from the Fund. O. Reg. 528/87, s. 7.

9.—(1) An application for payment from the Fund shall be made to the Board in a form satisfactory to the Board.

(2) A separate application shall be made to the Board in respect of each dealer against whom a producer has a claim.

(3) An application to the Board shall be made not later than thirty days next following the date on which,

- (a) the payment in respect of which the application is made became due;
- (b) the whole or any part of the dealer's assets has been placed in the hands of a trustee for distribution under the *Bankruptcy Act* (Canada) or the *Bulk Sales Act* or in the hands of a receiver; or
- (c) the dealer ceased to carry on business. O. Reg. 528/87, s. 8.

10. On receipt of an application under section 9, the Board shall give notice of the claim to the dealer by registered mail and notify the Director of the application. O. Reg. 528/87, s. 9.

11. Where the Board determines that a claim is not valid, it shall,

- (a) refuse payment of the claim;
- (b) give notice of the refusal by registered mail to the producer and to the dealer; and
- (c) notify the Director. O. Reg. 528/87, s. 10.

12. Where the Board determines that a claim is valid, it shall make payment from the Fund to the producer and notify the dealer and the Director. O. Reg. 528/87, s. 11.

13.—(1) Where the Board makes a payment from the Fund, the dealer in respect of whom the payment is made shall,

- (a) pay to the Board; or
- (b) commence to pay by instalments in accordance with an undertaking approved by the Board,

the amount paid from the Fund.

- (2) Where a dealer fails,
 - (a) to comply with the provisions of subsection (1); or
 - (b) to make an instalment payment as it becomes due under an undertaking referred to in clause (1) (b),

the Board shall notify the Director. O. Reg. 528/87, s. 12.

14.—(1) The Board may refuse to make payments in respect of a claim,

- (a) subject to subsection (2), where the producer claims payment in respect of a dealer who is not a licensed dealer;
- (b) where any cheque received by the producer from a dealer is dishonoured by non-acceptance or non-payment unless the producer has presented the cheque for payment within five banking days of the date on which the producer received it;
- (c) where the producer fails to make an application to the Board within the time prescribed by subsection 9 (3);
- (d) where the producer has made an agreement with the dealer whereby the time when payment shall be made under section 6 is extended;
- (e) where the applicant has failed to notify the Director in accordance with section 7; or
- (f) where the applicant and the dealer are associated in any way and the conduct of the applicant or, where the applicant is a corporation, of an officer or director of the applicant or person having power to direct the management of the applicant, caused the default in payment and in the circumstances it would be inequitable to make a payment from the Fund. O. Reg. 528/87, s. 13 (1); O. Reg. 273/89, s. 5; O. Reg. 99/90, s. 7.

(2) A producer may be paid from the Fund where the claim is made in respect of potatoes sold to a dealer whose licence was suspended, revoked or not renewed or had expired, if at the time of sale the producer was unaware of that suspension, revocation, non-renewal or expiry. O. Reg. 528/87, s. 13 (2).

15. The Board, having regard to the circumstances of a case, may make payment from the Fund where a claim for payment is made in substantial conformity with subsection 9 (3). O. Reg. 528/87, s. 14.

16.—(1) Subject to subsection (2), the amount that may be paid out of the Fund to a producer on any application shall be 90 per cent of the amount of the valid claim.

- (2) Where the applicant is a producer who holds a licence as a

dealer and has purchased potatoes in the licence year prior to the day on which the claim arose, the amount that may be paid out of the Fund is limited to the amount of the valid claim multiplied by the amount produced and divided by the sum of the amount produced and the amount purchased. O. Reg. 528/87, s. 15.

17.—(1) On or before the 30th day of November in each year, every dealer shall,

- (a) furnish to the Director proof of financial responsibility satisfactory to the Director; or
- (b) deposit with the Director security in a form and in an amount that relates to the price of potatoes to be purchased by the dealer during the next year, as determined by the Director.

(2) The security described in clause (1) (b) shall not exceed the purchase price of potatoes to be purchased by the dealer during the next year.

(3) Security deposited under subsection (1) shall be applied only in respect of claims of a producer who sells potatoes to a dealer and in respect of which payments have been made under the Act and this Regulation.

(4) Where the Director receives notice under the Act or this Regulation that a payment has been made to a producer who has sold potatoes to a dealer who has deposited security under subsection (1), the Director may realize upon the security or such part thereof as the Director considers necessary.

(5) A dealer whose security has been realized upon under this section shall deposit such additional security with the Director as is necessary to maintain the security at the amount established under subsection (1).

(6) Where the Director realizes upon a security under subsection (4), the Director shall,

- (a) pay the proceeds, or so much of the proceeds as is necessary to reimburse the Fund for the amount paid to the producer, into the Fund; and
- (b) where the dealer whose security has been realized upon has complied with subsection (5), pay the balance, if any, of the proceeds to the dealer. O. Reg. 273/89, s. 6.

REGULATION 450

FUND FOR PRODUCERS OF SOYBEANS

1. In this Regulation,

“Board” means the Grain Financial Protection Board;

“Chief Inspector” means the Chief Inspector appointed under the *Grain Elevator Storage Act*;

“dealer” means a person engaged in the business of buying soybeans from producers or in selling soybeans on behalf of producers;

“Director” means the Director appointed under the *Farm Products Grades and Sales Act*;

“Fund” means the Fund for Soybeans;

“licence” when referring to one held by a dealer means a licence under the *Farm Products Grades and Sales Act* and when referring to one held by an operator means a licence under the *Grain Elevator Storage Act*, and “licensed” has a corresponding meaning;

“local board” means The Ontario Soybean Growers’ Marketing Board;

“operator” means a grain elevator operator within the meaning of the *Grain Elevator Storage Act*;

“producer” means a person engaged in the production of soybeans. O. Reg. 652/84, s. 1; O. Reg. 140/87, s. 1, *revised*.

2. The fund known as the Fund for Soybean Producers is continued. O. Reg. 652/84, s. 2, *revised*.

3. The Board shall administer the Fund. O. Reg. 652/84, s. 3.

4. Soybeans are designated as a farm product. O. Reg. 652/84, s. 4.

5.—(1) A fee of 5 cents per tonne of soybeans sold by a producer to a dealer is payable by the producer to the Board at the time of the sale. O. Reg. 140/87, s. 2 (1), *part*; O. Reg. 556/88, s. 1; O. Reg. 531/90, s. 1.

(2) The dealer shall,

(a) deduct from the money payable to the producer the fees payable to the Board by the producer; and

(b) within fifteen days after the end of every month, forward to the local board the fees payable on all sales made during that month. O. Reg. 652/84, s. 5 (3); O. Reg. 140/87, s. 2 (2).

(3) The local board shall forward all such fees to the Board forthwith.

(4) The dealer shall provide the producer from whom fees are deducted with a statement of such fees at the time they are deducted.

(5) Every dealer shall keep at least for two years a record of all soybeans purchased and fees deducted. O. Reg. 652/84, s. 5 (4-6).

6.—(1) Where soybeans are sold on a deferred pricing arrangement, payment becomes due,

(a) for the percentage of the market price payable on account,

(i) where the soybeans are stored under the *Grain Elevator Storage Act*, on the day on which the soybeans are sold, and

(ii) in any other case, on the day on which the soybeans are delivered to the purchaser; and

(b) for the balance of the amount unpaid after payment on account, on the day on which the producer prices the soybeans to close out the contract.

(2) Where delivery and payment for soybeans sold under a contract are concurrent, payment becomes due on the date of delivery.

(3) Where subsection (1) or (2) does not apply, payment becomes due for the soybeans on the date of sale.

(4) Where a dealer or operator ceases to carry on business, a contract to which the dealer or operator is a party shall be considered to be closed out on the day that the other party to the contract became aware that the business was not being carried on. O. Reg. 140/87, s. 3.

7. Where,

(a) a dealer has not paid the producer the price of soybeans within fifteen days after the time the payment became due;

(b) a producer has reason to believe that a dealer or operator has ceased to carry on business;

(c) a producer has not received payment in respect of a sale of soybeans in storage as provided in subsection 18 (3) of the *Grain Elevator Storage Act* and the regulations thereunder;

(d) a grain elevator operator who is storing soybeans on behalf of a producer fails to deliver the whole or any part of such soybeans upon demand therefor; or

(e) the whole or any part of the assets of a grain elevator operator who is storing soybeans on behalf of a producer have been placed in the hands of a trustee for distribution under the *Bankruptcy Act* (Canada) or the *Bulk Sales Act* or in the hands of a receiver pursuant to a debenture or like instrument and the trustee or receiver fails to deliver to the producer the whole or any part of such soybeans upon demand therefor,

the producer shall forthwith notify the Director or Chief Inspector, as the case may be. O. Reg. 652/84, s. 6; O. Reg. 140/87, s. 4.

8. The,

(a) placing of the whole or any part of the assets of a dealer in the hands of a receiver pursuant to a debenture or like instrument; or

(b) ceasing, by a dealer or operator, to carry on business,

is prescribed as an additional condition to those referred to in subsection 3 (1) of the Act under which a producer may apply for payment from the Fund. O. Reg. 140/87, s. 5.

9.—(1) An application for payment from the Fund shall be made to the Board in a form satisfactory to the Board. O. Reg. 652/84, s. 8 (1).

(2) A separate application shall be made to the Board in respect of each dealer against whom a producer has a claim and in respect of each operator against whom an owner has a claim. O. Reg. 140/87, s. 6.

(3) An application to the Board shall be made not later than thirty days next following the date on which the ground for making the claim arises. O. Reg. 652/84, s. 8 (3).

10.—(1) On receiving an application under section 9 from a producer, the Board shall give notice of the claim, by registered mail, to the dealer and notify the Director of the application.

(2) On receiving an application under section 9 from an owner, the Board shall give notice of the claim, by registered mail, to the operator and notify the Chief Inspector of the application. O. Reg. 140/87, s. 7, *part*.

11. Where the Board determines that a claim is not valid, it shall refuse payment of the claim and shall,

(a) give notice of the refusal, by registered mail, to the person who made the claim and to the person against whom the claim was made; and

(b) notify the Director, where a producer made the claim, or the Chief Inspector, where an owner made the claim. O. Reg. 140/87, s. 7, *part*.

12. Where the Board determines that a claim is valid, it shall make payment from the Fund to the person who made the claim and notify,

(a) the dealer and the Director, if the claim is from a producer; or

- (b) the operator and the Chief Inspector, if the claim is from an owner. O. Reg. 140/87, s. 7, *part*.

13.—(1) Where the Board makes a payment from the Fund, the dealer in respect of whom the payment is made shall,

- (a) pay to the Board; or
(b) commence to pay by instalments in accordance with an undertaking approved by the Board,

the amount paid from the Fund. O. Reg. 652/84, s. 12 (1).

(2) The Board shall notify the Director if a dealer fails,

- (a) to comply with the provisions of subsection (1); or
(b) to make any instalment payment as it becomes due under an undertaking referred to in clause (1) (b). O. Reg. 652/84, s. 12 (2), *revised*.

14.—(1) The Board may refuse to make payments in respect of a claim,

- (a) subject to subsection (2), where the applicant claims payment in respect of a dealer who is not a licensed dealer;
(b) where any cheque received by the applicant from a dealer is dishonoured by non-acceptance or non-payment unless the applicant has presented the cheque for payment within five banking days of the date on which the applicant received it;
(c) where the applicant fails to make an application to the Board within the time prescribed by subsection 8 (3);
(d) where the applicant has made an arrangement with the dealer whereby the time on which payment shall be made under subsection 6 (1) of Regulation 540 of Revised Regulations of Ontario, 1990 or under subsection 7 (1) of Regulation 383 of Revised Regulations of Ontario, 1990 is extended;
(e) where the applicant is not the producer of the soybeans in respect of which the claim is made;
(f) where the deferred pricing arrangement referred to in subsection 6 (1) is not in writing and signed by the applicant and the dealer;
(g) where the applicant has failed to notify the Director in accordance with section 7; or
(h) where the applicant and the dealer are associated in any way and the conduct of the applicant or, where the applicant is a corporation, of an officer or director of the applicant or person having power to direct the management of the applicant, caused the default in payment and in the circumstances it would be inequitable to make a payment from the Fund. O. Reg. 652/84, s. 13 (1); O. Reg. 140/87, s. 8 (1); O. Reg. 99/90, s. 6.

(2) An applicant may be paid from the Fund where the claim is made in respect of soybeans sold to or stored by a dealer or operator whose licence was suspended, revoked or not renewed or had expired, if at the time the sale or storage was made the applicant was unaware of that suspension, revocation, non-renewal or expiry. O. Reg. 140/87, s. 8 (2).

15. The Board, having regard to the circumstances of a case, may make payment from the Fund where a claim for payment is made in substantial conformity with subsection 9 (3). O. Reg. 652/84, s. 14.

16.—(1) The amount that may be paid out of the Fund to an applicant on any one application is,

- (a) in the case of a claim under subsection 3 (2) of the Act, 90 per cent of the market value of the soybeans in respect of which the claim is made on the day on which the grounds arose for making the claim;
(b) in the case of a claim made in respect of a deferred pricing arrangement mentioned in subsection 6 (1), 90 per cent of the market price payable on the day the contract is closed out or considered to be closed out, less 75 per cent of the market price of the soybeans on the day payment on account was made unless the amount is more than 75 per cent in which case the actual amount paid;
(c) in the case of a claim by an applicant mentioned in subsection (3), 90 per cent of the amount determined in accordance with subsections (3) and (4); and
(d) in all cases not covered by clause (a), (b) or (c), 90 per cent of the amount of the claim.

(2) For the purpose of subsection (1), any default in payment by the claimant to the producer organization under the *Advance Payment for Crops Act* (Canada) arising from any default in payment by a dealer or a failure by an operator to deliver soybeans shall be included in the amount of the applicant's claim.

(3) Where the applicant is a producer who,

- (a) holds a licence as a dealer and has purchased soybeans before the day on which the claim arose; or
(b) holds a licence as an operator and has stored soybeans for other owners before the day on which the claim arose,

the amount of soybeans in respect of which a claim may be paid out of the Fund shall not exceed the percentage, calculated under subsection (4), of the amount of soybeans in respect of which the claim is made.

(4) The percentage prescribed by subsection (3) shall be calculated by dividing the amount of soybeans produced by the applicant by the combined amount of any soybeans produced by the applicant, purchased by the applicant in their capacity as a dealer and stored by the applicant in their capacity as an operator. O. Reg. 140/87, s. 9.

REGULATION 451

FUND FOR PRODUCERS OF VEGETABLES FOR PROCESSING

1. In this Regulation,

“Board” means the Processing—Vegetable Financial Protection Board;

“dealer” means a person engaged in the business of buying vegetables for processing from producers;

“Fund” means the Fund for Processing Vegetable Producers;

“licence” means a licence under the *Farm Products Marketing Act*, and “licensed” has a corresponding meaning;

“processing” means,

- (a) canning, dehydrating, drying, freezing, pickling or processing with sugar or sulphur dioxide or any other chemical or by heat, and combining or mixing a vegetable with one or more other vegetables, or
(b) entering into a contract for the purchase of vegetables for the purpose of performing on the vegetables any of the operations mentioned in clause (a);

“producer” means a person engaged in the production of vegetables;

“vegetables” means the following vegetables produced in Ontario and used for processing: green and wax beans, lima beans, red beets, cabbage except cabbage used for coleslaw, carrots, cauliflower, sweet corn, cucumbers, green peas, peppers, pumpkin, squash or tomatoes. O. Reg. 348/84, s. 1; O. Reg. 241/88, s. 1, *revised*.

2. The fund for producers of vegetables known as the Fund for Processing Vegetable Producers is continued. O. Reg. 348/84, s. 2, *revised*.

3.—(1) The board to be known as the Processing-Vegetable Financial Protection Board is continued to administer the Fund. O. Reg. 348/84, s. 3 (1), *revised*.

(2) The Board shall be composed of not fewer than eight members consisting of,

- (a) six members representing producers;
- (b) four members representing dealers; and
- (c) such other members as may be appointed by the Lieutenant Governor in Council. O. Reg. 348/84, s. 3 (2); O. Reg. 241/88, s. 2.

(3) The Lieutenant Governor in Council may designate one of the members of the Board as chair and one as vice-chair. O. Reg. 348/84, s. 3 (3).

4. Vegetables are designated as a farm product. O. Reg. 348/84, s. 4.

5.—(1) An annual fee of \$200 is payable by a dealer to the Board and shall be forwarded with the dealer’s application for a licence or renewal. O. Reg. 348/84, s. 5 (1).

(2) In the case of every sale of vegetables by a producer to a dealer, the producer shall pay to the Board a fee that is one-tenth of 1 per cent of the average price per tonne for all grades of that vegetable in the year of sale.

(3) For the purposes of subsection (2), the average price for a vegetable is calculated by the Ontario Vegetable Growers’ Marketing Board based on the price negotiated by the negotiating agency or fixed by arbitration for that vegetable. O. Reg. 380/88, s. 2 (1).

(4) The dealer shall,

- (a) deduct from the money payable to the producer the fees payable to the Board by the producer; and
- (b) forward the fees to The Ontario Vegetable Growers’ Marketing Board within two weeks of completion of harvest for the particular vegetable. O. Reg. 348/84, s. 5 (3).

(5) The Ontario Vegetable Growers’ Marketing Board shall forward all such fees to the Board on or before the 1st day of February next following the date of sale. O. Reg. 380/88, s. 2 (2).

(6) The dealer shall provide the producer from whom fees are deducted with a statement of such fees at the time they are deducted.

(7) Every dealer shall keep for at least two years a record of all vegetables purchased and fees deducted. O. Reg. 348/84, s. 5 (5, 6).

6. Where,

- (a) a dealer has refused to accept vegetables in accordance with the dealer’s agreement with a producer;

(b) a producer has not received payment for vegetables in accordance with the producer’s agreement with a dealer; or

(c) a producer is aware that the whole or any part of the dealer’s assets are in the hands of a trustee or receiver,

the producer shall forthwith notify the Ontario Farm Products Marketing Commission. O. Reg. 348/84, s. 6; O. Reg. 380/88, s. 1.

7. The following are prescribed as additional conditions to those set out in subsection 3 (1) of the Act under which a producer may apply for payment from the Fund:

- 1. The placing of the whole or any part of a dealer’s assets in the hands of a receiver pursuant to a debenture or like instrument.
- 2. The ceasing by a dealer to carry on business. O. Reg. 241/88, s. 3.

8.—(1) A separate application shall be made to the Board in respect of each dealer against whom a producer has a claim. O. Reg. 348/84, s. 8 (2).

(2) An application shall be made not later than thirty days after the earliest of the following events occur:

- 1. The payment in respect of which the application is made becomes due.
- 2. The whole or any part of the dealer’s assets is placed in the hands of a trustee for distribution under the *Bankruptcy Act* (Canada) or the *Bulk Sales Act* or in the hands of a receiver.
- 3. The dealer ceases to carry on business. O. Reg. 241/88, s. 4 (2).

9. On receipt of an application under section 8, the Board shall,

- (a) give notice to the dealer by registered mail of the claim for payment; and
- (b) notify the Ontario Farm Products Marketing Commission. O. Reg. 348/84, s. 9; O. Reg. 380/88, s. 1.

10. Where the Board determines that a claim is not valid, it shall refuse payment of the claim and shall give notice of the refusal by registered mail to the person who made the claim and to the dealer and shall also notify the Ontario Farm Products Marketing Commission. O. Reg. 348/84, s. 10; O. Reg. 380/88, s. 1.

11. Where the Board determines that a claim is valid, it shall,

- (a) make payment from the Fund to the person who made the claim; and
- (b) notify the dealer and the Ontario Farm Products Marketing Commission. O. Reg. 348/84, s. 11; O. Reg. 380/88, s. 1.

12.—(1) Where the Board makes a payment from the Fund, the dealer in respect of whom the payment is made shall,

- (a) pay to the Board; or
- (b) commence to pay by instalments in accordance with an undertaking approved by the Board,

the amount paid from the Fund.

(2) Where a dealer fails,

- (a) to comply with subsection (1); or

(b) to make any instalment payment as it becomes due under an undertaking referred to in clause (1) (b),

the Board shall notify the Ontario Farm Products Marketing Commission. O. Reg. 348/84, s. 12; O. Reg. 380/88, s. 1.

13.—(1) The Board may refuse to make payments in respect of a claim,

- (a) where any cheque received by the applicant from a dealer is dishonoured by non-acceptance or non-payment unless the applicant has presented the cheque for payment within five banking days of the date on which the applicant received it;
- (b) where the applicant fails to make an application within the time prescribed by subsection 8 (3);
- (c) where the applicant has made an arrangement with the dealer whereby the time on which payment becomes due is extended;
- (d) where the applicant has failed to notify the Ontario Farm Products Marketing Commission in accordance with section 6; or
- (e) where the applicant and the dealer are associated in any way and the conduct of the applicant or, where the applicant is a corporation, of an officer or director of the applicant or person having power to direct the management of the applicant, caused the default in payment and in the circumstances it would be inequitable to make a payment from the Fund. O. Reg. 348/84, s. 13 (1); O. Reg. 241/88, s. 5; O. Reg. 380/88, ss. 1, 3 (1); O. Reg. 99/90, s. 4.

(2) Subject to subsection (3), no payment shall be made from the Fund in respect of vegetables if the dealer was not licensed at the time the vegetables were delivered by the producer to the dealer.

(3) An applicant may be paid from the Fund if,

- (a) the applicant's claim is made in respect of vegetables sold to a dealer who was licensed for the crop year prior to the date on which the vegetables were delivered by the producer to the dealer; and
- (b) the applicant did not know, on the date mentioned in clause (a), that the dealer's licence had been suspended or revoked. O. Reg. 380/88, s. 3 (2).

14. The Board, having regard to the circumstances of a case, may make payment from the Fund where a claim for payment is made in substantial conformity with subsection 8 (3). O. Reg. 348/84, s. 14.

15. The amount that may be paid out of the Fund to an applicant on any application shall be 90 per cent of the amount of the claim. O. Reg. 348/84, s. 15.

16. The Treasurer of Ontario is authorized to make out of the Consolidated Revenue Fund to the Board one grant in the amount of \$25,000. O. Reg. 348/84, s. 16.

17.—(1) In this section, "Commission" means the Ontario Farm Products Marketing Commission. O. Reg. 348/84, s. 18 (1); O. Reg. 380/88, ss. 1, 4.

(2) Every dealer shall furnish to the Commission proof of financial responsibility and, where the Commission is not satisfied in respect of the financial responsibility of a dealer, the dealer shall deposit with the Commission security in a form satisfactory to the Commission and in an amount prescribed by the Commission. O. Reg. 348/84, s. 18 (2); O. Reg. 380/88, s. 4.

(3) Proof of financial responsibility required to be furnished to the Commission under subsection (2) shall be furnished by the 15th day of March, 1984 and by the 1st day of January in each subsequent year. O. Reg. 348/84, s. 18 (3); O. Reg. 380/88, s. 4.

(4) Security deposited with the Commission under subsection (2) shall be applicable solely to the claims of producers for vegetables sold to the dealer and in respect of which payments have been made under the Act and this Regulation. O. Reg. 348/84, s. 18 (4); O. Reg. 380/88, s. 4.

(5) Where the Commission receives notice pursuant to the Act and this Regulation that a payment has been made to a producer in respect of a dealer who deposited security under subsection (2), the Commission may realize upon the security or part thereof as it considers necessary. O. Reg. 348/84, s. 18 (5); O. Reg. 380/88, s. 4.

(6) Where security has been realized upon under subsection (5), the Commission shall pay into the Fund the money obtained therefrom or so much thereof as is necessary to reimburse the Fund for the amount paid to a producer. O. Reg. 348/84, s. 18 (6); O. Reg. 380/88, s. 4.

(7) Where security has been realized upon under subsection (5), the dealer shall deposit with the Commission such additional security as is necessary to comply with the amount prescribed by the Commission under subsection (2) and on the deposit of such additional security by the dealer, the Commission shall pay to the dealer the money remaining, if any, after payment is made to the Fund pursuant to subsection (6). O. Reg. 348/84, s. 18 (7); O. Reg. 380/88, s. 4.

Fire Departments Act
Loi sur les services des pompiers

REGULATION 452

FILING IN ONTARIO COURT (GENERAL DIVISION) OF DECISION OF ARBITRATOR OR ARBITRATION BOARD

1. A copy of a decision of an arbitrator or arbitration board for filing in the office of the Registrar of the Ontario Court (General Division) under subsection 7 (8) of the Act shall be in Form 1. R.R.O. 1980, Reg. 392, s. 1, *revised*.

Form 1

Fire Departments Act

In the matter of the decision of an arbitrator or arbitration board under section 7 of the *Fire Departments Act*.

Between:

— and — Complainant,
Respondent.

To: The Registrar of the Ontario Court (General Division):

....., being a
(name)
.....
(party, municipality, trade union or full-time firefighter)

*Strike out if not applicable. affected by the decision of *an arbitrator or *arbitration board under section 7 of the *Fire Departments Act* hereby files a copy of the decision under section 7.

The decision was made under the following circumstances:

- 1. Arbitrator or Members of Board of Arbitration.
- 2. Appearances for Complainant.
- 3. Appearances for Respondent.
- 4. Date and Place of Hearing.
- 5. Date of Decision.
- 6. Date of Delivery of Decision.
- *7. Date provided in Decision for Compliance.

The decision, exclusive of the reasons therefor, reads as follows:

The respondent has failed to comply with the decision.

Dated at, this day of, 19.....

I certify that the copy of the decision is a true copy and the particulars set out herein are within my knowledge and are accurate.

.....
(signature of person filing or, where person filing is a corporation or trade union, of an officer authorized in that behalf)

R.R.O. 1980, Reg. 392, Form 1, *revised*.

REGULATION 453

STANDARDS FOR PUMPERS

1. The standard for a self-propelled motorized fire pumper purchased by any municipality or offered for sale by any person to a municipality shall be a pumper not more than fifteen years old since the time of its original manufacture and sale. R.R.O. 1980, Reg. 393, s. 1.

2. Where a self-propelled motorized fire pumper is purchased by a municipality or fire area with a population of over 1,000 persons, and Ontario contributes towards the purchase price, the pumper shall,

- (a) have a pump,
 - (i) with a rated capacity of not less than 420 Imperial Gallons per minute at a net pump pressure of 120 pounds per square inch as evidenced by a test for a continuous period of two hours, capable of delivering 50 per cent of the rated capacity at 200 pounds net pressure and 33 1/3 per cent of the rated capacity at 250 pounds net pump pressure, as evidenced by a test for a continuous period of one-half an hour in each case, and
 - (ii) midship-mounted or rear-mounted on the chassis of a self-propelled motor truck with an enclosed cab capable of seating a crew of not less than five persons; and
- (b) when loaded, from a standing start attain a speed of 35 miles per hour within 35 seconds, and a top speed of 50 miles per hour, as evidenced by two tests in opposite directions over the same route on a level paved roadway. R.R.O. 1980, Reg. 393, s. 2.

Fire Marshals Act *Loi sur les commissaires des incendies*

REGULATION 454

FIRE CODE

PART I APPLICATION AND DEFINITIONS

TABLE OF CONTENTS

SECTION 1.1	APPLICATION
Subsection 1.1.1.	General
Subsection 1.1.2.	Records of Tests
Subsection 1.1.3.	Demolition
Subsection 1.1.4.	Imperial Values
Subsection 1.1.5.	Required Testing
Subsection 1.1.6.	Licensing of Persons Installing or Maintaining Fire Protection Equipment
Subsection 1.1.7.	Exemptions
Subsection 1.1.8.	Standards Referenced
Subsection 1.1.9.	Chief Fire Official

SECTION 1.2	DEFINITIONS OF WORDS AND PHRASES
Subsection 1.2.1.	Definitions

SECTION 1.3	ABBREVIATIONS
Subsection 1.3.1.	Abbreviations of Names of Associations
Subsection 1.3.2.	Abbreviations of Words and Phrases

SECTION 1.1 APPLICATION

Subsection 1.1.1. General

1.1.1.1. Unless otherwise specified, the **owner** shall be responsible for carrying out the provisions of this Code.

1.1.1.2. Where **tests**, repairs or alterations are made to fire protection installations, including sprinkler and standpipe systems, a procedure of notification shall be established, and the procedure shall include notifying the **fire department** and the **building** occupants where necessary for safety in the event of a fire emergency.

Subsection 1.1.2. Records of Tests

1.1.2.1. Written records shall be kept of all **tests** and corrective measures for a period of two years after they are made, and the records shall be available upon request to the **Chief Fire Official**.

Subsection 1.1.3. Demolition

1.1.3.1. Permits for the **demolition** or partial **demolition** of a **building** are required under the **Building Code**.

Subsection 1.1.4. Imperial Values

1.1.4.1. Imperial values corresponding to the values contained in this Code are set out in Appendix A hereto.

Subsection 1.1.5. Required Testing

1.1.5.1. Where a **building** or its contents must be **tested** for compliance with this Code, the **tests** shall be carried out by the **owner** or the **owner's** agent within such reasonable time as the **Chief Fire Official** may determine.

1.1.5.2.(1) The **tests** referred to in Article 1.1.5.1. may be carried out by the **Chief Fire Official**.

(2) The **Chief Fire Official** shall only take such samples as are necessary in the circumstances in order to carry out the **tests** referred to in Article 1.1.5.1.

Subsection 1.1.6. Licensing of Persons Installing or Maintaining Fire Protection Equipment

RESERVED

Subsection 1.1.7. Exemptions

1.1.7.1. A **building** or premises on a farm that is used for farming purposes and not as a residence is exempt from the requirements of this Code.

1.1.7.2. A hotel that is regulated by or under the **Hotel Fire Safety Act** is exempt from the requirements of this Code.

1.1.7.3. Despite Part 10, the requirements of Articles 2.6.1.12., 2.6.2.1., 2.6.3.2., 3.2.1.2., 5.4.2.3., 5.4.5.1., 5.5.6.1., 5.6.2.4., 5.12.2.3., 5.12.8.2., 5.13.6.1., and 5.18.3.3. and Part 9 do not apply to installations or construction that meet the requirements of Ontario Regulation 730/81 on the 10th day of February, 1987.

Subsection 1.1.8. Standards Referenced

1.1.8.1. In the event of a conflict between this Code and any standard, document, manual or handbook referred to herein, this Code shall apply.

1.1.8.2. A reference to a standard, document, manual or handbook in this Code shall include all amendments to the 28th day of January, 1987.

Subsection 1.1.9. Chief Fire Official

1.1.9.1. The Fire Marshal may appoint persons who are assistants to the Fire Marshal to be **Chief Fire Officials** for the purposes and subject to the limitations and conditions as are set out in the appointment.

1.1.9.2. An appointment made under Article 1.1.9.1. may grant to the person appointed the exclusive authority to exercise all or any of the powers and perform all or any of the duties of a **Chief Fire Official** with respect to any class or classes of **building** or **occupancy** or within the territorial area specified in the appointment and, in such case, no other **Chief Fire Official** shall exercise such powers or perform such duties.

SECTION 1.2 DEFINITIONS OF WORDS AND PHRASES

Subsection 1.2.1. Definitions

1.2.1.1. Definitions of words and phrases that are not included in the list of definitions in this Part shall have the meanings which are commonly assigned to them in the context in which they are used in this Code, taking into account the specialized use of terms by the various trades and professions to which the terminology applies.

1.2.1.2. The words and terms used in this Code that are in lower case bold face shall have the following meanings:

- Access to exit** means that part of a means of egress within a floor area that provides access to an exit serving the floor area.
- Air-supported structure** means a structure that consists of a pliable membrane that achieves and maintains its shape and support by internal air pressure.
- Appliance** means a device to convert fuel into energy, and includes all components, controls, wiring and piping required to be part of the device by the applicable standard referred to in this Code.
- Approved** means approved by the Chief Fire Official.
- Architect** means a member or licensee of the Ontario Association of Architects under the Architects Act.
- Assembly occupancy** means the occupancy or the use of a building, or part thereof, by a gathering of persons for civic, political, travel, religious, social, educational, recreational or like purposes or for the consumption of food or drink.
- Atmospheric storage tank** means a storage tank that is designed to operate at pressures from atmospheric to 3.5 kPa (gauge).
- Attic space** means the space between the roof and the ceiling of the top storey or between a dwarf wall and a sloping roof.
- Basement** means any storey below the first storey measured from the top of each floor to the top of the floor next below.
- Boiler** means an appliance intended to supply hot water or steam for space heating, processing or power purposes.
- Breeching** means a flue pipe or chamber for receiving flue gases from 1 or more flue connections and for discharging these gases through a single flue connection.
- Building** means any structure used or intended for supporting or sheltering any use or occupancy.
- Building area** means the greatest horizontal area of a storey above grade within the outside surface of exterior walls or where there is a firewall, the outside surface of exterior walls and the centre line of the firewall.
- Building Code** means Regulation 61 of Revised Regulations of Ontario, 1990.
- Building height (in storeys)** means the number of storeys contained between the roof and the floor of the first storey.
- Business and personal services occupancy** means the occupancy or use of a building or part thereof for the transaction of business or the rendering or receiving of professional or personal services.
- Cellar** means a basement that is more than 50 per cent below grade.
- Check** means visual observation to ensure the device or system is in place and is not obviously damaged or obstructed.
- Chief Fire Official** means the Municipal Fire Chief or a member or members of the fire department designated by the Municipal Fire Chief or a person appointed by the Fire Marshal under Subsection 1.1.9.
- Chimney** means a primarily vertical shaft enclosing at least 1 flue for conducting flue gases to the outdoors.
- Chimney liner** means a conduit containing a chimney flue used as a lining of a masonry or concrete chimney.
- Class A fire** means a fire involving combustible materials such as wood, cloth and paper.
- Class B fire** means a fire involving a flammable or combustible liquid, fat or grease.
- Class C fire** means a fire involving energized electrical equipment.
- Class D fire** means a fire involving a combustible metal.
- Closed container** means a container so sealed by means of a lid or other device that neither liquid nor vapour will escape from it at ordinary temperatures.
- Closure** means a device or assembly for closing an opening through a fire separation such as a door, a shutter, wired glass or glass block and includes all components, such as hardware, closing devices, frames and anchors.
- Combustible construction** means that type of construction that does not meet the requirements for noncombustible construction.
- Combustible dusts** means dusts and particles ignitable and liable to explode from handling or processing of grain, malt and the manufacture of flour and feed.
- Combustible fibres** means finely divided combustible vegetable or animal fibres and thin sheets or flakes of such materials that in a loose, unbaled condition present a flash fire hazard, and includes cotton, wool, hemp, sisal, jute, kapok, paper and cloth.
- Combustible liquid** means any liquid having a flash point at or above 37.8°C and below 93.3°C.
- Compressed gas** means any contained mixture or material with either an absolute pressure exceeding 275.8 kPa at 21°C or an absolute pressure exceeding 717 kPa at 54°C, or both, or any liquid having an absolute vapour pressure exceeding 275.8 kPa at 37.8°C.
- Constructor** means a person who contracts with an owner, occupant or their authorized agent to undertake a project, and includes an owner, occupant or authorized agent who contracts with more than one person for the work on a project or undertakes the work on a project or any part thereof.
- Corrosive liquid** means a liquid that, when contacting living tissue causes damage to the tissue, or when contacting organic matter and chemicals that react with the liquid, causes fire.
- Demolition** means the doing of anything in the removal of a building or any material part thereof.
- Dwelling unit** means a room or suite of rooms operated as a house-keeping unit that is used or intended to be used as a domicile by 1 or more persons and that may contain cooking, eating, living, sleeping and sanitary facilities.
- Existing** means in existence on the 11th day of February, 1987.
- Exit** means that part of a means of egress that leads from the floor area it serves and includes any doorway leading directly from a floor area to a public thoroughfare or to an approved open space.
- Fire compartment** means an enclosed space in a building that is separated from all other parts of the building by enclosing construction that provides a fire separation having a required fire-resistance rating.
- Fire damper** means a closure that consists of a damper installed in an air distribution system or in a wall or floor assembly that is normally held in the open position and that is designed to close automatically in the event of a fire in order to maintain the integrity of the fire separation.
- Fire department** means a fire department organized under the Municipal Act that provides fire protection for the municipality and that is equipped with one or more motorized fire pumpers meeting the requirements of Regulation 453 of Revised Regulations of Ontario, 1990.
- Fire-protection rating** means the time in hours or fraction thereof that a closure, window assembly or glass block assembly will withstand the passage of flame when exposed to fire under specified conditions of test and performance criteria, or as otherwise prescribed in the Building Code.
- Fire resistance** means the property of a material or assembly in a building to withstand fire or give protection from it and is characterized by the ability of the material or assembly to confine a fire or to continue to perform a given structural function or both.
- Fire-resistance rating** means the time in hours or fraction thereof that a material or assembly of materials will withstand the passage of flame and the transmission of heat when exposed to fire under specified conditions of test and performance criteria, or as determined by extension or interpretation of information derived therefrom as prescribed in the Building Code.
- Fire separation** means a construction assembly that acts as a barrier against the spread of fire and may or may not have a fire-resistance rating or a fire-protection rating.
- Fire stop** means a draft-tight barrier within or between construction assemblies that acts to retard the passage of smoke and flame.
- Fire-stop flap** means a device intended for use in horizontal assemblies that are required to have a fire-resistance rating and incorporate protective ceiling membranes and that operates to close off a duct opening through the membrane in the event of a fire.
- Firewall** means a fire separation of noncombustible construction that subdivides a building or separates adjoining buildings to resist the spread of fire that has a fire-resistance rating as prescribed in the Building Code and that has structural stability to remain intact under fire conditions for the required fire-rated time.
- First storey** means the storey with its floor closest to grade and having its ceiling more than 1.8 m above grade.
- Flame-spread rating** means an index or classification indicating the extent of spread of flame on the surface of a material or an assembly of materials as determined in the Building Code.
- Flammable liquid** means any liquid having a flash point below 37.8°C and having an absolute vapour pressure not exceeding 275.8 kPa at 37.8°C.
- Flash point** means the minimum temperature at which a liquid within a container gives off vapour in sufficient concentration to form an ignitable mixture with air near the surface of the liquid.

Floor area means the space on any storey of a **building** between exterior walls and required firewalls and includes the space occupied by interior walls and **partitions**, but does not include exits and vertical service spaces that pierce the storey.

Flue means an enclosed passageway for conveying flue gases.

Flue pipe means the pipe connecting the flue collar of an **appliance** to a chimney.

Furnace means a **space-heating appliance** that uses warm air as the heating medium and that usually has provision for the attachment of ducts.

Grade (as applying to the determination of **building height**) means the average level of finished ground adjoining a **building** at all exterior walls.

Hazardous location means a location that is or may become subject to conditions conducive to the rapid development of fire or explosion.

Heavy timber construction means that type of **combustible construction** in which a degree of fire safety is attained by placing limitations on the sizes of wood structural members and on thickness and composition of wood floors and roofs, by avoidance of concealed spaces under floors and roofs and by use of **approved** fastenings, construction details and adhesives for structural members.

High hazard industrial occupancy (Group "F" Division 1) means an **industrial occupancy** that contains sufficient quantities of highly combustible and flammable or explosive materials that, because of their inherent characteristics, constitute a special fire hazard.

Industrial occupancy means the **occupancy** or use of a **building** or part thereof for assembling, fabricating, manufacturing, processing, repairing or storing of goods and materials.

Inspect means physical examination to determine that the device or system will apparently perform in accordance with its intended function.

Institutional occupancy means the **occupancy** or use of a **building** or part thereof by persons harboured or detained to receive medical care or treatment, or by persons involuntarily detained.

Listed means equipment or materials included in a list published by a certification organization accredited by the Standards Council of Canada.

Lower explosive limit means the minimum concentration of vapour in air at which the propagation of flame occurs on contact with a source of ignition.

Low pressure storage tank means a **storage tank** designed to operate at pressures from 3.5 kPa (gauge) to 100 kPa (gauge).

Major occupancy means the principal **occupancy** for which a **building** or part thereof is used or intended to be used, and includes the subsidiary **occupancies** that are an integral part of the principal **occupancy**.

Means of egress means a continuous path of travel provided by a doorway, hallway, corridor, exterior passageway, balcony, lobby, stair, ramp or other egress facility or combination thereof, for the escape of persons from any point in a **building**, **floor area**, room or contained open space to a public thoroughfare or other **approved** open space and includes exits and access to exits.

Mercantile occupancy means the **occupancy** or use of a **building** or part thereof for the displaying or selling of retail goods, wares or merchandise.

Noncombustible construction means that type of construction in which a degree of fire safety is attained by the use of noncombustible materials for structural members and other **building** assemblies.

Occupancy means the use or intended use of a **building** or part thereof for the shelter or support of persons, animals or property.

Occupant load means the number of persons for which a **building** or part thereof is designed.

Order means an order made under clause 18 (2) (e) of the Act.

Owner means any person, firm or corporation having control over any portion of the **building** or property under consideration and includes the persons in the **building** or property.

Oxidizing material means a material, other than ordinary atmospheres, that by itself is not necessarily combustible, but that may, generally by yielding oxygen, cause or contribute to the combustion of another material.

Partition means an interior wall, **storey** or part of a **storey** in height that is not load-bearing.

Pressure vessel means a **storage tank** that is designed to operate at pressures greater than 100 kPa (gauge).

Professional Engineer means a member or licensee of the Association of Professional Engineers of the Province of Ontario under the **Professional Engineers Act**.

Public corridor means a corridor that provides access to exit from individually rented rooms, suites of rooms or **dwelling units**.

Residential occupancy means the **occupancy** of use of a **building** or part thereof by persons for whom sleeping accommodation is provided but who are not harboured or detained to receive medical care or treatment or are not involuntarily detained.

Retrofit means the minimum performance requirements for life safety for existing **buildings**.

Smoke alarm means a combined **smoke detector** and audible alarm device that is designed to sound an alarm within the room or suite in which it is located when there is smoke within the room or suite.

Smoke detector means a device that senses the presence of visible or invisible particles produced by combustion and that automatically initiates a signal indicating this condition.

Space heater means a **space-heating appliance** that heats the room or space within which it is located without the use of ducts.

Space-heating appliance means an **appliance** that supplies heat to a room or space directly or indirectly or to rooms or spaces of a **building** through a heating system.

Spraying area means the area that is within 6 m of a **spray booth** or spraying operation and that is not separated therefrom by a vapour-tight separation.

Spray booth means a power-ventilated structure that encloses or accommodates a spraying operation so that spray vapour and residue can be controlled and exhausted.

Spray room means a **spraying area** on a **floor area** or part thereof in which an open spraying operation is confined and that is separated from the remainder of the **building** in which it is located by a non-combustible vapour-tight separation.

Sprinklered (as applying to a **building** or part thereof) means that the **building** or part thereof is equipped with a system of automatic sprinklers.

Storage tank means a **closed container** installed in a fixed location and includes temporary arrangements on cradles or skids.

Storey means that portion of a **building** that is situated between the top of any floor and the top of the floor next above it, and where there is no floor above it, that portion between the top of the floor and the ceiling above it.

Street means any highway, road, boulevard, square or other improved thoroughfare 9 m or more in width, that has been dedicated or deeded for public use, and is accessible to **fire department** vehicles and equipment.

Supervisory staff means those occupants of a **building** who have some delegated responsibility for the fire safety of other occupants under the fire safety plan and may include the **fire department** where the **fire department** agrees to accept these responsibilities.

Tent means a shelter or structure with a covering that is made of pliable material.

Test means the operation of a device or system to ensure that it will perform in accordance with its intended operation or function.

Travel distance means the distance from any point in a **floor area** to an exit measured along the path of exit travel, except that when **floor areas** are subdivided into rooms used singly or into suites of rooms and served by **public corridors** or exterior passageways, the distance shall be measured from the door of the rooms or suites to the nearest exit.

Vapour pressure means the pressure exerted by a liquid as determined by ASTM D323-58(1968), "Vapour Pressure of Petroleum Products (Reid Method)".

Viscosity means the resistance that a liquid offers to flow.

SECTION 1.3 ABBREVIATIONS

Subsection 1.3.1. Abbreviations of Names of Associations

1.3.1.1. The abbreviations in this Code for the names of associations shall have the meanings assigned to them as follows.

ACNBC Associate Committee on the National Building Code

ANSI	American National Standards Institute
API	American Petroleum Institute
ASME	American Society of Mechanical Engineers
ASTM	American Society for Testing and Materials
CGSB	Canadian General Standards Board
CSA	Canadian Standards Association
NFPA	National Fire Protection Association
ULC	Underwriters' Laboratories of Canada
Subsection 1.3.2. Abbreviations of Words and Phrases	
1.3.2.1. The abbreviations of words and phrases in this Code shall have the meanings assigned to them as follows:	
cm	centimetre(s)
cm ²	square centimetre(s)
°C	degree(s) Celsius
cs	centistoke(s)
hr	hour(s)
kg	kilogram(s)
kN	kilonewton(s)
kPa	kilopascal(s)
L	litre(s)
L/min	litre(s) per minute
lx	lux
m	metre(s)
m ²	square metre(s)
m ³	cubic metre(s)
m/min	metre(s) per minute
m ³ /min	cubic metre(s) per minute
ml	millilitre(s)
mm	millimetre(s)
N	newton(s)
ppm	part(s) per million
s	second(s)
t	tonne(s)

PART 2 BUILDING AND OCCUPANT FIRE SAFETY

TABLE OF CONTENTS

SECTION 2.1	GENERAL
Subsection 2.1.1.	Scope and Application
Subsection 2.1.2.	Classification of Buildings or Parts of Buildings by Major Occupancy

SECTION 2.2	FIRE SEPARATIONS
Subsection 2.2.1.	Major Occupancies
Subsection 2.2.2.	Rooms and Spaces
Subsection 2.2.3.	Closures
SECTION 2.3	INTERIOR FINISHING, FURNISHING AND DECORATIVE MATERIALS
Subsection 2.3.1.	General
Subsection 2.3.2.	Textile Flammability
SECTION 2.4	FIRE HAZARDS
Subsection 2.4.1.	Combustible Materials
Subsection 2.4.2.	Exposure to Combustible Materials
Subsection 2.4.3.	Smoking
Subsection 2.4.4.	Open Flames
Subsection 2.4.5.	Use of Hazardous Materials
Subsection 2.4.6.	Electrical Hazards
SECTION 2.5	FIRE DEPARTMENT ACCESS TO BUILDINGS
Subsection 2.5.1.	General
SECTION 2.6	SERVICE EQUIPMENT
Subsection 2.6.1.	Heating, Ventilating and Air-Conditioning
Subsection 2.6.2.	Solid Fuel Burning Appliances
Subsection 2.6.3.	Incinerators
Subsection 2.6.4.	Transformer Vaults
SECTION 2.7	SAFETY TO LIFE
Subsection 2.7.1.	Means of Egress
Subsection 2.7.2.	Exit Door Hardware
Subsection 2.7.3.	Exit Lighting and Emergency Lighting
SECTION 2.8	EMERGENCY PLANNING
Subsection 2.8.1.	General
Subsection 2.8.2.	Fire Safety Plan
Subsection 2.8.3.	Fire Drills
SECTION 2.9	TENTS AND AIR SUPPORTED STRUCTURES
Subsection 2.9.1.	General
Subsection 2.9.2.	Materials
Subsection 2.9.3.	Fire Hazards and Control
SECTION 2.10	DAY-CARE CENTRES
Subsection 2.10.1.	Combustible Materials
SECTION 2.11	INSULATION AND RE-INSULATION
Subsection 2.11.1.	General
SECTION 2.12	COVERED MALLS
Subsection 2.12.1.	General

SECTION 2.1 GENERAL

Subsection 2.1.1. Scope and Application

Scope

2.1.1.1. This Part provides for the safety of the occupants in existing **buildings**, through the elimination or control of fire hazards in and around **buildings**, the maintenance of certain life safety systems in **buildings** and for the establishing of a fire safety plan in those **buildings** where necessary.

Application

2.1.1.2.(1) Part 2 of this Code applies to all **buildings**.

(2) Part 2 does not apply to individual **dwelling units**.

2.1.1.3. Despite Sentence 2.1.1.2.(2), Sections 2.2 Fire Separations, 2.6 Service Equipment and 2.11 Insulation and Re-Insulation apply to individual **dwelling units**.

Subsection 2.1.2. Classification of Buildings or Parts of Buildings by Major Occupancy

Classification of buildings or parts thereof

2.1.2.1. For the purpose of applying this Code, a building or part thereof shall be classified according to its **major occupancy** by the **Chief Fire Official** in conformance with the **Building Code**.

Hazardous activities

2.1.2.2. Activities that create a hazard and that are not allowed for in the original design shall not be carried out in a **building** unless provisions are made to alleviate the hazard and the carrying on of the activities is **approved**.

Prohibited combinations of occupancies

2.1.2.3. No **major occupancy** of Group 'F' Division 1 shall be contained within a **building** with any **occupancy** classified as Group 'A', 'B' or 'C'.

SECTION 2.2 FIRE SEPARATIONS

Subsection 2.2.1. Major Occupancies

Damaged fire separations

2.2.1.1. Where **fire separations** between **major occupancies** are damaged in a manner so as to affect the integrity of their **fire-resistance rating**, such **damaged fire separations** shall be repaired so that the integrity of the **fire separations** is maintained.

Subsection 2.2.2. Rooms and Spaces

Damaged fire separations

2.2.2.1. Where **fire separations** between rooms, corridors, shafts and other spaces are damaged so as to affect the integrity of their **fire-resistance rating**, the **damaged fire separations** shall be repaired so that the integrity of the **fire separations** is maintained.

Subsection 2.2.3. Closures

Damaged closures

2.2.3.1. Where **closures** are damaged so as to affect the integrity of their **fire-protection rating**, the **damaged closures** shall be repaired so that the integrity of the **closures** is maintained.

Maintenance of closures

2.2.3.2.(1) **Closures** in **fire separations** shall be maintained to ensure that they are operable at all times by

- (a) keeping fusible links and heat or smoke actuated devices undamaged and free of paint and dirt,
- (b) keeping guides, bearings and stay rolls clean and lubricated,
- (c) **inspecting** door hardware and other ancillary components and making necessary adjustments or repairs to ensure proper closing and latching, and
- (d) repairing or replacing inoperative parts of hold-open devices and automatic releasing devices.

2.2.3.3. **Closures** in **fire separations** shall not be blocked or wedged open.

Inspection of doors in fire separations

2.2.3.4. Doors in **fire separations** shall be inspected monthly.

2.2.3.5. Doors in **fire separations** in occupied **buildings** shall be **checked** as frequently as necessary to ensure that they remain closed, unless equipment is installed to close the doors automatically as required under the fire safety plan identified in Subsection 2.8.2.

2.2.3.6. RESERVED

Inspection of fire dampers and fire-stop flaps

2.2.3.7. **Fire dampers** and **fire-stop flaps** shall be inspected annually, or on an **approved** time schedule.

2.2.3.8. Door openings and the surrounding areas shall be kept clear of everything that would be likely to obstruct or interfere with the free operation of the door.

SECTION 2.3 INTERIOR FINISHING, FURNISHING AND DECORATIVE MATERIALS

Subsection 2.3.1. General

2.3.1.1.(1) Where a **building** is refurbished or redecorated, interior finish materials used shall be in conformance with the **Building Code**.

(2) Despite Sentence (1), other interior finish materials may be **approved**.

Moveable partitions and screens

2.3.1.2. Moveable **partitions** or screens, including acoustical screens, shall have a **flame-spread rating** equal to that required for the interior finish of the area in which they are located as determined in the **Building Code**.

Subsection 2.3.2. Textile Flammability

Flame resistance of textiles

2.3.2.1.(1) Drapes, curtains and other decorative materials, including textiles and films used in **buildings**, shall meet the requirements for a high degree of **flame resistance**, as described in NOTE 4 of CAN 2-4.2 M77: "Textile Methods", Method 27.1, when such drapes, curtains and other decorative materials are used in

- (a) Group 'B' **occupancy**,
- (b) any lobby or exit,
- (c) any **access to exit** in a Group 'A' **occupancy**, and **assembly occupancies** with an **occupant load** of more than 100 persons, or
- (d) any open **floor area** in any Group 'D', 'E' or 'F' **occupancy** exceeding 1500 m², except when the **floor area** is divided into **fire compartments** not exceeding 1500 m² in area and separated from the remainder of the **floor area** by a **fire separation** having a 1-hr **fire-resistance rating**.

Flameproofing treatments

2.3.2.2. Flameproofing treatments shall be renewed as often as required to ensure that the material will pass the match flame test in NFPA 701-1977, "Standard Methods of Fire Tests for Flame Resistant Textiles and Films."

SECTION 2.4 FIRE HAZARDS

Subsection 2.4.1. Combustible Materials

Accumulation of combustible materials

2.4.1.1. Combustible waste materials in **buildings** shall not be permitted to accumulate in quantities or locations that may constitute a fire hazard.

2.4.1.2. Combustible materials shall not be permitted to accumulate in any part of an elevator shaft, ventilation shaft, stairway, fire escape or other means of egress.

Liquid spill absorption

2.4.1.3. Combustible materials shall not be used to absorb **flammable** or **combustible liquid** spills within **buildings**.

Precautions against spontaneous combustion

2.4.1.4. Greasy or oily rags or materials subject to spontaneous heating shall be deposited in a receptacle conforming to Article 2.4.1.9. or be removed from the premises.

Lint traps

2.4.1.5. Lint traps in laundry equipment shall be cleaned to prevent the excessive accumulation of lint.

Waste materials in industrial occupancies

2.4.1.6.(1) Combustible waste materials in a **building** of an **industrial occupancy** that constitute a fire hazard shall be baled or stored in receptacles conforming to Article 2.4.1.9.

(2) Sentence (1) does not apply to in-process packaging materials where the **building** is **sprinklered**.

Storage of combustible waste

2.4.1.7. Where rooms are provided for the storage of combustible waste materials, the rooms shall conform to the **Building Code**.

Storage of ashes

2.4.1.8. Ashes shall be stored in receptacles conforming to Article 2.4.1.9., and combustible materials shall not be stored with ashes in the same container.

Receptacles for the storage of combustible materials

2.4.1.9.(1) Safety containers shall be provided for the storage of combustible materials.

(2) Containers required in Sentence (1) shall be constructed of noncombustible materials having a melting point of not less than 650°C, designed without any openings in the sides and bottom, and provided with a self-closing, tightly fitted cover.

2.4.1.10. Receptacles as described in Article 2.4.1.9. shall not be placed closer than 1 m on the sides and top to combustible materials, and where placed on a combustible floor surface shall be equipped with a flanged bottom or legs not less than 50 mm in height.

Subsection 2.4.2. Exposure to Combustible Materials

2.4.2.1. Combustible materials shall not be stored on a roof or adjacent to any **building** so as to create a fire hazard to the **building** or its occupants.

Subsection 2.4.3. Smoking

Smoking prohibited

2.4.3.1. Where conditions are such as to make smoking a fire or explosion hazard, smoking shall be permitted only in specifically **approved** smoking areas.

Signs

2.4.3.2. The areas where smoking is not permitted shall be identified by signs having black lettering 50 mm high with a 12.5 mm stroke on a yellow background, except that symbols of 150 mm × 150 mm may be used in lieu of lettering, or covered by instructions established under a fire safety plan and available to all persons.

Subsection 2.4.4. Open Flames

Open flames prohibited

2.4.4.1.(1) Open flames shall not be permitted in **buildings** used for public assemblies in such quantities and in such a manner as to create a fire hazard unless **approved**.

(2) Open flames shall not be permitted in dining areas in Group 'B' Division 2 **occupancies**.

2.4.4.2.(1) Flaming meals or drinks shall not be served in Group 'B' Division 2 **occupancies**.

(2) Flaming meals or drinks shall be ignited only at the location of serving in places of public assembly.

Portable extinguishers

(3) A 1A: 5BC or higher rated portable extinguisher, conforming to the requirements of Part 6, shall be available where refueling of **appliances** and containers used for flaming meals or drinks takes place.

(4) Refueling of **appliances** shall not be carried out in the dining area.

Portable extinguishers for flaming meals and drinks

2.4.4.3. A 1A: 5BC or higher rated portable extinguisher, conforming to the requirements of Part 6, shall be located on the serving cart or table where flaming meals and drinks are being served.

Devices having open flames

2.4.4.4. Devices having open flames shall be securely supported in noncombustible holders and located or protected so as to prevent accidental contact of the flame with combustible materials.

Subsection 2.4.5. Use of Hazardous Materials

2.4.5.1. **Flammable liquids** shall not be used for cleaning purposes except where the cleaning is an essential part of a process.

2.4.5.2. Flammable gases shall not be used to inflate balloons.

Subsection 2.4.6. Electrical Hazards

Electrical wiring

2.4.6.1. Temporary electrical wiring shall not be used where it presents a fire hazard.

SECTION 2.5 FIRE DEPARTMENT ACCESS TO BUILDINGS

Subsection 2.5.1. General

Application

2.5.1.1.(1) This Section applies to fire access routes

- (a) required to be constructed under the **Building Code**,
- (b) provided under a municipal by-law, or
- (c) designated under Paragraph 52 of Section 210 of the **Municipal Act**.

Maintaining access free of obstructions

2.5.1.2.(1) Fire access routes and access panels or windows provided to facilitate access for fire fighting operations shall not be obstructed by vehicles, gates, fences, building materials, vegetation, signs or any other form of obstruction.

Fire department connections

(2) **Fire department** sprinkler and standpipe connections shall be clearly identified and maintained free of obstructions for use at all times.

Maintenance

2.5.1.3. Fire access routes shall be maintained so as to be immediately ready for use at all times by **fire department** vehicles.

Signs

2.5.1.4. **Approved** signs shall be displayed to indicate fire access routes.

SECTION 2.6 SERVICE EQUIPMENT

Subsection 2.6.1. Heating, Ventilating, and Air-Conditioning

Defective equipment

2.6.1.1. Defective **appliances** in a **building** shall be removed, repaired or replaced when the defective **appliances** create a hazardous condition.

2.6.1.2. **Chimneys** and **chimney liners** that constitute a fire hazard shall be repaired or replaced in accordance with the **Building Code**.

Coal and wood bins

2.6.1.3. Coal and wood bins shall be located at least 1.2 m from the **appliance** served by the bins.

Inspection and maintenance

2.6.1.4. Hoods, filters and ducts that are subject to accumulations of combustible deposits shall be **checked** weekly and be cleaned when the deposits create a fire hazard.

2.6.1.5. **Chimneys, flues** and **flue pipes** shall be **inspected** annually and cleaned as often as necessary to keep them free from accumulations of combustible deposits.

Covers for flue pipe holes

2.6.1.6. Where a **flue pipe** is removed, the **flue pipe** hole shall be closed with a tight fitting noncombustible cover compatible with the **chimney flue** construction.

2.6.1.7. **Chimneys, flue pipes** and **breechings** shall be maintained in a safe operating condition.

Disconnect switches

2.6.1.8.(1) Disconnect switches for mechanical air-conditioning and ventilating systems shall be **inspected** annually to establish that the system can be shut down.

(2) Sentence (1) does not apply to **dwelling units**.

Ventilation shafts

2.6.1.9. Ventilation shafts shall be used only for ventilating purposes.

Precautions during repairs or renovations

2.6.1.10. Work on ducts involving the use of heat producing devices for cutting, welding or soldering shall not be undertaken before the system has been shut down, the duct cleaned of any accumulations of combustible deposits and any combustible lining and covering material that could be ignited by such work has been removed.

2.6.1.11. Precautions shall be taken, where necessary, to ensure that there is no damage to fuel supply piping or equipment that would result in fuel leakage or a fire hazard during renovations or excavations.

Commercial cooking equipment

2.6.1.12.(1) Commercial cooking equipment shall be provided with exhaust and fire protection systems in conformance with NFPA 96-1984, "Installation of Equipment for the Removal of Smoke and Grease-Laden Vapors from Commercial Cooking Equipment".

(2) Despite Sentence (1), existing exhaust or fire protection systems may be **approved**.

2.6.1.13. Commercial cooking equipment exhaust and fire protection systems shall be maintained in conformance with NFPA 96-1984, "Installation of Equipment for the Removal of Smoke and Grease-Laden Vapors from Commercial Cooking Equipment".

2.6.1.14.(1) Instructions for manually operating the fire extin-

guishing systems required under Article 2.6.1.12. shall be posted conspicuously in the kitchen areas.

(2) The instructions required in Sentence (1) shall be included in the fire safety plan where such a plan is required.

Subsection 2.6.2. Solid Fuel Burning Appliances

Solid fuel burning appliances

2.6.2.1. The installation of solid fuel burning **appliances** and equipment shall be in accordance with CAN3-B365-M84, "Installation Code for Solid Fuel Burning Appliances and Equipment".

2.6.2.2. Solid fuel burning **appliances** and equipment shall be maintained in accordance with CAN3-B365-M84, "Installation Code for Solid Fuel Burning Appliances and Equipment".

Subsection 2.6.3. Incinerators

Indoor incinerators

2.6.3.1. The installation and alteration of indoor incinerators shall conform to the requirements of the **Building Code**.

Outdoor incinerators

2.6.3.2. The design, construction, installation, alteration and maintenance of outdoor incinerators shall conform to NFPA 52-1982, "Incinerators, Waste and Linen Handling Systems and Equipment", except that the **flue** venting an incinerator shall not also serve as the chute conveying waste material to the incinerator.

Spark arresters

2.6.3.3.(1) Spark arresters shall be cleaned annually or more frequently where accumulations of debris will adversely affect operations.

(2) Burnt-out spark arresters shall be repaired or replaced.

Open air burning

2.6.3.4. Open air burning shall not be permitted unless **approved**, or unless such burning consists of a small, confined fire, supervised at all times, and used to cook food on a grill or a barbecue.

Subsection 2.6.4. Transformer Vaults

2.6.4.1. Transformer vaults shall not be used for storage purposes.

2.6.4.2. Transformer vaults shall be kept locked so that unauthorized persons will not have access to them.

SECTION 2.7 SAFETY TO LIFE

Subsection 2.7.1. Means of Egress

Group 'D', 'E' occupancies

2.7.1.1. Individual work areas in Group 'D' and 'E' **occupancies** shall be located adjacent to aisles described in Articles 2.7.1.2. and 2.7.1.3.

2.7.1.2. Where 2 **exits** are required from **floor areas** in **buildings** of Group 'D' and 'E' occupancy that are not subdivided into rooms or suites of rooms served by corridors giving access to **exits**, at least 1 aisle with access to the 2 **exits** and having a minimum clear width of 1100 mm shall be provided to serve the individual work areas where necessary.

2.7.1.3. Subsidiary aisles with a minimum clear width of 914 mm may branch off for a distance not exceeding 7.5 m from the aisles described in Article 2.7.1.2.

Places of assembly

2.7.1.4. The number of people permitted in an **assembly**

occupancy shall not exceed the **occupant load** as posted in conformance with Article 2.7.1.5.

Occupant load

2.7.1.5. When the **occupant load** as determined by the **Building Code** and limited by units of **exit width** available is more than 60 persons, the **occupant load** shall be posted in a conspicuous location near the main entrance.

Nonfixed seating

2.7.1.6.(1) Nonfixed row seating in an **assembly occupancy** shall be arranged as described in Sentences (2) to (6).

(2) Aisles leading to **exits** shall be provided so that there are not more than 7 seats between any seat and the nearest aisle.

(3) The minimum clear width of aisles shall be at least 1100 mm, but shall not be less than the required **exit widths** as determined by the **Building Code**.

(4) Aisles required in Sentence (3) may be reduced in width to 750 mm when serving 60 seats or less, or 914 mm when serving seats on one side only.

(5) Aisles shall terminate in a cross aisle, foyer or **exit** and the width of such cross aisle, foyer or **exit** shall be at least the required width of the widest aisle plus 50 per cent of the total required width of the remaining aisles that it serves.

(6) The distance of travel to an **exit door** by an aisle shall not be greater than 30 m.

(7) Where the **occupant load** exceeds 200 persons in an **assembly occupancy** containing nonfixed seating, the seats shall be fastened in units of not less than 4 nor more than 12 seats, or each end seat abutting an aisle shall be securely fastened to the floor.

(8) Seats may be arranged in a manner that does not meet the requirements of Sentence (7) where the aisle widths are increased by 50 per cent above the requirements set out in Sentences (2) to (6), and where the maximum **occupant load** is based on one person per 1.2 m² of total **floor area**.

Obstructions

2.7.1.7.(1) **Access to exits**, including corridors used by the public and **exits**, including outside areas, shall be maintained free of obstructions.

Lighting

(2) Lighting provided for illumination in **exits** and **access to exits**, including corridors used by the public, shall be maintained.

Fire escapes

2.7.1.8.(1) Exterior passageways, exterior stairways and fire escapes in occupied **buildings** shall be maintained in good repair and kept free of snow and ice accumulations.

(2) Where equipment is provided to melt snow or ice on exterior passageways, exterior stairways and fire escapes in an occupied **building**, the equipment shall be maintained in working order or alternative measures shall be taken as specified in Sentence (1).

Turnstiles and checkout counters

2.7.1.9.(1) Except as provided in Sentences (2) and (3), turnstiles, checkout counters, railings or barriers shall not obstruct the **exits** or **access to exits** from any room, **floor area** or storey.

(2) Checkout counters or control posts in retail outlets may be used within **access to exits** where an unobstructed width of 450 mm is maintained up to a height of 914 mm.

(3) Where the checkout counters or control posts exceed 914 mm in height, a clear width of 550 mm shall be retained.

(4) The locations described in Sentences (2) and (3) shall be deemed to provide 1 unit of **exit width** and the total number of units of **exit width** required must be provided from each area.

(5) Wheeled carts shall be stored after use so as not to obstruct **access to exits** in retail outlets where wheeled carts are used by customers.

Subsection 2.7.2. Exit Door Hardware

Panic hardware

2.7.2.1.(1) **Exit doors** shall be equipped with **approved hardware** that will release and allow the door to swing open when a force of not more than 90 N is applied to the hardware in the direction of **exit travel**, where required by the **Building Code**.

(2) Every **exit door** shall open in the direction of **exit travel** when the latch is released under a force of not more than 90 N applied at the knob or other latch releasing device.

(3) Sentence (2) does not apply where the existing **exit doors** are **approved** and do not endanger life safety or alternative measures to the requirements set out in Sentence (2) are taken to provide life safety.

2.7.2.2. Devices on any required **exit door** shall be such that the door may be readily opened from the inside without the use of keys and shall be designed to be opened in a conventional manner without the use of unusual devices or requiring a specialized knowledge of the door opening device, except that this requirement shall not apply to **exits** serving persons under legal restraint.

Subsection 2.7.3. Exit Lighting and Emergency Lighting

Exit signs

2.7.3.1. Required **exit signs** shall be clearly visible and maintained in a clean and legible condition.

2.7.3.2. Internally illuminated **exit lights** shall be kept clearly illuminated at all times, when the **building** is occupied.

Emergency lighting

2.7.3.3.(1) Pilot lights on emergency lighting unit equipment shall be **checked** monthly for operation.

(2) Emergency lighting unit equipment shall be **inspected** monthly to ensure that

- (a) the terminal connections are clean, free of corrosion and lubricated when necessary,
- (b) the terminal clamps are clean and tight as per manufacturer's specifications,
- (c) the electrolyte level and specific gravity are maintained as per manufacturer's specifications, and
- (d) the battery surface is kept clean and dry.

(3) Emergency lighting unit equipment shall be **tested**

- (a) monthly to ensure that the emergency lights will function upon failure of the primary power supply, and
- (b) annually to ensure that the unit will provide emergency lighting for a duration equal to the design criteria under simulated power failure conditions.

(4) After completion of the **test** required in Clause (3)(b), the charging conditions for voltage and current and the recovery period shall be **tested** to ensure that the charging system is in accordance with the manufacturer's specifications.

SECTION 2.8 EMERGENCY PLANNING

Subsection 2.8.1. General

Application

2.8.1.1.(1) The requirements of this Section shall apply to **buildings** containing a

- (a) Group 'A' or 'B' occupancy,
- (b) Group 'C' occupancy where the occupant load exceeds 10,
- (c) Group 'D' occupancy where the occupant load exceeds 300,
- (d) Group 'E' occupancy where the occupant load exceeds 300,
- (e) Group 'F' Division 1 occupancy where the occupant load exceeds 25,
- (f) Group 'F' Division 2 occupancy where the occupant load exceeds 100, or
- (g) Group 'F' Division 3 occupancy where the occupant load exceeds 300.

(2) Despite Sentence (1), the requirements of this Section shall apply to **buildings**

- (a) containing 4 storeys or more, including storeys below grade,
- (b) regulated by Section 9.3 Boarding, Lodging and Rooming Houses, or
- (c) used as a convalescent home or children's custodial home providing sleeping accommodation for more than 3 persons.

(3) Despite Sentence (1), the requirements of this Section apply to recreational camps regulated under the **Health Protection and Promotion Act**.

Instructions in emergency procedures

2.8.1.2.(1) **Supervisory staff** shall be instructed in the fire emergency procedures as described in the fire safety plan before they are given any responsibility for fire safety.

(2) **Supervisory staff** shall be available on notification of a fire emergency to fulfil their obligation as described in the fire safety plan.

(3) It is not necessary that **supervisory staff** be in the **building** on a continual basis.

Subsection 2.8.2. Fire Safety Plan

Measures in a fire safety plan

2.8.2.1.(1) A fire safety plan shall include

- (a) the emergency procedures to be used in case of fire including sounding the fire alarm, notifying the **fire department**, provisions for access for fire fighting, instructing occupants on procedures to be followed when the fire alarm sounds, evacuating endangered occupants and confining, controlling and extinguishing the fire,
- (b) the appointment and organization of designated **supervisory staff** to carry out fire safety duties,
- (c) the instruction of **supervisory staff** and other occupants so that they are aware of their responsibilities for fire safety,
- (d) the holding of fire drills including the emergency procedures appropriate to the **building**,

(e) the control of fire hazards in the **building**,

(f) the maintenance of **building** facilities provided for the safety of occupants, and

(g) the provisions of alternative measures for safety of occupants during any shutdown of fire protection equipment and systems or part thereof

and shall be prepared, **approved** and implemented in **buildings** regulated by Article 2.8.1.1.

Institutional occupancies

2.8.2.2. There shall be sufficient **supervisory staff** available in **institutional occupancies** to carry out the duties as required in the fire safety plan.

Schematic diagrams

2.8.2.3. Schematic diagrams shall be prepared, **approved** and maintained showing the type, location and operation of **building** fire emergency systems.

High buildings

2.8.2.4.(1) The fire safety plan in **buildings** within the scope of Subsection 3.2.6. of the **Building Code** shall, in addition to the requirements of Sentence 2.8.2.1.(1), include

- (a) the instruction of **supervisory staff** on the use of the voice communication system,
- (b) the procedures for use of elevators and for evacuation of persons in need of assistance,
- (c) the action to be taken by **supervisory staff** in initiating any smoke control or other fire emergency systems installed in a **building** in the event of fire until the **fire department** arrives, and
- (d) the procedures established to facilitate **fire department** access to the **building** and fire location within the **building**.

2.8.2.5.(1) A record including schematic diagrams of the fire emergency systems installed in **buildings** within the scope of Subsection 3.2.6. of the **Building Code** shall be maintained at the central alarm and control facility.

(2) The records required in Sentence (1) shall include instructions for the **supervisory staff** and **fire department** for the operation of the systems.

2.8.2.6. A copy of the fire emergency procedures and other duties for **supervisory staff** as laid down in the fire safety plan shall be given to all **supervisory staff**.

Posting of instructions

2.8.2.7. At least one copy of the fire emergency procedures shall be prominently posted and maintained on each **floor area**.

Subsection 2.8.3. Fire Drills

Procedures

2.8.3.1.(1) The procedure for conducting fire drills described in Clause 2.8.2.1.(1)(d) shall be included in the fire safety plan, taking into consideration

- (a) the **building** occupancy and its fire hazards,
- (b) the safety features provided in the **building**,
- (c) the desirable degree of participation of occupants other than **supervisory staff**,
- (d) the number and degree of experience of participating **supervisory staff**, and

- (e) the **testing and operation** of the emergency systems installed in **buildings** within the scope of Subsection 3.2.6. of the **Building Code**.

(2) The fire drill procedures required in Sentence (1) shall be prepared in consultation with the **Chief Fire Official**.

Frequency

2.8.3.2.(1) Fire drills as described in Sentence 2.8.3.1.(1) shall be held once during each 12-month period for the **supervisory staff**, except that

- (a) in day-care centres and Group 'B' occupancies, fire drills shall be held monthly,
- (b) in schools attended by children, total evacuation fire drills shall be held 3 times in each of the fall and spring school terms, and
- (c) in **buildings** within the scope of Subsection 3.2.6. of the **Building Code**, fire drills shall be held every 3 months.

SECTION 2.9 TENTS AND AIR-SUPPORTED STRUCTURES

Subsection 2.9.1. General

2.9.1.1. **Tents and air-supported structures** shall be in conformance with the **Building Code**.

2.9.1.2. This Section does not apply to **tents** that are used for camping, personal or other non-commercial uses, each having an area of 30 m² or less.

Subsection 2.9.2. Materials

Tests

2.9.2.1. When required by the **Chief Fire Official**, **tests** shall be carried out on samples of materials taken in the field in conformance with NFPA 701-1977, "Standard Methods of Fire Tests for Flame Resistant Textiles and Films".

Subsection 2.9.3. Fire Hazards and Control

Combustible materials

2.9.3.1. Hay, straw, shavings or similar combustible materials other than that necessary for the daily feeding and care of animals shall not be permitted within a **tent** or **air-supported structure** used for an **assembly occupancy**, except that sawdust and shavings may be used if kept damp.

Smoking and open flames

2.9.3.2. Smoking and open flame devices shall not be permitted in a **tent** or **air-supported structure** unless provisions have been made for such activities under the fire safety plan.

Firewatch

2.9.3.3. Where a fire alarm system is not provided in conformance with Subsection 3.2.4. of the **Building Code**, a person shall be employed for firewatch duty in **tents** and **air-supported structures** occupied by the public.

2.9.3.4.(1) A person employed for firewatch duty in accordance with Article 2.9.3.3. shall

- (a) be familiarized with all fire safety features, including the fire safety plan as provided in conformance with Section 2.8 and the condition of **exits**, and
- (b) patrol the area to ensure that the **means of egress** are kept clear and that regulations are enforced.

Communications systems

2.9.3.5. When the conditions of Article 2.9.3.3. apply, an **approved communications system** shall be provided.

SECTION 2.10 DAY-CARE CENTRES

Subsection 2.10.1. Combustible Materials

2.10.1.1. Combustible artwork and teaching materials that are attached to walls shall not exceed 20 per cent of the area of the walls.

Waste receptacles

2.10.1.2. Waste receptacles shall be made of noncombustible materials.

Flammable and combustible liquids

2.10.1.3. **Flammable** and **combustible liquids** shall be stored in an acceptable location and in areas inaccessible to children.

2.10.1.4. Where handicapped children are cared for, sufficient staff shall be present at all times during the period the children are in the centre to escort them to safety in the event of a fire emergency.

SECTION 2.11 INSULATION AND RE-INSULATION

Subsection 2.11.1. General

2.11.1.1. Insulation and re-insulation shall be carried out in accordance with the **Building Code** with respect to fire protection matters.

2.11.1.2. Unless otherwise **approved**, existing combustible insulation shall be protected as prescribed in the **Building Code**.

2.11.1.3. Insulation shall not be placed in **building** roof-ceiling or floor-ceiling assemblies as described in Part 3 of the **Building Code** where the assemblies are required to a **fire-resistance rating** unless it can be shown that the insulation does not affect the **fire-resistance rating** of the assemblies.

SECTION 2.12 COVERED MALLS

Subsection 2.12.1. General

2.12.1.1.(1) Covered malls designed for ornamental and pedestrian oriented uses only shall not be used for merchandising or public activities, except that such activities may be permitted on a temporary basis where they do not create a fire hazard.

(2) Where a covered mall described in Sentence (1) is used for merchandising or public activities, the fire safety plan described in Section 2.8 shall include additional provisions to offset any hazard that may be created by such activities.

2.12.1.2. Merchandising or public activities in a **sprinklered** covered mall described in Article 2.12.1.1. shall not be permitted where such activities will exceed the performance criteria for which the sprinkler system was designed.

2.12.1.3.(1) When a covered mall having a width of 9 m or more has been provided for the purpose of considering each portion of the **building** separated by the mall as a separate building, no merchandising or public activities or both shall be carried on within the 9 m width.

(2) Despite Sentence (1), merchandising or public activities or both may be carried on within the 9 m width where they are **approved** and they do not endanger life safety or alternative measures are taken to provide life safety.

2.12.1.4. **Access to exits** within a covered mall shall be provided and maintained in conformance with Subsection 2.7.1.

2.12.1.5. Where a covered mall is used for merchandising or public activities, the activities shall be arranged so that access to fire protection equipment, including sprinkler control valves, fire hose stations, portable extinguishers and fire alarm stations is not restricted.

2.12.1.6. Decorative materials used for merchandising or public activities in a covered mall shall conform to the **flame resistance** and flameproofing requirements in Subsection 2.3.2.

2.12.1.7. Where a covered mall is used for the display of fueled equipment, batteries shall be disconnected and caps for fuel tanks shall be locked or secured against tampering.

PART 3 PROPERTY PROTECTION FOR INDUSTRIAL AND COMMERCIAL OCCUPANCIES

TABLE OF CONTENTS

SECTION 3.1	GENERAL
Subsection 3.1.1.	Scope
SECTION 3.2	WOOD PRODUCTS
Subsection 3.2.1.	Woodworking Plants
Subsection 3.2.2.	Outdoor Storage of Lumber and Forest Products
Subsection 3.2.3.	Outdoor Storage of Wood Chips
SECTION 3.3	STORAGE
Subsection 3.3.1.	Indoor Tire Storage
Subsection 3.3.2.	Indoor General Storage
SECTION 3.4	INDUSTRIAL TRUCKS
Subsection 3.4.1.	General
Subsection 3.4.2.	Fuel Fired Industrial Trucks
Subsection 3.4.3.	Battery-Powered Industrial Trucks
SECTION 3.5	SALVAGE SHOPS AND SALVAGE YARDS INCLUDING AUTOMOBILE WRECKING YARDS
Subsection 3.5.1.	General
Subsection 3.5.2.	Piling
SECTION 3.6	CLEANING AND DYEING PLANTS
Subsection 3.6.1.	Flammable and Combustible Liquids
Subsection 3.6.2.	Ventilation
Subsection 3.6.3.	Fire Hazards
SECTION 3.7	BOWLING ALLEYS
Subsection 3.7.1.	Resurfacing
Subsection 3.7.2.	Pin Refinishing
Subsection 3.7.3.	Flammable and Combustible Liquids

SECTION 3.1 GENERAL

Subsection 3.1.1. Scope

Scope

3.1.1.1. This Part provides for property protection by requiring that certain fire protection measures be applied in the case of specific **occupancies** where the use, storage and handling of hazardous materials or the stockpiling of combustible materials create a potentially serious fire hazard.

SECTION 3.2 WOOD PRODUCTS

Subsection 3.2.1. Woodworking Plants

Lumber storage outdoors

3.2.1.1. The outdoor storage of lumber shall conform to Subsection 3.2.2.

Exhaust systems

3.2.1.2. Every machine that produces wood dust, particles or

shavings shall be provided with a blower and exhaust system installed in conformance with NFPA 91-1983, "Installation of Blower and Exhaust Systems for Dust, Stock and Vapor Removal or Conveying".

3.2.1.3. Operations that generate sparks or combustible vapours shall not be served by woodworking exhaust systems.

Sawdust disposal

3.2.1.4. Loose shavings and sawdust shall be swept up at frequent intervals and deposited in receptacles described in Articles 2.4.1.9. and 2.4.1.10.

Portable extinguishers

3.2.1.5. A portable extinguisher of 2A rating or a garden-type hose station shall be provided within 7.5 m of any machine producing wood dust, particles or shavings.

3.2.1.6. Spray finishing operations using **flammable** or **combustible liquids** in woodworking plants shall conform to Part 5.

3.2.1.7. RESERVED

Subsection 3.2.2. Outdoor Storage of Lumber and Forest Products

Deviations from requirements

3.2.2.1. This Subsection does not apply where the existing situation is **approved** and does not endanger life safety, or alternative measures to the requirements set out in this Subsection are taken to provide life safety.

Surface of ground

3.2.2.2.(1) Except as permitted in Sentence (2) and Article 3.2.2.3., storage sites for lumber and other forest products shall be level, solid ground, paved or surfaced with noncombustible material.

(2) Soft storage beds may be used for logs where embedment of stones or cinders may cause damage to cutting knives.

Surface under piling

3.2.2.3.(1) Forest products shall not be piled on refuse filled or sawdust filled land except where the site is covered with a layer of compacted earth to a minimum depth of 150 mm.

(2) Peat and humus are not acceptable materials for compacted earth cover in Sentence (1).

Clearance for yard storage areas

3.2.2.4.(1) Fire exposure to the yard areas from the mill operations and other structures shall be limited by providing clear space.

(2) The width of clear space shall be based upon the severity of exposure that will vary with the area, height, **occupancy**, construction and protection of the exposing structure and the type of piling and height of adjacent lumber piles.

(3) To provide for fire fighting operations, the clear space permanently available shall not be less than 4.5 m.

Clearance for stickered lumber piles

3.2.2.5.(1) Stickered lumber piles in lumber storage yards shall be located at least 15 m from property lines and **buildings**.

(2) Large size timbers and flat-piled stock may be stored or piled on the perimeter of the yard.

Clearance from vegetation

3.2.2.6. Storage yards shall be maintained free of combustible ground vegetation, including grass and weeds, for 4.5 m from the stored material and 30 m from brush and forested areas.

Wood waste disposal

3.2.2.7. Sawdust, chips and other waste material shall not be allowed to accumulate in piling areas in lumber yards.

Separation of treated lumber piles

3.2.2.8. Lumber and timber treated with **combustible liquids** shall be stored in piles that are separated from other stored material so that the distance between piles is at least twice the height of the treated pile, but not less than 4.5 m.

Storage beneath power lines

3.2.2.9. Stickered lumber piles, and piles of lumber and timber treated with **combustible liquids** shall not be stored beneath electrical power lines having a voltage in excess of 750 volts or that supply power to fire emergency systems.

Pile heights

3.2.2.10. Pile heights for stickered lumber piles shall not exceed 6 m.

3.2.2.11. Pile heights for randomly stacked or unranked piles shall not exceed 6 m unless special extinguishing equipment, such as portable turrets, deluge sets and monitor towers, is installed.

Fire department access

3.2.2.12.(1) Unless otherwise **approved**, each lumber yard shall be provided with at least 2 fire access routes in conformance with Sentence (2).

- (2) The fire access routes required in Sentence (1) shall
- have a clear width of at least 6 m, unless it can be shown that lesser widths are satisfactory,
 - be designed to support the expected loads imposed by fire fighting equipment and be surfaced with concrete, asphalt or other material designed to permit accessibility under all climatic conditions,
 - be connected with a public thoroughfare, and
 - be located as remotely as is possible in the circumstances from each other.

3.2.2.13.(1) Where storage areas are fenced or otherwise enclosed, gateways having a clear width of 3.5 m shall be provided to permit entry of **fire department** vehicles.

(2) Gateways shall be kept clear of obstructions so that gates may be opened fully at all times.

3.2.2.14. Groups of lumber piles shall be arranged with a maximum width of 15 m and a maximum length of 45 m, with **fire department** access routes surrounding each group of piles.

3.2.2.15. No vehicles shall be permitted to be parked overnight or equipment stacked in a **fire department** access route that is less than 7.5 m in width unless the parking is on one side only and there is at least 4.5 m of clear width for **fire department** vehicles.

3.2.2.16. RESERVED

Burning of wood waste materials

3.2.2.17. Shavings, sawdust and refuse materials shall be burned only in **boilers** or **furnaces**, or in incinerators or refuse burners conforming to Subsection 2.6.3.

3.2.2.18. Refuse burners or incinerators required in Article 3.2.2.17. shall be located at least 15 m from **buildings** or piles of logs or lumber or property lines.

3.2.2.19. Where the size and design of the burner or spark arresting screen, the prevailing winds or the location and arrangement of yard storage creates a fire hazard by conforming to Article 3.2.2.18.,

an **approved** increase in clear space referred to in Article 3.2.2.18. shall be provided to alleviate the fire hazard.

3.2.2.20. A refuse bin conforming to Articles 2.4.1.9. and 2.4.1.10. shall be provided at each **boiler**, **furnace**, incinerator and refuse burner referred to in Article 3.2.2.17.

3.2.2.21. Salamanders, braziers or other open flames shall not be used in storage yards.

Smoking prohibited

3.2.2.22. Smoking shall be prohibited in lumber yards, except as permitted in Subsection 2.4.3.

3.2.2.23. The telephone number of the **fire department** and location of the nearest telephones shall be posted conspicuously in working locations in the open yard and in each **building**.

Fire extinguishing provisions

3.2.2.24.(1) Outdoor lumber storage shall have fire protection provisions consisting of

- 200 L vessels with lids, having an opening of 457 mm least dimensions, located so that no person will have to travel more than 25 m from any part of the storage yard to reach a vessel, and
- three 12 L standard fire pails at each vessel.

(2) The water stored in the vessels and pump tanks shall be protected from freezing.

(3) The vessels, pails and pump tanks shall be painted red with the word "FIRE" in black painted thereon.

(4) Portable extinguishers having a 2A or higher rating conforming to the requirements of Part 6 may be provided in lieu of the requirements of Sentence (1).

3.2.2.25. Portable extinguishers shall be provided in conformance with Part 6 in each **building** located in a lumber yard.

Hydrant systems and water supply

3.2.2.26. The water supply available shall be adequate for hose streams and monitor towers, based on the provision of fire protection acceptable to the **Chief Fire Official**.

3.2.2.27. Where fire protection cannot be provided by municipal or private street hydrants or mobile pumping equipment to confine and control a fire within a lumber yard, the hydrant system shall be extended into the yard area so that all parts of lumber yards can be reached by using not more than 60 m of hose.

*Subsection 3.2.3. Outdoor Storage of Wood Chips**Deviations from requirements*

3.2.3.1. This Subsection does not apply where the existing situation is **approved** and does not endanger life safety, or alternative measures to the requirements set out in this Subsection are taken to provide life safety.

Surface of ground

3.2.3.2. The storage site shall be well drained and be level, solid ground or paved with asphalt, concrete or other hard surface material.

3.2.3.3. The ground surface between piles shall be kept free of combustible materials.

Vegetation removal

3.2.3.4.(1) Weeds, grass and similar vegetation shall be removed from the yard.

Burning of weeds

(2) Portable open-flame weed burners shall not be used in chip storage yards.

Pile dimensions

3.2.3.5. Piles shall not exceed 18 m in height, 90 m in width and 150 m in length unless temporary water pipes with hose connections are laid on the top surface of the pile.

Fire department access

3.2.3.6.(1) Space shall be maintained between chip piles and exposing structures, yard equipment or stock equal to

- (a) twice the pile height for combustible stock or **buildings**, or
- (b) the pile height for noncombustible **buildings** and equipment.

(2) Despite Sentence (1), space between chip piles and exposing structures, yard equipment or stock shall not be less than 9 m.

3.2.3.7. Where storage areas are fenced or otherwise enclosed, gates 3.5 m in width shall be provided to permit entry of **fire department** vehicles.

3.2.3.8. Access walkways 1.8 m wide shall be provided to the top of piles so that hose streams may be directed on any part of the piles.

3.2.3.9. Piles exceeding 150 m in length shall be provided with 2 access walkways on opposite sides of the pile and shall be surrounded by **fire department** access routes 9 m wide.

Smoking prohibited

3.2.3.10. Smoking shall be prohibited in chip pile areas.

Fire extinguishing provisions

3.2.3.11. Portable extinguishers for **Class A fires** shall be provided on vehicles operating on chip piles in addition to the units for **Class B fires** normally required for the vehicles.

3.2.3.12.(1) Hose houses or cabinets shall be provided around the perimeter of chip piles at intervals not exceeding 120 m.

(2) One 75 m length of 65 mm hose and 2 portable extinguishers having a 2A or higher rating and conforming to Part 6 shall be installed in each hose house or cabinet.

(3) Each hose required in Sentence (2) shall be connected to a water supply capable of supplying 1140 L/min of water to it at a pressure that will allow the hose stream to reach the top of the chip pile.

3.2.3.13. Portable extinguishers in conformance with Part 6 shall be provided in transfer houses.

SECTION 3.3 STORAGE**Subsection 3.3.1. Indoor Tire Storage***Application*

3.3.1.1. This Subsection applies to **buildings** used for the storage of tires in which the bulk volume of tires stored in one **fire compartment** exceeds 425 m³.

Tire pile dimensions

3.3.1.2. A single pile of tires in a tire storage location shall occupy an area not greater than 500 m² with a maximum length of 30 m.

3.3.1.3.(1) The maximum piling height of tires shall not exceed the height used for the design of the fixed extinguishing system installed as required in Article 3.3.1.8.

(2) The maximum piling height allowed in Sentence (1) shall be posted in conspicuous locations.

Pile clearance

3.3.1.4. A clearance of at least 914 mm shall be maintained between the tops of piles and sprinkler head deflectors.

3.3.1.5. Aisles between individual piles shall be 1.8 m wide.

3.3.1.6. A clearance of 600 mm shall be maintained between piles of tires and columns and enclosing walls.

3.3.1.7. A tire storage location shall be classified as a Group 'F' Division 2 **occupancy**.

Warehouse fire extinguishing systems

3.3.1.8.(1) Where the **floor area** of a tire storage location exceeds 250 m², the **floor area** shall be provided with an **approved** automatic fire extinguishing system installed in conformance with NFPA 231D-1980, "Storage of Rubber Tires".

(2) The design of the automatic fire extinguishing system required in Sentence (1) shall be based on the maximum piling height available.

3.3.1.9. A standpipe and hose system shall be installed in conformance with NFPA 231D-1980, "Storage of Rubber Tires".

Portable extinguishers

3.3.1.10. Portable extinguishers conforming to Part 6 shall be provided in tire storage locations so that there is one extinguisher with a 2A:10BC or higher rating for every 250 m² of **floor area**.

Subsection 3.3.2. Indoor General Storage*Application*

3.3.2.1. This Subsection applies to the indoor general storage of combustible or noncombustible solids with combustible packaging or storage aids to a height of 6.4 m, except that this Subsection does not apply to the bulk storage of unpackaged grain, coal or similar commodities, or special hazard commodities covered elsewhere in this Code.

Storage pile dimensions

3.3.2.2.(1) The area of individual storage piles shall not exceed 500 m² in **buildings** that are not **sprinklered**.

(2) The area of individual storage piles shall not exceed 1000 m² in **sprinklered buildings**.

(3) Heights of storage piles in **buildings** that are not **sprinklered** shall not exceed 4.5 m.

Pile clearance

3.3.2.3.(1) The clearance between sprinkler head deflectors and the tops of piles shall not be less than 457 mm.

(2) Where the storage piles are above the lower chords of floor or roof structural framing members, a horizontal clear space of 300 mm shall be maintained between the storage and the structural members.

Fire access aisles

3.3.2.4. At least one main aisle having a width equal to ½ the height of the highest adjacent pile and extending the length of the structure shall be provided but in no case less than 2.4 m.

3.3.2.5. Aisles separating piles described in Article 3.3.2.2. shall be 2.4 m wide.

3.3.2.6. Access aisles 1.2 m wide shall be provided to the sides of the **building**, to **exits**, to **fire department** access panels and to fire protection equipment, including sprinkler control valves, fire hose stations, portable extinguishers and fire alarm stations.

Pile clearance at walls

3.3.2.7. Wall clearances of 600 mm shall be maintained where

stored commodities may swell or expand with the absorption of water.

Palletized storage arrangements

3.3.2.8. Palletized storage shall be arranged so that unobstructed horizontal channels formed by the top and bottom of pallets shall not exceed 15 m.

3.3.2.9. Except as permitted in Article 3.3.2.10., pallets and dunnage not in use shall be stored outdoors and be located so as to avoid an exposure hazard.

Pallet storage

3.3.2.10.(1) Indoor storage of combustible pallets and dunnage may be permitted in **buildings** that are not **sprinklered** provided the area of storage does not exceed 100 m², the pile size does not exceed 1.2 m in height and 7.5 m in width, and the separating aisles are 2.4 m wide.

(2) Combustible pallets shall not be stored indoors to a height greater than 1.2 m except in areas **sprinklered** in conformance with Sentence (3).

(3) **Buildings** or compartments used for the storage of pallets shall be classified as Group 'F' Division 2 and shall be **sprinklered** in conformance with NFPA 231-1979, "Standard for Indoor General Storage".

SECTION 3.4 INDUSTRIAL TRUCKS

Subsection 3.4.1. General

3.4.1.1. Industrial trucks, including fork lifts, tractors and motorized hand trucks shall be permitted only in those areas for which they are **approved**.

Subsection 3.4.2. Fuel-Fired Industrial Trucks

Truck storage

3.4.2.1. Fuel-fired industrial trucks shall be stored in detached **buildings**, or in areas separated from the remainder of the storage **building** by a **fire separation** having a 1-hr **fire-resistance rating**, or in areas where the vehicles do not create a hazard to the storage area.

Fueling of trucks

3.4.2.2. Except as provided in Article 3.4.2.3., industrial trucks shall be refueled only at designated locations outside **buildings**.

3.4.2.3. Industrial trucks that are fueled by replaceable propane containers may have the containers exchanged indoors at a safe location at least 7.5 m from ignition sources, open pits and underground entrances.

3.4.2.4.(1) Where replaceable propane containers are exchanged, valves at the containers shall be closed.

(2) Where an **approved** automatic quick-closing coupling that closes in both directions when uncoupled is not provided, the engine shall be allowed to operate until the fuel in the system is consumed.

3.4.2.5. Propane cylinders shall be stored in conformance with Regulation 333 of Revised Regulations of Ontario, 1990 (**Propane Storage, Handling and Utilization Code**).

Portable extinguishers

3.4.2.6. Each fuel-fired industrial truck shall be equipped with a 5BC or higher rated portable extinguisher conforming to the requirements of Part 6.

Subsection 3.4.3. Battery-Powered Industrial Trucks

Battery charging installations

3.4.3.1.(1) Charging installations for battery-powered industrial trucks shall be located at least 1.5 m from combustible materials.

(2) Battery charging installations serving more than 2 trucks shall be located in well ventilated areas.

3.4.3.2. Battery charging equipment shall not be located in **occupancies** where **combustible dusts, fibres**, vapours or gases are present in hazardous quantities.

3.4.3.3. Facilities shall be provided at battery charging installations for flushing and neutralizing spilled electrolyte and for protecting charging apparatus from mechanical damage.

Portable extinguishers

3.4.3.4. Charging installations for battery-powered industrial trucks shall be equipped with a 10BC or higher rated portable extinguisher conforming to the requirements of Part 6.

Personnel restrictions

3.4.3.5. Only trained and authorized personnel shall be permitted to change or charge batteries.

Fire precautions

3.4.3.6. Precautions shall be taken to prevent open flames, sparks or electric arcs in battery charging areas.

SECTION 3.5 SALVAGE SHOPS AND SALVAGE YARDS INCLUDING AUTOMOBILE WRECKING YARDS

Subsection 3.5.1. General

Roof storage prohibited

3.5.1.1. The roof of a **building** located in a salvage yard shall not be used for storage purposes.

Fires prohibited

3.5.1.2. Fires shall not be permitted in a salvage yard except when used for heating purposes or for operating machinery or welding or cutting equipment.

3.5.1.3. Gas tanks on vehicles to be salvaged shall be drained and ventilated prior to salvage operations.

Fire access gates

3.5.1.4. Where storage areas are fenced or otherwise enclosed, gates having a clear width of 3.5 m shall be provided to permit the entry of **fire department** vehicles.

Fire extinguishing provisions

3.5.1.5. Except where all salvage and scrap material is noncombustible and free of combustibles, water barrels of 200 L capacity with three 12 L pails or portable extinguishers having a 2A or higher rating conforming to the requirements of Part 6 shall be provided, so that the maximum travel distance from any part of the yard to a barrel or extinguisher is 25 m.

3.5.1.6. Portable extinguishers in conformance with Part 6 shall be provided in each **building** located in a salvage yard.

Hydrant systems and water supply

3.5.1.7. Except as required in Article 3.5.1.8., where a municipal hydrant system exists and is adjacent to the yard, the hydrant system shall be extended into the yard area so that all parts of the salvage yard can be reached by using not more than 60 m of hose.

3.5.1.8. Article 3.5.1.7. does not apply where the fire protection that is provided by the municipal street hydrants and mobile pumping equipment is **approved** as being adequate in the circumstances.

Smoking prohibited

3.5.1.9. Smoking shall be prohibited in salvage yards, except as permitted in Subsection 2.4.3.

3.5.1.10. The telephone number of the **fire department** and loca-

tion of the nearest telephones shall be posted conspicuously in working locations in the open yard and in each **building**.

Subsection 3.5.2. Piling

Pile clearance and dimensions

3.5.2.1. Piles that include combustible salvage shall be 3 m from property lines, and not more than 3 m in height and 100 m² in area.

3.5.2.2. Piles of salvage material shall be separated by a clear space of 3 m that is kept clear of grass and weeds.

Piles of tanks or drums

3.5.2.3. Tanks or drums shall be stored in piles separate from piles of other materials.

Combustible metals

3.5.2.4.(1) Piles or containers with metal shavings, turnings and dusts shall be stored in an area separate from other salvage materials and identified with warning signs.

(2) Warning signs required in Sentence (1) shall

- (a) be visible from all directions of approach, and
- (b) have the name of the metal and the words "COMBUSTIBLE METAL — DO NOT USE WATER" displayed in plain legible letters as described in Sentence (3).

(3) Lettering on warning signs shall be red or white letters on a contrasting background 114 mm high with 19 mm stroke.

Subsection 3.5.3. Outdoor Tire Storage Yards

Application

3.5.3.1.(1) Despite Subsection 3.5.2., this Subsection applies with respect to the outdoor storage of tires or shredded tires where the bulk volume of stored product exceeds 300 m³.

(2) This Subsection does not apply where the stored tires or shredded tires are covered by a minimum depth of 150 mm of non-combustible material.

Prohibitions

3.5.3.2.(1) Open air burning is prohibited in storage yards.

(2) Cutting, welding or heating devices shall not be operated in storage yards.

(3) Smoking is prohibited in storage yards except as provided in Subsection 2.4.3.

(4) Storage piles shall not be located beneath electrical power lines with a voltage in excess of 750 volts or that supply power to fire emergency systems.

Fire safety planning

3.5.3.3.(1) A Fire Safety Plan as described in Article 2.8.2.1. shall be prepared, **approved** and implemented for the storage yard.

(2) The Fire Safety Plan shall include provisions respecting access for water tanker shuttle operations within the fire department access routes, if water tanker shuttle operations are required in the circumstances of the storage yard.

(3) At least one copy of the fire emergency procedures shall be prominently posted and maintained at the storage yard.

(4) The telephone number of the **fire department** and location of the nearest telephone shall be posted conspicuously in attended locations.

Pile dimensions separations

3.5.3.4.(1) Individual storage piles shall not be more than 3 m in height and 100 m² in area.

(2) Storage piles shall be separated by a clear space of at least 6 m from piles of other stored product.

Pile clearance

3.5.3.5.(1) Storage piles shall be located at least 15 m from property lines.

(2) Storage piles shall be located at least 15 m from **buildings**.

(3) Despite Sentence (2), the separation of storage piles from **buildings** may be determined as required by NFPA 231D Appendix C-1989, "Guidelines for Outdoor Storage of Scrap Tires" and NFPA-80A-1987, "Protection of Buildings from Exterior Fire Exposures".

(4) Individual storage piles shall be separated from other piles of salvage by a clear space of at least 6 m.

Clearances from vegetation

3.5.3.6.(1) Storage yards shall be maintained free of combustible ground vegetation,

- (a) over a distance of 4.5 m from the stored product to grass and weeds, and
- (b) over a distance of 30 m from the stored product to brush and forested areas.

Fire breaks

3.5.3.7.(1) Where the bulk volume of stored product is more than 4800 m³, fire breaks shall be provided around the perimeter of each group of storage piles in accordance with Sentences (2) and (3).

(2) Individual storage piles shall be arranged so that there are not more than 16 individual storage piles per group.

(3) Fire breaks shall be at least 22 m wide.

Alternative measures

3.5.3.8. Despite Articles 3.5.3.4., 3.5.3.5., 3.5.3.6. and 3.5.3.7., other pile arrangements that will prevent the spread of fire and that are **approved** may be used.

Fire department access

3.5.3.9.(1) Each tire storage yard shall be provided with fire access routes.

(2) The fire access routes shall,

- (a) have a clear width of at least 6 m,
- (b) be designed to support the loads imposed by fire fighting equipment,
- (c) be surfaced with material designed to permit accessibility under all climatic conditions,
- (d) be connected with a public thoroughfare in at least two places that are located as remotely as is possible in the circumstances from each other,
- (e) be located within all pile clearances identified in Sentence 3.5.3.5.(1), (2) or (3) and within all fire breaks required in Article 3.5.3.7.,
- (f) be within 50 m of any point in the storage yard where storage piles are located,
- (g) be at least 6 m from any storage pile, and

(h) be maintained accessible and unobstructed at all times.

(3) Despite Sentences (1) and (2),

- (a) alternate fire access routes may be provided if the routes permit fire fighting vehicles and equipment access and permit the use of fire suppression techniques appropriate in the circumstances, and
- (b) if the routes are **approved**.

Fencing

3.5.3.10.(1) Where the bulk volume of stored product is more than 600 m³, the storage yard shall be surrounded by a firmly anchored fence or other **approved** method of security that controls unauthorized access to the storage yard.

(2) The fence shall be,

- (a) constructed to discourage entry,
- (b) constructed at least 1.8 m high, and
- (c) provided with gates at least 3.5 m wide.

(3) All gates to the storage yard shall be locked when the storage yard is not staffed.

(4) Gateways shall be kept clear of obstructions so that gates may be opened fully at all times.

Water supply

3.5.3.11.(1) A public or private water supply shall be provided such that any part of the storage yard can be reached by using not more than 150 m of hose.

(2) When the quantity of stored product is between 300 m³ and 1200 m³, the water supply system shall be capable of supplying 1860 L/min. for 3 hours.

(3) Where the quantity of stored product is 1200 m³ or more, the water supply system shall be capable of supplying 3780 L/min. for 3 hours.

(4) Where on-site reservoirs or other established water supplies are used as a fire department draft source to meet the requirements of Sentences (1), (2) and (3), they shall be equipped with dry hydrants in accordance with NFPA 1231 Appendix B-1984 "Standard on Water Supplies for Suburban and Rural Fire Fighting".

Alternative measures

3.5.3.12. Despite Article 3.5.3.11., other water supply systems or other measures may be used if the systems or measures will provide sufficient fire suppression capability in the circumstances and if the systems or measures are **approved**.

Fire extinguishers

3.5.3.13. Fuel-fired vehicles operating in the storage yard shall be equipped with a 2A10BC or higher rated portable extinguisher conforming to the requirements of Part 6.

SECTION 3.6 CLEANING AND DYEING PLANTS

Subsection 3.6.1. Flammable and Combustible Liquids

Flammable liquids prohibited

3.6.1.1. **Flammable liquids** shall not be used for any purpose in dry cleaning and dry dyeing plants.

Use of combustible liquids

3.6.1.2. **Combustible liquid** solvents used in dry cleaning and dry dyeing plants shall be of an **approved** type.

3.6.1.3. **Combustible liquids** shall be stored and handled in conformance with Part 4.

3.6.1.4. Where **combustible liquids** are used as cleaning solvents, foreign materials shall be removed from the pockets and exterior of clothing in the receiving room.

3.6.1.5. **Combustible liquids** shall not be located where the public has access and may use dry cleaning equipment.

3.6.1.6. **Combustible liquids** used as a local application to remove spots and stains shall not exceed 4.6 L and shall be dispensed from **listed** and labelled plunger-type safety cans.

Subsection 3.6.2. Ventilation

Maximum solvent concentrations in atmosphere

3.6.2.1. Where **combustible liquids** are used in a dry cleaning or dry dyeing process, ventilating equipment shall be provided to maintain an average solvent concentration of not more than 100 ppm within 3 m horizontally of a cleaning or dyeing unit and not more than 40 ppm elsewhere in the plant.

Automatic shutdown of systems

3.6.2.2. Ventilation systems shall shut down automatically when manual fire alarm boxes or automatic fire detectors are operated.

Manual shutdown of systems

3.6.2.3.(1) Where fire alarm systems are not installed, signs shall be posted to instruct employees to shut down the ventilation system in the event of fire.

(2) Emergency switches for this purpose shall be provided and placed in a conspicuous location in exit ways.

Exhaust outlet location

3.6.2.4. Exhaust ventilation outlets shall be located at least 7.5 m from any opening in a **building**.

Subsection 3.6.3. Fire Hazards

Clearances of equipment from appliances

3.6.3.1. **Appliances** with open flames or with exposed electrical heating elements shall not be placed within 6 m of dry cleaning or dry dyeing equipment in which **combustible liquids** are used unless such **appliances** are located in a separate enclosed room or cabinet which is independently ventilated.

Ducts for combustion air

3.6.3.2. Combustion air for gas or oil-fired equipment shall be conveyed through ducts from a source outside the **building** when such equipment is located in a dry cleaning or dry dyeing room.

Lint and refuse disposal

3.6.3.3.(1) Lint and refuse shall be removed from traps in dry cleaning and dry dyeing systems after each day's work.

(2) The lint and refuse shall be disposed of in a receptacle conforming to Articles 2.4.1.9. and 2.4.1.10. or be removed from the premises.

SECTION 3.7 BOWLING ALLEYS

Subsection 3.7.1. Resurfacing

Notification

3.7.1.1. The **Chief Fire Official** shall be notified when bowling alleys are to be resurfaced.

Closure to public

3.7.1.2. Bowling alleys shall not be open to the public during the resurfacing of alleys.

3.7.1.3.(1) During the application of the floor finishes and for one hour after such application, Sentences (2) to (4) apply.

(2) Mechanical exhaust systems, electric motors and other equipment, including lights, that might be a source of ignition shall be shut down.

(3) Smoking shall not be permitted and open flames shall not be used.

(4) Waste materials shall be disposed of in conformance with Article 3.7.3.2. in bowling alleys.

3.7.1.4. Maximum natural ventilation shall be maintained during the resurfacing operations.

Subsection 3.7.2. Pin Refinishing

3.7.2.1.(1) Pin refinishing shall be carried out in a **building** provided for this purpose, or in a room at or above **grade** separated by walls, floor and ceiling assemblies having a 1-hr **fire-resistance** rating.

(2) Smoking shall not be permitted in a pin refinishing room.

(3) Signs in conformance with Article 2.4.3.2. shall be posted in pin refinishing rooms.

Subsection 3.7.3. Flammable and Combustible Liquids

Storage

3.7.3.1. RESERVED

Waste receptacles

3.7.3.2.(1) During the resurfacing or refinishing process, a receptacle conforming to Articles 2.4.1.9. and 2.4.1.10. shall be provided for waste rags and materials used in operations involving flammable finishes or solvents.

(2) The contents of the receptacles in Sentence (1) shall be removed daily and disposed of in a manner that is **approved**.

O. Reg. 67/87, Part 3; O. Reg. 281/90, s. 1.

PART 4 FLAMMABLE AND COMBUSTIBLE LIQUIDS

RESERVED

PART 5 HAZARDOUS MATERIALS, PROCESSES AND OPERATIONS

TABLE OF CONTENTS

SECTION 5.1	GENERAL
Subsection 5.1.1.	Application
Subsection 5.1.2.	Means of Egress
Subsection 5.1.3.	Electrical Installations
Subsection 5.1.4.	Ventilation
SECTION 5.2	EXPLOSIVES AND FIREWORKS
Subsection 5.2.1.	Explosives
Subsection 5.2.2.	Fireworks
SECTION 5.3	MATCHES
Subsection 5.3.1.	Storage
SECTION 5.4	CELLULOSE NITRATE PLASTICS
Subsection 5.4.1.	Displays
Subsection 5.4.2.	Manufacture
Subsection 5.4.3.	Storage of Finished Products
Subsection 5.4.4.	Cellulose Nitrate Motion Picture Film
Subsection 5.4.5.	Fire Protection

SECTION 5.5	AMMONIUM NITRATE
Subsection 5.5.1.	Application
Subsection 5.5.2.	Exposure
Subsection 5.5.3.	Storage Buildings
Subsection 5.5.4.	Storage
Subsection 5.5.5.	Fire Hazards
Subsection 5.5.6.	Fire Protection

SECTION 5.6	COMPRESSED GAS CYLINDERS
Subsection 5.6.1.	General
Subsection 5.6.2.	Storage

SECTION 5.7	REACTIVE SUBSTANCES RESERVED
--------------------	---

SECTION 5.8	CORROSIVE LIQUIDS RESERVED
--------------------	---------------------------------------

SECTION 5.9	OXIDIZING MATERIALS RESERVED
--------------------	---

SECTION 5.10	COMBUSTIBLE DUST PRODUCING PROCESSES
Subsection 5.10.1.	Dust Collection

SECTION 5.11	COMBUSTIBLE FIBRES
Subsection 5.11.1.	Storage
Subsection 5.11.2.	Fire Protection

SECTION 5.12	SPRAY APPLICATIONS USING FLAMMA- BLE AND COMBUSTIBLE MATERIALS
Subsection 5.12.1.	Location
Subsection 5.12.2.	Construction
Subsection 5.12.3.	Ventilation
Subsection 5.12.4.	Exhaust Ducts
Subsection 5.12.5.	Electrical Equipment
Subsection 5.12.6.	Flammable and Combustible Liquids
Subsection 5.12.7.	Control of Fire Hazards
Subsection 5.12.8.	Fire Protection Equipment
Subsection 5.12.9.	Drying Operations

SECTION 5.13	DIP TANKS
Subsection 5.13.1.	Location
Subsection 5.13.2.	Construction
Subsection 5.13.3.	Overflow and Drain Pipes
Subsection 5.13.4.	Salvage Tanks
Subsection 5.13.5.	Control of Fire Hazards
Subsection 5.13.6.	Fire Protection

SECTION 5.14	SPECIAL PROCESSES INVOLVING FLAM- MABLE AND COMBUSTIBLE LIQUIDS
Subsection 5.14.1.	Quench Tanks
Subsection 5.14.2.	Flow-Coating Operations
Subsection 5.14.3.	Roll-Coating Processes
Subsection 5.14.4.	Electrostatic Spraying and Detearing Equipment
Subsection 5.14.5.	Automobile Undercoating
Subsection 5.14.6.	Dry Powder Finishing
Subsection 5.14.7.	Organic Peroxides and Dual Component Coatings

SECTION 5.15	RADIOACTIVE MATERIALS
Subsection 5.15.1.	Application
Subsection 5.15.2.	Storage
Subsection 5.15.3.	Emergency Procedures

SECTION 5.16	FUMIGATION AND THERMAL INSECTI- CIDAL FOGGING
Subsection 5.16.1.	Application
Subsection 5.16.2.	Safety Precautions

SECTION 5.17	WELDING AND CUTTING
Subsection 5.17.1.	General
Subsection 5.17.2.	Use and Maintenance of Equipment
Subsection 5.17.3.	Prevention of Fires

SECTION 5.18 INDUSTRIAL OVENS FOR BAKING AND DRYING PROCESSES

Subsection 5.18.1.	Application
Subsection 5.18.2.	Location
Subsection 5.18.3.	Construction
Subsection 5.18.4.	Ventilation
Subsection 5.18.5.	Maintenance
Subsection 5.18.6.	Fire Protection

SECTION 5.1 GENERAL

Subsection 5.1.1. Application

Application

5.1.1.1. This Part applies to materials, processes and operations that involve a risk from explosion or high flammability, or otherwise create a hazard to life safety or health.

Subsection 5.1.2. Means of Egress

5.1.2.1. Hazardous materials, processes and operations shall be located and the premises maintained so that the **means of egress** will not be obstructed in any manner that would interfere with evacuation of the **floor area** in the event of a fire.

Subsection 5.1.3. Electrical Installations

Electrical installations

5.1.3.1. Electrical installations shall conform to the **Electrical Safety Code** made under the **Power Corporation Act**.

Subsection 5.1.4. Ventilation

5.1.4.1. Ventilation shall be provided for **hazardous locations** and processes in conformance with the **Building Code** and the requirements of this Part.

SECTION 5.2 EXPLOSIVES AND FIREWORKS

Subsection 5.2.1. Explosives

Storage, handling and use

5.2.1.1. The storage, handling and use of explosives, blasting agents, detonators, propellant explosives, pyrotechnics and ammunition shall be in conformance with the **Explosives Act (Canada)** and the **Explosives Regulations** made thereunder.

Fire emergency procedures

5.2.1.2.(1) Any person using, storing or handling explosives shall establish fire emergency procedures in conformance with Section 2.8 and that shall specify

- the location and identification of storage and use areas,
- methods to control a fire emergency safely and efficiently, and
- the names, addresses and telephone numbers of persons to be contacted in case of fire during nonoperating hours.

Subsection 5.2.2. Fireworks

Manufacture, storage, transportation and sale

5.2.2.1. The manufacture, storage, transportation and sale of fireworks shall be in conformance with the **Explosives Act (Canada)** and the **Explosives Regulations** made thereunder.

Handling and discharge

5.2.2.2. The handling and discharge of fireworks shall conform to the Fireworks Manual, as published by the Explosives Division, Department of Energy, Mines and Resources of the Government of Canada.

SECTION 5.3 MATCHES

Subsection 5.3.1. Storage

Labelling and packing

5.3.1.1. Matches shall be labelled and packed by the manufacturer in conformance with Sections 73.176 and 73.176a of the **Regulations for the Transportation of Dangerous Commodities by Rail**, as prepared by the Canadian Transport Commission.

Storage compartment

5.3.1.2. Where the aggregate volume of piles of stored matches exceeds 3 m³, storage compartments shall be constructed in conformance with the requirements of the **Building Code** for Group 'F' Division 1 occupancies.

Carton pile arrangements

5.3.1.3. In storage areas regulated by Article 5.3.1.2., shipping cartons containing matches shall be arranged in piles not exceeding 3 m in height or 40 m³ in volume, and separated by aisles 2.4 m wide.

Mixed storage

5.3.1.4. In mixed storage areas, matches shall be stored in a specific area separated from the remainder of the storage by a clear space of 2.4 m.

Storage restrictions

5.3.1.5. Matches shall not be stored within 3 m of any elevator shaft opening, stairway or other vertical opening.

SECTION 5.4 CELLULOSE NITRATE PLASTICS

Subsection 5.4.1. Displays

Advertising displays

5.4.1.1. Displays of cellulose nitrate plastic articles in stores that are not in showcases or show windows shall be displayed only when placed on tables or counters not more than 1 m wide and 3 m long, and the spaces underneath the tables or counters shall be kept free of combustible materials.

Lighting fixtures

5.4.1.2. Lighting fixtures shall not be located adjacent to any cellulose nitrate plastic material so as to create a possible ignition hazard.

Subsection 5.4.2. Manufacture

Storage of raw materials

5.4.2.1. Raw materials used in the manufacture of cellulose nitrate plastics shall be stored only in areas reserved for that purpose.

5.4.2.2. Not more than 450 kg of raw material used for the manufacture of finished cellulose nitrate plastic goods shall be stored in cabinets in any one workroom, not more than 225 kg stored in any one cabinet and not more than 112 kg in any one compartment of the cabinet.

5.4.2.3. Raw material in excess of that permitted in Article 5.4.2.2. shall be kept in vented vaults not exceeding 40 m³ capacity and protected with an automatic sprinkler system installed in conformance with NFPA 13-1983, "Standard for the Installation of Sprinkler Systems".

5.4.2.4. In factories manufacturing articles of cellulose nitrate plastics, **sprinklered** and vented cabinets, vaults or storage rooms shall be provided to prevent the accumulation of excessive quantities of such material in workrooms.

Stationing of operators

5.4.2.5. In the workrooms of factories where cellulose nitrate

plastics are being processed, operators shall be stationed not closer than 1 m apart.

Storage in work areas

5.4.2.6. Material for the manufacture of cellulose nitrate plastic articles that is not kept in containers may be placed on tables, workbenches or at machines provided the quantity does not exceed a ½ day's supply.

5.4.2.7. The total amount of cellulose nitrate plastic materials, including the material in containers and on tables, in any one workroom shall not exceed 70 kg.

Waste material storage

5.4.2.8. Waste cellulose nitrate plastic materials such as shavings, chips, turnings, sawdust edgings and trimmings shall be kept under water in metal receptacles until removed from the premises.

Subsection 5.4.3. Storage of Finished Products

Ventilation

5.4.3.1. Areas where cellulose nitrate plastic finished products are stored shall be ventilated so that any decomposition gases produced by the plastics will be vented outdoors to an area where they will not reenter the **building**.

Heating appliance restrictions

5.4.3.2.(1) Cellulose nitrate plastics shall not be stored

- (a) in rooms containing fuel burning **appliances** or electrical heating elements, or
- (b) within 600 mm of any steam pipe, radiator or **chimney**.

Storage vaults

5.4.3.3.(1) Where cellulose nitrate plastics in excess of 11 kg are stored in any **fire compartment** in a **building**, a vented cabinet or vault constructed in conformance with NFPA 40E-1980, "Code for the Storage of Pyroxylin Plastic", and Articles 5.4.3.4. and 5.4.3.5. shall be provided for its storage.

(2) Not more than 9000 kg of cellulose nitrate plastics shall be stored in any vault.

5.4.3.4.(1) Where quantities do not exceed 3400 kg, cellulose nitrate plastics shall be stored in a vault that

- (a) has a **fire-resistance rating** of 1½ hr,
- (b) is designed to resist an internal pressure of 3.5 kPa,
- (c) is not greater than 40 m³ in volume,
- (d) has explosion venting of 0.1 m² of venting area to the exterior for every cubic metre of vault volume, and
- (e) is ventilated to the exterior to provide 200 cm² of ventilating area for each cubic metre of vault volume.

5.4.3.5.(1) Where quantities exceed 3400 kg but do not exceed 9000 kg, cellulose nitrate plastics shall be stored in a vault that

- (a) has a 4-hr **fire-resistance rating**,
- (b) is designed to resist an internal pressure of 28 kPa,
- (c) has explosion venting of 650 cm² of venting area to the exterior for every cubic metre of vault volume, and
- (d) is ventilated to the exterior to provide 200 cm² of ventilating area for each cubic metre of vault volume.

Subsection 5.4.4. Cellulose Nitrate Motion Picture film

Restricted use

5.4.4.1. Cellulose nitrate motion picture film shall not be used, stored or handled in a place of public assembly.

Storage and handling

5.4.4.2. Cellulose nitrate motion picture film shall be stored and handled in conformance with NFPA 40-1974, "Storage and Handling of Cellulose Nitrate Motion Picture Film".

5.4.4.3. When not in use, cellulose nitrate motion picture film shall be kept in closed, single-roll containers.

Subsection 5.4.5. Fire Protection

Sprinkler systems

5.4.5.1. The manufacture and storage of articles of cellulose nitrate plastic in quantities exceeding 45 kg shall be only in **buildings** equipped with a system of automatic sprinklers installed in conformance with NFPA 13-1983, "Standard for the Installation of Sprinkler Systems".

SECTION 5.5 AMMONIUM NITRATE

Subsection 5.5.1. Application

Application

5.5.1.1. This Section applies to the storage of ammonium nitrate in quantities exceeding 900 kg in the form of crystals, flakes, grains or prills, including fertilizer grade or other mixtures containing 60 per cent or more ammonium nitrate by weight, but does not apply to blasting agents or fertilizer storage on railways regulated by the Canadian Transport Commission or on privately operated farms.

Subsection 5.5.2. Exposure

Clearances from storage facilities

5.5.2.1.(1) Except as provided in Sentences (2) and (3), the distance between an ammonium nitrate storage facility and the property line of another property shall be not less than 90 m, except that the distance may be reduced to

- (a) 30 m where the other property contains a **building** classified as a Group 'F' **occupancy**, **flammable liquid storage tanks**, **flammable gas storage tanks** or other tanks containing a hazardous substance, or
- (b) 15 m where the other property contains a warehouse for **flammable liquids** storage or a facility for loading or unloading **flammable liquids**.

(2) Storage facilities for up to 200 t of ammonium nitrate shall be located not closer than 15 m from a property containing a **building** classified as a Group 'F' Division 2 or 3 **occupancy**, except that this distance may be reduced to 7.5 m when a 2-hr **firewall** is provided between the storage facility and the **building** it exposes.

(3) Storage facilities for more than 200 t of ammonium nitrate shall be located not closer than 15 m from a property containing a **building** classified as a Group 'F' Division 2 or 3 **occupancy** when a 2-hr **firewall** is installed between the storage facility and the **building** it exposes.

(4) The use of existing **buildings** or structures that do not conform with the provisions of Subsection 5.5.2. may be **approved** where existing **buildings** or structures do not constitute a hazard to life or property from fire or explosion.

Subsection 5.5.3. Storage Buildings

Restrictions on buildings

5.5.3.1.(1) Ammonium nitrate shall not be stored in **buildings** which are more than 1 **storey** in **building height**.

(2) The walls of the exposed side of a storage **building** within 15 m of a combustible building, forest, pile of combustible materials and similar combustible materials shall be noncombustible, except that other forms of exposure protection may be used where acceptable to the **Chief Fire Official**.

5.5.3.2.(1) Ammonium nitrate shall not be stored in **buildings** having **cellars, basements, open floor drains, tunnels** or other pockets that might trap molten ammonium nitrate in the event of fire.

(2) Elevator pits and similar pits may be installed in the floor of a storage facility where vented to the exterior.

Ventilation

5.5.3.3. Ammonium nitrate shall not be stored in **buildings** having less than 70 cm² of openable vent area for each square metre of storage area unless mechanical ventilation is provided by equipment protected from the storage room by a **fire separation** having a 1-hr **fire-resistance rating**.

Subsection 5.5.4. Storage

Pile dimensions

5.5.4.1. The height and width of piles of bagged ammonium nitrate in warehouses shall not exceed 6 m.

Pile locations

5.5.4.2. Bags of ammonium nitrate in warehouses shall not be stacked closer than 914 mm from the roof, overhead supporting beams or sprinkler head deflectors.

Pallet channels

5.5.4.3. Where there is palletized storage of bagged ammonium nitrate in warehouses, pallet channels shall be at right angles to aisles.

Aisles

5.5.4.4.(1) Aisles of a minimum of 1 m in width shall be provided in warehouses to separate piles of ammonium nitrate.

(2) At least 1 aisle not less than 1.2 m in width shall be provided along the entire length of the storage area.

5.5.4.5. Unless constructed of noncombustible material or unless adequate facilities for fighting a roof fire are available, bulk storage structures shall not exceed a height of 12 m.

Bulk storage

5.5.4.6. Bulk storage of ammonium nitrate shall be located in warehouses, except that separate bin-type structures conforming to Article 5.5.4.7. may be used.

Bins

5.5.4.7. Bins described in Article 5.5.4.6. shall not contain galvanized iron, copper, lead or zinc, or other materials that may contaminate or be corroded by ammonium nitrate.

Identifying signs

5.5.4.8. Ammonium nitrate storage bins or piles shall be identified by signs of contrasting colours indicating the contents with letters 50 mm high.

Subsection 5.5.5. Fire Hazards

Smoking and open flames prohibited

5.5.5.1.(1) Smoking and the use of open flames shall be prohibited in **buildings** used for the storage of ammonium nitrate.

(2) Signs with letters 50 mm high indicating that ammonium nitrate is being stored and that smoking is not permitted shall be prominently displayed near each entrance on the exterior of **buildings** identified in Sentence (1).

Heating equipment

5.5.5.2. Heating equipment shall be separated from any storage area in conformance with the requirements of the **Building Code**.

Restricted use of mobile equipment

5.5.5.3. Mobile internal-combustion equipment may be used in storage buildings in conformance with Section 3.4.

Bags and containers

5.5.5.4. Bags and containers used for ammonium nitrate shall be in conformance with Part 73 of the **Regulations for the Transport of Dangerous Commodities by Rail**, as prepared by the Canadian Transport Commission.

Storage temperature

5.5.5.5.(1) Ammonium nitrate shall be stored at a storage facility where the ambient air temperature does not exceed 540°C.

(2) Ammonium nitrate having a temperature higher than 540°C shall not be transferred to the storage area.

Disposal

5.5.5.6.(1) Spilled ammonium nitrate material shall be disposed of in conformance with Sentences (2) to (5).

(2) Uncontaminated material may be rebagged in suitable slip-over bags and sealed to prevent spillage.

(3) Unsalvageable material shall be removed by sweeping and burial.

(4) After flushing and scrubbing contaminated areas very thoroughly to dissolve all material, the residue shall be washed away with hoses.

(5) Empty bags shall be disposed of by burning out of doors where permitted in a safe area or buried.

Explosives prohibited

5.5.5.7. Explosives shall not be used to break up caked ammonium nitrate.

Subsection 5.5.6. Fire Protection

Sprinkler installations

5.5.6.1.(1) Ammonium nitrate shall be stored only in **buildings** equipped with an automatic sprinkler system installed in conformance with NFPA 13-1983, "Standard for the Installation of Sprinkler Systems".

(2) Sentence (1) does not apply where the existing situation is **approved** and does not endanger life safety or alternative measures to the requirements set out in Sentence (1) are taken to provide life safety.

Portable extinguishers

5.5.6.2. Portable extinguishers shall be installed in conformance with Part 6.

SECTION 5.6 COMPRESSED GAS CYLINDERS

Subsection 5.6.1. General

5.6.1.1. RESERVED

5.6.1.2. Cylinders containing **compressed gas** shall be protected against mechanical damage and stored on racks or by using other devices designed to hold them in place.

Acetylene cylinders

5.6.1.3. Except when being transported, acetylene cylinders shall be kept in an upright position.

Valve caps

5.6.1.4. Cylinders containing **compressed gas** which are in storage shall be equipped with valve caps.

Temperature limitations

5.6.1.5. Cylinders containing **compressed gas** shall be stored in areas where the ambient air temperature does not exceed 520°C.

Ventilation

5.6.1.6. Where cylinders containing **compressed gas** are stored indoors, storage areas or rooms shall be dry and ventilated.

Oxygen cylinders

5.6.1.7. Oil or grease shall not be used for the lubrication of valves or fittings on oxygen cylinders.

Subsection 5.6.2. Storage

Outdoor platforms

5.6.2.1. Where cylinders containing **compressed gas** are stored outdoors, they shall be supported on raised concrete or other non-combustible platforms protected from the weather by a noncombustible canopy in an enclosure surrounded by a firmly anchored fence and used for the sole purpose of such storage.

Fencing

5.6.2.2.(1) The fence required in Article 5.6.2.1. shall

- (a) be designed to discourage climbing,
- (b) be substantially constructed with a minimum height of 1.8 m, and
- (c) be equipped with a gate to be kept locked when the enclosure is not staffed.

Clearances from building openings

5.6.2.3.(1) Cylinders containing **compressed gas** and located outdoors shall be,

- (a) if not more than 170 m³ aggregate capacity, 1.5 m from any **building** opening,
- (b) if over 170 m³ but under 500 m³ aggregate capacity, 7.5 m from any **building** opening, or
- (c) if over 500 m³ aggregate capacity, 15 m from any **building** opening.

Indoor storage of flammable compressed gases

5.6.2.4.(1) Except as provided in Sentences (2) and (3), cylinders containing flammable **compressed gas** stored indoors shall be located in a room that

- (a) is separated from the remainder of the **building** by a **fire separation** having a 2-hr **fire-resistance rating**,
- (b) is located on an exterior wall of the building,
- (c) can be entered only from the exterior,
- (d) is constructed so that an exterior wall provides explosion venting
 - (i) in the ratio of 0.2 m² for each cubic metre of room volume, or
 - (ii) in the ratio computed in accordance with NFPA 68-1978, "Guide for Explosion Venting", except in no case less than 650 cm² of vent area for each cubic metre of room volume,
- (e) is provided with natural ventilation with non-closeable louvered openings at the floor and ceiling in an outside wall,

(f) does not contain fuel fired equipment or high temperature heating elements, and

(g) is used for no purpose other than the storage of **compressed gas**.

Flammable compressed gases lighter than air

(2) Cylinders of flammable, lighter than air **compressed gas** may be stored in rooms other than those described in Sentence (1),

- (a) in a **building** of **combustible construction** that is not **sprinklered** where the aggregate capacity of expanded gas is not more than 60 m³,
- (b) in a **sprinklered building** of **combustible construction** where the aggregate capacity of expanded gas is not more than 170 m³, or
- (c) in a **building** of **noncombustible construction** where the aggregate capacity of expanded gas is not more than 170 m³.

Flammable compressed gases heavier than air

(3) Where flammable **compressed gas** is heavier than air, only 1 cylinder of gas may be located in any 1 room of a **building**, and cylinders shall not be located in **basements** or other areas below **grade**, but does not include cylinders on industrial trucks described in section 3.4.

5.6.2.5. RESERVED

5.6.2.6. Cylinders containing poisonous **compressed gas** shall not be stored in a room containing combustible or flammable material.

Restricted storage

5.6.2.7. Cylinders of gases that may react with one another shall not be stored in the same area.

5.6.2.8. Cylinders of flammable gases shall not be stored with **oxidizing materials** or with cylinders containing gases that support combustion.

Signs

5.6.2.9. Storage rooms shall have exterior signs with minimum 50 mm high letters indicating the nature of the **compressed gases**.

SECTION 5.7 REACTIVE SUBSTANCES

RESERVED

SECTION 5.8 CORROSIVE LIQUIDS

RESERVED

SECTION 5.9 OXIDIZING MATERIALS

RESERVED

SECTION 5.10 COMBUSTIBLE DUST PRODUCING PROCESSES

Subsection 5.10.1. Dust Collection

Mechanical exhaust systems

5.10.1.1. Machinery that produces, agitates or conveys **combustible dusts** shall have or be connected to a mechanical exhaust system to the outside atmosphere and dust-tight casings or enclosures.

5.10.1.2.(1) **Building** and machinery surfaces shall be kept clean by a vacuum apparatus listed and labelled for use in atmospheres containing **combustible dusts**.

(2) The vacuum cleaning machine required in Sentence (1) and ancillary piping, suction hose and tools shall be electrically conductive and grounded.

(3) Compressed air or other **compressed gases** shall not be used to blow dust from surfaces inside **buildings**.

Dust-collecting equipment

5.10.1.3. Dust-collecting equipment shall be installed where necessary to keep the accumulation of dust at a safe concentration in the interior of the **building**.

5.10.1.4.(1) Dust-collecting systems shall be made of noncombustible material.

(2) Dust-collecting systems shall be of a design which will prevent sparks due to physical contact in the fan assembly.

5.10.1.5.(1) Except where specifically designed and manufactured for internal use, dust-collectors shall

- (a) be located outside **buildings**, or
- (b) be equipped with exhaust stacks or ducts leading to the outside.

Grounding

5.10.1.6. Electrically conducting parts of duct systems, dust-collectors and the machines they serve shall be grounded.

Explosion venting

5.10.1.7. Except as provided in Article 5.10.1.11., manufacturing activities that produce, agitate, or convey **combustible dusts** shall be located only in **buildings** which have explosion venting to the outdoors.

5.10.1.8. Dust-collectors within **buildings** shall be designed with explosion venting to the exterior.

Interlocks

5.10.1.9. Equipment required to have a dust exhaust system shall not be capable of operating until the dust exhaust system is in operation.

Air velocity

5.10.1.10. Dust-collector systems shall be designed for an air velocity in the ducts of at least 1068 m/min.

Vent stacks

5.10.1.11.(1) Permanently open vent stacks may be used to ventilate storage containers where mechanical dust-collector systems are not practical, provided that the vent stacks

- (a) have a cross-sectional area not less than twice that of spouts discharging into the container,
- (b) are installed not more than 30 degrees from the vertical,
- (c) extend from the top of the container to a point not less than 1.2 m above the roof, and
- (d) are designed to prevent the entry of snow and rain.

Separators

5.10.1.12. Magnetic or pneumatic separators shall be installed to prevent the entrance of foreign materials that may cause sparks in equipment such as shellers, crackers, crushers, grinding machines, pulverizers or similar machines that produce **combustible dusts**.

Grounding

5.10.1.13. Machinery and metal parts of the equipment in Article 5.10.1.12. and related conveying systems shall be electrically grounded.

Ignition sources prohibited

5.10.1.14. Smoking, open flame and spark-producing equipment shall not be allowed in areas containing **combustible dust** producing operations.

SECTION 5.11 COMBUSTIBLE FIBRES

Subsection 5.11.1. Storage

Building sizes

5.11.1.1. **Buildings** used for the storage and handling of baled **combustible fibres** shall comply with the height and area limitations of the **Building Code** for Group 'F' Division 2 occupancies.

Loose fibre storage

5.11.1.2.(1) Up to 3 m³ of loose **combustible fibres** may be kept in any **building** provided storage is in a container complying with Articles 2.4.1.9. and 2.4.1.10.

(2) Quantities of loose **combustible fibres** exceeding 3 m³ but not exceeding 15 m³ shall be stored in rooms separated from the remainder of the **building** by a **fire separation** having a 1-hr **fire-resistance rating**.

(3) Quantities of loose **combustible fibres** exceeding 15 m³ but not exceeding 30 m³ shall be stored in rooms separated from the remainder of the **building** by a **fire separation** having a 2-hr **fire-resistance rating**.

(4) Quantities of more than 30 m³ of loose **combustible fibres** shall not be stored in an individual room unless the room is **sprinklered** and separated from the remainder of the **building** by a **fire separation** having a 2-hr **fire-resistance rating**.

Baled fibre storage

5.11.1.3.(1) Baled **combustible fibres** shall be stored so that

- (a) a single pile will not contain more than 700 m³,
- (b) the maximum height of any single pile will not exceed 4.5 m,
- (c) piles are separated by aisles not less than 1.5 m wide, and
- (d) the clearance between piles and building walls is not less than 1 m.

Baled storage piles

5.11.1.4. The sides of baled storage piles shall be inclined back from the base of the pile with a slope of not less than 1 m for each 10 m of height.

5.11.1.5.(1) The clearance between sprinkler head deflectors and the tops of piles shall not be less than 457 mm.

(2) Where the storage piles are above the lower chords of floor or roof structural framing members, a horizontal clear space of 300 mm shall be maintained between the storage and the structural members.

Heating equipment

5.11.1.6.(1) Storage areas for **combustible fibres** shall not contain fuel fired **appliances** or electrical heating elements.

(2) Shields shall be provided that will prevent stored material from coming within 300 mm of any part of the heating system.

Subsection 5.11.2. Fire Protection

Standpipe and hose system installations

5.11.2.1. **Combustible fibres** shall be stored only in warehouses which are protected by standpipe and hose systems installed in conformance with the **Building Code**.

Portable extinguishers

5.11.2.2. Portable extinguishers shall be provided in conformance with Part 6.

Smoke vents

5.11.2.3. Where **combustible fibres** are stored in **buildings**, automatic smoke venting hatches manually operable from remote locations and having a combined opening area of 64 cm³ for each square metre of **floor area** shall be provided.

SECTION 5.12 SPRAY APPLICATIONS USING FLAMMABLE AND COMBUSTIBLE MATERIALS

Subsection 5.12.1. Location

5.12.1.1. Spray operations shall be separated from the remainder of the **building** in conformance with the **Building Code**, where applicable.

Subsection 5.12.2. Construction

General

5.12.2.1.(1) A **spray booth** shall consist of a steel frame covered with sheet steel having a minimum thickness of 1.14 mm, or be of equivalent **noncombustible construction**.

(2) The interior surfaces of a **spray booth** shall be smooth and continuous.

(3) The floor of a **spray booth** and the operator's working area shall be of noncombustible, non-sparking material.

Baffle plates

5.12.2.2.(1) **Spray booth** baffle plates shall be of noncombustible material and be removeable or arranged to facilitate cleaning.

(2) **Spray booth** baffle plates shall not be located in exhaust ducts.

Filters in ducts

5.12.2.3. Filters in ducts used to ventilate **spraying areas** shall be made from noncombustible material or have a rate of combustibility no greater than Class 2 filters conforming to CAN4-S111-M80, "Standard Method of Fire Tests for Air Filter Units".

Fan blades and casings

5.12.2.4. Fan blades and casings in exhaust blowers for **spray booths** shall be nonferrous.

Subsection 5.12.3. Ventilation

Mechanical ventilation

5.12.3.1. Mechanical ventilation shall be provided in all **spraying areas** with sufficient air movement to prevent dangerous flammable vapour or powder concentrations.

Air velocity

5.12.3.2. Except as provided in Article 5.12.3.3., the exhaust air velocity at the face of the **spray booth** shall be 30 m/min.

5.12.3.3. Electrostatic spraying shall have an exhaust air velocity of 18 m/min at the face of the **spray booth**.

Combined ducting

5.12.3.4. A separate exhaust duct shall be provided for each **spray booth**, except that a common duct may be used if it serves **spray booths** having a combined open frontal area of not more than 1.8 m².

Exhaust air

5.12.3.5. Air exhausted from spray operations shall not be recirculated, except where recirculation is acceptable, as described in

NFPA 33-1982, "Standard for Spray Application Using Flammable and Combustible Materials".

Maintenance of air velocity

5.12.3.6. Gauges or audible alarms that will ensure that the required air velocity will be maintained shall be installed at **spray booths**.

Subsection 5.12.4. Exhaust Ducts

Duct support and construction

5.12.4.1. Exhaust ducts for **spray booths** shall be securely supported and constructed of sheet steel in conformance with Table 5.12.4.A.

TABLE 5.12.4.A.

Forming Part of Article 5.12.4.1.

Maximum Dimension of Duct	Minimum Thickness of Sheet Steel, mm
Up to 200 mm incl.	0.56
Over 200 mm to 450 mm incl.	0.69
Over 450 mm to 750 mm incl.	0.86
Over 750 mm	1.14
Column 1	2

Clearances

5.12.4.2. Except as provided in Article 5.12.4.3., a clearance of 457 mm shall be maintained between ducts venting **spray booths** and unprotected combustible material.

Collars

5.12.4.3.(1) Where exhaust ducts pass through combustible roofs or **partitions**, metal collars shall provide not less than a 100 mm clearance between the duct and combustible material.

(2) The space between the duct and combustible material shall be sealed with noncombustible insulating material.

Access doors

5.12.4.4. Exhaust ducts for **spray booths** shall be provided with access doors for cleaning purposes.

Exhaust outlet locations

5.12.4.5.(1) Except for water-wash types, the exhaust outlet to atmosphere from **spray booths** shall

- be 1.8 m from any combustible exterior wall or roof, and
- be located so that the air does not discharge toward any combustible surface or unprotected opening within 7.5 m.

Subsection 5.12.5. Electrical Equipment

Hazardous locations

5.12.5.1. Electrical equipment within the **spraying area** including lighting fixtures shall conform to Part 1, Sections 18 and 20 of the **Electrical Safety Code** made under the **Power Corporation Act**.

Motors for exhaust fans

5.12.5.2. Electric motors for exhaust fans shall not be placed inside **spray booths** or ducts.

Grounding

5.12.5.3. Metal parts of **spray booths**, exhaust ducts and piping systems conveying **flammable** or **combustible liquids** shall be electrically grounded.

Subsection 5.12.6. Flammable and Combustible Liquids

Storage and handling

5.12.6.1.(1) **Flammable and combustible liquids** for use in **spraying areas** shall be stored and handled in an **approved** manner.

(2) The amount of **flammable and combustible liquids** in the **spraying areas** shall not exceed 1 day's supply.

Paint storage

5.12.6.2. Paint shall be kept in **closed containers** when not in use.

Thinners and solvents

5.12.6.3. Thinners and solvents shall be dispensed only from **listed** and labelled safety cans.

Pump discharge relief valves

5.12.6.4. Where **flammable liquids** are supplied to spray nozzles by positive displacement pumps, the pump discharge line shall be provided with a suitable relief valve discharging to the pump suction or to a safe remote location.

Subsection 5.12.7. Control of Fire Hazards

Interlocks

5.12.7.1. The spraying equipment for a **spray booth** shall be interlocked to shut down in the event of failure of the ventilation system, failure of the circulating water pump of a water-wash system or failure of the filter roll-down mechanism of a **dry spray booth**.

Cleaning and residue disposal

5.12.7.2.(1) The inner surface of **spray booths** shall be kept clean by removing the deposits of combustible residue.

(2) Combustible residue from cleaning operations shall be removed from the **spraying area** and put in **approved** safety cans for daily disposal.

Filter pads and rolls

5.12.7.3. Discarded filter pads and filter rolls shall be removed to a safe location or placed in a water-filled metal container and disposed of after each day's operation.

Filters prohibited

5.12.7.4. A water-wash **spray booth** shall be used when applying spray material that is susceptible to spontaneous heating.

Heating equipment

5.12.7.5. **Space-heating appliances**, steam pipes and other hot surfaces shall not be located in an area where deposits of combustible residue may accumulate.

Ignition sources

5.12.7.6. Open flame or spark producing devices shall not be used within a **spraying area**, unless separated therefrom by a vapour-tight **fire separation** with a 1-hr **fire-resistance rating**.

Subsection 5.12.8. Fire Protection Equipment

Portable extinguishers

5.12.8.1. Portable extinguishers shall be installed near **spraying areas** in conformance with Part 6.

Sprinkler installations

5.12.8.2.(1) Except as permitted in Sentences (2) and (3), automatic sprinkler protection shall be provided in each **spraying area**, **spray booth** and **spray room** in conformance with NFPA 13-1983, "Standard for the Installation of Sprinkler Systems".

(2) Where spraying operations are confined within a **spray booth**, fire protection may be provided for the **spray booth** only, in conformance with NFPA 33-1982, "Standard for Spray Application Using Flammable and Combustible Materials".

(3) This Article does not apply where the existing situation is **approved** and does not endanger life safety, or alternative measures to the requirements set out in this Article are taken to provide life safety.

Sprinkler head protection

5.12.8.3.(1) Sprinkler heads in **spray booths** shall be protected with lightweight paper or thin polyethylene bags.

(2) Bags protecting sprinkler heads shall be replaced before they have accumulated excessive deposits.

Subsection 5.12.9. Drying Operations

Spray booths used for drying

5.12.9.1. **Spray booths**, **spray rooms** or other enclosures used for spraying operations shall not be used for drying by any arrangement that could cause an increase in the surface temperatures of the **spray booths**, **spray rooms** or other enclosures.

Location of equipment

5.12.9.2. Except as provided in Articles 5.12.9.3. and 5.12.9.4., drying or curing equipment that utilizes open flames or that produces sparks shall not be installed in or near a **spraying area**.

5.12.9.3.(1) Equipment described in Article 5.12.9.2. may be installed in an area adjacent to the **spraying area** provided the adjacent area is equipped with a ventilating system arranged to

- (a) purge the drying space before the heating system can be started,
- (b) maintain a safe atmosphere at any source of ignition, and
- (c) automatically shut down the heating system in the event of failure of the ventilating system.

Automobile spray booths used for drying

5.12.9.4.(1) Automobile **spray booths** may be used for drying operations with portable electric infrared drying apparatus provided

- (a) the interior of the enclosure is kept reasonably free of over-spray deposits,
- (b) the drying apparatus, wiring and connections are removed from the enclosure during spraying operations, and
- (c) interlocks are installed to
 - (i) prevent the use of spraying apparatus while the drying apparatus is in the enclosure,
 - (ii) provide for the purging of the enclosure of spray vapours for a minimum of 3 minutes before the drying apparatus can be energized,
 - (iii) ensure that the ventilating system maintains a safe atmosphere within the enclosure during the drying process, and
 - (iv) ensure that the drying apparatus will automatically shut off in the event of failure of the ventilating system.

SECTION 5.13 DIP TANKS

Subsection 5.13.1. Location

5.13.1.1. Dip tank operations involving **flammable or combustible liquids** shall be conducted only in a room designed for the purpose and separated from other areas by a **fire separation** having a 2-hr **fire-resistance rating**.

5.13.1.2. Dip tanks shall not be located in **cellars** or **basements**.

Subsection 5.13.2. Construction

Floors

5.13.2.1. The floor of any room where dip tanks are located shall be waterproofed, provided with permanent curbs and drained to a place of safe discharge.

Materials

5.13.2.2.(1) Dip tanks and drain boards shall be constructed of noncombustible material with steel, reinforced concrete or masonry supports.

(2) Drain boards shall be arranged to drain back to the dip tank.

Height above floor

5.13.2.3. The top of a dip tank shall not be less than 150 mm above the floor of the room in which it is located.

Covers

5.13.2.4. Dip tank covers as required in Articles 5.13.6.2. and 5.13.6.3. shall be of noncombustible materials.

5.13.2.5. Dip tank covers shall overlap the sides of the tank by 25 mm and shall have a recess or flange extending down around the tank.

5.13.2.6. Dip tank covers shall be maintained in good operating condition.

Subsection 5.13.3. Overflow and Drain Pipes

Liquid levels

5.13.3.1. The liquid level in a dip tank shall be kept not less than 150 mm below the top of the tank.

Overflow pipes

5.13.3.2. Dip tanks having a capacity in excess of 550 L or having a liquid surface area in excess of 1 m² shall be equipped with a properly trapped overflow pipe that leads to a safe location outside the **building** or to a closed, vented salvage tank conforming to Subsection 5.13.4.

5.13.3.3. The centre line of the overflow connection to a dip tank shall be 150 mm below the top of the tank.

5.13.3.4. Overflow pipe sizes for dip tanks shall conform to Table 5.13.3.A.

TABLE 5.13.3.A.

Forming Part of Article 5.13.3.4.

Size of Tank, L	Overflow Pipe Size Required, mm
0 - 46	50
47 - 160	65
161 - 350	75
351 - 700	100
701 - 1 025	125
1 026 - 1 500	150
1 501 and over	200
Column 1	2

5.13.3.5. Overflow pipes shall be connected to dip tanks by a flared outlet.

Piping connections

5.13.3.6. Piping connections for drains and overflow lines shall be designed so as to allow for easy access to their interiors for cleaning purposes.

Bottom drains

5.13.3.7. Dip tanks of over 2300 L liquid capacity shall be equipped with bottom drains capable of being operated both automatically and manually to drain the tank quickly in the event of fire.

5.13.3.8. Bottom drains from dip tanks shall be trapped and shall discharge to a closed, vented salvage tank.

5.13.3.9. Bottom drain sizes for dip tanks shall conform to Table 5.13.3.B.

TABLE 5.13.3.B.

Forming Part of Article 5.13.3.9.

Capacity of Dip Tank, L	Diameter of Bottom Drain Pipe, mm
2 300 - 3 425	75
3 426 - 4 550	100
4 551 - 11 500	125
11 501 - 18 250	150
18 251 and over	200
Column 1	2

Manual operation of bottom drains

5.13.3.10. Manual operation of bottom drains shall be from an accessible location not affected by a fire in or around the dip tank.

Automatic pumps

5.13.3.11. Where gravity flow is not practicable, automatic pumps shall be installed on drain lines from dip tanks.

5.13.3.12. Where salvage tanks are used, pumping arrangements shall be provided for the transfer of their contents for disposal.

Subsection 5.13.4. Salvage Tanks

Use

5.13.4.1. Salvage tanks shall be used only for temporary storage purposes.

Capacity

5.13.4.2. The capacity of a salvage tank shall be 20 per cent greater than the capacity of the dip tank or tanks to which it is connected.

Location

5.13.4.3. Salvage tanks shall be located underground in the yard or inside a **building** in an enclosure separated from the remainder of the **building** by a **fire separation** having a 2-hr fire-resistance rating.

Subsection 5.13.5. Control of Fire Hazards

Ventilation

5.13.5.1. Ventilation shall be provided to confine all flammable vapour concentrations exceeding 25 per cent of the **lower explosive limit** to within 600 mm of the dip tank, drain board and freshly coated work.

Interlocks

5.13.5.2. Ventilating systems shall be arranged so that the failure of any ventilation fan as sensed by air flow will automatically stop the dipping conveyor systems and sound an alarm.

5.13.5.3. The heating system used in drying operations shall be interlocked so that it cannot be started until the associated ventilation system is in operation.

Conveyor systems

5.13.5.4. Conveyor systems utilized in conjunction with dip tanks

shall be designed to stop automatically with the actuation of an automatic fixed extinguishing system or a manual fire alarm.

Purging interlocks

5.13.5.5. Where there is a possible source of ignition in a drying operation, interlocks shall be installed to provide for purging before the heating system can be started and for automatic shutdown if the ventilation system should fail.

Electrical installations

5.13.5.6. Where **flammable** and **combustible liquids** contained in dip tanks are heated or have a **flash point** below 43°C, the electrical installation shall conform to the **Electrical Safety Code** made under the **Power Corporation Act**.

5.13.5.7.(1) RESERVED

Flammable and combustible liquids

(2) The total number of containers for **flammable** and **combustible liquids** in a dip tank area shall not exceed that required for 1 day's operations.

Ignition sources

5.13.5.8. Smoking, open flames, sparkproducing devices and heated surfaces having a temperature sufficient to ignite vapours shall not be permitted in the vapour area of a dip tank.

Signs prohibiting smoking

5.13.5.9. Signs that prohibit smoking and that conform to Article 2.4.3.2. shall be posted conspicuously in the vicinity of dip tanks.

Subsection 5.13.6. Fire Protection

Automatic sprinklers

5.13.6.1. Dip tanks shall be located only in rooms protected by an automatic sprinkler system installed in conformance with NFPA 13-1983, "Standard for the Installation of Sprinkler Systems".

Tank covers and extinguishing systems

5.13.6.2.(1) Dip tanks with a capacity of over 550 L or over 1 m² liquid surface area shall be protected by

- (a) an automatic closing cover actuated by a device that also permits manual operations, or
- (b) an **approved** automatic extinguishing system of a water spray, foam, carbon dioxide or dry chemical type.

5.13.6.3. Dip tanks containing either a **flammable** or **combustible liquid** with a **flash point** less than 43°C or a heated **combustible liquid** giving off flammable vapours shall conform to Article 5.13.6.2. when the capacity exceeds 45 L or when the liquid surface area exceeds 0.4 m².

Portable extinguishers

5.13.6.4. Areas in the vicinity of dip tanks shall be provided with portable extinguishers in conformance with Part 6.

SECTION 5.14 SPECIAL PROCESSES INVOLVING FLAMMABLE AND COMBUSTIBLE LIQUIDS

Subsection 5.14.1. Quench Tanks

Location

5.14.1.1.(1) Quench tanks shall be located as far as practicable from annealing, hardening and tempering furnaces.

(2) Quench tanks shall not be located on or near combustible floors.

Hoods and vents

5.14.1.2. Quench tanks shall be provided with a noncombustible hood and vent exhausting to the outside of the **building**.

5.14.1.3. Vents for quench tanks shall conform to the requirements for **flue pipes** in Section 2.6.

High temperature limit switches

5.14.1.4.(1) A high temperature limit switch shall be provided to sound an alarm, shut off heat and stop conveyors when a **flammable** or **combustible liquid** reaches 28°C below its **flash point** in a quench tank.

(2) The temperature-sensing element for the high temperature limit switch in Sentence (1) shall be located close to the surface of the liquid and be protected from damage.

Electrical installations

5.14.1.5. Electrical installations conforming to the requirements for dip tanks in Article 5.13.5.6. shall be provided for quench tanks of over 1900 L capacity whose liquid surface area exceeds 2.5 m².

Air pressure

5.14.1.6. Air under pressure shall not be used to fill or agitate oil in quench tanks.

Working temperatures

5.14.1.7. A quench tank shall be designed so that the maximum workload is incapable of raising the working temperature of the cooling medium to within 28°C of its **flash point**.

Subsection 5.14.2. Flow-Coating Operations

Application of dip tank requirements

5.14.2.1.(1) The requirements in Section 5.13 for dip tanks shall also apply to flow-coating operations.

(2) The sump area and any area on which paint flows shall be considered as the dip tank area for the purposes of these provisions.

Mechanical ventilation

5.14.2.2. Mechanical ventilation shall be provided at the rate of 63 m³ of fresh air per litre of solvent used.

5.14.2.3. Ventilation shall be arranged so that the flammable vapour concentration exceeding 25 per cent of the **lower explosive limit** will be confined to within 600 mm of the paint stream and drain area, freshly coated work and the drip tunnel bottom.

Interlocks

5.14.2.4. The ventilation system shall be interlocked to shut down the paint supply whenever fans are stopped as sensed by the air flow.

Paint supply

5.14.2.5.(1) Paint shall be supplied by

- (a) direct low pressure pumping arranged to shut down automatically by means of **listed** and labelled heat-actuated devices in the event of fire, or
- (b) a gravity tank not exceeding 45 L in capacity.

Subsection 5.14.3. Roll-Coating Processes

Application of dip tank requirements

5.14.3.1. The requirements in Section 5.13 for dip tanks shall also apply to roll-coating processes.

Grounding

5.14.3.2.(1) Rotating parts shall be grounded.

(2) Static collectors shall be installed where the material being coated leaves each rotating part.

Location

5.14.3.3. Operations involving materials that have been freshly coated with a liquid containing solvents having a **flash point** less than 43°C shall be located in **sprinklered** rooms that are separated from other occupancies by **fire separations** having a 2-hr **fire-resistance rating**.

Subsection 5.14.4. Electrostatic Spraying and Detearing Equipment

Equipment location

5.14.4.1.(1) Electrical components including transformers, power packs and control equipment for electrostatic spray applications or for the electrostatic removal of excess coating material (detearing) shall be located in an area where the vapour concentration of **flammable** or **combustible liquids** cannot exceed 25 per cent of the **lower explosive limit**.

(2) Sentence (1) does not apply to high voltage grids and their connections.

Interlocks

5.14.4.2.(1) Electrostatic spraying and detearing equipment shall be provided with automatic controls that will operate without a time delay to disconnect power to high voltage transformers and to signal the operator when

- (a) stoppage of the air supply, ventilating fan or conveyor system occurs,
- (b) there is a ground at any point on the high voltage system, or
- (c) clearances are reduced below those specified in Article 5.14.4.4.

Insulators

5.14.4.3. Insulators shall be kept clean and dry.

Clearances

5.14.4.4.(1) A space equivalent to twice the sparking distance shall be maintained between articles being painted or deteared and electrodes or conductors.

(2) A sign shall be conspicuously posted near an electrical assembly stating the maximum sparking distance.

Drip plates and screens

5.14.4.5. Drip plates and screens subject to paint deposits shall be removeable for cleaning.

Insulating and grounding

5.14.4.6. High voltage components, including atomizing heads, shall be insulated and protected against mechanical damage and accidental contact or grounding.

5.14.4.7. An automatic means shall be provided for grounding the electrode system when it is de-energized.

Operating distances

5.14.4.8. Items being electrostatically sprayed shall not be held by hand nor suspended in such a manner as to reduce the proper operating distance from the atomizing heads.

5.14.4.9. Electrostatic spraying equipment shall be located 1.5 m from processing equipment and isolated from other areas by grounded guards and fences of conducting material.

Surface temperatures

5.14.4.10. The surface temperature of equipment in a **spraying area** shall not exceed 66°C.

Precautions against shock

5.14.4.11. High voltage circuits shall be designed so that any discharge occurring will not ignite vapour-air mixtures or create a shock hazard.

Spray guns

5.14.4.12. The energy supply to hand spray guns shall be controlled by a switch that also controls the coating material supply.

5.14.4.13. Spray gun handles shall be grounded and have a metallic connection that is in direct contact with the operator's hand during spraying.

Grounding

5.14.4.14.(1) Electrically conductive objects in the **spraying area**, including paint containers, wash cans and other objects, shall be grounded.

(2) A sign shall be posted in the **spraying area** indicating the need for the grounding of electrically conductive objects.

5.14.4.15. Hooks and other supports for sprayed items shall be kept clean and free of paint.

Warning signs

5.14.4.16. Signs designating the **spraying area** as dangerous shall be conspicuously posted.

Fixed extinguishing equipment

5.14.4.17. **Spraying areas** shall be located in rooms protected by **listed** and labelled automatic fixed extinguishing equipment.

Subsection 5.14.5. Automobile Undercoating

5.14.5.1. Automobile undercoating spray operations shall conform to the requirements of Section 5.12 or to the requirements in this Subsection.

Undercoating materials

5.14.5.2.(1) Automobile undercoating materials shall have a **flash point** of not less than 37.8°C.

(2) Where the **flash point** of an automobile undercoating is less than 60°C, it shall be applied in a work area where

- (a) there are no work pits,
- (b) there is a fan with nonferrous blades that provides mechanical ventilation during the application, cleaning and drying cycles at the rate of 72 m³/min per work station,
- (c) air movement from the air intake and exhaust system is along the length of the vehicle being undercoated, and
- (d) air is exhausted at a level approximately 1 m above the floor.

Ignition sources

5.14.5.3.(1) Work stations in Article 5.14.5.2. shall have no source of ignition located within 6 m horizontally of the work area or in the area above it.

(2) Signs prohibiting smoking that conform to Article 2.4.3.2. shall be posted at the outer limits of the work area.

Electrical installations

5.14.5.4. Except for overhead lighting that is totally enclosed and sealed with gaskets, electrical wiring and equipment within the area of hazard described in Article 5.14.5.3. shall conform to Article 5.1.3.1.

5.14.5.5. RESERVED

Portable extinguishers

5.14.5.6. Portable extinguishers shall be located so that there is one portable extinguisher having a 20BC rating immediately accessible to each work station described in Article 5.14.5.2.

Refuse disposal

5.14.5.7.(1) Areas where automobile undercoating is used shall be kept clean of undercoating deposits and refuse.

(2) The deposits and refuse shall be placed in covered metal containers.

Subsection 5.14.6. Dry Powder Finishing

Location of operations

5.14.6.1.(1) Processes involving protective finishing material applied in dry powder form by powder spray guns, by electrostatic powder spray guns, by fluidized beds or by electrostatic fluidized beds shall be performed in rooms of **noncombustible construction**, in ventilated, enclosed, powder-coating facilities, or in **spray booths** conforming to Article 5.12.2.1.

Installation

(2) Electrostatic fluidized beds and associated equipment shall be installed in conformance with good engineering practice.

Location of electrical equipment

5.14.6.2.(1) Transformers, power packs, control apparatus and other electrical components shall be located outside the powder-coating area.

(2) Sentence (1) does not apply to charging electrodes and their components.

Working temperatures

5.14.6.3.(1) Where a part to be coated is preheated prior to the application of the powder, the temperature of the part shall not exceed the ignition temperature of the powder being used.

(2) The surface temperature of electrostatic fluidized bed coating areas shall not exceed 66°C.

Grounding

5.14.6.4.(1) Powder transport, application and recovery equipment shall be grounded.

(2) Electrically conductive objects within the charging influence of the electrodes of electrostatic fluidized beds shall be grounded.

(3) A sign shall be posted indicating the necessity of grounding equipment and objects identified in Sentences (1) and (2).

Electrical discharges

5.14.6.5. High voltage circuits in electrostatic fluidized beds shall be designed so that any discharge produced when the charging electrodes of the bed are approached or contacted by a grounded object will not be of sufficient intensity to ignite any powder-air mixture likely to be encountered or result in any appreciable shock hazard.

Separators

5.14.6.6. Separators shall be used to prevent tramp iron or other spark-producing materials from being introduced into the powders being applied.

Recovery systems

5.14.6.7.(1) Waste air-suspended powders shall be safely removed by exhaust ducts to a powder recovery system.

(2) Waste air-suspended powders shall not be released to the outside atmosphere.

Vacuum cleaning

5.14.6.8. Accumulations of waste dust from dry powder finishes shall be removed by vacuum cleaning equipment.

Contact points

5.14.6.9. Objects being coated shall be maintained in contact with the conveyor or other support.

5.14.6.10. Hangers for objects being coated shall be kept clean and have sharp points or edges at areas of contact.

Smoking prohibited

5.14.6.11.(1) Smoking shall not be permitted at powder-coating areas and in powder storage rooms.

(2) Signs prohibiting smoking that conform to Article 2.4.3.2. shall be conspicuously posted at all powder-coating areas and powder storage rooms.

Subsection 5.14.7. Organic Peroxides and Dual Component Coatings

Location of spraying operations

5.14.7.1. Spraying operations involving the use of organic peroxides and other dual component coatings shall be conducted in **sprinklered spray booths** as described in Section 5.12.

Initiator storage

5.14.7.2. Organic peroxide initiators shall be stored so that they will be kept away from contact with other stored materials.

Handling equipment

5.14.7.3. Handling equipment, including spray guns, that are specifically designed for use with organic peroxides shall be used to apply dual component coatings.

Containers

5.14.7.4. Separate containers shall be used exclusively for the storage of resin and organic peroxide.

Pressure tank inserts

5.14.7.5. Organic peroxide pressure tank inserts shall be constructed of stainless steel, polyethylene or a material that is equally inert to organic peroxide.

Elimination of foreign materials

5.14.7.6. Precautions shall be taken to prevent any mixing of foreign materials with dusts or overspray residues resulting from the sanding or spraying of finishing materials containing organic peroxides.

Handling

5.14.7.7. RESERVED

SECTION 5.15 RADIOACTIVE MATERIALS

Subsection 5.15.1. Application

Application

5.15.1.1. This Section applies to the storage and handling of radioactive material that emits ionizing radiation and that is present in quantities in excess of the scheduled quantity as defined in Schedule I of the **Atomic Energy Control Regulations** made under the **Atomic Energy Control Act (Canada)**.

Subsection 5.15.2. Storage

5.15.2.1. Radioactive materials and equipment shall be returned to storage after use.

Storage

5.15.2.2. Radioactive materials shall be stored in accordance

with the licence requirements and regulations of the Atomic Energy Control Board.

5.15.2.3. Radioactive materials and equipment shall not be stored with flammable or corrosive materials.

Subsection 5.15.3. Emergency Procedures

5.15.3.1.(1) Persons using or storing radioactive materials shall establish fire emergency procedures in consultation with the **fire department** including

- (a) the location and identification of storage and use areas,
- (b) methods to control a fire emergency and to recover radioactive materials and equipment containing radioactive materials safely and efficiently,
- (c) the names, addresses and telephone numbers of primary and alternative sources of expert radiation safety advice and assistance, and
- (d) the location of primary and alternative sources of radiation survey instruments.

SECTION 5.16 FUMIGATION AND THERMAL INSECTICIDAL FOGGING

Subsection 5.16.1. Application

Application

5.16.1.1.(1) This Section applies to the fumigation or thermal fogging of **buildings** where this activity creates a fire or explosion hazard, including the fumigation of equipment or commodities within structures, tanks, bins or under tarpaulins.

Exceptions

(2) Articles 5.16.2.1. and 5.16.2.2. do not apply to industries that conduct frequent fumigation operations on a routine basis where **approved** prior to the conducting of the operations.

Subsection 5.16.2. Safety Precautions

Notification of fire department

5.16.2.1.(1) Except as permitted in Sentence 5.16.1.1.(2), the **fire department** shall

- (a) be notified in writing at least 24 hours before any **building** is to be closed for fumigation, and
- (b) be advised of the chemicals to be used, the proposed date and time of use, types of respiratory protective devices required and the degree of flammability of the fumigant or fog being used.

Notification of neighbours

5.16.2.2. Except as permitted in Sentence 5.16.1.1.(2), prior notice shall be given to the occupants of any premises adjacent to that in which fumigation or thermal insecticidal fogging is to take place.

Ignition sources

5.16.2.3. Flames and other sources of ignition shall be eliminated in a **building** undergoing fumigation or thermal insecticidal fogging.

Power supply

5.16.2.4. Electric power supply shall be shut off to the premises undergoing fumigation or thermal insecticidal fogging.

Air temperature

5.16.2.5. The air temperature in a **building** undergoing fumigation or thermal insecticidal fogging shall be kept sufficiently low to prevent the actuation of any sprinkler system.

Breathing apparatus

5.16.2.6. Protective breathing apparatus shall be made available at the premises undergoing fumigation or thermal insecticidal fogging for all persons in case of emergency.

Restricted entrance

5.16.2.7.(1) No person shall be permitted to enter a premises undergoing fumigation or thermal insecticidal fogging until the premises has been ventilated and is safe for human occupancy.

(2) Warning signs shall be posted in a conspicuous location near every entrance to the premises being fumigated.

5.16.2.8. RESERVED

SECTION 5.17 WELDING AND CUTTING

Subsection 5.17.1. General

Application

5.17.1.1. The protection of persons and property from injury or damage by fire or other causes arising from electric and gas welding and cutting equipment, its installation, operation and maintenance, shall conform to CSA W117.2-1974, "Code for Safety in Welding and Cutting", and to the requirements in this Section.

Subsection 5.17.2. Use and Maintenance of Equipment

Fuel gases

5.17.2.1. The operation of acetylene generating systems and the storage and generation of welding fuel gases shall conform to NFPA 51-1977, "Oxygen-Fuel Gas Systems for Welding and Cutting", Chapter 6.

Piping

5.17.2.2. Acetylene gas shall not be piped through copper or high copper content alloy, tubing, piping or fittings.

Cylinder storage

5.17.2.3. Cylinders stored inside **buildings** shall conform to the requirements in Section 5.6.

5.17.2.4. Gas fuel cylinders, whether full or empty, whose valves are not in a recessed or protected location shall have their caps in place and their valves tightly closed when not in actual use.

Damaged equipment

5.17.2.5. Torches, regulators, hoses and other oxyacetylene welding and cutting equipment which have been damaged shall not be used.

5.17.2.6.(1) Welding equipment shall be **inspected** daily or prior to use for defects by personnel in charge of the equipment.

(2) Welding and cutting equipment shall be **tested** monthly for leaks with a leak test solution.

(3) Defects in equipment shall be made good before reusing.

Equipment not in use

5.17.2.7. Valves shall be closed and lines bled when equipment is not in actual use.

5.17.2.8. Oil or grease shall not be used for lubrication of welding and cutting equipment.

Subsection 5.17.3. Prevention of Fires

Location of operations

5.17.3.1.(1) Welding and cutting operations in **buildings** shall be carried out in areas that are free of combustible and flammable contents, and that have walls, ceilings and floors of **noncombustible construction** or that are lined with noncombustible materials.

(2) When it is not practicable to undertake welding and cutting operations in areas described in Sentence (1), combustible and flammable materials shall either be removed 11 m from the work area or otherwise protected against ignition by sheet metal, asbestos blankets or other noncombustible material.

Work adjacent to piping

5.17.3.2. When welding or cutting is to be carried out near piping containing flammable gas, the section of the piping located within 1 m of the torch shall be covered with wet noncombustible insulating material 6 mm thick.

Work on containers

5.17.3.3.(1) Welding or cutting of metal containers shall not be undertaken until the containers and compartments within such containers have been cleaned of flammable and combustible materials and checked with an explosion meter.

(2) Welding or cutting operations shall not be undertaken on a totally enclosed container.

Portable extinguishers

(3) Suitable portable extinguishers shall be provided in conformance with Section 6.2 where welding or cutting operations take place.

SECTION 5.18 INDUSTRIAL OVENS FOR BAKING AND DRYING PROCESSES

Subsection 5.18.1. Application

Application

5.18.1.1. This Section applies to industrial baking and drying ovens which during operation contain flammable vapours given off by the products being baked or dried.

Subsection 5.18.2. Location

5.18.2.1. Ovens shall not be located in any storey of a building below grade.

Subsection 5.18.3. Construction

Oven materials

5.18.3.1. Industrial ovens shall be constructed of noncombustible materials with smooth interior surfaces to permit cleaning.

Limiting temperature on combustible construction

5.18.3.2. The roof and floor of ovens and heaters and associated ductwork shall have sufficient clearance or be insulated where necessary to prevent the temperature from exceeding 90°C at any combustible part of the building assembly.

Explosion vents

5.18.3.3.(1) Explosion vents shall be provided for ovens where fuel or vapour hazards are present.

(2) Explosion vents shall be designed in conformance with NFPA 91-1973, "Blower and Exhaust Systems" and shall have a venting ratio

- (a) of 0.2 m² of vent area for each cubic metre of oven volume, or
- (b) computed in accordance with NFPA 68-1978, "Guide for Explosion Venting", except in no case less than 650 cm² of vent area for each cubic metre of oven volume.

(3) Openings or access doors equipped with explosion release hardware shall be acceptable as explosion vents.

Duct and stack restrictions

5.18.3.4.(1) Ducts, stacks and associated insulation in systems for the removal of flammable vapours shall

- (a) be constructed of noncombustible materials,
- (b) not pass through firewalls, and
- (c) not discharge within 1.5 m of windows or within 6 m of other air intake openings.

Subsection 5.18.4. Ventilation

Oven ventilation

5.18.4.1. Ovens in which flammable vapours may be present or through which products of combustion are circulated shall be ventilated in accordance with NFPA 86A-1978, "Ovens and Furnaces".

Fan interlocks

5.18.4.2. Where flammable vapours may be present in ovens, interlocks shall be provided to ensure that energy sources and ignition devices are de-activated when the ventilating fans stop or the excess temperature controls are activated.

5.18.4.3. Where flammable vapours may be present in continuous process ovens, interlocks shall be provided to ensure that ventilating fans are operating before conveyors can be started and that the stopping of ventilating fans or activation of the excess temperature controls will stop the conveyors.

Subsection 5.18.5. Maintenance

Cleaning of ovens and ductwork

5.18.5.1.(1) Ovens and associated ductwork shall be inspected, cleaned and maintained at intervals sufficient to prevent the accumulation of combustible deposits.

(2) Access doors or panels shall be provided to permit inspection, cleaning and maintenance of ovens and associated ductwork.

(3) Fixed noncombustible ladders, steps or grab rails shall be provided to permit access to the doors or panels required in Sentence (2).

Subsection 5.18.6. Fire Protection

Portable extinguishers

5.18.6.1. Portable extinguishers shall be provided in conformance with Part 6.

Standpipe and hose systems

5.18.6.2. A standpipe and hose system shall be installed in conformance with the **Building Code** and equipped with shutoff spray nozzles so that all parts of an oven structure can be reached by a hose stream.

Fire access doors

5.18.6.3. Doors or other means of access shall be provided in ovens and associated ductwork so that portable extinguishers or hose streams may be used in all parts of the equipment.

5.18.6.4. Ovens containing or processing sufficient combustible materials to sustain a continuously burning fire shall be equipped with automatic sprinklers or other fixed fire extinguishing systems.

PART 6 FIRE PROTECTION EQUIPMENT

TABLE OF CONTENTS

SECTION 6.1	GENERAL
Subsection 6.1.1.	Scope

SECTION 6.2	PORTABLE EXTINGUISHERS
Subsection 6.2.1.	General
Subsection 6.2.2.	Classification
Subsection 6.2.3.	Selection Requirements
Subsection 6.2.4.	Installation Requirements
Subsection 6.2.5.	Grading of Hazards
Subsection 6.2.6.	Distribution
Subsection 6.2.7.	Inspection, Testing and Maintenance

SECTION 6.3	FIRE ALARM AND VOICE COMMUNICATION SYSTEMS FOR LIFE SAFETY
Subsection 6.3.1.	General
Subsection 6.3.2.	Check, Inspect and Test

SECTION 6.4	STANDPIPE AND HOSE SYSTEMS
Subsection 6.4.1.	General
Subsection 6.4.2.	Maintenance and Inspection of Hose Stations and Equipment
Subsection 6.4.3.	Testing

SECTION 6.5	SPRINKLER SYSTEMS
Subsection 6.5.1.	General
Subsection 6.5.2.	Sprinkler System Shutdowns
Subsection 6.5.3.	Checking
Subsection 6.5.4.	Inspection
Subsection 6.5.5.	Testing
Subsection 6.5.6.	Maintenance

SECTION 6.6	WATER SUPPLIES FOR FIRE PROTECTION
Subsection 6.6.1.	General
Subsection 6.6.2.	Tanks
Subsection 6.6.3.	Fire Pumps and Reservoirs
Subsection 6.6.4.	Hydrants
Subsection 6.6.5.	Inspection of Hydrants
Subsection 6.6.6.	Uniform Marking of Hydrants

SECTION 6.7	EMERGENCY POWER SYSTEMS
Subsection 6.7.1.	General

SECTION 6.8	SPECIAL EXTINGUISHING SYSTEMS
Subsection 6.8.1.	General

SECTION 6.1 GENERAL

Subsection 6.1.1. Scope

Scope

6.1.1.1. This Part provides for the installation, inspection, testing, maintenance and operation of portable extinguishers and the inspection, testing, maintenance and operation of fire alarm systems and voice communication systems, standpipe and hose systems, automatic sprinkler systems, special extinguishing systems, water supplies for fire protection and emergency power installations. (See also Part 7)

SECTION 6.2 PORTABLE EXTINGUISHERS

Subsection 6.2.1. General

6.2.1.1. Only ULC labelled portable extinguishers shall be installed when replacing or adding new extinguishers.

Maintenance

6.2.1.2. Portable extinguishers shall be kept operable and fully charged.

Location

6.2.1.3.(1) Portable extinguishers shall be located so that they are easily seen and shall be accessible at all times.

(2) A lockable, break-front glazed cabinet may be used for security purposes to store portable extinguishers and where portable

extinguishers are located in a fire hose cabinet, an approved lockable, scored glass break-front cabinet may be used.

6.2.1.4. Portable extinguishers shall be located in or adjacent to corridors or aisles that provide access to exits.

Signs

6.2.1.5. The location of portable extinguishers shall be prominently indicated by signs or markings in large floor areas and in locations where visual obstructions cannot be avoided.

6.2.1.6. Portable extinguishers in proximity to a fire hazard shall be located in a position so as to be accessible without exposing the operator to undue risk.

Corrosive atmosphere

6.2.1.7. Portable extinguishers that are subject to damage in a corrosive atmosphere shall not be installed where a corrosive atmosphere exists unless supplementary corrosion protection that will protect the portable extinguishers is provided.

Temperature range requirements

6.2.1.8.(1) Where a portable extinguisher is to be located in an area subject to temperatures outside the range 4°C to 49°C it shall be

- placed in an enclosure where the temperature is maintained within this range, or
- of a type labelled for the temperatures to which it will be exposed.

Mounting brackets

6.2.1.9. When portable extinguishers are located on vehicles or in areas where they are subject to jarring or vibration, brackets designed to accommodate these effects shall be used.

Subsection 6.2.2. Classification

Rating of extinguishers

6.2.2.1. Portable extinguishers shall be rated and identified in conformance with National Standard of Canada CAN 4-S508-76 (ULC-S508-1975), "Rating and Fire Testing of Fire Extinguishers".

Subsection 6.2.3. Selection Requirements

Multiple ratings

6.2.3.1. Where portable extinguishers have been tested and are rated as being acceptable for fighting more than one class of fire, each class of fire for which they are acceptable shall be designated on each extinguisher.

Subsection 6.2.4. Installation Requirements

Where required

6.2.4.1.(1) Portable extinguishers shall be installed in every building.

(2) The requirements of Sentence (1) do not apply to dwelling units.

Distance above floor

6.2.4.2. Portable extinguishers with a gross weight greater than 18 kg shall be installed so that the top of the extinguisher is not more than 1.1 m above the floor when the extinguisher is not equipped with wheels.

6.2.4.3. Portable extinguishers having a gross weight of 18 kg or less shall be installed so that the top of the extinguisher is not more than 1.5 m above the floor.

Operating instructions

6.2.4.4. The operating instructions of portable extinguishers shall

face outward when the extinguishers are located in cabinets, in wall recesses or on shelves.

Subsection 6.2.5. Grading of Hazards

Light hazard occupancy

6.2.5.1. Where the quantity of combustible material present is such that fires of small size may be expected, such as in offices, schoolrooms, churches, assembly halls and telephone exchanges, the occupancy shall be graded as light hazard.

Ordinary hazard occupancy

6.2.5.2. Where the quantity of combustible material present is such that fires of moderate size may be expected, such as in mercantile occupancies, display rooms, auto showrooms, parking garages, light manufacturing, warehouses not classified as extra hazard and school shop areas, the occupancy shall be graded as ordinary hazard.

Extra hazard occupancy

6.2.5.3. Where the quantity of combustible material present is such that fires of severe magnitude may be expected, such as in woodworking, auto repair, aircraft servicing, mercantile storage areas, warehouses with high-piled combustibles and processes incorporating flammable liquids, the occupancy shall be graded as extra hazard.

Subsection 6.2.6. Distribution

6.2.6.1.(1) Portable extinguishers shall be provided to protect the building and each hazardous occupancy in the building in conformance with this Subsection.

(2) Despite Sentence (1), in an unoccupied warehouse equipped with a fixed fire protection system, provision shall be made for portable extinguishers to be available for use by responding personnel.

(3) The location and number of portable extinguishers required under Sentence (2) shall be approved.

Building protection

6.2.6.2. Portable extinguishers that are provided to protect a building shall be suitable for fighting Class A fires and be available for use at all times.

Occupancy protection

6.2.6.3. Portable extinguishers that are provided to protect a hazardous occupancy shall be those required in this Section for fighting Class A, B, C or D fires.

Extinguishers for Class A fires

6.2.6.4. Except as required in Article 6.2.6.5., portable extinguishers for Class A fires shall be provided in conformance with Table 6.2.6.A.

6.2.6.5. Where a floor area is less than that shown in Table 6.2.6.A., one portable extinguisher not less than the minimum size permitted shall be provided.

TABLE 6.2.6.A.

Forming part of Article 6.2.6.4.

Basic Minimum Extinguisher Rating for Area Specified	Maximum Travel Distance to Extinguisher, m	Maximum Area to be Protected per Extinguisher for Class A Fires, m ²		
		Light Hazard Occupancy	Ordinary Hazard Occupancy	Extra Hazard Occupancy
1A	25	300	Not Acceptable	Not Acceptable
2A	25	600	300	Acceptable
3A	25	900	400	300
4A	25	1 100	600	400
6A	25	1 100	900	600
10A	25	1 100	1 100	900
20A	25	1 100	1 100	1 100
40A	25	1 100	1 100	1 100
Column 1	2	3	4	5

Hose stations in lieu of extinguishers

6.2.6.6. Up to ½ of the number of portable extinguishers required in Table 6.2.6.A. may be replaced by hose stations.

Extinguishers for Class B fires

6.2.6.7. Except as provided in Article 6.2.6.8., portable extinguishers for Class B fires shall be provided as required in Table 6.2.6.B.

6.2.6.8.(1) Where up to 3 portable extinguishers rated for Class B fires are used to satisfy the extinguisher rating specified in Table 6.2.6.B., the sum of the basic extinguisher ratings shall satisfy the requirements in Table 6.2.6.B.

(2) No more than 3 portable extinguishers shall be used to satisfy the requirements of Table 6.2.6.B.

TABLE 6.2.6.B.

Forming part of Article 6.2.6.7.

Grade of Hazard	Basic Minimum Extinguisher Rating per Unit	Maximum Travel Distance to Extinguishers, m
Light	5B	9
	10B	15
Ordinary	10B	9
	20B	15
Extra	20B	9
	40B	15
Column 1	2	3

Extinguishers for flammable and combustible liquids in open containers

6.2.6.9. Portable extinguishers for Class B fires shall be provided for flammable and combustible liquid hazards when such flammable or combustible liquids are stored in open containers to a depth greater than 6 mm and shall provide at least one numerical unit of extinguishing potential for Class B fires per 0.1 m² of surface area of the largest open container within the area.

6.2.6.10.(1) Where up to 3 foam-type portable extinguishers rated for Class B fires are used to satisfy the requirements of Article 6.2.6.9., the sum of the basic extinguisher ratings shall satisfy the requirements in Table 6.2.6.B.

(2) No more than 3 portable extinguishers shall be used to satisfy the requirements of Table 6.2.6.B.

Supplementary protection

6.2.6.11. Portable extinguishers shall supplement fixed fire protection in Part 5 in accordance with Article 6.2.6.9, where a **flammable or combustible liquid** is stored in an open container and where the liquid surface area exceeds 0.4 m².

Extinguishers for commercial cooking equipment

6.2.6.12. Alkali base, dry chemical portable extinguishers shall be provided to protect commercial cooking equipment.

Extinguishers for Class C fires

6.2.6.13. Portable extinguishers suitable for **Class C fires** shall be provided in or near service rooms containing electrical equipment.

Distribution

6.2.6.14. Distribution of portable extinguishers for **Class C fires** shall conform to the applicable provisions for the distribution of extinguishers for **Class A** or **Class B fires** in the vicinity of the electrical equipment.

6.2.6.15. Reference shall be made to Parts 2, 3, 4 and 5 for requirements of portable extinguishers for **flammable and combustible liquids**, hazardous materials, processes and operations.

Subsection 6.2.7. Inspection, Testing and Maintenance

6.2.7.1.(1) Except as set out in Sentence (2), maintenance and testing of portable extinguishers shall be in conformance with NFPA 10-1978, "Portable Fire Extinguishers".

(2) The requirements in Article 5-1.4. and in Note 1 to Table 5-3 of NFPA 10-1978 do not apply.

Examination

6.2.7.2. Portable extinguishers shall be **inspected** monthly.

Defective extinguishers

6.2.7.3. Portable extinguishers having defects shall be repaired or recharged where necessary.

Tags

6.2.7.4. Each portable extinguisher shall have a tag securely attached to it showing the maintenance or recharge date, the servicing agency and the signature of the person who performed the service.

Maintenance records

6.2.7.5. A permanent record containing the maintenance date, the examiner's name and a description of any maintenance work or hydrostatic **testing** carried out shall be prepared and maintained for each portable extinguisher.

Maintenance after use

6.2.7.6. Portable extinguishers shall be replaced and recharged after use in conformance with instructions given on the extinguisher nameplate.

6.2.7.7. Extinguisher shells, cartridges or cylinders that show leakage or permanent distortion in excess of specified limits or that rupture shall be removed from service.

6.2.7.8. Hydrostatic pressure **tests** shall be conducted at the original test pressure as stated on the nameplate.

Test labels

6.2.7.9.(1) Where a portable extinguisher is **tested**, a label shall be fixed to the extinguisher after **testing** that indicates the month and year the hydrostatic pressure **test** was performed, the test pressure used and the name of the person or agency performing the **test**.

(2) Sentence (1) does not apply where a permanent record of the **test** is kept and is available to the **fire department**.

SECTION 6.3 FIRE ALARM AND VOICE COMMUNICATION SYSTEMS FOR LIFE SAFETY

Subsection 6.3.1. General

Access

6.3.1.1. Access to fire alarm and voice communication system components requiring **inspection** or servicing shall be kept unobstructed.

6.3.1.2. Proprietary signalling systems shall be maintained in accordance with NFPA 72D-1975, "Installation, Maintenance and Use of Proprietary Protective Signalling Systems for Guard, Fire Alarm and Supervisory Service".

6.3.1.3. When a fire alarm or voice communication system or any part thereof is shut down, the **supervisory staff** shall be notified in accordance with Section 2.8.

6.3.1.4. Fire alarm and voice communication systems shall be maintained in operating condition.

Signal silencing

6.3.1.5.(1) Once activated, a fire alarm system shall not be manually silenced unless it has been confirmed by **supervisory staff**, in accordance with **approved** procedures as detailed in the fire safety plan, that no fire emergency exists.

(2) Sentence (1) does not apply where a silencing switch is part of an **approved** integrated voice communication system and signal silencing takes place to allow fire emergency instructions to be heard.

Subsection 6.3.2. Check, Inspect and Test

Intervals between tests

6.3.2.1. Fire alarm systems shall be subject to the requirements of Section 4: "Periodic Testing of Fire Alarm Systems", of ULC-S536-1979, "Standard for the Testing, Inspection and Maintenance of Existing Fire Alarm Systems".

Central alarm and control facilities

6.3.2.2. The central alarm and control facility shall be **checked** daily to ensure that no trouble is indicated in the system.

Voice communication systems

6.3.2.3.(1) Voice communication to and from floor areas to the central alarm and control facility shall be **tested** monthly and yearly as required for fire alarm initiating devices, as prescribed in Article 6.3.2.1.

(2) Loudspeakers operated from the central alarm and control facility shall be **tested** monthly and yearly as required for fire alarm audible signalling devices, as prescribed in Article 6.3.2.1.

(3) A voice communication system is not required to be **tested** in conformance with Sentences (1) and (2) where the system is used as part of a paging system.

SECTION 6.4 STANDPIPE AND HOSE SYSTEMS

Subsection 6.4.1. General

6.4.1.1. During alteration of a **building** required to have a standpipe and hose system, the system shall be installed or dismantled progressively so as to provide protection to all **floor areas**.

6.4.1.2. Standpipe and hose systems shall be maintained in operating condition.

Fire department connections

6.4.1.3.(1) **Fire department** connections shall be equipped with plugs or caps secured wrench tight.

(2) Plugs or caps shall be removed annually and the threads **inspected** for wear, rust or obstruction.

Out of service requirements

6.4.1.4. When the standpipe and hose system or any part thereof is shut down, the **supervisory staff** shall be notified in accordance with Section 2.8.

Subsection 6.4.2. Maintenance and Inspection of Hose Stations and Equipment

Hose stations

6.4.2.1. Hose stations shall be **inspected** monthly to ensure that the hose is in proper position and that all of the equipment is in place and in operable condition.

6.4.2.2. Standpipe and hose system equipment shall be used for fire protection only.

6.4.2.3. Standpipe hose stations shall be conspicuously identified and unobstructed.

Hose valves

6.4.2.4. Hose valves shall be **inspected** annually to ensure that they are tight so that there is no water leakage into the hose.

Hose

6.4.2.5.(1) Standpipe hose shall be **inspected** and re-racked annually and after use, and any worn hose or gaskets in the couplings at the hose valves and at the nozzle replaced.

(2) When hose is re-racked as required in Sentence (1), it shall be done so that any folds will not occur at the same places.

Dry standpipe identification

6.4.2.6. Each hose connection in a dry standpipe system shall be provided with a legible weatherproof sign reading: "DRY STANDPIPE FOR FIRE DEPARTMENT USE ONLY".

Subsection 6.4.3. Testing

Standpipe systems

6.4.3.1.(1) Standpipe systems that have been modified, extended or are being restored to service after a period of disuse exceeding 1 year shall be **tested** in conformance with Articles 6.4.3.2. to 6.4.3.5.

(2) Where standpipe connections are built in walls or **partitions**, the tests shall be made before the standpipes are concealed.

6.4.3.2. Standpipe system piping shall be hydrostatically **tested** at a pressure of not less than 1400 kPa (gauge) for 2 hr, or at 350 kPa (gauge) in excess of the normal hydrostatic pressure when the normal hydrostatic pressure is in excess of 1050 kPa (gauge).

Fire department connections

6.4.3.3. Piping between the **fire department** connection and the check valve in the inlet pipe to the standpipe shall be **tested** in the same manner as the remainder of the system.

Underground mains

6.4.3.4.(1) Underground mains and connections shall be **tested** for 2 hr at a hydrostatic pressure of 350 kPa (gauge) in excess of the maximum hydrostatic pressure in service but not less than 1400 kPa (gauge).

(2) Leakage during the **test** shall not exceed 2 L per hour per 100 joints for pipe laid with rubber gasketed joints, and 30 mL per hour per 25 mm of pipe diameter per joint for pipe laid with caulked lead or lead substitute joints.

Flow and pressure tests

6.4.3.5. Flow and pressure tests shall be conducted at the highest and most remote hose valve or hose connection to ensure that the water supply for standpipes is provided as originally designed.

Dry standpipes

6.4.3.6. Standpipe system piping which normally remains dry shall be **tested** in conformance with Article 6.4.3.2. at intervals of not more than 5 years.

SECTION 6.5 SPRINKLER SYSTEMS

Subsection 6.5.1. General

6.5.1.1. Repair, replacement and alterations of sprinkler system components shall be in accordance with NFPA 13-1983, "Standard for Installation of Sprinkler Systems".

6.5.1.2. Sprinkler systems shall be maintained in operating condition.

Closing sprinkler control valves

6.5.1.3. Sprinkler control valves shall not be closed in the event of a fire until the fire is extinguished or is considered to be under control by other means, as determined by the **fire department** or by an industrial fire brigade established by the owner in consultation with the **fire department**.

Changes in equipment or occupancy

6.5.1.4. Changes in equipment or **occupancy**, that might result in temperatures at sprinklers being more than 38°C or less than 4°C with wet pipe systems, shall not be made without previously making provisions to alter the sprinkler system to prevent premature operation or freezing.

Obstructions

6.5.1.5.(1) No obstructions shall be placed so as to interfere with the effectiveness of water discharge from sprinklers.

(2) Sprinkler systems shall not be used to support anything that will interfere with effective sprinkler system performance.

6.5.1.6.(1) Where alterations or repairs are made to feed mains, cross mains, or risers in existing systems, sprinkler systems shall be **tested** in conformance with Sentences (2) to (8).

(2) Except as permitted in Sentence (4), the sprinkler system shall be subjected to a hydrostatic pressure **test** of a minimum of 1400 kPa (gauge), or 350 kPa (gauge) in excess of the maximum static pressure to which the system may be subjected, for a period of 2 hr without loss of pressure.

Dry-pipe system testing

(3) For dry-pipe systems, the clapper of the differential type dry-pipe valve shall be held off its seat, and the ball drip in the intermediate chamber shall be replaced by a plug during the **test**.

Air testing

(4) At seasons of the year that will not permit hydrostatic pressure **testing**, the sprinkler system shall be pressure **tested** with air at 350 kPa (gauge) for 2 hr without loss of pressure, and the tests described in Sentence (2) performed when hydrostatic pressure **testing** can be performed without danger of freezing.

(5) Sprinkler system water pressure shall be **tested** with the main drain valve fully open.

(6) Drainage facilities shall be **tested** to ensure that the drains are capable of taking the full flow from the main drain pipe without overflowing.

Dry-pipe valve testing

(7) Dry-pipe valves shall be **tested** to ensure that they are in operative condition.

Alarm testing

(8) Mechanical and electrical alarms shall be **tested** to ensure that they are in operative condition.

6.5.1.7.(1) When alterations or additions are made to underground mains and lead-in connections of an existing sprinkler system, the mains and lead-in connections shall be **tested** by

- (a) flushing for sufficient time to remove foreign material at a minimum water flow as specified in Table 6.5.1.A., and

Pressure testing of underground mains

- (b) a 2 hr hydrostatic pressure test of 350 kPa (gauge) in excess of the maximum static pressure, but not less than 1400 kPa (gauge) and leakage shall not exceed 2 L per hour per 100 joints for pipe laid with rubber gasketed joints, and 30 mL per hour per 25 mm of pipe diameter per joint for pipe laid with caulked lead or lead substitute joints.

TABLE 6.5.1.A.

Forming part of Article 6.5.1.7.

Size of Pipe, mm	Minimum Flow, L/s
150	40
200	65
250	90
300	130
Column 1	2

(2) At seasons of the year that will not permit hydrostatic pressure **testing**, the procedure outlined in Sentence 6.5.1.6.(4) may be followed.

Records

6.5.1.8.(1) An **approved** record shall be kept of **inspections** of each system.

(2) The record required in Sentence (1) shall be available for examination by the **Chief Fire Official**.

6.5.1.9. If any device in a sprinkler system does not operate or appear to operate properly when **checked, inspected or tested**, it shall be repaired or replaced.

Subsection 6.5.2. Sprinkler System Shutdowns

Notification

6.5.2.1. When any alterations, additions or repairs are to be made involving interruption to a sprinkler system or part thereof, the **Chief Fire Official** shall be notified.

6.5.2.2. Sprinkler control valves and sprinkler water supplies shall not be shut down, disconnected or otherwise impaired for more than 24 hours without notifying the **Chief Fire Official**.

6.5.2.3. Where it is required to temporarily shut down a sprinkler system or part thereof, the work shall be programmed by the contractor working on the system to enable the sprinkler system to be operational as quickly as possible in the circumstances.

Programmed repairs

6.5.2.4. When a sprinkler system or part thereof is shut down, the **supervisory staff** shall be notified in accordance with Section 2.8.

Additional protection during shutdowns

6.5.2.5. Full sprinkler protection shall be restored or the provisions of Article 6.5.2.6. maintained when work on the system is discontinued.

Identification of closed valves

6.5.2.6. Closed sprinkler control valves shall be tagged or identified in an **approved** manner.

Subsection 6.5.3. Checking

Sprinkler control valves

6.5.3.1. Valves, except for electrically supervised valves, controlling water supplies to sprinklers and alarm connections shall be **checked** weekly to ensure that they are in the open position.

6.5.3.2. Exposed sprinkler piping hangers shall be **checked** yearly to ensure that they are kept in good repair.

Dry-pipe system maintenance

6.5.3.3. Air pressure in dry-pipe systems shall be **checked** weekly by using gauges to ensure that the system is maintained at the required operating pressure.

6.5.3.4. Dry-pipe valve rooms or enclosures in unheated **buildings** shall be **checked** as often as necessary when the outside temperature falls below 0°C to ensure that the system does not freeze.

Sprinkler inspection

6.5.3.5.(1) Sprinkler heads shall be **checked** at least once per year to ensure that they are free from damage, corrosion, grease, dust, paint or whitewash.

(2) Sprinkler heads that are identified as inoperable in Sentence (1) shall be replaced where necessary as a result of such conditions.

Subsection 6.5.4. Inspection

Winter damage

6.5.4.1. Auxiliary drains shall be **inspected** to prevent freezing.

Test flushing

6.5.4.2. Dry-pipe systems shall be **inspected** every 15 years for obstructions in the sprinkler piping and, if necessary, the entire system flushed of foreign material.

Priming water level

6.5.4.3. The priming water for dry-pipe systems shall be **inspected** annually to ensure that the proper level above the dry-pipe valve is maintained.

6.5.4.4.(1) **Fire department** connections shall be equipped with plugs or caps secured wrench tight.

(2) Plugs or caps shall be removed annually and the threads **inspected** for wear, rust or obstruction.

Subsection 6.5.5. Testing

Notification

6.5.5.1. Prior notification of waterflow or other tests to be made to a sprinkler system shall be given to parties who could be affected by an alarm.

6.5.5.2. An alarm test using the alarm test connection located at the sprinkler valve shall be performed monthly on sprinkler systems.

Waterflow alarm tests

6.5.5.3. Waterflow alarm tests using the most hydraulically remote test connection shall be performed annually on wet sprinkler systems.

Trip testing of valves

6.5.5.4. Dry-pipe valves shall be trip tested annually by means of the system test pipe to ensure that they operate satisfactorily and that the sprinkler alarms are in operating condition.

Water supply

6.5.5.5. Sprinkler system water pressure shall be tested annually with the main drain valve fully open to ensure that there are no obstructions or deterioration of the main water supply.

6.5.5.6. The test prescribed in Article 6.5.5.5. shall be conducted after any sprinkler system control valve has been operated.

Electrical supervisory signal testing

6.5.5.7.(1) Where an electrical supervisory signal service is provided for a sprinkler system, it shall be tested in conformance with Sentences (2) and (3).

(2) Transmitters and waterflow actuated devices shall be tested every 2 months.

(3) Valve supervisory switches, tank water level devices, building and tank water temperature supervisory devices and other sprinkler system supervisory devices shall be tested at least every 6 months.

Subsection 6.5.6. Maintenance

Sprinkler guards

6.5.6.1. Sprinklers shall be protected by sprinkler guards where there is the possibility of mechanical damage.

6.5.6.2. Sprinkler control valves shall be accessible and maintained in operable condition at all times.

6.5.6.3. Pits containing sprinkler control valves shall be kept free of water and protected against freezing.

Precautions against freezing

6.5.6.4.(1) Except as permitted in Sentence (2), sections of sprinkler systems subject to freezing shall be converted to a dry-pipe or antifreeze system with a separate control valve for that part of the system.

(2) Alternative methods to prevent freezing of sprinkler piping may be used where approved.

Spare sprinkler heads

6.5.6.5.(1) Where sprinkler systems are installed, a supply of spare sprinkler heads and equipment shall be maintained in conformance with Sentences (2) to (5).

(2) Spare sprinkler heads shall be kept in a cabinet where the temperature does not exceed 38°C.

(3) The minimum stock of spare sprinkler heads to be kept on hand shall be

- (a) 6 sprinkler heads for installations containing not more than 300 sprinklers,
- (b) 12 sprinkler heads for installations containing from 301 to 1000 sprinklers, and
- (c) 24 sprinkler heads for installations containing more than 1000 sprinklers.

(4) Spare sprinkler heads shall correspond to the types and temperature ratings of the sprinklers installed on the system.

Sprinkler wrench

(5) A wrench suitable for replacing sprinkler heads shall be kept in the cabinet where the spare sprinkler heads are stored.

SECTION 6.6 WATER SUPPLIES FOR FIRE PROTECTION

Subsection 6.6.1. General

6.6.1.1. Private and public water supplies for fire protection installations shall be maintained to provide the required flow under fire conditions.

Valve inspections

6.6.1.2. Valves controlling water supplies used exclusively for fire protection systems shall be inspected weekly to ensure that they are wide open and are sealed or locked in that position.

Ice accumulations

6.6.1.3. Water supply systems used for fire protection shall be kept free of ice accumulations that may interfere with flow.

Antifreeze pumping systems

6.6.1.4. Where antifreeze solutions are used to maintain pumping systems operable under freezing conditions, the specific gravity shall be such that the solution will remain unfrozen at a temperature of 8°C below the expected minimum temperature of the surrounding atmosphere.

Subsection 6.6.2. Tanks

Tank inspections

6.6.2.1. An annual inspection shall be made of tanks for fire protection, tank supporting structures and water supply systems including piping, control valves, check valves, heating systems, mercury gauges and expansion joints to ensure that they are in operating condition.

Tank heating equipment

6.6.2.2. Tank heating equipment and accessories shall be checked daily during freezing weather to ensure that they are in operating condition and that heater valves are open.

Water temperature checks

6.6.2.3. A daily check of the temperature of the water contained in tanks shall be carried out during freezing weather to ensure that it does not fall below the freezing temperature.

Tank enclosure temperature checks

6.6.2.4. A daily check of the temperature of the tank enclosure for tanks in buildings shall be carried out during freezing weather to ensure that the temperature of the tank enclosure does not fall below 0°C.

Check for corrosion

6.6.2.5. Steel and iron work including the inside and outside of steel tanks and hoops and grillages for wooden tanks shall be checked for corrosion at intervals of at least 2 years and scraped and repainted as required.

Inspection for sediment

6.6.2.6.(1) Tanks, other than tanks supplied by a potable water supply, shall be inspected for accumulations of sediment at least every 2 years and cleaned as required.

(2) Tanks supplied by a potable water supply shall be inspected every 5 years and scraped and repainted as required.

Inspection of cathodic protection

6.6.2.7. Where cathodic protection equipment is installed to prevent corrosion of steel tanks, the equipment shall be inspected annually.

Water level in gravity tanks

6.6.2.8. The water level in gravity tanks shall be inspected monthly.

Gravity tanks

6.6.2.9. Gravity tanks shall be **inspected** annually to ensure that the tank roof is tight and in good repair, that hatches or doors are kept closed and properly secured and that the frostproof casing of the tank riser makes a tight joint with the bottom of the tank.

6.6.2.10. The space between overflow pipes and the tops of gravity tanks, the valve pits at the bottoms of the risers and the entire area around the bases of the columns of tanks shall be kept free of rubbish and waste materials.

6.6.2.11. Gravity tank expansion joints shall be repacked and adjusted if binding or leaks develop.

Pressure tanks

6.6.2.12. The water level and air pressure for pressure tanks shall be **checked** weekly.

6.6.2.13. Relief valves on the air and water supply lines of pressure tanks shall be **inspected** weekly.

Subsection 6.6.3. Fire Pumps and Reservoirs

Fire pump reservoirs

6.6.3.1. The water level in the fire pump reservoir shall be **checked** weekly.

Pump room temperature

6.6.3.2. The temperature of pump rooms shall be **checked** daily during freezing weather.

Inspection of fire pumps

6.6.3.3.(1) Fire pumps shall be operated at least once per week at rated speed.

(2) The fire pump discharge pressure, suction pressure, lubricating oil level, operative condition of relief valves, priming water level and general operating conditions shall be **inspected** during the weekly operation of fire pumps.

Internal combustion engine inspection

6.6.3.4.(1) Internal combustion engine fire pumps shall be operated once a week for a sufficient time to bring the engine up to normal operating temperature.

(2) The storage batteries, lubrication systems, oil and fuel supplies shall be **inspected** once a week.

Fire pump flow tests

6.6.3.5. Fire pumps shall be **tested** annually at full rated capacity to ensure that they are capable of delivering the rated flow.

6.6.3.6.(1) Records shall be kept of fire pump flow tests.

(2) The records required in Sentence (1) shall be available for inspection by the **Chief Fire Official**.

Subsection 6.6.4. Hydrants

Hydrants

6.6.4.1. Municipal and private hydrants shall be maintained in operating condition.

6.6.4.2. Hydrants shall be maintained free of snow and ice accumulations.

6.6.4.3. Hydrants shall be readily available and unobstructed for use at all times.

Subsection 6.6.5. Inspection of Hydrants

6.6.5.1. Hydrants shall be **inspected** annually and after each use in accordance with Articles 6.6.5.2. to 6.6.5.5.

6.6.5.2. The port caps on hydrants shall be removed and the threads **inspected** for wear, rust or other obstructions and resecured at the end of the inspection.

6.6.5.3. The hydrant barrel shall be **inspected** to ensure that no water has accumulated within the barrel when the main valve is in the closed position.

6.6.5.4. Where the hydrant barrel is found to contain water under Article 6.6.5.3., the drain valve shall be **inspected** for operation.

6.6.5.5. Where the hydrant barrel is found to contain water because of poor drainage that cannot be corrected, provisions shall be made to prevent freezing during winter conditions.

Hydrant water flow

6.6.5.6. Hydrant water flow shall be **inspected** annually in accordance with Article 6.6.5.7.

6.6.5.7. The main valve of the hydrant shall be fully opened and the hydrant operated with one port open and the water flow **checked**.

6.6.5.8. A record of the hydrant operation as described in Article 6.6.5.7. shall be kept in conformance with Article 1.1.2.1.

Subsection 6.6.6. Uniform Marking of Hydrants

Hydrant marking

6.6.6.1. Hydrants shall be colour-coded in accordance with NFPA 291-1977, "Fire Flow Testing and Marking of Hydrants".

SECTION 6.7 EMERGENCY POWER SYSTEMS

Subsection 6.7.1. General

6.7.1.1.(1) Except as provided in Articles 6.7.1.2. to 6.7.1.5., emergency power systems shall be **inspected, tested** and maintained in conformance with CSA C282-1977, "Emergency Electrical Power Supply for Buildings".

(2) When an emergency power system or any part thereof is shut down, the **supervisory staff** shall be notified in accordance with Section 2.8.

Instructions for switching and starting

6.7.1.2. Where an emergency power system is installed, instructions shall be provided for switching on essential loads and for starting the generator when this is not done automatically.

Inspection and testing

6.7.1.3. Despite the requirements of Article 1.1.2.1., written records shall be maintained as required in CSA C282-1977, "Emergency Electrical Power Supply for Buildings".

Fuel supply

6.7.1.4. The amount of fuel stored and connected to the emergency power system shall be sufficient to operate the engine for 8 hr.

6.7.1.5.(1) Liquid fuel **storage tanks** shall be drained and refilled with a fresh supply at least once a year.

(2) The requirements of Sentence (1) may be achieved by replenishment as the result of the normal weekly test program required in Article 6.7.1.1.

SECTION 6.8 SPECIAL EXTINGUISHING SYSTEMS

Subsection 6.8.1. General

Inspection and maintenance

6.8.1.1.(1) Except as otherwise provided in this Section, where

special extinguishing systems have been installed, **inspection** and maintenance shall be provided in conformance with the appropriate Standards listed in Clauses (a) to (i):

- (a) NFPA 11-1983, "Low Expansion Foam and Combined Agent Systems",
- (b) NFPA 11A-1976, "High Expansion Foam Systems",
- (c) NFPA 12-1980, "Carbon Dioxide Extinguishing Systems",
- (d) NFPA 12A-1980, "Halon 1301 Fire Extinguishing Systems",
- (e) NFPA 12B-1980, "Halon 1211 Fire Extinguishing Systems",
- (f) NFPA 15-1979, "Water Spray Fixed Systems for Fire Protection",
- (g) NFPA 16-1980, "Deluge Foam-Water Sprinkler Systems and Foam-Water Spray Systems",
- (h) NFPA 17-1980, "Dry Chemical Extinguishing Systems", or
- (i) NFPA 18-1979, "Wetting Agents".

(2) When a special extinguishing system or any part thereof is shut down, the **supervisory staff** shall be notified in accordance with Section 2.8.

Test records

6.8.1.2. Written records shall be kept of **inspections**, maintenance and **testing** in conformance with Article 1.1.2.1.

Operating and maintenance instructions

6.8.1.3. Operating and maintenance instructions shall be posted in proximity to the equipment and located near manual controls when the controls are provided.

Valves and controls

6.8.1.4. Valves and controls shall be marked to clearly indicate their function and be accessible at all times.

Container maintenance

6.8.1.5. Extinguishing agent containers provided for special extinguishing systems shall be fully charged with the proper quantity of extinguishing agent and the necessary operating pressure maintained.

Discharge outlets

6.8.1.6. Discharge outlets for special extinguishing systems shall be kept free of dirt and residue.

Piping

6.8.1.7. Piping and equipment shall be mechanically secure and accessible for cleaning and maintenance.

Replacement equipment

6.8.1.8. No replacement equipment and devices provided for special extinguishing systems shall be used unless suitable for the installation in which they are to be placed.

PART 7 INSPECTION, TESTING AND MAINTENANCE OF FIRE EMERGENCY SYSTEMS IN HIGH BUILDINGS

TABLE OF CONTENTS

SECTION 7.1	GENERAL
Subsection 7.1.1.	General

SECTION 7.2 INSPECTION, TESTING AND MAINTENANCE

Subsection 7.2.1.	Intervals Between Tests
Subsection 7.2.2.	Elevators
Subsection 7.2.3.	Venting to Aid Fire Fighting
Subsection 7.2.4.	Central Alarm and Control Facilities and Voice Communication Systems for Life Safety

SECTION 7.3 INSPECTIONS AND TESTS FOR SMOKE CONTROL EQUIPMENT

Subsection 7.3.1.	General
-------------------	---------

SECTION 7.1 GENERAL

Subsection 7.1.1.	General
-------------------	---------

Application

7.1.1.1. This Part provides for the checking, **inspection**, **testing** and maintenance of fire emergency systems installed in high buildings as defined in Subsection 3.2.6. of the **Building Code**.

Fire safety plan

7.1.1.2. A fire safety plan as described in Section 2.8 shall be maintained for every **building** subject to this Section.

7.1.1.3. RESERVED

Testing fire emergency systems

7.1.1.4. Fire emergency systems required by Subsection 3.2.6. of the **Building Code** shall be **tested** in conformance with Sections 7.2 and 7.3.

7.1.1.5. RESERVED

Maintenance of fire emergency systems

7.1.1.6.(1) In addition to the requirements of Part 6, components of fire emergency systems shall be maintained in conformance with Sentences (2) to (6).

(2) The keys required to recall elevators and to permit independent operation of each elevator shall be kept in the location required by Subsection 3.2.6. of the **Building Code**.

(3) The firefighters' elevator identification required in Subsection 3.2.6. of the **Building Code** shall be maintained in identifiable condition.

(4) Access to windows and panels required to vent **floor areas** and vents to vestibules permitted to be manually openable shall be kept free of obstructions.

(5) Windows and panels provided for venting **floor areas** shall be maintained so as to be openable without the use of keys.

(6) Vents to vestibules permitted to be manually openable shall be maintained in an operable condition.

SECTION 7.2 INSPECTION, TESTING AND MAINTENANCE

Subsection 7.2.1.	Intervals Between Tests
-------------------	-------------------------

7.2.1.1. Unless otherwise specifically prescribed in this Part, **tests** shall be carried out at intervals of not more than 3 months.

7.2.1.2. Firefighters' elevators required in Subsection 3.2.6. of the **Building Code** and elevators required by Clause 2.8.2.4.(1)(b) of this Code shall be maintained in operable condition.

Subsection 7.2.2.	Elevators
-------------------	-----------

Testing

7.2.2.1.(1) Elevator door-opening devices operated by means of photo-electric cells shall be **tested** to ensure that the devices become

inoperative after the door has been held open for more than 10 s with the photo-electric cell covered.

(2) Key-operated switches located outside an elevator shaft shall be tested to ensure that actuation of the switch will render the emergency stop switch in each car inoperative and bring all cars to the street floor or transfer lobby by cancelling all other calls after the car has stopped at the next floor at which it can make a normal stop.

(3) Key-operated switches in each elevator car shall be tested to ensure that actuation of the switch will

- (a) enable the elevator to operate independently of other elevators,
- (b) allow operation of the elevator without interference from floor call buttons,
- (c) render door protective devices inoperative, and
- (d) control the opening of power-operated doors only by continuous pressure on the door opening buttons or switches, to ensure that if the "open" button or switch is released while the door is opening, the doors will automatically close.

Subsection 7.2.3. Venting to Aid Fire Fighting

Inspection

7.2.3.1.(1) Closures in vent openings into smoke shafts from each floor area shall be inspected sequentially over a period not to exceed 5 years.

(2) Every closure in an opening to the outdoors at the top of a smoke shaft shall be inspected annually to ensure that it will open

- (a) manually from outside the building,
- (b) on a signal from the smoke or heat actuated device in the smoke shaft, and
- (c) when a closure in an opening between a floor area and the smoke shaft opens.

(3) In addition to the procedures described in Sentences (1) and (2), elevators in an elevator shaft that is intended for use as a smoke shaft shall be inspected semi-annually to ensure that on activation of the fire alarm system they will return to the street floor and remain inoperative.

(4) Controls for air-handling systems used for venting in the event of a fire shall be inspected annually to ensure that air is exhausted from each floor area to the outdoors as required in Sentence 3.2.6.5.(2) of the Building Code.

Subsection 7.2.4. Central Alarm and Control Facilities and Voice Communication Systems for Life Safety

7.2.4.1. The checking, inspecting and testing of central alarm and control facilities and voice communication systems for life safety shall be carried out in accordance with the requirements of Section 6.3.

SECTION 7.3 INSPECTIONS AND TESTS FOR SMOKE CONTROL EQUIPMENT

Subsection 7.3.1. General

7.3.1.1. Smoke control equipment provided in buildings under the Building Code shall be maintained in a manner to ensure that they are fully operational.

7.3.1.2. Where smoke control measures contained in the Supplement to the National Building Code of Canada 1985, Chapter 3 "Measures for Fire Safety in High Buildings" are used, the

inspections and tests shall be carried out as outlined in Section 7.3 of the National Fire Code of Canada 1985.

7.3.1.3. Where a smoke control system is designed to meet the requirements of Sentences 3.2.6.2.(2), (3) and (4) of the Building Code, the inspections and tests for equipment shall be carried out in accordance with procedures established by the designer of the system.

PART 8 DEMOLITION

TABLE OF CONTENTS

SECTION 8.1 GENERAL

Subsection 8.1.1. Application

Subsection 8.1.2. Requirements

SECTION 8.1 GENERAL

Subsection 8.1.1. Application

Application

8.1.1.1. This Part applies to the prevention or control of fire during any demolition and the protection from fire of adjacent occupied spaces and adjoining properties.

Subsection 8.1.2. Requirements

Building services

8.1.2.1. Existing building services that may be affected by demolition so as to cause a fire hazard shall be protected or be shut off and capped.

Firewatch

8.1.2.2.(1) During periods when demolition operations will create a fire hazard to neighbouring properties or partially occupied spaces, a firewatch shall be provided.

(2) Where a firewatch is required, the demolition site shall be toured at least once each hour.

(3) The firewatch personnel shall be provided with a means of communication with the fire department, and be equipped with portable illumination and protective equipment.

Storage of combustible salvage

8.1.2.3. Combustible salvage, combustible waste material and rubbish shall not be permitted to accumulate on site in such quantity or such location as to cause a fire hazard.

Removal of combustible waste

8.1.2.4. Rubbish shall not be burned on the premises unless permitted in accordance with Article 2.6.3.4.

Welding and cutting

8.1.2.5. Electric or gas welding and cutting equipment and the installation, operation and maintenance of electric or gas welding and cutting equipment shall be carried out in conformance with the requirements of Section 5.17.

Standpipe systems

8.1.2.6.(1) During the demolition of any building with a standpipe system, the standpipe system complete with fire department connections, valves, couplings and hose, shall be maintained two floors below the level of the floor being demolished.

(2) Where no fire department standpipe connections exist in buildings 4 storeys or more in building height in buildings under demolition, a temporary connection shall be provided.

(3) In buildings not equipped with a standpipe system and over 8 storeys in building height, a temporary standpipe shall be provided.

(4) Standpipe systems shall be kept in such condition that they may be connected near street level, to a **fire department pump**, so as to supply water to every outlet on each floor.

(5) In **buildings** over 84 m in **building height**, standpipe systems provided in **buildings** under **demolition** shall be connected to street water mains.

8.1.2.7.(1) Fire fighting access routes shall be maintained in conformance with Section 2.5.

(2) Elevating devices shall be accessible for the use of firefighters for **buildings** more than 36 m in **building height**, measured between **grade** and the floor level of the top storey.

Portable extinguishers

8.1.2.8.(1) Portable extinguishers shall be provided in **buildings** under **demolition** in conformance with Subsection 6.2.6, as if the **building** were graded for ordinary hazard under Subsection 6.2.5.

(2) Portable extinguishers required under Sentence (1) shall be maintained in conformance with Section 6.2.

PART 9 RETROFIT

TABLE OF CONTENTS

SECTION 9.1	GENERAL
Subsection 9.1.1	Scope
Subsection 9.1.2	Application
Subsection 9.1.3	Schedule of Compliance
Subsection 9.1.4	Life Safety Study
SECTION 9.2	ASSEMBLY OCCUPANCIES
Subsection 9.2.1	Application
Subsection 9.2.2	Containment
Subsection 9.2.3	Means of Egress
Subsection 9.2.4	Fire Alarm and Detection
Subsection 9.2.5	Suppression
SECTION 9.3	BOARDING, LODGING AND ROOMING HOUSES
Subsection 9.3.1	Application
Subsection 9.3.2	Containment
Subsection 9.3.3	Means of Egress
Subsection 9.3.4	Fire Alarm and Detection
Subsection 9.3.5	Suppression
SECTION 9.4	HEALTH CARE FACILITIES
Subsection 9.4.1	Application
Subsection 9.4.2	Containment
Subsection 9.4.3	Means of Egress
Subsection 9.4.4	Fire Alarm and Detection
Subsection 9.4.5	Suppression

SECTION 9.1 GENERAL

Subsection 9.1.1. Scope

Scope

9.1.1.1. This Part provides for the upgrading of **existing buildings**.

Subsection 9.1.2. Application

Application

9.1.2.1. The requirements for **buildings** that are covered by this Part shall be determined by their **occupancies** as regulated in the appropriate Sections herein.

9.1.2.2. This Part does not apply to **buildings** or parts thereof that satisfy the requirements of the **Building Code**.

9.1.2.3.(1) The requirements of this Part shall be satisfied

- (a) under Subsection 9.1.3., or
- (b) by implementing a Life Safety Study that has been **approved** under Subsection 9.1.4.

Subsection 9.1.3. Schedule of Compliance

Compliance time

9.1.3.1.(1) It is the responsibility of the **owner** to comply with the requirements of

- (a) Section 9.2 and Section 9.3, and
- (b) Section 9.4 within one year after this Regulation comes into force.

(2) Sections 9.2 and 9.3 of this Regulation do not apply to **buildings** with respect to which the **Chief Fire Official** has granted an exemption under a predecessor to this Regulation for so long as the exemption is valid.

Extension of time

9.1.3.2.(1) The **owner** or the **owner's** agent may apply to the **Chief Fire Official** for an extension of time within which to comply

- (a) not to exceed two additional years from the date of compliance referred to in Clause 9.1.3.1.(1)(b) for occupancies regulated in Section 9.4, or
- (b) not to extend beyond the 30th day of April, 1987, for **assembly occupancies** referred to in Clause 9.2.1.1.(1)(k).

Schedule for completion

(2) A proposed schedule for completion of the work shall be submitted with the application for extension of time.

Review

(3) Upon receipt of the application referred to in Sentence (1) the **Chief Fire Official** shall, within ten days, review the application and either grant or refuse an extension of the time for compliance.

(4) The **Chief Fire Official** shall notify the **owner** or the **owner's** agent of the **Chief Fire Official's** decision in writing.

Notification

(5) Notification shall be served either personally or by ordinary mail.

(6) Where notification is by mail, it shall be deemed to have been served on the fifth day after the date of mailing.

Written reasons

(7) The **owner** or the **owner's** agent, within five days of being notified of a refusal to grant an extension of the time for compliance, may request the reasons therefor in writing.

(8) The **Chief Fire Official** shall comply with the request within ten days after receipt thereof.

Appeal

(9) An **owner** or the **owner's** agent who feels aggrieved by the decision to refuse an extension of time for compliance may, within thirty days of the refusal, appeal the refusal in the same manner as though it were an **Order**.

Subsection 9.1.4. Life Safety Study

Life Safety Study

9.1.4.1.(1) A Life Safety Study is a proposal to the **Chief Fire Official** that consists of

- (a) a detailed assessment of the life safety performance require-

ments, clearly identifying items not meeting the requirements of this Part,

- (b) a detailed description of how an acceptable level of life safety can be achieved, and
- (c) a detailed time schedule to implement Clause (b).

Contents

9.1.4.2.(1) A Life Safety Study shall deal with but is not limited to the following:

- (a) containment;
 - (i) **fire separations**
 - (ii) **firewalls**
 - (iii) construction assemblies
 - (iv) **occupancy separations**
 - (v) interior finishes
- (b) detection;
 - (i) alarm and detection systems
 - (ii) voice communication systems
- (c) suppression;
 - (i) **fire department access**
 - (ii) standpipe and hose systems
 - (iii) sprinkler or special extinguishing systems
 - (iv) firefighters' elevators
- (d) egress;
 - (i) exits (type, access to, direction to, lighting for, identification of, number from rooms, etc.)
 - (ii) fire escapes
 - (iii) **occupant load**
 - (iv) emergency lighting.

Signature and seal

9.1.4.3. A Life Safety Study shall bear the signature and seal of a **Professional Engineer** or **Architect**, or both.

Time schedule

9.1.4.4. Despite Sentence 9.1.3.2.(1) the time schedule referred to in Clause 9.1.4.1.(1)(c) may exceed two additional years from the date of compliance.

Extension

9.1.4.5. An **owner** or the **owner's** agent may apply to the **Chief Fire Official** for an extension of the compliance date to permit time for a Life Safety Study to be submitted.

Extension following Order

9.1.4.6.(1) Where an **owner** or the **owner's** agent has received an **Order** that requires compliance with this Part, the **owner** or the **owner's** agent may apply within five days of receipt of the **Order** to the **Chief Fire Official** to extend the time for compliance pending submission of a Life Safety Study.

Review

- (2) Upon receipt of the application referred to in Sentence (1),

the **Chief Fire Official** shall, within ten days, review the application and either grant or refuse an extension of the time for compliance to permit submission of a Life Safety Study.

- (3) The **Chief Fire Official** shall notify the **owner** or the **owner's** agent of the **Chief Fire Official's** decision in writing.

Notification

- (4) Notification shall be served either personally or by ordinary mail.

- (5) Where notification is by mail, it shall be deemed to have been served on the fifth day after the date of mailing.

Written reasons

- (6) The **owner** or the **owner's** agent, within five days of being notified of a refusal to grant an extension of the time to submit a Life Safety Study, may request the reasons therefor in writing.

- (7) The **Chief Fire Official** shall comply with the request within ten days after receipt thereof.

Appeal

- (8) An **owner** or the **owner's** agent who feels aggrieved by a decision to refuse an extension of time to submit a Life Safety Study may, within thirty days of the refusal, appeal the refusal in the same manner as though it were an **Order**.

Review

9.1.4.7.(1) Despite any other **Order** that requires compliance with this Part, the **Chief Fire Official** shall, within thirty days after receiving a Life Safety Study, review the Life Safety Study for implementation.

Notification

- (2) Where a Life Safety Study is **approved** for implementation, the **Chief Fire Official** shall notify the **owner** or the **owner's** agent of the decision in writing.

Rejection

- (3) Where a Life Safety Study is not **approved**, the **Chief Fire Official** shall advise the **owner** or the **owner's** agent of the decision and the reasons therefor in writing.

- (4) Notification shall be served either personally or by ordinary mail.

- (5) Where notification is by mail, it shall be deemed to have been served on the fifth day after the date of mailing.

Appeal

- (6) An **owner** or the **owner's** agent who feels aggrieved by a decision not to **approve** a Life Safety Study may, within thirty days of the refusal, appeal the decision in the same manner as though it were an **Order**.

- (7) Despite any other provision of this Part, a Life Safety Study that has been **approved** and implemented shall be deemed to satisfy an **Order** requiring compliance with this Part and made with respect to the same premises before the Life Safety Study was accepted.

Record

9.1.4.8. A copy of an **approved** Life Safety Study shall be kept on the premises to which it relates and be made available to the **Chief Fire Official** upon request.

SECTION 9.2 ASSEMBLY OCCUPANCIES

Subsection 9.2.1. Application

Assembly occupancies

- 9.2.1.1.(1) This Section applies to

- (a) art galleries,
- (b) auditoria,
- (c) beverage establishments,
- (d) bingo halls,
- (e) clubs,
- (f) community halls,
- (g) dance halls,
- (h) enclosed arenas,
- (i) exhibition halls,
- (j) gymnasias,
- (k) halls in religious establishments (excluding areas of worship),
- (l) lecture halls,
- (m) lodge rooms,
- (n) motion picture theatres,
- (o) museums,
- (p) opera houses,
- (q) restaurants,
- (r) television studios, and
- (s) theatres.

Exceptions

9.2.1.2. This Section does not apply to **assembly occupancies** in buildings that are regulated by or under the **Education Act** or the **Ministry of Colleges and Universities Act**.

Subsection 9.2.2. Containment

Fire separations between major occupancies

9.2.2.1.(1) **Fire separations** shall be provided between **assembly occupancies** described in Subsection 9.2.1. and other **major occupancies** in compliance with Article 3.1.3.2. of the **Building Code**.

(2) Where a **building** is **sprinklered** and the sprinkler system complies with Article 9.2.5.2., or where a detection system is provided and connected to the building fire alarm system, and Sentence (1) requires

- (a) a 2-hr **fire separation**, a 1-hr **fire separation** shall be deemed to be in compliance, or
- (b) a 1-hr **fire separation**, a ½-hr **fire separation** shall be deemed to be in compliance.

Protection of openings in fire separations

9.2.2.2.(1) **Closures** that are in compliance with Sentences 3.1.6.4.(2) and 3.1.6.7.(1) of the **Building Code** shall be provided in **fire separations**.

(2) Where Sentence (1) requires

- (a) a 1-hr or a ¾-hr **fire-protection rating**, existing hollow metal or kalamein doors, with or without wired glass, equipped with self-closing devices and existing hollow metal frames shall be deemed to be in compliance,
- (b) a 1-hr or a ¾-hr **fire-protection rating**, existing wired glass

screens set in fixed steel frames shall be deemed to be in compliance, or

- (c) a 20-min **fire-protection rating**, existing 45 mm solid core wood doors and existing solid wood frames shall be deemed to be in compliance.

(3) Despite the requirements referred to in Sentence (1), **fire dampers** and **fire-stop flaps** are not required to be installed in ducts at penetrations of a **fire separation**.

Fire separations of hazardous areas

9.2.2.3.(1) In high buildings classified in the **Building Code** under Subsection 3.2.6., **fire separations** that are in compliance with Subsection 3.5.2. of the **Building Code** shall be provided between service rooms and **assembly occupancies**.

(2) In buildings not referred to in Sentence (1), **fire separations** that are in compliance with Subsection 3.5.2. of the **Building Code** shall be provided between service rooms and **assembly occupancies**.

(3) A ½-hr **fire separation** shall be deemed to be in compliance with Sentence (2) where

- (a) the service room is **sprinklered**, or
- (b) a detection system is provided and connected to the building fire alarm system.

(4) **Fire separations** shall be provided between theatrical stages and **assembly occupancies** in compliance with Sentences 3.3.2.14. (3) to (5) of the **Building Code**.

(5) Despite Sentence (4), existing **fire separations** may be **approved**.

Interior finishes

9.2.2.4.(1) Interior finishes shall comply with the **flame-spread rating** requirements under Clauses 3.1.4.5.(3)(g) and (h) and Subsection 3.1.11. of the **Building Code**.

(2) Where

- (a) the finish is not an exposed expanded plastic, the assembly area is **sprinklered** and the sprinkler system complies with Article 9.2.5.2., the existing interior finish shall be deemed to be in compliance with Sentence (1), or
- (b) the finish is treated with a fire retardant surface coating listed by a recognized testing laboratory and applied in accordance with the listing conditions, the finish shall be deemed to be in compliance with Sentence (1).

(3) Despite Sentence (1), existing interior finishes may be **approved**.

Subsection 9.2.3. Means of Egress

Occupant load determination

9.2.3.1. The **occupant load** for calculation of number and width of **exits** referred to in Articles 9.2.3.6., 9.2.3.7. and 9.2.3.8. shall be in accordance with Table 3.1.14.A. of the **Building Code**.

Access to exits; number and location

9.2.3.2.(1) Where the **occupant load** of a room exceeds 60 persons, at least two egress doorways shall be provided in such a manner that one doorway can provide egress if the other doorway becomes inaccessible to the occupants.

(2) An existing room with one doorway shall be deemed to be in compliance with Sentence (1) where

- (a) the **occupant load** does not exceed 100 persons,

- (b) the **floor area** is **sprinklered** and the sprinkler system complies with Article 9.2.5.2., and
- (c) the **travel distance** does not exceed 23 m.

Access to exits

9.2.3.3.(1) **Access to exits** shall comply with Article 3.3.2.7. of the **Building Code**.

Dead end corridors

(2) **Existing access to exits** through dead end corridors shall be deemed to be in compliance with Sentence (1) where

- (a) the **occupant load** does not exceed 20 persons, and
- (b) the **travel distance** does not exceed 6 m plus the width of the dead end corridor to a point where a choice of two directions of exit travel are available.

Minimum number required

9.2.3.4.(1) Each **floor area** shall be served by at least two exits.

(2) Despite Sentence (1), **floor areas** in **buildings** not exceeding 2 storeys in **building height** may be served by one exit where

- (a) the **occupant load** for the **floor area** does not exceed 60 persons,
- (b) the **floor area** does not exceed 200 m², and
- (c) the **travel distance** from any point on the floor area does not exceed 15 m.

Door swing

9.2.3.5. Each door serving as an **access to exit** from a room serving more than 60 persons shall open in the direction of **exit travel** and shall swing on its vertical axis.

Number of exits

9.2.3.6.(1) The minimum number of **exits** from a **floor area** shall be provided as follows:

- (a) **occupant load** 61 up to and including 600 persons, not less than 2 exits,
- (b) **occupant load** 601 up to and including 1000 persons, not less than 3 exits, or
- (c) **occupant load** more than 1000 persons, not less than 4 exits.

Total width

9.2.3.7. The total width of required **exits** shall be determined on the basis of 90 persons per unit of **exit width** for a **floor area** located at or near **grade**, and 60 persons per unit of **exit width** where it is necessary to negotiate stairways or ramps.

9.2.3.8.(1) The width of an **exit** in units shall be determined by dividing the width of the **exit** in millimeters by 550.

(2) In calculating the width of an **exit**, where the remainder is 300 mm or more, half a unit shall be added to the **exit width** and where the remainder is less than 300 mm, the remainder shall be disregarded.

9.2.3.9.(1) The width of an **exit stair** or of a **corridor** used as an **access to exit** or as an **exit** shall be at least 914 mm.

(2) Where the total number of **exits** and the total width of **exits** comply with Articles 9.2.3.6., 9.2.3.7. and 9.2.3.8., **existing** **corridor** and **stair widths** shall be deemed to be in compliance with Sentence (1).

Fire escapes permitted

9.2.3.10. A fire escape may be erected on an **existing building** to

provide one or more of the **exit facilities** described in Article 3.4.1.2. of the **Building Code**, provided that the fire escape does not serve **floor areas** above the fifth floor.

Fire escape construction

9.2.3.11.(1) Each fire escape shall be constructed to comply with Article 3.4.7.13. of the **Building Code**, except as permitted in Article 9.2.3.18.

(2) Despite Sentence (1), an **existing** fire escape may be **approved**.

Emergency lighting

9.2.3.12. Emergency lighting shall comply with Article 3.2.7.3. of the **Building Code**.

Markings and signs

9.2.3.13.(1) **Markings and signs for exits and access to exits** shall comply with Subsection 3.4.5. of the **Building Code**.

(2) Despite Sentence (1), **existing** **markings and signs** may be **approved**.

Signs for basement stairs

9.2.3.14. In **buildings** over 2 storeys in **building height**, any part of an **exit ramp** or **stair** that continues past the **exit door** at ground level to a **basement** or **cellar** shall be clearly marked by a sign indicating that it does not lead to an **exit**.

Stairway separations

9.2.3.15.(1) Where an **exit stairway**, an **escalator** or a moving walkway serves as a required **exit**, it shall be separated from the remainder of the **building** in accordance with Sentence 3.4.4.1.(1) of the **Building Code**.

(2) **Doors** in fire separations required in Sentence (1) shall be equipped with self-closing devices.

(3) An **existing** $\frac{3}{4}$ -hr **fire separation** with a $\frac{3}{4}$ -hr rated **closure** as described in Clause 9.2.2.2.(2)(a) shall be deemed to be in compliance with Sentence (1).

(4) **Existing** **exit fire separations**, containing wired glass screens set in fixed steel frames, shall be deemed to be in compliance with Sentence (1).

Exits through lobbies

9.2.3.16.(1) **Exits** through a lobby area shall comply with the requirements of Clauses 3.4.4.1.(7) (c) to (f) of the **Building Code**.

(2) Despite Sentence (1), more than one **exit** may be permitted through a lobby area where there is at least one alternate **exit** capable of serving 50 per cent of the total capacity and leading directly to the outside.

Ancillary rooms

9.2.3.17.(1) **Existing** storage rooms, garbage rooms and laundry rooms, opening directly into an **exit stairway** shall be **sprinklered** and the rooms shall be separated from the **exit stairway** by a $\frac{3}{4}$ -hr **fire separation**.

(2) **Existing** washrooms and toilet rooms opening directly into an **exit stairway** shall be separated from the **exit stairway** by a $\frac{3}{4}$ -hr **fire separation**.

(3) Despite Sentences (1) and (2), **existing** ancillary rooms opening directly into an **exit stairway** may be **approved**.

9.2.3.18.(1) Openings adjacent to fire escapes shall comply with Sentence 3.4.7.13.(5) of the **Building Code**.

(2) **Existing** openings shall be deemed to be in compliance with Sentence (1) where each opening is protected by sprinklers in conformance with Article 9.2.5.2.

(3) Despite Sentences (1) and (2), existing openings may be approved.

Subsection 9.2.4. Fire Alarm and Detection

Fire alarm systems

9.2.4.1.(1) Fire alarm and detection systems shall be installed in compliance with Subsection 3.2.4., excluding Article 3.2.4.7., of the **Building Code**.

(2) Despite Sentence (1), existing fire alarm systems may be approved where the system reliability and performance will not increase the risk of life safety.

Subsection 9.2.5. Suppression

Access for fire fighting

9.2.5.1.(1) Access for fire fighting shall comply with Sentence 3.2.5.2.(1) of the **Building Code**.

(2) Sentence (1) does not apply where the building is sprinklered.

(3) Access routes that do not comply with Sentence (1) may be approved where available fire department equipment has access to the building or alternative provisions are made under Subsection 2.8.2. for such access.

Sprinkler systems

9.2.5.2.(1) Except as permitted in Sentence (3), sprinkler systems shall comply with Article 3.2.5.5. of the **Building Code**.

(2) An existing sprinkler system shall be deemed to be in compliance with Sentence (1) where the average sprinkler discharge density over the design area is at least equal to the minimum density corresponding to the area for the hazard classification as defined in Table 9.2.5.A.

High ceilings

(3) Where buildings with a ceiling height in excess of 9 m are required to be sprinklered, the design of the system shall be approved prior to installation.

Water supply requirements

(4) The water supply requirements for an existing sprinkler system shall be based on

- (a) the hazard classification, as determined in Table 9.2.5.A., and
- (b) the minimum sprinkler discharge density, area of application and sprinkler spacing, as determined in NFPA 13-1983, "Standard for the Installation of Sprinkler Systems", that corresponds to the hazard classification determined under Clause (a).

TABLE 9.2.5.A.

Forming Part of Article 9.2.5.2.

Hazard* Classification	Occupancy
Light Hazard	Art galleries Beverage establishments Gymnasias Halls in religious establishments (excluding areas of worship) Lecture halls Museums
Ordinary Hazard Group 1	Auditoria (excluding stages) Bingo halls Clubs Community halls Dance halls Lodge rooms Motion picture theatres Opera houses (excluding stages) Restaurants Television studios Theatres (excluding stages)
Ordinary Hazard Group 3	Enclosed arenas Exhibition halls Stages excluded in Ordinary Hazard Group 1

*Hazard Classification is defined as per NFPA 13-1983, "Standard for Installation of Sprinkler Systems".

Arenas and exhibition halls

(5) Clause 4 (b) does not apply to the water supply requirements for an existing sprinkler system in an arena or an exhibition hall.

(6) The water supply requirements for an existing sprinkler system in an arena or an exhibition hall shall be based on the lesser area of

- (a) 100 per cent of the display area, or
- (b) 280 m².

SECTION 9.3 BOARDING, LODGING AND ROOMING HOUSES

Subsection 9.3.1. Application

Application

9.3.1.1.(1) This Section applies to boarding houses, lodging houses, rooming houses and private rest homes in which residents, because of age, mental or physical limitations, do not require care or treatment, where

- (a) the building height does not exceed three storeys and the building area does not exceed 600 m²,
- (b) lodging is provided for more than three persons in return for remuneration or the provision of services or both, and
- (c) lodging rooms do not have both bathrooms and kitchen facilities for the exclusive use of individual occupants.

(2) This Section applies to homes for special care within the meaning of the **Homes for Special Care Act**, where

- (a) the building height does not exceed three storeys and the building area does not exceed 600 m²,

(b) sleeping accommodation is provided for more than three but not more than ten special care residents, and

(c) residents do not require nursing care.

Exceptions

9.3.1.2. Except as set out in Sentence 9.3.1.1.(2), this Section does not apply to **residential occupancies** that are regulated by or under the **Ministry of Community and Social Services Act**.

Subsection 9.3.2. Containment

Ceilings required

9.3.2.1.(1) Each storey shall have a ceiling consisting of lath and plaster or gypsum wallboard.

(2) Ceilings of noncombustible materials or combustible construction having a ½-hr **fire-resistance rating** shall be deemed to be in compliance with Sentence (1).

Basement ceilings

9.3.2.2. Article 9.3.2.1. does not apply to a **basement** that does not contain a bedroom, recreation room, meeting room or hobby room.

Walls and partitions separating bedrooms and corridors

9.3.2.3.(1) Each guest room or suite of rooms shall have interior walls consisting of lath and plaster or gypsum wallboard.

(2) **Existing** wall construction that has a ½-hr **fire-resistance rating** shall be deemed to be in compliance with Sentence (1).

9.3.2.4. Articles 9.3.2.1. and 9.3.2.3. do not apply to floor and wall assemblies that have a ½-hr **fire separation** that are constructed in accordance with Article 9.10.3.1. of the **Building Code**.

Fire separations to furnace room

9.3.2.5.(1) In a building where the **building height** is greater than two storeys or the **building area** is greater than 400 m², a furnace room that is located on a **floor area** that contains a bedroom, recreation room, meeting room or hobby room shall be separated from the remainder of the building by a ¾-hr **fire separation** that is constructed in accordance with Article 9.10.3.1. of the **Building Code**.

(2) Where the required vertical **fire separation** in a furnace room is maintained and it is not practical in the circumstances to install a ¾-hr **fire separation** in the ceiling, the furnace room area shall be **sprinklered** with a spacing that does not exceed 9.5 m² per sprinkler head.

(3) **Closures** in **fire separations** for a furnace room shall have a ¾-hr **fire-protection rating**.

(4) A hollow metal or kalamein door and frame shall be deemed to be in compliance with Sentence (3).

(5) **Closures** referred to in Sentences (3) and (4) shall be equipped with latches and self-closing devices.

(6) Despite Sentence (1), **fire dampers** or **fire-stop flaps** are not required in ducts at penetrations of a **fire separation**.

Combustion air

9.3.2.6. Where a furnace room is separated to comply with the requirements of Sentence 9.3.2.5.(1), sufficient combustion air shall be brought directly from the exterior for the proper combustion and safe operation of the **appliance**.

Subsection 9.3.3. Means of Egress

9.3.3.1.(1) Each **floor area** shall be served by at least two exits.

Exits from 1st and 2nd floors

(2) Where sleeping accommodation is not provided for more

than ten persons, one **exit** from each of the first and second floor **floor areas** shall be deemed to be in compliance with Sentence (1).

Exits from basements or cellars

(3) Where sleeping accommodation is not provided in the **basement** or **cellar**, one **exit** from the **basement** or **cellar** shall be deemed to be in compliance with Sentence (1).

Acceptable exits

9.3.3.2.(1) Exits required by Article 9.3.3.1. shall comply with the requirements of Articles 9.9.2.2. and 9.9.2.3. of the **Building Code**.

(2) Despite Sentence 9.3.3.5.(1), not more than one required **exit** from the **basement** or **cellar** may lead through the first floor **floor area**.

(3) Where sleeping accommodation is not provided for more than ten persons, corridors that are contiguous to a stairway may form part of the stairway enclosure.

(4) Only one stairway enclosure described in Sentence (3) shall be permitted as an **exit**.

(5) Where a fire escape of the type referred to in Article 9.3.3.4. is used as an **exit**, it shall be deemed to comply with the requirements of Articles 9.9.2.2. and 9.9.2.3. of the **Building Code**.

9.3.3.3.(1) Despite Articles 9.3.3.1. and 9.3.3.2., where an **approved** level of life safety will be achieved,

(a) **existing exit** facilities may be **approved**, or

(b) alternative measures, proposed by the **owner**, may be **approved** and implemented in accordance with the schedule of compliance in Subsection 9.1.3.

Fire escapes

9.3.3.4.(1) Each fire escape used as an **exit** shall be constructed in compliance with Article 3.4.7.13., excluding Sentences (4) and (5), of the **Building Code**.

(2) Despite Sentence (1), **existing** fire escapes may be **approved**.

(3) Access to fire escapes shall be from corridors.

Protection of exits

9.3.3.5.(1) Each **exit** other than a doorway opening directly onto a fire escape or to the outdoors at ground level shall be separated from the remainder of the **building** or from another **exit** by a ½-hr **fire separation** constructed in accordance with Article 9.10.3.1. of the **Building Code**.

(2) **Existing exit** stairways separated from the remainder of the **building** by walls consisting of lath and plaster or gypsum wallboard shall be deemed to be in compliance with Sentence (1).

(3) Despite Sentence (1), an **existing** separation of noncombustible material may be **approved**.

Interior stairways

9.3.3.6.(1) Floor separations shall be maintained at interior stairways that are not required **exits**.

(2) The floor separation shall be maintained at an **exit** permitted in Sentence 9.3.3.2.(2).

9.3.3.7. Floor separations required in Article 9.3.3.6. shall be constructed in accordance with Article 9.3.3.5.

Closures

9.3.3.8.(1) **Closures** in **fire separations** required in Articles 9.3.3.5. and 9.3.3.6. shall be constructed in accordance with Article

9.10.3.1. of the **Building Code** with a minimum 20-min **fire-protection rating**.

(2) **Closures** located along contiguous corridors permitted in Sentence 9.3.3.2.(3) shall comply with Sentence (1).

(3) A 45 mm solid core wood, hollow metal or kalamein door equipped with a self-closing device and a latching device shall be deemed to be in compliance with Sentences (1) and (2).

(4) Despite Sentences (1) and (2), frames for doors described in Sentence (3) may be of wood, hollow metal or kalamein construction.

(5) Despite Sentences (1) and (2), **fire dampers** or **fire-stop flaps** are not required in ducts at penetrations of a **fire separation**.

Wired glass closures

9.3.3.9. Existing wired glass **closures** set in fixed steel frames in a **fire separation** shall be deemed to be in compliance with Article 9.3.3.8.

Exit signs

9.3.3.10.(1) **Exit signs** shall be located along **means of egress** so that directions of **exit travel** are apparent to the occupants.

(2) **Exit signs** required by Sentence (1) shall have the word "EXIT" in block letters and such letters shall be

- (a) internally or externally illuminated,
- (b) coloured red on an opaque or contrasting field, and
- (c) at least 115 mm high with a 19 mm stroke.

Interior finishes

9.3.3.11. The **flame-spread rating** of interior finishes on walls and ceilings within a **means of egress** shall not exceed 200.

Illumination of egress

9.3.3.12. Corridors and stairways shall be lighted to the intensity of 50 lx measured at the floor level, or 5 watts per square metre of **floor area**.

Emergency lighting

9.3.3.13. Where sleeping accommodation is provided for more than ten persons, emergency lighting shall be provided to corridors and stairways in accordance with Article 9.9.11.4. of the **Building Code**.

Subsection 9.3.4. Fire Alarm and Detection

Alarm and detection systems

9.3.4.1.(1) A **building** to which this Section applies that does not comply with Articles 9.10.8.1. and 9.10.9.21. or the Compliance Alternatives of Part 11 of the **Building Code** shall have a fire alarm system that complies with Articles 9.10.17.5. and 9.10.17.11. of the **Building Code** and shall have

- (a) **smoke alarms** that comply with Sentence (2) and that are installed and interconnected so that the activation of any **smoke alarm** will sound a similar signal in each of the interconnected devices, or
 - (b) fire alarm system **smoke detectors** installed on the ceiling of each floor adjacent to each stairway, and on the ceiling in the **basement** adjacent to each stairway.
- (2) **Smoke alarms** referred to in Clause (1)(a) shall
- (a) be installed on the ceiling in the corridor of each floor adjacent to each stairway and on the ceiling in the **basement** adjacent to each stairway,

(b) be on a separate circuit with no disconnect switch between the overcurrent device and the **smoke alarms**, and

(c) employ devices and an interconnected installation that are **listed**.

9.3.4.2.(1) A fire alarm system complying with Articles 9.10.17.4., 9.10.17.5., 9.10.17.11. and Subsection 9.10.18. of the **Building Code** shall be installed where

- (a) sleeping accommodation is provided for more than ten persons, and
- (b) the **building** meets the construction requirements of Articles 9.10.8.1. and 9.10.9.21. or the Compliance Alternatives of Part 11 of the **Building Code** for **residential occupancies** as defined in Articles 9.10.2.1. and 9.10.2.2. of the **Building Code**.

9.3.4.3. Despite Articles 9.3.4.1. and 9.3.4.2., where sleeping accommodation is not provided for more than 14 persons, an interconnected **smoke alarm** system in accordance with Clause 9.3.4.1.(1)(a) shall be installed.

9.3.4.4. Despite Articles 9.3.4.1. and 9.3.4.2., existing fire alarm systems may be **approved** where the system reliability and performance will not increase the risk of life safety.

Subsection 9.3.5. Suppression

Portable extinguishers

9.3.5.1.(1) Despite the provisions of Articles 6.2.4.1., 6.2.6.4., 6.2.6.5. and 6.2.6.7., at least one 2A rated portable extinguisher shall be provided on each floor.

(2) At least one 5BC rated portable extinguisher shall be installed in each kitchen where shared cooking facilities exist.

SECTION 9.4 HEALTH CARE FACILITIES

Subsection 9.4.1. Application

Application

9.4.1.1.(1) This Section applies to

- (a) Homes for Special Care, regulated under the **Homes for Special Care Act**, where sleeping accommodation is provided for more than ten residents,
- (b) Homes for the Aged, regulated under the **Homes for the Aged and Rest Homes Act**,
- (c) Homes for the Aged, regulated under the **Charitable Institutions Act**,
- (d) Nursing Homes, regulated under the **Nursing Homes Act**,
- (e) Private Hospitals, regulated under the **Private Hospitals Act**, and
- (f) Public Hospitals, regulated under the **Public Hospitals Act**.

Subsection 9.4.2. Containment

Construction

9.4.2.1.(1) Existing **buildings** shall comply with the applicable construction requirements of Articles 9.4.2.2. to 9.4.2.4.

(2) **Fire separations** required by this Section to have a **fire-resistance rating** shall comply with Subsection 3.1.5. and Articles 3.1.6.1., 3.1.6.2. and 3.1.6.3. of the **Building Code**.

(3) Where a ¾-hr or less **fire-resistance rating** is required, existing wall assemblies, floor assemblies and their supporting assem-

blies consisting of membranes of lath and plaster or gypsum board shall be deemed to be in compliance with Sentences (1) and (2).

(4) Existing buildings with limited combustible components may be approved as noncombustible construction.

(5) Heavy timber construction conforming to Article 3.1.4.4. of the Building Code shall be deemed to have a ¾-hr fire-resistance rating.

(6) Floor assemblies shall be fire separations with fire-resistance ratings as required in this Subsection.

Combustible construction up to two storeys

9.4.2.2.(1) Buildings of combustible construction shall comply with the provisions of Sentence (2) where the building is

- (a) one storey in building height and not greater than 1000 m² in building area, or
- (b) two storeys in building height and not greater than 500 m² in building area.

(2) Floor assemblies and walls, columns and arches supporting floor assemblies shall have a ¾-hr fire-resistance rating.

(3) Despite Sentence (2), where the building is sprinklered, a fire-resistance rating is not required for floor assemblies and walls, columns and arches supporting floor assemblies.

Combustible construction up to four storeys

9.4.2.3.(1) Buildings of combustible construction shall comply with the provisions of Sentences (2) and (3) where the building is

- (a) not more than one storey in building height and not greater than 2400 m² in building area,
- (b) not more than two storeys in building height and not greater than 1600 m² in building area, or
- (c) not more than four storeys in building height and not greater than 500 m² in building area.

(2) Floor assemblies and walls, columns and arches supporting floor assemblies shall have a ¾-hr fire-resistance rating.

(3) Despite Sentence 9.4.4.2.(2), smoke detectors shall be provided in bedrooms, corridors, lounges and sitting areas.

(4) A building that is sprinklered shall be deemed to be in compliance with Sentences (2) and (3).

All other buildings

9.4.2.4.(1) Buildings not described in Articles 9.4.2.2. and 9.4.2.3. shall

- (a) have a ¾-hr fire-resistance rating for floor assemblies and walls, columns and arches supporting floor assemblies, and
- (b) be sprinklered, where the building is of combustible construction.

(2) Where only the roof assembly is of combustible construction,

- (a) sprinklering of the top storey and attic space shall be deemed to be in compliance with Clause 1(b), or
- (b) sprinklers are not required where the ceiling membrane has a ¾-hr fire-resistance rating and the attic space is fire stopped in accordance with the requirements of Article 3.1.9.3. of the Building Code.

Fire separations between occupancies

9.4.2.5.(1) Fire separations having a 1-hr fire-resistance rating

shall be provided between occupancies regulated under this Section and other major occupancies.

(2) Where a building is sprinklered and the sprinkler system complies with Article 9.4.5.2. or where the other major occupancy is equipped with heat detectors and connecting corridors are equipped with smoke detectors, a ½-hr fire separation shall be deemed to be in compliance with Sentence (1).

(3) Existing wall or floor assemblies consisting of masonry or membranes of lath and plaster or gypsum board shall be deemed to be in compliance with Sentence (1).

Fire separations between bedrooms and corridors

9.4.2.6.(1) Bedrooms or suites of rooms shall be separated from adjacent rooms by fire separations having a ¾-hr fire-resistance rating.

(2) Corridors serving bedrooms shall be separated from adjacent rooms, except sitting areas, lounges, nurses stations and washrooms by fire separations having a ¾-hr fire-resistance rating.

(3) Where the floor area is sprinklered, an existing fire separation shall be deemed to be in compliance with Sentences (1) and (2).

(4) Where smoke detectors are installed in bedrooms, sitting areas, lounges and corridors serving bedrooms on the floor area and where heat detectors are installed in other rooms opening onto corridors serving bedrooms, a ½-hr fire separation shall be deemed to be in compliance with Sentences (1) and (2).

Safe areas of refuge

9.4.2.7.(1) Floor areas containing rooms or areas used by the residents shall be divided by ¾-hr fire separations separating the floor area into at least two zones.

(2) Each zone required in Sentence (1) shall

- (a) contain at least one acceptable exit, and
- (b) be able to accommodate, in addition to its own occupants, the occupants of the adjacent zone, based on the requirements of 0.5 m² of clear floor space per person, 1.6 m² per person in a wheelchair, and 2.4 m² for each bedridden patient as the occupancy requires.

(3) A fire separation is not required under Sentence (1) where

- (a) the travel distance between exits does not exceed 9 m and the number of occupants on the floor area is not more than ten persons, or
- (b) the floor area is served by exterior exit doors leading directly to the outside.

Protection of openings in fire separations

9.4.2.8.(1) Closures in fire separations shall comply with the requirements of Sentences 3.1.6.4.(2), 3.1.6.7.(1) and 3.1.6.8.(1) and Article 3.1.6.9. of the Building Code.

(2) Where a ½-hr fire separation is permitted, closures shall have a 20-min fire-protection rating.

Doors and screens

(3) Where Sentences (1) and (2) require

- (a) a 1½-hr fire-protection rating, existing hollow metal doors, with or without wired glass panels not exceeding 645 cm², equipped with self-closing devices and existing hollow metal frames shall be deemed to be in compliance,
- (b) a ¾-hr fire-protection rating, existing hollow metal or kalamain doors, with or without wired glass, equipped with self-

closing devices and existing hollow metal frames shall be deemed to be in compliance,

(c) a ¾-hr **fire-protection rating**, existing wired glass screens set in fixed steel frames shall be deemed to be in compliance, or

(d) a 20-min **fire-protection rating**, existing 45 mm solid core wood doors and existing solid wood frames shall be deemed to be in compliance.

(4) Existing doors to bedrooms not conforming to Sentences (1) to (3) may be **approved**.

(5) Despite Sentence (1) and except as permitted in Article 9.4.2.9., door assemblies required to have a 20-min **fire-protection rating** shall be equipped with self-closing devices.

Fire dampers and fire-stop flaps

(6) Despite Sentences (1) and (2), **fire dampers** or **fire-stop flaps** are not required in ducts at penetrations of an **existing fire separation**.

Latches on bedroom doors

9.4.2.9. Where a door to a bedroom is not equipped with an automatic closing device, a latch that can hold the door in the closed position shall be installed.

9.4.2.10.(1) Fuel-fired appliances shall be enclosed in a service room separated from the remainder of the building by a **fire separation** having a ¾-hr **fire-resistance rating**.

(2) Sentence (1) does not apply to fireplaces.

(3) Despite Sentence (1), where the required vertical **fire separation** to a service room is provided and it is not practical in the circumstances to install a ¾-hr **fire separation** above the service room, the service room area shall be **sprinklered** with a spacing not exceeding 9.5 m² per sprinkler head.

9.4.2.11. Where a furnace room is separated to comply with the requirements of Article 9.4.2.10., sufficient combustion air shall be brought directly from the exterior for the proper combustion and safe operation of the **appliance**.

Transformer vaults

9.4.2.12. A transformer vault shall be separated from the remainder of the building by a **fire separation** having a 2-hr **fire-resistance rating**.

Vertical service facilities

9.4.2.13.(1) Vertical service facilities shall be enclosed in shafts separated from the remainder of the building by **fire separations** having a ¾-hr **fire-resistance rating**.

(2) Existing shaft construction shall be deemed to be in compliance with Sentence (1) where openings in the shaft, including shaft top and bottom, are sealed with noncombustible materials having the same rating as the existing shaft to prevent the movement of smoke.

Refuse and linen chutes

9.4.2.14.(1) Automatic sprinklers shall be installed at the top and at alternate floor levels in each linen or refuse chute and in the room or bin into which the chute discharges.

(2) An existing linen chute installation shall be deemed to be in compliance with Sentence (1) where the room into which the linen chute discharges is **sprinklered** and a minimum of 1 sprinkler head is installed at the top of the linen chute.

(3) Each room into which a linen or refuse chute discharges shall be separated from the remainder of the building by a 1-hr **fire separation**.

Incinerator rooms

9.4.2.15. Incinerators shall be enclosed in a service room separated from the remainder of the building by a **fire separation** having a 2-hr **fire resistance-rating**.

Subsection 9.4.3. Means of Egress

Access to exits

9.4.3.1.(1) Bedrooms or suites of rooms on a **floor area** shall have a doorway leading to an interior corridor where it shall be possible to go in opposite directions to each of two separate exits.

Dead end corridors

(2) Access to exits through a dead end corridor shall be deemed to be in compliance with Sentence (1) where

(a) the number of persons served does not exceed ten persons, and

(b) the travel distance does not exceed 6 m plus the width of the dead end corridor, to a point where a choice of two directions of exit travel are available.

(3) Where a bedroom or a suite of rooms is served by an exit door leading directly to the outside or to an exterior passageway, a doorway leading to an interior corridor served by one exit shall be deemed to be in compliance with Sentences (1) and (2).

(4) Where a dead end corridor does not satisfy the travel distance as described in Sentence (2), the existing corridor shall be deemed to be in compliance where additional fire protection measures are provided that are **approved**.

Number of exits

9.4.3.2. Each **floor area** used by patients or residents shall be served by not fewer than two exits.

Stairway separations

9.4.3.3.(1) Each exit stairway shall be separated from the remainder of the building by a **fire separation** having a ¾-hr **fire-resistance rating**.

(2) Closures in stairway **fire separations** shall conform to Article 9.4.2.8.

Door swing

9.4.3.4.(1) Each exit door shall open in the direction of exit travel and swing on its vertical axis.

(2) Existing door swing arrangements not in conformance with Sentence (1) may be **approved**.

Signs

9.4.3.5.(1) Signs for exits and access to exits shall comply with the requirements of Article 3.4.5.1. of the **Building Code**.

(2) Despite Sentence (1), existing signs may be **approved**.

Fire escapes

9.4.3.6.(1) A fire escape shall not be erected on an existing **building** unless it is not practical in the circumstances to provide one or more exit facilities, described under Article 3.4.1.2. of the **Building Code**, and provided that the fire escapes do not serve **floor areas** above the second floor.

(2) Fire escapes permitted under Sentence (1) shall be constructed to comply with the requirements of Article 3.4.7.13. of the **Building Code**, except that the fire escapes shall not be less than 1100 mm in width when serving **floor areas** with non-ambulatory residents.

(3) Despite Sentence (2), existing fire escapes may be **approved**.

Emergency lighting

9.4.3.7. Emergency lighting shall be provided in accordance with the provisions of Article 3.2.7.3. of the **Building Code**.

Subsection 9.4.4. Fire Alarm and Detection

Where required

9.4.4.1. A fire alarm and detection system shall be installed in each **building**.

Requirements

9.4.4.2.(1) Fire alarm and detection systems shall comply with the requirements of Subsection 3.2.4. of the **Building Code**.

(2) Despite Sentence (1), in **buildings** constructed prior to December 1, 1983, heat detectors may be installed in bedrooms, corridors and stair shafts to satisfy the **Building Code**, except where other detection is required by Sentence 9.4.2.3.(3), Sentence 9.4.2.5.(2) or Clause 9.4.2.6.(3)(b).

Existing fire alarm systems

(3) Despite Sentences (1) and (2), where the **Chief Fire Official** is satisfied that the performance and reliability of an existing fire alarm system will provide an adequate early warning level, the existing system may remain, be modified or be extended, provided compatibility of components is maintained.

Connections to fire department

9.4.4.3.(1) Each fire alarm system shall be connected to the **fire department** headquarters by

- (a) a direct connection, provided the **fire department** has the necessary facilities to accept such a connection, or
- (b) a central station or proprietary control station.

(2) Where the provisions required in Sentence (1) are not available, a procedure for notifying the **fire department** shall be approved.

Automatic shutdown of air handling systems

9.4.4.4.(1) Recirculating air handling systems that serve more than one storey or more than one zone as described in Sentence 9.4.2.7.(1) shall be arranged to shut down upon actuation of the fire alarm system.

(2) In **buildings** greater than six storeys in **building height**, air handling systems serving more than one storey or more than one zone as described in Article 9.4.2.7. shall be arranged to shut down upon actuation of the fire alarm system, except where continued operation of the air handling system is required to satisfy Subsection 3.2.6. of the **Building Code**.

Subsection 9.4.5. Suppression

9.4.5.1.(1) Access routes for fire fighting shall be provided in

accordance with the requirements of Article 3.2.5.2. of the **Building Code**.

(2) Sentence (1) does not apply where the **building** is **sprinklered**.

(3) Access routes that do not comply with Sentence (1) may be approved where available **fire department** equipment has access to the **building** or alternative provisions are made under Subsection 2.8.2. for such access.

Sprinkler systems

9.4.5.2.(1) Sprinkler systems shall be designed in conformance with Article 3.2.5.5. of the **Building Code**.

(2) Despite Sentence (1), water supply requirements for sprinkler systems required in this Section may be based on,

- (a) the operation of at least 3 sprinkler heads spaced not to exceed 14.4 m² per head, and
- (b) a sprinkler discharge rate of not less than 100 L/min at any single operating sprinkler head for a duration of 30 minutes.

(3) Despite Sentences (1) and (2), existing sprinkler systems providing adequate protection may be approved.

Firefighters elevators

9.4.5.3.(1) Despite the provisions of Clause 2.8.2.4.(1)(b), in **buildings** greater than six storeys in **building height**, at least one elevator shall be provided for use by firefighters.

(2) An elevator shall be deemed to be in compliance with Sentence (1) where

- (a) the elevator is capable of providing transportation from the **street** floor to each floor normally served by the elevator system,
- (b) the elevator is identified on the **street** floor as an elevator for use by firefighters,
- (c) the elevator satisfies the requirements of Article 3.2.6.3. of the **Building Code**, and
- (d) other elevator cabs in the same shaft as the elevator for use by firefighters satisfy the requirements of Sentences 3.2.6.3.(1) and (2) of the **Building Code**.

Voice communication systems

9.4.5.4.(1) In **buildings** greater than six storeys in **building height**, a voice communication system shall be provided in accordance with the requirements of Article 3.2.4.16. of the **Building Code**.

(2) A public address system compatible with the fire safety plan required under Subsection 2.8.2. shall be deemed to be in compliance with Sentence (1).

APPENDIX A - CORRESPONDING IMPERIAL VALUES

LIST OF ABBREVIATIONS

Abbreviations of words and phrases in this document have the following meanings:

METRIC

cm	centimetre(s)
cm ²	square centimetre(s)
°C	degree(s) Celsius
cs	centistoke(s)
hr	hour(s)
kg	kilogram(s)
kN	kilonewton(s)
kPa	kilopascal(s)
L	litre(s)
L/min	litre(s) per minute
lx	lux
m	metre(s)
m ²	square metre(s)
m ³	cubic metre(s)
m/min	metre(s) per minute
m ³ /min	cubic metre(s) per minute
ml	millilitre(s)
mm	millimetre(s)
N	newton(s)
ppm	part(s) per million
s	second(s)
t	tonne(s)

IMPERIAL

cfm	cubic foot (feet) per minute
cu ft	cubic foot (feet)
°F	degree(s) Fahrenheit
ft	foot (feet)
gal	gallon(s)
lgpm	Imperial gallon(s) per minute
in	inch(es)
lb	pound(s)

min	minute(s)
oz	ounce(s)
psi	pound(s) per square inch
psig	pound(s) per square inch (gauge)
qt	quart(s)
sq ft	square foot (feet)
sq in	square inch(es)
SUS	Saybolt Universal Second(s)

PART 1

Reference	S.I. Metric Units	Imperial Units	Remarks
Atmospheric storage tank	3.5 kPa (gauge)	0.5 psig	
Combustible Liquid	37.8°C 93.3°C	100°F 200°F	
Compressed Gas	275.8 kPa 21°C 717 kPa 54°C 275.8 kPa 37.8°C	40 psi 70°F 104 psi 130°F 40 psi 100°F	
First storey	1.8 m	6 ft	
Flammable liquid	37.8°C 275.8 kPa 37.8°C	100°F 40 psi 100°F	
Low Pressure Storage Tank	3.5 kPa (gauge) 100 kPa (gauge)	0.5 psig 15 psig	
Pressure Vessel	100 kPa (gauge)	15 psig	
Spraying area	6 m	20 ft	
Street	9 m	30 ft	
Column 1	2	3	4

PART 2

Reference	S.I. Metric Units	Imperial Units	Remarks
2.3.2.1.(1)(d)	1500 m ²	15000 sq ft	
2.4.1.9.(2)	650°C	1200°F	
2.4.1.10.	1 m 50 mm	3 ft 2 in	
2.4.3.2.	50 mm 12.5 mm 150 mm × 150 mm	2 in 1/2 in 6 in × 6 in	
2.6.1.3.	1.2 m	4 ft	
2.7.1.2.	1100 mm	44 in	
2.7.1.3.	914 mm 7.5 m	36 in 25 ft	
2.7.1.6.(3)	1100 mm	44 in	

Reference	S.I. Metric Units	Imperial Units	Remarks
(4)	750 mm 914 mm	30 in 36 in	
(6)	30 m	100 ft	
(8)	1.2 m ²	12 sq ft	
2.7.1.9.(2)	450 mm 914 mm	18 in 36 in	
(3)	914 mm 550 mm	36 in 22 in	
2.7.2.1.(1)	90 N	20 lb	
(2)	90 N	20 lb	
2.9.1.2.	30 m ²	300 sq ft	
2.12.1.3.(1)	9 m	30 ft	
(2)	9 m	30 ft	

PART 3

Reference	S.I. Metric Units	Imperial Units	Remarks
3.2.1.5.	7.5 m	25 ft	
3.2.2.3.(1)	150 mm	6 in	
3.2.2.4.(3)	4.5 m	15 ft	
3.2.2.5.(1)	15 m	50 ft	
3.2.2.6.	4.5 m 30 m	15 ft 100 ft	
3.2.2.8.	4.5 m	15 ft	
3.2.2.10.	6 m	20 ft	
3.2.2.11.	6 m	20 ft	
3.2.2.12.(2)(a)	6 m	20 ft	
3.2.2.13.(1)	3.5 m	12 ft	
3.2.2.14.	15 m 45 m	50 ft 150 ft	
3.2.2.15.	7.5 m 4.5 m	25 ft 15 ft	
3.2.2.18.	15 m	50 ft	
3.2.2.24.(1)(a)	200 L 457 mm 25 m	45 gal 18 in 75 ft	
(1)(b)	12 L	10 qt	
3.2.2.27.	60 m	200 ft	
3.2.3.5.	18 m 90 m 150 m	60 ft 300 ft 500 ft	
3.2.3.6.(2)	9 m	30 ft	
3.2.3.7.	3.5 m	12 ft	
3.2.3.8.	1.8 m	6 ft	
3.2.3.9.	150 m 9 m	500 ft 30 ft	
3.2.3.12.(1)	120 m	400 ft	
(2)	75 m 65 mm	250 ft 2.5 in	

Reference	S.I. Metric Units	Imperial Units	Remarks
(3)	1140 L/min	250 Igpm	
3.3.1.1.	425 m ³	15000 cu ft	
3.3.1.2.	500 m ² 30 m	5000 sq ft 100 ft	
3.3.1.4.	914 mm	36 in	
3.3.1.5.	1.8 m	6 ft	
3.3.1.6.	600 mm	24 in	
3.3.1.8.(1)	250 m ²	2500 sq ft	
3.3.1.10.	250 m ²	2500 sq ft	
3.3.2.1.	6.4 m	21 ft	
3.3.2.2.(1)	500 m ²	5000 sq ft	
(2)	1000 m ²	10000 sq ft	
(3)	4.5 m	15 ft	
3.3.2.3.(1)	457 mm	18 in	
(2)	300 mm	12 in	
3.3.2.4.	2.4 m	8 ft	
3.3.2.5.	2.4 m	8 ft	
3.3.2.6.	1.2 m	4 ft	
3.3.2.7.	600 mm	2 ft	
3.3.2.8.	15 m	50 ft	
3.3.2.10.(1)	100 m ² 1.2 m 7.5 m 2.4 m	1000 sq ft 4 ft 25 ft 8 ft	
(2)	1.2 m	4 ft	
3.4.2.3.	7.5 m	25 ft	
3.4.3.1.	1.5 m	5 ft	
3.5.1.4.	3.5 m	12 ft	
3.5.1.5.	200 L 12 L 25 m	45 gal 10 qt 75 ft	
3.5.1.7.	60 m	200 ft	
3.5.2.1.	3 m 100 m ²	10 ft 1000 sq ft	
3.5.2.2.	3 m	10 ft	
3.5.2.4.(3)	114 mm 19 mm	4.5 in 0.75 in	
3.6.1.6.	4.6 L	1 gal	
3.6.2.1.	3 m	10 ft	
3.6.2.4.	7.5 m	25 ft	
3.6.3.1.	6 m	20 ft	

PART 5

Reference	S.I. Metric Units	Imperial Units	Remarks
5.3.1.2.	3 m ³	100 cu ft	
5.3.1.3.	3 m 40 m ³ 2.4 m	10 ft 1500 cu ft 8 ft	
5.3.1.4.	2.4 m	8 ft	
5.3.1.5.	3 m	10 ft	
5.4.1.1.	1 m 3 m	3 ft 10 ft	
5.4.2.2.	450 kg 225 kg 112 kg	1000 lb 500 lb 250 lb	
5.4.2.3.	40 m ³	1500 cu ft	
5.4.2.5.	1 m	3 ft	
5.4.2.7.	70 kg	150 lb	
5.4.3.2.(1)(b)	600 mm	2 ft	
5.4.3.3.(1)	11 kg	25 lb	
(2)	9000 kg	20000 lb	
5.4.3.4.(1)	3400 kg	7500 lb	
(1)(b)	3.5 kPa	0.5 psig	
(1)(c)	40 m ³	1500 cu ft	
(1)(d)	0.1 m ² /m ³	1 sq ft/30 cu ft	
(1)(e)	200 c m ² /m ³	140 sq in/150 cu ft	
5.4.3.5.(1)	3400 kg 9000 kg	7500 lb 20000 lb	
(1)(b)	28 kPa	4 psig	
(1)(c)	650 c m ² /m ³	1 sq ft/50 cu ft	
(1)(d)	200 c m ² /m ³	140 sq in/150 cu ft	
5.4.5.1.	45 kg	100 lb	
5.5.1.1.	900 kg	2000 lb	
5.5.2.1.(1)	90 m	300 ft	
(1)(a)	30 m	100 ft	
(1)(b)	15 m	50 ft	
(2)	200 t 15 m 7.5 m	200 tons 50 ft 25 ft	
(3)	200 t 15 m	200 tons 50 ft	
5.5.3.1.(2)	15 m	50 ft	
5.5.3.3.	70 cm ² /m ²	1 sq ft/150 sq ft	
5.5.4.1.	6 m	20 ft	
5.5.4.4.(1)	1 m	3 ft	
(2)	1.2 m	4 ft	
5.5.4.5.	12 m	40 ft	
5.5.4.8.	50 mm	2 in	

Reference	S.I. Metric Units	Imperial Units	Remarks
5.5.5.1.(2)	50 mm	2 in	
5.5.5.5.(1)	54°C	130°F	
(2)	54°C	130°F	
5.6.1.5.	52°C	125°F	
5.6.2.2.(1)(b)	1.8 m	6 ft	
5.6.2.3.(1)(a)	170 m ³ 1.5 m	6000 cu ft 5 ft	
(1)(b)	170 m ³ 500 m ³ 7.5 m	6000 cu ft 18000 cu ft 25 ft	
(1)(c)	500 m ³ 15 m	18000 cu ft 50 ft	
5.6.2.4.(1)(d)(i)	0.2 m ² /m ³	1 sq ft/15 cu ft	
(1)(d)(ii)	650 cm ² /m ³	1 sq ft/50 cu ft	
(2)(a)	60 m ³	2000 cu ft	
(2)(b)	170 m ³	6000 cu ft	
5.6.2.9.	50 mm	2 in	
5.10.1.10.	1068 m/min	3500 ft/min	
5.10.1.11.(1)(c)	1.2 m	4 ft	
5.11.1.2.(1)	3 m ³	100 cu ft	
(2)	3 m ³ 15 m ³	100 cu ft 500 cu ft	
(3)	15 m ³ 30 m ³	500 cu ft 1000 cu ft	
(4)	30 m ³	1000 cu ft	
5.11.1.3.(1)(a)	700 m ³	25000 cu ft	
(1)(b)	4.5 m	14 ft	
(1)(c)	1.5 m	5 ft	
(1)(d)	1 m	3 ft	
5.11.1.4.	1 m/10 m	1 ft/10 ft	
5.11.1.5.(1)	457 mm	18 in	
(2)	300 mm	12 in	
5.11.1.6.(2)	300 mm	12 in	
5.11.2.3.	64 cm ² /m ²	16 sq ft/2500 sq ft	
5.12.2.1.(1)	1.14 mm	0.045 in	
5.12.3.2.	30 m/min	100 ft/min	
5.12.3.3.	18 m/min	60 ft/min	
5.12.3.4.	1.8 m ²	18 sq ft	
5.12.4.2.	457 mm	18 in	
5.12.4.3.	100 mm	4 in	
5.12.4.5.(1)(a)	1.8 m	6 ft	
(1)(b)	7.5 m	25 ft	
5.13.2.3.	150 mm	6 in	
5.13.2.5.	25 mm	1 in	
5.13.3.1.	150 mm	6 in	

Reference	S.I. Metric Units	Imperial Units	Remarks
5.13.3.2.	550 L 1 m ²	120 gal 10 sq ft	
5.13.3.3.	150 mm	6 in	
5.13.3.7.	2300 L	500 gal	
5.13.5.1.	600 mm	2 ft	
5.13.5.6.	43°C	110°F	
5.13.6.2.(1)	550 L 1 m ²	120 gal 10 sq ft	
5.13.6.3.	43°C 45 L 0.4 m ²	110°F 10 gal 4 sq ft	
5.14.1.4.(1)	28°C	50°F	
5.14.1.5.	1900 L 2.5 m ²	420 gal 25 sq ft	
5.14.1.7.	28°C	50°F	
5.14.2.2.	63 m ³ /L	10000 cu ft/gal	
5.14.2.3.	600 mm	2 ft	
5.14.2.5.(1)(b)	45 L	10 gal	
5.14.3.3.	43°C	110°F	
5.14.4.9.	1.5 m	5 ft	
5.14.4.10.	66°C	150°F	
5.14.5.2.(1)	37.8°C	100°F	
(2)	60°C	140°F	
(2)(b)	72 m ³ /min	2600 cfm	
(2)(d)	1 m	3 ft	
5.14.5.3.(1)	6 m	20 ft	
5.14.6.3.(2)	66°C	150°F	
5.17.3.1.(2)	11 m	35 ft	
5.17.3.2.	1 m 6 mm	3 ft 1/4 in	
5.18.3.2.	90°C	194°F	
5.18.3.3.(2)(a)	0.2 m ² /m ³	1 sq ft/15 cu ft	
(2)(b)	650 cm ² /m ³	1 sq ft/50 cu ft	
5.18.3.4.(1)(c)	1.5 m 6 m	5 ft 20 ft	

PART 6

Reference	S.I. Metric Units	Imperial Units	Remarks
6.2.1.8.(1)	4°C 49°C	40°F 120°F	
6.2.4.2.	18 kg 1.1 m	40 lb 3.5 ft	
6.2.4.3.	18 kg 1.5 m	40 lb 5 ft	
6.2.6.9.	6 mm 0.1 m ²	1/4 in 1 sq ft	
6.2.6.11.	0.4 m ²	4 sq ft	

Reference	S.I. Metric Units	Imperial Units	Remarks
6.4.3.2.	1400 kPa 350 kPa 1050 kPa	200 psig 50 psig 150 psig	
6.4.3.4.(1)	350 kPa 1400 kPa	50 psig 200 psig	
(2)	2 L 30 mL/hr/ 25 mm	2 qt 1 oz/hr/in	
6.5.1.4.	38°C 4°C	100°F 40°F	
6.5.1.6.(2)	1400 kPa 350 kPa	200 psig 50 psig	
(4)	350 kPa	50 psig	
6.5.1.7.(1)(b)	350 kPa 1400 kPa 2 L 30 mL/hr/ 25 mm	500 psig 200 psig 2 qt 1 oz/hr/in	
6.5.3.4.	0°C	32°F	
6.5.6.5.(2)	38°C	100°F	
6.6.1.4.	8°C	15°F	
6.6.2.4.	0°C	32°F	

PART 8

Reference	S.I. Metric Units	Imperial Units	Remarks
8.1.2.6.(5)	84 m	275 ft	
8.1.2.7.(2)	36 m	120 ft	

PART 9

Reference	S.I. Metric Units	Imperial Units	Remarks
9.2.2.2.(c)	45 mm	1.75 in	
9.2.3.2.(2)(c)	23 m	75 ft	
9.2.3.3.(2)(b)	6 m	20 ft	
9.2.3.4.(2)(b)	200 m ²	2000 sq ft	
(2)(c)	15 m	50 ft	
9.2.3.8.(1)	550 mm	22 in	
(2)	300 mm	12 in	
9.2.3.9.(1)	914 mm	36 in	
9.2.5.2.(3)	9 m	30 ft	
(6)(b)	280 m ²	3000 sq ft	
9.3.1.1.(1)(a)	600 m ²	6000 sq ft	
(2)(a)	600 m ²	6000 sq ft	
9.3.2.5.(1)	400 m ²	4000 sq ft	
(2)	9.5 m ²	100 sq ft	
9.3.3.8.(3)	45 mm	1.75 in	
9.3.3.10.(2)(c)	115 mm 19 mm	4.5 in 0.75 in	

Reference	S.I. Metric Units	Imperial Units	Remarks
9.3.3.12.	50 lx 5 watts/m ²	5 foot-candles 0.5 watts/sq ft	
9.4.2.2.(1)(a)	1000 m ²	10000 sq ft	
(1)(b)	500 m ²	5000 sq ft	
9.4.2.3.(1)(a)	2400 m ²	24000 sq ft	
(1)(b)	1600 m ²	16000 sq ft	
(1)(c)	500 m ²	5000 sq ft	
9.4.2.7.(2)(b)	0.5 m ² 1.6 m ² 2.4 m ²	5 sq ft 16 sq ft 24 sq ft	
(3)(a)	9 m	30 ft	
9.4.2.8.(3)(a)	645 cm ²	100 sq in	
(3)(d)	45 mm	1.75 in	
9.4.2.10.(3)	9.5 m ²	100 sq ft	
9.4.3.1.(2)(b)	6 m	20 ft	
9.4.3.6.(2)	1100 mm	44 in	
9.4.5.2.(2)(a)	14.4 m ²	144 sq ft	
(2)(b)	100 L/min	22 Igpm	

TABLES

TABLE 5.12.4.A.

Forming Part of Article 5.12.4.1.

Maximum Dimension of Duct	Minimum Thickness of Sheet Steel, in
Up to 8 in incl.	0.022
Over 8 in to 18 in incl.	0.027
Over 18 in to 30 in incl.	0.034
Over 30 in	0.045
Column 1	2

TABLE 5.13.3.A.

Forming Part of Article 5.13.3.4.

Size of Tank, gal	Overflow Pipe Size Required, in
0 - 10	2
11 - 35	2-1/2
36 - 75	3
76 - 150	4
151 - 225	5
226 - 325	6
326 and over	8
Column 1	2

TABLE 5.13.3.B.

Forming Part of Article 5.13.3.9.

Capacity of Dip Tank, gal	Diameter of Bottom Drain Pipe, in
500 - 750	3
751 - 1000	4
1001 - 2500	5
2501 - 4000	6
4001 and over	8
Column 1	2

TABLE 6.2.6.A.

Forming part of Article 6.2.6.4.

Basic Minimum Extinguisher Rating for Area Specified	Maximum Travel Distance to Extinguisher, ft	Maximum Area to be Protected per Extinguisher for Class A Fires, sq ft		
		Light Hazard Occupancy	Ordinary Hazard Occupancy	Extra Hazard Occupancy
1A	75	3000	Not Acceptable	Not Acceptable
2A	75	6000	3000	3000
3A	75	9000	4500	4000
4A	75	11250	6000	6000
6A	75	11250	9000	9000
10A	75	11250	11250	11250
20A	75	11250	11250	11250
40A	75	11250	11250	11250
Column 1	2	3	4	5

TABLE 6.2.6.B.

Forming part of Article 6.2.6.7.

Grade of Hazard	Basic Minimum Extinguisher Rating per Unit	Maximum Travel Distance to Extinguishers, ft
Light	5B	30
	10B	50
Ordinary	10B	30
	20B	50
Extra	20B	30
	40B	50
Column 1	2	3

TABLE 6.5.1.A.

Forming part of Article 6.5.1.7.

Size of Pipe, in	Minimum Flow, gpm
6	500
8	850
10	1200
12	1700
Column 1	2

REGULATION 455

GENERAL

DUTIES

1. It is the duty of the Fire Marshal, with the assistance of the Deputy Fire Marshal, district deputy fire marshals, inspectors, officers, clerks and servants of the Fire Marshal's Office, to carry out the provisions of the Act and this Regulation, and the Deputy Fire Marshal, district deputy fire marshals, inspectors, officers, clerks and servants shall, under the direction of the Fire Marshal, carry out such duties in the enforcement of the Act and this Regulation as are assigned to them from time to time by the Fire Marshal. R.R.O. 1980, Reg. 394, s. 1.

2.—(1) An officer, other than the Fire Marshal, who, making an inspection under section 18 of the Act, proposes to make an order against any property owned or leased by any municipality that has become subject to Part III of the *Municipal Affairs Act*, shall notify the Fire Marshal of the intention so to do at least five days before making the order.

(2) The officer making an order under section 18 of the Act shall file a copy of the order with the Fire Marshal within five days of the service of the order upon the person named therein. R.R.O. 1980, Reg. 394, s. 2.

3. The Fire Marshal, and under his or her direction the Deputy Fire Marshal, district deputy fire marshals, inspectors and assistants to the Fire Marshal may, under section 18 of the Act, enforce the regulations under the *Gasoline Handling Act*. R.R.O. 1980, Reg. 394, s. 3.

4. Without limiting the right to inspect and to issue orders under section 18 of the Act, the Fire Marshal may advise and consult with municipal authorities in the drafting and enforcement of by-laws under the authority of the *Municipal Act* with regard to establishments for dry cleaning and dry dyeing purposes as provided in section 22 of the Act. R.R.O. 1980, Reg. 394, s. 4.

ADVISORY COMMITTEE

5. The Lieutenant Governor in Council may from time to time appoint an advisory committee to consider any matter referred to it by the Minister. R.R.O. 1980, Reg. 394, s. 5.

RECORDS AND RETURNS

6.—(1) The Fire Marshal shall keep such registers, books and records as are required by the Minister.

(2) The Fire Marshal shall submit an annual report to the Minister and shall furnish or make such other reports and findings as the Minister from time to time requires or directs.

(3) Information and returns required by the Act or this Regulation to be furnished or made to the Fire Marshal shall, unless the Fire Marshal otherwise directs, be on forms provided by the Fire Marshal and shall contain such information as is required by the Fire Marshal. R.R.O. 1980, Reg. 394, s. 6.

7. Reports by assistants to the Fire Marshal under section 8 of the Act and reports by insurance companies and insurance adjusters and others under section 9 of the Act shall contain such statistical information in respect of fires, property destroyed, damaged or endangered by fire, and fire insurance, as is required from time to time by the Fire Marshal. R.R.O. 1980, Reg. 394, s. 7.

WITNESS FEES AND ALLOWANCES

8.—(1) The fees for persons attending to give evidence under section 14 of the Act, are,

- | | |
|--|------|
| (a) for persons summoned as witnesses, each day in attendance | \$ 6 |
| (b) for barristers, solicitors, physicians and surgeons, when called upon to give evidence in consequence of any professional service rendered by them or to give professional opinions, each day in attendance . | 15 |
| (c) for engineers, accountants, surveyors, architects, fire chiefs and other fire officers, when called upon to give evidence in consequence of any professional service rendered by them or to give evidence depending upon their skill or judgment, each day in attendance | 15 |

(2) A witness who travels to the place of hearing by private automobile is entitled to expenses of 10 cents a mile each way for each mile necessarily travelled in coming from and returning to his or her place of residence or place of service, whichever is the nearer to the place of hearing but, where the hearing is held in the local municipality in which the witness resides, the total amount shall not exceed 75 cents.

(3) A witness who travels to the place of hearing by a means other than private automobile is entitled to expenses of the amount of the fare actually paid for the transportation from his or her place of residence to the place of hearing and return.

(4) A witness who is required to attend the hearing on more than one day and who returns to his or her place of residence at night is entitled to the travelling allowance mentioned in subsections (2) and (3), as the case may be, in respect of each days attendance.

(5) Where a witness does not reside in the local municipality in which the hearing is held and it is desirable that he or she remain overnight at the place of hearing, the witness is entitled to expenses of the amount reasonably and actually paid by him or her for living expenses, but not more than \$8 for each night. R.R.O. 1980, Reg. 394, s. 8.

THE FIRE SERVICES LONG SERVICE MEDAL

9.—(1) In this section, service as a member of the public fire services shall include,

- (a) service as a full-time firefighter or a volunteer firefighter as defined in the *Fire Departments Act*;
- (b) employment in the service of the Crown in right of Ontario or any agency of the Crown in right of Ontario as a firefighter or in a capacity related to the prevention or investigation of fire; and
- (c) active service in the Canadian Forces in World War II, or the Korean War. R.R.O. 1980, Reg. 394, s. 9 (1).

(2) The Fire Marshal shall grant a medal, which shall be known as "The Fire Services Long Service Medal", to any person who has served as a member of the public fire services for a total of twenty-five years or more. O. Reg. 840/84, s. 1.

(3) The medal shall be worn on the left breast, subordinate to all Canadian and British military decorations.

(4) When a medal is awarded the name of the recipient shall be published in *The Ontario Gazette*. R.R.O. 1980, Reg. 394, s. 9 (3, 4).

10.—(1) The Fire Services Long Service Medal shall be a circular medal of rhodium plated metal 1½ inches in diameter,

- (a) bearing on the obverse the Maltese cross on which is superimposed the coat of arms of Ontario and the inscription "Fire Services Ontario"; and

- (b) bearing on the reverse the inscription "For long service the Fire Marshals Act".
- (2) The medal shall be suspended from a metal bar by means of a ribbon $1\frac{1}{4}$ inches in width comprising a red stripe $10/32$ of an inch in width in the centre and on each side,
- (a) a white stripe $3/32$ of an inch in width bordered by a green stripe $5/32$ of an inch in width; and
- (b) a red stripe $7/32$ of an inch in width at the edge of the ribbon. R.R.O. 1980, Reg. 394, s. 10.
-

Fish Inspection Act *Loi sur l'inspection du poisson*

REGULATION 456

QUALITY CONTROL

INTERPRETATION

1. In this Regulation,

“breaded fish” means fish or fish flesh that is coated with batter and breading;

“can” means any hermetically sealed glass or metal container;

“canned fish” means any fish that is sealed in a can and is sterilized;

“cannery” means an establishment where canned fish is produced for human consumption;

“comminuted fish flesh” means fish flesh that has been ground to a fine, uniform consistency;

“semi-preserving establishment” means an establishment where fish is prepared by salting or pickling in brine, vinegar, sugar, spices or any combination of those salting or pickling agents and packed so that it may be kept fit for human consumption for a minimum of six months by means of refrigeration without freezing;

“shrimp cocktail” means shrimp meat packed with sauce, spices, seasonings or flavourings or any combination of those ingredients; and

“sterilized”, in respect of canned fish, means fish that has been treated with heat to prevent spoilage and to destroy all pathogenic organisms. R.R.O. 1980, Reg. 395, s. 1.

2. For the purposes of section 7 of the Act,

(a) “decomposed”, with respect to fish, means fish that has an offensive or objectionable odour, flavour, colour or textural defect associated with spoilage;

(b) “tainted”, with respect to fish, means fish that is rancid or has an abnormal odour or flavour; and

(c) “unwholesome”, with respect to fish, means fish that has in or upon it micro-organisms of public health significance or substances toxic or aesthetically offensive to man. R.R.O. 1980, Reg. 395, s. 2.

PART I GENERAL

3. Fish shall be packed in new, clean and sound containers. R.R.O. 1980, Reg. 395, s. 3.

4.—(1) An inspector may detain fish or any container of fish for the purpose of inspection and for the purpose of identifying such fish, the inspector may attach to any of the fish or any container of fish a numbered tag furnished by the Ministry.

(2) Where fish or any container of fish is detained under subsection (1), the inspector shall deliver or mail to the owner or the owner's agent a notice of detention.

(3) Where fish or any container of fish is detained under subsection (1) on premises owned by a person who is not the owner of the

fish, a copy of the notice of detention referred to in subsection (2) shall be delivered or mailed to that person.

(4) No person shall move, sell or otherwise dispose of fish or any container of fish detained under subsection (1) unless that person has obtained a release therefor from an inspector.

(5) Where an inspector is satisfied that,

(a) fish and any container of fish detained under subsection (1) meet the requirements of this Regulation, he or she shall prepare a release authorizing the disposition of the fish for human consumption; or

(b) fish or any container of fish detained under subsection (1) does not meet the requirements of this Regulation, he or she may mark the fish or container accordingly and shall prepare a release authorizing the disposition of the fish for any purpose other than human consumption,

and shall deliver or mail one copy of the release referred to in clause (a) or (b) to the owner of the fish or the owner's agent and one copy to the person, if any, on whose premises the fish was found. R.R.O. 1980, Reg. 395, s. 4.

5. Where an inspector is satisfied that fish and any container of fish meet the requirements of this Regulation, the inspector shall, on request, issue an inspection certificate. R.R.O. 1980, Reg. 395, s. 5.

6. An appeal made under section 4 of the Act shall be made by notice in writing to the Minister within thirty days of the decision of the inspector. R.R.O. 1980, Reg. 395, s. 6.

7.—(1) No reinspection shall be ordered as a result of an appeal unless the appellant is able to satisfy the Minister that the identity of the fish or containers to be reinspected has been preserved.

(2) No reinspection shall be ordered as a result of an appeal where the decision of the inspector appealed from is in respect of the presence of a poisonous or harmful substance in or upon the fish or containers. R.R.O. 1980, Reg. 395, s. 7.

8. Where fish or containers have been approved under this Regulation and upon reinspection are found not to meet the requirements of this Regulation, any inspection marks and quality designations on such fish or containers shall be removed or obliterated and any inspection certificate that may have been issued for the fish or containers is void. R.R.O. 1980, Reg. 395, s. 8.

9. All receptacles, including vehicle bodies, boxes, tubs and barrels used to transport fish to or from any establishment shall be clean and shall be disinfected when necessary. R.R.O. 1980, Reg. 395, s. 9.

10. Fish that is intended for human consumption shall be adequately iced or chilled while being held or transported and shall be protected from contamination and the weather. R.R.O. 1980, Reg. 395, s. 10.

11. Fish that is intended for human consumption shall be protected from contamination and the weather during loading and unloading. R.R.O. 1980, Reg. 395, s. 11.

12. Frozen fish, while under the control of a carrier, shall be kept refrigerated in such a manner that, when it is delivered to its destina-

tion, the temperature of such fish will not have increased more than 10°F from the temperature at the time it was loaded. R.R.O. 1980, Reg. 395, s. 12.

13. No person shall sell or offer for sale cans of fish,
- that have not been properly sealed;
 - the tops or bottoms of which have been distorted outwards; or
 - that are otherwise defective. R.R.O. 1980, Reg. 395, s. 13.

PART II LABELLING

14. No person shall mark or label a container of fish with a quality designation or sell a container of fish that is so marked or labelled unless,

- a standard for that quality has been specified in this Regulation or the *Fish Inspection Regulations* (Canada); and
- the fish in that container meets that standard. R.R.O. 1980, Reg. 395, s. 14.

PART III CODE MARKINGS

15.—(1) Every carton and case in which containers of fish are packed at an establishment shall be legibly marked on one end in such a manner that the name of the establishment and the day, month and year of processing can be determined by an inspector.

(2) Every container in which pickled, spiced or marinated fish are packed shall be legibly marked in such a manner that the name of the establishment and the day, month and year of processing can be determined by an inspector. R.R.O. 1980, Reg. 395, s. 15.

16.—(1) Every can of fish that is packed in an establishment shall be embossed on one end in such a manner that the name of the establishment and the day, month and year of processing can be determined by an inspector.

(2) Where a can of fish is embossed with a code marking, a copy of the key to every such code marking shall be sent to the Minister each year before the commencement of processing operations. R.R.O. 1980, Reg. 395, s. 16.

17. Despite subsection 16 (1), any hermetically sealed glass container containing fish is exempt from the embossing requirement referred to in that subsection, if such container or the label affixed to it is otherwise permanently marked in such a manner that the name of the establishment and the day, month and year of processing can be determined by an inspector. R.R.O. 1980, Reg. 395, s. 17.

PART IV CANNED FISH

18. Canned fish shall be sterilized so that the product,
- is free from micro-organisms capable of development under normal conditions of storage; and
 - does not contain any substances originating from micro-organisms in amounts that may represent a hazard to health. R.R.O. 1980, Reg. 395, s. 18.

19. All canned fish, except canned fish packed in flat drawn cans, shall have sufficient vacuum to ensure that can ends do not bulge when the product is heated to a temperature of 95°F. R.R.O. 1980, Reg. 395, s. 19.

PART V FRESH OR FROZEN FISH

BREADED FISH

- 20.—(1) Fish sticks for sale in Ontario shall,
- if cooked, contain a minimum of 66⅔ per cent by weight of fish flesh;
 - if uncooked, contain a minimum of 75 per cent by weight of fish flesh;
 - weigh not less than one ounce each;
 - be free from defects; and
 - not be prepared from comminuted fish flesh.

(2) In this section, “fish sticks” means uniform, rectangular portions of breaded fish flesh. R.R.O. 1980, Reg. 395, s. 20.

21. Breaded scallops for sale in Ontario shall,
- if cooked, contain a minimum of 66⅔ per cent by weight of scallop meat; and
 - if uncooked, contain a minimum of 75 per cent by weight of scallop meat. R.R.O. 1980, Reg. 395, s. 21.

22.—(1) Shrimp cocktail shall be prepared from sound, cooked, peeled shrimp meat.

(2) Shrimp cocktail shall contain not less than 36½ per cent by weight of shrimp meat. R.R.O. 1980, Reg. 395, s. 22.

PART VI GENERAL CONSTRUCTION AND EQUIPMENT REQUIREMENTS FOR ESTABLISHMENTS

23. The surface of a floor in a wet working area of an establishment shall be sloped for drainage purposes and shall be constructed of durable and impervious material that permits rapid disposal of waste and that can be readily cleaned. R.R.O. 1980, Reg. 395, s. 23.

24. A floor in a dry working area of an establishment shall be constructed of material that can be readily cleaned. R.R.O. 1980, Reg. 395, s. 24.

25. Drains in an establishment shall be of a type and size sufficient to carry off process effluents and water from cleaning operations and shall be equipped with traps or other devices to prevent the entry of gases or vermin into the establishment through the drains. R.R.O. 1980, Reg. 395, s. 25.

26. The inside surfaces of walls in a wet working area of an establishment shall be constructed of smooth, durable, waterproof and light-coloured material that can be thoroughly cleaned up to a height of not less than four feet. R.R.O. 1980, Reg. 395, s. 26.

27. Every room in an establishment in which fish is processed shall have a ceiling that is free from cracks, crevices and open joints and is constructed of smooth, light-coloured material that can be readily cleaned. R.R.O. 1980, Reg. 395, s. 27.

28. Every establishment shall be equipped with a natural or mechanical ventilation system that will provide clean air, remove undesirable odours, steam and smoke and prevent condensation in rooms where work is performed. R.R.O. 1980, Reg. 395, s. 28.

29. Every establishment shall contain toilet facilities that are constructed and located in such a manner as to prevent the contamination of the establishment or the water supply of the establishment. R.R.O. 1980, Reg. 395, s. 29.

30. The room in which a toilet facility in an establishment is located shall,

- (a) have self-closing doors;
- (b) be ventilated to the outside;
- (c) have walls and a ceiling that are smooth, light in colour and that can be readily cleaned; and
- (d) have a floor that is constructed of impervious material and that can be readily cleaned. R.R.O. 1980, Reg. 395, s. 30.

31. Every establishment shall be provided with sanitary washbasins in locations that are visible from the working area, equipped with hot and cold running water, liquid or powdered soap and air dryers or single service towels. R.R.O. 1980, Reg. 395, s. 31.

32.—(1) Every establishment shall be provided with a supply of potable water that has a coliform bacteria count of not more than two per hundred millimetres and is under a minimum operating pressure of twenty pounds per square inch.

(2) Despite subsection (1), an establishment may be provided with water other than water referred to in subsection (1) for fire protection, boilers or auxiliary services provided that there is no connection between the water system used for fire protection, boilers or auxiliary services and the system providing water for other purposes. R.R.O. 1980, Reg. 395, s. 32.

33. The frames and legs on all equipment on which fish is processed shall be constructed of metal or other durable and impervious material, other than wood, that can be readily cleaned. R.R.O. 1980, Reg. 395, s. 33.

34. A table in an establishment shall be so constructed that it and the area beneath it can be readily cleaned. R.R.O. 1980, Reg. 395, s. 34.

35.—(1) A bin or receptacle in which offal is stored shall be watertight, constructed of metal or other durable and impervious material, other than wood, and, where necessary to prevent contamination of the establishment or any fish processed in the establishment, be equipped with a well-fitted cover.

(2) A concrete or other impervious surface, sloped for drainage purposes, shall be placed under an elevated offal bin. R.R.O. 1980, Reg. 395, s. 35.

36. No wood shall be used in the construction of a conveyor in an establishment where the wood will come in contact with fish. R.R.O. 1980, Reg. 395, s. 36.

37. Flumes for conveying fish shall be constructed of non-corrodible material, other than wood, that can be thoroughly cleaned. R.R.O. 1980, Reg. 395, s. 37.

38. Every working surface in a processing room in an establishment shall be provided with an illumination having a minimum intensity of twenty foot-candles. R.R.O. 1980, Reg. 395, s. 38.

PART VII ADDITIONAL CONSTRUCTION AND EQUIPMENT REQUIREMENTS FOR CANNERIES

FRESH-FISH, FREEZING OR SEMI-PRESERVING ESTABLISHMENTS

39. No cannery and no fresh-fish, freezing or semi-preserving establishment shall have exposed pipe over any working surface on which fish is processed. R.R.O. 1980, Reg. 395, s. 39.

40. Every cannery and every fresh-fish, freezing or semi-preserving establishment shall be provided with hot water that is maintained at a minimum temperature of 110°F in sufficient quantity for the

operations of the cannery or fresh-fish, freezing or semi-preserving establishment, as the case may be. R.R.O. 1980, Reg. 395, s. 40.

41. Every cannery and every fresh-fish, freezing or semi-preserving establishment shall be provided with facilities for disinfecting the protective hand coverings used in processing areas. R.R.O. 1980, Reg. 395, s. 41.

42. Every cutting, filleting and skinning board in a cannery and a fresh-fish, freezing or semi-preserving establishment shall be made of planed lumber or other material that is smooth and without cracks. R.R.O. 1980, Reg. 395, s. 42.

43. Every surface in a cannery and a fresh-fish, freezing or semi-preserving establishment, other than a cutting, filleting and skinning board on which fish is processed, shall be made of a non-corrodible material, other than wood, and every joint on the surface shall be smooth and watertight. R.R.O. 1980, Reg. 395, s. 43.

44. Every receptacle, tray, tank, vat and utensil used for processing fish in a cannery and a fresh-fish, freezing or semi-preserving establishment shall be made of a non-corrodible material, other than wood, and shall have smooth surfaces free from cracks and crevices. R.R.O. 1980, Reg. 395, s. 44.

45. Every box, cart, bin and other receptacle used in a cannery and a fresh-fish, freezing or semi-preserving establishment for holding fish, other than live fish, before it is further processed or shipped, shall be constructed so as to provide drainage and, where made of wood, be constructed of planed lumber or waterproof plywood and be coated with a durable and waterproof material free of contaminants. R.R.O. 1980, Reg. 395, s. 45.

46. Every conveyor belt in a cannery and a fresh-fish, freezing or semi-preserving establishment that comes in contact with fish, other than canned fish or packaged fish, shall be fitted with a spray washer and, where practical, a scraper. R.R.O. 1980, Reg. 395, s. 46.

47. No person shall use a wire mesh utensil in processing fish in a cannery or a fresh-fish, freezing or semi-preserving establishment. R.R.O. 1980, Reg. 395, s. 47.

48. No person shall use an enamelled utensil in processing fish in a cannery or a fresh-fish, freezing or semi-preserving establishment. R.R.O. 1980, Reg. 395, s. 48.

49. Every cannery shall be provided with steam of a supply and at a pressure sufficient for the operations of the cannery. R.R.O. 1980, Reg. 395, s. 49.

50. Every freezing facility in a fresh-fish, freezing or semi-preserving establishment shall be capable of reducing the temperature at the centre of a one-inch thick block of unpackaged fillets to -5°F in two hours or less. R.R.O. 1980, Reg. 395, s. 50.

51.—(1) Every freezing facility in a fresh-fish, freezing or semi-preserving establishment where round or dressed fish is blast frozen shall be capable of freezing fish by means of air at a temperature of -20°F or colder, moving at a velocity of not less than four hundred feet per minute.

(2) Where fish is frozen by the method referred to in subsection (1), the fish shall be removed from the freezing facility immediately after the temperature at the centre of the thickest section of the fish reaches -5°F. R.R.O. 1980, Reg. 395, s. 51.

52. Every cannery shall be equipped with one or more retorts equipped with,

- (a) a mercury-in-glass thermometer;
- (b) a pressure gauge;
- (c) a steam spreader; and

- (d) venting valves. R.R.O. 1980, Reg. 395, s. 52.

**PART VIII
GENERAL OPERATING REQUIREMENTS FOR
ESTABLISHMENTS**

53. No person who,

- (a) is known to be suffering from a communicable disease;
- (b) is a known carrier of a communicable disease; or
- (c) has an infected wound or open lesion on any part of his or her body,

shall be employed in any working area of an establishment. R.R.O. 1980, Reg. 395, s. 53.

54. Every person engaged in handling or processing fish in an establishment shall wash his or her hands thoroughly with warm water and liquid or powdered soap immediately before commencing each work shift and after each absence from duty. R.R.O. 1980, Reg. 395, s. 54.

55. No employee who handles fish with his or her bare hands in an establishment shall wear finger-nail polish. R.R.O. 1980, Reg. 395, s. 55.

56. All waterproof garments in an establishment shall be thoroughly cleaned after each work shift. R.R.O. 1980, Reg. 395, s. 56.

57. No person in an establishment shall smoke or spit in a working area. R.R.O. 1980, Reg. 395, s. 57.

58. Every toilet facility in an establishment shall be maintained in a clean condition and contain a supply of toilet tissue at all times. R.R.O. 1980, Reg. 395, s. 58.

59. All sewage from an establishment, including liquid waste from fish processing operations, shall be disposed of in such a manner that the sewage is inaccessible to flies and the water supply for the establishment does not become contaminated. R.R.O. 1980, Reg. 395, s. 59.

60. Offal and other refuse shall be removed from the processing area of an establishment at least once a day. R.R.O. 1980, Reg. 395, s. 60.

61. No person shall use an offal bin or receptacle in an establishment for a purpose other than the retention of offal. R.R.O. 1980, Reg. 395, s. 61.

62. No person shall permit a dog or other animal to be in an establishment. R.R.O. 1980, Reg. 395, s. 62.

63. Every operator of an establishment shall maintain a rodent and insect control program in the establishment and where a pesticide is used, it shall be used in such a manner that the pesticide does not contaminate any fish in the establishment. R.R.O. 1980, Reg. 395, s. 63.

64. No unnecessary material or equipment shall be stored in a working area of an establishment. R.R.O. 1980, Reg. 395, s. 64.

65. The grounds and beach of an establishment shall be kept clean. R.R.O. 1980, Reg. 395, s. 65.

66. Every establishment shall be equipped with brushes, brooms, hoses and other equipment and material for the cleaning of the establishment. R.R.O. 1980, Reg. 395, s. 66.

67. Except where it is to be further processed, frozen fish shall be protected to prevent a rise in the temperature of the fish when it is outside a refrigerated area. R.R.O. 1980, Reg. 395, s. 67.

68. Every establishment and all equipment and utensils used in the operation of an establishment shall be kept in good repair and in a clean and sanitary condition. R.R.O. 1980, Reg. 395, s. 68.

**PART IX
ADDITIONAL OPERATING REQUIREMENTS FOR
CANNERIES**

FRESH-FISH, FREEZING OR SEMI-PRESERVING ESTABLISHMENTS

69. Every operator of a cannery shall keep at the cannery a record for a period of not less than twelve months of the sterilization treatment used for each batch of fish at the cannery. R.R.O. 1980, Reg. 395, s. 69.

70. All water used in a cannery for cooling canned fish shall be chlorinated to give a chlorine residual of at least two parts per million. R.R.O. 1980, Reg. 395, s. 70.

71.—(1) All fish which are to be canned shall be thoroughly washed prior to canning.

(2) Round fish shall be thoroughly washed prior to processing.

(3) Where fish has been dressed, it shall be thoroughly washed prior to further processing. R.R.O. 1980, Reg. 395, s. 71.

72.—(1) No ice, other than ice made from water referred to in subsection 32 (1), shall be used in a cannery or a fresh-fish, freezing or semi-preserving establishment.

(2) Except for fire protection, boilers or auxiliary services, no water, other than water referred to in subsection 32 (1), shall be used in a cannery or a fresh-fish, freezing or semi-preserving establishment. R.R.O. 1980, Reg. 395, s. 72.

73. All protective hand coverings worn by employees in any processing area in a cannery or a fresh-fish, freezing or semi-preserving establishment shall be disinfected immediately after each break in a work shift and at the end of every work shift. R.R.O. 1980, Reg. 395, s. 73.

74.—(1) Except for a filleter, skinner, scaler, handler of round or dressed fish or a worker in a frozen storage room in a fresh-fish, freezing or semi-preserving establishment, every employee engaged in a fish processing operation in a cannery or a fresh-fish, freezing or semi-preserving establishment shall wear a clean coverall, smock or coat and headgear that completely covers the hair.

(2) All protective outer garments worn by an employee in a fish processing operation in a cannery shall be kept thoroughly cleaned.

(3) A filleter, skinner, scaler or handler of round or dressed fish in a fresh-fish, freezing or semi-preserving establishment shall wear clean outer garments and headgear that completely covers the hair.

(4) A worker in a frozen storage room in a fresh-fish, freezing or semi-preserving establishment shall wear clean outer garments. R.R.O. 1980, Reg. 395, s. 74.

75.—(1) Every utensil that comes in contact with fish before it is canned or packaged shall be thoroughly cleaned and disinfected at least once during each work shift and at the end of each work shift.

(2) Every utensil referred to in subsection (1) shall be air-dried and stored in a sanitary manner at the end of each working day. R.R.O. 1980, Reg. 395, s. 75.

76. All equipment, including conveyor belts and tables, that comes in contact with fish that is being processed, other than canned and packaged fish, shall be cleaned and disinfected at the end of each work shift. R.R.O. 1980, Reg. 395, s. 76.

77. Every floor in a wet working area in a cannery and a fresh-

fish, freezing or semi-preserving establishment shall be thoroughly washed and disinfected daily. R.R.O. 1980, Reg. 395, s. 77.

**PART X
ADDITIONAL OPERATING REQUIREMENTS FOR
FROZEN-STORAGE ESTABLISHMENTS**

78. Every room in a frozen-storage establishment in which frozen fish is stored shall be maintained at a temperature of -15°F or colder. R.R.O. 1980, Reg. 395, s. 78.

79.—(1) Every storage room in a frozen-storage establishment shall be equipped with a thermometer or other temperature-measuring device that is located in such a place that it indicates the average air temperature of the room.

(2) The temperature in a storage room in a frozen-storage establishment shall be read and recorded at least once each day and the record shall be retained for a period of not less than twelve months. R.R.O. 1980, Reg. 395, s. 79.

80. No odoriferous substance shall be stored with fish in a holding or storage room in a frozen-storage establishment. R.R.O. 1980, Reg. 395, s. 80.

**PART XI
TRANSPORTATION OF FISH**

81. Every vehicle used for the marketing of fish shall contain facilities that,

- (a) protect the fish from contamination and weather;
- (b) are in good repair and in a clean and sanitary condition;
- (c) where fresh or semi-preserved fish are being transported will maintain the fish in a chilled condition; and
- (d) where frozen fish are being transported will prevent the temperature of the frozen fish from increasing more than 10°F during transportation. R.R.O. 1980, Reg. 395, s. 81.

Forest Fires Prevention Act *Loi sur la prévention des incendies de forêt*

REGULATION 457

FIRE REGIONS

1. The parts of Ontario described in the Schedules are declared to be fire regions, and each fire region shall bear the name appearing as the heading of the Schedule. R.R.O. 1980, Reg. 396, s. 1.

FIRE PERMITS

2. A fire permit shall be in Form 1. R.R.O. 1980, Reg. 396, s. 2.

3. It is a condition of a fire permit that,

- (a) the permittee shall keep the permit at the site of the burning operation conducted under the permit; and
- (b) the person in charge of the burning operation conducted under the permit shall produce and show the permit to any officer whenever requested by the officer. R.R.O. 1980, Reg. 396, s. 3.

FOREST TRAVEL PERMITS

4. A forest travel permit shall be in Form 2. R.R.O. 1980, Reg. 396, s. 4.

FIRE PREVENTION AND SUPPRESSION

5. Every person who starts a fire out of doors for the purpose of cooking or obtaining warmth shall,

- (a) start the fire on a site that is bare rock or bare mineral soil or free from flammable materials; and
- (b) keep an area of at least three feet in width immediately outside the edge of the fire cleared to bare rock or to bare mineral soil or cleared of flammable materials. R.R.O. 1980, Reg. 396, s. 7.

6. No person shall operate an outdoor incinerator,

- (a) that is an unenclosed device;
- (b) that is constructed, in whole or in part, of combustible material;
- (c) unless the outlet is covered with a heavy duty screen having a mesh size not greater than one-quarter inch;
- (d) that is situate less than fifteen feet from a forest or woodland;
- (e) unless it is situate on bare rock or bare mineral soil; and
- (f) unless an area of at least five feet in width immediately surrounding the incinerator is bare rock or bare mineral soil. R.R.O. 1980, Reg. 396, s. 8.

7. Every person who starts a fire or causes a fire to be started out of doors shall,

- (a) take all reasonable steps to keep the fire under control;
- (b) ensure that a responsible person tends the fire;

(c) extinguish the fire before quitting the site of the fire; and

(d) where the fire is started under a fire permit, extinguish the fire or cause the fire to be extinguished on or before the expiration of the permit. R.R.O. 1980, Reg. 396, s. 9.

8.—(1) Except as otherwise provided in the work permit, every person who conducts or causes to be conducted any operation in respect of which the person is required by the Act to obtain a work permit and in which is engaged a number of persons specified in column 1 of an item of the Table shall provide on the operation in serviceable condition not less than the number of packpumps specified in column 2 of the item, the number of shovels specified in column 3 of the item, the number of axes specified in column 4 of the item, the number of portable fire pumps specified in column 5 of the item and the feet of fire hose specified in column 6 of the item.

(2) Every person conducting or causing to be conducted an operation mentioned in subsection (1) shall ensure that fifty per cent of the persons engaged in the operation are competent in the use in fire suppression of the equipment provided on the operation. R.R.O. 1980, Reg. 396, s. 10.

9. No person shall, in a forest or woodland,

- (a) start a power saw within ten feet of the place where it is fueled;
- (b) operate a power saw without having readily available a fire extinguisher that is in working condition; or
- (c) when the engine of a power saw is operating or is hot, place the power saw on any flammable material. R.R.O. 1980, Reg. 396, s. 11.

FIRE REGIONS

Schedule 1

NORTHWESTERN FIRE REGION

In the territorial districts of Kenora, Kenora-Patricia Portion and Rainy River, described as follows:

Beginning at the southeasterly corner of the geographic Township of Corman in the Territorial District of Kenora; thence northerly along the easterly boundary of the geographic townships of Corman and Chartrand and the northerly production of the easterly boundary of the Geographic Township of Chartrand to the southwesterly corner of G.T.P. Block No. 6; thence easterly along the south boundary of that block to the southeasterly corner thereof; thence northerly along the easterly boundary of that block and the northerly production of the easterly boundary of that Block No. 6 to the base line run by Phillips and Benner, Ontario Land Surveyors, in 1931; thence northeasterly in a straight line to the intersection of latitude 50° 00' with the meridian line run by K. G. Ross, Ontario Land Surveyor, in 1921; thence easterly along latitude 50° 00' to longitude 90° 00'; thence northerly along longitude 90° 00' to latitude 51° 00'; thence easterly along latitude 51° 00' to longitude 89° 00'; thence northerly along longitude 89° 00' to the southerly boundary of Wunnumin Lake Indian Reserve 86; thence easterly along that southerly boundary to the easterly boundary of that Indian Reserve; thence northerly along that easterly boundary to the northerly boundary of that Indian Reserve; thence westerly along that northerly boundary to longitude 89° 00'; thence northerly along longitude 89° 00' to latitude 54° 00'; thence westerly along latitude 54° 00' to the Interprovincial Boundary between Ontario and Manitoba; thence in a southwesterly

and southerly direction following that boundary to the International Boundary between Canada and the United States of America; thence in an easterly and southeasterly direction following that boundary to longitude 92° 30'; thence northerly along that longitude to the high-water mark along the southerly bank of the Seine River; thence easterly along that high-water mark to the southerly boundary of Indian Reserve 23A; thence easterly and northerly along that boundary to the high-water mark along the southerly bank of the Seine River; thence easterly along that high-water mark to the southerly limit of the right of way of that part of the King's Highway known as No. 11; thence easterly along that right of way to the southerly production of the easterly boundary of the Geographic Township of Bennett in the Territorial District of Rainy River; thence northerly along that southerly production and the easterly boundary of that geographic township and the northerly production of the easterly boundary of the Geographic Township of Bennett to the 3rd base line; thence westerly along that base line to the 5th meridian line; thence northerly along that meridian line to a line drawn west astronomically from the southwesterly corner of the Geographic Township of Grummett in the Territorial District of Kenora; thence east astronomically to the southwesterly corner of the Geographic Township of Grummett; thence easterly along the southerly boundary of the geographic townships of Grummett, Cathcart, McNevin and Corman to the place of beginning. R.R.O. 1980, Reg. 396, App. A, Sched. 1.

Schedule 2

NORTH CENTRAL FIRE REGION

In the territorial districts of Algoma, Cochrane, Kenora, Rainy River and Thunder Bay described as follows:

Beginning at the southeast corner of the geographic Township of Corman being a point on the east boundary of the Territorial District of Kenora; thence northerly along that boundary to the southwest corner of G.T.P. Block No. 6; thence easterly along the south boundary of that block to the southeast corner thereof; thence northerly along the east boundary of that block and the northerly production of that east boundary to the base line run by Phillips and Benner, Ontario Land Surveyors, in 1931; thence northeasterly in a straight line to the point of intersection of the parallel of latitude 50° 00' with the meridian line run by K.G. Ross, Ontario Land Surveyor, in 1921; thence easterly along the parallel of latitude 50° 00' to the line of longitude 90° 00'; thence northerly along the line of longitude 90° 00' to the parallel of latitude 51° 00'; thence easterly along the parallel of latitude 51° 00' to the line of longitude 89° 00'; thence northerly along the line of longitude 89° 00' to the southerly boundary of Wunnumin Lake Indian Reserve Number 86; thence easterly along that southerly boundary to the easterly boundary of that Indian Reserve; thence northerly along that easterly boundary to the northerly boundary of that Indian Reserve, thence westerly along that northerly boundary to the line of longitude 89° 00'; thence northerly along that line of longitude to the parallel of latitude 54° 00'; thence easterly along the parallel of latitude 54° 00' to the intersection with a line drawn in a course of north astronomic from the northwest corner of the geographic Township of Bicknell, in the Territorial District of Cochrane; thence south astronomically along that line to the northwest corner of the geographic Township of Bicknell; thence easterly along the north boundary of the last mentioned geographic township to the northeast corner thereof; thence southerly along the east boundary of the geographic townships of Bicknell, Boyce and Clavet to the northerly boundary of the geographic Township of Downer; thence easterly along the north boundary of the last mentioned geographic township to the northeast corner thereof; thence southerly along the east boundary of the geographic townships of Downer, Frances and Flanders to the southeast corner of the last mentioned geographic township; thence westerly along the south boundary of the last mentioned geographic township to the southwest corner thereof; thence southerly along the west boundary of the geographic townships of Foch and Drew to the northeast corner of the geographic Township of Spooner; thence westerly along the north boundary of the geographic Township of Spooner to the northwest corner thereof; thence southerly along the west boundary of the geographic Township of Spooner to the southwest corner thereof;

thence southerly in a straight line to the northeast corner of the geographic Township of McGill; thence westerly along the north boundary of the last mentioned geographic township to the northwest corner thereof; thence southerly along the west boundary of the last mentioned geographic township to the southwesterly corner thereof; thence west astronomically to the intersection with a line drawn in course of north astronomic from the northwest corner of the geographic Township of Laberge; thence south astronomically along that line to the northwest corner of the geographic Township of Laberge; thence southerly along the west boundary of the last mentioned geographic township to the northerly limit of the right-of-way of the Canadian Pacific Railway Company; thence westerly along the said northerly limit to the intersection with the east boundary of the geographic Township of Lecours; thence southerly along the said east boundary and its southerly production to the intersection with a line drawn on a course of east astronomic from southeast corner of the geographic Township of Pic; thence west astronomically along that line and continuing westerly along the south boundary of the said geographic Township of Pic to the intersection with the westerly boundary of Pukaskwa National Park; thence north 0° 38' 10" east along the said park boundary 780.468 metres; thence north 86° 31' 40" west along the said park boundary 2323.993 metres; thence north 2° 25' 50" east along the said park boundary 1014.761 metres; thence south 50° 26' 20" west along the said park boundary 129.174 metres; thence south 56° 08' 20" west along the said park boundary 266.282 metres; thence south 18° 25' 00" west along the said park boundary 486.571 metres; thence south 26° 00' 10" west along the said park boundary 200.683 metres; thence south 47° 18' 20" west along the said park boundary 306.376 metres; thence north 71° 56' 30" west along the said park boundary 183.596 metres; thence south 70° 34' 40" west along the said park boundary 329.245 metres, more or less, to the water's edge of Lake Superior; thence south 68° 00' west 9.656 kilometres; thence south 22° 00' east 25.750 kilometres; thence south 30° 00' west 82.077 kilometres, more or less, to the International Boundary between Canada and the United States of America; thence in a northwesterly, southwesterly and westerly direction following that International Boundary to the line of longitude 92° 30'; thence northerly along that line of longitude to the water's edge along the southerly shore of Seine River; thence in an easterly direction along that water's edge to the south boundary of Indian Reserve Number 23A; thence easterly along the south boundary of Indian Reserve Number 23A to the southeast corner thereof; thence northerly along the east boundary of Indian Reserve Number 23A to the water's edge along the southerly shore of Seine River; thence in an easterly direction along that water's edge to the southerly limit of the right of way of the King's Highway known as Number 11; thence easterly along that limit to the intersection with the southerly production of the east boundary of the geographic Township of Bennett; thence northerly along that southerly production and the east boundary of that township and the northerly production of that east boundary to the boundary between the territorial districts of Kenora and Rainy River; thence westerly along that boundary to the 5th Meridian Line as surveyed by A. Niven, Ontario Land Surveyor in 1897; thence northerly along that meridian line to the intersection with line drawn on a course of west astronomic from the southwest corner of the geographic Township of Grummett; thence east astronomically along that line to the southwest corner of the geographic Township of Grummett; thence easterly along the south boundary of the geographic townships of Grummett, Cathcart, McNevin and Corman to the place of beginning. O. Reg. 207/84, s. 1, *part*.

Schedule 3

NORTHERN FIRE REGION

In the territorial districts of Algoma, Cochrane, Kenora Patricia Portion, Sudbury and Timiskaming described as follows:

Beginning at the southwest corner of the geographic Township of Drew, in the Territorial District of Algoma; thence easterly along the south boundary of the geographic townships of Drew and Cholle to the northwest corner of the geographic Township of Bayfield; thence southerly along the west boundary of the geographic Township of Bayfield to the southwest corner thereof; thence easterly along the south boundary of the last mentioned township to the

northwest corner of the geographic Township of Gourlay; thence southerly along the west boundary of that township to the southwest corner thereof; thence easterly along the south boundary of the geographic townships of Gourlay, Breckenridge, Lizar, Ermine, Irving and Marjorie to the west boundary of the geographic Township of Hook; thence southerly along the west boundary of the last mentioned township to the southwest corner thereof; thence easterly along the south boundary of the geographic townships of Hook and Hayward to the west boundary of the geographic Township of Coderre; thence southerly along the west boundary of the geographic townships of Coderre and Lerwick to the northeast corner of the geographic Township of Kildare; thence westerly along the north boundary of that township to the northwest corner thereof; thence southerly along the west boundary of that township to a limit of the Missinaibi Provincial Park measured south 57° 00' west from a point distant 13100 metres measured south 77° 30' west from a point distance 1650 metres measured west astronomic from a point on the east boundary of the geographic Township of Kildare distant 6500 metres measured northerly thereon from the southeast corner thereof; thence south 57° 00' west along that limit of Missinaibi Provincial Park to the north boundary of the geographic Township of Baltic; thence westerly along the north boundary of the geographic townships of Baltic and Leeson to the northwest corner of the last mentioned township; thence southerly along the west boundary of the geographic townships of Leeson, Brackin and Lang to the southwest corner of the last mentioned township; thence westerly along the north boundary of the geographic Township of Bader to the northwest corner thereof; thence southerly along the west boundary of the geographic townships of Bader, Hornell and D'Avaugour to the southwest corner of the last mentioned township; thence easterly along the south boundary of that township to the northwest corner of the geographic Township of Cosens; thence southerly along the west boundary of the geographic townships of Cosens, Topham, Windigo, Beilhartz, Engstrom, Hammond and Moen to the southwest corner of the last mentioned township; thence easterly along the south boundary of the geographic townships of Moen, Moggy and Neill to the southeast corner of the last mentioned township; thence northerly along the east boundary of that township to the southwest corner of the geographic Township of Patenaude; thence easterly along the south boundary of that township to the southeast corner thereof; thence southerly along the west boundary of the geographic Township of Carruthers to the southwest corner thereof; thence easterly along the south boundary of the geographic townships of Carruthers, Cassidy, Deans, Drey, Duksza and Eaton to the southeast corner of the last mentioned township; thence southerly along the west boundary of the geographic townships of Guindon and McKeough to the southwest corner of the last mentioned township; thence easterly along the south boundary of the geographic townships of McKeough, Fulton, Gladwin, Ivy, Earl, Specht, Breadner, Battersby, Dublin, Onaping, Scotia, Frechette, McNamara and Cotton to the southeast corner of the last mentioned township; thence northerly along the east boundary of the geographic townships of Cotton, Valin and Stull to the south boundary of the geographic Township of Dufferin; thence easterly along the south boundary of the geographic townships of Dufferin and Leckie to the southeast corner of the last mentioned township; thence northerly along the east boundary of that township to the northeast corner thereof; thence westerly along the north boundary of that township to the southeast corner of the geographic Township of Ray; thence northerly along the east boundary of that township to the southwest corner of the geographic Township of Charters; thence easterly along the south boundary of the geographic townships of Charters and Corkill to the southeast corner of the last mentioned township; thence northerly along the east boundary of that township to the southwest corner of the geographic Township of Roadhouse; thence easterly along the south boundary of the geographic townships of Roadhouse, Willet, Barber, Cane and Henwood to the southwest corner of the Township of Kerns; thence easterly along the south boundary of the townships of Kerns, Harley and Casey to the Interprovincial Boundary between Ontario and Quebec; thence in a northerly direction along that Interprovincial Boundary to the shore of James Bay; thence southwest-erly, northwesterly, northerly and northwesterly following the shore of James Bay and Hudson Bay to the Interprovincial Boundary between Ontario and Manitoba; thence in a southwesterly direction along that Interprovincial Boundary to the intersection with the

westerly production of a line joining the intersection of the line of longitude 91° 30' and the parallel of latitude 55° 00' with the intersection of the line of longitude 89° 00' and the parallel of latitude 54° 00'; thence southeasterly along that production and that line to the intersection with the line of longitude 89° 00' and the parallel of latitude 54° 00'; thence easterly along the parallel latitude 54° 00' to the intersection with a line drawn on a course of north astronomic from the northwest corner of the geographic Township of Bicknell; thence south astronomically along that line to the northwest corner of the geographic Township of Bicknell; thence easterly along the north boundary of that township to the northwest corner of the geographic Township of Burrell; thence southerly along the west boundary of the geographic townships of Burrell, Shuel and Kohler to the southwest corner of the last mentioned township; thence easterly along the south boundary of that township to the northwest corner of the geographic Township of Mercer; thence southerly along the west boundary of the geographic townships of Mercer, Hiawatha and Nagagami to the southwest corner of the last mentioned township; thence westerly along the north boundary of the geographic township of Foch to the northwest corner thereof; thence southerly along the west boundary of the geographic townships of Foch and Drew to the place of beginning. O. Reg. 13/86, s. 1, *part*.

Schedule 4

NORTHEASTERN FIRE REGION

In the territorial districts of Algoma, Manitoulin, Nipissing, Parry Sound, Sudbury, Thunder Bay and Timiskaming described as follows:

Beginning at the northeast corner of the geographic Township of Mildred, in the Territorial District of Algoma; thence southerly along the east boundary of that township to the southeast corner thereof; thence easterly along the north boundary of the geographic townships of Nebotik and Conking to the northeast corner of the last mentioned township; thence southerly along the east boundary of that township to the southeast corner thereof; thence westerly along the south boundary of the geographic Township of Conking to the northeast corner of the geographic Township of Abigo; thence southerly along the east boundary of the last mentioned township to a limit of the Missinaibi Provincial Park measured south 57° 00' west from a point distant 13100 metres measured south 77° 30' west from a point distance 1650 metres measured west astronomic from a point on the east boundary of the geographic Township of Kildare distant 6500 metres measured northerly thereon from the southeast corner thereof; thence south 57° 00' west along that limit of Missinaibi Provincial Park to the south boundary of the geographic Township of Abigo; thence westerly along the south boundary of the geographic townships of Abigo, Amik and Winget to the northeast corner of the geographic Township of Rennie; thence southerly along the east boundary of the geographic townships of Rennie, Stover and Marsh to the southeast corner of the last mentioned township; thence westerly along the south boundary of that township to the southwest corner thereof; thence southerly along the east boundary of the geographic townships of Echum, Laforme, and Nadjiwon to the southeast corner of the last mentioned township; thence easterly along the north boundary of the geographic Township of Recollect to the northeast corner thereof; thence southerly along the east boundary of the geographic townships of Recollect, Shawkence, Wawia, Behmann, Emiry, Hallett and McParland to the northwest corner of the geographic Township of Schembri; thence easterly along the north boundary of the geographic townships of Schembri, Scriven and Sherratt to the northeast corner of the last mentioned township; thence northerly along the west boundary of the geographic Township of Carton to the northwest corner thereof; thence easterly along the north boundary of that township to the northeast corner thereof; thence southerly along the east boundary of the geographic Township of Carton to the northwest corner of the geographic Township of Ferrier; thence easterly along the north boundary of the geographic townships of Ferrier, Foulds, Gaunt, Gilbertson, Gisborn and Grossman to the northeast corner of the last mentioned township; thence southerly along the east boundary of the geographic townships of Grossman and Leluk to the southeast corner of the last mentioned township; thence easterly along the north boundary of the

geographic townships of Parrott, Comox, Ethel, Durban, Jasper, Alton, Lafleche, Athlone, Muldrew, Fairbairn, Dunbar, Sweeny, Beaumont and Beresford to the northeast corner of the last mentioned township; thence northerly along the west boundary of the geographic townships of Howey, Haentschel and McLeod to the northwest corner of the last mentioned township; thence easterly along the north boundary of the geographic townships of McLeod and Ellis to the southwest corner of the geographic Township of Corley; thence northerly along the west boundary of that township to the northwest corner thereof; thence westerly along the south boundary of the geographic Township of Donovan to the southwest corner thereof; thence northerly along the west boundary of that township to the northwest corner thereof; thence easterly along the north boundary of the geographic townships of Donovan and Brewster to the northeast corner of the last mentioned geographic township; thence northerly along the west boundary of the geographic Township of Wallis to the northwest corner thereof; thence easterly along the north boundary of the geographic townships of Wallis, Banks, Speight, Auld, and Lundy to the northwest corner of the Township of Hudson; thence easterly along the north boundary of the townships of Hudson, Dymond and Harris to the Interprovincial Boundary between Ontario and Quebec; thence in a southerly and southeasterly direction following that Interprovincial Boundary to the northeasterly corner of the Improvement District of Cameron; thence southerly along the easterly boundary of the Improvement District of Cameron to the northeasterly corner of the geographic Township of Deacon; thence westerly along the northerly boundary of the geographic Township of Deacon to a point thereon distant 2048.518 metres measured south 20° 48' 25" east from a point distant 5427.680 metres measured north 69° 08' 20" east from a point in the easterly boundary of the geographic Township of Boyd distant 4084.354 metres measured northerly thereon from the southeasterly corner thereof; thence north 20° 48' 25" west 2048.518 metres; thence south 69° 08' 20" west 5427.680 metres to a point in the easterly boundary of the geographic Township of Boyd distant 4084.354 metres measured northerly thereon from the southeasterly corner thereof; thence northerly along the easterly boundary of the geographic Township of Boyd to the intersection with the centre line of the allowance for road between former concessions X and XI in the said township; thence south 69° 06' west 6095.994 metres; thence south 65° 16' west 1214.874 metres; thence south 65° 26' 30" west 259.147 metres; thence north 22° 01' 30" west 2122.705 metres; thence south 69° 07' 00" west 4161.748 metres; thence south 22° 01' 30" east 2216.217 metres; thence south 68° 46' west 411.811 metres; thence south 69° 08' west 417.846 metres; thence south 68° 57' west 401.753 metres; thence south 68° 29' west 401.753 metres; thence south 68° 38' west 813.564 metres to the easterly boundary of the geographic Township of Pentland; thence northerly along the easterly boundary of that township to the northeasterly corner thereof; thence westerly along the southerly boundary of the geographic Township of Lauder to the survey monument opposite the line between former lots 12 and 13, Concession I, in the said township; thence north 20° 51' 40" west 2172 metres; thence south 69° 08' 50" west 3850.126 metres; thence south 20° 49' 40" east 2172.833 metres to the southerly boundary of the geographic Township of Lauder; thence westerly along that southerly boundary of that township to the southwesterly corner thereof; thence southerly along the easterly boundary of the geographic Township of Boulter to the southeasterly corner thereof; thence westerly along the southerly boundary of that township to the southwesterly corner thereof; thence continuing westerly along the northerly boundary of the geographic townships of Ballantyne and Laurier to the northwesterly corner of the last mentioned township; thence continuing westerly along the northerly boundary of the Township of Machar to the northwesterly corner thereof; thence westerly along the southerly boundary of the geographic townships of Pringle and East Mills to the southwesterly corner of the last mentioned township; thence northerly along the westerly boundary of the geographic townships of East Mills and Hardy to the water's edge along the southerly shore of the Memesagamesing River; thence in a general northwesterly direction following that water's edge to the intersection with the water's edge along the southerly shore of the French River Main Channel; thence north astronomically to the intersection with the boundary between the territorial districts of Parry Sound and Sudbury; thence in a general westerly and southwesterly direction following that boundary to the

intersection with the westerly limit of the right-of-way of the Canadian National railway line; thence in a southeasterly direction following that limit to Key Junction; thence southerly along the westerly limit of an abandoned right-of-way of the Canadian National railway line to the intersection with a line drawn east astronomic from the point on the water's edge at the most northerly extremity of Pine Island in Key Harbour; thence west astronomically 0.520 kilometres, more or less, to a point distant 0.060 kilometres measured westerly from the high water mark of the mainland immediately east of Pine Island; thence south astronomically 0.380 kilometres; thence south 72° 00' west 0.350 kilometres; thence north 83° 00' west 1.750 kilometres; thence south 85° 30' west 1.200 kilometres; thence south 43° 00' west 2.030 kilometres; thence north 88° 00' west 2.480 kilometres, thence southwesterly in a straight line to the southeast corner of the Territorial District of Manitoulin being distant 64.374 kilometres measured south astronomic from the southeast corner of the geographic Township of Humboldt; thence west astronomically along the south boundary of the last mentioned territorial district to the International Boundary between Canada and the United States of America; thence in a general northwesterly direction following that International Boundary to the intersection with a line drawn south 30° 00' west from a point distant 25.750 kilometres measured south 22° 00' east from a point distant 9.656 kilometres measured south 68° 00' west from the intersection of the westerly boundary of Pukaskwa National Park with the water's edge of Lake Superior; thence north 30° 00' east 82.077 kilometres; thence north 22° 00' west 25.750 kilometres; thence north 68° 00' east 9.656 kilometres, more or less, to the intersection of the westerly boundary of Pukaskwa National Park with the water's edge of Lake Superior; thence north 70° 34' 40" east along that park boundary 329.245 metres; thence south 71° 56' 30" east along that park boundary 183.596 metres; thence north 47° 18' 20" east along that park boundary 306.376 metres; thence north 26° 00' 10" east along that park boundary 200.863 metres; thence north 18° 25' 00" east along that said park boundary 486.571 metres; thence north 56° 08' 20" east along that park boundary 266.282 metres; thence north 50° 26' 20" east along that park boundary 129.174 metres; thence south 2° 25' 50" west along that park boundary 1014.761 metres; thence south 86° 31' 40" east along that park boundary 2323.993 metres; thence south 0° 38' 10" west along that park boundary 780.468 metres to the south boundary of the geographic Township of Pic; thence easterly along that south boundary and its easterly production to the intersection with the southerly production of the east boundary of the geographic Township of Lecours; thence northerly along that southerly production and the east boundary of the geographic Township of Lecours to the northerly limit of the right-of-way of the Canadian Pacific railway line; thence easterly along that northerly limit to the west boundary of the geographic Township of Laberge; thence northerly along that west boundary of the northwest corner of the geographic Township of Laberge; thence northerly along the northerly production of the west boundary of that township to the intersection with the westerly production of the south boundary of the geographic township of McGill; thence easterly along that westerly production to the southwest corner of the geographic Township of McGill; thence northerly along the west boundary of that township to the northwest corner thereof; thence easterly along the north boundary of that township to the northeast corner thereof; thence northerly in a straight line to the southwest corner of the geographic Township of Spooner; thence northerly along the west boundary of that township to the northwest corner thereof; thence easterly along the north boundary of the geographic Township of Spooner to the west boundary of the geographic Township of Drew; thence southerly along that west boundary to the northwest corner of the geographic Township of Welsh; thence easterly along the north boundary of the geographic townships of Welsh and Matthews to the northeast corner of the last mentioned township; thence southerly along the east boundary of the geographic Township of Matthews to the north boundary of the geographic Township of Hambleton; thence easterly along that north boundary to the northeast corner of the geographic Township of Hambleton; thence southerly along the east boundary of that township to the northwest corner of the geographic Township of Strickland; thence easterly along the north boundary of the geographic townships of Strickland, Nameigos, Mosambik, Carney, Martin and Mildred to the place of beginning. O. Reg. 13/86, s. 1, part.

Schedule 5

ALGONQUIN FIRE REGION

In the territorial districts of Parry Sound and Nipissing, The District Municipality of Muskoka, and the counties of Haliburton, Hastings, Lennox and Addington, Peterborough, Renfrew, Simcoe and Victoria, described as follows:

Beginning at the northwesterly corner of the Township of Matchedash; thence southerly along the westerly boundary of the Township of Matchedash to the southwesterly corner thereof; thence easterly along the southerly boundary of that township to the intersection with the centre line of the allowance for road between concessions II and III, Northern Division, in the Township of Orillia; thence southerly along that centre line to the intersection with the westerly production of the southerly limit of Lot 19, Concession III, Northern Division, in the Township of Orillia; thence easterly along that production to the southwesterly corner of said Lot 19; thence easterly along the south limit of said Lot 19 to the southeasterly corner thereof; thence easterly in a straight line across the allowance for road between concessions III and IV to the southwesterly corner of Lot 19, Concession IV, Northern Division; thence easterly along the southerly limit of said Lot 19 to the northeasterly corner thereof; thence easterly in a straight line across the allowance for road between concessions IV and V to the southwesterly corner of Lot 19, Concession V, Northern Division; thence easterly along the southerly limit of said Lot 19 to the southeasterly corner thereof; thence easterly in a straight line across the allowance for road between concessions V and VI to the southwesterly corner of Lot 19, Concession VI, Northern Division; thence easterly along the southerly limit of said Lot 19 to the southeasterly corner thereof; thence easterly in a straight line across the allowance for road between concessions VI and VII to the southwesterly corner of Lot 19, Concession VII, Northern Division; thence easterly along the southerly limit of said Lot 19 to the southeasterly corner thereof; thence easterly in a straight line across the allowance for road between concessions VII and VIII to the southwesterly corner of Lot 19, Concession VIII, Northern Division; thence easterly along the southerly limit of said Lot 19 to the southeasterly corner thereof; thence easterly in a straight line across the allowance for road between concessions VIII and IX to the southwesterly corner of Lot 19, Concession IX, Northern Division; thence easterly along the southerly limit of said Lot 19 to the southeasterly corner thereof; thence easterly in a straight line across the allowance for road between concessions IX and X to the southwesterly corner of Lot 19, Concession X, Northern Division; thence easterly along the southerly limit of said Lot 19 to the southeasterly corner thereof; thence easterly in a straight line across the allowance for road between concessions X and XI to the southwesterly corner of Lot 19, Concession XI, Northern Division; thence easterly along the southerly limit of said Lot 19 to the southeasterly corner thereof; thence easterly in a straight line across the allowance for road between concessions XI and XII to the southwesterly corner of Lot 19, Concession XII, Northern Division; thence easterly along the southerly limit of said Lot 19 to the southeasterly corner thereof; thence easterly in a straight line across the allowance for road between concessions XII and XIII to the southwesterly corner of Lot 19, Concession XIII, Northern Division; thence easterly along the southerly limit of said Lot 19 to the southeasterly corner thereof; thence easterly in a straight line across the allowance for road between concessions XIII and XIV to the southwesterly corner of Lot 19, Concession XIV, Northern Division; thence easterly along the southerly limit of said Lot 19 to the southeasterly corner thereof; thence continuing easterly along the production of the southerly limit of said Lot 19 to the intersection with the south boundary of the Town of Gravenhurst, in The District Municipality of Muskoka; thence southerly and easterly along that boundary to the northwesterly corner of the Township of Dalton; thence southerly along the westerly boundary of the townships of Dalton and Carden to the southwesterly corner of the last mentioned township; thence easterly along the south boundary of the Township of Carden to the westerly boundary of the Township of Bexley; thence southerly along the westerly boundary of the Township of Bexley to the southwesterly corner thereof; thence easterly along the southerly boundary of the townships of Bexley and Somerville to the westerly boundary of the

Township of Harvey; thence southerly along that westerly boundary to the boundary between the townships of Harvey and Verulam; thence easterly, southerly and easterly along the southerly boundary of the Township of Harvey to the southwesterly corner of the Township of Burleigh and Anstruther; thence easterly along the southerly boundary of the last mentioned township to the westerly boundary of the Township of Dummer; thence southerly along the westerly boundary of the Township of Dummer to the southwesterly corner thereof; thence easterly along the southerly boundary of the last mentioned township to the westerly boundary of the Township of Belmont and Methuen; thence southerly along that boundary to the southwesterly corner of the last mentioned township; thence easterly along the southerly boundary of the Township of Belmont and Methuen to the southeasterly corner thereof; thence northerly along the easterly boundary of the last mentioned township to the northwesterly corner of the Township of Marmora and Lake; thence easterly along the northerly boundary of the last mentioned township to the northeasterly corner thereof; thence easterly along the southerly boundary of the Township of Limerick to the southeasterly corner thereof; thence easterly along the northerly boundary of the Township of Elzevir and Grimsthorp to the northeasterly corner thereof; thence northerly along the easterly boundary of the Township of Tudor and Cashel, being also the easterly boundary of the former Township of Cashel, to the northeasterly corner thereof; thence northerly along the easterly boundary of the Township of Mayo to the southerly boundary of the Township of Raglan; thence easterly along the southerly boundary of the Township of Raglan to the southwesterly corner of the Township of Brudenell and Lyndoch; thence easterly along the southerly boundary of the last mentioned township to the southeasterly corner thereof; thence southerly along the westerly boundary of the Township of Griffith and Matawatchan to the southwesterly corner thereof; thence easterly along the southerly boundary of the Township of Griffith and Matawatchan to the southeasterly corner thereof; thence northerly along the easterly boundary of the last mentioned township to the southwesterly corner of the Township of Brougham; thence in a general northeasterly direction along the southerly boundary of the last mentioned township to the southeasterly corner thereof; thence southerly along the westerly boundary of the Township of Bagot and Blithfield to the most southerly corner thereof; thence easterly along the southerly boundary of the Township of Blithfield and Bagot and the Township of McNab to the intersection with the Interprovincial Boundary between Ontario and Quebec; thence in a general northwesterly direction following the said Interprovincial Boundary to the northwesterly corner of the Improvement District of Cameron; thence southerly along the easterly boundary of the Improvement District of Cameron to the northeasterly corner of the geographic Township of Deacon; thence westerly along the northerly boundary of the geographic Township of Deacon to a point thereon distant 2048.518 metres measured south 20° 48' 25" east from a point distant 5427.680 metres measured north 69° 08' 20" east from a point in the easterly boundary of the geographic Township of Boyd distant 4084.354 metres measured northerly thereon from the southeasterly corner thereof; thence north 20° 48' 25" west 2048.518 metres; thence south 69° 08' 20" west 5427.680 metres to a point in the easterly boundary of the geographic Township of Boyd distant 4084.354 metres measured northerly thereon from the southeasterly corner thereof; thence northerly along the easterly boundary of the geographic Township of Boyd to the intersection with the centre line of the allowance for road between former concessions X and XI in the said township; thence south 69° 06' west 6095.994 metres; thence south 65° 16' west 1214.874 metres; thence south 65° 26' 30" west 259.147 metres; thence north 22° 01' 30" west 2122.705 metres; thence south 69° 07' 00" west 4161.748 metres; thence south 22° 01' 30" east 2216.217 metres; thence south 68° 46' west 411.811 metres; thence south 69° 08' west 417.846 metres; thence south 68° 57' west 401.753 metres; thence south 68° 29' west 401.753 metres; thence south 68° 38' west 813.564 metres to the easterly boundary of the geographic Township of Pentland; thence northerly along the easterly boundary of the last mentioned township to the northeasterly corner thereof; thence westerly along the southerly boundary of the geographic Township of Lauder to the survey monument opposite the line between former lots 12 and 13, Concession I, in the said township; thence north 20° 51' 40" west 2172.000 metres; thence south 69° 08' 50" west 3850.126 metres; thence south 20° 49' 40" east 2172.833

metres to the southerly boundary of the geographic Township of Lauder; thence westerly along the southerly boundary of the last mentioned township to the southwesterly corner thereof; thence southerly along the easterly boundary of the geographic Township of Boulter to the southeasterly corner thereof; thence westerly along the southerly boundary of the last mentioned township to the southwesterly corner thereof; thence continuing westerly along the northerly boundary of the geographic townships of Ballantyne and Laurier to the northwesterly corner of the last mentioned township; thence continuing westerly along the northerly boundary of the Township of Machar to the northwesterly corner thereof; thence westerly along the southerly boundary of the geographic townships of Pringle and East Mills to the southwesterly corner of the last mentioned township; thence northerly along the westerly boundary of the geographic townships of East Mills and Hardy to the water's edge along the southerly shore of the Memesagamesing River; thence in a general northwesterly direction following the said water's edge to the intersection with the water's edge along the southerly shore of the French River Main Channel; thence north astronomically to the intersection with the boundary between the territorial districts of Parry Sound and Sudbury; thence in a general westerly and southwesterly direction following that boundary to the intersection with the westerly limit of the right-of-way of the Canadian National railway line; thence in a southeasterly direction following the said westerly limit to Key Junction; thence southerly along the westerly limit of an abandoned right-of-way of the Canadian National Railway Company to the intersection with a line drawn east astronomic from the point on the water's edge at the most northerly extremity of Pine Island in Key Harbour; thence west astronomically 0.520 kilometres, more or less, to a point distant 0.060 kilometres measured westerly from the high water mark of the mainland immediately east of Pine Island; thence south astronomically 0.380 kilometres; thence south 72° 00' west 0.350 kilometres; thence north 83° 00' west 1.750 kilometres; thence south 85° 30' west 1.200 kilometres; thence south 43° 00' west 2.030 kilometres; thence north 88° 00' west 2.480 kilometres; thence southwesterly in a straight line to the southeast corner of the Territorial District of Manitoulin being distant 64.374 kilometres measured south astronomically from the southeast corner of the geographic Township of Humboldt; thence southeasterly in a straight line to the intersection of the line of longitude 80° 30' with the parallel of latitude 45° 00'; thence southeasterly in a straight line to the most northerly point on the water's edge along the shore of Giants Tomb Island; thence east astronomically to the westerly boundary of the Township of Georgian Bay; thence southeasterly and northeasterly along that boundary to the place of beginning. O. Reg. 13/86, s. 1, *part*.

the northerly boundary of that township to the northeasterly corner thereof; thence easterly along the southerly boundary of the Township of Limerick to the southeasterly corner thereof; thence easterly along the northerly boundary of the Township of Elzevir and Grimsthorpe to the northeasterly corner thereof; thence northerly along the easterly boundary of the Township of Tudor and Cashel, being also the easterly boundary of the former Township of Cashel, to the northeasterly corner thereof; thence northerly along the easterly boundary of the Township of Mayo to the southerly boundary of the Township of Raglan; thence easterly along the southerly boundary of the Township of Raglan to the southwesterly corner of the Township of Brudenell and Lyndoch; thence easterly along the southerly boundary of the last mentioned township to the southeasterly corner thereof; thence southerly along the westerly boundary of the Township of Griffith and Matawatchan to the southwesterly corner thereof; thence easterly along the southerly boundary of the Township of Griffith and Matawatchan to the southeasterly corner thereof; thence northerly along the easterly boundary of the last mentioned township to the southwesterly corner of the Township of Brougham; thence in a general northeasterly direction along the southerly boundary of the last mentioned township to the southeasterly corner thereof; thence southerly along the westerly boundary of the Township of Bagot and Blithfield to the most southerly corner thereof; thence easterly along the southerly boundary of the Township of Bagot and Blithfield and the Township of McNab to the most northerly corner of the Township of Pakenham; thence southeasterly along the northeasterly boundary of the townships of Pakenham and Ramsay to the most easterly corner of the last mentioned township; thence southwesterly along the southeasterly boundary of the townships of Ramsay and Lanark and of the Township of Lavant, Dalhousie and North Sherbrooke to the easterly boundary of the Township of Oso; thence southerly along the easterly boundary of the last mentioned township to the southeasterly corner thereof; thence southeasterly along the northeasterly boundary of the Township of Bedford to the most easterly corner thereof; thence westerly along the southerly boundary of the townships of Bedford, Hichinbrooke and Sheffield to the southwesterly corner of the last mentioned township; thence southerly along the easterly boundary of the Township of Hungerford to the southeasterly corner thereof; thence westerly along the southerly boundary of the townships of Hungerford and Huntingdon to the southwesterly corner of the last mentioned township; thence northerly along the westerly boundary of the Township of Huntingdon to the northwesterly corner thereof; thence westerly along the southerly boundary of the Township of Madoc and the Township of Marmora and Lake to the place of beginning. O. Reg. 13/86, s. 1, *part*.

Schedule 6

EASTERN FIRE REGION

In the counties of Frontenac, Hastings, Lanark and Lennox and Addington described as follows:

Beginning at the southwesterly corner of the Township of Marmora and Lake; thence northerly along the westerly boundary of that township to the northwesterly corner thereof; thence easterly along

Schedule 7

SOUTHWESTERN FIRE REGION

The townships of,

- (a) Albemarle, Amabel, Eastnor, Lindsay and St. Edmunds in the County of Bruce; and
- (b) Keppel in the County of Grey. O. Reg. 13/86, s. 1, *part*.

TABLE

ITEM	COLUMN 1	COLUMN 2	COLUMN 3	COLUMN 4	COLUMN 5	COLUMN 6
	No. of Persons	Packpumps	Shovels	Axes	Portable Fire Pumps	Feet of Fire Hose
1.	1	0	1	0	0	0
2.	2	0	1	1	0	0
3.	3	1	2	1	0	0
4.	4	2	2	1	0	0
5.	5	3	3	2	0	0
6.	6-10	5	5	3	0	0

ITEM	COLUMN 1	COLUMN 2	COLUMN 3	COLUMN 4	COLUMN 5	COLUMN 6
	No. of Persons	Packpumps	Shovels	Axes	Portable Fire Pumps	Feet of Fire Hose
7.	11-20	8	10	5	0	0
8.	21-30	10	15	7	0	0
9.	31-40	15	15	10	1	2500
10.	41-50	18	20	15	1	2500
11.	51-60	20	25	20	1	2500
12.	61-70	25	25	25	2	5000
13.	71 or more	30	30	30	2	5000

R.R.O. 1980, Reg. 396, App. B, Sched. 1.

Form 1

Forest Fires Prevention Act

FIRE PERMIT

Under the *Forest Fires Prevention Act* and the regulations, and subject to the limitations thereof, and subject also to the terms and conditions herein, this permit is issued to

.....
name in full of permittee in block letters

.....
post office address telephone no.

to start a fire upon the following lands:

Township Lot Concession

Subdivision: Lot Plan

Mining Claim No. Location No.

Base Map No. Other

for the purpose of Incinerator Brush Burning

Land Clearing

Other

from the day of, 19.... to and

including the day of, 19....,

subject to the following terms and conditions:

1. The permittee shall keep this permit at the site of the burning operation conducted under this permit.
2. The person in charge of the burning operation conducted under this permit shall produce and show this permit to any officer whenever requested by the officer.

3. This permit is not valid between
and local time of each day.

4. The amount to be burned at any one time shall not exceed
..... acres
piles windrows.

5. All slash and land clearing debris shall be in piles or windrows separated by a distance of at least feet.
Windrows shall not exceed feet in length.

6. The permittee shall have at the location of the fire...persons and the following firefighting equipment in serviceable condition:
.....
.....

7. The permittee shall report wildfires to

8. Other terms and conditions.....
.....
.....

.....
(place of issue) (date of issue)

.....
(signature of permittee) (signature of issuing officer)

R.R.O. 1980, Reg 396, Form 1.

Form 2

Forest Fires Prevention Act

FOREST TRAVEL PERMIT

Under the *Forest Fires Prevention Act* and the regulations, and subject to the limitations thereof, and subject also to the terms and conditions herein, this permit is issued to

.....
(name in full of permittee in block letters)

.....
(post office address)

to enter and travel about in
(restricted travel zone)

.....
or description of such part thereof in which travel

.....
is permitted)

from and including the day of, 19.....

to and including the day of, 19.....,
subject to the following conditions:

..... (place of issue) (date of issue)

..... (signature of permittee) (signature of issuing officer)

R.R.O. 1980, Reg. 396, Form 2.

Forestry Act *Loi sur les forêts*

REGULATION 458

NURSERIES

1. In this Regulation,

“Christmas tree plantation” means a group of coniferous trees that are planted or growing on land for the production of Christmas trees;

“private land” means land not vested in Her Majesty in right of Ontario, but includes unpatented land that is located or sold under the *Public Lands Act*;

“shelter” includes shelter of land or structures;

“shelter belt” means a belt of trees for shelter, planted or growing at least one metre and not more than two metres apart in one or more rows at least sixty metres in length and at least one metre apart;

“unit” means a seedling, transplant, tree or cutting;

“wood” means a group of trees planted or growing on at least 0.5 of a hectare of land with at least 250 trees on each 0.5 hectare of land. R.R.O. 1980, Reg. 397, s. 1.

2. The Minister is authorized to establish nurseries at Dryden, Thunder Bay, Kemptville, Midhurst, Orono, St. Williams and Swastika. R.R.O. 1980, Reg. 397, s. 2.

3.—(1) An application for nursery stock shall be prepared in the form provided by the Minister. R.R.O. 1980, Reg. 397, s. 3 (1).

(2) An application shall not be made for fewer than 100 units,

except an application for nursery stock made available under an approved participatory forest research program, in which case an application may be made for twenty-five units, but only one such application for twenty-five units may be made by any person. O. Reg. 30/83, s. 1.

(3) An application for more than 100 units shall be for whole number multiples of fifty units.

(4) Subject to subsections (2) and (3), an application shall not be made for fewer than fifty units of a species.

(5) Subject to subsections (2) and (3), an application for more than fifty units of a species shall be for whole number multiples of fifty units of the species. R.R.O. 1980, Reg. 397, s. 3 (3-5).

4. Nursery stock may be furnished in respect of private land having an area of at least two hectares exclusive of any part occupied by structures or having a lesser area where nursery stock is made available under an approved participatory forest research program. O. Reg. 30/83, s. 2.

5. Nursery stock may be furnished for enlarging, establishing and replenishing a Christmas tree plantation, shelter belt or wood, or for the purposes of an approved participatory forest research program. O. Reg. 30/83, s. 3.

6. The charges to be made for nursery stock at a nursery are \$10 plus 7.5 cents for each unit except for stock made available under an approved participatory forest research program, in which case the charges are \$25 for twenty-five units. O. Reg. 590/88, s. 1

7. No nursery stock shall be furnished until the amount of charges for the nursery stock has been received by the Minister. R.R.O. 1980, Reg. 397, s. 7.

Freedom of Information and Protection of Privacy Act *Loi sur l'accès à l'information et la protection de la vie privée*

REGULATION 459

DISPOSAL OF PERSONAL INFORMATION

1. In this Regulation, "Archives" means the Archives of Ontario. O. Reg. 15/89, s. 1.

2. An institution may dispose of personal information only by transferring it to the Archives or by destroying it. O. Reg. 15/89, s. 2.

3. Where personal information is in the custody or under the control of an institution, no person shall destroy it without the authorization of the head. O. Reg. 15/89, s. 3.

4.—(1) Every head shall ensure that all reasonable steps are taken to protect the security and confidentiality of personal information that is to be destroyed, including protecting its security and confidentiality during its storage, transportation, handling and destruction.

(2) Every head shall ensure that all reasonable steps are taken to

protect the security and confidentiality of personal information that is to be transferred to the Archives, including protecting its security and confidentiality during its storage, transportation and handling.

(3) In determining whether all reasonable steps are taken under subsection (1) or (2), the head shall consider the nature of the personal information to be destroyed or transferred. O. Reg. 15/89, s. 4.

5. Every head shall take all reasonable steps to ensure that when personal information is to be destroyed, it is destroyed in such a way that it cannot be reconstructed or retrieved. O. Reg. 15/89, s. 5.

6.—(1) Every head of an institution shall ensure that the institution maintains a disposal record setting out what personal information has been destroyed or transferred to the Archives and the date of that destruction or transfer.

(2) The head shall ensure that the disposal record maintained under subsection (1) does not contain personal information. O. Reg. 15/89, s. 6.

REGULATION 460

GENERAL

1.—(1) The agencies, boards, commissions, corporations and other bodies listed in Column 1 of the Schedule are designated as institutions.

(2) The person occupying the position listed in Column 2 of the Schedule opposite to each institution listed in Column 1 is designated as the head of that institution. O. Reg. 516/90, s. 1.

2. A record capable of being produced from machine readable records is not included in the definition of "record" for the purposes of the Act if the process of producing it would unreasonably interfere with the operations of an institution. O. Reg. 516/90, s. 2.

3.—(1) A head who provides access to an original record must ensure the security of the record.

(2) A head may require that a person who is granted access to an original record examine it at premises operated by the institution.

(3) A head shall verify the identity of a person seeking access to his or her own personal information before giving the person access to it. O. Reg. 516/90, s. 3.

4.—(1) Every head shall ensure that reasonable measures to prevent unauthorized access to the records in his or her institution are defined, documented and put in place, taking into account the nature of the records to be protected.

RÈGLEMENT 460

DISPOSITIONS GÉNÉRALES

1 (1) Les organismes, conseils, commissions, personnes morales et autres entités qui figurent dans la colonne 1 de l'annexe sont désignés comme institutions.

(2) La personne qui occupe le poste qui figure dans la colonne 2 de l'annexe vis-à-vis de chaque institution de la colonne 1 est désignée comme personne responsable de l'institution. Règl. de l'Ont. 655/90, art. 1, *en partie*.

2 Le document qui peut être constitué à partir de documents lisibles par machine est soustrait à la définition du terme «document» pour l'application de la Loi si sa préparation entraverait abusivement les activités normales d'une institution. Règl. de l'Ont. 655/90, art. 1, *en partie*.

3 (1) La personne responsable qui accorde l'accès à l'original d'un document doit assurer la sécurité de celui-ci.

(2) La personne responsable peut exiger que la personne à qui est accordé l'accès à l'original d'un document consulte celui-ci dans les locaux dans lesquels l'institution exerce ses activités normales.

(3) La personne responsable vérifie l'identité de l'auteur d'une demande d'accès aux renseignements personnels le concernant avant de lui en accorder l'accès. Règl. de l'Ont. 655/90, art. 1, *en partie*.

4 (1) Les personnes responsables veillent à ce que des mesures raisonnables pour empêcher l'accès non autorisé aux documents qui se trouvent dans leur institution soient déterminées, documentées et appliquées en tenant compte du caractère des documents à protéger.

(2) Every head shall ensure that only those individuals who need a record for the performance of their duties shall have access to it.

(3) Every head shall ensure that reasonable measures to protect the records in his or her institution from inadvertent destruction or damage are defined, documented and put in place, taking into account the nature of the records to be protected. O. Reg. 516/90, s. 4.

5.—(1) Personal information that has been used by an institution shall be retained by the institution for at least one year after use unless the individual to whom the information relates consents to its earlier disposal.

(2) For the purposes of subsection (1), the minimum period of retention of personal information that is contained in a telecommunication logger tape in the custody or under the control of the Ontario Provincial Police is forty-five days rather than one year. O. Reg. 516/90, s. 5.

6. The following are the fees that shall be charged for the purposes of subsection 57 (1) of the Act:

1. For photocopies and computer printouts, 20 cents per page.
2. For floppy disks, \$10 for each disk.
3. For manually searching for a record after two hours have been spent searching, \$7.50 for each fifteen minutes spent by any person.
4. For preparing a record for disclosure, including severing a part of the record, \$7.50 for each fifteen minutes spent by any person.
5. For developing a computer program or other method of producing a record from machine readable record, \$15 for each fifteen minutes spent by any person.
6. For any costs, including computer costs, incurred by the institution in locating, retrieving, processing and copying the record if those costs are specified in an invoice received by the institution. O. Reg. 516/90, s. 6.

7.—(1) If a head gives a person an estimate of an amount payable under the Act and that estimate is \$25 or more, the head may require the person to pay a deposit equal to 50 per cent of the estimate before completing the request.

(2) A head shall refund any amount paid under subsection (1) that is subsequently waived. O. Reg. 516/90, s. 7.

8. The following are prescribed as matters for a head to consider in deciding whether to waive all or part of a payment required to be made under the Act:

1. Whether the person requesting access to the record is given access to it.
2. If the amount of a payment would be \$5 or less, whether the amount of the payment is too small to justify requiring payment. O. Reg. 516/90, s. 8.

9. If a person is required to pay a fee for access to a record, the head may require the person to do so before giving the person access to the record. O. Reg. 516/90, s. 9.

(2) Les personnes responsables veillent à ce que seuls les particuliers qui ont besoin d'un document pour l'exercice de leurs fonctions y aient accès.

(3) Les personnes responsables veillent à ce que des mesures raisonnables pour empêcher les documents qui se trouvent dans leur institution d'être détruits ou endommagés par inadvertance soient déterminées, documentées et appliquées en tenant compte du caractère des documents à protéger. Règl. de l'Ont. 655/90, art. 1, *en partie*.

5 (1) L'institution conserve les renseignements personnels dont elle s'est servie pendant un an au moins après leur utilisation, sauf si le particulier concerné par ces renseignements consent à leur suppression avant la fin du délai imparté.

(2) Pour l'application du paragraphe (1), le délai minimal pendant lequel sont conservés les renseignements personnels contenus dans une base de données informatisée dont la Police provinciale de l'Ontario a la garde ou le contrôle est de quarante-cinq jours au lieu d'un an. Règl. de l'Ont. 655/90, art. 1, *en partie*.

6 Les frais suivants sont imputés pour l'application du paragraphe 57 (1) de la Loi :

1. Pour des photocopies et imprimés d'ordinateur, 20 cents la page.
2. Pour des disquettes, 10 \$ chacune.
3. Pour effectuer une recherche manuelle d'un document après deux heures de recherche, 7,50 \$ pour chaque tranche de quinze minutes qu'une personne consacre à cette fin.
4. Pour préparer un document en vue de sa divulgation, y compris extraire une partie du document, 7,50 \$ pour chaque tranche de quinze minutes qu'une personne consacre à cette fin.
5. Pour créer un programme d'ordinateur ou une autre méthode de préparation d'un document à partir de documents lisibles par machine, 15 \$ pour chaque tranche de quinze minutes qu'une personne consacre à cette fin.
6. Pour tous les frais, y compris les frais d'ordinateur, que l'institution engage pour le repérage, la récupération, le traitement et la duplication du document si ces frais sont précisés dans une facture reçue par l'institution. Règl. de l'Ont. 655/90, art. 1, *en partie*.

7 (1) Si la personne responsable donne à l'auteur de la demande une estimation d'un montant à payer aux termes de la Loi et que l'estimation s'élève à au moins 25 \$, elle peut exiger un acompte égal à 50 pour cent du montant de l'estimation avant de donner suite à la demande.

(2) La personne responsable rembourse tout montant payé aux termes du paragraphe (1) qui est supprimé par la suite. Règl. de l'Ont. 655/90, art. 1, *en partie*.

8 En décidant si elle doit supprimer ou non la totalité ou une partie d'un paiement exigé aux termes de la Loi, la personne responsable tient compte des facteurs suivants :

1. La question de savoir si l'accès au document est accordé à l'auteur de la demande.
2. Si le montant est d'au plus 5 \$, la question de savoir si celui-ci est trop petit pour justifier l'exigence d'un paiement. Règl. de l'Ont. 655/90, art. 1, *en partie*.

9 Si une personne est tenue de payer des frais d'accès à un document, la personne responsable peut exiger qu'elle le fasse avant de lui accorder l'accès. Règl. de l'Ont. 655/90, art. 1, *en partie*.

10.—(1) The following are the terms and conditions relating to security and confidentiality that a person is required to agree to before a head may disclose personal information to that person for a research purpose:

1. The person shall use the information only for a research purpose set out in the agreement or for which the person has written authorization from the institution.
2. The person shall name in the agreement any other persons who will be given access to personal information in a form in which the individual to whom it relates can be identified.
3. Before disclosing personal information to other persons under paragraph 2, the person shall enter into an agreement with those persons to ensure that they will not disclose it to any other person.
4. The person shall keep the information in a physically secure location to which access is given only to the person and to the persons given access under paragraph 2.
5. The person shall destroy all individual identifiers in the information by the date specified in the agreement.
6. The person shall not contact any individual to whom personal information relates, directly or indirectly, without the prior written authority of the institution.
7. The person shall ensure that no personal information will be used or disclosed in a form in which the individual to whom it relates can be identified without the written authority of the institution.
8. The person shall notify the institution in writing immediately if the person becomes aware that any of the conditions set out in this section have been breached. O. Reg. 516/90, s. 10 (1).

(2) An agreement relating to the security and confidentiality of personal information to be disclosed for a research purpose shall be in Form 1. O. Reg. 516/90, s. 10.

11. A request for access to a record under Part II of the Act or for access to or correction of personal information under Part III of the Act shall be in Form 2 or in any other written form that specifies that it is a request made under the Act. O. Reg. 516/90, s. 11.

10 (1) Les conditions relatives à la sécurité et au caractère confidentiel que la personne est tenue d'accepter avant que la personne responsable puisse lui divulguer des renseignements personnels à des fins de recherche sont les suivantes :

1. La personne n'utilise les renseignements qu'à des fins de recherche précisées dans l'accord ou pour lesquelles elle a reçu l'autorisation écrite de l'institution.
2. La personne nomme dans l'accord les autres personnes à qui sera accordé l'accès aux renseignements personnels sous une forme dans laquelle le particulier concerné par ces renseignements peut être identifié.
3. Avant de divulguer les renseignements personnels aux autres personnes visées à la disposition 2, la personne conclut un accord avec celles-ci pour veiller à ce qu'elles ne les divulguent pas à d'autres personnes.
4. La personne conserve les renseignements dans un endroit sûr dont l'accès n'est accordé qu'à la personne et aux personnes à qui l'accès est accordé aux termes de la disposition 2.
5. La personne détruit tous les identificateurs individuels contenus dans les renseignements au plus tard à la date précisée dans l'accord.
6. La personne ne communique avec aucun particulier concerné par ces renseignements personnels, directement ou indirectement, sans obtenir au préalable l'autorisation écrite de l'institution.
7. La personne veille à ce qu'aucun renseignement personnel ne soit utilisé ou divulgué sous une forme dans laquelle le particulier concerné par ce renseignement peut être identifié, à moins d'obtenir l'autorisation écrite de l'institution.
8. La personne avise l'institution par écrit immédiatement si elle apprend que les conditions énoncées au présent article n'ont pas été observées.

(2) L'accord relatif à la sécurité et au caractère confidentiel des renseignements personnels à être divulgués à des fins de recherche est rédigé selon la formule 1. Règl. de l'Ont. 655/90, art. 1, *en partie*.

11 La demande d'accès à un document visé à la partie II de la Loi ou la demande d'accès à des renseignements personnels visés à la partie III de la Loi ou de rectification de ceux-ci est rédigée selon la formule 2 ou selon une autre formule écrite qui précise que la demande est présentée en vertu de la Loi. Règl. de l'Ont. 655/90, art. 1, *en partie*.

Schedule

ITEM	COLUMN 1	COLUMN 2
	INSTITUTION	HEAD
1.	Academic Advisory Committee	Minister of Colleges and Universities
2.	Advisory Committee of Public Trustee on Investments	Attorney General
3.	Advisory Committee on Crime Prevention	Solicitor General
4.	Advisory Committee on Diploma Education for Alfred College of Agriculture Technology	Minister of Agriculture and Food
5.	Advisory Committee on Diploma Education for Centralia College of Agriculture Technology	Minister of Agriculture and Food
6.	Advisory Committee on Diploma Education for Kemptville College of Agriculture Technology	Minister of Agriculture and Food
7.	Advisory Committee on Diploma Education for New Liskeard College of Agriculture Technology	Minister of Agriculture and Food
8.	Advisory Committee on Diploma Education for Ridgetown College of Agriculture Technology	Minister of Agriculture and Food
9.	Advisory Committee on Environmental Standards	Minister of the Environment
10.	Advisory Committee on Genetic Services	Minister of Health
11.	Advisory Committee on Inborn Errors of Metabolism	Minister of Health
12.	Advisory Committee on Reproductive Care	Minister of Health
13.	Advisory Committee on Sport Fitness and Recreation Safety	Minister of Tourism and Recreation
14.	Advisory Committee on Occupational Health and Occupational Safety	Minister of Labour
15.	Advisory Council on Special Education	Minister of Education
16.	Agricultural Council of Ontario	Minister of Agriculture and Food
17.	Agricultural Health and Safety Implementation Committee	Minister of Agriculture and Food
18.	Agricultural Industry Advisory Committee	Minister of Labour
19.	Agricultural Licencing and Registration Review Board	Minister of Agriculture and Food
20.	Agricultural Rehabilitation and Development Directorate	Minister of Agriculture and Food
21.	Agricultural Research Institute of Ontario	Minister of Agriculture and Food
22.	Algonquin Forestry Authority	General Manager of the Authority
23.	Animal Care Review Board	Solicitor General
24.	Apprenticeship and Tradesmen's Provincial Advisory Committees, each Committee	Minister of Skills Development
25.	Assessment Review Board	Attorney General
26.	Assistive Devices Advisory Committee	Minister of Health
27.	Beginning Farmer Assistance Program Review Committee	Minister of Agriculture and Food
28.	Board of Governors of each College of Applied Arts and Technology	Chair of the Board
29.	Board of Negotiation (Attorney General)	Attorney General
30.	Board of Negotiation (Environment)	Minister of the Environment
31.	Board of Review under the <i>Operating Engineers Act</i>	Minister of Consumer and Commercial Relations

Annexe

NUMÉRO	COLONNE 1	COLONNE 2
	INSTITUTION	PERSONNE RESPONSABLE
1	Comité consultatif sur les programmes d'enseignement	Ministre des Collèges et Universités
2	Comité consultatif du Curateur public sur les placements	Procureur général
3	Comité consultatif sur la prévention du crime	Solliciteur général
4	Comité consultatif sur les programmes d'études menant au diplôme du Collège de technologie agricole et alimentaire d'Alfred	Ministre de l'Agriculture et de l'Alimentation
5	Comité consultatif sur les programmes d'études menant au diplôme du Collège de technologie agricole Centralia	Ministre de l'Agriculture et de l'Alimentation
6	Comité consultatif sur les programmes d'études menant au diplôme du Collège de technologie agricole de Kemptville	Ministre de l'Agriculture et de l'Alimentation
7	Comité consultatif sur les programmes d'études menant au diplôme du Collège de technologie agricole de New Liskeard	Ministre de l'Agriculture et de l'Alimentation
8	Comité consultatif sur les programmes d'études menant au diplôme du Collège de technologie agricole de Ridgeway	Ministre de l'Agriculture et de l'Alimentation
9	Comité consultatif des normes environnementales	Ministre de l'Environnement
10	Comité consultatif des services de génétique	Ministre de la Santé
11	Comité consultatif sur les enzymopathies des enfants	Ministre de la Santé
12	Comité consultatif sur les soins périnataux	Ministre de la Santé
13	Comité consultatif sur la sécurité dans le domaine des sports, du conditionnement physique et des loisirs	Ministre du Tourisme et des Loisirs
14	Conseil consultatif sur la santé et la sécurité au travail	Ministre du Travail
15	Conseil consultatif sur l'éducation de l'enfance en difficulté	Ministre de l'Éducation
16	Conseil agricole de l'Ontario	Ministre de l'Agriculture et de l'Alimentation
17	Comité de mise en oeuvre des politiques de santé et de sécurité en agriculture	Ministre de l'Agriculture et de l'Alimentation
18	Comité consultatif sur l'industrie agricole	Ministre du Travail
19	Commission de révision des enregistrements et des permis agricoles	Ministre de l'Agriculture et de l'Alimentation
20	Direction générale de la revalorisation et de l'aménagement des régions agricoles	Ministre de l'Agriculture et de l'Alimentation
21	Institut de recherche agricole de l'Ontario	Ministre de l'Agriculture et de l'Alimentation
22	Agence de foresterie du parc Algonquin	Directeur général de l'Agence
23	Commission d'étude des soins aux animaux	Solliciteur général
24	Chacun des comités consultatifs provinciaux sur l'apprentissage et les gens de métier	Ministre de la Formation professionnelle
25	Commission de révision de l'évaluation foncière	Procureur général
26	Comité consultatif sur les appareils et accessoires fonctionnels	Ministre de la Santé
27	Comité d'examen du Programme d'aide aux agriculteurs débutants	Ministre de l'Agriculture et de l'Alimentation
28	Conseil d'administration de chaque collège d'arts appliqués et de technologie	Président du conseil d'administration
29	Commission de négociation (ministère du Procureur général)	Procureur général
30	Commission de négociation (ministère de l'Environnement)	Ministre de l'Environnement
31	Commission de révision constituée en vertu de la <i>Loi sur les mécaniciens d'exploitation</i>	Ministre de la Consommation et du Commerce

ITEM	COLUMN 1	COLUMN 2
	INSTITUTION	HEAD
32.	Board of Valuation	Minister of Energy
33.	Building Code Commission	Minister of Housing
34.	Building Industry Strategy Board	Minister of Housing
35.	Building Materials Evaluation Commission	Minister of Housing
36.	Canada's Capital Congress Centre	General Manager of the Centre
37.	Centres of Entrepreneurship Advisory Committee	Minister of Colleges and Universities
38.	Child and Family Services Review Board	Minister of Community and Social Services
39.	Chiropody Review Committee	Minister of Health
40.	Chiropractic Review Committee	Minister of Health
41.	Civil Service Commission	Chair of Management Board of Cabinet
42.	Classification Rating Committee	Minister of Labour
43.	College Relations Commission	Minister of Colleges and Universities
44.	Commercial Registration Appeal Tribunal	Minister of Consumer and Commercial Relations
45.	Commodity Futures Advisory Board	Minister of Financial Institutions
46.	Conservation Review Board	Minister of Culture and Communications
47.	Co-operative Loans Board of Ontario	Minister of Agriculture and Food
48.	Coroners' Council	Solicitor General
49.	Council for Franco-Ontarian Education	Minister of Education
50.	Criminal Injuries Compensation Board	Attorney General
51.	Crop Insurance Commission of Ontario	Minister of Agriculture and Food
52.	Crown Employees Grievance Settlement Board	Minister of Labour
53.	Crown Timber Board of Examiners	Minister of Natural Resources
54.	Custody Review Board	Minister of Community and Social Services
55.	Dental Personnel Selection Committee	Minister of Health
56.	Dentistry Review Committee	Minister of Health
57.	Denture Therapists Appeal Board	Minister of Health
58.	District Health Councils, each Council	Chair of the Council
59.	Drug Quality and Therapeutics Committee	Minister of Health
60.	Eastern Ontario Development Corporation	Minister of Industry, Trade and Technology
61.	Education Relations Commission	Minister of Education
62.	Environmental Appeal Board	Minister of the Environment
63.	Environmental Assessment Advisory Committee	Minister of the Environment
64.	Environmental Assessment Board	Minister of the Environment
65.	Environmental Compensation Corporation	Minister of the Environment
66.	Farm Income Stabilization Commission of Ontario	Minister of Agriculture and Food
67.	Farm Pollution Advisory Committee	Minister of the Environment
68.	Farm Products Appeal Tribunal	Minister of Agriculture and Food
69.	Farm Products Marketing Board	Minister of Agriculture and Food
70.	Farm Products Payment Board	Minister of Agriculture and Food

NUMÉRO	COLONNE 1	COLONNE 2
	INSTITUTION	PERSONNE RESPONSABLE
32	Commission d'évaluation	Ministre de l'Énergie
33	Commission du code du bâtiment	Ministre du Logement
34	Commission de stratégie pour l'industrie du bâtiment	Ministre du Logement
35	Commission d'évaluation des matériaux de construction	Ministre du Logement
36	Centre des Congrès de la Capitale du Canada	Directeur général du Centre
37	Comité consultatif sur les centres d'entrepreneuriat	Ministre des Collèges et Universités
38	Commission de révision des services à l'enfance et à la famille	Ministre des Services sociaux et communautaires
39	Comité d'étude de la podologie	Ministre de la Santé
40	Comité d'étude de la chiropractie	Ministre de la Santé
41	Commission de la fonction publique	Président du Conseil de gestion du gouvernement
42	Comité d'évaluation des classifications	Ministre du Travail
43	Commission des relations de travail dans les collèges	Ministre des Collèges et Universités
44	Commission d'appel des enregistrements commerciaux	Ministre de la Consommation et du Commerce
45	Conseil consultatif sur la vente à terme de marchandises	Ministre des Institutions financières
46	Commission des biens culturels	Ministre de la Culture et des Communications
47	Commission des prêts aux coopératives de l'Ontario	Ministre de l'Agriculture et de l'Alimentation
48	Conseil des coroners	Solliciteur général
49	Conseil de l'éducation franco-ontarienne	Ministre de l'Éducation
50	Commission d'indemnisation des victimes d'actes criminels	Procureur général
51	Commission ontarienne de l'assurance-récolte	Ministre de l'Agriculture et de l'Alimentation
52	Commission de règlement des griefs des employés de la Couronne	Ministre du Travail
53	Commission d'examen du bois de la Couronne	Ministre des Richesses naturelles
54	Commission de révision des placements sous garde	Ministre des Services sociaux et communautaires
55	Comité de sélection du personnel dentaire	Ministre de la Santé
56	Comité d'étude de la dentisterie	Ministre de la Santé
57	Commission d'appel des denturologues	Ministre de la Santé
58	Conseils régionaux de santé	Président de chaque conseil
59	Comité d'appréciation des médicaments et des thérapeutiques	Ministre de la Santé
60	Société de développement économique de l'Est de l'Ontario	Ministre de l'Industrie, du Commerce et de la Technologie
61	Commission des relations de travail en éducation	Ministre de l'Éducation
62	Commission d'appel de l'environnement	Ministre de l'Environnement
63	Comité consultatif des évaluations environnementales	Ministre de l'Environnement
64	Commission des évaluations environnementales	Ministre de l'Environnement
65	Société d'indemnisation environnementale	Ministre de l'Environnement
66	Commission de stabilisation des revenus agricoles de l'Ontario	Ministre de l'Agriculture et de l'Alimentation
67	Comité consultatif sur la pollution agricole	Ministre de l'Environnement
68	Commission d'appel pour les produits agricoles	Ministre de l'Agriculture et de l'Alimentation
69	Commission de commercialisation des produits agricoles	Ministre de l'Agriculture et de l'Alimentation
70	Commission de recouvrement du prix des produits agricoles	Ministre de l'Agriculture et de l'Alimentation

ITEM	COLUMN 1	COLUMN 2
	INSTITUTION	HEAD
71.	Farm Tax Rebate Appeal Board	Minister of Agriculture and Food
72.	Finance Committee for the Investment of Court Funds	Attorney General
73.	Financial Disclosure Advisory Board	Minister of Financial Institutions
74.	Fire Code Commission	Solicitor General
75.	Fisheries Advisory Council	Minister of Natural Resources
76.	Funeral Services Review Board	Minister of Health
77.	Game and Fish Hearing Board	Minister of Natural Resources
78.	Geoscience Research Review Committee	Minister of Mines
79.	Grain Financial Protection Board	Minister of Agriculture and Food
80.	Hazardous Waste Listing Advisory Committee	Minister of the Environment
81.	Healing Arts Radiation Protection Commission	Minister of Health
82.	Health Care Systems Research Review Committee	Minister of Health
83.	Health Disciplines Board	Minister of Health
84.	Health Facilities Appeal Board	Minister of Health
85.	Health Protection Appeal Board	Minister of Health
86.	Health Research Personnel Committee	Minister of Health
87.	Health Services Appeal Board	Minister of Health
88.	Health System-Linked Research Units Grants Review Committee	Minister of Health
89.	Hospital Appeal Board	Minister of Health
90.	Huronian Historical Advisory Council	Minister of Tourism and Recreation
91.	Industrial Disease Standards Panel	Minister of Labour
92.	Innovation Ontario Corporation	Minister of Industry, Trade and Technology
93.	Interim Regulatory Council on Midwifery	Minister of Health
94.	Joint Committee on Physicians' Compensation	Minister of Health
95.	Laboratory Review Board	Minister of Health
96.	Labour-Management Advisory Committee	Minister of Labour
97.	Lake of the Woods Control Board	Minister of Natural Resources
98.	Languages of Instruction Commission of Ontario	Minister of Education
99.	Licence Suspension Appeal Board	Minister of Transportation
100.	Lieutenant Governor's Board of Review	Minister of Health
101.	Liquor Control Board of Ontario	Chair of the Board
102.	Liquor Licence Board of Ontario	Minister of Consumer and Commercial Relations
103.	Livestock Financial Protection Board	Minister of Agriculture and Food
104.	Livestock Medicines Advisory Board	Minister of Agriculture and Food
105.	Local Housing Authorities, each Authority	Minister of Housing
106.	Medical Advisory Board	Minister of Community and Social Services
107.	Medical Eligibility Committee — Health Insurance	Minister of Health

NUMÉRO	COLONNE 1	COLONNE 2
	INSTITUTION	PERSONNE RESPONSABLE
71	Commission d'appel des remises fiscales aux exploitations agricoles	Ministre de l'Agriculture et de l'Alimentation
72	Comité des finances pour les placements des fonds judiciaires	Procureur général
73	Conseil consultatif sur la divulgation des renseignements de nature financière	Ministre des Institutions financières
74	Commission du code des incendies	Solliciteur général
75	Conseil consultatif sur les pêches	Ministre des Richesses naturelles
76	Funeral Services Review Board	Ministre de la Santé
77	Commission des recours en matière de chasse et de pêche	Ministre des Richesses naturelles
78	Comité d'étude de la recherche géoscientifique	Ministre des Mines
79	Commission de protection financière des producteurs de céréales	Ministre de l'Agriculture et de l'Alimentation
80	Comité consultatif d'immatriculation des déchets dangereux	Ministre de l'Environnement
81	Commission de protection contre les rayons	Ministre de la Santé
82	Comité d'examen des recherches sur les systèmes de soins	Ministre de la Santé
83	Conseil des sciences de la santé	Ministre de la Santé
84	Commission d'appel des établissements de santé	Ministre de la Santé
85	Commission d'appel pour la protection de la santé	Ministre de la Santé
86	Comité de chercheurs dans le domaine de la santé	Ministre de la Santé
87	Commission d'appel des services de santé	Ministre de la Santé
88	Comité d'examen des demandes de subvention des unités de recherche reliées au système de santé	Ministre de la Santé
89	Commission d'appel des hôpitaux	Ministre de la Santé
90	Conseil consultatif historique de la Huronie	Ministre du Tourisme et des Loisirs
91	Comité des normes en matière de maladies professionnelles	Ministre du Travail
92	Société Innovation Ontario	Ministre de l'Industrie, du Commerce et de la Technologie
93	Conseil intérimaire sur la réglementation future de la profession de sage-femme	Ministre de la Santé
94	Comité mixte sur la rémunération des médecins pour leurs services professionnels	Ministre de la Santé
95	Commission d'étude des laboratoires	Ministre de la Santé
96	Comité consultatif sur les relations employés-employeurs	Ministre du Travail
97	Commission de contrôle du lac des Bois	Ministre des Richesses naturelles
98	Commission des langues d'enseignement de l'Ontario	Ministre de l'Éducation
99	Commission d'appel des suspensions de permis	Ministre des Transports
100	Conseil de révision du lieutenant-gouverneur	Ministre de la Santé
101	Régie des alcools de l'Ontario	Président de la Régie
102	Commission des permis de vente d'alcool de l'Ontario	Ministre de la Consommation et du Commerce
103	Commission de protection financière des éleveurs de bétail	Ministre de l'Agriculture et de l'Alimentation
104	Comité consultatif sur les médicaments pour le bétail	Ministre de l'Agriculture et de l'Alimentation
105	Chacune des commissions locales de logement	Ministre du Logement
106	Conseil médical consultatif	Ministre des Services sociaux et communautaires
107	Comité d'admissibilité médicale — assurance-santé	Ministre de la Santé

ITEM	COLUMN 1	COLUMN 2
	INSTITUTION	HEAD
108.	Medical Personnel Selection Committee	Minister of Health
109.	Medical Review Committee — Health Insurance	Minister of Health
110.	Metropolitan Toronto Convention Centre Corporation	President and Chief Executive Officer of the Corporation
111.	Milk Commission of Ontario	Minister of Agriculture and Food
112.	Minister's Advisory Committee on Corrections	Minister of Correctional Services
113.	Municipal/Industrial Strategy for Abatement Advisory Committee	Minister of the Environment
114.	Niagara Escarpment Commission	Minister of Municipal Affairs
115.	Niagara Parks Commission	Chair of the Commission
116.	North Pickering Development Corporation	Chair of the Board
117.	Northern Development Councils, each Council	Minister of Northern Development
118.	Northern Development Councils' Chairmen's Advisory Committee	Minister of Northern Development
119.	Northern Ontario Development Corporation	Minister of Industry, Trade and Technology
120.	Northern Ontario Heritage Fund Corporation	Minister of Northern Development
121.	Nursing Homes Review Board	Minister of Health
122.	Old Fort William Advisory Committee	Minister of Tourism and Recreation
123.	Ontario Advisory Council for Disabled Persons	Minister Responsible for Disabled Persons
124.	Ontario Advisory Council on Multiculturalism and Citizenship	Minister of Citizenship
125.	Ontario Advisory Council on Senior Citizens	Minister Responsible for Senior Citizen's Affairs
126.	Ontario Advisory Council on Women's Issues	Minister Responsible for Women's Issues
127.	Ontario Agricultural Museum Advisory Board	Minister of Agriculture and Food
128.	Ontario Agricultural Museum Artifacts Valuation Committee	Minister of Agriculture and Food
129.	Ontario Board of Parole	Minister of Correctional Services
130.	Ontario Centre for Advanced Manufacturing Technology	President of the Centre
131.	Ontario Centre for Automotive Parts Technology	President of the Centre
132.	Ontario Centre for Farm Machinery and Food Processing Technology	President of the Centre
133.	Ontario Centre for Microelectronics Technology	President of the Centre
134.	Ontario Centre for Resource Machinery Technology	President of the Centre
135.	Ontario Council of Regents for Colleges of Applied Arts and Technology	Minister of Colleges and Universities
136.	Ontario Council on Teacher Education	Minister of Education
137.	Ontario Council on University Affairs	Minister of Colleges and Universities
138.	Ontario Crop Insurance Arbitration Board	Minister of Agriculture and Food
139.	Ontario Development Corporation	Minister of Industry, Trade and Technology
140.	Ontario Drainage Tribunal	Minister of Agriculture and Food
141.	Ontario Energy Board	Minister of Energy
142.	Ontario Family Farm Interest Rate Reduction Appeal Board	Minister of Agriculture and Food
143.	Ontario Farm Family Advisor Program Board	Minister of Agriculture and Food
144.	Ontario Farm Implements Board	Minister of Agriculture and Food

NUMÉRO	COLONNE 1	COLONNE 2
	INSTITUTION	PERSONNE RESPONSABLE
108	Comité de sélection du personnel médical	Ministre de la Santé
109	Comité d'étude de la médecine — assurance-santé	Ministre de la Santé
110	Metro Toronto Convention Centre Corporation	Président-directeur général de la société
111	Commission du lait de l'Ontario	Ministre de l'Agriculture et de l'Alimentation
112	Comité consultatif du ministre sur les services correctionnels	Ministre des Services correctionnels
113	Comité consultatif de la Stratégie municipale et industrielle de dépollution	Ministre de l'Environnement
114	Commission de l'escarpement du Niagara	Ministre des Affaires municipales
115	Commission des parcs du Niagara	Président de la Commission
116	Société d'aménagement de North Pickering	Président du conseil d'administration
117	Chacun des conseils de développement du Nord	Ministre du Développement du Nord
118	Comité consultatif des présidents de conseils de développement du Nord	Ministre du Développement du Nord
119	Société de développement du Nord de l'Ontario	Ministre de l'Industrie, du Commerce et de la Technologie
120	Société de gestion du Fonds du patrimoine du Nord de l'Ontario	Ministre du Développement du Nord
121	Commission de révision des maisons de soins infirmiers	Ministre de la Santé
122	Comité consultatif du Vieux Fort William	Ministre du Tourisme et des Loisirs
123	Conseil consultatif de l'Ontario sur les personnes handicapées	Ministre délégué aux Affaires des personnes handicapées
124	Conseil consultatif des relations civiques et multiculturelles de l'Ontario	Ministre des Affaires civiques
125	Conseil consultatif de l'Ontario sur l'âge d'or	Ministre délégué aux Affaires des personnes âgées
126	Conseil consultatif de l'Ontario sur la condition féminine	Ministre délégué à la Condition féminine
127	Conseil consultatif du Musée agricole de l'Ontario	Ministre de l'Agriculture et de l'Alimentation
128	Comité d'évaluation des artefacts du Musée agricole de l'Ontario	Ministre de l'Agriculture et de l'Alimentation
129	Commission ontarienne des libérations conditionnelles	Ministre des Services correctionnels
130	Centre de technologie de fabrication avancée de l'Ontario	Président du Centre
131	Centre de technologie des pièces automobiles de l'Ontario	Président du Centre
132	Centre de technologie agricole et alimentaire de l'Ontario	Président du Centre
133	Centre de microélectronique de l'Ontario	Président du Centre
134	Centre ontarien de technologie minière et forestière	Président du Centre
135	Conseil ontarien des affaires collégiales	Ministre des Collèges et Universités
136	Conseil ontarien sur la formation du personnel enseignant	Ministre de l'Éducation
137	Conseil ontarien des affaires universitaires	Ministre des Collèges et Universités
138	Commission d'arbitrage de l'assurance-récolte de l'Ontario	Ministre de l'Agriculture et de l'Alimentation
139	Société de développement de l'Ontario	Ministre de l'Industrie, du Commerce et de la Technologie
140	Commission de drainage de l'Ontario	Ministre de l'Agriculture et de l'Alimentation
141	Commission de l'énergie de l'Ontario	Ministre de l'Énergie
142	Commission d'appel des réductions des taux d'intérêt pour les exploitations agricoles familiales de l'Ontario	Ministre de l'Agriculture et de l'Alimentation
143	Conseil du Programme de conseillers des familles d'agriculteurs	Ministre de l'Agriculture et de l'Alimentation
144	Commission des appareils agricoles de l'Ontario	Ministre de l'Agriculture et de l'Alimentation

ITEM	COLUMN 1	COLUMN 2
	INSTITUTION	HEAD
145.	Ontario Farm Machinery Board	Minister of Agriculture and Food
146.	Ontario Film Development Corporation	Minister of Culture and Communications
147.	Ontario Film Review Board	Minister of Consumer and Commercial Relations
148.	Ontario Fisheries Advisory Council	Minister of Natural Resources
149.	Ontario Food Terminal Board	Chair of the Board
150.	Ontario Forestry Council	Minister of Natural Resources
151.	Ontario French Language Services Commission	Minister Responsible for Francophone Affairs
152.	Ontario Geographic Names Board	Minister of Natural Resources
153.	Ontario Grain Corn Council	Minister of Agriculture and Food
154.	Ontario Heritage Foundation	Minister of Culture and Communications
155.	Ontario Highway Transport Board	Minister of Transportation
156.	Ontario Historical Studies Series Board of Trustees	Minister of Culture and Communications
157.	Ontario Housing Corporation	Minister of Housing
158.	Ontario Human Rights Commission	Minister of Citizenship
159.	Ontario Hydro	Chair of Ontario Hydro
160.	Ontario Insurance Commission	Minister of Financial Institutions
161.	Ontario International Corporation	Minister of Industry, Trade and Technology
162.	Ontario Institute for Studies in Education	Chair of the Board
163.	Ontario Junior Farmer Establishment Loan Corporation	Minister of Agriculture and Food
164.	Ontario Labour Relations Board	Minister of Labour
165.	Ontario Law Reform Commission	Attorney General
166.	Ontario Lottery Corporation	President of the Corporation
167.	Ontario Mortgage Corporation	Minister of Government Services
168.	Ontario Municipal Board	Attorney General
169.	Ontario Municipal Employees Retirement Board	Chair of the Board
170.	Ontario Municipal Improvement Corporation	Minister of Treasury and Economics
171.	Ontario Northland Transportation Commission	Chair of the Commission
172.	Ontario Place Corporation	Minister of Tourism and Recreation
173.	Ontario Police Arbitration Commission	Solicitor General
174.	Ontario Police Commission	Solicitor General
175.	Ontario Pork Industry Improvement Program Advisory Committee	Minister of Agriculture and Food
176.	Ontario Provincial Police Grievance Board	Chair of Management Board of Cabinet
177.	Ontario Provincial Police Negotiating Committee	Chair of Management Board of Cabinet
178.	Ontario Public Service Labour Relations Tribunal	Minister of Labour
179.	Ontario Racing Commission	Minister of Consumer and Commercial Relations
180.	Ontario/Regional Special Education Tribunals, each Tribunal	Minister of Education
181.	Ontario Renewable Resources Research Review Board	Minister of Natural Resources
182.	Ontario Science Centre	Minister of Culture and Communications

NUMÉRO	COLONNE 1	COLONNE 2
	INSTITUTION	PERSONNE RESPONSABLE
145	Commission des machines agricoles de l'Ontario	Ministre de l'Agriculture et de l'Alimentation
146	Société de développement de l'industrie cinématographique de l'Ontario	Ministre de la Culture et des Communications
147	Commission de contrôle cinématographique de l'Ontario	Ministre de la Consommation et du Commerce
148	Conseil consultatif de l'Ontario sur les pêches	Ministre des Richesses naturelles
149	Commission du Marché des produits alimentaires de l'Ontario	Président de la Commission
150	Conseil forestier de l'Ontario	Ministre des Richesses naturelles
151	Commission des services en français de l'Ontario	Ministre délégué aux Affaires francophones
152	Commission de toponymie de l'Ontario	Ministre des Richesses naturelles
153	Conseil ontarien du maïs-grain	Ministre de l'Agriculture et de l'Alimentation
154	Fondation du patrimoine ontarien	Ministre de la Culture et des Communications
155	Commission des transports routiers de l'Ontario	Ministre des Transports
156	Conseil d'administration du Ontario Historical Studies Series	Ministre de la Culture et des Communications
157	Société de logement de l'Ontario	Ministre du Logement
158	Commission ontarienne des droits de la personne	Ministre des Affaires civiles
159	Ontario Hydro	Président d'Ontario Hydro
160	Commission des assurances de l'Ontario	Ministre des Institutions financières
161	Société internationale de l'Ontario	Ministre de l'Industrie, du Commerce et de la Technologie
162	Institut d'études pédagogiques de l'Ontario	Président du conseil d'administration
163	Société de prêts aux jeunes agriculteurs de l'Ontario	Ministre de l'Agriculture et de l'Alimentation
164	Commission des relations de travail de l'Ontario	Ministre du Travail
165	Commission de réforme du droit de l'Ontario	Procureur général
166	Société des loteries de l'Ontario	Président de la Société
167	Société d'hypothèques de l'Ontario	Ministre des Services gouvernementaux
168	Commission des affaires municipales de l'Ontario	Procureur général
169	Commission du régime de retraite des employés municipaux de l'Ontario	Président de la Commission
170	Société ontarienne d'aménagement municipal	Trésorier et ministre de l'Économie
171	Commission de transport Ontario Northland	Président de la Commission
172	Société d'exploitation de la Place Ontario	Ministre du Tourisme et des Loisirs
173	Commission d'arbitrage de la police de l'Ontario	Solliciteur général
174	Commission de police de l'Ontario	Solliciteur général
175	Comité consultatif du Programme d'amélioration de l'industrie du porc de l'Ontario	Ministre de l'Agriculture et de l'Alimentation
176	Commission des griefs de la Police provinciale de l'Ontario	Président du Conseil de gestion du gouvernement
177	Comité de négociation de la Police provinciale de l'Ontario	Président du Conseil de gestion du gouvernement
178	Tribunal des relations de travail de la fonction publique de l'Ontario	Ministre du Travail
179	Commission des courses de l'Ontario	Ministre de la Consommation et du Commerce
180	Chacun des tribunaux de l'enfance en difficulté de l'Ontario	Ministre de l'Éducation
181	Conseil ontarien des recherches sur les ressources renouvelables	Ministre des Richesses naturelles
182	Centre des sciences de l'Ontario	Ministre de la Culture et des Communications

ITEM	COLUMN 1	COLUMN 2
	INSTITUTION	HEAD
183.	Ontario Securities Commission	Minister of Financial Institutions
184.	Ontario Sport Medicine and Safety Advisory Board	Minister of Tourism and Recreation
185.	Ontario Stock Yards Board	Chair of the Board
186.	Ontario Student Assistance Program Appeal Board	Minister of Colleges and Universities
187.	Ontario Telephone Development Corporation	Minister of Culture and Communications
188.	Ontario Telephone Service Commission	Minister of Culture and Communications
189.	Ontario Training Corporation	Chair of the Board
190.	Ontario Transportation Development Corporation	Minister of Transportation
191.	Ontario Waste Management Corporation	Chair and President of the Corporation
192.	Optometry Review Committee	Minister of Health
193.	Osteopathy Review Committee	Minister of Health
194.	Ottawa River Regulation Planning Board	Minister of Natural Resources
195.	Pay Equity Commission	Minister of Labour
196.	Pay Equity Hearings Tribunal	Minister of Labour
197.	Pension Commission of Ontario	Minister of Financial Institutions
198.	Pesticides Advisory Committee	Minister of the Environment
199.	Planning and Implementation Commission	Minister of Education
200.	Potato Financial Protection Board	Minister of Agriculture and Food
201.	Premier's Advisory Committee on Executive Resources	Premier
202.	Private Vocational School Review Board	Minister of Colleges and Universities
203.	Processing Vegetable Financial Protection Board	Minister of Agriculture and Food
204.	Produce Arbitration Board	Minister of Agriculture and Food
205.	Professional Services Management Committee	Minister of Health
206.	Province of Ontario Medal for Fire Fighters' Bravery Advisory Council	Minister of Intergovernmental Affairs
207.	Province of Ontario Medal for Good Citizenship Advisory Council	Minister of Intergovernmental Affairs
208.	Province of Ontario Medal for Police Bravery Advisory Council	Minister of Intergovernmental Affairs
209.	Province of Ontario Medal for the Order of Ontario Advisory Council	Minister of Intergovernmental Affairs
210.	Provincial Decision Committee (for the Operating Loan Guarantee Program)	Minister of Agriculture and Food
211.	Provincial Judges Benefits Board	Minister of Government Services
212.	Provincial Parks Council	Minister of Natural Resources
213.	Provincial Schools Authority	Minister of Education
214.	Public Complaints Commissioner	Attorney General

NUMÉRO	COLONNE 1	COLONNE 2
	INSTITUTION	PERSONNE RESPONSABLE
183	Commission des valeurs mobilières de l'Ontario	Ministre des Institutions financières
184	Conseil consultatif de l'Ontario sur la sécurité et la médecine dans les sports	Ministre du Tourisme et des Loisirs
185	Commission ontarienne des parcs à bestiaux	Président de la Commission
186	Commission d'appel du Régime d'aide financière aux étudiants de l'Ontario	Ministre des Collèges et Universités
187	Société de développement des réseaux téléphoniques de l'Ontario	Ministre de la Culture et des Communications
188	Commission ontarienne des services téléphoniques	Ministre de la Culture et des Communications
189	Société ontarienne de formation	Président du conseil d'administration
190	Société de développement des transports de l'Ontario	Ministre des Transports
191	Société ontarienne de gestion des déchets	Président du conseil d'administration et président de la Société
192	Comité d'étude de l'optométrie	Ministre de la Santé
193	Comité d'étude de l'ostéopathie	Ministre de la Santé
194	Commission de planification de la région de la rivière des Outaouais	Ministre des Richesses naturelles
195	Commission de l'équité salariale	Ministre du Travail
196	Tribunal de l'équité salariale	Ministre du Travail
197	Commission des régimes de retraite de l'Ontario	Ministre des Institutions financières
198	Comité consultatif sur les pesticides	Ministre de l'Environnement
199	Commission de planification et de mise en oeuvre	Ministre de l'Éducation
200	Commission de protection financière des cultivateurs de pommes de terre	Ministre de l'Agriculture et de l'Alimentation
201	Comité consultatif du premier ministre sur le personnel cadre	Premier ministre
202	Commission d'étude des écoles privées de formation professionnelle	Ministre des Collèges et Universités
203	Commission de protection financière des cultivateurs de légumes destinés au conditionnement	Ministre de l'Agriculture et de l'Alimentation
204	Commission d'arbitrage des produits agricoles	Ministre de l'Agriculture et de l'Alimentation
205	Comité de gestion des services professionnels	Ministre de la Santé
206	Conseil consultatif de la médaille de bravoure des pompiers de la province de l'Ontario	Ministre des Affaires intergouvernementales
207	Conseil consultatif de la médaille du mérite civique de la province de l'Ontario	Ministre des Affaires intergouvernementales
208	Conseil consultatif de la médaille de bravoure des policiers de la province de l'Ontario	Ministre des Affaires intergouvernementales
209	Conseil consultatif de l'Ordre de l'Ontario	Ministre des Affaires intergouvernementales
210	Comité décisionnel provincial (pour le Programme de garantie de prêts d'exploitation)	Ministre de l'Agriculture et de l'Alimentation
211	Commission de retraite des juges provinciaux	Ministre des Services gouvernementaux
212	Conseil des parcs provinciaux	Ministre des Richesses naturelles
213	Administration des écoles provinciales	Ministre de l'Éducation
214	Commissaire aux plaintes du public	Procureur général
215	Commission consultative sur les régimes de retraite des employés de la fonction publique	Président du Conseil de gestion du gouvernement

ITEM	COLUMN 1	COLUMN 2
	INSTITUTION	HEAD
215.	Public Sector Pensions Advisory Board	Chair of Management Board of Cabinet
216.	Public Service Grievance Board	Minister of Labour
217.	Public Trustee	Attorney General
218.	Rabies Advisory Committee	Minister of Natural Resources
219.	Real Estate Advisory Board	Minister of Government Services
220.	Recycling Advisory Committee	Minister of the Environment
221.	Rent Review Hearings Board	Minister of Housing
222.	Residential Rental Standards Board	Minister of Housing
223.	Residential Tenancy Commission	Minister of Housing
224.	Review Board under the <i>Mental Health Act</i>	Minister of Health
225.	Royal Ontario Museum	Chair of the Board
226.	St. Lawrence Parks Commission	Minister of Tourism and Recreation
227.	Selection Board	Minister of Colleges and Universities
228.	Shoreline Management Advisory Council	Minister of Natural Resources
229.	Social Assistance Review Board	Minister of Community and Social Services
230.	Soldiers Aid Commission	Minister of Community and Social Services
231.	Stadium Corporation of Ontario Limited	Chair of the Corporation
232.	Statutory Powers Procedure Rules Committee	Attorney General
233.	Sturgeon River/Lake Nipissing/French River Watershed Management Advisory Board	Minister of Natural Resources
234.	Teachers' Superannuation Commission	Chair of the Commission
235.	Toronto Area Transit Operating Authority	Chair of the Authority
236.	University Research Incentive Fund Selection Committee	Minister of Colleges and Universities
237.	Wolf Damage Assessment Board	Minister of Agriculture and Food
238.	Workers' Compensation Appeals Tribunal	Minister of Labour
239.	Workers' Compensation Board	Chair of the Board

O. Reg. 516/90, Sched.

Form 1*Freedom of Information and Protection of Privacy Act***AGREEMENT**

This agreement is made between, referred to
name of researcher

below as the researcher, and, referred to
name of institution
below as the institution.

The researcher has requested access to the following records that contain personal information and are in the custody or under the control of the institution: (Describe the records below)

.....
The researcher understands and promises to abide by the following terms and conditions:

NUMÉRO	COLONNE 1	COLONNE 2
	INSTITUTION	PERSONNE RESPONSABLE
216	Commission des griefs de la fonction publique	Ministre du Travail
217	Curateur public	Procureur général
218	Comité consultatif sur la rage	Ministre des Richesses naturelles
219	Comité consultatif sur les biens immobiliers	Ministre des Services gouvernementaux
220	Comité consultatif du recyclage	Ministre de l'Environnement
221	Commission de révision des loyers	Ministre du Logement
222	Conseil des normes de location résidentielle	Ministre du Logement
223	Commission de location résidentielle	Ministre du Logement
224	Conseil de révision constitué en vertu de la <i>Loi sur la santé mentale</i>	Ministre de la Santé
225	Musée royal de l'Ontario	Président du conseil d'administration
226	Commission des parcs du Saint-Laurent	Ministre du Tourisme et des Loisirs
227	Comité de sélection	Ministre des Collèges et Universités
228	Comité consultatif sur la gestion des rives	Ministre des Richesses naturelles
229	Commission de révision de l'aide sociale	Ministre des Services sociaux et communautaires
230	Commission d'aide aux anciens combattants	Ministre des Services sociaux et communautaires
231	Stadium Corporation of Ontario Limited	Président de la société
232	Comité des règles d'exercice des compétences légales	Procureur général
233	Conseil consultatif pour la gestion du bassin de la rivière Sturgeon, du lac Nipissing et de la rivière des Français	Ministre des Richesses naturelles
234	Conseil du régime de retraite des enseignantes et des enseignants de l'Ontario	Président du conseil
235	Régie des transports en commun de la région de Toronto	Président de la Régie
236	Comité de sélection du Fonds d'encouragement à la recherche dans les universités	Ministre des Collèges et Universités
237	Commission d'évaluation des dommages causés par les loups	Ministre de l'Agriculture et de l'Alimentation
238	Tribunal d'appel des accidents du travail	Ministre du Travail
239	Commission des accidents du travail	Président de la Commission

Règl. de l'Ont. 655/90, art. 1, *en partie*.**Formule 1***Loi sur l'accès à l'information et la protection de la vie privée***ACCORD**

Le présent accord est conclu entre, ci-après appelé
nom de l'auteur de la demande

l'auteur de la demande, et, ci-après appelé l'institution.
nom de l'institution

L'auteur de la demande a présenté une demande d'accès aux documents suivants qui contiennent des renseignements personnels et dont l'institution a la garde ou le contrôle. (Décrire les documents ci-dessous.)

.....

L'auteur de la demande comprend les conditions suivantes et promet de s'y conformer :

1. The researcher will not use the information in the records for any purpose other than the following research purpose unless the researcher has the institution's written authorization to do so: (Describe the research purpose below)

.....

2. The researcher will give access to personal information in a form in which the individual to whom it relates can be identified only to the following persons: (Name the persons below)

.....

3. Before disclosing personal information to persons mentioned above, the researcher will enter into an agreement with those persons to ensure that they will not disclose it to any other person.

4. The researcher will keep the information in a physically secure location to which access is given only to the researcher and to the persons mentioned above.

5. The researcher will destroy all individual identifiers in the information by (date)

6. The researcher will not contact any individual to whom personal information relates, directly or indirectly, without the prior written authority of the institution.

7. The researcher will ensure that no personal information will be used or disclosed in a form in which the individual to whom it relates can be identified without the written authority of the institution.

8. The researcher will notify the institution in writing immediately upon becoming aware that any of the conditions set out in this agreement have been breached.

Signed at this day of, 199.....

Researcher
Name:
Address:
Telephone:

Representative of Institution
Name:
Position:
Institution:
Address:
Telephone:

O. Reg. 516/90, Form I.

1. L'auteur de la demande n'utilisera les renseignements contenus dans les documents qu'aux fins de recherche ci-après précisées, sauf autorisation écrite de l'institution. (Décrire l'objet de la recherche ci-dessous.)
.....
2. L'auteur de la demande ne donnera accès aux renseignements personnels sous une forme dans laquelle le particulier concerné par ces renseignements peut être identifié qu'aux personnes suivantes. (Nommer les personnes ci-dessous.)
.....
3. Avant de divulguer des renseignements personnels aux personnes visées ci-dessus, l'auteur de la demande conclura un accord avec celles-ci pour veiller à ce qu'elles ne les divulguent pas à d'autres personnes.
4. L'auteur de la demande conservera les renseignements dans un endroit sûr dont l'accès n'est accordé qu'à lui et aux personnes visées ci-dessus.
5. L'auteur de la demande détruira tous les identificateurs individuels contenus dans les renseignements au plus tard le
(date)
6. L'auteur de la demande ne communiquera pas avec les particuliers concernés par ces renseignements personnels, directement ou indirectement, sans obtenir au préalable l'autorisation écrite de l'institution.
7. L'auteur de la demande veillera à ce qu'aucun renseignement personnel ne soit utilisé ni divulgué sous une forme dans laquelle le particulier concerné par ce renseignement peut être identifié, à moins d'obtenir l'autorisation écrite de l'institution.
8. L'auteur de la demande avisera l'institution par écrit immédiatement s'il apprend que les conditions énoncées dans le présent accord n'ont pas été observées.

Fait à le 199.....

Auteur de la demande

Nom :

Adresse :

Téléphone :

Représentant de l'institution

Nom :

Poste :

Institution :

Adresse :

Téléphone :

Règl. de l'Ont. 655/90, art. 1, en partie.

Form 2

Freedom of Information and Protection of Privacy Act

Request for: <input type="checkbox"/> Access to General Records <input type="checkbox"/> Access to Own Personal Information <input type="checkbox"/> Correction of Own Personal Information	Name of Institution request made to.			
If request is for access to, or correction of, own personal information records: Last name appearing on records. <input type="checkbox"/> same as below or <input type="checkbox"/>				
Details				
Last Name	First Name	Middle Name	<input type="checkbox"/> Mr.	<input type="checkbox"/> Mrs.
			<input type="checkbox"/> Ms.	<input type="checkbox"/> Miss
Address (Street/Apt. No./P.O. Box No./R.R. No.)			City or Town	Province
Postal Code	Telephone Number(s) Day <input type="checkbox"/> Evening <input type="checkbox"/>	Area Code	Area Code	
Detailed description of requested records, personal information records or personal information to be corrected (If you are requesting access to, or correction of, your personal information, please identify the personal information bank or record containing the personal information, if known)				

Note: If you are requesting a correction of personal information, please indicate the desired correction and, if appropriate, attach any supporting documentation. You will be notified if the correction is not made and you may require that a statement of disagreement be attached to your personal information.

Preferred method of access to records: <input type="checkbox"/> Examine Original <input type="checkbox"/> Receive Copy	Signature	Date Day Month Year
For Institution Use Only		
Date received Day Month Year	Request Number	Comments

Personal information contained on this form is collected pursuant to the Freedom of Information and Protection of Privacy Act and will be used for the purpose of responding to your request. Questions about this collection should be directed to the Freedom of Information and Privacy Coordinator at the institution where the request is made.

1278

Formule 2

Loi sur l'accès à l'information et la protection de la vie privée

Demande : <input type="checkbox"/> Accès à des documents d'ordre général <input type="checkbox"/> Accès à des renseignements personnels sur soi <input type="checkbox"/> Rectification de renseignements personnels sur soi		Nom de l'institution à laquelle la demande est présentée		
S'il s'agit d'une demande d'accès à des renseignements personnels sur soi ou de rectification de ceux-ci : Nom de famille figurant dans les documents : <input type="checkbox"/> même que ci-dessous ou ►				
Détails				
Nom de famille		Prénom	Second prénom	<input type="checkbox"/> M. <input type="checkbox"/> M ^{me} <input type="checkbox"/> M ^{lle}
Adresse (Rue / N° d'app. / C.P. / R.R.)		Cité ou ville	Province	
Code Postal	Numéro(s) de téléphone	Indicatif régional	Indicatif régional	
	Jour ►		Soir ►	
Description détaillée des documents ou des renseignements personnels demandés ou des renseignements personnels à rectifier. (Si vous présentez une demande d'accès à des renseignements personnels vous concernant ou de rectification de ceux-ci, veuillez indiquer la banque de renseignements personnels ou le document contenant ces renseignements, si vous le savez.)				

Remarque : Si vous présentez une demande de rectification de renseignements personnels, veuillez indiquer la rectification demandée et, s'il y a lieu, annexer les documents à l'appui. Si la rectification n'est pas effectuée, vous en serez avisé et vous pourrez exiger qu'une déclaration de désaccord soit annexée aux renseignements personnels vous concernant.

Mode préféré d'accès aux documents <input type="checkbox"/> Consulter l'original <input type="checkbox"/> Recevoir une copie		Signature		Date Jour Mois Année		
À l'usage exclusif de l'institution						
Date de réception Jour Mois Année			Numéro de la demande		Remarques	

Les renseignements personnels figurant sur cette formule sont recueillis conformément à la Loi sur l'accès à l'information et la protection de la vie privée et seront utilisés pour donner suite à votre demande. Les questions sur cette collecte devraient être adressées au coordonnateur de l'accès à l'information et de la protection de la vie privée de l'institution à laquelle est présentée la demande.

Règl. de l'Ont. 655/90, art. I, en partie.

French Language Services Act
Loi sur les services en français

REGULATION 461**EXEMPTIONS**

1. In this Regulation, “highway” means a highway, as defined in the *Public Transportation and Highway Improvement Act*, that is under the jurisdiction and control of the Minister of Transportation. O. Reg. 540/89, s. 1.

2. The following are exempt from the application of sections 2 and 5 of the Act:

1. Publications prepared by or for government agencies or institutions of the Legislature, or appendices to those publications, that are of a scientific, technical, reference, research or scholarly nature and that,
 - i. although not restricted in circulation to the confines of the Government of Ontario, are not normally available for general circulation to members of the public, or
 - ii. are normally consulted by members of the public with the assistance of public servants.
2. Signs on highways in The Municipality of Metropolitan Toronto, the City of Hamilton and the City of Mississauga. O. Reg. 540/89, s. 2.

3. This Regulation is revoked on the 19th day of November, 1992.

RÈGLEMENT 461**EXEMPTIONS**

1 Dans le présent règlement, l'expression «voie publique» s'entend d'une voie publique, au sens de la *Loi sur l'aménagement des voies publiques et des transports en commun*, qui est du ressort du ministre des Transports. Règl. de l'Ont. 540/89, art. 1.

2 Les articles 2 et 5 de la Loi ne s'appliquent pas à ce qui suit :

1. Les publications ou les annexes de celles-ci rédigées par des organismes gouvernementaux ou des institutions de la Législature qui sont de caractère scientifique, technique ou savant, ou ont un but de consultation ou de recherche et :
 - i. soit qui, bien que leur circulation ne se limite pas au gouvernement de l'Ontario, ne sont pas normalement mises à la disposition du public en général,
 - ii. soit qui sont normalement consultées par le public avec l'aide de fonctionnaires.
2. Les panneaux de signalisation situés le long des voies publiques qui se trouvent dans la municipalité de la communauté urbaine de Toronto, la cité de Hamilton et la cité de Mississauga. Règl. de l'Ont. 540/89, art. 2.

3 Le présent règlement est abrogé le 19 novembre 1992.

REGULATION 462**GENERAL**

1. The following are designated as public service agencies for the purpose of the definition of “government agency” in section 1 of the Act:

1. Hôpital Notre-Dame Hospital in Hearst.
2. Hôpital Montfort in Ottawa.
3. Maison Fraternité—Fraternity House in Vanier in respect of the programs carried out on behalf of the Ministry of Health and the Ministry of Community and Social Services.
4. Hébergement Renaissance Inc. in Ottawa.
5. Centre Médical Ste-Anne Inc. in Ottawa.
6. Services psychiatriques francophones de l'est de l'Ontario in Ottawa.
7. Royal Ottawa Health Care Group/Services de Santé Royal Ottawa but only in respect of the rehabilitation Centre, geriatric psychiatric services and psychiatric rehabilitation program.

RÈGLEMENT 462**DISPOSITIONS GÉNÉRALES**

1 Les organismes suivants sont désignés comme des organismes offrant des services publics, aux fins de la définition du terme «organisme gouvernemental» figurant à l'article 1 de la Loi :

1. Hôpital Notre-Dame Hospital à Hearst.
2. Hôpital Montfort à Ottawa.
3. Maison Fraternité—Fraternity House à Vanier à l'égard des programmes exécutés pour le compte du ministère de la Santé et du ministère des Services sociaux et communautaires.
4. Hébergement Renaissance Inc. à Ottawa.
5. Centre Médical Ste-Anne Inc. à Ottawa.
6. Services psychiatriques francophones de l'est de l'Ontario à Ottawa.
7. Royal Ottawa Health Care Group/Services de Santé Royal Ottawa, mais seulement à l'égard du Centre de réhabilitation, des services de psychiatrie gériatriques et du programme de réadaptation psychiatrique.

- | | |
|---|--|
| <p>8. Services de toxicomanie Cochrane Nord Inc.—North Cochrane Addiction Services Inc. in Kapuskasing, Cochrane, Hearst and Smooth Rock Falls in respect of the programs carried out on behalf of the Ministry of Health.</p> <p>9. Hearst, Kapuskasing, Smooth Rock Falls Counselling Services/Services de counselling de Hearst, Kapuskasing, Smooth Rock Falls in respect of the programs carried out on behalf of the Ministry of Health.</p> <p>10. Maison Renaissance de la Réhabilitation in Hearst in respect of the programs carried out on behalf of the Ministry of Health.</p> <p>11. Maison Arc-En-Ciel Centre de réhabilitation du nord de l'Ontario Inc. in Opatatika in respect of the programs carried out on behalf of the Ministry of Health.</p> <p>12. Sensenbrenner Hospital in Kapuskasing.</p> <p>13. Le Service Familial de la région de Sudbury Inc. in respect of the programs carried out on behalf of the Ministry of Community and Social Services and the Ministry of Correctional Services.</p> <p>14. Maison Décision House in Ottawa in respect of the programs carried out on behalf of the Ministry of Correctional Services.</p> <p>15. Les Services correctionnels communautaires de Prescott-Russell et Glengarry in respect of the programs carried out on behalf of the Ministry of Correctional Services.</p> <p>16. Centre d'activités françaises de Penetanguishene in respect of the programs carried out on behalf of the Ministry of Community and Social Services.</p> <p>17. Centre des Pionniers in Toronto in respect of the programs carried out on behalf of the Ministry of Community and Social Services.</p> <p>18. Club d'âge d'or de la Vallée Inc./Golden Age Club of the Valley in Hanmer in respect of the programs carried out on behalf of the Ministry of Community and Social Services.</p> <p>19. Club Accueil/âge d'or d'Azilda in respect of the programs carried out on behalf of the Ministry of Community and Social Services.</p> <p>20. Union Culturelle des Franco-Ontariennes in Sudbury in respect of the programs carried out on behalf of the Ministry of Community and Social Services.</p> <p>21. Cambrian College in Sudbury in respect of the programs carried out on behalf of the Ministry of Community and Social Services by l'Arc-En-Ciel/ Carrousel.</p> <p>22. Association pour les Handicapés mentaux de Hearst et de la région de Hearst/Hearst and District Association for Mentally Handicapped in respect of the programs carried out on behalf of the Ministry of Community and Social Services.</p> <p>23. Services à la Jeunesse de Hearst Inc. in respect of the programs carried out on behalf of the Ministry of Community and Social Services.</p> <p>24. Services Familiaux du District de Cochrane-Nord/North Cochrane District Family Services in Kapuskasing in respect of the programs carried out on behalf of the Ministry of Community and Social Services.</p> | <p>8. Services de toxicomanie Cochrane Nord Inc.—North Cochrane Addiction Services Inc. à Kapuskasing, Cochrane, Hearst et Smooth Rock Falls à l'égard des programmes exécutés pour le compte du ministère de la Santé.</p> <p>9. Hearst, Kapuskasing, Smooth Rock Falls Counselling Services/Services de counselling de Hearst, Kapuskasing, Smooth Rock Falls à l'égard des programmes exécutés pour le compte du ministère de la Santé.</p> <p>10. Maison Renaissance de la Réhabilitation à Hearst à l'égard des programmes exécutés pour le compte du ministère de la Santé.</p> <p>11. Maison Arc-En-Ciel Centre de réhabilitation du nord de l'Ontario Inc. à Opatatika à l'égard des programmes exécutés pour le compte du ministère de la Santé.</p> <p>12. Sensenbrenner Hospital à Kapuskasing.</p> <p>13. Le Service Familial de la région de Sudbury Inc. à l'égard des programmes exécutés pour le compte du ministère des Services sociaux et communautaires et du ministère des Services correctionnels.</p> <p>14. Maison Décision House à Ottawa à l'égard des programmes exécutés pour le compte du ministère des Services correctionnels.</p> <p>15. Les Services correctionnels communautaires de Prescott-Russell et Glengarry à l'égard des programmes exécutés pour le compte du ministère des Services correctionnels.</p> <p>16. Centre d'activités françaises de Penetanguishene à l'égard des programmes exécutés pour le compte du ministère des Services sociaux et communautaires.</p> <p>17. Centre des Pionniers à Toronto à l'égard des programmes exécutés pour le compte du ministère des Services sociaux et communautaires.</p> <p>18. Club d'âge d'or de la Vallée Inc./Golden Age Club of the Valley à Hanmer à l'égard des programmes exécutés pour le compte du ministère des Services sociaux et communautaires.</p> <p>19. Club Accueil/âge d'or d'Azilda à l'égard des programmes exécutés pour le compte du ministère des Services sociaux et communautaires.</p> <p>20. Union Culturelle des Franco-Ontariennes à Sudbury à l'égard des programmes exécutés pour le compte du ministère des Services sociaux et communautaires.</p> <p>21. Cambrian College à Sudbury à l'égard des programmes exécutés par l'Arc-En-Ciel/Carrousel pour le compte du ministère des Services sociaux et communautaires.</p> <p>22. Association pour les Handicapés mentaux de Hearst et de la région de Hearst/Hearst and District Association for Mentally Handicapped à l'égard des programmes exécutés pour le compte du ministère des Services sociaux et communautaires.</p> <p>23. Services à la Jeunesse de Hearst Inc. à l'égard des programmes exécutés pour le compte du ministère des Services sociaux et communautaires.</p> <p>24. Services Familiaux du District de Cochrane-Nord/North Cochrane District Family Services à Kapuskasing à l'égard des programmes exécutés pour le compte du ministère des Services sociaux et communautaires.</p> |
|---|--|

- | | |
|---|---|
| <p>25. Les services à la Jeunesse Jeanne Sauvé Youth Services Inc. in Kapuskasing in respect of the programs carried out on behalf of the Ministry of Community and Social Services.</p> <p>26. Centre de counselling familial de Timmins/Timmins Family Counselling Centre Inc. in respect of the programs carried out on behalf of the Ministry of Community and Social Services and the Ministry of Correctional Services.</p> <p>27. Association pour l'intégration communautaire de Nipissing Ouest/West Nipissing Association for Community Living in Sturgeon Falls in respect of the programs carried out on behalf of the Ministry of Community and Social Services.</p> <p>28. Club d'âge d'or River Valley/Golden Age Club in River Valley in respect of the programs carried out on behalf of the Ministry of Community and Social Services.</p> <p>29. Maison d'amitié in Ottawa in respect of the programs carried out on behalf of the Ministry of Community and Social Services.</p> <p>30. Centre de jour Séraphin-Marion d'Orléans in respect of the programs carried out on behalf of the Ministry of Community and Social Services.</p> <p>31. Le Centre de jour polyvalent des aînés francophones d'Ottawa-Carleton in Ottawa in respect of the programs carried out on behalf of the Ministry of Community and Social Services.</p> <p>32. Centre psycho-social pour enfants et familles Ottawa-Carleton in Ottawa in respect of the programs carried out on behalf of the Ministry of Community and Social Services.</p> <p>33. Co-opérative Carrousel pour parents et enfants francophones Inc. in Ottawa in respect of the programs carried out on behalf of the Ministry of Community and Social Services.</p> <p>34. Service d'entraide communautaire in Ottawa in respect of the programs carried out on behalf of the Ministry of Community and Social Services.</p> <p>35. Les Soeurs de la Charité d'Ottawa (Corporation)—La Résidence Saint-Louis (Registered Business Name) in Ottawa in respect of the programs carried out on behalf of the Ministry of Community and Social Services.</p> <p>36. Centre de services communautaires de Vanier—Vanier Community Service Centre in respect of the programs carried out on behalf of the Ministry of Community and Social Services.</p> <p>37. Centre Lajoie des Aînés(es) francophones de Pembroke in respect of the programs carried out on behalf of the Ministry of Community and Social Services.</p> <p>38. Groupe Action pour l'Enfant, la Famille et la Communauté de Prescott-Russell in Hawkesbury in respect of the programs carried out on behalf of the Ministry of Community and Social Services.</p> <p>39. Maison Interlude House Inc. in Hawkesbury in respect of the programs carried out on behalf of the Ministry of Community and Social Services.</p> | <p>25. Les services à la Jeunesse Jeanne Sauvé Youth Services Inc. à Kapuskasing à l'égard des programmes exécutés pour le compte du ministère des Services sociaux et communautaires.</p> <p>26. Centre de counselling familial de Timmins/Timmins Family Counselling Centre Inc. à l'égard des programmes exécutés pour le compte du ministère des Services sociaux et communautaires et du ministère des Services correctionnels.</p> <p>27. Association pour l'intégration communautaire de Nipissing Ouest/West Nipissing Association for Community Living à Sturgeon Falls à l'égard des programmes exécutés pour le compte du ministère des Services sociaux et communautaires.</p> <p>28. Club d'âge d'or River Valley/Golden Age Club à River Valley à l'égard des programmes exécutés pour le compte du ministère des Services sociaux et communautaires.</p> <p>29. Maison d'amitié à Ottawa à l'égard des programmes exécutés pour le compte du ministère des Services sociaux et communautaires.</p> <p>30. Centre de jour Séraphin-Marion d'Orléans à l'égard des programmes exécutés pour le compte du ministère des Services sociaux et communautaires.</p> <p>31. Le Centre de jour polyvalent des aînés francophones d'Ottawa-Carleton à Ottawa à l'égard des programmes exécutés pour le compte du ministère des Services sociaux et communautaires.</p> <p>32. Centre psycho-social pour enfants et familles Ottawa-Carleton à Ottawa à l'égard des programmes exécutés pour le compte du ministère des Services sociaux et communautaires.</p> <p>33. Co-opérative Carrousel pour parents et enfants francophones Inc. à Ottawa à l'égard des programmes exécutés pour le compte du ministère des Services sociaux et communautaires.</p> <p>34. Service d'entraide communautaire à Ottawa à l'égard des programmes exécutés pour le compte du ministère des Services sociaux et communautaires.</p> <p>35. Les Soeurs de la Charité d'Ottawa (personne morale)—La Résidence Saint-Louis (nom commercial inscrit) à Ottawa à l'égard des programmes exécutés pour le compte du ministère des Services sociaux et communautaires.</p> <p>36. Centre de services communautaires de Vanier—Vanier Community Service Centre à l'égard des programmes exécutés pour le compte du ministère des Services sociaux et communautaires.</p> <p>37. Centre Lajoie des Aînés(es) francophones de Pembroke à l'égard des programmes exécutés pour le compte du ministère des Services sociaux et communautaires.</p> <p>38. Groupe Action pour l'Enfant, la Famille et la Communauté de Prescott-Russell à Hawkesbury à l'égard des programmes exécutés pour le compte du ministère des Services sociaux et communautaires.</p> <p>39. Maison Interlude House Inc. à Hawkesbury à l'égard des programmes exécutés pour le compte du ministère des Services sociaux et communautaires.</p> |
|---|---|

- | | |
|---|---|
| <p>40. The Prescott-Russell Association for the Mentally Retarded/L'Association pour les déficients mentaux de Prescott-Russell in Hawkesbury in respect of the programs carried out on behalf of the Ministry of Community and Social Services.</p> <p>41. La Société de l'aide à l'enfance de Prescott-Russell/The Children's Aid Society of Prescott and Russell in Plantagenet in respect of the programs carried out on behalf of the Ministry of Community and Social Services.</p> <p>42. Services communautaires de Prescott-Russell in Hawkesbury in respect of the programs carried out on behalf of the Ministry of Community and Social Services.</p> <p>43. Centre d'accueil Roger-Séguin in Clarence Creek in respect of the programs carried out on behalf of the Ministry of Community and Social Services.</p> <p>44. Centre de Services Familiaux de Prescott-Russell in Hawkesbury in respect of the programs carried out on behalf of the Ministry of Community and Social Services.</p> <p>45. L'Équipe d'hygiène mentale pour francophones de Stormont, Dundas et Glengarry Inc. in Cornwall in respect of the programs carried out on behalf of the Ministry of Community and Social Services.</p> <p>46. Centre des services de développement pour Stormont, Dundas et Glengarry in Cornwall in respect of the programs carried out on behalf of the Ministry of Community and Social Services.</p> <p>47. Hôpital général de Hawkesbury and District General Hospital Inc.</p> <p>48. The Sudbury and District Association for Community Living/Association pour l'intégration communautaire de Sudbury et district in respect of the programs carried out on behalf of the Ministry of Community and Social Services.</p> <p>49. Association pour les services préscolaires d'Ottawa-Carleton.</p> <p>50. Centre de jour des Petits Poucets.</p> <p>51. Centre des petits d'Ottawa Inc.</p> <p>52. Centre préscolaire Coccinelle d'Orléans.</p> <p>53. Coopérative Brin d'herbe Inc.</p> <p>54. Garderie Le Cerf-volant de Gaston Vincent.</p> <p>55. Garderie «Sur un nuage» d'Ottawa-Carleton.</p> <p>56. Le Centre parascolaire l'Hirondelle d'Ottawa.</p> <p>57. Programme Para-scolaire La Vérendrye.</p> <p>58. Centre parascolaire des Pionniers.</p> <p>59. Centre médico-social communautaire (Toronto) Inc.</p> <p>60. Ottawa Civic Hospital Corporation in respect of the in-vitro fertilization and dentistry clinics.</p> <p>61. Saint-Vincent Hospital/Hôpital Saint-Vincent (Soeurs de la Charité d'Ottawa/Sisters of Charity at Ottawa).</p> <p>62. Centre de santé Élisabeth-Bruyère/Élisabeth-Bruyère Health Centre (Soeurs de la Charité d'Ottawa/Sisters of Charity at Ottawa).</p> | <p>40. The Prescott-Russell Association for the Mentally Retarded/L'Association pour les déficients mentaux de Prescott-Russell à Hawkesbury à l'égard des programmes exécutés pour le compte du ministère des Services sociaux et communautaires.</p> <p>41. La Société de l'aide à l'enfance de Prescott-Russell/The Children's Aid Society of Prescott and Russell à Plantagenet à l'égard des programmes exécutés pour le compte du ministère des Services sociaux et communautaires.</p> <p>42. Services communautaires de Prescott-Russell à Hawkesbury à l'égard des programmes exécutés pour le compte du ministère des Services sociaux et communautaires.</p> <p>43. Centre d'accueil Roger-Séguin à Clarence Creek à l'égard des programmes exécutés pour le compte du ministère des Services sociaux et communautaires.</p> <p>44. Centre de Services Familiaux de Prescott-Russell à Hawkesbury à l'égard des programmes exécutés pour le compte du ministère des Services sociaux et communautaires.</p> <p>45. L'Équipe d'hygiène mentale pour francophones de Stormont, Dundas et Glengarry Inc. à Cornwall à l'égard des programmes exécutés pour le compte du ministère des Services sociaux et communautaires.</p> <p>46. Centre des services de développement pour Stormont, Dundas et Glengarry à Cornwall à l'égard des programmes exécutés pour le compte du ministère des Services sociaux et communautaires.</p> <p>47. Hôpital général de Hawkesbury and District General Hospital Inc.</p> <p>48. The Sudbury and District Association for Community Living/Association pour l'intégration communautaire de Sudbury et district à l'égard des programmes exécutés pour le compte du ministère des Services sociaux et communautaires.</p> <p>49. Association pour les services préscolaires d'Ottawa-Carleton.</p> <p>50. Centre de jour des Petits Poucets.</p> <p>51. Centre des petits d'Ottawa Inc.</p> <p>52. Centre préscolaire Coccinelle d'Orléans.</p> <p>53. Coopérative Brin d'herbe Inc.</p> <p>54. Garderie Le Cerf-volant de Gaston Vincent.</p> <p>55. Garderie «Sur un nuage» d'Ottawa-Carleton.</p> <p>56. Le Centre parascolaire l'Hirondelle d'Ottawa.</p> <p>57. Programme Para-scolaire La Vérendrye.</p> <p>58. Centre parascolaire des Pionniers.</p> <p>59. Centre médico-social communautaire (Toronto) Inc.</p> <p>60. Ottawa Civic Hospital Corporation à l'égard des cliniques de soins dentaires et des cliniques de fécondation in vitro.</p> <p>61. Saint-Vincent Hospital/Hôpital Saint-Vincent (Soeurs de la Charité d'Ottawa/Sisters of Charity at Ottawa).</p> <p>62. Centre de santé Élisabeth-Bruyère/Élisabeth-Bruyère Health Centre (Soeurs de la Charité d'Ottawa/Sisters of Charity at Ottawa).</p> |
|---|---|

- | | |
|---|---|
| <p>63. Hôpital général de Mattawa/Mattawa General Hospital (Soeurs de la Charité d'Ottawa/Sisters of Charity at Ottawa) in respect of ambulance services.</p> <p>64. The Lady Minto Hospital at Cochrane in respect of ambulance services.</p> <p>65. Minto Counselling Centre in respect of the programs carried out on behalf of the Ministry of Health.</p> <p>66. The West Nipissing General Hospital/Hôpital général de l'ouest Nipissing in respect of ambulance services.</p> <p>67. Timmins and District Hospital/L'Hôpital de Timmins et du district in respect of administrative services at the Timmins and District Hospital Corporation, primary, secondary and acute care at the St. Mary's General Hospital, and chronic care at the Porcupine General Hospital.</p> <p>68. Nipissing District Youth Employment Service Inc. in respect of the community service order program carried out on behalf of the Ministry of Correctional Services.</p> <p>69. Recon Association in respect of the programs carried out on behalf of the Ministry of Correctional Services.</p> <p>70. La Fraternité-The Fraternity in respect of the programs carried out on behalf of the Ministry of Correctional Services.</p> <p>71. Volunteer Organization in Community Correctional Services (V.O.I.C.S.S.) in respect of the programs carried out on behalf of the Ministry of Correctional Services. O. Reg. 632/89, s. 1; O. Reg. 676/90, s. 1.</p> | <p>63. Hôpital général de Mattawa/Mattawa General Hospital (Soeurs de la Charité d'Ottawa/Sisters of Charity at Ottawa) à l'égard des services d'ambulance.</p> <p>64. The Lady Minto Hospital at Cochrane à l'égard des services d'ambulance.</p> <p>65. Minto Counselling Centre à l'égard des programmes exécutés pour le compte du ministère de la Santé.</p> <p>66. The West Nipissing General Hospital/Hôpital général de l'ouest Nipissing à l'égard des services d'ambulance.</p> <p>67. Timmins and District Hospital/L'Hôpital de Timmins et du district à l'égard des services administratifs offerts au Timmins and District Hospital Corporation, des soins primaires et secondaires et des soins reliés aux maladies aiguës offerts au St. Mary's General Hospital et des soins reliés aux maladies chroniques offerts au Porcupine General Hospital.</p> <p>68. Nipissing District Youth Employment Service Inc. à l'égard du programme d'ordonnance de service à la communauté exécuté pour le compte du ministère des Services correctionnels.</p> <p>69. Recon Association à l'égard des programmes exécutés pour le compte du ministère des Services correctionnels.</p> <p>70. La Fraternité-The Fraternity à l'égard des programmes exécutés pour le compte du ministère des Services correctionnels.</p> <p>71. Volunteer Organization in Community Correctional Services (V.O.I.C.S.S.) à l'égard des programmes exécutés pour le compte du ministère des Services correctionnels. Règl. de l'Ont. 632/89, art. 1; Règl. de l'Ont. 676/90, art. 1.</p> |
|---|---|
-

Freshwater Fish Marketing Act (Ontario)

Loi sur la commercialisation du poisson d'eau douce (Ontario)

REGULATION 463

GENERAL

1. The Freshwater Fish Marketing Corporation established under the *Freshwater Fish Marketing Act* (Canada) is designated as the body to control the selling and buying of fish in the parts of Ontario designated in Schedule 1. R.R.O. 1980, Reg. 398, s. 1.

2. The Act does not apply to the sale of fish to or the purchase of fish by a person for consumption by that person or his or her family or for consumption by persons or animals, in the course of his or her business. R.R.O. 1980, Reg. 398, s. 2.

Schedule 1

In the territorial districts of Cochrane, Kenora and Thunder Bay described as follows:

Beginning at the intersection of the water's edge of Hudson Bay with longitude 86° 00'; thence southerly along longitude 86° 00' to the water's edge along the northerly shore of Lake Superior; thence in a northwesterly and southwesterly direction along that water's edge to the northerly shore of the Pigeon River; thence south astronomically to the International Boundary between Canada and the United States of America; thence westerly along that International Boundary to the southerly production of the easterly boundary of the geographic Township of Hartington in the Territorial District of Thunder Bay; thence northerly along that production and the easterly boundary of the geographic townships of Hartington, Lismore, Strange, Aldina, Sackville, Laurie and Blackwell to the centreline of that part of the King's Highway known as No. 11; thence easterly along that centreline to the centreline of that part of the King's Highway known as No. 17; thence northwesterly along that centreline to longitude 92° 30'; thence northerly along longitude 92° 30' to the northerly boundary of geographic Township McIlraith; thence westerly along the northerly boundary of the geographic townships of McIlraith, Breithaupt, Daniel and Rowell to the northwesterly corner of the last-mentioned geographic township; thence northerly along the 6th Meridian to the 7th Base Line; thence westerly along that base line to the centreline of that part of the King's Highway known as No. 105; thence northwesterly along that centreline to latitude 51° 00'; thence westerly along that latitude to the Interprovincial Boundary between Ontario and Manitoba; thence northerly and northeasterly along that boundary to the water's edge of Hudson Bay; thence southeasterly along that water's edge to the place of beginning.

Except the waters of the following bodies of water:

1. Basket Lake in the Territorial District of Kenora, Patricia Portion, at approximate latitude 49° 43' north, longitude 92° 00' west.
2. McCusker Lake in the Territorial District of Kenora, Patricia Portion, at approximate latitude 51° 39' north, longitude 94° 39' west.
3. Musclow Lake in the Territorial District of Kenora, Patricia Portion, at approximate latitude 51° 24' north, longitude 94° 57' west.
4. Lake Nipigon in the Territorial District of Thunder Bay.
5. Wapési Lake in the Territorial District of Kenora, Patricia Portion, at approximate latitude 50° 34' north, longitude 92° 21' west.
6. Paguchi Lake in the Territorial District of Kenora, at approximate latitude 49° 34' north, longitude 91° 32' west.
7. Indian Lake in the Territorial District of Kenora, at approximate latitude 49° 34' north, longitude 91° 40' west.
8. Sturgeon Lake in the territorial districts of Kenora and Thunder Bay, at approximate latitude 50° 00' north, longitude 90° 45' west.
9. Onaman Lake in the Territorial District of Thunder Bay, at approximate latitude 50° 00' north, longitude 87° 26' west.
10. Ara Lake in the Territorial District of Thunder Bay, at approximate latitude 50° 33' north, longitude 87° 28' west.
11. Meta Lake in the Territorial District of Thunder Bay, at approximate latitude 50° 30' north, longitude 87° 25' west.
12. Lac Seul in the Territorial District of Kenora, at approximate latitude 50° 20' north, longitude 92° 30' west.
13. Kagianagami Lake in the Territorial District of Thunder Bay, at approximate latitude 50° 57' north, longitude 87° 50' west.
14. Chipman Lake in the territorial districts of Cochrane and Thunder Bay, at approximate latitude 49° 58' north, longitude 86° 15' west.
15. Marshall Lake in the Territorial District of Thunder Bay, at approximate latitude 50° 25' north, longitude 87° 30' west.
16. Woman Lake in the Territorial District of Kenora, Patricia Portion, at approximate latitude 51° 12' north, longitude 92° 45' west.
17. Confederation Lake in the Territorial District of Kenora, Patricia Portion, at approximate latitude 51° 05' north, longitude 92° 44' west.
18. Smoothrock Lake in the Territorial District of Thunder Bay, at approximate latitude 50° 30' north, longitude 89° 30' west.
19. Whitewater Lake in the Territorial District of Thunder Bay, at approximate latitude 50° 48' north, longitude 89° 10' west.
20. Mojikit Lake in the Territorial District of Thunder Bay, at approximate latitude 50° 40' north, longitude 88° 15' west.
21. North Wind Lake in the Territorial District of Thunder Bay, at approximate latitude 49° 52' north, longitude 87° 57' west.
22. Summit Lake in the Territorial District of Thunder Bay, at approximate latitude 50° 25' north, longitude 87° 45' west.
23. Sowden Lake in the Territorial District of Kenora, at approximate latitude 49° 32' north, longitude 91° 12' west.
24. Abamategwia Lake in the Territorial District of Kenora, at approximate latitude 49° 40' north, longitude 91° 54' west.
25. Mameigwess Lake in the Territorial District of Kenora, at approximate latitude 49° 34' north, longitude 91° 49' west.

26. Black Sturgeon Lake in the Territorial District of Thunder Bay, at approximate latitude 49° 20' north, longitude 88° 53' west.
 27. Lake of Bays in the Territorial District of Kenora, at approximate latitude 50° 05' north, longitude 91° 15' west.
 28. Barrel Lake in the Territorial District of Kenora, at approximate latitude 49° 39' north, longitude 91° 31' west.
 29. Ogoki Lake in the Territorial District of Thunder Bay.
 30. That part of the Albany River in the territorial districts of Thunder Bay and Kenora (Patricia Portion) extending downstream from the easterly end of Washi Lake to the boundary between the territorial districts of Cochrane and Thunder Bay and its production northerly to the north shore of the Albany River. R.R.O. 1980, Reg. 398, Sched. 1; O. Reg. 777/81, s. 1.
-

Fuel Tax Act

Loi de la taxe sur les carburants

REGULATION 464

GENERAL

1.—(1) In this Regulation,

“annual registration certificate” means a registration certificate issued by the Minister under subsection 3 (1) of the Act other than an Ontario trip registration certificate;

“broker-driver” means a person who has entered into a written agreement to drive a motor vehicle on behalf of the operator of the motor vehicle, where the operator is an interjurisdictional carrier and where the person is responsible for the purchase of the fuel used to generate power in the motor vehicle;

“current registration year” means the registration year that began on the immediately preceding 1st day of July;

“fleet of interjurisdictional vehicles” means all interjurisdictional vehicles operated by an interjurisdictional carrier;

“interjurisdictional vehicle” means a motor vehicle, other than a motor vehicle referred to in clause (b) or (c) of the definition of “interjurisdictional carrier” in section 1 of the Act, operated by an interjurisdictional carrier that is,

- (a) powered by fuel as defined in section 1 of the Act,
- (b) used in the transportation of goods or passengers for compensation or in the course of a commercial undertaking, and
- (c) operated or expected to be operated both inside and outside Ontario during a registration year as defined in this subsection;

“motor vessel” means any vessel, ship, boat or watercraft that is designed to move in or through water and that is powered by fuel, but does not include any aircraft capable of operating on water or any vehicle moving on ice;

“Ontario trip registration certificate” means a registration certificate issued by the Minister under subsection 3 (1) of the Act to an interjurisdictional carrier or the interjurisdictional carrier’s agent, with respect to an interjurisdictional vehicle operated by the interjurisdictional carrier for a single trip of the vehicle that is both inside and outside Ontario;

“prior registration year” means the registration year that ended on the immediately preceding 30th day of June;

“registration year” means a twelve month period beginning on the 1st day of July. O. Reg. 251/87, s. 1 (1).

(2) The amount or quantity of dye prescribed for the purposes of the definitions of “clear fuel” and “coloured fuel” in section 1 of the Act is 3.42 parts of dye per million parts of fuel.

(3) The proportion prescribed for the purpose of the definitions of “colouring” and “colour” in section 1 of the Act is not less than 170 and not more than 190 parts of dye per million parts of fuel. O. Reg. 1/89, s. 1 (1).

(4) The following substances are prescribed for the purpose of blending with fuel to make coloured fuel:

1. A colouring agent acceptable to the Minister in a proportion that is not less than 2.8269 per cent and not more than 2.9423 per cent of the dye.
2. Furfural in a proportion that is not less than 2.8269 per cent and not more than 2.9423 per cent of the dye.
3. Xylene based aromatic solvent in a proportion that is not less than 1.8846 per cent and not more than 1.9616 per cent of the dye.
4. Fuel of a composition that the Minister considers satisfactory for blending with the components referred to in paragraphs 1, 2 and 3 in a proportion that is not less than 90.4615 per cent and not more than 94.1539 per cent of the dye. O. Reg. 1/89, s. 1 (2).

(5) When the colouring agent, furfural and xylene based aromatic solvent described in paragraphs 1, 2 and 3 of subsection (4) are combined in the proportions of not less than 36.75 parts or more than 38.25 parts colouring agent and not less than 36.75 parts or more than 38.25 parts furfural to not less than 24.25 parts or more than 25.75 parts xylene based aromatic solvent, the combination of components shall,

- (a) have a flash point at or above 29 degrees Celsius determined using the setaflash closed cup method;
- (b) have a pour point of less than minus 50 degrees Celsius;
- (c) contain not more than 0.1 per cent moisture measured according to the American Society for the Testing of Materials scale 0-95;
- (d) contain not more than 0.5 per cent by weight of fuel insolubles when the combination of components is mixed with fuel in a 7 to 1 ratio; and
- (e) have a viscosity of not more than 15 centipoise at minus 20 degrees Celsius and 5 centipoise at 20 degrees Celsius on the Brookfield scale and 10 centistokes at 20 degrees Celsius on the Kinematic scale. O. Reg. 140/83, s. 1 (2).

(6) The colouring agent referred to in paragraph 1 of subsection (4) shall be a dye with a colour value between 43 per cent and 45 per cent of colour index 26050 and shall have absorption maxima between 525 and 535 in iso-octane, or 2,2,4-trimethyl pentane.

(7) The furfural referred to in paragraph 2 of subsection (4) shall be of such quality that easily allows its detection in a product that is 5 per cent coloured stove oil and 95 per cent clear stove oil. O. Reg. 772/82, s. 1 (6, 7).

2.—(1) Fuel that is acquired principally to be consumed in the following manner is prescribed for the purposes of subsection 2 (2) of the Act:

1. In the operation of railway equipment on rails where the railway equipment is operated in connection with and as part of a public transportation system.
2. In the operation of a motor vessel where the operator of the motor vessel is an interjurisdictional carrier.
3. As a raw material to be wrought into or become part of

goods for sale, provided that the fuel is not used to generate power in a motor vehicle.

(2) An application under subsection 2 (1) of the Act shall be made to the Minister in Form 1.

(3) A fuel acquisition permit shall be in Form 2 or Form 3, as the case may be.

(4) A registered consumer who changes the name or nature of the consumer's business, shall forthwith return the consumer's fuel acquisition permit to the Minister and may apply for a new fuel acquisition permit in accordance with subsection (2).

(5) Where a registered consumer ceases to carry on the business in respect of which a fuel acquisition permit has been issued, the registered consumer shall return the fuel acquisition permit to the Minister within fifteen days of ceasing to carry on the business.

(6) Where a fuel acquisition permit is lost or destroyed, the registered consumer whose fuel acquisition permit is lost shall forthwith notify the Minister of the loss and may apply for a new fuel acquisition permit, in accordance with subsection (2).

(7) A fuel acquisition permit is not transferable.

(8) Where a registered consumer does not produce the consumer's fuel acquisition permit for the inspection of a collector from whom the consumer purchases clear fuel at the time of the purchase of the fuel, the registered consumer shall pay the tax required to be paid under the Act as if the consumer were not a registered consumer. O. Reg. 772/82, s. 2.

3.—(1) Every interjurisdictional carrier whose head or registered office is located,

- (a) in Ontario and whose fleet of interjurisdictional vehicles travelled or may reasonably be expected to travel, an aggregate distance of 10,000 kilometres or more outside Ontario; or
- (b) outside Ontario and whose fleet of interjurisdictional vehicles travelled or may reasonably be expected to travel, an aggregate distance of 10,000 kilometres or more in Ontario,

during either the prior registration year or the current registration year shall make an application in Form 4 for annual registration certificates for all vehicles in the applicant's fleet of interjurisdictional vehicles.

(2) Every interjurisdictional carrier, other than an interjurisdictional carrier referred to in subsection (1), shall make application,

- (a) for an Ontario trip registration certificate before an interjurisdictional vehicle of the applicant is driven in Ontario on each trip of the vehicle that is both inside and outside Ontario; or
- (b) in Form 4 for annual registration certificates for the current registration year for all interjurisdictional vehicles of the applicant.

(3) Every interjurisdictional carrier who has made an application in Form 4 or under this subsection for a current registration year shall,

- (a) make application in Form 5 for additional annual registration certificates for the current registration year for vehicles,
 - (i) that become part of the applicant's fleet of interjurisdictional vehicles during the current registration year, or
 - (ii) that form part of the applicant's fleet of interjurisdic-

tional vehicles and for which the applicant, for any reason, does not have annual registration certificates for the current registration year; and

- (b) make application in Form 5 at least sixty days before the end of the current registration year and each subsequent registration year for annual registration certificates for all interjurisdictional vehicles operated by the applicant.

(4) Despite clause (3) (b), an interjurisdictional carrier is not required to apply for annual registration certificates for the next registration year if, during the current registration year and the prior registration year, the interjurisdictional carrier is not and was not an interjurisdictional carrier described in clause (1) (a) or (b).

(5) An annual registration certificate shall be in Form 6.

(6) An annual registration certificate is valid only for the registration year for which it is issued and is not transferable between vehicles or between interjurisdictional carriers.

(7) An Ontario trip registration certificate shall be in Form 7.

(8) An Ontario trip registration is valid only as set out therein and not be transferable between vehicles.

(9) Any application required to be made under this section by an interjurisdictional carrier for a registration certificate with respect to an interjurisdictional vehicle may be made by the driver of that vehicle as agent of the interjurisdictional carrier.

(10) Each annual registration certificate issued by the Minister to an interjurisdictional carrier shall be affixed or caused to be affixed by the interjurisdictional carrier to the metal portion of the passenger door of the cab of an interjurisdictional vehicle for which the certificate was issued in a conspicuous and clearly visible place that is unobstructed by any other certificate, sign or other marking and shall not be defaced or altered except as authorized by this section.

(11) No person shall affix or cause to be affixed an annual registration certificate to any vehicle that is not an interjurisdictional vehicle for which the annual registration certificate has been issued by the Minister.

(12) Where the Minister has issued a new annual registration certificate for a current registration year to be affixed to an interjurisdictional vehicle that already bears an annual registration certificate previously issued for the current registration year, the interjurisdictional carrier operating the vehicle shall,

- (a) affix or cause to be affixed the new annual registration certificate over the annual registration certificate previously issued for the current registration year, if the previously issued annual registration certificate has been attached in the manner required under subsection (10); or
- (b) affix, or cause to be affixed, the new annual registration certificate in the manner required under subsection (10) and shall either remove from the vehicle all annual registration certificates previously issued for the current registration year or apply for and obtain from the Minister a cancellation sticker and affix the sticker over the previously issued annual registration certificates for the current registration year.

(13) No driver of an interjurisdictional vehicle shall drive the vehicle in Ontario unless,

- (a) an annual registration certificate for the current registration year has been issued by the Minister for the vehicle and has been affixed to the vehicle in the manner required under this section; or
- (b) the Minister has issued an Ontario trip registration certificate and the driver retains the certificate in the cab of the

vehicle throughout the trip for which the certificate was issued.

(14) Every interjurisdictional carrier shall forthwith notify the Minister in writing of all changes in the name or nature of the carrier's business and of any termination of business as an interjurisdictional carrier.

(15) Every interjurisdictional carrier who ceases to carry on business as an interjurisdictional carrier shall either remove all annual registration certificates for the current registration year previously affixed to vehicles operated by the carrier or apply for and obtain from the Minister and affix a cancellation sticker over each annual registration certificate for the current registration year previously affixed to vehicles operated by the carrier. O. Reg. 251/87, s. 2.

4. Every interjurisdictional carrier shall hold a registration certificate under section 3 of the Act except an interjurisdictional carrier who,

- (a) is using fuel purchased outside Ontario and brought into Ontario in the fuel tank of a motor vehicle passing through Ontario under the authority of a Class L permit or a Class Y licence, issued under the *Truck Transportation Act* and the regulations made thereunder; or
- (b) is a broker-driver. O. Reg. 772/82, s. 4.

5.—(1) Every collector shall install, maintain and repair or replace as necessary, at every dye-point operated by the collector, such equipment as is required for the mechanical and automatic injection of dye into fuel for the purpose of colouring fuel under all climatic conditions and, without limiting the generality of the foregoing, such equipment shall include,

- (a) a controlled electrical energy source activated by a mechanical switch to supply electrical energy to a pilot solenoid;
- (b) a pilot solenoid to operate a dye flow switching device;
- (c) a dye flow switching device consisting of a spool valve or four-way valve for directing the flow of dye to either end of a calibrated free piston cylinder;
- (d) a calibrated free piston cylinder or other measuring device capable of delivering a predetermined amount of dye into the fuel line;
- (e) a supply tank for the storage of dye, mounted horizontally or vertically and having,
 - (i) an eight inch inspection port that is easily accessible at the uppermost position on the tank, and
 - (ii) a dye line leading to a dye line outlet,

and that portion of the dye line that is within the supply tank shall be so constructed that the intake to the dye line is situated a minimum of six inches from the bottom of the tank;

- (f) as part of each supply tank referred to in clause (e),
 - (i) one or more pumps to dispense dye at a pressure in the dye line that exceeds the pressure in the fuel line by a minimum of 175 kilopascals, and
 - (ii) equipment that is both designed and operated with sufficient frequency to ensure the proper concentration of dye throughout the product contained in the supply tank at all times;
- (g) an in-line filter of adequate density to remove any undissolved matter installed between the supply tank described

in clause (e) and the switching device described in clause (c);

- (h) meters approved and certified to be accurate under the *Weights and Measures Act* (Canada) to record individual and cumulative total volumes of fuel dispensed and to activate a pulser, but a collector may dispense with such equipment where the dye-point is used exclusively for loading railway tank cars and is equipped with a product movement sensor that is approved by the Minister and that activates a pulser;
- (i) a pulser to control the electrical supply to the pilot solenoid described in clause (b) for the purpose of injecting preset volumes of fuel at a rate of not less than one pulse of dye for each 100 litres of fuel;
- (j) a relay assembly for directing electrical current to solenoid switches, enclosed in a box constructed to provide protection against tampering or explosion;
- (k) a fuel line solenoid valve, normally shut, through which all fuel delivered from the loading arm dedicated to the system of which the injection equipment is a part must flow;
- (l) a fuel line solenoid switch operating the fuel line solenoid valve described in clause (k);
- (m) a by-pass valve located on the dye line following the injection device described in clause (d) to facilitate measuring the quantity of dye injected;
- (n) a dye-flow monitor switch; and
- (o) a printing device that produces a loading document for each delivery showing the amount of fuel dispensed through the rack and loading arm. O. Reg. 772/82, s. 5 (1); O. Reg. 140/83, s. 2 (1); O. Reg. 381/83, s. 1; O. Reg. 185/85, s. 1.

(2) No design for a fuel delivery system and no placement or arrangement of components in the dye injection or fuel delivery system that, in the Minister's opinion, will permit the delivery of fuel that has not been coloured from the loading arm dedicated to the fuel delivery system shall be used in colouring fuel. O. Reg. 140/83, s. 2 (2).

(3) Every collector shall ensure that the equipment described in subsection (1) will stop the flow of fuel and the injection of dye automatically not more than thirty-five seconds after the occurrence of any malfunction.

(4) Despite subsection (3), where the printing device described in clause (1) (o) ceases to operate but the pulser in clause (1) (i) continues to operate, the loading document for each delivery may, when authorized by the Minister, be produced manually until the printing device is repaired and a loading document manually produced shall be certified accurate by the employee of the collector in charge of the bulk plant or terminal at the time of the failure of the printing device.

(5) Every collector shall allow any person authorized by the Minister access to every component of the dye injection system described in subsection (1) for the purpose of affixing seals provided by the Minister and, without limiting the generality of the foregoing, shall include,

- (a) every connection or coupling on the dye line located above ground; and
- (b) every valve, inlet or outlet in the dye injection system,

and, where any component is inaccessible or cannot otherwise be sealed, the collector shall enclose the component fully in a secure box or cover to which a seal may be affixed.

(6) Despite subsection (1), every collector who operates a facility for delivering fuel into a storage tank from a pipeline or a motor vessel and who, during such delivery, dyes fuel for the purpose of the Act and regulations, shall install, maintain and repair or replace as necessary, at every dye point operated by the collector to dye the fuel, such equipment as is required for the mechanical and automatic injection of dye into fuel for the purpose of colouring fuel under all climatic conditions and, without limiting the generality of the foregoing, the equipment shall include,

- (a) a flow switch on the main fuel transfer line to activate the dye injection system;
- (b) a dye injection system consisting of,
 - (i) a dye supply tank as described in clause 5 (1) (e),
 - (ii) two controlled volume positive displacement pumps, connected in parallel, installed in such a manner as to ensure that should one pump become inoperative, the other will be manually activated within such time as to ensure the proper injection of dye to retain the dye to fuel ratio prescribed in subsection 1 (3) and to dispense dye in the dye line at a pressure that exceeds the pressure in the fuel line by a minimum of 175 kilopascals,
 - (iii) a manually operated pump connected in parallel to the controlled volume displacement pumps described in subclause (ii) for use in the event of a malfunction in the controlled volume displacement pump,
 - (iv) an in-line filter or filters of adequate density to remove any undissolved matter installed between the dye supply tank and the pumps described in subclauses (ii) and (iii),
 - (v) a flow meter on the dye injection line to indicate individual and cumulative quantities of dye injected and to control the positive displacement pumps from a preset type batch register,
 - (vi) a flow switch on the dye injection line that will sound an alarm to indicate a malfunction in the dye injection system in the event there is no flow of dye,
 - (vii) a low level alarm switch in the dye supply tank set at a level to ensure that the usable quantity of dye in the tank is sufficient to colour the total volume of fuel expected during any delivery; and
- (c) dye injection system controls consisting of,
 - (i) a dye system electrical power supply switch to supply electrical energy to the control system,
 - (ii) an interlock connection between the flow switch described in clause (a), the flow meter preset batch register described in subclause (b) (v), and the positive displacement pumps described in subclause (b) (ii),
 - (iii) a key-lock timer that,
 - (A) is activated each time a signal is received from the flow switch referred to in subclause (b) (vi),
 - (B) is interlocked to the supply pump starter or starters on the loading arm or arms referred to in subsection (2),
 - (C) resets automatically to zero when the dye line flow returns to normal,

- (D) is so constructed that a malfunction in the dye injection system will initially sound the alarm referred to in subclause (b) (vi),
- (E) is so constructed that if the malfunction referred to in sub-subclause (D) is not remedied in a preset time, it will ensure that the proportion of dye in the fuel is as prescribed in subsection 1 (3) and it will stop the loading arm's supply pump or pumps.

(7) Every collector shall,

- (a) notify the Minister prior to each presetting of the timer prescribed in subclause (7) (c) (iii), and shall provide with such notification the name and position of the person presetting the timer and the reason for the presetting; and
- (b) shall allow any person authorized by the Minister to affix a seal provided by the Minister to every component of the dye injection system described in this subsection to which, in the opinion of the Minister, seals should be affixed. O. Reg. 772/82, s. 5 (3-8).

6.—(1) Where an importer intends to import and colour clear fuel in Ontario, the importer shall notify the Minister of the intention to import and colour the fuel at least forty-eight hours before the fuel is brought into Ontario. O. Reg. 104/86, s. 1, *part*.

(2) Imported clear fuel that is to be coloured in Ontario shall be coloured upon entry into Ontario at a point of entry for fuel permitted by Revenue Canada, Customs and Excise. O. Reg. 197/87, s. 1 (1), *part*; O. Reg. 74/90, s. 1 (1).

(3) At least twenty-four hours before imported clear fuel is to be coloured, the importer shall notify the Minister of,

- (a) the date and time of the importation into Ontario of the fuel that is to be coloured;
- (b) the location where the fuel is to be coloured; and
- (c) the quantity of fuel to be coloured. O. Reg. 104/86, s. 1, *part*.

(4) Imported clear fuel shall be coloured only by,

- (a) a person authorized by the Minister; or
- (b) where the importer wishes to colour the fuel, the importer under the supervision of a person authorized by the Minister. O. Reg. 197/87, s. 1 (1), *part*.

(5) The importer shall reimburse the Minister for all costs incurred by the Minister in colouring or supervising the colouration of the imported clear fuel.

(6) Imported clear fuel that is not coloured in accordance with this section shall be deemed to be clear fuel and the importer shall collect and remit the tax collectable and payable on such fuel under the Act. O. Reg. 104/86, s. 1, *part*.

7.—(1) Every collector shall,

- (a) store the dye used by the collector in a secure location and in accordance with the *Gasoline Handling Act* and the regulations thereunder;
- (b) colour fuel using the specifications for the proportion of dye to fuel in accordance with the Table; and
- (c) maintain records related to the receipt, inventors and use of dye. O. Reg. 772/82, s. 6 (1); O. Reg. 140/83, s. 3 (1).

(2) If a collector possesses or controls any coloured fuel in which

the proportion of dye to fuel is less than 170 parts per million, any person authorized to take samples of fuel under clause 18 (1) (e) of the Act may require the collector to colour that fuel either through the use of equipment described in subsection 5 (1) or manually as the person requiring the colouring directs and the collector shall colour the fuel in compliance with that direction under the supervision of the person making that direction. O. Reg. 1/89, s. 2.

8.—(1) For the purpose of subsections 8 (2) and 11 (5) of the Act, every importer or collector shall collect,

- (a) from every wholesaler or retailer to whom the importer or collector sells clear fuel, at the time of the sale, an amount as security equal to the tax imposed by the Act; and
- (b) from every purchaser to whom the importer or collector sells clear fuel, at the time of the sale, the tax payable under the Act.

(2) For the purposes of subsection 11 (6) of the Act, every importer who is a collector shall remit the tax and security collected under subsection (1) and the tax payable by the importer under subsection 4 (1) of the Act in accordance with subsection 10 (1).

(3) Every importer who is not a collector shall, on or before the fifteenth day of the month following the month in which the fuel was imported into or received in Ontario, deliver to the Minister a return in Form 9 together with,

- (a) the tax and security collectable and payable by the importer in respect of the sales of fuel under subsection (1); and
- (b) the tax payable by the importer under subsection 4 (1) of the Act.

(4) The return required under subsection (3) shall set out the quantity of coloured fuel and clear fuel imported into Ontario by the importer, the name and address of the person from whom the coloured fuel and the clear fuel was purchased and the date of each purchase.

(5) An importer who has complied with subsection 11 (7) of the Act may deduct from remittances required under subsection (3), all amounts paid under subsection 11 (8) of the Act in respect of fuel imported during the previous month.

(6) For the purposes of subsection 11 (9) of the Act, every importer who imports fuel into Ontario from outside Canada shall deliver a statement in Form 26 to the Minister, or to a person authorized by the Minister, at the time of entry into Ontario of each shipment of fuel.

(7) The statement required under subsection (6) shall set out the quantity of clear fuel and coloured fuel imported into Ontario, the name and address of the consignee and the name of the person transporting the fuel. O. Reg. 74/90, s. 2.

9.—(1) Every collector, importer, registered consumer and inter-jurisdictional carrier shall maintain a record of,

- (a) the quantities of fuel imported, purchased or otherwise received from suppliers or from his, her or its own production;
- (b) the quantity of dye received from the Minister;
- (c) the quantity of dye received from any other source;
- (d) the quantity of fuel dyed;
- (e) the quantity of dye used;
- (f) the quantities of clear fuel and of coloured fuel sold, delivered, exported or consumed including sales and deliveries

to other collectors, importers, registered consumers, inter-jurisdictional carriers and purchasers;

- (g) inventories, including inventories of clear fuel and coloured fuel, and an inventory of dye accounted for by supplier;
- (h) the quantity of clear fuel delivered, loaded or otherwise moved that has been used in the operation of auxiliary equipment of a motor vehicle and with respect to which a refund has been or may be claimed; and
- (i) the tax collectable and payable,

and shall retain all those records and all invoices, books of account and other documents related thereto. O. Reg. 772/82, s. 7 (1); O. Reg. 140/83, s. 4.

(2) A person required under subsection (1) to maintain records, invoices, books of account or other documents need not maintain records, invoices, books of account or other documents where,

- (a) the records, invoices, books of account or other documents are related to a period for which all returns required under the Act or the regulations have been filed and for which all taxes assessed under the Act or the regulations have been paid;
- (b) the records, invoices, books of account or other documents relate to a period for which there is no outstanding dispute between the person retaining the records, invoices, books of account or other documents and the Minister with regard to any tax payable or to be remitted by the person, and the time limit for filing a notice of objection to any assessment or statement of disallowance for the period has expired without the filing of such notice of objection;
- (c) no demand of the Minister for the production of the records, invoices, books of account or other documents has been made and remains unsatisfied;
- (d) no written notice from the Minister has been given requiring the retention of the records, invoices, books of account or other documents; and
- (e) a period of five years has expired since the end of the calendar year to which the records, invoices, books of account or other documents relate. O. Reg. 772/82, s. 7 (2), *revised*.

(3) Despite subsection (2), a person required to maintain records, invoices, books of account or other documents may dispose of those records, invoices, books of account or other documents if the person first obtains the Minister's authorization to do so.

(4) In addition to the records required to be kept under subsection (1), every interjurisdictional carrier shall also maintain a record of,

- (a) the number of kilometres travelled in each jurisdiction in which the carrier operates for each vehicle owned or operated by the carrier; and
- (b) the amount of tax paid to each jurisdiction with respect to purchases of fuel. O. Reg. 772/82, s. 7 (3, 4).

10.—(1) On or before the 25th day of each month, every collector shall deliver to the Minister a return in Form 8 with respect to the taxes collectable and payable by the collector in the immediately preceding calendar month and with the return the collector shall remit the tax collectable and the tax payable by the collector for the period referred to in the return. O. Reg. 772/82, s. 8 (1).

(2) On or before the 25th day following the last day of any calendar month in which a registered consumer purchased clear fuel without payment of tax as a result of the issuance of a fuel acquisition permit or at any other time as the Minister may require, the regis-

tered consumer shall deliver to the Minister a return in Form 10 with respect to the fuel so purchased and with the return the registered consumer shall remit the tax payable by the registered consumer under the Act that was not collected by the supplier. O. Reg. 772/82, s. 8 (3).

(3) Every interjurisdictional carrier described in clause (a) of the definition of "interjurisdictional carrier" in section 1 of the Act who is not a collector and to whom the Minister has issued a registration certificate, other than an Ontario trip registration certificate, shall deliver to the Minister a return in Form 11,

- (a) on or before the 25th day of January, April, July and October in each year with respect to the three immediately preceding complete calendar months;
- (b) where the Minister considers it advisable, on or before the twenty-fifth day of each month with respect to the immediately preceding calendar month or at such other time as the Minister may require; or
- (c) where the Minister considers it advisable, on or before the 25th day of July in each year with respect to the twelve-month period ending on the immediately preceding 30th day of June where the interjurisdictional carrier is not an interjurisdictional carrier referred to in subsection 3 (1).

(4) The interjurisdictional carrier shall remit the tax payable by the interjurisdictional carrier during the period to which the applicable return provided for under subsection (3) relates. O. Reg. 251/87, s. 4 (1).

(5) On or before the 25th day of each month, every interjurisdictional carrier who is not an interjurisdictional carrier referred to in subsection (3) to whom the Minister has issued a registration certificate, other than a registration certificate issued with respect to a single trip, shall deliver to the Minister a return in Form 12 with respect to the immediately preceding calendar month and with the return the interjurisdictional carrier shall remit the tax payable by the interjurisdictional carrier during the immediately preceding month.

(6) Every collector shall complete and deliver to the Minister, within 48 hours of the receipt by the collector of dye, a dye stock receipt notice in Form 13 with respect to the dye so received.

(7) Despite subsections (1), (2), (3) and (5), the Minister may at any time require a collector, importer, registered consumer or interjurisdictional carrier to make a return covering such period and including such information as the Minister may determine and the collector, importer, registered consumer or interjurisdictional carrier shall remit to the Treasurer with the return the tax collectable and payable by the collector, importer, registered consumer or interjurisdictional carrier, as the case may be, during such period.

(8) Despite subsections (1), (2), (3) and (5) the Minister may, upon application in writing, authorize a collector, registered consumer or interjurisdictional carrier, who closes his, her or its books at the end of periods that do not coincide with calendar months and that are no longer in duration than five weeks, to file the returns required by subsections (1), (2), (3) and (5) with respect to such periods.

(9) Where the Minister has, under subsection (8), authorized a collector, registered consumer or interjurisdictional carrier to file returns for periods shorter or longer in duration than calendar months, the collector, registered consumer or interjurisdictional carrier shall, on or before the 1st day of March in each year subsequent to the authorization, provide the Minister with a schedule of the precise dates upon which the collector, registered consumer or interjurisdictional carrier will end each such period during the calendar year or part thereof, as the case may be, commencing on the 1st day of April next following. O. Reg. 772/82, s. 8 (5-9).

(10) Despite subsections (1), (3) and (5), the Minister may require any collector or interjurisdictional carrier to file the returns

under the Act for periods longer than prescribed but not exceeding twelve months in duration. O. Reg. 251/87, s. 4 (2).

(11) Where the Minister has required a collector, registered consumer or interjurisdictional carrier to file returns for extended periods under subsection (10) or for periods longer or shorter than a calendar month under subsection (8), the collector, registered consumer or interjurisdictional carrier shall make the return required by subsection (8) or (10), as the case may be, in the form provided by the Minister within twenty-five days after the close of each such period, and shall remit to the Treasurer with the return the tax collectable and payable during the period covered by the return.

(12) Where the Minister has required a collector or interjurisdictional carrier to file returns for an extended period under subsection (10) and the collector or interjurisdictional carrier fails to file a return within the time prescribed in subsection (11), the collector or interjurisdictional carrier shall thereafter file a return in accordance with subsection (1), (2), (3), (5) or (8), as the case may be. O. Reg. 772/82, s. 8 (11, 12).

(13) An interjurisdictional carrier required under subsection (3) to deliver a return in Form 11 may record the distance travelled by the interjurisdictional carrier's fleet of interjurisdictional vehicles by,

- (a) recording the total distance travelled during the period to which the return relates on page 3 of Form 11; or
- (b) filing with the return a separate page 3 of Form 11 for each calendar month during the period to which the return relates, recording the distance travelled during the month. O. Reg. 251/87, s. 4 (3).

11.—(1) A notice of assessment referred to in section 13 of the Act shall be in Form 16.

(2) A statement of disallowance referred to in subsection 13 (7) of the Act shall be in Form 17.

(3) A seal referred to in subsection 25 (2) of the Act shall be in Form 18.

(4) A label referred to in subsection 25 (2) of the Act shall be in Form 19 or 20, as the case may be.

(5) A notice of objection referred to in section 14 of the Act shall be in Form 21.

(6) A notice of appeal referred to in section 14 of the Act shall be in Form 22. O. Reg. 772/82, s. 9.

12.—(1) An application for a single exemption certificate referred to in paragraphs 6 and 7 of section 7 of Regulation 465 of Revised Regulations of Ontario, 1990 shall be in Form 23 and the single exemption certificate so referred to shall be in Form 24.

(2) A statement of clear fuel receipts and deliveries shall be in Form 25.

(3) Where a person is seeking to purchase clear fuel from a collector exempt of tax for resale to a collector, the person shall apply for a single exemption certificate and where a single exemption certificate is issued and the person purchases and resells the clear fuel exempt of tax the person shall deliver the application for the single exemption certificate to the Minister so that the Minister receives the application within the forty-eight hours next following the departure from the terminal of the collector selling the fuel of the first portion of the fuel purchased.

(4) A person referred to in subsection (3) shall,

- (a) upon purchasing clear fuel exempt of tax, deliver to the collector who is selling the fuel, a copy of the single exemption certificate; and

- (b) return the statement of clear fuel receipts and deliveries in Form 25 within the time specified by the Minister in the statement. O. Reg. 267/84, s. 1.

13.—(1) Subject to section 21 of the Act, where it has been established to the satisfaction of the Minister that tax has been wrongly paid under the Act,

- (a) by any person in respect of any product that is excluded by regulation from the application of the Act;
- (b) by any person exempt by regulation from the payment of tax imposed by the Act;
- (c) on the use of fuel for any purpose other than generating power by internal combustion; or
- (d) on fuel the use of which is by regulation made under the Act exempt from tax imposed by the Act,

such tax may, upon application by the person who paid the tax, be refunded to the applicant.

(2) Subject to section 21 of the Act the Minister may, upon application from a purchaser, refund the tax paid on clear fuel purchased where the fuel has been used to operate auxiliary equipment of a motor vehicle, the power from which auxiliary equipment is not used or designed for the propulsion of a motor vehicle on the highway, and where the motor vehicle to which such equipment is auxiliary is not principally used by its owner or operator for the transportation of passengers, whether or not for hire, or for the pleasure or recreation of the owner or operator.

(3) Every purchaser who applies for a refund of tax under this section or under section 21 of the Act shall maintain in a form satisfactory to the Minister records that show,

- (a) all of such purchaser's acquisitions, inventories and uses of clear fuel and coloured fuel; and
- (b) a differentiation among uses of fuel sufficient to establish to the satisfaction of the Minister the entitlement of the applicant to the refund sought.

(4) Every invoice submitted in support of an application for a refund under this section or under section 21 of the Act shall show clearly, in addition to that information required to be shown on the invoice required under section 6 (1) of the Act, the date of payment of the tax, and no refund shall be paid in respect of any invoice or invoices on or in connection with which the applicant has misrepresented a material fact.

(5) Where an application for a refund under this section or under section 21 of the Act is supported in whole or in part by an invoice or invoices on or in connection with which the applicant has misrepresented a material fact, the amount of the refund that may be made by the Minister in respect of the application shall be reduced by the greater of \$5 or 200 per cent of the amount of the refund claimed through the use of the invoice or invoices on or in connection with which the misrepresentation is made.

(6) The use of fuel to propel railway equipment on rails where such equipment is operated in connection with and as part of a public transportation system is prescribed to be excluded from the application of section 21 of the Act.

(7) Subject to section 21 of the Act, where it has been established to the satisfaction of the Minister that tax has been overpaid under the Act by a broker-driver in respect of fuel purchased by the broker-driver to generate power in a motor vehicle of an interjurisdictional carrier who is the operator of such motor vehicle, the Minister may, subject to subsection (8) and upon application by the broker-driver, refund directly to the broker-driver the tax that, had such application for a refund not been received, would have been refunded to the operator of such motor vehicle.

(8) A refund referred to in subsection (7) shall be made only where the Minister has received sufficient information from both the operator and the broker-driver described in that subsection to enable the Minister to determine the correct amount of the refund to be made and no refund shall be made under that subsection in respect of money that, prior to receipt of the broker-driver's refund application, has been paid to the operator.

(9) A purchaser who applies for a refund of tax under this section or under section 21 of the Act shall, subject to subsection (10), complete and forward to the Minister an application for a refund of fuel tax in Form 14.

(10) An application made in accordance with subsection (9) may exclude the calculation of the amount of refund and, where excluded, such calculation shall be made by the Minister and a written statement thereof delivered to the person who applied for the refund.

(11) An Indian registered under section 5 of the *Indian Act* (Canada) who purchases clear fuel on a reserve for use by him or her or by another registered Indian at his or her expense may apply for a refund under this section.

(12) For the purposes of subsections (7) and (8), "operator" means,

- (a) the registered owner under the *Highway Traffic Act* of a motor vehicle or a fleet of motor vehicles or a person who would be so registered but for a reciprocal agreement between Ontario and another jurisdiction provided that such registered owner or other person is the holder of a licence or permit that is required under Regulation 1091 of Revised Regulations of Ontario, 1990 made under the *Truck Transportation Act*, but does not include a broker-driver;
- (b) the lessee of a motor vehicle who holds a valid registration certificate under section 3 of the Act and owns and operates as an interjurisdictional carrier one or more motor vehicles and includes the lessee of such motor vehicle or motor vehicles under any lease purchase agreement, but does not include a broker-driver. O. Reg. 772/82, s. 10.

14. An application under Regulation 466 of Revised Regulations of Ontario, 1990 shall be in Form 15. O. Reg. 608/88, s. 1.

TABLE
BLENDING CHART OF DYE

LITRES TO BE COLOURED	QUANTITY OF DYE TO BE USED (c.c.)	LITRES TO BE COLOURED	QUANTITY OF DYE TO BE USED (litres)
100	18	100,000	18
200	36	200,000	36
300	54	300,000	54
400	72	400,000	72
500	90	500,000	90
600	108	600,000	108
700	126	700,000	126
800	144	800,000	144
900	162	900,000	162
1,000	180	1,000,000	180
2,000	360	2,000,000	360
3,000	540	3,000,000	540
4,000	720	4,000,000	720
5,000	900	5,000,000	900
6,000	1,080	6,000,000	1,080
7,000	1,260	7,000,000	1,260
8,000	1,440	8,000,000	1,440
9,000	1,620	9,000,000	1,620
10,000	1,800	10,000,000	1,800
20,000	3,600	20,000,000	3,600
30,000	5,400	30,000,000	5,400
40,000	7,200	40,000,000	7,200
50,000	9,000	50,000,000	9,000
60,000	10,800	60,000,000	10,800
70,000	12,600	70,000,000	12,600
80,000	14,400	80,000,000	14,400
90,000	16,200	90,000,000	16,200

O. Reg. 1/89, s. 3.

Form 1

Fuel Tax Act



Ministry of Motor Fuels and Tobacco Tax Revenue Branch

Application For A Fuel Acquisition Permit - FT 809 Fuel Tax Act

1. Legal Name

2. Mailing Address Street Number and Name, Rural Route No., etc.

City or Town Province or State Postal or Zip Code

3. Business Name

Complete only if different from above. Business Address Street Number and Name, Rural Route No., etc. City or Town Province or State Postal or Zip Code

4. Type of Ownership (Place an 'X' in appropriate box.) Individual Proprietorship Partnership Corporation Other (specify)

5. Enter the full Name(s), Title(s), Address(es) and Phone Number(s) of authorized Signing Officers of the Corporation, or the Owner, or all Partners. Attach additional list if necessary.

Table with 3 columns: Name and Title, Address, Telephone Number

6. Location of Records 7. Name of Person Responsible for Records 8. (Area Code) Telephone No.

9. Do you operate diesel powered licensed vehicles in Ontario? Yes No
D

10. Were you a holder of a Registration Certificate under the Motor Vehicle Fuel Tax Act, being chapter 300 of the Revised Statutes of Ontario, 1980? Yes No

11. Is your application/return to be prepared and/or submitted by an agent on your behalf? Yes No

If Yes, state Registration Certificate Number(s)

12. Do you require fuel principally for consumption as a raw material ingredient in a manufacturing process? Yes No

If Yes, please describe fully the nature of the manufactured product that requires clear fuel as a raw material ingredient.

13. Do you operate railway equipment as part of a public transportation system on rails in Ontario? Yes No

14. Complete this item if answer to questions 12 or 13 is Yes. For each location where untaxed clear fuel will be used, please provide the following information. Attach additional list, if necessary.

Location Street Number and Name, City or Town	Storage Tank Size (Litres)	Describe use of fuel at each Location
1.		
2.		
3.		
4.		
5.		

15. Do you operate motor vessels in the commercial transportation of goods or passengers under the Canada Shipping Act? Yes No

Certification

I hereby certify that the statements on this application are true, correct and complete in every respect.

Name (please print)

Signature

Title

Date

Form 2
Formule 2

Fuel Tax Act
Loi de la taxe sur les carburants



Ministry of Revenue / Ministère du Revenu / Motor Fuels and Tobacco Tax Branch / Direction de la taxe sur les carburants et le tabac

FUEL ACQUISITION PERMIT—FT811
PERMIS D'ACHAT DE CARBURANT—FT811

Legal Name and Address/Nom et adresse

Account Number/Numéro de compte

Always refer to this Number when communicating with the Motor Fuels and Tobacco Tax Branch
Indiquer ce numéro dans votre correspondance avec la Direction de la taxe sur le tabac et les carburants

Effective Date/Date d'entrée en vigueur

This permit is not transferable and may be suspended or cancelled for contravention of the Act or Regulations.
Le présent permis n'est pas cessible et peut être suspendu ou annulé en cas d'infraction à la Loi ou aux règlements.

Minister of Revenue
Le ministre du Revenu

O. Reg. 775/84, s. 1, part, revised.
Règl. de l'Ont. 775/84, art. 1, en partie, révisé.

Form 3
Formule 3

Fuel Tax Act
Loi de la taxe sur les carburants



Ministry of Revenue / Ministère du Revenu / Motor Fuels and Tobacco Tax Branch / Direction de la taxe sur les carburants et le tabac

FUEL ACQUISITION PERMIT—FT810 (Single Event)
PERMIS D'ACHAT DE CARBURANT—FT810 (en une seule occasion)

Legal Name and Address/Nom et adresse

Account Number (if any)/Numéro de compte (s'il y a lieu)

Always refer to this Number when communicating with the Motor Fuels and Tobacco Tax Branch
Indiquer ce numéro dans votre correspondance avec la Direction de la taxe sur le tabac et les carburants

Effective Date Date d'entrée en vigueur	Valid until Valide jusqu'au
--	--------------------------------

This permit is not transferable and may be suspended or cancelled for contravention of the Act or Regulations.
Le présent permis n'est pas cessible et peut être suspendu ou annulé en cas d'infraction à la Loi ou aux règlements.

Minister of Revenue
Le ministre du Revenu

O. Reg. 775/84, s. 1, part, revised.
Règl. de l'Ont. 775/84, art. 1, en partie, révisé.

Form 4

Fuel Tax Act



Ministry of Revenue
Motor Fuels and Tobacco Tax Branch

APPLICATION FOR REGISTRATION—FT805
FOR INTERJURISDICTIONAL CARRIERS

Section A Basic Information

1. Legal Name		
2. Mailing Address (Street Number and Name, Rural Route No., etc)		
City or Town		Province or State
Postal or Zip Code		
3. Complete only if different from above.	Business Name	
	Business Address (Street Number and Name, Rural Route No., etc)	
	City or Town	Province or State
Postal or Zip Code		
4. Usual Commodities Carried		5. If Common Carriers, State Class(es)
6. Type of Ownership Sole Proprietorship <input type="checkbox"/> Corporation <input type="checkbox"/> Partnership <input type="checkbox"/> Other (Specify) <input type="checkbox"/>		If you prefer correspondence in French, please place an X in this box <input type="checkbox"/>
7. Enter the full Name(s), Title(s) Address(es) and Phone Number(s) of authorized Signing Officers of the Corporation, or the Owner, or all Partners. Attach additional list if necessary.		
Name and Title	Address	(Area Code) Telephone Number
8. If the business was purchased or taken over from another person, state name used by former owner (see guide)		
9. Location of Records	10. Name of Person Responsible for Records	11. (Area Code) Telephone Number
12. Is your return/application to be prepared and/or submitted by an agent on your behalf? No <input type="checkbox"/> Yes <input type="checkbox"/>		

Section B To be Completed by Operators of Motor Vehicles Travelling Interjurisdictionally.

13. State the number of diesel powered interjurisdictional vehicles for which you require decals. (List on reverse)	
14. a. Are you a private carrier? No <input type="checkbox"/> Yes <input type="checkbox"/> If Yes, complete 14(c), (d) and (e). If no, complete 14(b), (c), (d) and (e).	
b. Do you hold an Extra - Provincial Operating Licence issued by the Ontario Ministry of Transportation? No <input type="checkbox"/> Yes <input type="checkbox"/> If yes, provide number	
c. Are you the registered owner of at least one of the vehicles in item 13? No <input type="checkbox"/> Yes <input type="checkbox"/> If yes, please include with this application a photocopy of one of the ownership document(s) as issued by your registrar of motor vehicles.	
d. Are you the lessee (for a period of 31 or more consecutive days) of at least one of the vehicles in item 13? No <input type="checkbox"/> Yes <input type="checkbox"/>	
e. Do you employ owner-operator(s) for a term of 31 or more consecutive days who do not hold an Extra-Provincial Operating Licence issued by the Ontario Ministry of Transportation? No <input type="checkbox"/> Yes <input type="checkbox"/>	
If yes to questions 14(d) and/or (e), please provide a list of the names and addresses of the owners of the vehicle(s).	
15. Estimate the annual kilometres travelled by interjurisdictional vehicle(s) in Ontario.	16. Estimate the annual kilometres travelled by interjurisdictional vehicle(s) outside Ontario

Section C To be Completed by Operators of Railway Equipment or Motor Vessels.

17. Do you use fuel to propel railway equipment as part of a public transportation system in Ontario? If yes, state the number of diesel powered units.	No <input type="checkbox"/> Yes <input type="checkbox"/>
18. Do you operate motor vessels under The Canada Shipping Act for the purpose of commercial transportation of goods or passengers in Ontario? If yes, state the number of motor vessels.	No <input type="checkbox"/> Yes <input type="checkbox"/>

Certification

I hereby certify that the statements on this application are true, correct and complete in every respect.

Name (please print)	Signature	Title	Date

Please list the Vehicle Identification Number (Serial Number) for diesel powered interjurisdictional vehicles requiring decals. (Attach a separate list if necessary.) Indicate by a check mark those vehicles which are operated by owner-operators (broker-drivers). Do not include owner-operators holding Extra-Provincial Operating Licences issued by the Ontario Ministry of Transportation. They must apply for their own decals.

Vehicle Identification Number (Serial Number)	Owner Operator ✓	Vehicle Identification Number (Serial Number)	Owner Operator ✓	Vehicle Identification Number (Serial Number)	Owner Operator ✓
1.		4.		7.	
2.		5.		8.	
3.		6.		9.	

O. Reg. 251/87, s. 6, part.

Form 5

Fuel Tax Act



Ontario

Ministry of Revenue

Motor Fuels and Tobacco Tax Branch

Application for Registration Certificates (Decals) - FT805A For Interjurisdictional Carriers Fuel Tax Act

For the Period

Account Number

Please refer to the above number on all correspondence.

I hereby apply for _____ (Number of certificates/decals required)

Ontario Fuel Tax Registration Certificates (Decals) for the vehicles which are listed on the reverse, and certify that the applicant is:

(check (✓) appropriate box(es))

- the registered owner of the motor vehicle(s)
the lessee of the motor vehicle(s) for a period of 31 or more consecutive days
the operator of a fleet of motor vehicles where the owners of these vehicles do not hold an operating authority issued by the Ontario Highway Transport Board

Name (please print) Signature Title Date

IMPORTANT:

According to our records, you have not filed Fuel Tax Return(s) FT823 as required for the following Period(s).

Table with 2 columns: PERIOD (From, To) and PERIOD (From, To)

Unless this application and the return(s) listed above (if applicable) are received by your registration will be cancelled and registration certificates (decals) applied for will not be issued. You will be required to purchase an Ontario Trip Registration Certificate for each trip made into Ontario.

Director, Motor Fuels and Tobacco Tax Branch

Please list the Vehicle Identification Number (Serial Number) for inter-jurisdictional vehicles requiring registration certificates (decals). Indicate by a check mark those vehicles which are operated by owner-

operators (broker-drivers). Do not include owner-operators holding operating authorities issued by the Ontario Highway Transport Board. They must apply for their own registration certificates (decals).

Vehicle Identification No. (Serial No.)	Owner Operator ✓	Vehicle Identification No. (Serial No.)	Owner Operator ✓	Vehicle Identification No. (Serial No.)	Owner Operator ✓
1.		4.		7.	
2.		5.		8.	
3.		6.		9.	

Attach a separate list if necessary.

O. Reg. 251/87, s. 6, part.

Form 6

Fuel Tax Act

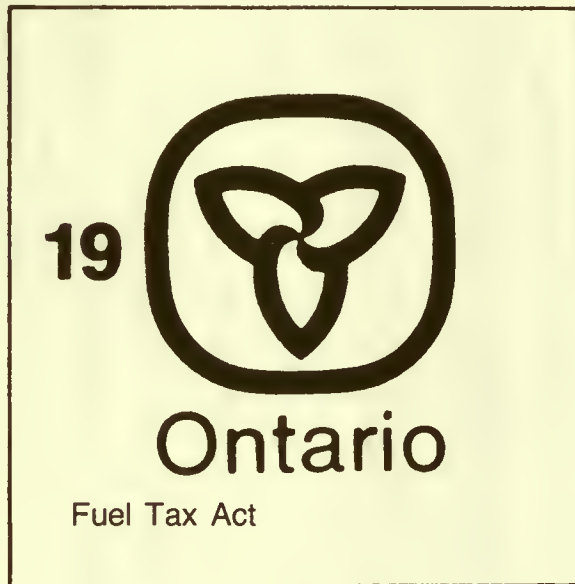

O. Reg. 251/87, s. 6, part.

Form 7
Formule 7

MINISTÈRE DES TRANSPORTS
MINISTRY OF TRANSPORTATION

MOTOR FUELS AND TOBACCO TAX BRANCH
DIRECTION DE LA TAXE SUR LE TABAC ET LES CARBURANTS

FT 832

CERTIFICATE NO. _____ NO DU CERTIFICAT _____
E

ONTARIO SINGLE TRIP REGISTRATION CHARGES
DROITS D'ENREGISTREMENT POUR LES TRAJETS OCCASIONNELS EN ONTARIO

Ministry of Transportation

Ministère des Transports

This certificate is issued under the authority of the Highway Traffic Act. Despite the issuance of this certificate and where applicable, the Truck Transportation Act, the Public Vehicles Act, and the Motor Vehicle Transport Act, 1987 (Canada) apply.

Le présent certificat est délivré sous le régime du Code de la route. Malgré sa délivrance et dans les cas pertinents, la Loi sur le camionnage, la Loi sur les véhicules de transport en commun et la Loi de 1987 sur les transports routiers (Canada) s'appliquent.

Ministry of Revenue

Ministère du Revenu

Under the Fuel Tax Act, the holder of this certificate is authorized to travel in Ontario between the points set out below only and by the route relating to the stated distance for a single trip.

Aux termes de la Loi de la taxe sur les carburants, le titulaire du présent certificat est autorisé à circuler en Ontario seulement entre les points indiqués ci-après en suivant l'itinéraire qui correspond à la distance déclarée.

Please complete all applicable sections.

Remplir les rubriques pertinentes.

This certificate, the fee for which must be paid at or before the time of issue, must be retained with the vehicle identified below until the trip has been completed.

Le présent certificat, pour lequel les droits doivent être acquittés lors de la délivrance ou antérieurement à cette date, doit être conservé dans le véhicule désigné ci-après jusqu'à la fin du trajet.

HOLDER NAME OF OWNER		TITULAIRE NOM DU PROPRIÉTAIRE		VEHICLE YEAR AND MAKE		ANNÉE ET MARQUE		LICENCE PLATE NO.		NO DE LA PLAQUE D'IMMATRICULATION		PROV. OR STATE		MINISTÈRE DU REVENU POINT D'ENTRÉE	
MAILING ADDRESS		ADRESSE POSTALE		VEH. SERIAL NO.		MTC		NO DE SÉRIE		MINISTRY OF REVENUE POINT OF ENTRY		MINISTÈRE DU REVENU POINT D'ENTRÉE		POINT DE DESTINATION	
CITY OR TOWN		CITÉ OU VILLE		PROV. OR STATE		PROV. OU ÉTAT		NO. AXLES TRUCK TRACTOR		NOMBRE D'ESSIEUX DU CAMION ROUTIER		POINT OF EXIT		POINT DE SORTIE	
POSTAL OR ZIP CODE		CODE POSTAL		TELEPHONE NO.		NO DE TÉLÉPHONE		NAME OF LESSEE		NOM DU LOCATAIRE					

MAILING ADDRESS

ADRESSE POSTALE

CITY OR TOWN CITÉ OU VILLE PROV. OR STATE PROV. OU ÉTAT

POSTAL OR ZIP CODE CODE POSTAL TELEPHONE NO. NO DE TÉLÉPHONE

SEND CERTIFICATE TO EXPÉDIER LE CERTIFICAT AU POINT D'ARRÊT

NAME OF STATION NO DU POSTE TELEPHONE NO. NO DE TÉLÉPHONE

DATE OF ISSUE DAY/JOUR MO./MO. YR./AN. TIME HEURE VALID UNTIL - DAY/JOUR MO./MO. YR./AN.

DATE DE LA DÉLIVRANCE OFFICE NO. / ISSUING OFFICER NOM DE L'AGENT QUI DÉLIVRE LE PERMIS VALIDE JUSQU'AU -

NO DU BUREAU

CHARGES FOR TOTAL TRIP

MTC TYPE (check one) MTC GENRE (cocher une case)

UNLADEN COMMERCIAL VEHICLE \$10 VÉHICULE UTILITAIRE SANS CHARGE

LADEN SINGLE COMMERCIAL VEHICLE \$60 VÉHICULE UTILITAIRE UNIQUE AVEC CHARGE

LADEN TRUCK/TRACTOR & TRAILER COMBINATION \$110 CAMION AVEC CHARGE/ENSEMBLE DE TRACTEUR ET REMORQUE

REVENUE kilomentres REVENUE kilomentres

TOTAL FUEL TAX/TAXE TOTALE SUR LES CARBURANTS

TOTAL MTC FEE/TOTAL DES DROITS MTC

TOTAL CHARGES TOTAL DES DROITS

LE MINISTRE DES TRANSPORTS, LE MINISTRE DU REVENUE,

MINISTER OF TRANSPORT MINISTER OF REVENUE

NOTE: TRUCK STOP OR STATION MUST COLLECT APPLICABLE FEES IN ADDITION TO ABOVE ONTARIO CHARGES.

REMARQUE: LES DROITS À VERSER AINSI QUE CEUX DE L'ONTARIO MENTIONNÉS CI-DESSUS DOIVENT ÊTRE PERÇUS AU POINT D'ARRÊT DU CAMION OU AU POSTE.

COLLECT ONTARIO CHARGES, PLUS APPLICABLE FEE. \$ À PERCEVOIR DROITS DE L'ONTARIO ET DROITS À VERSER.

COMPULSORY AUTOMOBILE INSURANCE ACT - CERTIFICATE OF INSURANCE
LOI SUR L'ASSURANCE-AUTOMOBILE OBLIGATOIRE - CERTIFICAT D'ASSURANCE

I HEREBY CERTIFY THAT THE MOTOR VEHICLE BEARING VEHICLE IDENTIFICATION NUMBER IS INSURED UNDER A CONTRACT OF AUTOMOBILE INSURANCE MADE WITH

J'ATTESTE PAR LA PRÉSENTE QUE LE VÉHICULE PORTANT NUMÉRO D'IDENTIFICATION EST ASSURÉ EN VERTU D'UN CONTRAT D'ASSURANCE-AUTOMOBILE PASSÉ AVEC

NAME OF INSURANCE COMPANY POLICY NUMBER
RAISON SOCIALE DE LA NO DE LA POLICE
COMPAGNIE D'ASSURANCE

SIGNATURE DATE

Form 8

Fuel Tax Act



Ministry of Revenue
Motor Fuels and Tobacco Tax Branch

Fuel Tax Return - FT 812

Fuel Tax Act

Important: Shaded areas for Ministry use only.

Name of Collector		Account Number
Address	Period Covered	From To

Fuel Handled

	Clear Fuel (Litres)	Coloured Fuel (Litres)
1. Opening inventory		
2. Received from own refinery in Ontario		
3. Own fuel coloured by other Collectors	()	
4. Own fuel coloured by own facilities in Ontario	()	
5. Own fuel imported into Ontario (See page 4, Sch. 3 and/or Sch. 3a)		
6. Imported into Ontario from other companies (See page 4, Sch. 3 and/or Sch. 3a)		
7. Purchased/received from other Collectors in Ontario (See page 4, Sch. 4)		
8. Purchased from non-collectors in Ontario		
Total to be accounted for		
9. Exported from Ontario (See page 4, Sch. 5 and/or Sch. 5a)		
10. Sold/delivered to other Collectors in Ontario (See page 4, Sch. 6)		
11. Sold to Fuel Acquisition Permit or Single Exemption Cart. holders (See page 4, Sch. 7)		
12. Other sales and own consumption		
13. Total Deliveries/Issues (Total of line 9, 10, 11 and 12)		
14. Rebranded to product(s) excluded under the Act		
15. Losses/gains - temperature, evaporation and handling		
16. Losses - accident, contamination and other major losses (from page 3)		
17. Closing inventory		
Total accounted for (lines 13, 14, 16, 16 & 17)		

Calculation of Compensation

	Coloured Fuel (Litres)
18. Total deliveries and issues of coloured fuel (from line 13)	
Deduct - Coloured fuel received from other companies	
19. Imported into Ontario from other companies (from line 6)	
20. Purchased/received from other Collectors in Ontario (from line 7)	
21. Purchased/received from non-Collectors (from line 8)	
22. Own fuel coloured by other Collectors (Custom dyeing, from line 3)	
Total fuel delivered and coloured by own facilities in and outside Ontario	
23. Add - Fuel coloured for other Collectors (Custom dyeing)	
Deduct - 24. Coloured fuel exported outside Ontario	
25. Coloured fuel involved in contamination and/or spills	
26. Fuel coloured by the Ministry	
27. Coloured fuel shipped to terminals of other Collectors	
28. Coloured fuel sold to Registered Consumers under Fuel Acquisition Permit	
29. Total coloured fuel on which compensation is to be claimed	

Tax Calculation

	Litres	Tax Rates	Amount
30. Sales and own consumption (at current tax rate)			\$ -
31. Sales and own consumption (at previous tax rate)			-
32. Sales and own consumption (at other tax rate)			-
33. Total			-
Deduct - 34. Compensation (from line 29)			-
35. Refund claimed on Ontario tax paid clear fuel used in unlicensed equipment			-
36. Tax paid on Ontario fuel purchases			-
37. Other adjustments (Please specify):		<input type="checkbox"/> Plus <input type="checkbox"/> Minus	-
Total Due			-

Certification: I certify that the financial and other statements of information included herein or attached hereto are in agreement with the books of the collector and exhibit truly, correctly and completely all information for the period covered by this return.

Name (please print) _____ Title _____

Signature _____ Date _____

P

E

Schedule 1 - Dye Stock and Usage Report

Authorized Dye Points: Authorization Numbers		1	2	3	4	5
Method of colouring and applicable period	Automatic Injection	From:	From:	From:	From:	From:
		To:	To:	To:	To:	To:
	Authorized Hand Dyeing	From:	From:	From:	From:	From:
		To:	To:	To:	To:	To:
Litres of dye handled (to 3 decimals)	1. Physical opening inventory					
	2. Dye received					
	3. Transferred in/out					
	Total to be accounted for (lines 1, 2 & 3)					
	4. Dye used (total of lines 1,2,3 minus total of lines 5,6,7)					
	5. Known losses					
	6. Stock in-transit					
Litres of fuel coloured	7. Physical closing inventory					
	Total accounted for (lines 4, 5, 6 & 7)					
	8. Fuel coloured for own requirements					
For Branch use only	9. Fuel coloured for other Collectors (custom dyeing)					
	Total fuel coloured (lines 8 & 9)					
	10. Dye required					
For Branch use only	11. Dye used					
	12. Difference					
	13. Difference in percentage					
	Remarks					

Schedule 2 - Details of Major Losses, Contaminations, etc. of Fuel

Name of Collector	Account No.	Period covered

Particulars	Date	Litres of clear fuel	Litres of coloured fuel

Supporting Schedules to be provided with Return FT812

Schedule 3 - Details of Clear Fuel Imports

If you have imported clear fuel into Ontario during the reporting period, complete form " FT Schedule 3 ".

Schedule 3a - Details of Coloured Fuel Imports

If you have imported coloured fuel into Ontario during the reporting period, complete form " FT Schedule 3a ".

Schedule 4 - Details of Fuel received from Ontario Collectors.

Providing for receipts, including loans and exchanges, aggregated by collector, the following details:

- i) the name of the Collector or Supplier,
- ii) the receiving point,
- iii) the quantity of clear fuel received,
- iv) the quantity of coloured fuel received

Note: Total quantities to be entered on line 7 form FT812 (page 1).

Schedule 5 - Details of Clear Fuel Exports

If you have exported clear fuel outside Ontario during the reporting period, complete form " FT Schedule 5 ".

Schedule 5a - Details of Coloured Fuel Exports

If you have exported coloured fuel outside Ontario, complete form " FT Schedule 5a ".

Schedule 6 - Details of Fuel Sold / Delivered to Other Collectors in Ontario

Providing for deliveries, including loans and exchanges, aggregated by collector, the following details:

- i) the name of the Collector to whom the fuel was delivered,
- ii) the point of delivery,
- iii) the quantity of clear fuel delivered,
- iv) the quantity of coloured fuel delivered

Note: Total quantities to be entered on line 10 form FT812 (page 1).

Schedule 7 - Details of Untaxed Sales of Clear Fuel

Providing for each delivery of untaxed clear fuel to registered consumers, the following details:

- i) the name and address of purchaser,
- ii) the Fuel Acquisition Permit Number or Single Exemption Certificate Number,
- iii) the Invoice Number,
- iv) the Invoice Date, and
- v) the quantity of clear fuel sold

Note: Total quantity to be entered on line 11 form FT812 (page 1).

Note: There are no prescribed forms for Schedules 4, 6 and 7.

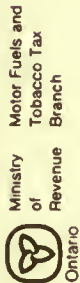

FT Schedule 3 Details of Clear Fuel Imports

For the month of

Name of Collector / Importer Importer's Federal Sales Tax Number **▲**
 Account Number Importer's Federal Excise Tax Number **▲**

Submit in **DUPLICATE**, use separate Schedule for EACH Province or State.

Province or State from which fuel was imported (i.e. Province or State to which fuel export was declared) **▲**

Product Code (Note 1)	From Whom Purchased Supplier's Name and Full Address		Address of Delivery Point		Point of Title Transfer	Mode of Transportation	Name of Carrier	Supplier's Invoice		Point of Entry	Cargo Control Number (Note 2)	Quantity (Litres) (Note 3)
	Date	Number	Date	Number								
State / Province Total ▲												

Note:
 1. PRODUCT CODE: Diesel motor fuel = 15; Furnace fuel = 14; Stove Oil = 13; Kerosene = 12; Other middle distillate fuels = 99.
 2. CARGO CONTROL #: As shown on Revenue Canada's Customs Cargo Document. Not required for product shipped by pipeline.
 3. CONVERSION FACTORS: 1 Imperial gallon = 4.54609 Litres; 1 US gallon = 3.785412 Litres.

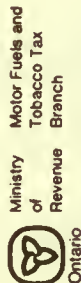

FT Schedule 3a Details of Coloured Fuel Imports

For the month of

Name of Collector / Importer Importer's Federal Sales Tax Number **▲**
 Account Number Importer's Federal Excise Tax Number **▲**

Submit in **DUPLICATE**, use separate Schedule for EACH Province or State.

Province or State from which fuel was imported (i.e. Province or State to which fuel export was declared) **▲**

Product Code (Note 1)	From Whom Purchased Supplier's Name and Full Address		Address of Delivery Point		Point of Title Transfer	Mode of Transportation	Name of Carrier	Supplier's Invoice		Point of Entry	Location Where Dyes	Cargo Control Number (Note 2)	Quantity (Litres) (Note 3)
	Date	Number	Date	Number									
State / Province Total ▲													

Note:
 1. PRODUCT CODE: Diesel motor fuel = 15; Furnace fuel = 14; Stove Oil = 13; Kerosene = 12; Other middle distillate fuels = 99.
 2. CARGO CONTROL #: As shown on Revenue Canada's Customs Cargo Document. Not required for product shipped by pipeline.
 3. CONVERSION FACTORS: 1 Imperial gallon = 4.54609 Litres; 1 US gallon = 3.785412 Litres.

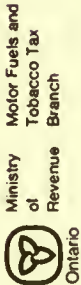

Ministry of Revenue Ontario

Motor Fuels and Tobacco Tax Revenue Branch

For the month of

Submit in DUPLICATE, use separate Schedule for EACH Province or State

Name of Collector / Refund Applicant: _____ Account Number /GTR Number: _____

Province or State to which fuel was exported from Ontario (i.e. Province or State to which fuel import was declared) ▶

Product Code (REQ)	Customer in jurisdiction of delivery	Address of Delivery Point	Customer's Fuel Tax Permit Lic. #	Point of Title Transfer	Sale Invoice		Mode of Transportation	Name of Carrier	Point of Exit	Date of Exit	Quantity (Litres) (Note 2)
					Date	Number					
State / Province Total ▶											

Note:
 1. PRODUCT CODE: Diesel motor fuel = 15; Furnace fuel = 14; Stove oil = 13; Kerosene = 12; Other middle distillate fuels = 99
 2. CONVERSION FACTORS: 1 imperial gallon = 4.54609 Litres; 1 US gallon = 3.785412 Litres.

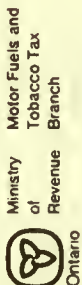

Ministry of Revenue Ontario

Motor Fuels and Tobacco Tax Revenue Branch

For the month of

Submit in DUPLICATE, use separate Schedule for EACH Province or State

Name of Collector / Refund Applicant: _____ Account Number /GTR Number: _____

Province or State to which fuel was exported from Ontario (i.e. Province or State to which fuel import was declared) ▶

Product Code (REQ)	Customer in jurisdiction of delivery	Address of Delivery Point	Customer's Fuel Tax Permit Lic. #	Point of Title Transfer	Sale Invoice		Mode of Transportation	Name of Carrier	Point of Exit	Date of Exit	Quantity (Litres) (Note 2)
					Date	Number					
State / Province Total ▶											

Note:
 1. PRODUCT CODE: Diesel motor fuel = 15; Furnace fuel = 14; Stove oil = 13; Kerosene = 12; Other middle distillate fuels = 99.
 2. CONVERSION FACTORS: 1 imperial gallon = 4.54609 Litres; 1 US gallon = 3.785412 Litres.

Form 9



Ministry of Revenue
Motor Fuels and Tobacco Tax Branch

Statement of Fuel Imports - FT 815
Fuel Tax Act

This form is to be completed by a fuel importer who is not a Collector under the Act.
IMPORTANT: Shaded areas are for Ministry use only.

Legal Name and Address

Account Number
06 11
Voucher Number FUI
12 18 17
Month of Importation
18 25

Instructions

- Statement of Fuel Imports must be delivered to the Ministry of Revenue, together with payment, on or before the 15th day of the month following the month in which the fuel was imported into or received in Ontario.
- Submit this Statement of Fuel Imports together with your cheque or money order made payable to the TREASURER OF ONTARIO at the address shown above.
- FT Schedules 3 or 3a must accompany this statement.

AS PER FT SCHEDULES 3 and 3a	
Province / State	Litres Imported
(1) Total	

Ontario Tax Rate A
X [] = \$ []

To be completed ONLY if product was imported from Quebec
(Complete either (2) or (3), NOT BOTH)

- If Quebec tax rate is higher than Ontario's, complete (2)

(2) Quebec-tax-paid fuel imported into Ontario
Litres [] X Ontario Tax Rate [] = \$ [] B

- If Quebec tax rate is lower than Ontario's, complete (3)

(3) Quebec-tax-paid fuel imported into Ontario
Litres [] X Quebec Tax Rate [] = \$ [] C

(4) Tax Due (Box A minus Box B or C as applicable) D
\$ []

(5) Fuel coloured by authorized personnel
Litres (as per FT Sch. 3a) [] X Ontario Tax Rate [] = \$ [] E

(6) Amount of tax/security remitted with respect to the imports declared in this return F
\$ []

(7) Amount Due (Box D minus Boxes E & F)
\$ []

Certification: I hereby certify that the financial and other statements of information included herein or attached hereto are in agreement with the books of the importer and exhibit truly, correctly and completely all information for the period covered by this Return.

Name (please print) _____ Title _____
Signature _____ Date _____

Date received
41 46
P 8
E 47 57
88 88

Formule 9



Ministère Direction de la taxe
du sur les carburants
Revenu et le tabac

Ontario

Déclaration d'importation de
carburant - FT 815
Loi de la taxe sur les carburants

La présente déclaration doit être remplie par tout importateur de carburant qui n'est pas un percepteur aux termes de la Loi.
IMPORTANT. Les parties ombrées sont réservées au ministère.

Nom et adresse

Numéro de compte
06 11
Numéro de reçu FUI
12 16 17
Mise d'importation
18 23

Instructions

- La Déclaration d'importation de carburant doit parvenir au ministère du Revenu, accompagnée du paiement, au plus tard le 15 du mois qui suit le mois pendant lequel le carburant a été importé ou reçu en Ontario.
- Envoyer la Déclaration d'importation de carburant, accompagnée d'un chèque ou d'un mandat établi à l'ordre du TRÉSORIER DE L'ONTARIO, à l'adresse indiquée ci-dessus.
- L'annexe FT3 ou FT3a doit être jointe à cette déclaration.

DONNÉES À REPORTER DES ANNEXES FT3 ET FT3a	
Province / État	Quantité importée (litres)
(1) Total	

Taxe de l'Ontario A
X [] = [] \$

À remplir SEULEMENT si le produit a été importé du Québec (remplir (2) ou (3) et NON LES DEUX).

- Si la taxe du Québec est plus élevée que celle de l'Ontario, remplir (2).
- (2) Carburant importé en Ontario pour lequel le taxe du Québec a été payée
Litres [] X Taxe de l'Ontario [] = [] B \$
- Si la taxe du Québec est moins élevée que celle de l'Ontario, remplir (3).
- (3) Carburant importé en Ontario pour lequel la taxe du Québec a été payée
Litres [] X Taxe du Québec [] = [] C \$

(4) Taxe due (Case A moins case B ou C, selon le cas) [] D \$

(5) Carburant coloré par ou personnel autorisé Litres (d'après l'annexe FT3a) [] X Taxe de l'Ontario [] [] E \$

(6) Montant de la taxe/de la garantie versée à l'égard des importations déclarées sur la présente formule [] F \$

(7) Montant dû (Case D moins case E & F) [] \$

Attestation: J'atteste, par la présente, que les relevés financiers et autres renseignements contenus dans la présente ou joints à celle-ci concordent avec les livres de l'importateur et présentés de manière fidèle, exacte et complète, les renseignements se rapportant à la période visée par la présente déclaration.

.....
Nom (en caractères d'imprimerie) Titre

.....
Signature Date

Reçu le

41 46

P

47 57

E

58 64

Form 10

Fuel Tax Act



Ministry of Revenue
Motor Fuels and Tobacco Tax Branch

Statement of Clear Fuel Receipts - FT 814
Fuel Tax Act

IMPORTANT: This form is to be completed by holders of a Fuel Acquisition Permit. Shaded areas are for Ministry use only.

This Return covers the period
From _____ To _____

Return Due Date ▶ _____

Legal Name and Address

Account Number
06 _____ 11

Voucher Number _____ FUJ
12 _____ 16 17

From _____
18 _____ 23

To _____
24 _____ 29

Name of Supplier	Invoice Number	Invoice Date	Litres of clear fuel received
Total			

Certification: I certify that the financial and other statements of information included herein or attached hereto are in agreement with the books of the registered consumer, and exhibit truly, correctly and completely all information for the period covered by this Return.

Name (please print) _____ Title _____
Signature _____ Date _____

Date received

30 _____ 35

Form 11

Fuel Tax Act



Ministry of Revenue Motor Fuels and Tobacco Tax Branch

Fuel Tax Return - FT 823 (Interjurisdictional Carriers) Fuel Tax Act

This Return covers the period From To

Return Due Date

IMPORTANT: Shaded areas are for Ministry use only.

Legal Name and Address

Account Number

Voucher Number FUJ

From

To

IMPORTANT: This return must be filed whether or not you travelled interjurisdictionally during the period. Please read the guide before completing this return. Complete the Ontario Fuel Purchase Report on the reverse before completing the face of the return.

For Interjurisdictional Vehicles ONLY:

1 Total kilometres travelled everywhere km
2 Total kilometres travelled in Ontario km
3 Total kilometres travelled in Canadian jurisdictions km
4 Total quantity of fuel issued everywhere litres
5 Average kilometres per litre km/litre

6 Quantity of fuel used by interjurisdictional vehicles in Ontario Litres Tax per litre Dollars Cents
7 Refund claimed on Ontario tax paid fuel used in unlicensed or auxiliary equipment
8 Ontario tax paid on fuel issued only to interjurisdictional vehicles

9 Other adjustments (check one) Plus or Minus

10 NET TAX DUE (check one) or Credit

11. Accumulated credit from previous Return

12 BALANCE: (check one) Cheque Attached or Credit

Certification: I certify that the financial and other statements of information included herein or attached hereto are in agreement with the books of the interjurisdictional carrier and exhibit truly, correctly and completely all information for the period covered by the Return. Name (please print) Title Signature Date

Date received
P \$
E \$

Ontario Fuel Purchase Report
Fuel Tax Act

Attach a separate list if necessary.

ONTARIO SUPPLIER Name & Place	Invoice Number	Invoice Date	Type of Purchase		
			Bulk	Keylock	On Road
			L	L	L
			L	L	L
			L	L	L
			L	L	L
Sub Totals			L	L	L
Total (Ontario Purchases)			L		

- | | |
|--|--|
| 1. Issues of Ontario tax paid clear fuel to unlicensed equipment . . . _____ L | 4. Issues of Ontario tax paid clear fuel to interjurisdictional vehicles _____ L |
| 2. Tax amount per litre X _____ | 5. Tax amount per litre X _____ |
| 3. Ontario fuel tax credit \$ _____
(Enter on line 7, FT 823) | 6. Ontario fuel tax credit \$ _____
(Enter on line 8, FT 823) |

Complete next section only if applicable

Explanation of Other Adjustments from line 9 of FT 823

**Uniform Reporting of Distance Record:
Information Form for Reporting Interjurisdictional Travel - URD
(KILOMETRES)**

See reverse side for instructions

To be completed by all carriers registered for interprovincial proration of Fuel Tax, Registration fees (CAVR) and/or Sales Tax (ISTA).

Ministry of Revenue Ontario
Motor Fuels and Tobacco Tax Branch

Carrier	Mailing Address										Phone		Month or Period		Authorized Signature			
	Jurisdiction	Province	Nfld	N.S.	P.E.I.	N.B.	Que.	Ont.	Man.	Sask.	Alta.	B.C.	Yukon	N.W.T.	Total Canada	Total U.S.A.	Total Distance	
1. CAVR Cat "A" Fuel #																		
Fuel #																		
Fuel #																		
Fuel #																		
Fuel #																		
Fuel #																		
SUB TOTAL																		
2 Other Interjurisdictional CAVR Category "B" Multi-plated Can units Base plated & U.S.A																		
3. TOTAL Interjurisdictional																		
4. For Fuel Reports Diesel units Propane units Gasoline units																		
5. For ISTA Reports Interjurisdictional Intrajurisdictional TOTAL Inter & Intra																		

O. Reg. 251/87, s. 6, part.

Form 12

Fuel Tax Act



Ministry of Revenue
Motor Fuels and Tobacco Tax Branch

Fuel Tax Return - FT 826⁰¹/₀₅
(Railways and Motor Vessels)

Fuel Tax Act

This Return covers the period
From _____ To _____

Return Due Date _____

Legal Name and Address

Account Number
04 _____ 11

Voucher Number FUI
12 _____ 16 17

From
18 _____ 23

To
24 _____ 29

IMPORTANT This Return must be completed by holders of a Registration Certificate issued to interjurisdictional carriers who operate railway equipment on rails and/or motor vessels.
Shaded areas are for Ministry use only.

	Litres	Tax per litre	Dollars	Cents
1. Fuel used in railway equipment on rails in Ontario	_____	€ _____	_____	_____
2. Fuel used in licensed vehicles and/or issued for other taxable purposes	_____	€ _____	_____	_____
3. Fuel issued to motor vessels in Ontario	_____	_____	_____	_____
4. Tax due (line 1 plus line 2)	_____	_____	_____	_____
Deduct - 5. Ontario tax paid on clear fuel used in railway equipment on rails and/or in motor vessels (from line 13, Ontario Fuel Purchase Report)	_____	_____	_____	_____
Deduct - 6. Refunds claimed on Ontario tax paid clear fuel used in unlicensed/auxiliary equipment (from line 10, Ontario Fuel Purchase Report)	_____	_____	_____	_____
7. Other adjustments (please explain) _____	_____	_____	_____	_____
9. Nat Tax due	_____	_____	30 _____	40 _____

Certification: I certify that the financial and other statements of information included herein or attached hereto are in agreement with the books of the interjurisdictional carrier, and exhibit truly, correctly and completely all information for the period covered by this Return

Name (please print) _____ Title _____

Signature _____ Date _____

Date received _____

41 _____ 46

P \$ _____

E \$ 47 _____ 57

58 _____ 68



Ministry of Revenue
Motor Fuels and Tobacco Tax Branch
Ontario

**Interjurisdictional Transport
Information IF-102**
Fuel Tax Act

Legal Name and Address	Account Number	Period Covered
------------------------	----------------	----------------

*This form is to be completed by Registered Interjurisdictional Carriers who operate railway equipment on rails.
This form must accompany Form FT826.*

	Fuel used in Railway Equipment on Rails (Litres)
1. Newfoundland	
2. Nova Scotia	
3. Prince Edward Island	
4. New Brunswick	
5. Quebec	
6. Ontario	
7. Manitoba	
8. Saskatchewan	
9. Alberta	
10. British Columbia	
11. Yukon	
12. Northwest Territories	
13. U.S.A.	
14. Total	

Ontario Fuel Purchase Report
Fuel Tax Act

Legal Name	Account No.	Period covered
------------	-------------	----------------

Ontario Tax Paid Fuel

	A Previous Tax Rate	B Current Tax Rate
1. Opening inventory	L	L
2. Ontario tax paid purchases	L	L
3. Less: Closing inventory		() L
4. Fuel available	L	L

Calculation of Ontario Fuel Tax Credit

Interjurisdictional Vehicles

5. Ontario tax paid fuel issued to interjurisdictional vehicles (on road end from bulk storage)	L	L
6. Applicable tax amount per litre	¢/L	¢/L
7. Tax credit (line 5 X line 6 for each column, and enter the total on line 8, FT823)	\$	\$

Unlicensed Equipment

8. Ontario tax paid fuel issued to unlicensed/auxiliary equipment	L	L
9. Applicable tax amount per litre	¢/L	¢/L
10. Tax credit (line 8 X line 9 for each column, and enter the total on line 7 FT823, or line 6 FT826)	\$	\$

Motor Vessels and Railways

11. Ontario tax paid fuel issued to motor vessels and railway equipment	L	L
12. Applicable tax amount per litre	¢/L	¢/L
13. Tax credit (line 11 X line 12 for each column, and enter the total on line 5 FT826)	\$	\$

Form 13

Fuel Tax Act



Ministry of Revenue
Motor Fuels and Tobacco Tax Branch

Dye Stock Receipt Notice - FT 816

IMPORTANT: Complete this form for each receipt of dye.
Forward to the Motor Fuels and Tobacco Tax Branch within 48 hours of receiving the dye.

Name of Collector				Account Number	
Address where dye received	Street Number and Name	City or Town	Province	Postal Code	
Bill of Lading Reference					

Quantity of dye received — Number of barrels _____ x 185 litres

Certification

I hereby certify that I have received on _____, 19____ the quantity of dye indicated above.

Name (please print) Signature Title Date

O. Reg. 775/84, s. 1, part.

Form 14

Fuel Tax Act



Ministry of Revenue Motor Fuels and Tobacco Tax Branch

Application for Refund of Fuel Tax - FT 850

This form is not for completion or use by a collector under the Act

Important: Shaded areas are for Ministry Use Only.

Is this your first claim? Yes No

GTR Number

Large empty rectangular box for additional information.

Table with columns: Trans Code, Name, Act, Type, Class, County, Sub Code, Inmate.

A Complete Name and Address Section if above information is incorrect or if label is missing.

Form A: Name of Proprietor or Business Name, Address, Postal Code.

B County or District in which business is operated

Form B: Farm Claimant only (Lot No, Concession No, Township)

C Describe nature of business operated and refundable use of diesel fuel.

Form C: Description of business and equipment.

D Do you operate licensed diesel vehicles? Do you fuel licensed diesel vehicles from your own storage?

Form D: CLAIM PERIOD (Date of first Invoice, Date of last Invoice)

Important: Complete only Line F or Line G. Do not complete both.

Form E: Declaration of Diesel or Clear Fuel Purchases and Refund Claimed; Declaration of Clear Fuel Purchases and Exports.

Note: 1. If the worksheet in the guide is not completed, your refund will be calculated on your behalf... 2. To calculate your refund, the worksheet in the guide should be completed and attached.

Form F: Refund Claimed (Amount and Code)

H CERTIFICATION

- 1. I HEREBY CERTIFY that all clear fuel in respect of which this refund is claimed has been taxed under the Fuel Tax Act... 2. I FURTHER CERTIFY that the clear fuel covered by this claim was consumed or used in one or more of the following ways... 3. I FURTHER CERTIFY that the clear fuel relating to this claim for rebete of tax was NOT used in a motor vehicle operated for personal or recreational purposes. 4. I FURTHER CERTIFY that the information supplied by me in this application and its supporting documents is true, complete and correct.

Form G: Signature, Title, Telephone Number & Area Code

Warning: Fraudulent claims submitted may result in charges being laid under the Criminal Code.

Form H: Summary table with columns: Code, Litres, Amount.

Form 15

Fuel Tax Act



Ministry of Revenue Motor Fuels and Tobacco Tax Branch

Application for Fuel Tax Refund - FT 840

Type of Claim [] Bad Debt Claim [] Loss of Product Claim [] Contaminated Product Claim
Type of Business [] Collector [] Importer [] Wholesaler [] Retailer

Applicant's Name Gasoline Handling License Number
Address

A - Bad Debt Claim

Debtor's Legal Name
Address

If in Bankruptcy, state name and address of the trustee and date of assignment
Trustee's Name and Address

Date of Assignment

List in chronological order details of all unpaid invoices on which refund of the tax is claimed. (Please attach invoices) Use separate listing if space is insufficient.

Table with 5 columns: Date of Invoice, Invoice Number, Number of Litres, Tax Rate, Tax Amount Claimed

State the Taxation Year in which the Bad Debt was written off under the Income Tax Act (Canada) 19 Total Tax Claimed \$

B - Loss of Product / Contaminated Product Claim
Table with 3 columns: Number of Litres, Tax Rate, Amount of Tax
Includes checkboxes for Fire, Vehicle Accident, Other, Theft, Contamination

Certification
I hereby certify that the statements and information included herein or attached hereto are true, complete and accurate in every respect.
Authorized Signature Title Date

NOTE: No relief from tax will be permitted until authorized by the Branch.

Form 16

Fuel Tax Act



Ministry of Revenue
Motor Fuels and Tobacco Tax Branch

Notice of Assessment
FT 828

Account Number	Date of Mailing or Delivery	Due Date	Please quote this Assessment Number in all correspondence pertaining to this Notice of Assessment

Explanation of Assessment

You have been assessed the amount indicated in respect of Fuel Tax due and payable to the Treasurer of Ontario. If the tax due is not paid by the due date, interest will be charged to the date of payment.

This liability is for the period		Fuel Tax Due	Interest	Other/Penalty	Total Amount
From	To	\$	\$	\$	\$ of this Assessment

NOTICE OF OBJECTION

You have the right to appeal this Notice of Assessment by filing an objection with the Minister of Revenue in the prescribed form within 180 days from the date this notice was mailed.

For more information or to obtain Notice of Objection forms contact:
Tax Appeals Branch
Ontario Ministry of Revenue

Statement of Account

Balance	
Total of above assessment	
Amount credited	
Net account balance as of	

Deputy Minister of Revenue

DETACH HERE



Ministry of Revenue
Motor Fuels and Tobacco Tax Branch

Remittance Advice
Fuel Tax Act

01 00 11 00

Mailing Address, if different from above (include Postal Code)

Assessment Number

CREDIT

- Claim as an accumulated credit on your next return.
- A cheque in the above amount will be mailed to you.

PAYMENT DUE

For Office Use Only

Detach and return this Remittance Advice together with your Cheque or Money Order made payable to the Treasurer of Ontario, to:
Ministry of Revenue
Taxation Data Centre
Motor Fuels and Tobacco Tax Branch

Form 17

Fuel Tax Act



Ministry of Revenue
Motor Fuels and Tobacco Tax Revenue Branch

Statement of Disallowance - FT 829

Date of Mailing or Delivery

Please quote this DISALLOWANCE NUMBER on all correspondence pertaining to this Statement of Disallowance

Refund of tax claimed by you in respect of Fuel Tax has been disallowed in the amount and for the reason(s) indicated below.

Type of claim received

Fuel Tax Return(s) - Account No. []
OR
 Refund Claim - G T R No. []
Refund Claim No. []

Period covered by refund claim - From [] To []

Amount of refund claimed \$.
Amount of refund disallowed \$.
Amount of refund allowed \$.

Reason(s) for disallowance

NOTICE OF OBJECTION
You have the right to appeal this Statement of Disallowance of your claim by filing an objection with the Minister of Revenue in the prescribed form within 180 days from the date this notice was mailed. For more information or to obtain Notice of Objection forms contact:
Tax Appeals Branch
Ontario Ministry of Revenue

Deputy Minister of Revenue

Form 18

Fuel Tax Act

Lead Seal



Obverse



Reverse

To accommodate
an identification number
from 1 to 50 inclusive
(Digits 5mm high)

O. Reg. 772/82, Form 15.

Form 19

Fuel Tax Act



O. Reg. 772/82, Form 16.

Form 20

Fuel Tax Act

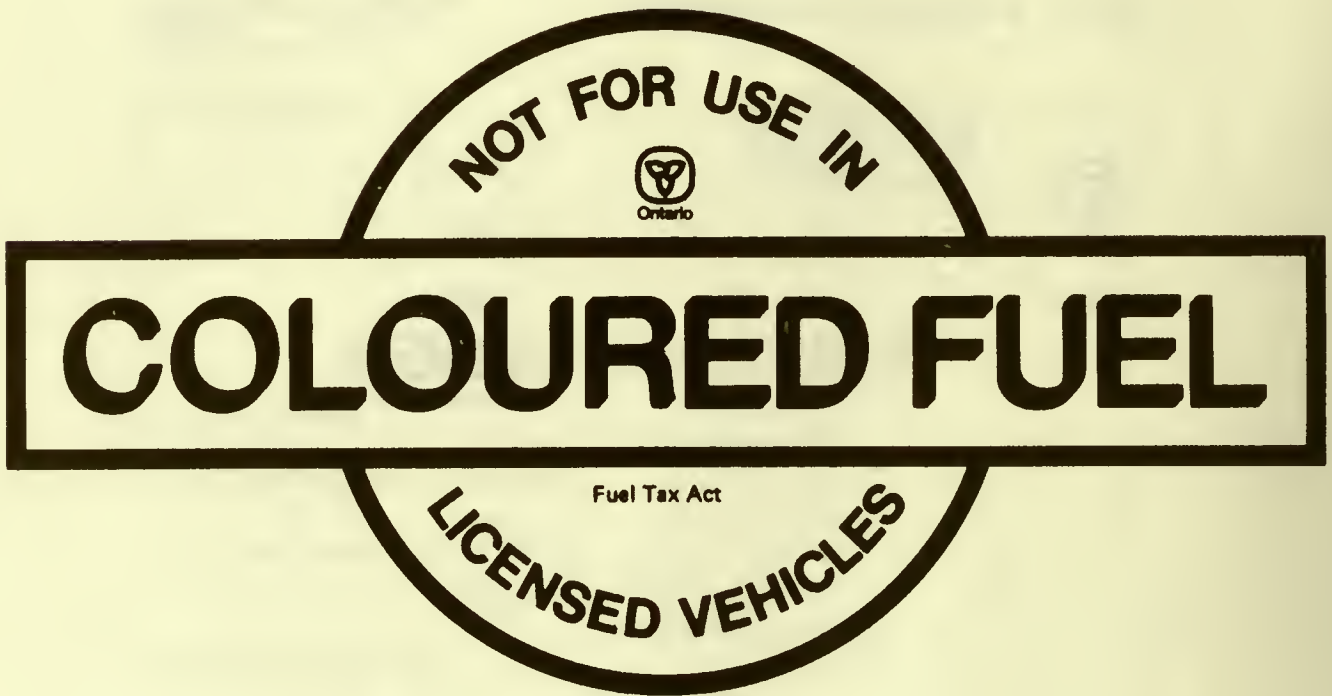

O. Reg. 772/82, Form 17.

Form 21

Fuel Tax Act



Ministry of Revenue Ontario

Notice of Objection

Name of Taxpayer (Corporation, Purchaser, Registrant, Vendor)			Telephone No ()
Street Number and Name			
Mailing Address			
City/Town	Province	Postal Code	

NOTICE OF OBJECTION is hereby given to the:

<input type="checkbox"/> OR <input type="checkbox"/>	Assessment No	Date of Notice of Assessment	Amount of Tax	for Period ending
		Year Month Day	\$	Year Month Day
	Statement of Disallowance	Statement Date	Rebate/Refund Amount	
	of Rebate/Refund Claim No. _____	Year Month Day	\$	

under the following act (check one only and indicate account/permit number)

<input type="checkbox"/> CORPORATIONS TAX ACT	- Account Number	_____
<input type="checkbox"/> GASOLINE TAX ACT	- Permit Number	_____
<input type="checkbox"/> LAND TRANSFER TAX ACT		
<input type="checkbox"/> RETAIL SALES TAX ACT	- Permit Number	_____ - _____
<input type="checkbox"/> TOBACCO TAX ACT	- Permit Number	_____
<input type="checkbox"/> FUEL TAX ACT	- Permit Number	_____
<input type="checkbox"/> MINING TAX ACT	- Account Number	_____
<input type="checkbox"/> RACE TRACKS TAX ACT	- Permit Number	_____ - _____

The following are the reasons for objection and the relevant facts:

(If space is insufficient, a separate memorandum should be attached setting forth the full statement of reasons for objection and relevant facts.)

Check here if additional sheets are attached.

Appointment of Representative

I confirm that _____ has the authority to communicate on my/the company's behalf concerning this Notice of Objection. I authorize the Tax Appeals Branch to collect personal information from and disclose personal information to my representative in accordance with the Freedom of Information and Protection of Privacy Act.

This NOTICE OF OBJECTION must be signed by the person objecting or an authorized signing officer of the company.

Date	Name (print)	Signature	Position or Office
------	--------------	-----------	--------------------

Form 22

Fuel Tax Act



Notice of Appeal

IN THE ONTARIO COURT (GENERAL DIVISION)

In The Matter of the (Check one only):

- Corporations Tax Act, Gasoline Tax Act, Retail Sales Tax Act, Tobacco Tax Act, Land Transfer Tax Act, Fuel Tax Act, Mining Tax Act, Race Tracks Tax Act

BETWEEN

- AND - THE MINISTER OF REVENUE

Appellant,

Respondent.

TAKE NOTICE that pursuant to (Check one only):

- Section 85 of the Corporations Tax Act, Section 14 of the Gasoline Tax Act, Section 25 of the Retail Sales Tax Act, Section 22 of the Tobacco Tax Act, Section 14 of the Land Transfer Tax Act, Section 14 of the Fuel Tax Act, Section 10 of the Mining Tax Act, Section 11 of the Race Tracks Tax Act

the Appellant appeals to the Ontario Court (General Division) from the decision of the Minister of Revenue

dated the ... day of ... 19 ... in respect of

Table with 4 columns: Assessment No., Date of Notice of Assessment, Amount of Tax, For Period ending. Includes rows for Statement of Disallowance and Rebate/Refund Amount.

STATEMENT OF REASONS FOR APPEAL

(Set out relevant facts and law to be relied on in support of the appeal in a separate memorandum attached to this form.)

Appointment of Representative

I confirm that ... has the authority to communicate on my/the company's behalf concerning this Notice of Appeal. I authorize the Ministry of Revenue to collect personal information from and disclose personal information to my representative in accordance with the Freedom of Information and Protection of Privacy Act.

This NOTICE OF APPEAL must be signed by the Appellant or by an authorized representative.

Signature line with fields for Date, Name (print), Signature, and Position or Office.

Form 23

Fuel Tax Act

Application for a Single Exemption Certificate

Legal Name		Certificate No.
Mailing Address		Postal Code
Name of Person to Contact		Telephone
Name of Collector/Supplier	Terms of Purchase <input type="checkbox"/> F.O.B. Supplier's Dye-point <input type="checkbox"/> F.O.B. Customer's Dye-point	
Name of Collector/Customer	Terms of Sale <input type="checkbox"/> F.O.B. Supplier's Dye-point <input type="checkbox"/> F.O.B. Customer's Dye-point	

Particulars of untaxed clear fuel receipts and deliveries

Receipts from Collector/Supplier			Deliveries to Collector/Customer			Transported by			
Dye-point Location	Date	Quantity (Litres)	Dye-point Location	Date	Quantity (Litres)	Truck	Ship	Pipeline	Railway
Total Quantity			Total Quantity						

VERIFICATION
 All the information given in this application and in every document submitted in support thereof is true, correct and complete in every detail.

Name (Type or Print)	Title	Signature	Date
----------------------	-------	-----------	------

O. Reg. 267/84, s. 2, part.

Form 24

Fuel Tax Act

Single Exemption Certificate

Commencing on the date indicated, the holder of this certificate is authorized to acquire from Collector
 a quantity not to exceed..... litres, in aggregate, of untaxed clear fuel which may be supplied in whole or in part from
 dye point dye point dye point
 subject to the conditions listed on the reverse side of this certificate.

Legal Name and Address
 []

Certificate No.
Effective Date
Expiry Date

Minister of Revenue

O. Reg. 267/84, s. 2, part.

Form 25

Fuel Tax Act

Statement of Clear Fuel Receipts and Deliveries

Legal Name		Certificate No.
Mailing Address		Postal Code
Name of Person to Contact		Telephone
Name of Collector/Supplier	Terms of Purchase <input type="checkbox"/> F.O.B. Supplier's Dye-point <input type="checkbox"/> F.O.B. Customer's Dye-point	
Name of Collector/Customer	Terms of Sale <input type="checkbox"/> F.O.B. Supplier's Dye-point <input type="checkbox"/> F.O.B. Customer's Dye-point	

Particulars of untaxed clear fuel receipts and deliveries (attach additional sheet if space is insufficient)

Receipts from Collector/Supplier				Deliveries to Collector/Customer				Transported by			
Dye-point Location	Date	Invoice No.	Quantity (Litres)	Dye-point Location	Date	Invoice No.	Quantity (Litres)	Truck	Ship	Pipeline	Railway
Quantity Received				Quantity Delivered							
Quantity Authorized				Quantity Authorized							
Difference				Difference							

VERIFICATION			
The financial and other statements of information included herein or attached hereto are in agreement with the books of the certificate holder and exhibit truly, correctly and completely all information for the period covered by this statement.			
Name (Type or Print)	Title	Signature	Date

O. Reg. 267/84, s. 2, part.

Form 26
Formule 26



Ministry of Revenue / Ministère du Revenu

Motor Fuels and Tobacco Tax Branch / Direction de la taxe sur les carburants et le tabac

Ontario Fuel and Gasoline Tax (Border) FGTB-1
Gasoline Tax Act/Fuel Tax Act

Taxe ontarienne sur les carburants et sur l'essence (Frontière) FGTB-1
Loi de la taxe sur l'essence/Loi de la taxe sur les carburants

Name of importing Consignee / Nom du consignataire important le carburant		Importer's Federal Sales Tax Number / Numéro de la taxe de vente fédérale de l'importateur
Postal Address / Adresse postale	Telephone No / N° de téléphone	Importer's Federal Excise Tax Number / Numéro de la taxe d'accise fédérale de l'importateur
City, Town and Province / Cité, ville, province	Postal Code / Code postal	If applicable, Ontario Gasoline Tax Collector No. / Le cas échéant, N° du percepteur de la taxe sur l'essence de l'Ontario
Name of Carrier / Nom du transporteur		Ontario Fuel Tax Collector No. / N° du percepteur de la taxe sur les carburants de l'Ontario
Ontario Point of Entry / Point d'entrée en Ontario	Canada Customs Control Document No / N° du document de contrôle des douanes canadiennes	

Tax on Gasoline / Aviation Fuel Imports
Taxe sur les importations d'essence / de carburant aviation

Product/Produit Gasoline/Essence	Litres Imported Litres importés		Tax Rate Taux de la taxe		Tax Amount Montant de la taxe
Leaded/Avec plomb	<input type="text" value="1"/>	X	<input type="text"/>	=	\$ <input type="text"/>
Unleaded/Sans plomb	<input type="text" value="1"/>	X	<input type="text"/>	=	\$ <input type="text"/>
Aviation Fuel Carburant aviation	<input type="text" value="1"/>	X	<input type="text"/>	=	\$ <input type="text"/>
Note: 1 US Gallon = 3.785 litres / Remarque: 1 gallon É.U. = 3,785 litres					Tax Due / Taxe due "A" \$ <input type="text"/>

Tax on Fuel Imports/Taxe sur les importations de carburant

Product/Produit	Litres Imported Litres importés		Tax Rate Taux de la taxe		Tax Amount Montant de la taxe
Clear Fuel Carburant incolore	<input type="text" value="1"/>	X	<input type="text"/>	= "B"	\$ <input type="text"/>
Coloured fuel dyed under supervision of a customs officer Carburant coloré sous la supervision d'un douanier	<input type="text" value="1"/>	X	Tax Exempt Exonéré de la taxe		
1-K Kerosene as certified by manufacturers Kérosène 1K certifié comme tel par les fabricants	<input type="text" value="1"/>	X	Tax Exempt Exonéré de la taxe		
Total Tax Due / Taxe due = "C" ("A" + "B" = "C")					\$ <input type="text"/>

Make cheque payable to Treasurer of Ontario / Libeller le chèque à l'ordre du trésorier de l'Ontario

Certification
I hereby certify that the statements made herein or attached hereto are in agreement with the books of the importer and exhibit truly, correctly and completely all information concerned by this statement.

Attestation
J'atteste, par la présente, que les renseignements contenus dans cette formule ou joints à celle-ci sont conformes aux registres de l'importateur et présentent de manière fidèle, exacte et complète tous les renseignements s'y rapportant.

Signature of Signing Officer / Signature du signataire autorisé	Title	Date
---	-------	------

REGULATION 465

MISCELLANEOUS

1. In this Regulation,

“broker-driver” means a person who has entered into a written agreement to drive a motor vehicle on behalf of the operator of the motor vehicle where the operator is an interjurisdictional carrier and where the person is responsible for the purchase of the fuel used to generate power in the motor vehicle;

“motor vessel” means any vessel, ship, boat or watercraft that is designed to move in or through water, and that is powered by fuel, but does not include any aircraft capable of operating on water or any vehicle moving on ice. O. Reg. 778/82, s. 1.

2.—(1) For the purposes of the Act and this Regulation, “operator” when used in reference to a motor vehicle, other than a motor vehicle referred to in clause (b) or (c) of the definition of “interjurisdictional carrier” in section 1 of the Act, that is used in the commercial transportation of goods or passengers for compensation or in the course of a commercial undertaking means,

- (a) the registered owner of the motor vehicle if the motor vehicle is not leased to another person or is leased to another person for a period less than thirty-one consecutive days;
- (b) the lessee of the motor vehicle if the motor vehicle is leased for a period in excess of thirty consecutive days, unless the lessee has entered into a written agreement with the lessor whereby the lessor agrees to account for and remit to the Treasurer the tax imposed under the Act on fuel used by the motor vehicle during the term of the lease; and
- (c) the lessor of the motor vehicle if the motor vehicle is leased to another person,
 - (i) for a period not in excess of thirty consecutive days, or
 - (ii) for a period in excess of thirty consecutive days and the lessor has entered into a written agreement with the lessee whereby the lessor agrees to account for and remit to the Treasurer the tax imposed under the Act on fuel used by the motor vehicle during the term of the lease.

(2) Despite subsection (1), for the purposes of subsections 5 (2) and (3) and section 19 of the Act, “operator” when used in reference to a motor vehicle, other than a motor vessel, includes the driver of the motor vehicle.

(3) For the purposes of the Act and this Regulation, “operator” when used in reference to a motor vessel means the person having the care or control of the motor vessel.

(4) For the purposes of the Act and this Regulation, “driver” means the person having the physical care and control of a motor vehicle whether the motor vehicle is in motion or not.

(5) For the purposes of subsection (1), the “registered owner” of a motor vehicle, other than a motor vehicle referred to in clause (b) or (c) of the definition of “interjurisdictional carrier” in section 1 of the Act, means the “holder” within the meaning of subsection 6 (1) of the *Highway Traffic Act*,

- (a) in whose name a permit has been issued under section 7 of the said Act with respect to the motor vehicle; or
- (b) who would be required to apply for and obtain a permit under section 7 of the said Act with respect to the motor vehicle, but for the provisions of a reciprocal agreement between Ontario and another jurisdiction. O. Reg. 303/87, s. 1.

3. For the purpose of clause (a) of the definition of “interjurisdictional carrier” in section 1 of the Act and paragraph 4 of section 7 of this Regulation, a vehicle required to be licensed under the *Highway Traffic Act* includes a vehicle that would be required to be so licensed but for a reciprocal agreement between Ontario and another jurisdiction. O. Reg. 778/82, s. 3.

4. For the purposes of the definition of “interjurisdictional carrier” in section 1 of the Act and subsection 2 (1) of this Regulation, a person engages in the commercial transportation of goods or passengers when that person operates,

- (a) a commercial motor vehicle carrying a cargo of passengers or goods;
- (b) a commercial motor vehicle travelling without a cargo of passengers or goods to a point at which passengers or goods are to embark or be loaded;
- (c) a commercial motor vehicle returning without a cargo of passengers or goods from a point at which passengers or goods have disembarked or been offloaded; or
- (d) a tractor travelling without a trailer in transit to a point where a trailer is to be picked up or from a point where a trailer has been delivered. O. Reg. 255/85, s. 1; O. Reg. 303/87, s. 2

5. The following products are excluded from the application of the Act except when they are blended, compounded or combined with any fuel taxable under the Act:

1. Bunker fuel.
2. Any product that is a solvent, naphtha or thinner and that is obtained from a petroleum origin or from the destructive distillation of coal, wood or wood products or that is produced by fermentation or by synthetic chemical reaction.
3. Any product that is compounded wholly of products referred to in paragraph 2.
4. Kerosene certified by the vendor on the invoice as meeting the standard for type I-K Kerosene specified by the American Society for Testing and Materials (A.S.T.M.).
5. Coloured fuel. O. Reg. 778/82, s. 4; O. Reg. 604/83, s. 1; O. Reg. 676/87, s. 1.

6. Those persons serving in or employed by a diplomatic or consular mission, high commission or trade commission and their spouses and families as authorized by the Department of External Affairs Canada are exempt from the tax imposed by the Act when purchasing clear fuel exclusively for their own use provided that such persons are not Canadian citizens or “permanent residents” of Canada as defined in the *Immigration Act* (Canada) and provided that such persons are assigned to duty from the state they represent and are not engaged locally by the mission or commission. O. Reg. 778/82, s. 5.

7. All fuel used in the following enumerated ways is exempt from the tax imposed by the Act:

1. Clear fuel delivered directly into the tanks of a motor vessel operating under the *Canada Shipping Act* (Canada), provided that the purchaser holds a fuel acquisition permit.
2. Clear fuel intended for use exclusively in the service vehicles, aircraft or vessels of a visiting force as defined in the *Visiting Forces Act* (Canada) when such fuel is exempt from taxation under section 26 of that Act and the regulations made thereunder.
3. Coloured fuel when used for any purpose other than the operation of a motor vehicle,

- i. licensed or required to be licensed under the *Highway Traffic Act*, or
 - ii. operated or intended to be operated principally for the pleasure or recreation of its owner or operator.
4. Ethyl alcohol, methyl alcohol, natural gas, manufactured gas or any product commonly known as liquefied petroleum gas used for the purpose of generating power by internal combustion.
 5. Coloured fuel when used by registered Indians if such fuel is acquired on a reserve, or used by an Indian settlement located on Crown land, the Indian inhabitants of which are treated by the Department of Indian Affairs and Northern Development (Canada) in the same manner as Indians residing on a reserve and, for the purposes of this paragraph, "registered" and "reserve" have the same meaning as in the *Indian Act* (Canada).
 6. Clear fuel purchased from the terminal of a collector in a quantity in excess of 100,000 litres by a person authorized by the Minister to acquire the fuel for the purpose of resale to a collector operating an authorized dye-point for transfer by pipeline, railway or ship to that dye-point where all the fuel is delivered to the dye-point of the purchasing collector and the person authorized by the Minister to acquire clear fuel for resale presents to the collector selling the fuel a single exemption certificate issued by the Minister.
 7. Clear fuel purchased from the terminal of a collector in a quantity in excess of 100,000 litres by a person authorized by the Minister to acquire the fuel for the purpose of resale to a collector operating an authorized dye-point for transfer by truck to that dye-point where,
 - i. delivery of the fuel is taken and title to the fuel passes at the terminal of the collector selling the fuel and the fuel is picked up by the collector purchasing the fuel or a common carrier employed by the collector purchasing the fuel; or
 - ii. delivery of the fuel is taken and title to the fuel passes at an authorized dye-point of the purchasing collector,

and where all the fuel is delivered to the dye-point of the purchasing collector and the person authorized by the Minister to acquire clear fuel for resale presents to the collector selling the fuel a single exemption certificate issued by the Minister. O. Reg. 778/82, s. 6; O. Reg. 266/84, s. 1; O. Reg. 448/86, s. 1.

8.—(1) The rate of interest payable per year under the Act or any regulation made under the Act shall be reviewed semi-annually and adjusted, effective on the 1st day of April and the 1st day of October in each year, and shall remain in force until the next adjustment date, and the rate shall be the mean rate rounded to the nearest whole percentage point of the lowest interest rates charged to their most credit-worthy borrowers for prime business loans by the Royal Bank of Canada, the Bank of Nova Scotia, the Canadian Imperial Bank of Commerce, the Bank of Montreal and the Toronto-Dominion Bank, and,

- (a) where the date of the interest adjustment is the 1st day of April, the rate shall be based on the mean interest rates effective on the immediately preceding 15th day of January; and
- (b) where the date of the interest adjustment is the 1st day of October, the rate shall be based on the mean interest rates effective on the immediately preceding 15th day of July,

and the Minister shall cause the rate to be printed in *The Ontario*

Gazette published next after the coming into force of the adjusted rate.

(2) On the amount of any refund made under subsection 13 (1) of Regulation 464 of Revised Regulations of Ontario, 1990, interest shall be paid, calculated from the date of application to the Minister for the amount to be refunded to the date when the refund is made or is applied by the Minister or the Treasurer, as the case may be, against other liability of the person entitled to the refund.

(3) On the amount of any refund made under subsection 21 (3) of the Act as the result of any overpayment of tax to the Treasurer under the Act, interest shall be paid, calculated from the date of application to the Minister for the amount to be refunded to the date when the refund is made or is applied by the Minister or the Treasurer, as the case may be, against other liability of the person entitled to the refund.

(4) Despite subsections (1), (2) and (3), where the amount of interest is calculated to be less than \$5.00, no interest shall be paid or applied.

(5) Where a calculation of interest is made under the Act or the regulations, the rate of interest payable with respect to each portion of the period of calculation after that date shall be the rate of interest in effect for that portion of the period as prescribed under subsection (1). O. Reg. 510/83, s. 1.

9.—(1) Where a collector colours fuel in accordance with the Act and the Regulations, the collector may deduct from the amount otherwise to be remitted to the Treasurer under section 11 of the Act .023 of a cent for each litre of fuel coloured by the collector as compensation for the collector's services but no compensation may be claimed by a collector with respect to fuel,

- (a) subsequently exported or used outside Ontario by,
 - (i) the collector,
 - (ii) the person to whom the collector sold the fuel, or
 - (iii) any subsequent purchaser who does not deal at arm's length with the collector or with the person to whom the collector sells the fuel;
- (b) coloured outside Ontario and imported into Ontario, unless the dye used to colour such fuel is supplied by the Minister;
- (c) coloured, using dye supplied by the Minister, the cost of which is assessed to the collector under subsection 13 (4) of the Act;
- (d) coloured in whole or in part by any officer of the Ministry of Revenue or under the direct supervision or instruction of such an officer;
- (e) coloured prior to the Minister's designation of the collector under subsection 8 (1) of the Act or during any suspension or cancellation of that designation under section 9 of the Act;
- (f) coloured and delivered to the terminal of another collector; or
- (g) coloured and delivered to a registered consumer purchasing such fuel under the authority of a valid fuel acquisition permit. O. Reg. 778/82, s. 8 (1); O. Reg. 643/83, s. 1; O. Reg. 334/88, s. 1; O. Reg. 10/89, s. 1 (1).

(2) The amount of compensation for a collector's services shall be rounded to the nearest whole cent. O. Reg. 10/89, s. 1 (2).

(3) Despite clause (1) (b), dye supplied by another province may be used by a collector to colour fuel outside Ontario for importation, sale and use in Ontario where prior written approval is obtained

from the Minister and the collector may claim compensation in accordance with subsection (1) provided that no compensation for the colouring of the fuel is paid by the province in which the fuel is coloured.

(4) The Minister may give the written approval required under subsection (3) only where he or she is satisfied that the dye supplied by another province will contain the same chemical substances in the same proportions described in subsection 1 (4) of Regulation 464 of Revised Regulations of Ontario, 1990 and will be blended with fuel in the proportion prescribed in subsection 1 (3) of that Regulation. O. Reg. 778/82, s. 8 (2, 3).

10.—(1) The Deputy Minister of Revenue and the officer of the Ministry of Revenue holding the position of Assistant Deputy Minister, Tax Revenue, may exercise any power or perform any duty conferred or imposed upon the Minister by the Act.

(2) The officer of the Ministry of Revenue holding the position of Director of the Motor Fuels and Tobacco Tax Branch may exercise the powers and perform the duties of the Minister under the following sections of the Act:

1. Sections 2, 3, 4, 5, 6, 7, 8, 9, 10 and 12.
2. Subsections 15 (3) and 17 (3).
3. Clauses 18 (1) (a), (b), (c), (e) and (f).
4. Subsections 18 (2), (3) and (4).
5. Sections 19, 20 and 21.
6. Subsections 22 (5) and (7).
7. Section 25.

(3) The officer of the Ministry of Revenue holding the position of Manager of Audit, Motor Fuels and Tobacco Tax Branch, may exercise the powers and perform the duties of the Minister under the following sections of the Act:

1. Sections 5 and 6.
2. Subsection 9 (3).
3. Section 12.
4. Clauses 18 (1) (a), (b), (c), (e) and (f).
5. Subsections 18 (2) and (3).
6. Sections 19, 21 and 25.

(4) The officer of the Ministry of Revenue holding the position of Manager, Operations and Finance, Motor Fuels and Tobacco Tax Branch, may exercise the powers and perform the duties of the Minister under the following sections of the Act:

1. Subsections 2 (2) and 3 (1).
2. Sections 4 and 7.
3. Subsection 8 (9).
4. Section 10.
5. Subsection 17 (3).
6. Section 21.

(5) The officer of the Ministry of Revenue holding the position of Manager, Tax Advisory Services, Motor Fuels and Tobacco Tax Branch, may exercise the powers and perform the duties of the Minister under subsection 22 (7) of the Act.

(6) The officer of the Ministry of Revenue holding the position of Director, Special Investigations Branch, may exercise the powers and perform the duties of the Minister under the following sections of the Act:

1. Section 6.
2. Subsections 12 (1) and (2).
3. Sections 18 and 19.
4. Subsections 22 (5) and (6).

(7) The officer of the Ministry of Revenue holding the position of Director, Legal Services Branch, may exercise the powers and perform the duties of the Minister under the following sections of the Act:

1. Subsections 12 (2) and 14 (15).
2. Clause 17 (1) (b).

(8) The officer of the Ministry of Revenue holding the position of Director, Tax Appeals Branch, may exercise the powers and perform the duties of the Minister under subsections 14 (3) and (15) of the Act.

(9) Every officer of the Ministry of Revenue authorized to perform investigations under subsection 18 (1) of the Act is authorized to exercise the Minister's power to require information under subsections 6 (2) and 19 (1) of the Act. O. Reg. 778/82, s. 9.

REGULATION 466

REFUNDS

1. In this Regulation,

“applicant” means a person who applies for a refund under this Regulation;

“debtor” means a person to whom an applicant has sold fuel;

“wholesale dealer” means a person who sells fuel for the purpose of resale. O. Reg. 470/88, s. 1.

2.—(1) Subject to subsection (2), upon receipt of an application in Form 15 of Regulation 464 of Revised Regulations of Ontario, 1990 made by an applicant who is a collector, importer, wholesale dealer or retail dealer, together with such other information as may be required under this section, the Minister may refund an amount on account of tax collectable or payable under the Act that has been remitted by the applicant to the Treasurer or paid over by the applicant to the collector, importer or other fuel supplier for subsequent remittance to the Treasurer, with respect to fuel, equal to,

- (a) where all or a portion of the sale price of the fuel sold by the applicant has not been paid and has become an uncollectable debt, that portion of the amount remitted or paid over by the applicant on account of tax with respect to the fuel that the uncollectable debt bears to the total sale price of the fuel, including the total amount on account of tax; and
- (b) where the fuel has been lost or cannot be sold or used by the applicant by reason of destruction, theft or contamination of the fuel, the amount remitted or paid over by the applicant on account of tax with respect to the fuel.

(2) No refund shall be made under this section where,

- (a) the collectable or uncollectable portion of the debt arising on the sale of the fuel referred to in clause (1) (a) has been

- assigned, with or without recourse, by private contract to another person other than for security purposes;
- (b) at the time of the sale of the fuel referred to in clause (1) (a) or of the loss of the fuel referred to in clause (1) (b), as the case may be, the applicant did not hold a valid licence under the *Gasoline Handling Act*; or
- (c) the applicant is otherwise entitled under the Act or the regulations to receive or to apply to receive a refund of or an allowance in compensation for the amount remitted or paid over by the applicant on account of the tax with respect to the fuel.
- (3) For the purposes of this section,
- (a) a debt is not an uncollectable debt until,
- (i) the applicant has claimed a deduction for the amount of the debt under paragraph 20 (1) (p) of the *Income Tax Act* (Canada) in the calculation of the applicant's income for a taxation year for the purposes of that Act, and
- (ii) the deduction referred to in subclause (i) has been allowed by the Minister of National Revenue, by a court on an appeal under Division J of the *Income Tax Act* (Canada) or by a court on an appeal of a previous court decision; and
- (b) a debt shall cease to be an uncollectable debt if the deduction referred to in clause (a) is subsequently denied on an assessment, re-assessment or additional assessment of tax or in a determination of the applicant's non-capital loss under the *Income Tax Act* (Canada), or on an appeal referred to in subclause (a) (ii).
- (4) An application for a refund under clause (1) (a) shall be accompanied by,
- (a) copies of all invoices in respect of which a refund is being claimed;
- (b) proof that the amount being claimed was remitted to the Treasurer or paid over to a collector, importer or other supplier for subsequent remittance to the Treasurer; and
- (c) proof that the debt in respect of which the refund is being claimed is an uncollectable debt.
- (5) An application for a refund under clause (1) (b) shall be accompanied by,
- (a) a copy of any settlement by or written confirmation from an insurance company confirming settlement of any claim for the loss with respect to which the refund is being claimed;
- (b) a copy of any police report made with respect to the loss;
- (c) a copy of any fire marshal's report made with respect to the cause of the loss; and
- (d) such other information as is necessary to verify the loss or contamination of the fuel and the remittance or payment over by the applicant of the amount being claimed.
- (6) Where a refund has been made under clause (1) (a) or under section 11 of Ontario Regulation 772/82 as it existed on the 21st day of July, 1988, the tax in respect of the fuel shall remain payable to the Treasurer and the applicant or the person who received the refund under the said section 11 shall pay to the Treasurer an amount on account of tax payable under the Act as determined under subsection (7) at any time when the applicant or person receives any payment from or on behalf of the debtor or receives any payment from any person in satisfaction of part or all of the debt in respect of which the refund was made.
- (7) For the purpose of subsection (6), the amount payable to the Treasurer shall be the amount on account of the tax determined by the Minister to have been paid to the applicant or person after allocation of the payment to amounts payable to the applicant by the debtor on account of fuel and tax in the order of the date of sale by the applicant or person.
- (8) Where a refund has been made under clause (1) (a) and the debt in respect of which the refund was made has ceased to be an uncollectable debt, the applicant shall become liable to pay to the Treasurer the amount of the refund and such amount shall be deemed, for the purposes of the recovery thereof, to be tax payable by the applicant under the Act.
- (9) Where a refund has been made under clause (1) (a) and the applicant has paid an amount to the Treasurer under subsection (8), the Minister may make a refund to the applicant under clause (1) (a) in an amount that is not in excess of the amount paid to the Treasurer under subsection (8) if,
- (a) the debt in respect of which the refund was originally made subsequently becomes an uncollectable debt by reason of the subsequent allowance of the deduction referred to in clause (3) (a) by the Minister of National Revenue or by a court on an appeal of an assessment of tax under the *Income Tax Act* (Canada); and
- (b) neither the applicant nor the Minister of National Revenue has any further right of appeal, either with or without leave of a court, with respect to the issue of the deductibility of the debt or part thereof from the applicant's taxable income under that Act.
- (10) No refund shall be made under this section unless application therefor is made within three years of,
- (a) in the case of a refund under clause (1) (a), the date of a notice of assessment or a determination of a non-capital loss made under the *Income Tax Act* (Canada) or of a judgment or order of a court, whereby the debt in respect of which the refund is claimed is allowed as a deduction referred to in clause (3) (a); and
- (b) in the case of a refund under clause (1) (b), the date of the loss or contamination of the fuel in respect of which the refund is claimed. O. Reg. 470/88, s. 2.

Funeral Directors and Establishments Act

Loi sur les directeurs de services funéraires et les établissements funéraires

REGULATION 467

BOARD—COMPOSITION AND REMUNERATION

1. The Board of Funeral Services shall be composed of,
 - (a) five funeral directors appointed under paragraph 1 of subsection 4 (1) of the Act;
 - (b) five persons appointed under paragraph 2 of subsection 4 (1) of the Act; and
 - (c) one person appointed alternately under paragraph 1 of subsection 4 (1) of the Act and paragraph 2 of that subsection. O. Reg. 280/90, s. 1.
2. The remuneration payable to a member of the Board who is a funeral director is, for each day that the member is actually engaged in the business of the Board,
 - (a) \$150 for the chair of the Board;
 - (b) \$125 for the vice-chair of the Board; and
 - (c) \$100 for a member of the Board other than the chair or vice-chair. O. Reg. 280/90, s. 2, *revised*.
3. A member of the Board who is a funeral director shall be reimbursed for expenses reasonably incurred by that member in the performance of his or her duties as a member of the Board. O. Reg. 367/90, s. 1, *revised*.

REGULATION 468

COMPENSATION FUND

1. In this Regulation,

“approved securities” means investments authorized under sections 26 and 27 of the *Trustee Act*;

“Committee” means the Compensation Fund Committee appointed by the Board;

“participant” means an operator of a funeral establishment or an operator of a transfer service who participates in the Compensation Fund;

“Trustee” includes any successor Trustee appointed under subsection 15 (7). O. Reg. 369/90, s. 1.

FUND ESTABLISHED

2. The compensation fund known as the Prepaid Funeral Services Compensation Fund is continued. O. Reg. 369/90, s. 2, *revised*.

COMMITTEE

3. Except for the duties and responsibilities of the Trustee and the Board under this Regulation, the affairs of the Compensation Fund shall be managed by the Committee. O. Reg. 369/90, s. 3.
4. A member of the Committee is disqualified from participating and shall not participate in any deliberation or decision of the Com-

mittee with respect to any claim against a participant where the member is the participant or an officer or director of the participant or has a financial interest in the participant. O. Reg. 369/90, s. 4.

5. The situs of the Compensation Fund shall be in Ontario at all times and the property and interest comprising the Compensation Fund shall be held at all times by the Trustee in Ontario. O. Reg. 369/90, s. 5.

6.—(1) The Committee may employ or retain or authorize the employment or retention of such counsel, accountants or other experts or advisors as it may reasonably require to assist in administering the Compensation Fund and the Committee may act and shall be protected where it acts in good faith on the opinion or advice of or information from any of them and shall not be responsible for any misconduct on the part of any of them.

(2) The Committee may, in its discretion, employ or authorize the employment of such persons to act as claims officers and clerks as it may reasonably require to assist in the efficient consideration and resolution of claims and operation of the Compensation Fund.

(3) All fees, costs and expenses incurred by the Committee in employing or retaining persons under this section shall be paid by the Trustee and shall be deducted first from the income of the Compensation Fund and in the event of any deficiency, from the capital of the Fund. O. Reg. 369/90, s. 6.

PAYMENTS FROM PARTICIPANTS

7. The capital of the Fund shall be composed of the payments of the participants contributed in the manner set out in section 8. O. Reg. 369/90, s. 7.

PAYMENTS BY PARTICIPANTS

8.—(1) Every operator of a funeral establishment that offers services to the public and every operator of a transfer service shall participate in the Compensation Fund. O. Reg. 369/90, s. 8 (1).

(2) Each participant shall make an initial payment of \$180 into the Compensation Fund at the time the participant applies for a licence. O. Reg. 369/90, s. 8 (2), *revised*.

(3) In addition to the initial payment, each participant shall pay a \$5 levy into the Compensation Fund for each death registered under the *Vital Statistics Act* for which payment was required for funeral services or supplies or transfer services provided during the year by the participant, until the participant is notified by the Committee that the book value of the Compensation Fund is at least \$1,000,000.

(4) The levy required to be paid each year under this section shall be for the period ending on the 31st day of October and may be paid in one instalment or two equal instalments as follows:

1. One payment after the 31st day of October and on or before the 31st day of December in that year.
2. One payment after the 31st day of October and on or before the 31st day of December in that year and one payment in the next year after the 30th day of April and on or before the 30th day of June. O. Reg. 369/90, s. 8 (3, 4).

(5) If the book value of the Compensation Fund is less or is anticipated to be less than \$500,000 by reason of a proposed payment or

payments by the Compensation Fund to one or more claimants, the Committee may in its discretion require each participant,

- (a) to pay such additional amount in proportion to the amount of the levy that the participant is required to pay under this section, as the Committee determines is necessary to bring the level of the Compensation Fund up to at least \$1,000,000; or
- (b) to recommence paying the levy under subsection (3). O. Reg. 369/90, s. 8 (5), *revised*.

(6) Each participant shall pay the additional amount referred to in clause (5) (a) within twenty-one days of the notice of the required payment. O. Reg. 369/90, s. 8 (6).

COMPENSATION FUND

9.—(1) All money received from participants or others under this Regulation and all income on any such money including any rights or benefits accruing from the investment of such money shall be held in trust for the benefit of such of the holders of claims as the Committee may from time to time in its discretion approve as provided in this Regulation and all such money and income shall constitute the Compensation Fund to be dealt with and distributed in accordance with this Regulation.

(2) The Committee shall maintain a record of payments or other amounts received from, on behalf of or in respect of each participant and all such payments or amounts shall be credited to a participant or participants and the Committee's decision in respect of such crediting is final.

(3) No credit of a payment or amount to the Compensation Fund with respect to a participant gives the participant any right to that payment or amount or any part thereof.

(4) The Trustee, in accordance with the direction received from the Committee, shall keep the Compensation Fund invested in approved securities.

(5) The Trustee shall collect and receive all income from the Compensation Fund and shall, after deducting the fees, costs, charges and expenses referred to in section 17, invest the balance of the income in approved securities in accordance with the provisions of section 16.

(6) Records of all transactions referred to in this section with respect to the administration of the Compensation Fund shall be based on a fiscal year ending with the 31st day of October.

(7) A copy of the financial statements of the Compensation Fund certified by the Committee shall be delivered to each member of the Board and the Registrar within thirty days after the end of each fiscal year or as soon thereafter as is reasonably possible.

(8) The financial statements of the Compensation Fund shall include, where applicable, at least the following information:

- 1. The amount owing under this Regulation by any participant to the Compensation Fund that has not been paid when due.
- 2. The amount of all receipts and the sources thereof.
- 3. The amount of all payments on behalf of participants.
- 4. A statement of all receipts and disbursements for claims in respect of each participant who failed to meet an obligation or liability under this Regulation during the fiscal period to which the statements relate.
- 5. A statement of all credits and debits to the capital of the Compensation Fund.

6. A statement of all fees, costs, charges and expenses paid from the income or capital of the Compensation Fund or owing by the Compensation Fund for expenses incurred during that fiscal period.

7. Such other information in addition to that set out in paragraphs 1 to 6 with respect to the Compensation Fund as the Board or the Registrar may from time to time require.

(9) The Trustee shall provide a quarterly statement to the Committee of the assets of the Compensation Fund at book value and fair market value and a statement of any acquisitions and dispositions of investments during the quarter to which the statement relates.

(10) The financial statements of the Compensation Fund shall be available to any participant for inspection upon request during the regular business hours of the Board. O. Reg. 369/90, s. 9.

CLAIMS

10.—(1) The Committee, subject to subsection (8), shall pay compensation to a person who makes a claim in accordance with this section and who satisfies the Committee that the person has suffered a financial loss and has not otherwise been fully compensated because,

- (a) a prepaid contract was cancelled and all the funds and income accrued thereon and owing to the person were not paid in accordance with section 34 of the Act;
- (b) a prepaid contract was not fulfilled and as a result it was necessary for the person to obtain funeral services, funeral supplies or transfer services other than under the prepaid contract;
- (c) a payment was not made to the person in accordance with section 35 of the Act; or
- (d) a refund was not made to the person in accordance with section 36 of the Act.

(2) A claim for payment out of the fund may only be made,

- (a) within six months of the event giving rise to the claim in the case of a claim under clause (1) (a), (b) or (d); or
- (b) within six months of the date that the person could have reasonably been expected to have known that payment was due in the case of a claim under clause (1) (c).

(3) A claim may be made by a claimant giving written notice of the claim to the Registrar who shall give a copy of the claim to the Committee.

(4) The Committee may require as a condition precedent to making payment of a claim or any part thereof, the delivery and execution of such documents as the Committee in its discretion or upon the advice of its counsel considers necessary including such documents as are necessary for transferring to the Committee the interest of the claimant in such claim so as to subrogate the Committee to the position of the claimant against the participant.

(5) Despite subsection (2), if circumstances warrant it, the Committee may grant an extension of time for making a claim against the Fund and the decision of the Committee as to any such extension is final and not subject to review.

(6) The Committee shall determine the eligibility and the amount of any claim made by a claimant and shall direct the Trustee to pay any claim or any part thereof that meets the requirements of this Regulation and, subject to section 11, the decision of the Committee is final.

(7) No amount shall be paid out of the Compensation Fund until the claimant assigns to the Compensation Fund any judgment or

other right of any kind that the claimant has against the participant or any other person in respect of the claimant's claim.

(8) Despite subsection (6) and subsection 11 (4), the Trustee shall not pay out of the Compensation Fund, more than \$25,000, exclusive of costs, to each claimant in respect of each transaction, for a claim or claims against any one participant.

(9) For the purposes of subsection (8), a partnership and the members thereof are deemed to be one participant and a corporation and the officers thereof are deemed to be one participant.

(10) If an amount is recovered from any source in partial satisfaction of the total claim against a participant, the maximum amount authorized by subsection (8) is reduced by the amount so recovered.

(11) If it appears to the Board or the Committee that a customer of a participant will be entitled to claim against the Compensation Fund, and that the customer has been placed in circumstances where immediate funds or service are necessary to alleviate undue inconvenience of the customer, the Committee, with the concurrence of the Board, may direct the Trustee to pay out of the Compensation Fund an amount sufficient to alleviate the immediate inconvenience.

(12) If a claim is approved by the Committee, the Trustee shall pay the claim out of the Compensation Fund to the person or persons entitled.

(13) If a payment is made out of the Compensation Fund, the Committee is subrogated for the amount of the payment, to any and all rights or remedies to which the person receiving the payment is entitled in respect of the claim for which the payment was made, including rights and remedies as judgment creditor or execution creditor in respect of any judgment that has been assigned under subsection (7) against the participant or any other person or in the event of the death, insolvency, bankruptcy or other disability of the participant or other person, against the personal representative or other person administering the estate of the participant. O. Reg. 369/90, s. 10.

HEARING BY TRIBUNAL

11.—(1) If the Committee determines that a claim or any part thereof made under section 10 is not a proper claim, it shall serve notice of its decision together with written reasons therefor on the claimant.

(2) The notice of the Committee's decision shall inform the claimant that the claimant is entitled to a hearing by the Tribunal if the claimant mails or delivers to the Registrar and the Tribunal within fifteen days after the notice is served on the claimant, notice in writing requiring a hearing.

(3) If a claimant who is served with a notice of the Committee's decision does not require a hearing, the Tribunal shall not hold a hearing and the decision of the Committee is final.

(4) If a claimant requires a hearing before the Tribunal with respect to a determination of the Committee, the Tribunal shall appoint a time for and hold the hearing and, after affording the claimant an opportunity to be heard, may confirm the determination of the Committee or may set aside the determination of the Committee with respect to all or any part of a claim and direct the Trustee to pay the amount determined by the Tribunal.

(5) The claimant who requests the hearing and such other persons as the Tribunal may specify are parties to proceedings before the Tribunal under this section. O. Reg. 369/90, s. 11.

TERMINATION OF PARTICIPATION IN THE COMPENSATION FUND

12. A participant whose licence is voluntarily cancelled under subsection 22 (8) of the Act shall be deemed to be no longer participating in the Compensation Fund on the day that the licence is cancelled by the Registrar. O. Reg. 369/90, s. 12.

13.—(1) If a participant fails to meet an obligation or liability under this Regulation, the Committee shall forward notice in writing of the failure to the participant.

(2) If a participant fails to meet an obligation or liability under this Regulation, the participant shall satisfy the failure within ten days from the date of the notice of the failure from the Committee.

(3) This section does not apply where the failure is due to insolvency, bankruptcy or a voluntary or compulsory winding up of a participant. O. Reg. 369/90, s. 13.

14. A licensee who ceases to participate in the Compensation Fund shall file with the Committee and the Registrar such financial statements and other evidence as the Committee in its discretion requires to establish that the affairs of the licensee are settled and that there are no claims on the Compensation Fund and that arrangements satisfactory to the Committee have been made to ensure that all liabilities and obligations of the licensee that could give rise to any such claim have been met and discharged. O. Reg. 369/90, s. 14.

THE TRUSTEE

15.—(1) The Committee shall, with the approval of the Board, appoint a trust corporation registered under the *Loan and Trust Corporations Act* as the Trustee.

(2) The Trustee shall not be required to give any bond or other security for the performance of its duties and shall not be responsible for any diminution in the funds, securities or property of whatever character constituting part of the Compensation Fund or any loss resulting from the making of any investments or from the retention in good faith for any length of time of securities or other property of whatsoever character purchased or acquired by it, despite the fact that the securities or property may not be income producing, or from any mistake in judgment made in good faith or from any loss of whatsoever character unless resulting from its own fraud, negligence or wilful misconduct.

(3) The Trustee may act upon any resolution, certificate, statement, instrument, opinion, report, notice, request, consent, letter, telegram, cablegram or other paper or document believed by it on reasonable grounds to be genuine and to have been signed, sent or delivered by or on behalf of the proper party or parties.

(4) The Trustee may employ or retain such counsel, accountants, appraisers or other experts or advisers as it may reasonably require for the purpose of discharging its duties under this Regulation and may act on the opinion or advice of or information obtained from any of them and shall not be responsible for any misconduct on the part of any of them.

(5) The Trustee may at any time resign as Trustee by giving ninety days notice in writing to the Board.

(6) The Committee or the Board may at any time require the removal of the Trustee on giving ninety days notice in writing to the Trustee.

(7) Upon the resignation or removal of the Trustee or where the Trustee is at any time unable to act, the Committee, with the approval of the Board, shall appoint another trust corporation registered under the *Loan and Trust Corporations Act* as a successor trustee and the corporation upon acceptance of such appointment shall, subject to subsection (8), have vested in it without further act or formality, all rights and powers given under this Regulation to the Trustee who resigned, was removed or was unable to act.

(8) Upon the written request of the Committee, the Trustee ceasing to act shall execute and deliver an instrument in writing transferring to the successor Trustee all the rights, powers and Compensation Fund assets reposing in or with the Trustee ceasing to act and shall do all such other acts or things necessary or desirable for the vesting of the Compensation Fund assets in the successor Trustee.

(9) A Trustee ceasing to act shall render to the Board and to the Committee an account of its administration. O. Reg. 369/90, s. 15.

16.—(1) The Trustee, in the administration of the Compensation Fund, shall have power and authority to,

- (a) invest and reinvest the Compensation Fund in approved securities and may do all acts and things and execute, acknowledge and deliver all instruments in respect thereof;
- (b) hold in the form of cash awaiting investment or other application hereunder any portion of the Compensation Fund and may hold the cash in any deposit or current account operated by the Trustee;
- (c) sell, convert, assign, exchange, transfer or otherwise dispose of any approved securities at any time constituting part of the Compensation Fund at public or private sale for such consideration and upon such terms and conditions as the Trustee sees fit;
- (d) vote in person or by proxy with respect to any approved security constituting part of the Compensation Fund;
- (e) exercise personally or by general or limited power of attorney any right appurtenant to any approved securities or to any other property held by it at any time;
- (f) join in or dissent from and oppose the reorganization, redistribution, consolidation, merger, liquidation or sale of corporations or properties whose securities are held by the Compensation Fund;
- (g) exchange approved securities for other securities issued in connection with or resulting from a reorganization and retain such securities;
- (h) exercise or sell any rights issued upon or with respect to any approved securities;
- (i) register any approved security or other property held by it in its own name or in the name of a nominee with or without the addition of words indicating that such securities are held in a fiduciary capacity;
- (j) do any act in addition to those referred to in clauses (a) to (i) with respect to any property in the Compensation Fund necessary to protect the investment of the Compensation Fund.

(2) The Trustee shall ensure that its books and records clearly identify all approved securities and property howsoever held by it that are part of the Compensation Fund. O. Reg. 369/90, s. 16.

17.—(1) The Trustee's fee for performing its duties under this Regulation shall be such as may be mutually agreed upon between the Board and the Trustee.

(2) In addition to the fee referred to in subsection (1), the Trustee is entitled to be reimbursed for any and all costs, charges and expenses reasonably incurred by the Trustee in the performance of its duties under this Regulation.

(3) All fees, costs, charges and expenses and the expenses directed to be paid by the Committee shall be deducted first from the income of the Compensation Fund and in the event of any deficiency in the income of the Compensation Fund from the capital of the Compensation Fund. O. Reg. 369/90, s. 17.

18. The Committee shall notify the Registrar forthwith of any failure by a participant to meet an obligation or liability under this Regulation or of any claim made in respect thereof. O. Reg. 369/90, s. 18.

19. The Trustee shall furnish the Committee with all information,

records and documents in its possession in connection with this Regulation and its administration of the Compensation Fund as the Committee may from time to time reasonably request. O. Reg. 369/90, s. 19.

MISCELLANEOUS

20. No payment shall be made out of the Compensation Fund to satisfy or settle any claim or judgment or other court order resulting from the fraud, negligence or wilful misconduct of the Trustee. O. Reg. 369/90, s. 20.

21.—(1) The Committee shall, when required by the Minister, provide to the Minister such information, books, records or documents respecting the affairs of the Compensation Fund as the Minister may specify from time to time.

(2) The Board may, where it considers it advisable, direct that the affairs of the Compensation Fund be audited and the Committee shall assist the Board in performing such an audit and shall provide all books and records and other information as may be required in connection therewith. O. Reg. 369/90, s. 21.

REGULATION 469

EQUIPMENT AND PREMISES

1. In this Regulation,

“casket” means a receptacle designed for the encasement of human remains which is ornamented or has a fixed interior lining but does not include an outer burial container or grave liner;

“container” means a receptacle designed for the encasement of human remains which is neither ornamented nor contains a fixed interior lining, but does not include an outer burial container or grave liner. O. Reg. 370/90, s. 1.

2. Every funeral establishment and premises where transfer services are performed shall be separated from other businesses by having its own entrance from a street or public area. O. Reg. 370/90, s. 2.

3. No funeral establishment or transfer service shall be located in such proximity to a cemetery or crematorium or the offices of a cemetery or crematorium so as to make it appear that the funeral establishment or transfer service is being operated in connection with it. O. Reg. 370/90, s. 3.

4. Every funeral establishment which offers services to the public and every transfer service shall have a separate meeting room suitable for meeting with a person using or inquiring about the use of its services. O. Reg. 370/90, s. 4.

5.—(1) Every funeral establishment shall have at least one separate room for the holding of dead human bodies and their preparation or placement into caskets or containers.

(2) Every transfer service shall have a room described in subsection (1) or shall be able to show it has immediate access to such a room. O. Reg. 370/90, s. 5.

6.—(1) The interior of a room used for any of the purposes described in subsection 5 (1) shall be,

- (a) at least eleven square metres in size, but larger if necessary;
- (b) hidden from sight, except when the door is open;
- (c) well lit and mechanically ventilated to the outside;
- (d) capable of being easily disinfected; and

- (e) surfaced in a material which will prevent fluids from soaking into it.

(2) A room where the preparation of dead human bodies or their placement into caskets or containers occurs shall be maintained in a sanitary condition and equipped with,

- (a) a sink supplied with hot and cold running water;
- (b) a vacuum breaker on each water supply;
- (c) storage facilities for equipment and supplies;
- (d) protective covering for the hands, body and feet of the people working in the room;
- (e) sheets or towels; and
- (f) disinfectants, germicidal soap, paper towels, a pail and mop, and detergent. O. Reg. 370/90, s. 6.

7.—(1) In a funeral establishment where embalming is performed, the room described in subsection 6 (2) shall be used for the embalming and preparation of dead human bodies.

(2) In addition to the requirements of sections 6 and 8, the room shall be equipped with,

- (a) an extra sink, or a sink with two compartments, instead of the single sink required by clause 6 (2) (a);
- (b) an examining table that is easily disinfected;
- (c) face masks, eye glasses or goggles, and disposable body suits in addition to those protective coverings required under clause 6 (2) (d);
- (d) a first aid kit and an eye wash station; and
- (e) all embalming supplies which are necessary. O. Reg. 370/90, s. 7.

8. A room described in subsection 6 (2) shall be equipped with,

- (a) sanitary drainage, or facilities for the disposal of bodily fluids; and
- (b) facilities for the disposal of and treatment of bodily fluids and waste which has come into contact with bodily fluids but which do not require disposal under Regulation 347 of Revised Regulations of Ontario, 1990 made under the *Environmental Protection Act*. O. Reg. 370/90, s. 8.

9. No holder of a licence for a funeral establishment or applicant for a licence shall construct or alter a funeral establishment with respect to any item that is governed by this Regulation unless the Registrar is first provided with architectural plans or drawings of the proposed work. O. Reg. 370/90, s. 9.

10.—(1) Funeral establishments which offer services to the public shall contain a room which displays,

- (a) at least eight adult caskets ranging in price from the least expensive available on the market to the most expensive offered by the establishment with each casket and its price clearly shown; and
- (b) a container or a picture of a container and its price both of which are set out in a prominent place.

(2) Of the eight caskets described in clause (1) (a), at least two shall be cloth-covered, two shall be metal, and two shall be wood. O. Reg. 370/90, s. 10.

11. Every casket and container shall be rigid and where necessary be leakproof or have a leakproof liner. O. Reg. 370/90, s. 11.

12. The operator of a transfer service shall in each location where the transfer service is operated own or have access to a sufficient number of containers. O. Reg. 370/90, s. 12.

13.—(1) Every operator of a funeral establishment or transfer service shall own or shall be able to obtain immediately a vehicle suitable for the transfer of dead human bodies. O. Reg. 370/90, s. 13.

(2) The vehicle shall be capable of transporting bodies so they are out of public view. O. Reg. 370/90, s. 14.

(3) The vehicle shall be kept in a sanitary condition. O. Reg. 370/90, s. 15, *revised*.

REGULATION 470

LICENSING AND BUSINESS PRACTICES

1. In this Regulation,

“casket” means a receptacle designed for the encasement of human remains which is ornamented or has a fixed interior lining, but does not include an outer burial container or grave liner;

“container” means a receptacle designed for the encasement of human remains which is neither ornamented nor contains a fixed interior lining, but does not include an outer burial container or grave liner. O. Reg. 368/90, s. 1.

2.—(1) There are two classes of licence to act as a funeral director, one authorizing the performing of embalming and one not authorizing the performing of embalming.

(2) There are two classes of licence to operate a funeral establishment, one offering funeral services to the public and one not offering funeral services to the public. O. Reg. 368/90, s. 2.

3.—(1) The requirements for the issuing of a funeral director’s licence are that the applicant,

- (a) has graduated from a program in funeral education at an institution approved by the Board;
- (b) has successfully completed twelve months of in-service training;
- (c) has passed the licensing examination set or approved by the Board, after a maximum of three attempts over a two-year period;
- (d) if the licence is to include embalming, has successfully completed a course in embalming at an institution approved by the Board and has properly embalmed at least fifty human bodies; and
- (e) has submitted to the Registrar a completed application form.

(2) The in-service training required under clause (1) (b) shall include the performance under the supervision and in the presence of a funeral director of all aspects of acting as a funeral director.

(3) The in-service training required for applicants for a licence to act as a funeral director not to perform embalming shall not include those aspects relating to embalming. O. Reg. 368/90, s. 3.

4.—(1) An applicant for a licence to operate a funeral establishment or a transfer service shall submit to the Registrar a completed application setting out,

- (a) the name of the funeral director responsible for the management of the funeral establishment or the name of the person responsible for the management of the transfer service;
- (b) the name and address of any person having a beneficial interest in the operation of the business of the applicant; and
- (c) if the operator of a funeral establishment or transfer service is a corporation, the names and addresses of the officers and directors of the corporation and persons holding more than 10 per cent of the equity shares of the corporation or an officer or director of that person.
- (2) It is a condition of a licence to operate a funeral establishment or a transfer service that the premises and vehicles are adequately insured against any public liability.
- (3) It is a condition of a licence to operate a funeral establishment that it is managed and directly supervised by a licensed funeral director and, if embalming is performed, that the funeral director is licensed to perform embalming. O. Reg. 368/90, s. 4.
5. An operator of a funeral establishment or transfer service shall, upon request of the Board, submit proof of any health, safety or environmental inspection carried out in the twelve-month period before the request. O. Reg. 368/90, s. 5.
- 6.—(1) A licence expires on the 31st day of December following the date it was issued or last renewed.
- (2) The requirements for the renewal of a licence are that the licensee pays the required fee and submits to the Registrar a completed application for the renewal of the licence. O. Reg. 368/90, s. 6.
7. The fees payable under the Act are set out in the Schedule. O. Reg. 368/90, s. 7.
8. A licence is not transferable. O. Reg. 368/90, s. 8.
- 9.—(1) A licensed operator of a funeral establishment or a transfer service shall notify the Registrar in writing of any change with respect to,
- (a) the funeral director responsible for the management of the funeral establishment or the person responsible for the management of the transfer service;
- (b) any person having a beneficial interest in the operation of the business of the licensee;
- (c) if the licensee is a corporation, any officer or director of the corporation and any person holding more than 10 per cent of the equity shares of the corporation or an officer or director of that person; or
- (d) the names or addresses of the persons mentioned in clauses (a) to (c).
- (2) The Registrar shall be given notice under subsection (1) within fifteen days of the change occurring. O. Reg. 368/90, s. 9.
10. Every licensed operator of a funeral establishment or transfer service shall prominently display the licence at or near the main entrance of the premises to which the licence relates. O. Reg. 368/90, s. 10.
- 11.—(1) Each transfer service shall be managed and directly supervised by a licensed funeral director or a person who has successfully completed a course in operating a transfer service approved by the Board, and has passed the examination set or approved by the Board after a maximum of three attempts over a two-year period.
- (2) An operator of a transfer service or an agent or employee thereof shall not,
- (a) in the course of business, be present at or conduct a visitation or be present at or participate in the conduct of a funeral;
- (b) sell or offer to sell caskets; or
- (c) engage in or offer to obtain services related to the care and preparation of a dead human body if it involves direct contact with the body, except for the removal or placement of the body in caskets or containers.
- (3) Despite clause (2) (b), an operator of a transfer service may sell or offer to sell one model of casket if the model is from among the least expensive available on the market. O. Reg. 368/90, s. 11.
12. A person who was operating a transfer service on the 1st day of April, 1990 is exempt from subsection 11 (1) if the person managed the transfer service,
- (a) at the first available opportunity, passes the examination set or approved by the Board; or
- (b) within one year of failing the examination set or approved by the Board, completes a course in operating a transfer service approved by the Board and subsequently passes the examination set or approved by the Board. O. Reg. 368/90, s. 12.
- 13.—(1) An operator of a transfer service shall transport a dead human body from the place removal was first requested directly to a cemetery or crematorium.
- (2) Unless a dead human body is first embalmed, an operator of a transfer service shall not transport it unless the transportation is effected within seventy-two hours of death or within seventy-two hours from the time it is removed from refrigeration.
- (3) Subsection (1) does not prevent an operator of a transfer service from transporting a dead human body from the place removal was first requested to a temporary holding facility used by the transfer service for that purpose. O. Reg. 368/90, s. 13.
14. The registers maintained under subsection 2 (3) of the Act shall include,
- (a) the names of the funeral directors responsible for the management of each funeral establishment and the names of the persons responsible for the management of each transfer service;
- (b) the name and address of any person having a beneficial interest in the operation of the business of the licensee; and
- (c) if the operator of a funeral establishment or transfer service is a corporation, the names and addresses of the officers and directors of the corporation and persons holding more than 10 per cent of the equity shares of the corporation or an officer or director of that person. O. Reg. 368/90, s. 14.
- 15.—(1) Every operator of a funeral establishment or transfer service shall maintain books, records and accounts at the place of business, in which shall be recorded,
- (a) all money received under a contract for the purchase of funeral services or supplies or transfer services;
- (b) all money disbursed in accordance with the terms of a contract for the purchase of funeral services or supplies or transfer services; and

- (c) all other money received or disbursed in connection with its business.
- (2) If the operator of a funeral establishment or transfer service has more than one place of business, separate books, records and accounts shall be maintained with respect to all money received or disbursed under clauses (1) (a) and (b) at each place of business.
- (3) The books, records and accounts to be kept at each place of business shall include,
- a book or other permanent accounting record showing all receipts and disbursements of money;
 - all bank statements, pass books and cashed cheques for any account maintained in connection with the operation of the business of the licensee;
 - detailed duplicate deposit slips respecting the deposit of funds received as payment for the sale of funeral services or supplies or transfer services on which is recorded the serial number of the receipt or invoice issued or such other reference as will readily identify the transaction to which the deposit relates; and
 - copies of all receipts or invoices issued in connection with the sale of funeral services or supplies or transfer services kept in numerical, alphabetical, chronological or other systematic order.
- (4) The books, records and accounts required to be kept under this section shall be retained for a period of ten years from the date of providing the funeral services or supplies or transfer services, or from the date of the cancellation of a contract.
- (5) The records under this section may be kept electronically or by using a magnetic medium if a written document can be readily produced and it is in an easily understandable form. O. Reg. 368/90, s. 15.
- 16.—(1) Every operator of a funeral establishment or transfer service shall invest prepayment funds or shall dispatch such funds for investment by registered mail within five business days of their receipt.
- (2) Every operator of a funeral establishment or transfer service shall retain the registered mail receipt until written acknowledgment of the receipt of the funds is received from the investment institution.
- (3) If prepayment funds are to be deposited before their investment, the deposit shall be made to the Funeral Directors and Establishments Act Trust Account described in section 18. O. Reg. 368/90, s. 16.
- 17.—(1) An operator of a funeral establishment may accept prepayment funds only through a funeral director or the funeral director's authorized delegate.
- (2) An operator of a transfer service may accept prepayment funds only through the person responsible for the management of the transfer service or that person's authorized delegate.
- (3) A delegate's authority to accept prepayment funds shall expressly set out the necessity of the delegation and shall state whether or not the delegate is an employee of the operator of the funeral establishment or transfer service.
- (4) A delegate's authority to accept prepayment funds shall be in writing and a copy of the delegation of authority shall be given to the Registrar. O. Reg. 368/90, s. 17.
- 18.—(1) Every operator of a funeral establishment or transfer service that deposits prepayment funds before their investment shall maintain a separate trust account in a branch of a depository located

in Ontario which shall be designated as the "Funeral Directors and Establishments Act Trust Account".

(2) No operator of a funeral establishment or transfer service shall maintain more than one account designated as the Funeral Directors and Establishments Act Trust Account. O. Reg. 368/90, s. 18.

19. Every operator of a funeral establishment or transfer service that receives prepayment funds shall maintain a register or ledger located on its premises in which shall be entered,

- the date of the contract;
- the name and address of the person with whom the contract was made;
- the name, address, age and when known, the place and date of death of the beneficiary;
- the date on which the contract is fully performed, or cancelled; and
- the details of the prepayment funds invested or deposited under section 16. O. Reg. 368/90, s. 19.

20.—(1) Every operator of a funeral establishment or transfer service shall invest prepayment funds and keep them re-invested in Ontario directly or through a fraternal society licensed under the *Insurance Act* that accepts prepayment funds in,

- an interest-bearing savings account at a depository; or
- deposit notes, deposit receipts, certificates of deposit, guaranteed investment certificates, term deposits or other similar instruments of a depository.

(2) Every investment shall be made and kept in the name of the licensed operator of a funeral establishment or transfer service in trust for the individual purchaser from whom the prepayment funds were received.

(3) In respect of investments made in the name of a funeral director in trust for purchasers before the 1st day of October, 1990, each funeral director shall, as soon as practicable, transfer these investments to the name of the licensed operator of the funeral establishment with which the funeral director is associated.

(4) A funeral director is not required to notify the purchaser of a transfer under subsection (3).

(5) No other money shall be included with the investment of prepayment funds. O. Reg. 368/90, s. 20.

21. Within ten days after the investment of prepayment funds, the operator of a funeral establishment or transfer service shall deliver to the purchaser the original or a copy of the investment receipt provided by the depository or fraternal society. O. Reg. 368/90, s. 21.

22.—(1) An operator of a funeral establishment or transfer service shall not disburse or withdraw any prepayment funds until,

- proof of the beneficiary's death is received and payment is to be made to the person providing the funeral services or supplies or transfer services for which the prepayment funds were received;
- proof of the beneficiary's death is received and the funeral establishment or transfer service itself provides the funeral services or supplies or transfer services for which the prepayment funds were received;
- written cancellation of the contract is received; or

(d) the prepayment funds are re-invested in accordance with section 20.

(2) A prepaid contract shall be deemed cancelled if the licensee has reasonable grounds to believe that the beneficiary has or would have reached the age of 120 years and the licensee is unable to determine that the beneficiary is alive. O. Reg. 368/90, s. 22.

23.—(1) Every operator of a funeral establishment or transfer service shall, at the request of the purchaser, inform the purchaser of the accumulated value of the prepayment funds, the name of the depository and the form in which the prepayment funds are invested.

(2) The information under subsection (1) need not be provided more than once a year. O. Reg. 368/90, s. 23.

24. If requested in writing by the Registrar, every operator of a funeral establishment or transfer service shall account within thirty days for all prepayment funds received from a purchaser. O. Reg. 368/90, s. 24.

25.—(1) Within three months after its fiscal year end, every operator of a funeral establishment or transfer service shall have an audited report prepared by a public accountant licensed under the *Public Accountancy Act* with respect to all prepayment funds invested in the fiscal year.

(2) The audited report shall be accompanied by a statement of the auditor as to whether or not, in the auditor's opinion, the prepayment funds are being held and dealt with in accordance with sections 20 and 22.

(3) The report and statement shall be submitted to the Registrar within four months after the fiscal year end of the operator. O. Reg. 368/90, s. 25.

26. Every operator of a funeral establishment offering services to the public and every operator of a transfer service shall make available and shall, upon request, provide an inexpensive transfer service. O. Reg. 368/90, s. 26.

27.—(1) A person who owns, operates or has direct control of a funeral establishment or transfer service shall not own, operate or have direct control of a cemetery or crematorium.

(2) A person who is on the board of directors of the operator of a funeral establishment or transfer service shall not be on the board of directors of the owner of a cemetery or crematorium.

(3) No employee of an operator of a funeral establishment or transfer service shall also be an employee of an owner of a cemetery or crematorium.

(4) Nothing in this section prevents a person from serving as an unpaid volunteer board member in respect of a cemetery operated on a non-profit basis. O. Reg. 368/90, s. 27.

28.—(1) If the operator of a funeral establishment or transfer service carries on business under a name or style other than its corporate name,

- (a) the corporate name shall be clearly disclosed to the public on the licensee's letterhead, contracts, price lists, brochures and business signs; and
- (b) a notice shall be posted in a conspicuous place on the premises indicating the corporate name and listing, by name, every other funeral establishment or transfer service that the corporation operates within a 170 kilometre radius.

(2) Clause (1) (a) does not apply in respect of business signs until the 1st day of October, 1991. O. Reg. 368/90, s. 28.

29.—(1) Notice shall be given by the operator of a funeral establishment or transfer service to all persons who have entered into pre-

paid contracts for funeral services or supplies or transfer services of the following changes:

1. A person acquires directly or indirectly 25 per cent or more of the shares of the licensee.
2. There is a change with regard to any person having a beneficial interest in the business of the licensee.
3. There is a sale of the assets of a licensee to a new licensee.
4. A licence is terminated, revoked, voluntarily surrendered or expires.

(2) The notice shall include notice of the right to cancel the contract.

(3) The notice shall be given within thirty days of the change occurring. O. Reg. 368/90, s. 29.

30.—(1) If a dead human body is cremated and the cremated remains are not claimed, the funeral director or the operator of a transfer service having possession of the cremated remains shall retain them for a period of not less than one year from the date of cremation.

(2) If the cremated remains are not claimed within the one-year period, the funeral director or transfer service operator may bury them in a common ground burial site.

(3) The funeral director or transfer service operator shall maintain records of all burials made under subsection (2).

(4) Subsections (1) to (3) apply to cremated remains in existence on the 1st day of October, 1990.

(5) At the time a contract for funeral services or supplies or transfer services involving cremation is entered into, the funeral director or transfer service operator shall disclose the requirements set out in subsections (1) to (3).

(6) The maximum refundable deposit that may be required toward the price of unclaimed cremated remains is \$150. O. Reg. 368/90, s. 30.

31.—(1) It is a condition of a funeral director's licence that the funeral director attends, at least once every five years, a professional development course of instruction in topics related to funeral services conducted or approved by the Board.

(2) The Registrar shall keep a record of every course of professional development attended by each funeral director.

(3) A funeral director who is unable to attend a course as required by subsection (1) may upon filing proof of extraordinary circumstances be granted an extension of time by the Board in which to comply with subsection (1).

(4) Subsection (1) does not apply to a licensed funeral director who is not actively engaged in providing or directing the provision of funeral services in the Province of Ontario.

(5) A funeral director who is not actively engaged as such in the Province of Ontario for a period of less than ten consecutive years shall, immediately upon becoming actively engaged, take the first available course referred to in subsection (1).

(6) A funeral director who is not actively engaged as such in the Province of Ontario for a period of ten or more consecutive years shall take and pass the licensing examination set or approved by the Board before becoming actively engaged as a funeral director. O. Reg. 368/90, s. 31.

32. A licensee shall not provide a container or casket for cremation which is prohibited by or which is incapable of being made to

comply with the regulations made under the *Cemeteries Act*. O. Reg. 368/90, s. 32.

33.—(1) Every contract signed on behalf of a funeral establishment shall be signed by a funeral director or the funeral director's authorized delegate.

(2) Every contract signed on behalf of a transfer service shall be signed by the person responsible for the management of the transfer service or that person's authorized delegate.

(3) A delegate's authority to sign a contract shall expressly set out the necessity of the delegation and shall state whether or not the delegate is an employee of the operator of the funeral establishment or transfer service.

(4) A delegate's authority to sign contracts shall be in writing and a copy of the delegation of authority shall be given to the Registrar. O. Reg. 368/90, s. 33.

34. Every contract executed for the delivery of funeral services or supplies or transfer services shall be signed by the parties to the contract as soon as practicable after an agreement has been reached and, in any event, before the delivery of all agreed upon funeral services or supplies or transfer services. O. Reg. 368/90, s. 34.

35. The operator of a transfer service shall, before the execution of a contract with a purchaser, inform the purchaser,

- (a) that it cannot be present at or participate in the conduct of a funeral;
- (b) that it cannot be present at or conduct a visitation; and
- (c) that it cannot transport a dead human body except in accordance with section 13. O. Reg. 368/90, s. 35.

36. Every operator of a funeral establishment offering services to the public and every operator of a transfer service shall ensure that every contract includes,

- (a) the date the contract was made;
- (b) the full name and address of the purchaser;
- (c) the name and address of the funeral establishment or the transfer service;
- (d) the full name and address of the beneficiary;
- (e) an itemized list of the funeral services or supplies or transfer services to be provided, including the price and description of each;
- (f) specific instructions for embalming if embalming is to be performed;
- (g) the amount of money received and, if determinable, the total price of the contract; and
- (h) the details of the payments for the unpaid balance of the contract, including the interest charges and any reduction for prompt payment. O. Reg. 368/90, s. 36.

37. Every contract shall be made at least in duplicate and one copy shall be delivered to the purchaser. O. Reg. 368/90, s. 37.

38. Every prepaid contract shall include, in addition to the information required under section 36,

- (a) a serial or other unique identifying number;
- (b) the date and place of birth of the beneficiary, if known;
- (c) a statement indicating whether or not the funeral establish-

ment or transfer service guarantees to fulfil the contract at a fixed price, exclusive of any taxes or charges imposed by the provincial or federal government, and,

- (i) if so, a statement indicating what that price is, whether or not payment has been made in full, the amount already paid by the purchaser, and the schedule of payment instalments to be made by the purchaser, or
 - (ii) if not, a statement indicating how the full payment will be calculated, inclusive of all borrowing and other charges, the amount already paid by the purchaser, and the schedule of payment instalments to be made by the purchaser;
- (d) a statement setting out the obligations under section 21;
 - (e) a statement advising that,
 - (i) the purchaser may cancel the contract at any time and is entitled to receive the money paid under the contract and all income accrued thereon except, if the contract is cancelled after thirty days, the fee that may be deducted under subsection 39 (1),
 - (ii) if the prepayment funds are in excess of the cost of delivering the services or supplies contracted for, the balance will be paid to the beneficiary's estate, and
 - (iii) the purchaser is entitled to know, on an annual basis, the accumulated value of the prepayment funds, the name of the depository and the form in which the prepayment funds are invested, if the purchaser requests such information; and
 - (f) a statement explaining the circumstances of substitution without increase of cost and details of the requirements of subsection 40 (2). O. Reg. 368/90, s. 38.

39.—(1) The fees that may be deducted from the amount paid when a prepaid contract is cancelled after thirty days is 10 per cent of the prepayment funds to a maximum of \$200.

(2) The prescribed interest rate under subsection 36 (2) of the Act is the higher of,

- (a) the interest rate actually received on the money; and
- (b) the interest rate which would have been received had the same amount of money been invested continuously in Canada Savings Bonds. O. Reg. 368/90, s. 39.

40.—(1) The operator of a funeral establishment or transfer service may, without the consent of the purchaser or the personal representative, subcontract a clearly defined portion, but not all, of the services or supplies contracted for.

(2) If the operator of a funeral establishment or transfer service must substitute goods or services agreed to under a contract, it shall inform the purchaser or the representatives of the beneficiary of the substitution and the purchaser or representative may cancel that part of the contract. O. Reg. 368/90, s. 40.

41.—(1) Every operator of a funeral establishment offering services to the public shall make available to the public an up-to-date list of the funeral services, funeral supplies and transfer services it generally offers and their corresponding prices.

(2) The list referred to in subsection (1) shall include,

- (a) the price of professional and staff services;
- (b) the price of embalming or other preparations of the remains of the deceased person;

- (c) the price of the use of facilities for visitations or services;
 - (d) the price for the use of facilities for the embalming or the shelter of the remains of the deceased person, including the cost of refrigeration;
 - (e) the price of the transfer of the remains of the deceased person;
 - (f) the price for the use of a funeral coach;
 - (g) the price for the use of a clergy or lead car;
 - (h) the price for use of any automobiles in addition to those referred to in clauses (f) and (g);
 - (i) the price of funeral services and supplies and transfer services offered as a package, indicating each item included in the package; and
 - (j) the price of completing or obtaining any necessary forms or documents.
- (3) Every operator of a funeral establishment offering services to the public shall maintain an up-to-date list of the caskets, containers, outer burial containers and urns that are generally offered for sale in the funeral establishment.
- (4) The list referred to in subsection (3) shall give the name, a brief description and the price of each casket, container, outer burial container and urn, including the manufacturer's name, if available, and any model number.
- (5) The lists referred to in subsections (1) and (3) shall clearly state the effective date of the list and the name and address of the funeral establishment, including the name of the licensee of the funeral establishment and the name of the funeral director who manages and supervises the establishment.
- (6) Every operator of a funeral establishment offering services to the public shall, before a potential purchaser selects funeral services, supplies or transfer services, offer to that purchaser a copy of the lists referred to in subsections (1) and (3).
- (7) Copies of the printed lists or a notice stating that a price list is available without charge or obligation shall be located in a conspicuous place near the main entrance of the funeral establishment offering services to the public and shall be available to be picked up by any person entering the premises.
- (8) Every operator of a funeral establishment offering services to the public shall provide, without cost, a copy of the lists referred to in subsections (1) and (3) to every person who requests the list or any information contained in the list.
- (9) Prices on the lists shall be expressed as a fixed charge, an hourly rate, a rate per kilometre or other unit of compensation. O. Reg. 368/90, s. 41.
- 42.—(1) Every operator of a transfer service shall make available to the public an up-to-date list of the transfer services and funeral supplies it generally offers and their corresponding prices.
- (2) The list referred to in subsection (1) shall include,
- (a) the price of staff services;
 - (b) the price of the transfer of the remains of the deceased person;
 - (c) the price for the use of facilities for sheltering the remains of the deceased person;
 - (d) the price for use of any automobiles;
 - (e) the price of transfer services and funeral supplies offered as a package, indicating each item included in the package; and
 - (f) the price of completing or obtaining any necessary forms or documents.
- (3) Every operator of a transfer service shall maintain an up-to-date list of the casket described in subsection 11 (3), containers, outer burial containers and urns that it generally offers for sale.
- (4) The list referred to in subsection (3) shall give the name, a brief description and the price of the casket described in subsection 11 (3) and each container, outer burial container and urn, including the manufacturer's name, if available, and any model number.
- (5) The lists referred to in subsections (1) and (3) shall clearly state the effective date of the list and the name and address of the transfer service, including the name of the licensee of the transfer service and the name of the manager of the transfer service.
- (6) Every operator of a transfer service shall, before a potential purchaser selects transfer services or funeral supplies, offer to that purchaser, a copy of the lists referred to in subsections (1) and (3).
- (7) Copies of the printed lists or a notice stating that a price list is available without charge or obligation shall be located in a conspicuous place near the main entrance of the premises of the transfer service and shall be available to be picked up by any person entering the premises.
- (8) Every operator of a transfer service shall provide, without cost, a copy of the lists referred to in subsections (1) and (3) to every person who requests the list or any information contained in the list.
- (9) Prices on the lists shall be expressed as a fixed charge, an hourly rate, a rate per kilometre or other unit of compensation. O. Reg. 368/90, s. 42.
43. Price lists referred to in sections 41 and 42 shall be retained for a period of ten years from the date they were last in effect. O. Reg. 368/90, s. 43.
44. For the purposes of the Act, professional misconduct of a funeral director includes,
- (a) an act or omission inconsistent with the Act or the regulations;
 - (b) failing to respect the confidentiality of information concerning a client except with the consent of the client or the client's personal representative unless required to do so by law;
 - (c) charging fees that are excessive in relation to the funeral services, funeral supplies or transfer services requested, performed or provided;
 - (d) submitting a false or misleading account;
 - (e) making or promising any benefit to a third party for procuring patronage;
 - (f) accepting any commission or benefit without full disclosure, including a benefit to which a third party may be entitled;
 - (g) charging fees for funeral supplies not purchased from the funeral establishment;
 - (h) submitting an account before making a contract in accordance with the regulations;
 - (i) charging interest on an account without notifying the client of the terms of interest before making a contract, excluding interest granted by the judgment of a court;

- (j) selling or attempting to sell an account to a third party within thirty days of signing a contract for that account, except upon the sale of the funeral establishment and excluding an agent retained to collect unpaid accounts;
- (k) failing to carry out the terms of a contract;
- (l) counselling or assisting any person to contravene the Act or the regulations;
- (m) acting or holding out as a funeral director using any name other than the name of the licensee that is entered in the register;
- (n) being the manager of a funeral establishment that operates or holds out as a funeral establishment using any name other than the name of the licensee that is entered in the register;
- (o) signing or issuing a certificate, report or other document that contains a statement the licensee knows or ought to know is false, misleading or otherwise improper;
- (p) requiring, without reasonable grounds, that a person purchase specific funeral services, funeral supplies or transfer services as a condition of obtaining funeral services, funeral supplies or transfer services;
- (q) refusing services to any person, except where a funeral director has reasonable grounds to refuse the services and is willing to provide a reasonable alternative;
- (r) embalming a body without specific instructions from the purchaser of the service or the beneficiary's personal representative;
- (s) failing to reply within a reasonable time to a written inquiry received from the Registrar;
- (t) engaging in the practice of funeral directing while impaired by alcohol or a drug; and
- (u) acting in a manner relevant to the practice of funeral directing that, having regard to the circumstances, would reasonably be regarded as unprofessional conduct. O. Reg. 368/90, s. 44.
45. It is a condition of a licence to operate a transfer service that the operator,
- (a) respects the confidentiality of any information concerning a client except with the consent of the client or the client's personal representative unless required to do so by law;
- (b) does not charge fees that are excessive in relation to the services or funeral supplies requested, performed or provided;
- (c) does not submit a false or misleading account;
- (d) does not make or promise any benefit to a third party for procuring patronage;
- (e) does not accept any commission or benefit without full disclosure, including a benefit to which a third party may be entitled;
- (f) does not charge fees for funeral supplies not purchased from the transfer service;
- (g) does not submit an account before making a contract in accordance with the regulations;
- (h) does not charge interest on an account without notifying the client of the terms of interest before making a contract, excluding interest granted by a judgment of a court;
- (i) does not sell or attempt to sell an account to a third party within thirty days of signing a contract for that account, except upon the sale of the transfer service and excluding an agent retained to collect unpaid accounts;
- (j) carries out the terms of a contract;
- (k) does not counsel or assist any person to contravene the Act or the regulations;
- (l) does not operate or hold out the transfer service under any name other than the name of the licensee that is entered in the register;
- (m) does not sign or issue a certificate, report or other document that contains a statement the licensee knows or ought to know is false, misleading or otherwise improper;
- (n) does not require, without reasonable grounds, that a person purchase specific services or funeral supplies as a condition of obtaining services or funeral supplies;
- (o) does not refuse services or funeral supplies to any person, except where a transfer service has reasonable grounds to refuse the services or funeral supplies and is willing to provide a reasonable alternative;
- (p) replies within a reasonable time to a written inquiry received from the Registrar;
- (q) does not operate a transfer service while impaired by alcohol or a drug; and
- (r) does not act in a manner relevant to the provision of transfer services that, having regard to the circumstances, would reasonably be regarded as disgraceful or inconsistent with fair business practice. O. Reg. 368/90, s. 45.
- 46.—(1) A person applying for in-service training shall file with the Registrar within ninety days of successful completion of a program in funeral service education authorized by the Board,
- (a) a completed application;
- (b) proof that the applicant has successfully completed a program of funeral service education;
- (c) separate certificates of good character from two persons, excluding relatives, who have known the applicant for a period of at least five years;
- (d) an agreement of in-service training between the student and a funeral director; and
- (e) a photograph of the applicant taken within the last twelve months.
- (2) An applicant who complies with subsection (1) shall be issued a certificate of authorization by the Board. O. Reg. 368/90, s. 46.
- 47.—(1) Subject to subsection (2), a certificate of authorization shall be withdrawn if the student fails to pass the first examination set by the Board following the receipt of the certificate and fails, within thirty days of being notified of the failure, to apply to retry the examination set by the Board at the next available sitting.
- (2) If proof is submitted to the Board that the student failed the examination due to illness or a death in the student's family, the Board may direct that the certificate of authorization not be withdrawn. O. Reg. 368/90, s. 47.
48. If the certificate of authorization is withdrawn by the Board, the agreement of in-service training between the funeral director and the student is void and the Board shall so notify the funeral director. O. Reg. 368/90, s. 48.

49.—(1) The period of in-service training of a student shall be not less than twelve months and not more than the maximum period allowed under clause 3 (1) (c) for passing the licensing examination.

(2) During the term of the in-service training a student shall be employed only by the funeral director with whom the student is being trained, except with the written consent of the funeral director and the Board.

(3) The period of in-service training of a student shall be calculated from the date of the certificate of authorization. O. Reg. 368/90, s. 49.

50. If a student wishes to transfer an agreement of in-service training from one funeral director to another funeral director the student shall file with the Registrar, at least fifteen days before the transfer, a notice of change, a statement as to the length and nature of the in-service training completed and a copy of the new agreement for in-service training. O. Reg. 368/90, s. 50.

51.—(1) Subject to subsection (2), a funeral director shall provide in-service training to only one student at a time.

(2) If a funeral establishment has two or more funeral directors regularly employed, it may provide in-service training to two students and, with the permission of the Board, to more than two students.

(3) A funeral director shall ensure that a student receiving in-service training is trained in all aspects of the profession.

(4) A funeral director with whom a student is employed shall furnish to the student, upon completion or assignment of the in-service agreement, a statement as to the length and nature of the in-service training. O. Reg. 368/90, s. 51.

52.—(1) The agreement of in-service training between a funeral director and a student is cancelled if the funeral director,

- (a) is absent from Ontario for more than ninety consecutive days;
- (b) becomes bankrupt, or takes the benefit of any Act for the relief of insolvent debtors; or
- (c) ceases to operate a funeral establishment.

(2) If a funeral director with whom a student is employed dies or the agreement of in-service training is cancelled, the student may file with the Registrar within sixty days thereof an application for authorization to receive in-service training with another funeral director together with a statement as to the length and nature of the in-service training under the original authorization.

(3) The Board may dispense with the filing of the statement of in-service training if it is impractical or impossible for the student to obtain the statement.

(4) If a student fails to file an application under subsection (2) within the required time, the student's certificate of authorization may be withdrawn by the Board. O. Reg. 368/90, s. 52.

53.—(1) An operator of a funeral establishment or transfer service shall not include on any sign on the premises of the funeral establishment or transfer service the name or photograph of any person not licensed under the Act.

(2) An operator of a funeral establishment or transfer service shall not include in any advertisement a reference to price or condi-

tions of sale or price or description of services unless the services and supplies to which the prices apply are clearly set out.

(3) All advertisements shall be filed with the Board before being released to the public. O. Reg. 368/90, s. 53.

54. A family conducting a funeral or supplying funeral services with respect to one of its members, excluding embalming, is exempt from the Act and this Regulation. O. Reg. 368/90, s. 54.

Schedule

FEES

1. Application for a funeral director's licence	\$ 75.00
2. Renewal of funeral director's licence	75.00
3. Renewal of funeral director's licence if application filed after the expiry of the previous licence	150.00
4. Application for a licence to operate a funeral establishment	100.00
5. Renewal of a licence to operate a funeral establishment not offering services to the public	200.00
6. Renewal of a licence to operate a funeral establishment offering services to the public (amount payable for each death registered for which payment was required for services or supplies provided during the twelve-month period ending on the 31st day of October preceding the expiry of the licence)	7.00 per death registered
7. Renewal of a licence to operate a funeral establishment if application is filed after the expiry of the licence (in addition to the amounts under paragraph 5 or 6)	200.00
8. Application for a licence to operate a transfer service	50.00
9. Renewal of a licence to operate a transfer service (amount payable for each death registered for which payment was required for services or supplies provided during the twelve-month period ending on the 31st day of October preceding the expiry of the licence)	7.00 per death registered
10. Renewal of a licence to operate a transfer service if application filed after the expiry of the licence (in addition to the amount under paragraph 9)	100.00
11. Application for in-service training	50.00
12. Application to take funeral director's examination	150.00
13. Application to retry funeral director's examination	50.00
14. Application to take transfer service operator's examination	75.00
15. Application to retry transfer service operator's examination	25.00

O. Reg. 368/90, Sched.

Fur Farms Act
Loi sur les fermes d'élevage d'animaux à fourrure

REGULATION 471

GENERAL

1.—(1) An application for a licence as an operator of a fur farm shall be made to the Director in Form 1.

(2) A licence as an operator of a fur farm shall be in Form 2.

(3) The fee for a licence in Form 2 is \$10.

(4) Except as otherwise provided therein, a licence in Form 2 expires with the last day of February next following the date on which it becomes effective.

(5) A licence in Form 2 is not transferable. R.R.O. 1980, Reg. 400, s. 1.

2.—(1) Subject to subsection (2), an operator of a fur farm shall, prior to the 15th day of February in every year, submit to the Director a Fur Farm Report in Form 3.

(2) A person who ceases to be the operator of a fur farm shall surrender the person's licence and submit the Fur Farm Report to the Director within ten days after the date on which the person ceases to be the operator of the fur farm. R.R.O. 1980, Reg. 400, s. 2.

3. An operator of a fur farm shall make and keep records containing such details of the operator's operation as are required for the completion of the Fur Farm Report in Form 3. R.R.O. 1980, Reg. 400, s. 3.

4.—(1) A permit,

(a) to take or ship, or cause to be taken or shipped, from a fur farm to a point outside Ontario;

(b) to take or ship, or cause to be taken or shipped, from a fur farm to a point within Ontario; or

(c) to send, or cause to be sent, from a fur farm to a tanner or taxidermist for tanning, plucking or treating in any way,

a fur-bearing animal or pelt shall be in Form 4.

(2) A permit in Form 4 expires with the seventh day after the date on which it is issued. R.R.O. 1980, Reg. 400, s. 4.

5. The following animals are declared to be fur-bearing animals for the purposes of the Act:

1. Lynx.

2. The species Nyctereutes procyonoides, commonly known as Finn-raccoon. R.R.O. 1980, Reg. 400, s. 5; O. Reg. 321/81, s. 1.

Form 1

Fur Farms Act

APPLICATION FOR LICENCE AS AN OPERATOR OF A FUR FARM

To: The Director
under the Fur Farms Act
Ministry of Agriculture and Food

(name of corporation, partnership or person)

(address)

applies for a licence as an operator of a fur farm under the Fur Farms Act and the regulations and, in support of this application, the following facts are stated:

A. TO BE COMPLETED BY ALL APPLICANTS

1. Name of fur farm:

2. Location of fur farm: Lot No.

Concession No. Township

County or District

3. Applicant is: Owner () tenant () of land.

4. Name of manager of fur farm Telephone No.

5. Licence No. for previous year:

6. If partnership, names of partners:

7. Number, species and genetic type of fur-bearing animals in pens on January 1st or as otherwise stated:

NUMBER	SPECIES	GENETIC TYPE
.....
.....

B. TO BE COMPLETED BY APPLICANT NOT LICENSED FOR PREVIOUS YEAR:

- 1. How were fur-bearing animals obtained?
- 2. If fur-bearing animals were trapped in the wild state by applicant and transferred to the fur farm, was written authority obtained under section 67 of the *Game and Fish Act*?
- 3. Particulars of purchases of fur-bearing animals:

DATE			VENDOR		DESCRIPTION		
Day	Month	Year	Name	Address	No.	Species	Genetic Type
.....
.....

4. Were fur-bearing animals kept on your premises since date of purchase?
If not, give particulars of owners of premises where they were kept:

Name	Address
.....
.....

(signature)

(title)

Dated at, this day of, 19.....

R.R.O. 1980, Reg. 400, Form 1.

Form 2

Fur Farms Act

LICENCE AS AN OPERATOR OF A FUR FARM

LICENCE NO.

Under the *Fur Farms Act* and the regulations, and subject to the limitations thereof, this licence is issued to:

(name)

(address)

to be the operator of a fur farm on premises known as
(name of fur farm)

This licence becomes effective on the day of, 19, and expires with the day of February, 19.....

Dated at, this day of, 19.....

.....
Director under the *Fur Farms Act*

R.R.O. 1980, Reg. 400, Form 2.

Form 3

Fur Farms Act

FUR FARM REPORT

This report is made under the *Fur Farms Act* and the regulations for
(name of fur farm)

for the period from January 1st to December 31st, 19.....

Name of Operator

Address Licence No.

Species	<u>1. Animals on hand</u> (including boarders) at the beginning of period:	<u>2. Live animals received during period:</u>	
	(a)	Purchased or received by trade:	Born on farm during period:
.....
.....

Species	<u>3. Live Animals Removed or Disposed of During Period:</u>			<u>4. Animals on hand</u> (including boarders) at end of period:
	Sold or Traded (d)	Killed for Pelts or Died and Pelted (e)	Died (Not Pelted) or Escaped (f)	(g)
.....
.....

5. Details of Purchases (live animals):
(as shown in column b)

Day	<u>Date</u>		<u>Vendor</u>		No.	Species	Genetic Type
	Month	Year	Name	Address			
.....
.....

6. Details of Sales (live animals):
(as shown in column d)

Day	<u>Date</u>		<u>Purchaser</u>		No.	Species	Genetic Type	Permit No.
	Month	Year	Name	Address				
.....
.....

7. Details of Boarders:

Name	<u>Owner</u>		No.	Species
	Address		
.....
.....

8. Details of Animal Deaths:

<u>Month of Death</u>	<u>Cause of Death (if known)</u>	<u>No.</u>	<u>Species</u>
.....
.....

9. Raw Furs Sold or Disposed of During Period:
(including pelts shipped, whether sold or not)

<u>Day</u>	<u>Date Month</u>	<u>Year</u>	<u>Sold or Shipped To</u>	<u>No.</u>	<u>Species</u>	<u>Permit No.</u>
.....
.....

10. Type of Pelts Taken From Mink During Period:

<u>Description of Colour Type</u>	<u>No.</u>
.....
.....
.....
TOTAL PELTS	

.....
(signature)

.....
(title)

Dated at, this day of, 19.....

R.R.O. 1980, Reg. 400, Form 3.

Form 4

Fur Farms Act

FUR FARM OPERATOR'S PERMIT FOR EXPORT OR TRANSPORTATION

19..... PERMIT NO.

Under the *Fur Farms Act* and the regulations, and subject to the limitations thereof, this permit is issued to
(name)

of, the holder of Licence No. as an operator of a fur farm,
(address)

*strike out if not applicable *(a) to take or ship, or cause to be taken or shipped, from the operator's fur farm to a point outside Ontario;

OR

*strike out if not applicable *(b) to take or ship, or cause to be taken or shipped, from the operator's fur farm to a point within Ontario;

OR

*strike out if not applicable *(c) to send, or cause to be sent, from the operator's fur farm to a tanner or taxidermist,

the following fur-bearing animals or pelts:

<u>SPECIES</u>	<u>NO. OF LIVE ANIMALS</u>	<u>NO. OF PELTS</u>
.....
.....

Name of Carrier:

Name and Address of Consignee, Tanner or Taxidermist:

.....
(name) (address)

This permit expires with the seventh day after the date on which it is issued.

.....
Director under the *Fur Farms Act*

Date of Issue:

Signature of Operator of Fur Farm:

Way-bill No.: Date: Place:

Signature of Carrier's Agent:

R.R.O. 1980, Reg. 400, Form 4.

Game and Fish Act
Loi sur la chasse et la pêche

REGULATION 472

AMPHIBIANS

1. The following species and subspecies of Amphibia are declared to be amphibians:

1. *Rana catesbeiana* Shaw, commonly known as bullfrog.
 2. *Bufo woodhousii fowleri* Hinckley, commonly known as Fowler's toad.
 3. *Acris crepitans blanchardi* Harper, commonly known as Blanchard's cricket frog.
 4. *Desmognathus fuscus fuscus* (Green), commonly known as northern dusky salamander. O. Reg. 264/90, s. 1.
-

REGULATION 473

**ANIMALS DECLARED TO BE FUR-BEARING
ANIMALS**

1. The following animals are declared to be fur-bearing animals:

1. *Taxidea taxus*, commonly known as badger.
 2. *Lynx rufus*, commonly known as bobcat.
 3. *Bison americanus*, commonly known as buffalo.
 4. *Canis lupus L.*, commonly known as wolf.
 5. *Canis latrans* Say, commonly known as coyote.
 6. Any hybrid of *Canis lupus L.* and *Canis latrans* Say.
 7. Polar bears.
 8. *Didelphis marsupialis*, commonly known as opossum. R.R.O. 1980, Reg. 401, s. 1; O. Reg. 692/81, s. 1.
-

REGULATION 474

AYLMER HUNTING AREA

1. The lands in respect of which an agreement has been entered into under section 6 of the Act, described in the Schedule, are designated in accordance with paragraph 33 of section 92 of the Act. O. Reg. 29/81, s. 1.

2. Except as provided in this Regulation, no person shall hunt in the area described in the Schedule. O. Reg. 29/81, s. 2.

3. The holder of a licence in Form 5 of Regulation 500 of Revised Regulations of Ontario, 1990, may hunt ducks and geese on any day, except Sunday, Tuesday or Friday, during the open season therefor in any year during the hours between one-half hour before sunrise and twelve o'clock noon, in the area described in the Schedule if,

- (a) the motor vehicle that he or she arrives in at the hunting area is parked in a parking area;
- (b) he or she hunts within an area that is not more than ten metres from a blind supplied by the Ministry of Natural Resources and marked with the number of the parking area wherein the motor vehicle that he or she arrived in is parked;
- (c) the area or blind from which he or she hunts is occupied by not more than one other person; and
- (d) he or she keeps his or her firearm unloaded and encased except while occupying the blind or the area referred to in clause (b). O. Reg. 29/81, s. 3.

4. In this Regulation, a reference to the Schedule is a reference to the Schedule to Ontario Regulation 29/81, as that Schedule read on December 31, 1990. *New*.

REGULATION 475

AYLMER LAGOON HUNTING AREA

1. The lands in respect of which an agreement has been entered into under section 6 of the Act and described in the Schedule are designated in accordance with paragraph 33 of section 92 of the Act. R.R.O. 1980, Reg. 402, s. 1.

2. Except as provided in this Regulation, no person shall hunt any animal or bird in the area described in the Schedule. R.R.O. 1980, Reg. 402, s. 2.

3. The holder of a licence in Form 5 of Regulation 500 of Revised Regulations of Ontario, 1990 may hunt ducks, geese, rails, coots, snipe and gallinules on any day, except Sunday, during the open season therefor in any year during the hours between one-half hour before sunrise and one-half hour after sunset in the area described in the Schedule, upon condition that,

- (a) he or she parks his or her motor vehicle in an area designated as a parking area;
- (b) he or she hunts only within a radius of thirty feet from a blind supplied by the Ministry of Natural Resources and marked with the number of the area in which his or her motor vehicle is parked;
- (c) the area from which he or she hunts is occupied by not more than one other person; and
- (d) he or she keeps his or her firearm unloaded and encased except while occupying a hunting area. R.R.O. 1980, Reg. 402, s. 3.

4. In this Regulation, a reference to the Schedule is a reference to the Schedule to Regulation 402 of Revised Regulations of Ontario, 1980, as that Schedule read on December 31, 1990. *New*.

REGULATION 476**BAG LIMIT FOR BLACK BEAR**

1.—(1) In this Regulation, "hunting in a party" means hunting in a party of two or more persons who have agreed to hunt co-operatively during a period in an area that can reasonably be hunted by such persons during the period so that the intended objective of the hunt can be achieved.

(2) Subsection (1) does not apply to the hunting of moose or deer. R.R.O. 1980, Reg. 403, s. 1.

2. Subject to section 4, black bear may be hunted by a person hunting in a party during the open season therefor in any part of Ontario. R.R.O. 1980, Reg. 403, s. 2.

3. Subject to section 4, no person shall during the open season therefor take or possess more than one black bear under a licence to hunt black bear. R.R.O. 1980, Reg. 403, s. 3.

4. Where two or more persons who each hold a valid licence to hunt black bear are hunting in a party for black bear, any one of such persons may take or possess the number of black bear that is equal to the number of licences to hunt black bear held by the persons in the party, but the total number of black bear taken or possessed by the persons hunting in a party shall not exceed the total number of licences to hunt black bear held by such persons. R.R.O. 1980, Reg. 403, s. 4.

REGULATION 477**BEAVER MEADOW HUNTING AREA**

1. The Crown lands described in the Schedule are designated in accordance with paragraph 33 of section 92 of the Act. O. Reg. 477/85, s. 1.

2. Except as provided in this Regulation, no person shall hunt any animal or bird in the area described in the Schedule. O. Reg. 477/85, s. 2.

3. The holder of a licence in Form 5 of Regulation 500 of Revised Regulations of Ontario, 1990 may hunt ducks, geese, rails, coots and gallinules on a Monday, Wednesday, Friday or Saturday during the open season therefor in any year during the hours between one-half hour before sunrise and one-half hour after sunset in the area described in the Schedule, if,

- (a) the holder's motor vehicle is parked in an area designated as a parking area;
- (b) the holder hunts only from a blind marked by an officer of the Prince Edward Region Conservation Authority with the number of the parking area in which the holder's motor vehicle is parked;
- (c) the blind from which the holder hunts is occupied by not more than one other person;
- (d) the holder keeps his or her firearm unloaded and encased except while occupying the hunting blind; and
- (e) the holder enters and leaves the lands described in the Schedule through the area designated as a parking area. O. Reg. 477/85, s. 3.

4. In this Regulation, a reference to the Schedule is a reference to the Schedule to Ontario Regulation 477/85, as that Schedule read on December 31, 1990. *New.*

REGULATION 478**BLACK BEAR MANAGEMENT AREAS**

1. Part of Ontario is divided into those black bear management areas (BMAs) shown outlined in black on the maps filed in the office of the Director of Wildlife Branch of the Ministry of Natural Resources at Toronto under the numbers in Column 1 of each Schedule and the areas are designated by the initials and numbers in Column 2 of each Schedule identifying the administration district of the Ministry and the wildlife management unit in which they are situated and the area. O. Reg. 348/89, s. 1.

Schedule 1

Abbreviations:

RL for Red Lake

SL for Sioux Lookout

ITEM	COLUMN 1	COLUMN 2
1	21	RL-01C-01
2	21	RL-01C-02
3	21	RL-01C-03
4	21	RL-01C-04
5	22	RL-01C-05
6	22	RL-01C-06
7	21	RL-01C-07
8	21	RL-01C-08
9	21	RL-01C-09
10	30	RL-01C-10
11	22, 30	RL-01C-11
12	30	RL-01C-12
13	30	RL-01C-13
14	30	RL-01C-14
15	22	RL-01C-15
16	22	RL-01C-16
17	31	SL-01C-17
18	23	SL-01C-18
19	23	SL-01C-19
20	23, 24	SL-01C-20
21	31	SL-01C-21
22	32A	SL-01C-22

O. Reg. 348/89, Sched. 1.

Schedule 2

Abbreviations:

KE for Kenora

RL for Red Lake

ITEM	COLUMN 1	COLUMN 2
1	21, 29	RL-02-01
2	29	RL-02-02
3	29	RL-02-03
4	29	RL-02-04
5	29	RL-02-05
6	29	RL-02-06
7	29	RL-02-07
8	29	RL-02-08
9	29	RL-02-09
10	29	RL-02-10
11	29	RL-02-11
12	29	RL-02-12
13	29	RL-02-13

ITEM	COLUMN 1	COLUMN 2
14	29	RL-02-14
15	29	RL-02-15
16	29	RL-02-16
17	29	RL-02-17
18	29, 38A	RL-02-18
19	30	KE-02-19
20	29, 38A	RL-02-20
21	38A	RL-02-21
22	38A	RL-02-22
23	38A	RL-02-23
24	30	RL-02-24
25	30	RL-02-25
26	38B	KE-02-26
27	38B	KE-02-27
28	38B	KE-02-28
29	38B	KE-02-29
30	38B	KE-02-30
31	38B	KE-02-31
32	38B	KE-02-32
33	38B	KE-02-33
34	38B	KE-02-34
35	38B	KE-02-35
36	38B	KE-02-36

O. Reg. 348/89, Sched. 2

Schedule 3

Abbreviations:

KE for Kenora
RL for Red Lake

ITEM	COLUMN 1	COLUMN 2
1	30	RL-03-01
2	30	RL-03-02
3	30	RL-03-03
4	30	RL-03-04
5	29, 30	RL-03-05
6	30	RL-03-06
7	30	RL-03-07
8	30	RL-03-08
9	30	RL-03-09
10	30	RL-03-10
11	30	RL-03-11
12	30	RL-03-12
13	30	RL-03-13
14	30	RL-03-14
15	30	RL-03-15
16	30	RL-03-16
17	30	RL-03-17
18	30	RL-03-18
19	30	RL-03-19
20	29, 30	RL-03-20
21	29	RL-03-21
22	30, 39B	RL-03-22
23	30, 39B	RL-03-23
24	30, 39B	RL-03-24
25	30, 39B	RL-03-25
26	30, 39B	RL-03-26
27	30	RL-03-27
28	30, 39B	RL-03-28

ITEM	COLUMN 1	COLUMN 2
29	30	RL-03-29
30	38A, 39B	RL-03-30
31	39B	RL-03-31
32	39B	RL-03-32
33	39B	RL-03-33
34	38A	RL-03-34
35	38A, 39B	RL-03-35
36	38A	RL-03-36
37	38A	RL-03-37
38	39B	RL-03-38
39	39B	RL-03-39
40	39B	RL-03-40
41	39B	RL-03-41
42	39B	RL-03-42
43	39B	RL-03-43
44	38B	KE-03-44
45	38B	KE-03-45
46	38B	KE-03-46
47	38B	KE-03-47
48	38B	KE-03-48
49	38B	KE-03-49
50	38B	KE-03-50

O. Reg. 348/89, Sched. 3

Schedule 4

Abbreviations:

RL for Red Lake
SL for Sioux Lookout

ITEM	COLUMN 1	COLUMN 2
1	30	RL-04-01
2	30, 39B	RL-04-02
3	30	RL-04-03
4	39B	RL-04-04
5	39B	RL-04-05
6	30, 39B	RL-04-06
7	39B	RL-04-07
8	39B	RL-04-08
9	39B	RL-04-09
10	39B	RL-04-10
11	39B	RL-04-11
12	39B	RL-04-12
13	39B	RL-04-13
14	30	RL-04-15
15	39A	SL-04-17
16	39A	SL-04-18
17	39A	SL-04-19
18	39A	SL-04-20
19	39A, 40A	SL-04-21
20	39A	SL-04-22
21	39A	SL-04-23
22	39A	SL-04-24
23	39A, 40A	SL-04-25
24	39A	SL-04-26
25	39A	SL-04-27
26	39A, 40A	SL-04-28
27	39A, 40A	SL-04-29
28	39A	SL-04-30
29	39A, 40A	SL-04-31

ITEM	COLUMN 1	COLUMN 2
30	30	SL-04-32
31	30	SL-04-33
32	30	SL-04-34
33	40A	SL-04-35
34	40A	SL-04-36
35	40A	SL-04-37
36	40A	SL-04-38
37	40A	SL-04-39
38	40A	SL-04-40
39	40A	SL-04-41
40	40A	SL-04-42
41	40A	SL-04-43
42	40A	SL-04-44
43	40A	SL-04-45
44	40A	SL-04-46
45	40A	SL-04-47
46	40A	SL-04-48
47	40A	SL-04-49
48	40A	SL-04-50

O. Reg. 348/89, Sched. 4.

Schedule 5

Abbreviations:

DR for Dryden

IG for Ignace

KE for Kenora

RL for Red Lake

SL for Sioux Lookout

ITEM	COLUMN 1	COLUMN 2
1	39C	DR-05-01
2	39C	DR-05-02
3	39C	DR-05-03
4	39C	DR-05-04
5	39C	DR-05-05
6	39B	RL-05-08
7	39C, 48A	DR-05-09
8	39C	DR-05-10
9	39C	DR-05-11
10	39C	DR-05-12
11	39C	DR-05-13
12	39C	DR-05-14
13	39C	DR-05-15
14	39C	DR-05-16
15	39C	DR-05-17
16	39C	DR-05-18
17	39C	DR-05-19
18	39C	DR-05-20
19	39C	DR-05-21
20	39C	DR-05-22
21	39C	DR-05-23
22	39C	DR-05-24
23	39C	DR-05-25
24	39C	DR-05-26
25	39C, 48A	DR-05-27
26	39C, 48A	DR-05-28
27	48A	DR-05-29
28	39C, 48A	DR-05-30
29	39C, 48A	DR-05-31

ITEM	COLUMN 1	COLUMN 2
30	39C, 48A	DR-05-32
31	39C	DR-05-33
32	39C	DR-05-34
33	39C	DR-05-35
34	39C	DR-05-36
35	39C	DR-05-37
36	39C	DR-05-38
37	39C	DR-05-39
38	39C	DR-05-40
39	39C	DR-05-41
40	39C	DR-05-42
41	39C	DR-05-43
42	39C	DR-05-44
43	39C	DR-05-45
44	39C	DR-05-46
45	39C	DR-05-47
46	39C	DR-05-48
47	39C	DR-05-49
48	39C	DR-05-50
49	39C	DR-05-51
50	39C	DR-05-52
51	39C	DR-05-53
52	39C	DR-05-54
53	39C	DR-05-55
54	39C, 48A	DR-05-56
55	39C	DR-05-57
56	39C	DR-05-58
57	39C	DR-05-59
58	39C	DR-05-60
59	39C	DR-05-61
60	39C	DR-05-62
61	39C, 48A	DR-05-63
62	39C	SL-05-64
63	48A	DR-05-65
64	48A	DR-05-66
65	48A	DR-05-67
66	48A	DR-05-68
67	48A	DR-05-69
68	48A	DR-05-70
69	48A	DR-05-71
70	38B	KE-05-72
71	38B	KE-05-73
72	39A, 48C	SL-05-74
73	39A, 48C, 49A	SL-05-75
74	48C	SL-05-77
75	48C	SL-05-78
76	48C	SL-05-79
77	48C, 49A	SL-05-80
78	48C	SL-05-81
79	48C	SL-05-82
80	48C	SL-05-83
81	48C	SL-05-84
82	48B	IG-05-86
83	48B	IG-05-87
84	48B	IG-05-88
85	48B, 49B	IG-05-89
86	48B	IG-05-90
87	39B	RL-05-91
88	39B	RL-05-92
89	39B	RL-05-93

ITEM	COLUMN 1	COLUMN 2
90	39B	RL-05-94
91	39B	RL-05-95
92	39B	RL-05-96
93	39B	RL-05-97
94	39B	RL-05-98
95	39A	SL-05-102
96	39A	SL-05-103
97	39A, 40A	SL-05-104
98	39A, 48C	SL-05-105
99	39A, 40A	SL-05-106
100	39A	SL-05-107
101	39A	SL-05-108
102	39A, 40A	SL-05-109
103	39A, 40A	SL-05-110
104	39A, 48C	SL-05-111
105	39A, 40A	SL-05-112
106	39A, 40A, 49A	SL-05-113
107	40A, 49A	SL-05-116
108	40A, 49A	SL-05-117
109	40A, 49A	SL-05-118
110	40A, 49A	SL-05-119
111	40A, 49A	SL-05-120
112	40A, 49A	SL-05-121
113	40A, 49A	SL-05-122
114	49A	SL-05-123
115	49A	SL-05-124
116	49A	SL-05-125
117	49A	SL-05-126
118	40A	SL-05-127
119	40A	SL-05-128
120	40A, 49A	SL-05-129
121	40A	SL-05-130
122	40A	SL-05-131
123	40A	SL-05-132
124	40A	SL-05-133
125	40A	SL-05-134
126	40A	SL-05-135
127	40A	SL-05-136
128	40A	SL-05-137
129	40A	SL-05-138
130	39C	SL-05-139

O. Reg. 348/89, Sched. 5.

Schedule 6

Abbreviations:

DR for Dryden

KE for Kenora

ITEM	COLUMN 1	COLUMN 2
1	38B	KE-06-01
2	38B	KE-06-02
3	38B	KE-06-03
4	38B	KE-06-04
5	38B	KE-06-05
6	38B	KE-06-06
7	38B	KE-06-07
8	38B	KE-06-08
9	38B	KE-06-09
10	38B	KE-06-10

ITEM	COLUMN 1	COLUMN 2
11	38B	KE-06-11
12	38B	KE-06-12
13	38B	KE-06-13
14	38B	KE-06-14
15	38B	KE-06-15
16	38B	KE-06-16
17	38B	KE-06-17
18	38B	KE-06-18
19	38B	KE-06-19
20	38B	KE-06-20
21	38B	KE-06-21
22	38B	KE-06-22
23	38B	KE-06-23
24	38B	KE-06-24
25	38B	KE-06-25
26	38B	KE-06-26
27	38B	KE-06-27
28	38B	KE-06-28
29	38B	KE-06-29
30	38B	KE-06-30
31	38B	KE-06-31
32	39C	DR-06-32
33	39C	DR-06-33
34	39C, 48A	DR-06-34

O. Reg. 348/89, Sched. 6.

Schedule 7

Abbreviations:

KE for Kenora

ITEM	COLUMN 1	COLUMN 2
1	38B	KE-07A-01
2	38B	KE-07A-02
3	38B	KE-07A-03
4	38B	KE-07A-04
5	38B	KE-07A-06
6	38B	KE-07A-07
7	38B	KE-07A-08
8	38B	KE-07A-09
9	38B	KE-07A-10
10	38B	KE-07A-11
11	38B	KE-07A-12
12	38B	KE-07A-13
13	38B	KE-07A-14
14	38B	KE-07A-15
15	38B	KE-07A-16
16	38B	KE-07A-17
17	38B	KE-07A-18
18	38B	KE-07A-19
19	38B	KE-07A-20
20	38B	KE-07A-21
21	38B	KE-07A-22
22	38B	KE-07A-23
23	38B	KE-07A-24
24	38B	KE-07A-25

O. Reg. 348/89, Sched. 7.

Schedule 8

Abbreviations:

DR for Dryden

FF for Fort Frances

KE for Kenora

ITEM	COLUMN 1	COLUMN 2
1	38B	KE-07B-01
2	38B	KE-07B-02
3	38B	KE-07B-03
4	38B	KE-07B-04
5	38B	KE-07B-05
6	38B	KE-07B-06
7	38B	KE-07B-07
8	38B	KE-07B-08
9	38B	KE-07B-09
10	38B	KE-07B-10
11	38B	KE-07B-11
12	38B	KE-07B-12
13	38B	KE-07B-13
14	38B	KE-07B-14
15	38B	KE-07B-15
16	38B	KE-07B-16
17	38B	KE-07B-17
18	38B	KE-07B-18
19	38B	KE-07B-19
20	38B	KE-07B-20
21	38B	KE-07B-21
22	38B	KE-07B-22
23	38B	KE-07B-23
24	38B	KE-07B-24
25	38B	KE-07B-25
26	38B	KE-07B-26
27	38B	KE-07B-27
28	38B	KE-07B-28
29	38B	KE-07B-29
30	38B	KE-07B-30
31	38B	KE-07B-31
32	38B	KE-07B-32
33	38B	KE-07B-33
34	38B	KE-07B-34
35	38B	KE-07B-35
36	38B	KE-07B-36
37	38B	KE-07B-37
38	38B	KE-07B-38
39	38B	KE-07B-39
40	38B	KE-07B-40
41	38B	KE-07B-41
42	38B	KE-07B-42
43	38B	KE-07B-43
44	38B	KE-07B-44
45	38B	KE-07B-45
46	38B	KE-07B-46
47	38B	KE-07B-47
48	38B	KE-07B-48
49	38B	KE-07B-49
50	38B	KE-07B-50
51	38B	KE-07B-51
52	38B	KE-07B-52
53	38B	KE-07B-53
54	38B	KE-07B-54

ITEM	COLUMN 1	COLUMN 2
55	38B	KE-07B-55
56	38B	KE-07B-56
57	38B	KE-07B-57
58	38B	KE-07B-58
59	38B	KE-07B-59
60	38B	KE-07B-60
61	38B	KE-07B-61
62	38B	KE-07B-62
63	38B	KE-07B-63
64	38B	KE-07B-64
65	38B	KE-07B-65
66	38B	KE-07B-66
67	38B	KE-07B-67
68	38B	KE-07B-68
69	38B	KE-07B-69
70	38B	KE-07B-70
71	38B	KE-07B-71
72	38B	KE-07B-72
73	38B	KE-07B-73
74	38B	KE-07B-74
75	38B	KE-07B 75
76	38B	KE-07B-76
77	38B	KE-07B-77
78	38B	KE-07B-78
79	38B	KE-07B-79
80	38B	KE-07B-80
81	38B	KE-07B-81
82	38B	KE-07B-82
83	38B	KE-07B-83
84	38B	KE-07B-84
85	38B	KE-07B-85
86	38B	KE-07B-86
87	38B	KE-07B-87
88	38B	KE-07B-88
89	38B	KE-07B-89
90	38B	FF-07B-90
91	38B	FF-07B-91
92	47	FF-07B-92
93	47	FF-07B-93
94	47	FF-07B-94
95	47	FF-07B-95
96	47, 48B	FF-07B-96
97	48B	FF-07B-97
98	47	FF-07B-98
99	47, 56	FF-07B-99
100	47, 56, 57A	FF-07B-100
101	48A	DR-07B-101
102	48A, 56, 57	DR-07B-102
103	48A	DR-07B-103
104	48A	DR-07B-104
105	48A	DR-07B-105
106	48A	DR-07B-106
107	48A	DR-07B-107
108	47, 56	FF-07B-108
109	47, 56	FF-07B-109
110	56	FF-07B-110
111	48A	DR-07B-111

Schedule 9

Abbreviations:

DR for Dryden
 FF for Fort Frances
 KE for Kenora

ITEM	COLUMN 1	COLUMN 2
1	48A	DR-08-01
2	48A	DR-08-02
3	48A	DR-08-03
4	48A	DR-08-04
5	48A	DR-08-05
6	48A	DR-08-06
7	48A	DR-08-07
8	48A	DR-08-08
9	48A	DR-08-09
10	48A	DR-08-10
11	48A	DR-08-11
12	48A	DR-08-12
13	48A	DR-08-13
14	48A	DR-08-14
15	48A	DR-08-15
16	48A	DR-08-16
17	48A	DR-08-17
18	48A	DR-08-18
19	48A	DR-08-19
20	48A	DR-08-20
21	48A	DR-08-21
22	48A	DR-08-22
23	48A	DR-08-23
24	48A	DR-08-24
25	48A	DR-08-25
26	48A	DR-08-26
27	48A	DR-08-27
28	48A	DR-08-28
29	48A	DR-08-29
30	48A	DR-08-30
31	48A	DR-08-31
32	48A	DR-08-32
33	39C, 48A	DR-08-33
34	48A	DR-08-34
35	39C, 48A	DR-08-35
36	39C, 48A	DR-08-36
37	39C, 48A	DR-08-37
38	39C, 48A	DR-08-38
39	48A	DR-08-39
40	48A	DR-08-40
41	48A	DR-08-41
42	48A	DR-08-42
43	48A	DR-08-43
44	48A	DR-08-44
45	48A	DR-08-45
46	48A	DR-08-46
47	48A	DR-08-47
48	48A	DR-08-48
49	48A	DR-08-49
50	38B	KE-08-51
51	38B	KE-08-52
52	48B	FF-08-53
53	48B	FF-08-54
54	48B	FF-08-55

ITEM	COLUMN 1	COLUMN 2
55	48B	FF-08-56
56	48B	FF-08-57

O. Reg. 348/89, Sched. 9.

Schedule 10

Abbreviations:

DR for Dryden
 FF for Fort Frances
 IG for Ignace
 KE for Kenora

ITEM	COLUMN 1	COLUMN 2
1	38B	KE-09A-01
2	38B	KE-09A-02
3	38B	KE-09A-03
4	38B	KE-09A-04
5	38B	KE-09A-05
6	38B	KE-09A-06
7	38B	KE-09A-07
8	38B	KE-09A-08
9	38B	KE-09A-09
10	38B	KE-09A-10
11	38B	KE-09A-11
12	38B	KE-09A-12
13	38B	KE-09A-13
14	38B	KE-09A-14
15	38B	KE-09A-15
16	48A	DR-09A-17
17	48A	DR-09A-18
18	48A	DR-09A-19
19	48A	DR-09A-20
20	48A	DR-09A-21
21	48A	DR-09A-22
22	48A	DR-09A-23
23	48A	DR-09A-24
24	48B	FF-09A-26
25	48B	FF-09A-27
26	48B	FF-09A-28
27	48B	FF-09A-29
28	48B	FF-09A-30
29	48B	FF-09A-31
30	48B	FF-09A-32
31	48B	FF-09A-33
32	48B	FF-09A-34
33	48B	FF-09A-35
34	48B	FF-09A-36
35	48B	FF-09A-37
36	48B	FF-09A-38
37	48B	FF-09A-39
38	48B	IG-09A-40
39	48B	IG-09A-41
40	48B	IG-09A-42
41	48B	IG-09A-43

O. Reg. 348/89, Sched. 10.

Schedule 11

Abbreviations:

FF for Fort Frances

ITEM	COLUMN 1	COLUMN 2
1	48B	FF-09B-01
2	48B, 57A	FF-09B-02
3	48B	FF-09B-03
4	48B	FF-09B-04
5	48B, 57A	FF-09B-05
6	48B, 57A	FF-09B-06
7	48B, 57A	FF-09B-07
8	57A	FF-09B-08
9	57A	FF-09B-09
10	57A	FF-09B-10
11	57A	FF-09B-11
12	57A	FF-09B-12
13	48B, 57A	FF-09B-13
14	48B	FF-09B-14
15	48B, 57A	FF-09B-15
16	57A	FF-09B-16
17	57A	FF-09B-17
18	57A	FF-09B-18
19	57A	FF-09B-19
20	57A	FF-09B-20
21	48B, 57A	FF-09B-21
22	48B, 57A	FF-09B-22
23	48B, 57A	FF-09B-23
24	57A	FF-09B-24
25	57A	FF-09B-25
26	57A	FF-09B-26
27	57A	FF-09B-27
28	48B, 57A	FF-09B-28
29	57A	FF-09B-29

O. Reg. 348/89, Sched. 11.

Schedule 12

Abbreviations:

FF for Fort Frances

ITEM	COLUMN 1	COLUMN 2
1	56	FF-10-01
2	56	FF-10-02
3	56	FF-10-03
4	56	FF-10-04
5	56	FF-10-05
6	56, 57A	FF-10-06
7	56, 57A	FF-10-07
8	56, 57A	FF-10-08
9	57A	FF-10-09
10	56, 57A	FF-10-10
11	57A	FF-10-11

O. Reg. 348/89, Sched. 12.

Schedule 13

Abbreviations:

AT for Atikokan
FF for Fort Frances

ITEM	COLUMN 1	COLUMN 2
1	57A	FF-11A-01
2	57A	FF-11A-02
3	57A	FF-11A-03
4	57A	FF-11A-04
5	57A	FF-11A-05
6	57A	FF-11A-06
7	57A	FF-11A-07
8	57A	FF-11A-08
9	57A	FF-11A-09
10	57B	AT-11A-11
11	57B	AT-11A-12
12	57B	AT-11A-13
13	57B	AT-11A-14
14	57B	AT-11A-15
15	57B	AT-11A-16
16	57B, 58	AT-11A-17
17	57B, 58	AT-11A-18
18	58	AT-11A-19
19	58	AT-11A-20
20	58	AT-11A-21
21	58	AT-11A-22
22	58	AT-11A-23

O. Reg. 348/89, Sched. 13.

Schedule 14

Abbreviations:

TB for Thunder Bay

ITEM	COLUMN 1	COLUMN 2
1	58	TB-11B-01
2	58	TB-11B-02
3	58, 59	TB-11B-03
4	58, 59	TB-11B-04
5	58	TB-11B-05
6	58	TB-11B-06
7	58	TB-11B-07
8	58	TB-11B-08
9	58	TB-11B-09

O. Reg. 348/89, Sched. 14.

Schedule 15

Abbreviations:

AT for Atikokan
FF for Fort Frances
IG for Ignace
TB for Thunder Bay

ITEM	COLUMN 1	COLUMN 2
1	48B	FF-12A-01
2	48B, 49B	IG-12A-03
3	48B	IG-12A-04
4	48B, 49B	IG-12A-05
5	48B, 49B	IG-12A-06

ITEM	COLUMN 1	COLUMN 2
6	49B	IG-12A-07
7	49B	IG-12A-08
8	49B	IG-12A-09
9	49B	IG-12A-10
10	49B	IG-12A-11
11	49B	IG-12A-12
12	49B	IG-12A-13
13	49B	IG-12A-14
14	49B	IG-12A-15
15	48D, 49C	AT-12A-16
16	48D, 49C	AT-12A-17
17	49C	AT-12A-18
18	49C, 58	AT-12A-19
19	49C	AT-12A-20
20	49C	AT-12A-21
21	49C	AT-12A-22
22	49C	AT-12A-23
23	49C	AT-12A-24
24	49C	AT-12A-25
25	49C	AT-12A-26
26	49C	AT-12A-27
27	49C	TB-12A-31

O. Reg. 348/89, Sched. 15.

Schedule 16

Abbreviations:

AT for Atikokan
 FF for Fort Frances
 TB for Thunder Bay

ITEM	COLUMN 1	COLUMN 2
1	48B, 57A	FF-12B-01
2	48B, 57A	FF-12B-02
3	48B, 57A	FF-12B-03
4	57A	FF-12B-04
5	57A	FF-12B-05
6	48D, 49C, 57B, 58	AT-12B-06
7	57B, 58	AT-12B-07
8	57B, 58	AT-12B-08
9	57B, 58	AT-12B-09
10	49C, 58	AT-12B-10
11	58	AT-12B-11
12	58	AT-12B-12
13	58	AT-12B-13
14	49C, 58	AT-12B-14
15	58	AT-12B-15
16	49C, 58	AT-12B-16
17	58	AT-12B-17
18	58	AT-12B-18
19	58	AT-12B-19
20	49C, 58	AT-12B-20
21	58	AT-12B-21
22	58	AT-12B-22
23	58	AT-12B-23
24	49C	TB-12B-25
25	58	TB-12B-26
26	58	TB-12B-27
27	58	TB-12B-28

ITEM	COLUMN 1	COLUMN 2
28	49C, 58	TB-12B-29
29	58	TB-12B-30
30	58	TB-12B-31
31	58	TB-12B-32
32	58	TB-12B-33
33	58	TB-12B-34
34	58	TB-12B-35
35	58, 59	TB-12B-36
36	58	TB-12B-37
37	58	TB-12B-38
38	58	TB-12B-39
39	58	TB-12B-40
40	58	TB-12B-41
41	58, 59	TB-12B-42

O. Reg. 348/89, Sched. 16.

Schedule 17

Abbreviations:

NG for Nipigon
 TB for Thunder Bay

ITEM	COLUMN 1	COLUMN 2
1	58, 59	TB-13-01
2	59	TB-13-02
3	50, 59	TB-13-03
4	50, 59	TB-13-04
5	50	NG-13-05
6	50, 59	NG-13-06
7	50, 59	NG-13-07
8	50, 59	NG-13-08
9	59	NG-13-09
10	59	TB-13-13
11	59	TB-13-14
12	59	TB-13-15
13	58	TB-13-16
14	58	TB-13-17
15	58, 59	TB-13-18
16	59	TB-13-19
17	58	TB-13-20
18	58	TB-13-21
19	58	TB-13-22
20	58, 59	TB-13-23
21	59	TB-13-24
22	59	TB-13-25
23	58	TB-13-26
24	59	TB-13-27
25	58	TB-13-28
26	58, 59	TB-13-29
27	59	TB-13-30

O. Reg. 348/89, Sched. 17.

Schedule 18

Abbreviations:

NG for Nipigon

ITEM	COLUMN 1	COLUMN 2
1	59	NG-14-01
2	59	NG-14-02

ITEM	COLUMN 1	COLUMN 2
3	59, 60	NG-14-03
4	59, 60	NG-14-04

O. Reg. 848/89, Sched. 18.

Schedule 19

Abbreviations:

IG for Ignace
SL for Sioux Lookout
TB for Thunder Bay

ITEM	COLUMN 1	COLUMN 2
1	48B, 49B	IG-15A-01
2	48B, 49B	IG-15A-02
3	49B	IG-15A-03
4	49B	IG-15A-04
5	49B	IG-15A-05
6	49B	IG-15A-06
7	49B	IG-15A-07
8	49B	IG-15A-08
9	49B	IG-15A-09
10	49B	IG-15A-10
11	49B	IG-15A-11
12	49B	IG-15A-12
13	49B	IG-15A-13
14	49B	IG-15A-14
15	40B	IG-15A-15
16	40B	IG-15A-16
17	40B, 49B	IG-15A-17
18	40B, 49B	IG-15A-18
19	40B, 49B	IG-15A-19
20	40B, 49B	IG-15A-20
21	49B	IG-15A-21
22	49B	IG-15A-22
23	49B	IG-15A-23
24	49B	IG-15A-24
25	49B	IG-15A-25
26	49B	IG-15A-27
27	49B	IG-15A-28
28	49B	IG-15A-29
29	49B	IG-15A-30
30	49B	IG-15A-31
31	49B	IG-15A-32
32	40B	IG-15A-33
33	40B	IG-15A-34
34	40B, 49B	IG-15A-35
35	40B	IG-15A-36
36	40B, 49B	IG-15A-37
37	49B	IG-15A-38
38	49B	IG-15A-39
39	40B, 49B	IG-15A-40
40	49B	IG-15A-41
41	49B	IG-15A-42
42	49B	IG-15A-43
43	49B	IG-15A-44
44	40B	IG-15A-45
45	40B	IG-15A-46
46	40B	IG-15A-47
47	40B	IG-15A-48
48	40B, 49B	IG-15A-49

ITEM	COLUMN 1	COLUMN 2
49	40B	IG-15A-50
50	40B, 49B	IG-15A-51
51	49B	IG-15A-52
52	49A	SL-15A-53
53	49A	SL-15A-54
54	49A	SL-15A-55
55	49A	SL-15A-56
56	49A	SL-15A-57
57	49B	IG-15A-60
58	49B	IG-15A-61
59	49B	IG-15A-62
60	49B	IG-15A-63
61	40B, 49B	IG-15A-64
62	40B, 49B	IG-15A-65
63	49C	TB-15A-70
64	49C	TB-15A-71
65	49C	TB-15A-72
66	49C	TB-15A-73
67	49C	TB-15A-74
68	49C	TB-15A-75
69	49C	TB-15A-76
70	49C	TB-15A-77
71	49C	TB-15A-78

O. Reg. 348/89, Sched. 19.

Schedule 20

Abbreviations:

NG for Nipigon
TB for Thunder Bay

ITEM	COLUMN 1	COLUMN 2
1	40A, 41	TB-15B-01
2	41, 50	TB-15B-02
3	41	NG-15B-03
4	41	NG-15B-04
5	41	NG-15B-05
6	41, 50	NG-15B-06
7	41, 50	NG-15B-07
8	50	TB-15B-08
9	50	TB-15B-09
10	50	TB-15B-10
11	50	TB-15B-11
12	49C	TB-15B-12
13	50	TB-15B-13
14	50	TB-15B-14
15	50	TB-15B-15
16	49C, 50	TB-15B-17
17	50	TB-15B-18
18	49C	TB-15B-19
19	49C	TB-15B-20
20	49C	TB-15B-21
21	49C	TB-15B-22
22	49C	TB-15B-23
23	49C, 50	TB-15B-24
24	50	TB-15B-25
25	50	TB-15B-26
26	50	TB-15B-27
27	50	TB-15B-28
28	50	TB-15B-29

ITEM	COLUMN 1	COLUMN 2
29	50	NG-15B-30
30	50	NG-15B-31
31	50	NG-15B-32
32	49C	TB-15B-33
33	49C	TB-15B-34
34	49C	TB-15B-35
35	49C	TB-15B-36
36	49C, 50, 58, 59	TB-15B-37
37	49C, 50, 58, 59	TB-15B-38
38	50, 59	TB-15B-39
39	50	TB-15B-40
40	50	TB-15B-41
41	50	NG-15B-42
42	50	NG-15B-43
43	50	NG-15B-44

O. Reg. 348/89, Sched. 20.

Schedule 21

Abbreviations:

RL for Red Lake

SL for Sioux Lookout

ITEM	COLUMN 1	COLUMN 2
1	30	RL-16A-01
2	31	SL-16A-02
3	30	RL-16A-03
4	30	RL-16A-04
5	30	SL-16A-05
6	30	SL-16A-06
7	30	RL-16A-07
8	30	RL-16A-08
9	30	SL-16A-09
10	30	SL-16A-10
11	30	RL-16A-11
12	30	SL-16A-12
13	31	SL-16A-13
14	31	SL-16A-14
15	31	SL-16A-15
16	31	SL-16A-16
17	31	SL-16A-17
18	31	SL-16A-18
19	32A	SL-16A-19
20	32A	SL-16A-20
21	30	RL-16A-21
22	30	RL-16A-22
23	30	RL-16A-23
24	31	SL-16A-24
25	31	SL-16A-25

O. Reg. 348/89, Sched. 21.

Schedule 22

Abbreviations:

SL for Sioux Lookout

ITEM	COLUMN 1	COLUMN 2
1	40A	SL-16B-01
2	40A	SL-16B-02
3	40A	SL-16B-03

ITEM	COLUMN 1	COLUMN 2
4	40A	SL-16B-04
5	40A	SL-16B-05
6	40A	SL-16B-06
7	40A	SL-16B-07
8	40A	SL-16B-08
9	40A	SL-16B-09
10	40A	SL-16B-10
11	40A	SL-16B-11
12	40A	SL-16B-12
13	40A	SL-16B-13
14	40A	SL-16B-14
15	40A	SL-16B-15
16	40A	SL-16B-16
17	40A	SL-16B-17
18	40A	SL-16B-18
19	40A	SL-16B-19
20	40A	SL-16B-20
21	40A	SL-16B-21
22	40A	SL-16B-22
23	40A	SL-16B-23
24	40A	SL-16B-24
25	40A	SL-16B-25
26	40A	SL-16B-26
27	31, 40A	SL-16B-27
28	31, 40A	SL-16B-28
29	40A	SL-16B-29
30	32A	SL-16B-30

O. Reg. 348/89, Sched. 22.

Schedule 23

Abbreviations:

GE for Geraldton

NG for Nipigon

ITEM	COLUMN 1	COLUMN 2
1	32B	GE-16C-01
2	41	NG-16C-06
3	41	NG-16C-07
4	41	NG-16C-08
5	32B, 41	NG-16C-09
6	41	NG-16C-10
7	41	NG-16C-11
8	41	NG-16C-12
9	41	NG-16C-13
10	41	NG-16C-14
11	41	NG-16C-15
12	41	NG-16C-16
13	41	NG-16C-17
14	41	NG-16C-18
15	41	NG-16C-19
16	41	NG-16C-20
17	41	NG-16C-21

O. Reg. 348/89, Sched. 23.

Schedule 24

Abbreviations:

GE for Geraldton

ITEM	COLUMN 1	COLUMN 2
1	32B	GE-17-01
2	32B	GE-17-02

O. Reg. 348/89, Sched. 24.

Schedule 25

Abbreviations:

GE for Geraldton

ITEM	COLUMN 1	COLUMN 2
1	42	GE-18A-06
2	42	GE-18A-07
3	42	GE-18A-08
4	42	GE-18A-09
5	42	GE-18A-10
6	42	GE-18A-11
7	42	GE-18A-12
8	42	GE-18A-13
9	42	GE-18A-14
10	42	GE-18A-15
11	42	GE-18A-16
12	42	GE-18A-17
13	42	GE-18A-18
14	42	GE-18A-19
15	42	GE-18A-20

O. Reg. 348/89, Sched. 25.

Schedule 26

Abbreviations:

GE for Geraldton

NG for Nipigon

ITEM	COLUMN 1	COLUMN 2
1	42, 51	NG-19-01
2	51	NG-19-02
3	51	NG-19-03
4	51	NG-19-04
5	51	NG-19-05
6	51	NG-19-07
7	51	NG-19-08
8	42	GE-19-16
9	42	GE-19-17
10	42, 51	GE-19-18
11	42	GE-19-19
12	42	GE-19-20
13	42, 51	GE-19-21
14	42, 51	GE-19-22
15	42, 51	GE-19-23
16	51	GE-19-24
17	51	GE-19-25
18	51	GE-19-26
19	51	GE-19-27
20	51	GE-19-28
21	42, 51	GE-19-29
22	42, 51	GE-19-30

ITEM	COLUMN 1	COLUMN 2
23	42, 51	GE-19-31
24	51	GE-19-32
25	51	GE-19-33
26	51, 52A	GE-19-34
27	51, 52A	GE-19-35
28	52A	GE-19-36
29	52A	GE-19-37
30	52A	GE-19-38
31	51	GE-19-39

O. Reg. 348/89, Sched. 26.

Schedule 27

Abbreviations:

GE for Geraldton

NG for Nipigon

TR for Terrace Bay

ITEM	COLUMN 1	COLUMN 2
1	51	NG-21A-01
2	51	NG-21A-02
3	50, 51	NG-21A-03
4	51	NG-21A-04
5	50	NG-21A-05
6	50, 51	NG-21A-06
7	50, 51	NG-21A-07
8	51	NG-21A-08
9	51	NG-21A-09
10	50	NG-21A-10
11	51	NG-21A-11
12	51	NG-21A-12
13	51	NG-21A-13
14	50	NG-21A-14
15	50	NG-21A-15
16	50, 51, 59, 60	NG-21A-16
17	59, 60	NG-21A-17
18	51	GE-21A-26
19	51	GE-21A-27
20	51	GE-21A-28
21	51	GE-21A-29
22	51	GE-21A-30
23	51	GE-21A-31
24	51	GE-21A-32
25	51	GE-21A-33
26	60	TR-21A-51
27	60	TR-21A-52
28	60	TR-21A-53
29	51, 60	TR-21A-54
30	51, 60	TR-21A-55
31	51, 60	TR-21A-56
32	60	TR-21A-57
33	51, 60	TR-21A-58
34	51, 60	TR-21A-59
35	51, 60	TR-21A-60
36	51	TR-21A-61
37	51	TR-21A-62

O. Reg. 348/89, Sched. 27.

Schedule 28

Abbreviations:

GE for Geraldton
HE for Hearst
TR for Terrace Bay
WA for Wawa

ITEM	COLUMN 1	COLUMN 2
1	51	GE-21B-01
2	51, 52A	GE-21B-02
3	52A	GE-21B-03
4	51, 52A	GE-21B-04
5	51, 52A	GE-21B-05
6	51, 52A	TR-21B-26
7	52A	TR-21B-27
8	52A	TR-21B-28
9	52A	TR-21B-29
10	52A	TR-21B-30
11	51, 52A	TR-21B-31
12	51, 52A, 60, 61B	TR-21B-32
13	51, 60	TR-21B-33
14	60, 61B	TR-21B-34
15	60, 61B	TR-21B-35
16	60, 61B	TR-21B-36
17	61B	TR-21B-37
18	61B	TR-21B-38
19	60, 61B	WA-21B-51
20	61B	WA-21B-52
21	52A, 61B	WA-21B-53
22	53, 61B	WA-21B-54
23	61B	WA-21B-55
24	61B	WA-21B-56
25	61B	WA-21B-57
26	61B	WA-21B-58
27	52A	HE-21B-76
28	52A	HE-21B-77
29	52A	HE-21B-78
30	52A	HE-21B-79
31	52A	HE-21B-80
32	52A	HE-21B-81
33	52A	HE-21B-82
34	52A	HE-21B-83
35	52A, 61B	HE-21B-84
36	52A	HE-21B-85
37	52A	HE-21B-86
38	52A, 61B	HE-21B-87
39	61B	HE-21B-88

O. Reg. 348/89, Sched. 28.

Schedule 29

Abbreviations:

HE for Hearst
WA for Wawa

ITEM	COLUMN 1	COLUMN 2
1	53	HE-22-01
2	52B	HE-22-02
3	52B	HE-22-03
4	52B	HE-22-04
5	52B	HE-22-05

ITEM	COLUMN 1	COLUMN 2
6	52B	HE-22-06
7	52B	HE-22-07
8	52B	HE-22-08
9	52B	HE-22-09
10	52B	HE-22-10
11	52B, 61A	HE-22-11
12	52B, 61A	HE-22-12
13	61A	HE-22-13
14	61A	HE-22-14
15	61A	HE-22-15
16	61A	HE-22-16
17	61A	HE-22-17
18	61A	HE-22-18
19	52B	HE-22-19
20	52B	HE-22-20
21	52B	HE-22-21
22	52B	HE-22-22
23	61A	WA-22-26
24	61A	WA-22-27
25	61A	WA-22-28
26	61A	WA-22-29
27	61A	WA-22-30
28	61A	WA-22-31
29	61A	WA-22-32
30	61A	WA-22-33
31	61A	WA-22-34
32	61A	WA-22-35
33	61A	WA-22-36
34	61A	WA-22-37
35	61A	WA-22-38
36	61A	WA-22-39
37	61A	WA-22-40

O. Reg. 348/89, Sched. 29.

Schedule 30

Abbreviations:

CP for Chapleau
HE for Hearst
KA for Kapuskasing

ITEM	COLUMN 1	COLUMN 2
1	53	HE-23-01
2	53	HE-23-02
3	53	HE-23-03
4	53	HE-23-04
5	52B, 53	HE-23-05
6	53, 62	HE-23-06
7	53, 62	HE-23-07
8	62	HE-23-08
9	53	KA-23-13
10	53, 62	KA-23-14
11	53, 62	KA-23-15
12	53, 62	KA-23-16
13	62	CP-23-21
14	62	CP-23-22
15	62	CP-23-23

O. Reg. 348/89, Sched. 30.

Schedule 31

Abbreviations:

CC for Cochrane

HE for Hearst

KA for Kapuskasing

MO for Moosonee

ITEM	COLUMN 1	COLUMN 2
1	52	HE-24-01
2	52	HE-24-02
3	52	HE-24-03
4	52	HE-24-04
5	43, 44, 52, 53	HE-24-05
6	44, 52, 53	HE-24-06
7	53	HE-24-07
8	53	HE-24-08
9	53	HE-24-09
10	53	HE-24-10
11	53	KA-24-16
12	44	KA-24-17
13	53	KA-24-18
14	53	KA-24-19
15	53	KA-24-20
16	53	KA-24-21
17	53, 54	KA-24-22
18	44, 53, 54	CC-24-31
19	54	CC-24-32
20	45	MO-24-37

O. Reg. 348/89, Sched. 31.

Schedule 32

Abbreviations:

MO for Moosonee

ITEM	COLUMN 1	COLUMN 2
1	45	MO-25-01

O. Reg. 348/89, Sched. 32.

Schedule 33

Abbreviations:

CC for Cochrane

MO for Moosonee

ITEM	COLUMN 1	COLUMN 2
1	45	MO-26-01
2	45	CC-26-06
3	45	CC-26-07
4	45	CC-26-08
5	45	CC-26-09
6	45	CC-26-10
7	45	CC-26-11
8	45	CC-26-12
9	46	CC-26-13
10	46	CC-26-14
11	45, 54	CC-26-15
12	45	CC-26-16
13	45	CC-26-17
14	45	CC-26-18
15	45, 54	CC-26-19

ITEM	COLUMN 1	COLUMN 2
16	45	CC-26-20
17	45, 54	CC-26-21
18	45, 54	CC-26-22
19	45, 54	CC-26-23
20	45, 54	CC-26-24
21	45, 54	CC-26-25
22	54	CC-26-26
23	45, 54	CC-26-27
24	45, 46, 54, 55	CC-26-28
25	55	CC-26-29
26	54	CC-26-30
27	54	CC-26-31
28	54	CC-26-32
29	54	CC-26-33
30	54	CC-26-34
31	54, 55	CC-26-35
32	54	CC-26-36
33	54	CC-26-37
34	54	CC-26-38
35	55	CC-26-39
36	54	CC-26-40
37	54	CC-26-41
38	54	CC-26-42
39	54	CC-26-43
40	54	CC-26-44
41	54	CC-26-45
42	54	CC-26-46
43	54	CC-26-47
44	54	CC-26-48
45	54, 55	CC-26-49
46	54	CC-26-50
47	54	CC-26-51
48	54	CC-26-52
49	54	CC-26-53
50	54, 55	CC-26-54
51	54	CC-26-55
52	54	CC-26-56
53	54	CC-26-57
54	54	CC-26-58
55	54	CC-26-59
56	54, 55	CC-26-60
57	55	CC-26-61
58	54	CC-26-62
59	54	CC-26-63
60	54	CC-26-64
61	54	CC-26-65
62	54	CC-26-66
63	54	CC-26-67
64	54	CC-26-68
65	54	CC-26-69
66	54	CC-26-70
67	54	CC-26-71

O. Reg. 348/89, Sched. 33.

Schedule 34

Abbreviations:

CC for Cochrane

ITEM	COLUMN 1	COLUMN 2
1	54	CC-27-01
2	54	CC-27-02
3	54	CC-27-03
4	54	CC-27-04
5	54	CC-27-05
6	54	CC-27-06
7	54	CC-27-07
8	54	CC-27-08
9	54	CC-27-09
10	54, 63	CC-27-10
11	54	CC-27-11
12	54	CC-27-12
13	54, 63	CC-27-13
14	55, 64	CC-27-14
15	54, 63	CC-27-15
16	55, 64	CC-27-16
17	63, 64	CC-27-17
18	63	CC-27-19
19	54	CC-27-20
20	54	CC-27-21

O. Reg. 348/89, Sched. 34.

Schedule 35

Abbreviations:

CC for Cochrane

KL for Kirkland Lake

TE for Temagami

ITEM	COLUMN 1	COLUMN 2
1	63	CC-28-01
2	63	KL-28-07
3	63	KL-28-08
4	63, 64	KL-28-09
5	63	KL-28-10
6	63	KL-28-11
7	63	KL-28-12
8	63	KL-28-13
9	63	KL-28-14
10	63	KL-28-15
11	64	KL-28-16
12	63, 67	KL-28-17
13	63	KL-28-18
14	63, 64	KL-28-19
15	64	KL-28-20
16	63	KL-28-21
17	63	KL-28-22
18	63, 64	KL-28-23
19	64, 68A	KL-28-24
20	64, 68A	KL-28-25
21	64, 68A	KL-28-26
22	63, 64, 67, 68A	KL-28-27
23	63, 67	KL-28-28
24	63, 67	KL-28-29
25	67	KL-28-30
26	67	KL-28-31

ITEM	COLUMN 1	COLUMN 2
27	67	KL-28-32
28	67	KL-28-33
29	67	KL-28-34
30	67	KL-28-35
31	68A	KL-28-36
32	68A	KL-28-37
33	68A	KL-28-38
34	68A	KL-28-39
35	67	KL-28-40
36	67	KL-28-41
37	67	KL-28-42
38	67	KL-28-43
39	67	KL-28-44
40	67, 68A	KL-28-45
41	67	KL-28-46
42	67, 68A	KL-28-47
43	67, 68B	TE-28-64
44	68B	TE-28-65
45	68B	TE-28-66

O. Reg. 348/89, Sched. 35.

Schedule 36

Abbreviations:

GO for Gogama

KL for Kirkland Lake

TI for Timmins

ITEM	COLUMN 1	COLUMN 2
1	63	TI-29-01
2	63	TI-29-02
3	63	TI-29-03
4	63	TI-29-05
5	63	TI-29-06
6	63, 67	TI-29-07
7	63	TI-29-08
8	63, 67	TI-29-09
9	63	TI-29-10
10	63	TI-29-11
11	63	TI-29-12
12	63	TI-29-13
13	63	TI-29-14
14	63	KL-29-26
15	63	KL-29-27
16	63	KL-29-28
17	63, 67	KL-29-29
18	63, 67	KL-29-30
19	63	KL-29-31
20	63, 67	KL-29-32
21	63	KL-29-33
22	63, 67	KL-29-34
23	67	KL-29-35
24	63, 67	KL-29-36
25	67	KL-29-37
26	67	KL-29-38
27	67	KL-29-39
28	67	KL-29-40
29	63, 67	GO-29-48
30	67	GO-29-49
31	67	GO-29-50

ITEM	COLUMN 1	COLUMN 2
32	67	GO-29-51
33	67	GO-29-52
34	67	GO-29-53
35	67	GO-29-54
36	67	GO-29-56
37	67	GO-29-57
38	67	GO-29-58
39	67	GO-29-59
40	67	GO-29-60
41	67	GO-29-61
42	67	GO-29-62
43	67	GO-29-63
44	67	GO-29-64
45	67	GO-29-65
46	67	GO-29-66

O. Reg. 348/89, Sched. 36.

Schedule 37

Abbreviations:

CC for Cochrane
 CP for Chapleau
 KA for Kapuskasing
 TI for Timmins

ITEM	COLUMN 1	COLUMN 2
1	53, 62	KA-30-01
2	53, 54, 62, 63	KA-30-02
3	54	CC-30-06
4	54	CC-30-07
5	54	CC-30-08
6	54, 63	CC-30-09
7	54, 63	CC-30-10
8	63	CC-30-11
9	54, 63	CC-30-12
10	54	CC-30-13
11	63	CC-30-14
12	62	CP-30-21
13	62	CP-30-22
14	62	CP-30-23
15	62	CP-30-24
16	62	CP-30-25
17	62	CP-30-26
18	62	CP-30-27
19	62	CP-30-28
20	62	CP-30-29
21	62	CP-30-30
22	62	CP-30-31
23	62	CP-30-32
24	62, 63	TI-30-41
25	63	TI-30-42
26	63	TI-30-43
27	63	TI-30-44
28	63	TI-30-45
29	63	TI-30-46
30	63	TI-30-47
31	63	TI-30-48
32	63	TI-30-49

ITEM	COLUMN 1	COLUMN 2
33	63	TI-30-50

O. Reg. 348/89, Sched. 37.

Schedule 38

Abbreviations:

CP for Chapleau
 GO for Gogama
 TI for Timmins

ITEM	COLUMN 1	COLUMN 2
1	62, 63	TI-31-01
2	62	CP-31-06
3	62	CP-31-07
4	62	CP-31-08
5	62	CP-31-09
6	62	CP-31-10
7	62	CP-31-11
8	62	CP-31-12
9	62	CP-31-13
10	62	CP-31-14
11	62	CP-31-15
12	62	CP-31-16
13	62, 66C	CP-31-17
14	62, 66C	CP-31-18
15	62	CP-31-19
16	62	CP-31-20
17	62	CP-31-21
18	62	CP-31-22
19	62, 66C	CP-31-23
20	62	CP-31-24
21	62	CP-31-25
22	62	CP-31-26
23	66C	CP-31-27
24	62, 66C	CP-31-28
25	66C	CP-31-29
26	62, 66C	CP-31-30
27	66C	CP-31-31
28	66C	CP-31-32
29	66C	CP-31-33
30	62, 66C	CP-31-35
31	66C	CP-31-36
32	62, 66C	CP-31-37
33	66C	CP-31-38
34	66C	CP-31-39
35	66C	CP-31-40
36	66C	CP-31-41
37	66C	CP-31-42
38	66C	CP-31-43
39	66C	CP-31-44
40	62, 63, 66C, 67	CP-31-45
41	66C	CP-31-46
42	66C	CP-31-47
43	63, 64, 66C, 67	GO-31-52
44	63, 64, 67	GO-31-53
45	63, 64, 67	GO-31-54
46	66C, 67	GO-31-55
47	66C	GO-31-56
48	67	GO-31-57
49	66C	GO-31-58

ITEM	COLUMN 1	COLUMN 2
50	67	GO-31-59
51	67	GO-31-60
52	67	GO-31-61
53	67	GO-31-62
54	66C, 67	GO-31-63
55	67	GO-31-64
56	67	GO-31-65

O. Reg. 348/89, Sched. 38.

Schedule 39

Abbreviations:

CP for Chapleau

WA for Wawa

ITEM	COLUMN 1	COLUMN 2
1	61C	WA-32-01
2	61C	WA-32-02
3	61C	WA-32-03
4	61C	WA-32-04
5	61C	WA-32-05
6	61C	WA-32-06
7	61C	WA-32-07
8	61C	WA-32-08
9	61C	WA-32-09
10	61C	WA-32-10
11	61C	WA-32-11
12	61C	WA-32-12
13	61C	WA-32-13
14	61C	WA-32-14
15	61C	WA-32-15
16	61C	WA-32-16
17	61C	WA-32-17
18	61C	WA-32-18
19	61C, 62	WA-32-19
20	61C	WA-32-20
21	61C	WA-32-21
22	61C, 65B	WA-32-22
23	61C, 62, 65B	WA-32-23
24	61C, 65B	WA-32-24
25	61C	WA-32-25
26	61C, 65B	WA-32-26
27	61C	WA-32-27
28	61C, 65B	WA-32-28
29	61C, 65B	WA-32-29
30	65B	WA-32-30
31	61C, 65A	WA-32-31
32	65B	WA-32-32
33	65B	WA-32-33
34	65B, 66B	CP-32-34
35	62, 66B	CP-32-35
36	66B	CP-32-36
37	66B	CP-32-37
38	66B	CP-32-38
39	66B	CP-32-39
40	66B	CP-32-40

O. Reg. 348/89, Sched. 39.

Schedule 40

Abbreviations:

WA for Wawa

ITEM	COLUMN 1	COLUMN 2
1	60, 61C	WA-33-01
2	61C	WA-33-02
3	61C	WA-33-03
4	61C	WA-33-04
5	61C	WA-33-05
6	61C	WA-33-06
7	61C	WA-33-07
8	61C	WA-33-08
9	61C	WA-33-09
10	61C	WA-33-10
11	61C, 65B	WA-33-11
12	61C, 65B	WA-33-12
13	61C, 65B	WA-33-13

O. Reg. 348/89, Sched. 40.

Schedule 41

Abbreviations:

WA for Wawa

ITEM	COLUMN 1	COLUMN 2
1	65B	WA-34-01
2	65B	WA-34-02
3	65B	WA-34-03
4	65B	WA-34-04
5	65B	WA-34-05
6	65B	WA-34-06
7	65B	WA-34-07
8	65B	WA-34-08

O. Reg. 348/89, Sched. 41.

Schedule 42

Abbreviations:

BL for Blind River

CP for Chapleau

SS for Sault Ste. Marie

WA for Wawa

ITEM	COLUMN 1	COLUMN 2
1	65A	WA-35-01
2	65A	WA-35-02
3	65A, 66A	CP-35-03
4	65A	WA-35-04
5	66A	CP-35-05
6	65A	WA-35-06
7	66A	CP-35-07
8	65A, 66A	CP-35-08
9	65A	WA-35-09
10	66A	CP-35-10
11	66A	CP-35-11
12	66A	CP-35-12
13	66A	CP-35-13
14	66A	CP-35-14
15	65A	WA-35-15
16	66A	CP-35-16

ITEM	COLUMN 1	COLUMN 2
17	66A	CP-35-17
18	66A	CP-35-18
19	65A	WA-35-19
20	65A	WA-35-20
21	66A	CP-35-21
22	66A	SS-35-22
23	65A	WA-35-23
24	65A, 66A	WA-35-24
25	66A	CP-35-25
26	66A	CP-35-26
27	65A, 66A	WA-35-27
28	66A	CP-35-28
29	66A	CP-35-29
30	65A, 66A	SS-35-30
31	66A	SS-35-31
32	66A	BL-35-32
33	65A	SS-35-33
34	66A	BL-35-34
35	66A, 70A	SS-35-35
36	66A, 70A	SS-35-36
37	65A, 66A, 69, 70A	SS-35-37
38	66A	BL-35-38
39	66A	BL-35-39
40	66A	BL-35-40
41	70A	BL-35-41
42	70A	SS-35-42
43	70A	SS-35-43
44	65A	WA-35-44
45	66B	BL-35-45

O. Reg. 348/89, Sched. 42.

Schedule 43

Abbreviations:

BL for Blind River
SS for Sault Ste. Marie

ITEM	COLUMN 1	COLUMN 2
1	65A	SS-36-01
2	65A, 69	SS-36-02
3	65A	SS-36-03
4	65A	SS-36-04
5	65A, 69	SS-36-05
6	65A, 69	SS-36-06
7	69	SS-36-07
8	70A	SS-36-08
9	70A	BL-36-09
10	70A	BL-36-10
11	70A	SS-36-11
12	69	SS-36-12
13	69, 70A	SS-36-13
14	70A	SS-36-14
15	70A	BL-36-15
16	70A	SS-36-16
17	70A	BL-36-17
18	70A	SS-36-18
19	70A	BL-36-19
20	70A	BL-36-20
21	70A	BL-36-21

ITEM	COLUMN 1	COLUMN 2
22	70A	BL-36-22
23	70A	BL-36-23

O. Reg. 348/89, Sched. 43.

Schedule 44

Abbreviations:

BL for Blind River
EP for Espanola

ITEM	COLUMN 1	COLUMN 2
1	70B	BL-37-01
2	70B	BL-37-02
3	70B	BL-37-03
4	70B	BL-37-04
5	70B	BL-37-05
6	70B	BL-37-06
7	70B	BL-37-07
8	70B	BL-37-08
9	70B	BL-37-09
10	70B	BL-37-10
11	70B	BL-37-11
12	70B	BL-37-12
13	70B	BL-37-13
14	70B	BL-37-14
15	70B	BL-37-15
16	70B	BL-37-16
17	70B	BL-37-17
18	70B	BL-37-18
19	70B	BL-37-19
20	70B	BL-37-20
21	70B	BL-37-21
22	70B	BL-37-22
23	70B	BL-37-23
24	70B	BL-37-24
25	70B	BL-37-25
26	70B	BL-37-26
27	70B	BL-37-27
28	70B	BL-37-28
29	70B	BL-37-29
30	70B	BL-37-30
31	70B	BL-37-31
32	70B	BL-37-32
33	70B	BL-37-33
34	70B	BL-37-34
35	70B	BL-37-35
36	70B	BL-37-36
37	70B	BL-37-37
38	70B	BL-37-38
39	70B	EP-37-39
40	70B	EP-37-40
41	70B	EP-37-41
42	70B, 71A	EP-37-42
43	71A	EP-37-43
44	70B	EP-37-44
45	70B, 71A	EP-37-45
46	70B	EP-37-46
47	70B	EP-37-47

ITEM	COLUMN 1	COLUMN 2
48	70A	EP-37-48

O. Reg. 348/89, Sched. 44.

Schedule 45

Abbreviations:

BL for Blind River

CP for Chapleau

EP for Espanola

SU for Sudbury

ITEM	COLUMN 1	COLUMN 2
1	66B	CP-38-01
2	66B	CP-38-02
3	66B	CP-38-03
4	66B	CP-38-04
5	66B, 67	CP-38-05
6	66B	CP-38-06
7	66B	CP-38-07
8	66B	CP-38-08
9	66B	CP-38-09
10	66B	CP-38-10
11	66B, 67	CP-38-11
12	66B	CP-38-12
13	66B	CP-38-13
14	66B	CP-38-14
15	66B	CP-38-15
16	66B	CP-38-16
17	66B	CP-38-17
18	66B	CP-38-18
19	66B	CP-38-19
20	66B	CP-38-20
21	66B	CP-38-21
22	66B	CP-38-22
23	66B	CP-38-23
24	66B	CP-38-24
25	66B, 67	CP-38-25
26	66B, 67	CP-38-26
27	66B	BL-38-27
28	66B	BL-38-28
29	66B	BL-38-29
30	66B	BL-38-30
31	66B	BL-38-31
32	66B	BL-38-32
33	66B	BL-38-33
34	66B	BL-38-34
35	66B	BL-38-35
36	66B	BL-38-36
37	66B	BL-38-37
38	66B	BL-38-38
39	66B, 70C	BL-38-39
40	66B	BL-38-40
41	66B, 70C	BL-38-41
42	66B, 70C	BL-38-42
43	66B, 70C	BL-38-43
44	66B, 70C	BL-38-44
45	66B, 70C	BL-38-45
46	66B, 70C	BL-38-46
47	66B, 70C	BL-38-47
48	66B, 70C	BL-38-48

ITEM	COLUMN 1	COLUMN 2
49	70C	BL-38-49
50	66B	EP-38-50
51	66B, 70C	EP-38-51
52	66B, 70C	EP-38-52
53	70C	BL-38-53
54	70C	BL-38-54
55	70C	EP-38-55
56	70C	EP-38-56
57	66B, 70C	EP-38-57
58	66B, 67, 70C, 71A	EP-38-58
59	67C, 71A	SU-38-59
60	70C, 71A	EP-38-60
61	71A	SU-38-61
62	70C	BL-38-62
63	70C	BL-38-63
64	70C	EP-38-64
65	70C	EP-38-65
66	70C	EP-38-66
67	70C, 71A	EP-38-67
68	70C, 71A	EP-38-68
69	71A	EP-38-69
70	70C	BL-38-70
71	70C	BL-38-71
72	70C	BL-38-72
73	70C	EP-38-73
74	70C	EP-38-74
75	70C	EP-38-75
76	70C	BL-38-76
77	70C	EP-38-77
78	70C	EP-38-78
79	70C, 71A	EP-38-79
80	71A	EP-38-80
81	70C	BL-38-81
82	70C	EP-38-82
83	66B	BL-38-83

O. Reg. 348/89, Sched. 45.

Schedule 46

Abbreviations:

EP for Espanola

GO for Gogama

SU for Sudbury

ITEM	COLUMN 1	COLUMN 2
1	67	GO-39-01
2	67	GO-39-02
3	67	GO-39-03
4	67, 71A	GO-39-04
5	67	GO-39-05
6	67, 71A	GO-39-06
7	67, 71A	SU-39-07
8	67, 71A	SU-39-08
9	67, 71A	SU-39-09
10	67, 71A	SU-39-10
11	67, 71A	SU-39-11
12	67, 71A	SU-39-12
13	71A	SU-39-13
14	71A	SU-39-14

ITEM	COLUMN 1	COLUMN 2
15	71A	SU-39-15
16	71A	SU-39-16
17	71A	SU-39-17
18	71A	SU-39-18
19	71A	EP-39-19
20	71A	EP-39-20
21	71A	EP-39-21
22	71A	EP-39-22
23	71A	EP-39-23
24	71A	SU-39-24
25	71A	SU-39-25
26	71A	EP-39-26
27	71A	SU-39-27

O. Reg. 348/89, Sched. 46.

Schedule 47

Abbreviations:

GO for Gogama
 KL for Kirkland Lake
 NB for North Bay
 SU for Sudbury
 TE for Temagami

ITEM	COLUMN 1	COLUMN 2
1	63, 67	KL-40-01
2	67	KL-40-02
3	67	KL-40-03
4	67	KL-40-04
5	67	KL-40-05
6	67	KL-40-06
7	67	KL-40-07
8	67	KL-40-08
9	67	KL-40-09
10	67	KL-40-10
11	67	KL-40-11
12	67	KL-40-12
13	67	KL-40-13
14	67	KL-40-14
15	67	KL-40-15
16	67	KL-40-16
17	67	KL-40-17
18	67	KL-40-18
19	67	KL-40-19
20	67	GO-40-21
21	67	GO-40-22
22	67	GO-40-23
23	67	GO-40-24
24	67	GO-40-25
25	67	GO-40-27
26	67	GO-40-28
27	67	GO-40-29
28	67	GO-40-30
29	67	SU-40-36
30	67, 71A	SU-40-37
31	67, 68B	TE-40-41
32	67, 68B	TE-40-42
33	67	TE-40-43
34	67, 68B	TE-40-44
35	68B	TE-40-45

ITEM	COLUMN 1	COLUMN 2
36	67, 68B	TE-40-46
37	68B	TE-40-47
38	67	TE-40-48
39	67	TE-40-49
40	67, 71A	TE-40-50
41	67, 68B, 71B, 72	TE-40-51
42	68B, 72	TE-40-52
43	68B	TE-40-53
44	71B, 72	TE-40-54
45	68B, 72	TE-40-55
46	68B, 72	TE-40-56
47	68B	TE-40-57
48	68B, 72	TE-40-58
49	72	TE-40-59
50	72	TE-40-60
51	72	TE-40-61
52	72	TE-40-62
53	72	TE-40-63
54	72	TE-40-64
55	72	TE-40-65
56	72	NB-40-66
57	72	NB-40-67
58	72	NB-40-68

O. Reg. 348/89, Sched. 47.

Schedule 48

Abbreviations:

GO for Gogama
 NB for North Bay
 SU for Sudbury
 TE for Temagami

ITEM	COLUMN 1	COLUMN 2
1	67	GO-41-01
2	67	GO-41-02
3	67	SU-41-03
4	67	GO-41-04
5	67	GO-41-05
6	67	GO-41-06
7	67, 71A	SU-41-07
8	67, 71A	SU-41-08
9	71B	NB-41-09
10	67, 71B	TE-41-10
11	67, 71B	NB-41-11
12	71B	TE-41-12
13	71A	SU-41-13
14	71A	SU-41-14
15	71A	SU-41-15
16	71B	NB-41-16
17	71B	TE-41-18
18	72	NB-41-19
19	71A	SU-41-20
20	71A	SU-41-21
21	71B	NB-41-22
22	71B	NB-41-23
23	71B	NB-41-24
24	71B	NB-41-25
25	71B	NB-41-26
26	71B, 72	NB-41-27

ITEM	COLUMN 1	COLUMN 2
27	72	NB-41-28
28	72	NB-41-29
29	72	NB-41-30
30	72	NB-41-31
31	71A	SU-41-32
32	71B	NB-41-33
33	71B	NB-41-34
34	71B	NB-41-35
35	71B, 72	NB-41-36
36	72	NB-41-37
37	72	NB-41-38
38	72	NB-41-39
39	71A	SU-41-40
40	71A	SU-41-41
41	71A	SU-41-42
42	71B	NB-41-43
43	71B	NB-41-44
44	71B, 72	NB-41-45
45	72	NB-41-46
46	72	NB-41-47
47	72	NB-41-48
48	71A	NB-41-49
49	71B	NB-41-50
50	72	NB-41-51
51	72	NB-41-52
52	72	NB-41-53
53	71B	NB-41-54
54	71B, 72	NB-41-55
55	72	NB-41-56
56	72	NB-41-57
57	72	NB-41-58
58	72	NB-41-59
59	72	NB-41-60
60	72	NB-41-61
61	71B	TE-41-62

O. Reg. 348/89, Sched. 48.

Schedule 49

Abbreviations:

EP for Espanola
 NB for North Bay
 SU for Sudbury

ITEM	COLUMN 1	COLUMN 2
1	71A	SU-42-01
2	71A	SU-42-02
3	71A	SU-42-03
4	71A	SU-42-04
5	71A	EP-42-05
6	71A	SU-42-06
7	71A	SU-42-07
8	71A	SU-42-08
9	71A	SU-42-09
10	71A	SU-42-10
11	71A	SU-42-11
12	71A	SU-42-12
13	71A	EP-42-13
14	71A	EP-42-14
15	71A	SU-42-15

ITEM	COLUMN 1	COLUMN 2
16	71A	SU-42-16
17	71A	SU-42-17
18	71A	NB-42-18
19	72	NB-42-19
20	72	NB-42-20
21	71A, 72	NB-42-21
22	70B	EP-42-22
23	70B	EP-42-23
24	70B, 71A	EP-42-24
25	71A	EP-42-25
26	71A	EP-42-26
27	71A	EP-42-27
28	71A	EP-42-28
29	71A	EP-42-29
30	71A	SU-42-30
31	71A	SU-42-31
32	71A	SU-42-32
33	71A	SU-42-33
34	71A	SU-42-34
35	71A	SU-42-35
36	71A	SU-42-36
37	71A	SU-42-37
38	71A	SU-42-38
39	71A	SU-42-39
40	71A	NB-42-40
41	71A	NB-42-41
42	71A	EP-42-42
43	71A	EP-42-43
44	71A	EP-42-44
45	71A	EP-42-45
46	71A	EP-42-46
47	71A, 75	SU-42-47
48	71A, 75	SU-42-48
49	71A, 75	SU-42-49
50	71A	SU-42-50
51	71A	SU-42-51
52	71A	SU-42-52
53	71A	SU-42-53
54	71A	SU-42-54
55	71A	SU-42-55
56	71A	SU-42-56
57	71A	SU-42-57
58	71A	SU-42-59

O. Reg. 348/89, Sched. 49.

Schedule 50

Abbreviations:

EP for Espanola

ITEM	COLUMN 1	COLUMN 2
1	74, 75	EP-43B-01

O. Reg. 348/89, Sched. 50.

Schedule 51

Abbreviations:

PS for Parry Sound

SU for Sudbury

ITEM	COLUMN 1	COLUMN 2
1	71A, 75	SU-46-01
2	75	SU-46-02
3	71A, 75	SU-46-03
4	71A, 75	SU-46-04
5	71A, 75	PS-46-06
6	75	PS-46-07
7	75	PS-46-08
8	75	PS-46-09
9	75	PS-46-10
10	75	PS-46-11
11	75	PS-46-12
12	75	PS-46-13
13	75	PS-46-14
14	75	PS-46-15
15	75	PS-46-16
16	75	PS-46-17
17	75, 76A	PS-46-18
18	76A	PS-46-19
19	75, 76A	PS-46-20
20	76A	PS-46-21

O. Reg. 348/89, Sched. 51.

Schedule 52

Abbreviations:

NB for North Bay

PS for Parry Sound

ITEM	COLUMN 1	COLUMN 2
1	71A, 75	PS-47-01
2	71A, 75	PS-47-02
3	75	PS-47-03
4	75	PS-47-04
5	71A, 75	PS-47-05
6	71A	PS-47-06
7	71A	NB-47-07
8	71A, 75	PS-47-08
9	72, 75, 76F	PS-47-09
10	75	PS-47-10
11	75	PS-47-11
12	75	PS-47-12
13	75, 76A	PS-47-13
14	75	PS-47-14
15	75, 76A	PS-47-15
16	76A	PS-47-16
17	76A	PS-47-17
18	71A, 72	NB-47-18
19	72	NB-47-19
20	72	NB-47-20
21	72	NB-47-21
22	72, 76F	NB-47-22
23	72, 76F	NB-47-23
24	72, 76F	NB-47-24

O. Reg. 348/89, Sched. 52.

Schedule 53

Abbreviations:

BR for Bracebridge

NB for North Bay

PE for Pembroke

ITEM	COLUMN 1	COLUMN 2
1	72	NB-48-01
2	72, 76B	NB-48-02
3	72	NB-48-03
4	72	NB-48-04
5	72	NB-48-05
6	72	NB-48-06
7	72	PE-48-07
8	72	PE-48-08
9	72	PE-48-09
10	72, 73	PE-48-10
11	72, 73	PE-48-11
12	73	PE-48-12
13	73	PE-48-13
14	73	PE-48-14
15	72, 73, 77A	PE-48-15
16	77A	PE-48-16
17	77A	PE-48-17
18	77A	PE-48-18
19	76B	BR-48-19

O. Reg. 348/89, Sched. 53.

Schedule 54

Abbreviations:

PS for Parry Sound

ITEM	COLUMN 1	COLUMN 2
1	75	PS-49-01
2	75	PS-49-02
3	75	PS-49-03
4	75	PS-49-04
5	75, 76A	PS-49-05
6	76A	PS-49-06
7	75, 76A	PS-49-07
8	76A	PS-49-08
9	76A	PS-49-09
10	76A	PS-49-10

O. Reg. 348/89, Sched. 54.

Schedule 55

Abbreviations:

BR for Bracebridge

ITEM	COLUMN 1	COLUMN 2
1	76B	BR-50-01
2	76B	BR-50-02
3	76B	BR-50-03
4	76B	BR-50-04
5	76B	BR-50-05
6	76B	BR-50-06
7	76B	BR-50-07
8	76B	BR-50-08
9	76B	BR-50-09

ITEM	COLUMN 1	COLUMN 2
10	76B	BR-50-10
11	76B	BR-50-11
12	76B	BR-50-12
13	76B	BR-50-13

O. Reg. 348/89, Sched. 55.

Schedule 56

Abbreviations:

BR for Bracebridge

ITEM	COLUMN 1	COLUMN 2
1	76B	BR-53-01
2	76B, 80A	BR-53-02
3	76B, 80A	BR-53-03

O. Reg. 348/89, Sched. 56.

Schedule 57

Abbreviations:

AP for Algonquin Park

BR for Bracebridge

MD for Minden

ITEM	COLUMN 1	COLUMN 2
1	76B	BR-54-01
2	76B	BR-54-02
3	76D	MD-54-03
4	76D	MD-54-04
5	76D	MD-54-05
6	76C	AP-54-06
7	76C	AP-54-07

O. Reg. 348/89, Sched. 57.

Schedule 58

Abbreviations:

AP for Algonquin Park

PE for Pembroke

ITEM	COLUMN 1	COLUMN 2
1	76C	AP-55A-01
2	76C	AP-55A-02
3	76C, 77A	AP-55A-03
4	76C	AP-55A-04
5	76C	AP-55A-05
6	76C, 77A	AP-55A-06
7	77A	AP-55A-07
8	76C	AP-55A-08
9	76C, 77A	AP-55A-09
10	77A	AP-55A-10
11	77A	PE-55A-11
12	77A	PE-55A-12
13	77A	PE-55A-13

O. Reg. 348/89, Sched. 58.

Schedule 59

Abbreviations:

PE for Pembroke

ITEM	COLUMN 1	COLUMN 2
1	77A	PE-55B-01
2	77A	PE-55B-02
3	77A	PE-55B-03
4	77A	PE-55B-04
5	77A	PE-55B-05
6	77A	PE-55B-06
7	77A	PE-55B-07

O. Reg. 348/89, Sched. 59.

Schedule 60

Abbreviations:

BR for Bracebridge

MD for Minden

ITEM	COLUMN 1	COLUMN 2
1	76D	MD-56-01
2	76D	MD-56-02
3	76D, 80A	BR-56-03
4	76D, 80B	MD-56-04
5	76D, 80B	MD-56-05
6	80B	MD-56-06
7	80B	MD-56-07
8	80B	MD-56-08
9	80B	MD-56-09
10	80B	MD-56-10
11	80B	MD-56-11
12	80B	MD-56-12
13	80B	MD-56-13
14	80B	MD-56-14
15	76D, 80B	MD-56-15
16	76D	MD-56-16

O. Reg. 348/89, Sched. 60.

Schedule 61

Abbreviations:

BA for Bancroft

PE for Pembroke

ITEM	COLUMN 1	COLUMN 2
1	76E, 77B	BA-57-01
2	76E	BA-57-02
3	77B	BA-57-03
4	77B	BA-57-04
5	77B	BA-57-05
6	77B	BA-57-06
7	76E	BA-57-07
8	76E, 77B	BA-57-08
9	76E	BA-57-09
10	77B	BA-57-10
11	76E, 77B, 80C	BA-57-11
12	77B	BA-57-12
13	77B	BA-57-13

ITEM	COLUMN 1	COLUMN 2
14	77A	PE-57-14

O. Reg. 348/89, Sched. 61.

Schedule 62

Abbreviations:

PE for Pembroke

TW for Tweed

ITEM	COLUMN 1	COLUMN 2
1	77A	PE-58-01
2	77A	PE-58-02
3	77A	PE-58-03
4	77A	PE-58-04
5	77A	PE-58-05
6	77A	PE-58-06
7	77A	PE-58-07
8	77C	TW-58-08

O. Reg. 348/89, Sched. 62.

Schedule 63

Abbreviations:

PE for Pembroke

ITEM	COLUMN 1	COLUMN 2
1	77A	PE-59-01
2	77A	PE-59-02
3	77A	PE-59-03

O. Reg. 348/89, Sched. 63.

Schedule 64

Abbreviations:

BA for Bancroft

MD for Minden

TW for Tweed

ITEM	COLUMN 1	COLUMN 2
1	80B	MD-60-01
2	80B	MD-60-02
3	80B	MD-60-03
4	80B	MD-60-04
5	80B	MD-60-05
6	80B	MD-60-06
7	80C, 81A	BA-60-07
8	80B	MD-60-08
9	80B	MD-60-09
10	80B	MD-60-10
11	80B	MD-60-11
12	80B	MD-60-12
13	80B	MD-60-13
14	80B	MD-60-14
15	80C	BA-60-15
16	77B, 81A	BA-60-16
17	77B, 81A	BA-60-17
18	80C	BA-60-18
19	81A	BA-60-19
20	81A	BA-60-20
21	80C, 81A	BA-60-21

ITEM	COLUMN 1	COLUMN 2
22	81B	TW-60-22
23	81B	TW-60-23
24	81B	TW-60-24
25	81B	TW-60-25
26	81B	TW-60-26

O. Reg. 348/89, Sched. 64.

Schedule 65

Abbreviations:

BA for Bancroft

TW for Tweed

ITEM	COLUMN 1	COLUMN 2
1	77B, 81A	BA-61-01
2	77B, 81A	BA-61-02
3	81A	BA-61-03
4	81B	TW-61-04
5	81B	TW-61-05
6	81B	TW-61-06
7	81B	TW-61-07
8	81B	TW-61-08
9	77C, 81B	TW-61-09
10	77C, 81B	TW-61-10
11	81B	TW-61-11
12	77C, 81B	TW-61-12
13	77C	TW-61-13
14	77C	TW-61-14
15	77C, 81B	TW-61-15
16	77C	TW-61-16

O. Reg. 348/89, Sched. 65.

Schedule 66

Abbreviations:

TW for Tweed

ITEM	COLUMN 1	COLUMN 2
1	81B	TW-62-01
2	81B	TW-62-02
3	81B	TW-62-03
4	81B	TW-62-04
5	81B	TW-62-05
6	81B	TW-62-06
7	81B	TW-62-07

O. Reg. 348/89, Sched. 66.

Schedule 67

Abbreviations:

CA for Carleton Place

PE for Pembroke

TW for Tweed

ITEM	COLUMN 1	COLUMN 2
1	77A	PE-63-01
2	77A	TW-63-02
3	77C, 81B	TW-63-03
4	77A	PE-63-04
5	77C	TW-63-05

ITEM	COLUMN 1	COLUMN 2
6	77C	CA-63-06
7	77C	CA-63-07
8	77C	CA-63-08
9	77C	CA-63-09
10	77C	CA-63-10
11	77C	CA-63-11
12	77C, 81B	CA-63-12
13	77C, 81B	TW-63-13
14	77C, 81B	TW-63-14
15	81B	TW-63-15
16	77C	TW-63-16
17	77C, 81B	TW-63-17
18	81B	TW-63-18
19	77C, 81B	TW-63-19

O. Reg. 348/89, Sched. 67.

Schedule 68

Abbreviations:

CA for Carleton Place

ITEM	COLUMN 1	COLUMN 2
1	77C	CA-64-01

O. Reg. 348/89, Sched. 68.

REGULATION 479

BOWS AND ARROWS

1. No person shall hunt deer with, or have in his or her possession while hunting deer,

- (a) a crossbow unless it has,
 - (i) a draw length of at least 300 millimetres, and
 - (ii) a draw weight of at least forty-five kilograms at the release latch mechanism or at some point between the release latch mechanism and the point of string rest;
- (b) a long-bow unless it has a draw weight of at least eighteen kilograms at a draw length of 700 millimetres or less;
- (c) an arrow that,
 - (i) is less than 600 millimetres in length,
 - (ii) has a head that is less than twenty-two millimetres at the widest part thereof, or
 - (iii) has a head that has less than two cutting edges that are sharp, unserrated, barbless, straight and made of steel; or
- (d) a bolt that has a head that,
 - (i) is less than twenty-two millimetres at the widest part thereof, or
 - (ii) has less than two cutting edges that are sharp, unserrated, barbless, straight and made of steel. R.R.O. 1980, Reg. 405, s. 1; O. Reg. 9/90, s. 1.

2. No person shall hunt moose or bear with, or have in his or her possession while hunting moose or bear,

- (a) a crossbow unless it has,
 - (i) a draw length of at least 300 millimetres, and
 - (ii) a draw weight of at least fifty-four kilograms at the release latch mechanism or at some point between the release latch mechanism and the point of string rest;
- (b) a long-bow unless it has a draw weight of at least twenty-two kilograms at a draw length of 700 millimetres or less;
- (c) an arrow that,
 - (i) is less than 600 millimetres in length,
 - (ii) has a head that is less than twenty-two millimetres at the widest part thereof, or
 - (iii) has a head that has less than two cutting edges that are sharp, unserrated, barbless, straight and made of steel; or
- (d) a bolt that has a head that,
 - (i) is less than twenty-two millimetres at the widest part thereof, or
 - (ii) has less than two cutting edges that are sharp, unserrated, barbless, straight and made of steel. R.R.O. 1980, Reg. 405, s. 2; O. Reg. 9/90, s. 2.

REGULATION 480

BULLFROGS

1.—(1) A licence to take bullfrogs for the purpose of sale or barter shall be in Form 1 and the fee therefor is \$36.75. O. Reg. 694/81, s. 1 (1); O. Reg. 522/86, s. 1; O. Reg. 622/89, s. 1; O. Reg. 607/90, s. 1.

(2) No licence in Form 1 shall be issued to a non-resident.

(3) A licence in Form 1 is valid only in the part or parts of Ontario prescribed in the licence.

(4) An application for a licence in Form 1 shall be in Form 2. O. Reg. 694/81, s. 1 (3-5).

(5) A licence in Form 1 expires with the 31st day of December next following the date of issue. O. Reg. 694/81, s. 1 (6); O. Reg. 89/90, s. 1 (2).

2. The following persons may take bullfrogs for personal use:

1. A holder of a licence in Form 1 (Ontario Resident Sport Fishing Licence) of Regulation 490 of Revised Regulations of Ontario, 1990 (Fishing Licences) to which a tag in Form 2 (Ontario Resident Four Day Sport Fishing Tag) or Form 3 (Ontario Resident Seasonal Sport Fishing Tag) of that Regulation is affixed.
2. A holder of a licence in Form 13 (Non-Resident/Canadian Resident Angling Licence) of Regulation 490 of Revised Regulations of Ontario, 1990 (Fishing Licences) to which a tag in Form 14 (Non-Resident Four Day Angling Tag), Form 15 (Non-Resident Twenty-One Day Angling Tag) or Form 16 (Non-Resident Seasonal Angling Tag) of that Regulation is affixed. O. Reg. 89/90, s. 2.

3. Bullfrogs may be taken from the 21st day of July to the 15th day of October, both inclusive, in any year. O. Reg. 694/81, s. 2.

4.—(1) Subject to subsection (3), no person other than the holder of a licence in Form 1 shall take more than ten bullfrogs in one day or possess more than ten bullfrogs at one time.

(2) No person shall take or possess, in the County of Lanark or The Regional Municipality of Ottawa-Carleton, any bullfrog unless the tibia thereof is five centimetres or more in length.

(3) Subsection (1) does not apply to the possession of bullfrogs purchased from the holder of a licence in Form 1. O. Reg. 694/81, s. 3.

5. The holder of a licence in Form 1 shall, in each year, make a return in Form 3 and send it by registered mail within thirty days after the day on which the open season for bullfrogs terminates to the district manager of the administrative district of the Ministry in which the licence was issued. O. Reg. 694/81, s. 4.

Form 1

Game and Fish Act

LICENCE TO TAKE BULLFROGS FOR SALE OR BARTER

No.....

19.....

Under the *Game and Fish Act* and the regulations and subject to the limitations thereof, this licence is granted to:

Name
Address

to take bullfrogs for sale or barter, in the County, Regional Municipality or District of

This licence expires with the 31st day of December next following the date of issue.

Signature of Issuer	District Office	Date
---------------------	-----------------	------

The holder of a licence is required to submit an Annual Return to the District Manager of the District in which the licence was issued within thirty days after the day on which the open season for bullfrogs terminates in the year in which the licence was issued. O. Reg. 694/81, Form 1; O. Reg. 522/86, s. 2.

Form 2

Game and Fish Act

APPLICATION FOR A LICENCE TO TAKE BULLFROGS FOR SALE OR BARTER

Under the *Game and Fish Act* and the regulations and subject to the limitations thereof,

Please Print Name:
(Surname) (Given Names)

Address:
(Number) (Street) (City/Town, etc.) (Province) (Postal Code)

makes application for a licence to take bullfrogs for sale or barter in the County, Regional Municipality or District of

Date of Application Day Month Year	Completed at (specify-Township, District, County, Regional Municipality, City, etc.)	Signature of Applicant

Form 3

Game and Fish Act

ANNUAL RETURN BY THE HOLDER OF A LICENCE TO TAKE BULLFROGS FOR SALE OR BARTER

Please Print

Name of Licensee	
Address of Licensee	
Licence No.	Licence Expires December 31st, 19.....

Number of Bullfrogs Taken	Number Actually Killed	Location—Marsh, Township, County, Regional Municipality or District

Sales of Bullfrogs:

Date	To Whom Sold	Number Sold for Human Consumption	Number Sold to Biological Supply House

Comments:

I certify that the foregoing information is true	Signature of Licensee	Date
--	-----------------------	------

Annual Return must be submitted to the District Manager of the District in which the licence was issued within thirty days after the day on which the open season for bullfrogs terminates in the year in which the licence was issued. O. Reg. 694/81, Form 4.

REGULATION 481

CALTON SWAMP HUNTING AREA

1. The Crown lands and lands in respect of which an agreement has been entered into under section 6 of the Act, described in the Schedule, are designated in accordance with paragraph 33 of section 92 of the Act. O. Reg. 30/81, s. 1.

2. Except as provided in this Regulation, no person shall hunt in the area described in the Schedule. O. Reg. 30/81, s. 2.

3. The holder of a licence in Form 5 of Regulation 500 of Revised Regulations of Ontario, 1990 may hunt ducks, geese, rails, coots, snipe and gallinules on any day except Sunday in the months of September and October during the open season therefor in any year during the hours between one-half hour before sunrise and one-half hour after sunset in the area described in the Schedule if,

- (a) the motor vehicle that he or she arrives in at the hunting area is parked in a parking area;
- (b) he or she hunts within an area that is not more than ten metres from a blind supplied by the Ministry of Natural

Resources and marked with the number of the parking area wherein the motor vehicle that he or she arrived in is parked;

- (c) the area or blind from which he or she hunts is occupied by not more than one other person; and
- (d) he or she keeps his or her firearm unloaded and encased except while occupying the blind or the area referred to in clause (b). O. Reg. 30/81, s. 3.

4. The holder of a licence in Form 5 of Regulation 500 of Revised Regulation of Ontario, 1990 may hunt such game for which the licence is valid during the open season therefor on any day, except Sunday, from the 1st day of November in any year to the last Saturday in February in the year next following, both inclusive, between the hours of one-half hour before sunrise and one-half hour after sunset, in the area described in the Schedule, if the motor vehicle that he or she arrives in at the hunting area is parked in a parking area. O. Reg. 30/81, s. 4.

5. In this Regulation, a reference to the Schedule is a reference to the Schedule to Ontario Regulation 30/81, as that Schedule read on December 31, 1990. *New*.

REGULATION 482

CAMDEN LAKE HUNTING AREA

1. The Crown lands described in the Schedule are designated in accordance with paragraph 33 of section 92 of the Act. R.R.O. 1980, Reg. 407, s. 1, *revised*.

2. Except as provided in this Regulation, no person shall hunt any animal or bird in the area described in the Schedule. R.R.O. 1980, Reg. 407, s. 2.

3. The holder of a licence in Form 5 of Regulation 500 of Revised Regulations of Ontario, 1990 may hunt ducks, rails, coots and gallinules on a Monday, Wednesday, Friday or Saturday during the open season therefor in any year during the hours between one-half hour before sunrise and one-half hour after sunset in the area described in the Schedule, upon condition that,

- (a) he or she parks his or her motor vehicle in an area designated as a parking area;
- (b) he or she hunts only within a radius of thirty feet from a stake planted and marked by an officer of the Ministry of Natural Resources with the number of the area in which his or her motor vehicle is parked;
- (c) the area from which he or she hunts is occupied by not more than one other person;
- (d) he or she keeps his or her firearm unloaded and encased except while occupying a hunting area; and
- (e) he or she enters and leaves the lands described in the Schedule through the area designated as a parking area. R.R.O. 1980, Reg. 407, s. 3.

4. In this Regulation, a reference to the Schedule is a reference to the Schedule to Regulation 407 of Revised Regulations of Ontario, 1980, as that Schedule read on December 31, 1990. *New*.

REGULATION 483

COPELAND FOREST HUNTING AREA

1. The Crown lands described in the Schedule are designated in

accordance with paragraph 33 of section 92 of the Act. O. Reg. 693/81, s. 1.

2. Regulation 512 of Revised Regulations of Ontario, 1990 applies to this Regulation except insofar as it is modified by this Regulation. O. Reg. 693/81, s. 2.

3. Except as provided in this Regulation, no person shall hunt in the area described in the Schedule. O. Reg. 693/81, s. 3.

4. Subject to Regulation 486 of Revised Regulations of Ontario, 1990, the holder of a licence in Form 5 of Regulation 500 of Revised Regulations of Ontario, 1990, may hunt fox, wolf, game birds, rabbits, raccoon and squirrel, other than red squirrel and, subject to the *Migratory Birds Convention Act* (Canada) and the regulations made thereunder, may hunt ducks, geese, rails, coots, woodcock, snipe and gallinules from the 15th day of September to the Saturday preceding the first Monday in December, both inclusive, in any year, during the open season in the area described in the Schedule if the holder parks the motor vehicle that he or she arrives in at the hunting area in a designated parking area in the area described in the Schedule. O. Reg. 563/83, s. 1.

5.—(1) Despite subsection 3 (2) of Regulation 500 of Revised Regulations of Ontario, 1990, the holder of a licence in Form 1 or 2 of that Regulation may hunt antlered and antlerless deer from the third Monday in October to the Sunday preceding the first Monday in December, both inclusive, in any year, in the area described in the Schedule if the holder parks the motor vehicle that he or she arrives in at the hunting area in a designated parking area in the area described in the Schedule. O. Reg. 563/83, s. 2.

(2) Only bows and arrows may be used while hunting deer during the period mentioned in subsection (1) in the area described in the Schedule. O. Reg. 693/81, s. 5 (2).

6.—(1) The holder of a licence in Form 1 or 2 of Regulation 500 of Revised Regulations of Ontario, 1990, may hunt deer from the first Monday in December to the third Tuesday next following, both inclusive, except Sundays, in the area described in the Schedule if,

- (a) less than twenty deer in total have been taken from the area described in the Schedule during the period mentioned in this subsection or any part of it;
- (b) the holder's name is drawn by lot in a draw administered by the Ministry of Natural Resources;
- (c) the holder obtains a licence in Form 1 of this Regulation and deposits the copy in a designated box at the main gate of the Copeland Forest;
- (d) there are not more than thirty-nine other persons hunting in the area described in the Schedule on any day; and
- (e) the holder parks the motor vehicle that he or she arrives in at the hunting area in a designated parking area in the area described in the Schedule. O. Reg. 563/83, s. 3.

(2) Only flint-lock or percussion cap muzzle loading guns may be used while hunting deer during the period mentioned in subsection (1) in the area described in the Schedule. O. Reg. 693/81, s. 6 (2).

7. No person may use or be accompanied by a dog while hunting deer in the area described in the Schedule. O. Reg. 693/81, s. 7.

8.—(1) The holder of a licence in Form 1 of this Regulation shall complete the questionnaire provided by the Ministry of Natural Resources and return the questionnaire to the office of the Ministry specified on it on or before the 31st day of December in the year on which the licence is issued.

(2) Any person who refuses or neglects to return the completed questionnaire to the Ministry as required by subsection (1) and in

accordance with it is ineligible to receive a licence in Form 1 of this Regulation in the year next following. O. Reg. 693/81, s. 8.

9. In this Regulation, a reference to the Schedule is a reference to the Schedule to Ontario Regulation 693/81, as that Schedule read on December 31, 1990. *New.*

Form 1

Game and Fish Act

COPELAND FOREST HUNTING AREA

FREE LICENCE TO HUNT DEER AND ANTLERLESS DEER TAG

No.

Under the *Game and Fish Act* and the regulations and subject to the limitations thereof, this licence is issued to:

Mr.
Miss
Mrs. (Last Name) (First Name) (Initial)
Ms.

of
(Street Address, P.O. Box, or Rural Route) (City, Town, Village)

being the holder of valid licence number to hunt
(Resident or Farmer's Licence to Hunt Deer in 19...)

antlered and antlerless deer in the area described in the Schedule to O. Reg. 693/81 on
(date(s) of authorization)

Date of Issue, 19..... Signature of Issuer

O. Reg. 693/81, Form 1.

REGULATION 484

APPENDIX A

CROWN GAME PRESERVES

Schedule 1

**PART I
CROWN LANDS**

CHAPLEAU CROWN GAME PRESERVE

1. This Part applies to Crown game preserves on Crown Lands. R.R.O. 1980, Reg. 409, s. 1.

All that land in the territorial districts of Algoma and Sudbury in the Province of Ontario described as follows:

2. There shall be Crown game preserves on Crown lands as described in the Schedules to Appendix A, each preserve to be known by the name appearing as the heading of the Schedule. R.R.O. 1980, Reg. 409, s. 2.

Beginning at the intersection of the centre line of the right of way of the Canadian Pacific Railway Company with the centre line of the right of way of the Algoma Central Railway Company in the geographic Township of Pearkes; thence southeasterly along the centre line of the right of way of the Canadian Pacific Railway Company to the intersection with the northwesterly bank of the Chapleau River, locally known as the Kebsquashing River; thence in a northeasterly direction along the westerly bank of the Chapleau River System composed of Chapleau Lake, Henderson Lake, D'Arcy Lake, Robinson Lake, Schewabik Lake, the Chapleau River and Kapuskasing Lake to the intersection of the centre line of the right of way of the Canadian National Railway Company; thence northwesterly along the centre line of that right of way to the intersection with the centre line of the right of way of the Algoma Central Railway Company in the geographic Township of Franz; thence southwesterly along the centre line of the right of way of the Algoma Central Railway Company to the place of beginning. O. Reg. 345/89, s. 1.

**PART II
LANDS OTHER THAN CROWN LANDS**

Schedule 2

3. This Part applies to Crown game preserves on lands other than Crown lands. R.R.O. 1980, Reg. 409, s. 3.

GEIKIE ISLAND CROWN GAME PRESERVE

4. The lands described in the Schedules to Appendix B are designated as Crown game preserves, each preserve to be known by the name appearing as the heading of the Schedule. R.R.O. 1980, Reg. 409, s. 4.

Geikie Island in Lake Nipigon in the Territorial District of Thunder Bay. R.R.O. 1980, Reg. 409, App. A, Sched. 2.

5.—(1) A resident of a Crown game preserve may under a licence in Form 1 possess traps, explosives, firearms or sporting implements on that part of the preserve owned or occupied by the resident.

(2) A licence in Form 1 expires with the 31st day of December next following the date on which it is issued. R.R.O. 1980, Reg. 409, s. 5.

Schedule 3**NIPISSING CROWN GAME PRESERVE**

In the geographic townships of Askin, Flett, Gladman, Gooderham, Hammell, Kenny, La Salle, Law, McLaren, Milne, Olive, Osborne and Sisk, in the Territorial District of Nipissing, and described as follows:

Beginning at the intersection of the southerly boundary of the geographic Township of Gladman with the northeasterly limit of that part of the King's Highway known as No. 11; thence northwesterly and northerly along the northeasterly limit of that highway limit to its intersection with the southerly limit of a travelled road in the geographic Township of Askin known as Seigny's Road; thence in a general northeasterly direction following that southerly limit to its intersection with the southwesterly limit of the right of way of the Ontario Northland Railway; thence southeasterly along that railway limit to the intersection with the southerly boundary of the geographic Township of Osborne; thence westerly along the southerly boundaries of the geographic townships of Osborne, Hammell and Gladman to the place of beginning. R.R.O. 1980, Reg. 409, App. A, Sched. 3.

APPENDIX B**Schedule 1****BRIGDEN CROWN GAME PRESERVE**

In the Township of Moore in the County of Lambton, and described as follows:

Beginning at the northwesterly angle of Lot 12, Concession VI; thence southerly along the westerly limit of Lot 12 through concessions VI to I, both inclusive, to the southerly limit of the Township of Moore; thence easterly along the southerly limit of the Township of Moore to the easterly limit of Lot 10, Concession I; thence northerly along the easterly limit of Lot 10, Concession I, and continuing northerly in a straight line to the southerly limit of Concession II; thence easterly along the southerly limit of Concession II to the westerly limit of a travelled road running northerly in Lot 9, Concession II; thence northerly along the westerly limit of that road to the southerly limit of Concession III; thence easterly along the southerly limit of Concession III to the easterly limit of Lot 7, Concession III; thence northerly along the easterly limit of Lot 7 through concessions III to VI, both inclusive, to the northerly limit of Concession VI; thence westerly along the northerly limit of Concession VI to the place of beginning. R.R.O. 1980, Reg. 409, App. B, Sched. I.

Schedule 2**CONESTOGO CROWN GAME PRESERVE**

In those parts of The Regional Municipality of Waterloo that, on the 31st day of December, 1972, were the townships of Woolwich and Waterloo in the County of Waterloo, and described as follows:

Beginning at a point in the Township of Woolwich where the southerly bank of the Conestogo River meets the westerly bank of the Grand River; thence in a general westerly direction along the southerly bank of the Conestogo River to the easterly limit of the road running southerly in Lot 2 in the Township of Woolwich; thence in a general southerly direction along the easterly limit of that road through Lot 2 in the Township of Woolwich and lots 65 and 66 in the Township of Waterloo to the northerly limit of a road running easterly from the first-described road to the Grand River in Lot 66 in the Township of Waterloo; thence in a general easterly direction along the northerly limit of the secondly-described road to the westerly bank of the Grand River in Lot 66; thence in a general northerly, easterly and northwesterly direction along the westerly bank of the Grand River to the place of beginning. R.R.O. 1980, Reg. 409, App. B, Sched. 2.

Schedule 3**CONROY MARSH CROWN GAME PRESERVE**

In the Township of Carlow, in the County of Hastings, and the Township of Raglan, in the County of Renfrew and described as follows:

1. Part of the Township of Carlow, in the County of Hastings, described as follows:

Beginning at the northeasterly corner of Lot 29, in Concession XII; thence westerly along the northerly limits of lots 29, 28, 27 and 26, in Concession XII, to the northwesterly corner of said Lot 26; thence southerly along the westerly limit of said Lot 26 to the southwesterly corner thereof; thence westerly in a straight line to the northeasterly corner of Lot 25, in Concession XI; thence westerly along the northerly limit of said Lot 25 to the northwesterly corner thereof; thence southerly along the westerly limit of said Lot 25 to the southwesterly corner thereof; thence easterly along the southerly limit of said Lot 25 to the southeasterly corner thereof; thence easterly in a straight line to the southwesterly corner of Lot 26, in Concession XI; thence easterly along the southerly limits of lots 26, 27 and 28 to the intersection with the inner limit of the road allowance laid out along the northerly shore of York River; thence in a general northeasterly direction following the said inner limit to the intersection with the easterly limit of Lot 29, in Concession XI; thence northerly along the easterly limit of Lot 29, in concessions XI and XII, to the point of beginning.

2. Part of the Township of Raglan in the County of Renfrew described as follows:

Beginning at a point in the easterly limit of Lot 9, in Concession XVI, distant 23 chains measured southerly along the said easterly limit from the northeasterly corner of said Lot 9; thence southerly along the easterly limit of Lot 9, in concessions XVI and XV, to the southeasterly corner of Lot 9, in Concession XV; thence westerly along the southerly limit of Lot 9 to the southwesterly corner of Lot 9, in Concession XV; thence southerly in a straight line to the northeasterly corner of Lot 8, in Concession XIV; thence southerly along the easterly limit of said Lot 8 to the southeasterly corner thereof; thence westerly along the southerly limits of lots 8, 7 and 6 to the southwesterly corner of said Lot 6; thence northerly along the westerly limit of said Lot 6 to the intersection with the inner limit of a 66 foot road allowance laid out along the southerly shore of York River; thence in a general northeasterly and northerly direction following the said inner limit to a point distant 7 chains measured westerly from and perpendicularly to the easterly limit of Lot 6, in Concession XV; thence northerly parallel to the easterly limit of said Lot 6 to the intersection with the inner limit of the 66 foot road allowance along the southerly shore of York River; thence in a general northeasterly direction following the said inner limit to the intersection with the westerly limit of Lot 8, in Concession XVI; thence northerly along the said westerly limit to the intersection with a line drawn west astronomically from the point of beginning; thence east astronomically to the point of beginning. R.R.O. 1980, Reg. 409, App. B, Sched. 3.

Schedule 4**DUMFRIES CROWN GAME PRESERVE**

That part of the City of Cambridge and of the Township of North Dumfries, in The Regional Municipality of Waterloo, described as follows:

Beginning at the intersection of the westerly limit of the right of way of The King's Highway No. 24 with the northerly limit of Lot 3, east of Grand River, Concession IX, as shown on the plan of the Township of Dumfries; thence in a general southerly direction along the westerly limit of the said right of way to the southerly boundary of the Township of North Dumfries; thence westerly along that boundary to the intersection with the easterly limit of the West River Road; thence in a general northerly direction along that limit to the

intersection with the northerly limit of Lot 3, west of Grand River, Concession IX, as shown on the plan of the Township of Dumfries; thence easterly along that limit and its join across the Grand River with the westerly extremity of the northerly limit of Lot 3, east of Grand River, Concession IX, as shown on the plan of the Township of Dumfries; thence continuing easterly along that limit to the place of beginning. O. Reg. 27/82, s. 1.

Schedule 5

HIMSWORTH CROWN GAME PRESERVE

In the geographic townships of Chisholm and East Ferris in the Territorial District of Nipissing and the geographic townships of North Himsworth and South Himsworth in the Territorial District of Parry Sound, and described as follows:

Beginning at the intersection of the northerly limit of Lot 12 in Concession XVI in the geographic Township of South Himsworth with the easterly limit of that part of the King's Highway known as No. 11; thence northerly following the easterly limit of that highway to its intersection with the southerly limit of Lot 5 in Concession XXIII in the geographic Township of North Himsworth; thence easterly along the last mentioned limit to the southeasterly angle of that lot; thence northerly along the easterly limit of that lot to the easterly limit of the last mentioned highway; thence northerly along the last mentioned limit to the southerly limit of the present travelled road known as the Booth Road in Lot 4 in Concession XXIV in the geographic Township of North Himsworth; thence easterly and following the southerly limit of that road to its intersection with the westerly limit of the lands of the Canadian National Railways in Lot 28 in Concession V in the geographic Township of East Ferris; thence southeasterly and southwesterly following the westerly limit of those lands to the easterly limit of Lot 11 in Concession XV in the geographic Township of South Himsworth; thence northerly along the easterly limit of that lot to the northeasterly corner thereof; thence westerly along the northerly limit of said Lot 11 to the northwesterly corner thereof; thence southerly along the westerly limit of the said lot to the intersection with the westerly limit of the lands of the Canadian National Railways; thence southwesterly along the westerly limit of those lands to the northerly limit of the road allowance between concessions XIV and XV; thence westerly along the northerly limit of the said road allowance to the intersection with the easterly limit of that part of the King's Highway known as No. 11; thence northerly along the easterly limit of the said King's Highway to the intersection with the westerly limit of Lot 12 in Concession XVI in the geographic Township of South Himsworth; thence southerly along the westerly limit of that lot to the southwesterly corner thereof; thence easterly along the southerly limits of lots 12 and 11 in Concession XVI in the geographic Township of South Himsworth to the southeasterly corner of said Lot 11; thence northerly along the easterly limit of Lot 11 to the northeasterly corner thereof; thence westerly along the northerly limits of lots 11 and 12 to the place of beginning. R.R.O. 1980, Reg. 409, App. B, Sched. 5.

Schedule 6

MINER CROWN GAME PRESERVE

In the Township of Gosfield South in the County of Essex, and described as follows:

Beginning at a point where the easterly limit of the McCain Side Road intersects the northerly limit of the road between concessions I and II; thence easterly along the northerly limit of the road between concessions I and II to the westerly limit of Division Road; thence northerly along the westerly limit of Division Road to the southerly limit of the road between concessions III and IV; thence westerly along the southerly limit of the road between concessions III and IV to the easterly limit of the McCain Side Road; thence southerly along the easterly limit of the McCain Side Road to the place of beginning. R.R.O. 1980, Reg. 409, App. B, Sched. 6.

Schedule 7

NOPIMING CROWN GAME PRESERVE

In part of the Township of McNab in the County of Renfrew, and in part of that part of The Regional Municipality of Ottawa-Carleton, that on the 14th day of June, 1968 was the Township of Fitzroy in the County of Carleton, and described as follows:

Beginning at a point in the Township of McNab where the northerly limit of the Canadian National Railway line intersects the easterly bank of the Madawaska River in Concession C of the Township of McNab; thence in a general easterly direction along that railway line through the Township of McNab in the County of Renfrew and the Township of Fitzroy in the former County of Carleton to the southeasterly limit of Lot 23, Concession V, in the Township of Fitzroy; thence northeasterly along the southeasterly limit of Lot 23, Concession V, to the southwesterly bank of the Mississippi River; thence northwesterly along the southwesterly bank of the Mississippi River and in a general westerly direction along the southerly bank of the Ottawa River to the easterly bank of the Madawaska River; thence southerly along the easterly bank of the Madawaska River to the place of beginning. R.R.O. 1980, Reg. 409, App. B, Sched. 7.

Schedule 8

PEMBROKE CROWN GAME PRESERVE

In the Township of Petawawa in the County of Renfrew and composed of lots 13 and 14, Lake Range. R.R.O. 1980, Reg. 409, App. B, Sched. 8.

Schedule 9

PETERBOROUGH CROWN GAME PRESERVE

In the townships of Belmont and Methuen and Burleigh and Anstruther, in the County of Peterborough, and described as follows:

Beginning at the intersection of the water's edge along the easterly shore of Jack Creek with the water's edge along the northerly shore of Stony Lake; thence northeasterly following the water's edge along the easterly shore of Jack Creek to the centre line of the allowance for road between lots 5 and 6, Concession XII, Old Survey, as shown on the plan of the Township of Burleigh; thence easterly along the said centre line to the centre line of a road known as the Nephelene Mine Road; thence in an easterly and northeasterly direction along the said centre line to the water's edge along the westerly shore of Kashaog Lake opposite Lot 14, Concession VIII, as shown in the plan of the Township of Methuen; thence in a general northeasterly direction along the said water's edge to the southerly production of the centre line of the allowance for road between concessions VI and VII; thence northerly along the said production and the centre line of the allowance for road between concessions VI and VII to the easterly production of the northerly limit of Lot 31, Concession VII; thence westerly along the said easterly production and the northerly limit of Lot 31, Concession VII, to the northwesterly corner thereof; thence westerly in a straight line across the allowance for road between concessions VII and VIII to the northeasterly corner of Lot 31, Concession VIII; thence westerly along the northerly limit of said Lot 31 to the water's edge along the westerly shore of Redmond Creek; thence in a southwesterly and westerly direction along the said water's edge to the intersection with the water's edge along the northerly shore of Redmond Bay of Jack Lake; thence in a general westerly direction following the said water's edge and the water's edge along the northerly shore of Jack Lake and the water's edge along the northerly shore of Brook Bay of Jack Lake to the easterly production of the northerly limit of Lot 14, Concession XVI, New Survey, as shown on the plan of the Township of Burleigh; thence westerly along that production and the northerly limit of Lot 14, concessions XVI and XV, to the northwesterly corner of said Lot 14, Concession XV; thence westerly in a straight line across the allowance for road between concessions XIV and XV, to the northeasterly corner of Lot 14, Concession XIV; thence westerly along the north-

erly limit of Lot 14, Concession XIV, to the northwesterly corner thereof; thence southerly along the easterly limit of lots 14 and 13, Concession XIII, to the southeasterly corner of said Lot 13; thence westerly along the southerly limit of said Lot 13 to the southwesterly corner thereof; thence westerly in a straight line across the allowance for road between concessions XIII and XII to the southeasterly corner of Lot 13, Concession XII; thence westerly along the southerly limit of said Lot 13 and along the westerly prolongation of the said southerly limit across the allowance for road along the easterly shore of Eels Creek to the water's edge thereof; thence southerly along the said water's edge to the westerly prolongation of the northerly limit of Lot 10, Concession XI; thence easterly along the said westerly prolongation and the northerly limit of said Lot 10 to the northeasterly corner thereof; thence southerly along the easterly limit of lots 10 and 9, Concession XI, to the southeasterly corner of said Lot 9; thence westerly along the southerly limit of Lot 9, Concession XI, to the southwesterly corner thereof; thence northerly along the westerly limit of said Lot 9 and along the northerly prolongation of the said westerly limit across the allowance for road along the easterly shore of Eels Creek to the water's edge thereof; thence in a southwesterly and southeasterly direction along the said water's edge to the intersection with the water's edge along the northerly shore of Stony Lake; thence in a general easterly direction along the said water's edge to the place of beginning. O. Reg. 517/85, s. 1.

Schedule 10

PUSLINCH CROWN GAME PRESERVE

In part of the Township of Puslinch in the County of Wellington, and in part of that part of The Regional Municipality of Waterloo that, on the 31st day of December, 1972, was the Township of Waterloo in the County of Waterloo, and described as follows:

All that territory within 500 yards of the highwater mark on the shore of Puslinch Lake located in lots 1 to 6, both inclusive, in Concession I of the Township of Puslinch. R.R.O. 1980, Reg. 409, App. B, Sched. 10.

Schedule 11

SHIRLEY BAY CROWN GAME PRESERVE

In those parts of The Regional Municipality of Ottawa-Carleton that, on the 14th day of June, 1968, were the townships of March and Nepean in the County of Carleton, and described as follows:

Beginning at a point where the northeasterly limit of the road between concessions IV and V in the Township of March intersects the southeasterly limit of the road between lots 15 and 16; thence in a general southeasterly direction along the northeasterly limit of the road between concessions IV and V through the Township of March to the boundary between the townships of March and Nepean; thence southerly along that boundary to its intersection with the northerly limit of the Canadian National Railways line; thence in a general southeasterly direction along that railway line through Concession A of the Township of Nepean to the northerly limit of the road between concessions A and I in that township; thence northeasterly along the northerly limit of the road between concessions A and I to the westerly limit of the road between lots 5 and 6, Concession A; thence northwesterly along the westerly limit of the road between lots 5 and 6 through Concession A and along the production of the westerly limit of that road in a straight line across the mouth of Shirley Bay in the Ottawa River to the highwater mark on the southerly shore of Einnis Point in the Township of March; thence in a general northerly and northwesterly direction along the highwater mark on the westerly bank of the Ottawa River to its intersection with the northeasterly production of the southeasterly limit of the road between lots 15 and 16 in the Township of March; thence southwest-erly along the production and along the southeasterly limit of the road to the place of beginning. R.R.O. 1980, Reg. 409, App. B, Sched. 11.

Schedule 12

YARMOUTH CROWN GAME PRESERVE

In the Township of Yarmouth in the County of Elgin and composed of,

- (a) lots 4 to 8, both inclusive, in Range I south of Edgeware Road;
- (b) lots 5 to 8, both inclusive, in Range I and II north of Edgeware Road; and
- (c) lots 5 to 8, both inclusive, in concessions X and XI. R.R.O. 1980, Reg. 409, App. B, Sched. 12.

Form 1

Game and Fish Act

19.....

No.

Under the *Game and Fish Act* and the regulations, and subject to the limitations thereof, this licence is granted to:

.....
of

to possess traps, explosives, firearms or sporting implements on the following lands:

.....
.....
.....

being lands owned or occupied by him or her in the

..... Crown Game Preserve.

This licence expires with the 31st day of December, 19.....

.....
Issuer

.....
(date)

.....
(signature of licensee)

R.R.O. 1980, Reg. 409, Form 1.

REGULATION 485

DISCHARGE OF FIREARMS FROM OR ACROSS HIGHWAYS AND ROADS

1. The counties and regional municipalities described in Schedules 1 and 2 are designated for the purpose of subsection 21 (1) of the Act. O. Reg. 603/89, s. 1.

2. The designation of a county or regional municipality in Schedule 2 is limited to when there is an open season for deer in the county or regional municipality other than a season during which only bows and arrows may be used to hunt deer. O. Reg. 603/89, s. 2.

Schedule 1

1. Brant.
2. Bruce.
3. Dufferin.
4. Dundas.
5. Durham.
6. Elgin.
7. Essex, except the Township of Pelee.
8. Frontenac, except the townships of Barrie, Clarendon, Hinchinbrooke, Kennebec, Miller, North Canonto, Olden, Oso, Palmerston and South Canonto.
9. Glengarry.
10. Grenville.
11. Grey.
12. Haldimand-Norfolk.
13. Halton.
14. Hamilton-Wentworth.
15. The townships of Hungerford, Huntingdon, Rawdon, Sidney, Thurlow and Tyendinaga, in the County of Hastings.
16. Huron.
17. Kent.
18. Lambton.
19. Lanark.
20. Lennox and Addington, except the townships of Abinger, Anglesea, Ashby, Denbigh, Effingham, Kaladar and Sheffield.
21. Leeds.
22. Middlesex.
23. Niagara.
24. Northumberland.
25. Ottawa-Carleton.
26. Oxford.
27. Peel.
28. Perth.
29. Peterborough, except the townships of Anstruther, Burleigh, Cavendish, Chandos, Galway, Harvey and Methuen.
30. Prescott.
31. Prince Edward.
32. Russell.
33. Simcoe.
34. Stormont.

35. Victoria, except the townships of Carden, Dalton, Digby, Laxton, Longford and Somerville.
36. Waterloo.
37. Wellington.
38. York. O. Reg. 603/89, Sched.1.

Schedule 2

1. The townships of Barrie, Clarendon, Hinchinbrooke, Kennebec, Miller, North Canonto, Olden, Oso, Palmerston and South Canonto, in the County of Frontenac.
2. Haliburton.
3. Hastings, except the townships of Hungerford, Huntingdon, Rawdon, Sidney, Thurlow and Tyendinaga.
4. The townships of Abinger, Anglesea, Ashby, Denbigh, Effingham, Kaladar and Sheffield, in the County of Lennox and Addington.
5. Muskoka.
6. The townships of Anstruther, Burleigh, Cavendish, Chandos, Galway, Harvey and Methuen, in the County of Peterborough.
7. Renfrew.
8. The townships of Carden, Dalton, Digby, Laxton, Longford and Somerville, in the County of Victoria. O. Reg. 603/89, Sched. 2.

REGULATION 486**DISCHARGE OF FIREARMS ON SUNDAY**

1. No person shall carry or discharge a firearm, other than a long-bow or a cross-bow, for the purpose of hunting on a Sunday, in,
 - (a) any county except,
 - (i) the County of Renfrew except the Township of Raglan,
 - (ii) the United Counties of Prescott and Russell, and
 - (iii) the Township of Haldimand in the County of Northumberland;
 - (b) any regional municipality lying south of the French and Mattawa rivers;
 - (c) The Municipality of Metropolitan Toronto; or
 - (d) the territorial districts of Muskoka and Parry Sound and that part of the Territorial District of Nipissing comprising the geographic townships of Boulter and Chisholm and the parts of the geographic townships of Ballantyne, Butt, Finlayson, McCraney and Paxton lying west of the westerly boundary of Algonquin Provincial Park. R.R.O. 1980, Reg. 411, s. 1.

2. This Regulation does not apply to a game bird hunting preserve licensed under Regulation 493 of Revised Regulations of Ontario, 1990. R.R.O. 1980, Reg. 411, s. 2.

REGULATION 487**FINGAL HUNTING AREA**

1. The Crown lands described in the Schedule are designated in accordance with paragraph 33 of section 92 of the Act. O. Reg. 28/81, s. 1.

2. Except as provided in this Regulation, no person shall hunt in the area described in the Schedule. O. Reg. 28/81, s. 2.

3. The holder of a licence in Form 5 of Regulation 500 of Revised Regulations of Ontario, 1990, may hunt ducks and geese on any day except Sunday, Tuesday or Friday, during the open season for ducks and geese in any year during the hours between one-half hour before sunrise and one-half hour after sunset in the area described in the Schedule if,

- (a) the motor vehicle that he or she arrives in at the hunting area is parked in an area designated as a parking area for waterfowl hunters;
- (b) he or she hunts within an area that is not more than ten metres from a blind supplied by the Ministry of Natural Resources and marked with the number of the parking area wherein the motor vehicle that he or she arrived in is parked;
- (c) the area or blind from which he or she hunts is occupied by not more than one other person; and
- (d) he or she keeps his firearm unloaded and encased except while occupying the blind or the area referred to in clause (b). O. Reg. 28/81, s. 3.

4. The holder of a licence in Form 5 of Regulation 500 of Revised Regulations of Ontario, 1990, may hunt the game for which the licence is valid, other than ducks and geese, on any day except Sunday, Tuesday or Friday, during the open season for the game in any year during the hours between one-half hour before sunrise and one-half hour after sunset in that part of the area described in the Schedule that is designated by signs for the hunting of game other than ducks and geese if,

- (a) the motor vehicle that he or she arrives in at the hunting area is parked in an area designated as a parking area for hunters hunting game other than ducks and geese; and
- (b) he or she keeps his or her firearm unloaded and encased except while he or she is in that part of the area described in the Schedule that is designated by signs for the hunting of game other than ducks and geese. O. Reg. 28/81, s. 4.

5. In this Regulation, a reference to the Schedule is a reference to the Schedule to Ontario Regulation 28/81, as that Schedule read on December 31, 1990. *New.*

REGULATION 488**FIREARMS—AULNEAU PENINSULA**

1. Despite the provisions of subsections 13 (2), (4), (5), (6), (7) and (8) of Regulation 500 of Revised Regulations of Ontario, 1990, no person while hunting with a shotgun in the area described in the Schedule shall have in his or her gun or on his or her person any shotgun shell loaded with ball or with shot larger than number two shot during the periods from,

- (a) the 15th day of April to the 15th day of June, both inclusive, in any year; and
- (b) the 1st day of September to the 15th day of December, both

inclusive, in any year. R.R.O. 1980, Reg. 412, s. 1; O. Reg. 428/82, s. 1.

2.—(1) Despite the provisions of subsections 13 (2), (4), (5), (6), (7) and (8) of Regulation 500 of Revised Regulations of Ontario, 1990, no person shall hunt with or have in his or her possession, while hunting, a rifle of greater calibre or projectile power than the rifle known as a .22-calibre rim-fire rifle in the area described in the Schedule during the periods from,

- (a) the 15th day of April to the 15th day of June, both inclusive, in any year; and
- (b) the 1st day of September to the 15th day of December, both inclusive, in any year. R.R.O. 1980, Reg. 412, s. 2 (1); O. Reg. 428/82, s. 2; O. Reg. 523/86, s. 1.

(2) The calibre limitation mentioned in subsection (1) does not apply to a flint-lock or percussion cap muzzle loading rifle. R.R.O. 1980, Reg. 412, s. 2 (2).

Schedule

Aulneau Peninsula west of Turtle Portage in the Territorial District of Kenora excluding all off shore islands in Lake of the Woods. R.R.O. 1980, Reg. 412, Sched.

REGULATION 489**FISHING HUTS**

1. In this Regulation, a reference to a Division is a reference to a division of waters described in Schedule IV to Ontario Fishery Regulations. O. Reg. 129/90, s. 1, *part.*

2. No person shall place or occupy or attempt to place or occupy any hut, other than a tent that is made of cloth or synthetic fabric and having a basal area not exceeding two square metres when erected, used for fishing on the ice of any of the waters described in the Schedule unless the hut bears on the outside, in numerals not less than two and one-half inches in height, the number assigned to the owner by an officer of the Ministry of Natural Resources in the administrative district where the water is located. R.R.O. 1980, Reg. 413, s. 1; O. Reg. 380/85, s. 1; O. Reg. 129/90, s. 1, *part.*

3. No person shall place, use, occupy or leave any hut used for the purpose of fishing, in any year,

- (a) after the last day of February, on the ice of any waters in Division 8;
- (b) after the 15th day of March, on the ice of,
 - (i) any waters in the part of Division 12 lying south of a line running east and west through the point of intersection of the King's Highway known as No. 17 and the King's Highway known as No. 533,
 - (ii) any waters in the part of Division 15 in the Township of Tudor,
 - (iii) Lake Scugog in Division 6 and in The Regional Municipality of Durham and Lake Simcoe in the County of Simcoe and in the regional municipalities of Durham and York, or
 - (iv) the part of Long Point Bay on Lake Erie in The Regional Municipality of Haldimand-Norfolk lying west of a line from the survey point at Turkey Point Marina, situate at approximate latitude 42 degrees 42 minutes north and longitude 80 degrees 19 minutes west, to the control survey monument on the northernmost point of Pottohawk Point, situate

at approximate latitude 42 degrees 36 minutes north and longitude 80 degrees 17 minutes west;

- (c) after the Monday following the third Sunday in March, on the ice of Colpoys Bay and Owen Sound, in the counties of Bruce and Grey; or
- (d) after the 31st day of March, on the ice of,
- (i) Lake Temagami in Division 26 and in the Territorial District of Nipissing,
 - (ii) Lake Timiskaming in Division 18 and in the territorial districts of Nipissing and Timiskaming,
 - (iii) Lake Manitou in Division 28 and in the Territorial District of Manitoulin, or
 - (iv) Trout Lake, situate at approximate latitude 46 degrees 18 minutes north and longitude 79 degrees 20 minutes west, in the City of North Bay and the Geographic Township of East Ferris in the Territorial District of Nipissing, Lake Nipissing or the French or Mattawa rivers or any waters south of them. O. Reg. 129/90, s. 2.

Schedule

1. The water known as Lake Couchiching in the County of Simcoe and The Regional Municipality of Durham.
2. The water known as Lake Simcoe in the County of Simcoe and the regional municipalities of Durham and York.
3. The water known as Puslinch Lake in the County of Wellington.
4. The water known as Lake Nipissing in the territorial districts of Nipissing, Parry Sound and Sudbury.
5. The water known as Lake Temagami in the Territorial District of Nipissing.
6. The waters known as Lake Scugog in The Regional Municipality of Durham.
7. The waters known as Lake Timiskaming in the territorial districts of Nipissing and Timiskaming.
8. The waters known as Lake Manitou in the Territorial District of Manitoulin.
9. That part of the waters known as Colpoys Bay, in the counties of Bruce and Grey, lying southwest of a line joining the most southerly angle of the Cape Croker Indian Reserve to the most southwesterly point on the shore of Kidd Point of White Cloud Island and of a line joining the last mentioned point to the most northerly point on the shore of Cape Commodore in the Township of Keppel.
10. Divisions 7, 8, 9, 10, 11, 12, 15 and 29.
11. Trout Lake, situate at approximate latitude 46 degrees 81 minutes north and longitude 79 degrees 20 minutes west in the City of North Bay and the Geographic Township of East Ferris in the Territorial District of Nipissing.
12. The part of Long Point Bay on Lake Erie in The Regional Municipality of Haldimand-Norfolk lying west of a line from the survey point at Turkey Point Marina, situate at approximate latitude 42 degrees 42 minutes north and longitude 80 degrees 19 minutes west, to the control survey monument on the northernmost point of Pottowhawk Point, situate at approximate latitude 42 degrees 36 minutes north and longitude 80 degrees 17 minutes west. R.R.O. 1980, Reg. 413, Sched.; O. Reg. 753/81, s. 2; O. Reg. 24/82, s. 1; O. Reg. 71/86, s. 2 (2); O. Reg. 574/86, s. 2; O. Reg. 129/90, s. 3.

REGULATION 490

FISHING LICENCES

1. In this Regulation,

“lake trout” includes common lake trout, Great Lakes trout, grey trout, Makinaw trout, siscowet and splake;

“muskellunge” includes the hybrid of the muskellunge and the northern pike;

“splake” means a cross breed of brook trout and lake trout;

“sport fishing” means the taking of fish for non-commercial purposes by angling or by means of hook and line, spear, dip net, bait fish trap, seine net or bow and arrow. O. Reg. 526/86, s. 1.

PART I

RESIDENT FISHING LICENCES

2.—(1) A licence issued to a resident to take fish by means of a sport fishing licence shall be in Form 1. O. Reg. 211/89, s. 1.

- (2) There is no fee for a licence in Form 1.

(3) A licence in Form 1 is not valid for sport fishing unless a tag in Form 2 or 3 is affixed to the reverse side thereof. O. Reg. 526/86, s. 2 (2, 3).

- (4) The fee for a tag,

(a) in Form 2 is \$6 and the issuing fee is 50 cents;

(b) in Form 3 is \$11 and the issuing fee is 50 cents. O. Reg. 526/86, s. 2 (4); O. Reg. 620/89, s. 1 (1, 2).

3.—(1) A licence issued to a resident to take bait fish for commercial use by means of a bait fish trap, dip net or seine net shall be in Form 4. O. Reg. 211/89, s. 2.

- (2) The fee for a licence in Form 4 to take bait fish by means of,

(a) a dip net, is \$7.75; and

(b) bait fish traps, is \$3.25 for each bait fish trap authorized by the licence. O. Reg. 526/86, s. 3 (2); O. Reg. 620/89, s. 2 (1, 2).

(3) The fee for a licence in Form 4 to take bait fish by means of a seine net whose dimensions are,

(a) not more than twenty metres by two metres, is \$15.50;

(b) more than twenty metres by two metres but not more than thirty-one metres by two and one-half metres, is \$23.50;

(c) more than thirty-one metres by two and one-half metres but not more than forty-six metres by two and one-half metres, is \$31.25. O. Reg. 526/86, s. 3 (3); O. Reg. 620/89, s. 2 (3-5).

4.—(1) A licence issued to a resident to take fish for commercial use by means of a gill net, pound net, trap net, trawl net, hoop net, seine net, dip net or trammel net, or by means of hooks, shall be in Form 5. O. Reg. 211/89, s. 3.

- (2) The fee for a licence in Form 5 to take fish by means of a gill net,

(a) in Lake Superior, Lake Huron, including Georgian Bay and North Channel, Lake Erie, except that part described in clause (b), and Lake Ontario, except the Bay of Quinte, is the greater of,

- (i) \$24, and

- (ii) \$4 for every 1,000 metres of gill net authorized by the licence;
- (b) in that part of Lake Erie east of a line drawn south 21° 31' east astronomically or approximately south 16° 30' east magnetically from a point where the high water mark on the north shore of Lake Erie is intersected by the boundary between the counties of Elgin and Kent, authorizing the estimated taking of,
- (i) not more than fourteen tonnes of fish, is \$60, and
- (ii) more than fourteen tonnes of fish, is \$150;
- (c) in Bay of Quinte of Lake Ontario is \$30;
- (d) in Lake Nipigon, authorizing the use of,
- (i) 5,500 metres of gill net, is \$36,
- (ii) 11,000 metres of gill net, is \$72, and
- (iii) 22,000 metres of gill net, is \$144; and
- (e) in any other waters, authorizing the use of,
- (i) 1,850 metres of gill net, is \$24, and
- (ii) 3,675 metres of gill net, is \$48.
- (3) The fee for a licence in Form 5 to take fish by means of pound nets,
- (a) in Lake St. Clair, is \$8.50; and
- (b) in other waters, is \$12,
- for each net authorized by the licence.
- (4) The fee for a licence in Form 5 to take fish by means of,
- (a) trap nets, is \$12 for each trap net authorized by the licence;
- (b) a trawl net, is \$120;
- (c) hoop nets, is \$3.75 for each hoop net authorized by the licence.
- (5) The fee for a licence in Form 5 to take fish by means of hooks,
- (a) in the Ottawa River, is \$30; and
- (b) in Lake St. Clair, is \$30 for every 300 hooks authorized by the licence.
- (6) The fee for a licence in Form 5 to take fish, other than sturgeon or trout of any species, in waters other than the Ottawa River and Lake St. Clair, is \$6 for every 150 hooks authorized by the licence.
- (7) The fee for a licence in Form 5 to take fish other than bait fish by means of a seine net,
- (a) in Long Point Bay of Lake Erie, is \$60;
- (b) in Lake St. Clair and the Detroit River and their tributaries lying within the counties of Essex and Kent, is \$12 for every 100 metres of seine net authorized by the licence; and
- (c) in other waters, is \$24 for every 100 metres of seine net authorized by the licence.
- (8) The fee for a licence in Form 5 to take fish by means of a trammel net is \$24 for every 100 metres authorized by the licence. O. Reg. 526/86, s. 4 (2-8).
- 5.—(1) A licence issued to a resident for a bait fish dealer's licence shall be in Form 6. O. Reg. 211/89, s. 4, *part*.

(2) The fee for a licence in Form 6 is \$15.50. O. Reg. 211/89, s. 4, *part*; O. Reg. 620/89, s. 3.

6.—(1) A licence issued to a resident to preserve bait fish shall be in Form 7. O. Reg. 211/89, s. 5, *part*.

(2) The fee for a licence in Form 7 is \$8. O. Reg. 211/89, s. 5, *part*; O. Reg. 620/89, s. 4.

7.—(1) The holder of a licence in Form 5 shall,

- (a) make,
- (i) a monthly return, in Form 8 where no fishing has been done under the licence during the month and in Form 9 in all other cases, and
- (ii) a return in Form 10 for every sale of fish, except a sale to the owner or manager of a fish plant registered under the *Fish Inspection Act* (Canada),

and forward the returns to the district manager or an officer designated by the district manager on or before the 8th day of the month following that for which the returns are made; and

- (b) make an annual return in Form 11 and forward the return to the district manager not later than the 31st day of January next following the expiry of the licence.

(2) The holder of a licence in,

- (a) Form 4 that authorizes the taking of bait fish for commercial use;
- (b) Form 6; or
- (c) Form 7,

shall make an annual return in Form 12 and forward the return to the issuer of the licence not later than the 15th day of January next following the date of expiry of the licence. O. Reg. 526/86, s. 7.

8.—(1) A licence to take lake herring, lake whitefish and pink salmon for personal use by means of a dip net may be issued only to a resident.

(2) The fee for a licence in Form 25 is \$11.50. O. Reg. 620/89, s. 5.

9.—(1) A licence issued to ship or transport live fish other than bait fish taken from Ontario waters shall be in Form 26.

(2) There is no fee for a licence in Form 26. O. Reg. 211/89, s. 6.

10. A licence in Form 4, 5, 6 or 7 may be transferred upon application therefor in a form provided by the Ministry. O. Reg. 526/86, s. 9.

PART II NON-RESIDENT FISHING LICENCE

11. In this Part, "Canadian resident" means a person who has resided in any part of Canada other than Ontario for a period of at least seven consecutive months during the twelve months immediately preceding the time that the person's residence becomes material under this Regulation. O. Reg. 526/86, s. 10.

12.—(1) A Non-Resident/Canadian Resident Angling Licence under the Ontario Fishery Regulations, 1989 shall be in Form 13. O. Reg. 620/89, s. 6.

(2) There is no fee for a licence in Form 13.

(3) A licence in Form 13 is not valid for angling unless a tag in Form 14, 15, 16, 17, 18 or 19 is affixed to the reverse side thereof.

(4) A licence in Form 13 is not valid for angling lake trout or muskellunge unless a tag in Form 20 or 21 is attached to the reverse side thereof.

(5) A tag in Form 14, 15, 16, 17, 18 or 19 affixed to the reverse side of a licence in Form 13 authorizes the holder of that licence to angle for fish, except lake trout and muskellunge, during the period specified on the tag.

(6) A tag in Form 14, 15, 16, 17, 18 or 22 shall only be issued to non-residents.

(7) A tag in Form 19 shall only be issued to Canadian residents.

(8) A tag in Form 20 or 21 may be issued to a non-resident or a Canadian resident. O. Reg. 526/86, s. 11 (2-8).

13.—(1) A Non-Resident/Canadian Resident Angling Licence issued in Form 13 to a person who is not a Canadian resident is not valid for angling in Lake St. Joseph, located at latitude 51° 05' north and longitude 90° 35' west, unless a tag in Form 27 is attached to the reverse side of the licence.

(2) There is no fee for a tag in Form 27. O. Reg. 435/90, s. 1.

14. The fee for a tag,

- (a) in Form 14 is \$15.50 and the issuing fee is \$0.75;
- (b) in Form 15 is \$27.25 and the issuing fee is \$1.50;
- (c) in Form 16 is \$33 and the issuing fee is \$1.50;
- (d) in Form 17 is \$22 and the issuing fee is \$1;
- (e) in Form 18 is \$22 and the issuing fee is \$1;
- (f) in Form 19 is \$22.25 and the issuing fee is \$0.75;
- (g) in Form 20 is \$6 and the issuing fee is \$0.50;
- (h) in Form 21 is \$6 and the issuing fee is \$0.50;
- (i) in Form 22 is \$3.25 and the issuing fee is \$0.25. O. Reg. 526/86, s. 12; O. Reg. 620/89, s. 7.

15. Where two persons are spouses of each other a tag in Form 17 shall be issued to one spouse and a tag in Form 18 shall be issued to the other spouse and these tags shall authorize the holders thereof to angle for fish, except muskellunge and lake trout, during the period specified on the tags. O. Reg. 526/86, s. 13.

16.—(1) In this section,

“houseboat” means a vessel fitted as a temporary or permanent dwelling;

“tourist establishment” means an establishment consisting of any one of or a combination of,

- (a) a cabin establishment,
- (b) a camping establishment,
- (c) a cottage establishment,
- (d) a hotel,
- (e) a motel,
- (f) a motor hotel,
- (g) an outpost establishment,
- (h) a resort, or
- (i) a tourist outfitter establishment,

as defined in Regulation 1037 of Revised Regulations of Ontario,

1990, and includes a houseboat that is used for commercial purposes and is registered in Ontario under the *Canada Shipping Act*.

(2) A licence in Form 13 is not valid for angling in the part of Ontario described in the Schedule unless the holder of the licence has on his or her person a tag in Form 22 with the date of angling inserted on it by a licence issuer.

(3) Subsection (2) does not apply to the holder of a licence in Form 13 who, at the time of angling,

- (a) has on his or her person a valid Crown land camping permit issued by the Ministry of Natural Resources;
- (b) is authorized to camp on Crown land under clause 2 (1) (b) of Regulation 971 of Revised Regulations of Ontario, 1990 and has the rental agreement on his or her person;
- (c) has a contract for accommodation with the operator of a tourist establishment;
- (d) has a contract with an air carrier licensed by the Canadian Transport Commission and Transport Canada for air transportation to and from an angling site within the part of Ontario described in the Schedule;
- (e) is the owner or the grandparent, parent, spouse, child, brother, sister or grandchild of the owner of real property located in or adjoining the part of Ontario described in the Schedule; or
- (f) has on his or her person a valid camp-site and vehicle permit or interior camping permit issued under Regulation 952 of Revised Regulations of Ontario, 1990.

(4) The holder of a licence in Form 13 to whom clause (3) (c), (d) or (e) applies shall, on the request of an officer, state to the officer,

- (a) the location and duration of the accommodation;
- (b) the name of the person with whom the holder has a contract for air transportation; or
- (c) the location of the real property,

as the case may be.

(5) A tag in Form 22 is valid only for the day indicated on it. O. Reg. 526/86, s. 14.

17.—(1) A licence issued to a non-resident who is a member of an organized camp shall be in Form 23. O. Reg. 211/89, s. 8.

(2) Each member of an organized camp shall pay a fee of \$3.50 for a licence in Form 23. O. Reg. 526/86, s. 15 (2); O. Reg. 620/89, s. 8.

(3) A licence in Form 23 shall not be issued unless at least five members of the organized camp apply for the licence.

(4) A licence in Form 23 is valid during the period specified therein. O. Reg. 526/86, s. 15 (3, 4).

18.—(1) A licence issued to a non-resident to take fish by means other than angling shall be in Form 24. O. Reg. 211/89, s. 9 (1).

(2) A licence in Form 24 is valid only during the months of March, April, May, June and July. O. Reg. 526/86, s. 16 (2).

(3) The fee for a licence in Form 24 is \$10.50 and the issuing fee is \$1. O. Reg. 211/89, s. 9 (2); O. Reg. 620/89, s. 9.

PART III GENERAL

19. A licence in a form other than Form 23 or 24 expires with the date specified in the licence or in the tag attached to the licence or, if

no such date is specified, with the 31st day of December following the date of issue of the licence. O. Reg. 620/89, s. 10.

20. The fee for the replacement of any sport fishing licence is \$6.25. O. Reg. 526/86, s. 18; O. Reg. 620/89, s. 11.

21. No licence prescribed in this Regulation is valid unless signed by the issuer and the licensee. O. Reg. 526/86, s. 19; O. Reg. 620/89, s. 12.

Schedule

In the territorial districts of Kenora and Rainy River described as follows:

All the waters of Rainy Lake, Rainy River, Lake of the Woods, Shoal Lake, Cul de Sac Lake and Obabikou Lake, and the Seine River system, including Little Grassy Lake, Grassy Lake, Shoal Lake, Wild Potato Lake and Partridge Crop Lake, lying downstream of Crilly Dam situated immediately north of the King's Highway known as Number 11. O. Reg. 526/86, Sched.



Form 1

Game and Fish Act

**ONTARIO RESIDENT
SPORT FISHING LICENCE 19.....**

Under the *Game and Fish Act* and the regulations, and subject to the limitations thereof, and the limitations of the *Fisheries Act (Canada)* and of the Ontario Fishery Regulations, 1989, this licence is granted to

Ontario Resident

*Tag and
Issuing Fee*
\$

Seasonal

Four Day

\$

Last Name (Print)

Mr./
M.
Mrs.

--	--	--	--	--	--	--	--	--	--	--	--	--	--	--	--	--	--	--	--	--

First Name (Print)

Initial

--	--	--	--	--	--	--	--	--	--	--	--	--	--	--	--	--	--	--	--	--

--	--

Street Address, Apt. No., P. O. Box or Rural Route

--	--	--	--	--	--	--	--	--	--	--	--	--	--	--	--	--	--	--	--	--

City, Town or Village

--	--	--	--	--	--	--	--	--	--	--	--	--	--	--	--	--	--	--	--	--

Prov.

Postal Code

--	--	--	--	--	--	--	--	--	--	--	--	--	--	--	--	--	--

--	--	--	--	--	--	--	--	--	--	--	--	--	--	--	--	--	--

This licence is not valid unless appropriate Tag is affixed to reverse side and signed by Licence Issuer

Identification

Date of Birth		
Day	Month	Year
Height	Colour of Hair	

Issuer Number					

Signature of Licensee	Date of Issue	Signature of Issuer



Ministry of
Natural
Resources

Ontario

Form 2

Game and Fish Act

**ONTARIO RESIDENT FOUR DAY
SPORT FISHING TAG 19.....**

Valid for 4 consecutive days from Fee \$.....

Day	Month	Year	to	Day	Month	Year

O. Reg. 526/86, Form 2.



Ministry of
Natural
Resources

Ontario

Form 3

Game and Fish Act

**ONTARIO RESIDENT SEASONAL
SPORT FISHING TAG 19.....**

Expires with the 31st day of December 19..... Fee \$.....

O. Reg. 526/86, Form 3.



Ministry of
Natural
Resources

Ontario Ministère des
Richesses
naturelles

**Form 4
Formule 4**

*Game and Fish Act
Loi sur la chasse et la pêche*

**Commercial Bait Fish Licence
Permis de prise de poisson d'appât à des fins commerciales**

Licence No. Permis n°
Licence fee Droits \$

Under the *Game and Fish Act*, and the regulations, and subject to the limitations thereof and the limitations of the *Fisheries Act* (Canada) and of the Ontario Fishery Regulations, 1989, this licence is granted to
En vertu de la Loi sur la chasse et la pêche et de ses règlements d'application, et sous réserve des restrictions qui y figurent et qui figurent dans la Loi sur les pêches (Canada) et les règlements de 1989 de la pêche en Ontario, le présent permis est délivré à

Name
Nom

Address
Adresse

to take
pour la prise de

for commercial use by means of not more than
à des fins commerciales à l'aide d'au plus

in the public waters of
dans les eaux publiques

.....

.....

.....

This licence expires with the 31st of December, 19.....
Ce permis expire le 31 décembre 19.....

This licence is issued subject to further licences being granted for the public waters mentioned hereon.
Ce permis est délivré sous réserve de la délivrance d'autres permis pour les eaux publiques mentionnées aux présentes.

Date of Issue
Date de délivrance

Place of Issue
Lieu de délivrance

Not valid unless signed by Issuer
N'est valide qu'une fois signé par le responsable qui l'a délivré

Signature of Issuer
Signature du responsable qui délivre le permis

O. Reg. 526/86, Form 4, revised.



Ministry of
Natural
Resources

Ontario Ministère des
Richesses
naturelles

**Form 5
Formule 5**

*Game and Fish Act
Loi sur la chasse et la pêche*

Commercial Fishing Licence
Permis de pêche commerciale

Licence No.
Permis n°

Licence fee
Droits

\$

Under the *Game and Fish Act*, and the regulations, and subject to the limitations thereof and the limitations of the *Fisheries Act* (Canada) and of the Ontario Fishery Regulations, 1989, this licence is granted to

En vertu de la Loi sur la chasse et la pêche et de ses règlements d'application, et sous réserve des restrictions qui y figurent et qui figurent dans la Loi sur les pêches (Canada) et les règlements de 1989 de la pêche en Ontario, le présent permis est délivré à

Name(s)
Nom(s)

Mailing Address
Adresse postale

Postal Code
Code postal

To take and sell: the specified species of fish in the quantities specified herein subject to the conditions attached and marked Appendix "A", "B" and "C" which all form part of this licence, and in the waters as described below:

pour la prise et la vente des espèces et des quantités de poissons indiquées aux présentes, sous réserve des conditions stipulées aux annexes «A», «B» et «C» de ce permis et dans les eaux décrites ci-dessous :

This licence is issued subject to further licences being granted for the waters mentioned hereon. This licence is issued subject to annual amend-

ment in respect to quota or other management requirements.

Ce permis est délivré sous réserve de la délivrance d'autres permis pour les eaux mentionnées aux présentes et de sa modification annuelle en matière de contingents ou autres exigences de gestion.

Signature of Licensee(s) Signature du ou des titulaires
--

Date of Issue Date de délivrance	Expiry Date Date d'expiration	Place of Issue Lieu de délivrance
Not valid unless signed by Licence Issuer and Licensee(s). N'est valide qu'une fois signé par le responsable qui l'a délivré et le ou les titulaires.		Signature of Licence Issuer Signature du responsable qui délivre le permis



Ministry of
Natural
Resources

Ontario Ministère des
Richesses
naturelles

Commercial Fishing Licence
Permis de pêche commerciale

Appendix A
Annexe A

The person(s) holding licence no. is/are authorized to take and transport commercial fish by means of the vessels as described below:
Le ou les titulaires du permis n° sont autorisés à prendre et à transporter du poisson commercial à l'aide des bateaux décrits ci-dessous :

Identification Identification

I, we
Je, nous,

The person(s) holding licence no. designate the person(s) named hereunder to conduct on my/our behalf in my/our absence commercial fishing under the authority of licence no.:

Le ou les titulaires du permis n° désignent la ou les personnes dont le nom est indiqué ci-dessous pour faire de la pêche commerciale en vertu du permis n°, en son ou en leur absence :

Designate Personne(s) désignée(s)	Signature of Designate Signature(s) de la ou des personnes désignées

Not valid unless signed by Licence Issuer and Licensee(s).

N'est valide qu'une fois signé par le responsable qui l'a délivré et le ou les titulaires.

Signature of Licensee(s) Signature(s) du ou des titulaires	Signature of Licence Issuer Signature du responsable qui délivre le permis	Date of Issue Date de délivrance
---	---	-------------------------------------



Ministry of
Natural
Resources

Ontario Ministère des
Richesses
naturelles

Commercial Fishing Licence Conditions
Conditions d'un permis de pêche commerciale

Appendix B
Annexe B

The person(s) holding Commercial Fishing Licence No. may take the specified species of fish mentioned in Column I of Appendix C in the specified quantities mentioned in Column 2 of Appendix C, subject to the following conditions:

Le ou les titulaires du permis de pêche commerciale n° sont autorisés à prendre les espèces et les quantités de poissons indiquées respectivement dans les colonnes I et 2 de l'annexe C, sous réserve des conditions suivantes :

--

I have read and understand the conditions of this licence. J'ai lu et je comprends les conditions rattachées à ce permis.	Signature of Licensee(s) Signature(s) du ou des titulaires
Date of Issue Date de délivrance	Place of Issue Lieu de délivrance
Not valid unless signed by Licence Issuer and Licensee(s). N'est valide qu'une fois signé par le responsable qui l'a délivré et le ou les titulaires.	Signature of Licence Issuer Signature du responsable qui délivre le permis



Ministry of
Natural
Resources

Ontario Ministère des
Richesses
naturelles

Commercial Fishing Licence Quotas
Contingents du permis de pêche commerciale

Appendix C
Annexe C

Licence No.
Permis n°

Legend: (No.) - Amount of Quota
Légende: - Importance des contingents
Unl. - Unlimited Quotas
- Contingents illimités
X - No Harvest Permitted
- Pas de capture permise

Fish Species Espèces de poissons	Quantities of the named fish species in kilogram in round weight for which this licence is valid in Fishing Area No. (specify) Poids arrondi en kilogrammes des espèces de poissons dont la prise est autorisée par ce permis dans la région de pêche n° (préciser)	
Signature of Licensee(s) Signature(s) du ou des titulaires	Place of Issue Lieu de délivrance	
Serial No. N° de série	Date of Issue Date de délivrance	Signature of Licence Issuer Signature du responsable qui délivre le permis

Not valid unless signed by Licence Issuer and Licensee(s)
N'est valide qu'une fois signé par le responsable qui l'a délivré et le ou les titulaires

O. Reg. 526/86, Form 5, revised.



Ministry of
Natural
Resources

Ontario

Form 6*Game and Fish Act*

Bait-Fish Dealer's Licence 19.....

Licence Fee \$

Under the *Game and Fish Act*, and the regulations, and subject to the limitations thereof and the limitations of the Ontario Fishery Regulations, 1989, this licence is granted to

Name	
Address	
OF	
to deal in bait-fish at _____	
This licence expires with the 31st of December, 19.....	This licence cannot be either assigned or transferred.
Date of Issue	Place of Issue
Not valid unless signed by Issuer	Signature of Issuer

O. Reg. 526/86, Form 6.



Ministry of
Natural
Resources

Ontario

Form 7*Game and Fish Act*

Licence to Preserve Bait-Fish 19.....

Licence fee \$

Under the *Game and Fish Act*, and the regulations, and subject to the limitations thereof and the limitations of the Ontario Fishery Regulations, 1989, this licence is granted to

Name	
Address	
OF	
to preserve bait-fish at _____	
This licence expires with the 31st of December, 19.....	This licence cannot be either assigned or transferred.
Date of Issue	Place of Issue
Not valid unless signed by Issuer	Signature of Issuer

O. Reg. 526/86, Form 7.



Ministry of
Natural
Resources

Ontario

Form 8

Game and Fish Act

Report of Nil Commercial Fishing

Game and Fish Act

(Complete separate form for each licence)

Name of Licensee		Licence No.
Mailing Address		
		Postal Code
Lake	Port	

My commercial fish harvest for the period of

..... to

Day Month Year Day Month Year

is nil.

Important:

1. Commercial Fishing Licence holders operating on waters except Lake Erie must submit this return by the 8th day of the month following any month in which no fishing was done.
2. Lake Erie licensees must submit this return by the Monday following any week in which no fishing was done.

This return is a true, complete and correct statement of fishing operations carried on by me during the period specified herein.

Signature of the holder of the licence for which this return is made	Date		
	Day	Month	Year

Note: A nil report is not required for a commercial fishing licence for those months during which that licence is not valid.

O. Reg. 526/86, Form 8.

Form 9

Ontario
Ministry of Natural Resources
Monthly Report of Commercial Fisheries

Port where Fish Landed
Lake
Current Licence No.
For Head Office Use

Month (in which fishing was actually done)
Postal Address
Postal Code

No. of men in Crew
Issued to - Name

Boat No. Kind (Tug, Rowboat, Canoe, etc.)
Weight of catch by species in lbs. kg.

Table with 2 columns:
** Trawl Nets: No. of hauls, Av. Depth, Mesh Size
*** Gill Nets: No. of hauls, Av. Depth, Mesh Size

Main table with 15 rows (Day 1-15) and 20 columns (Species: Bullheads, Burbot or Ling, Carp, Catfish, Cavier, Chub or Tullibee, Crappie, Eels, Freshwater Drum, Lake Herring, Lake Trout, Lake Whitefish, Pike, Rock Bass, Round Whitefish or Menominee, Saugers, Smelt, Sunfish, Surgeon, Suckers or Mullets, White Bass, White Perch, Yellow Perch, Yellow Pickerel, Mixed fish or discarded fish for animal food).

Please be sure to show: Where fish were landed - Port or Landing Point. Specific Location of fishing activities, every day. Amount of gear lifted for every day that you fished. Form of fish sold - Round, Dressed or Filleted - with average price per pound or kg. Fish sold live, sold for animal food, unsold or discarded, in the time at X below.

This report is due by the eighth of the month.

Ministry of Natural Resources

Ontario

Code to be Used
 R -- Round
 O -- Dressed
 H -- Headless Dressed
 F -- Filled
 L -- Live

Indicate Measure Used
 Kilograms
 Pounds

Ministry of Natural Resources
 Ontario



Sold to (Name of Buyer)	Yellow Perch			Whitefish			Species not TROUT			Yellow Pike			Northern Pike			Other (list)		
	Weight Form Code #	Form Code #	Code #	Weight Form Code #	Form Code #	Code #	Weight Form Code #	Form Code #	Code #	Weight Form Code #	Form Code #	Code #	Weight Form Code #	Form Code #	Code #	Weight Form Code #	Form Code #	Code #

Notes

- Use this column for pound nets, traps, hoop nets, seines, baited hooks, trolling lines and dip nets, to show type of gear and lifts. For hoop nets, show the number of pots lifted, to overcome the difficulty arising from single and double sets. For seines, show length in yards and number of hauls made for each day, as for example: 100-2, to indicate a one hundred yard seine hauled twice. For baited hooks, show the number of hooks lifted for each day that fish were landed.
- Use the three columns below for trawling operations, to show the number of hauls made each day, the depth in fathoms, and cod end mesh size.
- Use the three columns below for gill net operations, to show the amount of net lifted

Additional observations or comments may be made below.

each day fish were landed, depth of net in number of meshes, and size of mesh fished. Use separate report forms if different mesh sizes (small, large, etc.) have been fished.

This report is the only source of complete detailed information about the commercial fishery. Data compiled from these reports is necessary for fishery research, business interests and for the best management of the fishery, and is frequently of value in supporting the continuation or introduction of commercial fishing in specific areas. The value of these statistics is dependent upon the proper and accurate completion, and prompt submission of this report, as required by regulation.

This return contains a complete and accurate account of sales to fish buyers carried on by me during the month of

Signature of Person Holding Licence: _____ Date: _____

License No. _____



Ministry of
Natural
Resources

Ontario

Form 10

Game and Fish Act

Official Receipt and Export Permit

No.

Fish caught under the authority of licence no.

Code to be used F — filleted D — dressed R — round	H — headless dressed L — live	Indicate measure used <input type="checkbox"/> Pounds <input type="checkbox"/> kilograms
---	----------------------------------	--

Fish sold to or Exported to (check one)

Name	Date month	day	19...
Address			

Species	Weight	Form (use Code above)	Price	Amount
Yellow pickerel				
Lake whitefish				
Northern pike				
Yellow perch				
Lake Trout				
Other(s)—list				
Total				

I certify that the above information is true and complete.

Signature of Licensee or Vendor	Signature of Receiver
---------------------------------	-----------------------

O. Reg. 526/86, Form 10.



Form 11

Game and Fish Act

Annual Commercial Fishing Report

Do not include in this report any information shown on an Annual Commercial Fishing Report for another licence this year

To _____ For the year ending December 31, 198 _____
 Conservation Officer

Commercial Fishing Licence Number Name of Licensee Home Port or Address NEW CAPITAL INVESTMENT (Purchases during the year of "New" equipment not "Used" equipment)				Number of fishermen engaged in fishery: (Where owner exists he should be included but, do not show men already included under another licence)		
				FISH CAUGHT DURING THE YEAR		
				KIND	QUANTITY LBS.	PRICE PER POUND
KIND						
TOTAL COST \$						
Diesel and Gas Engines, Outboard Motors						00
Tugs, Boats, Canoes, etc.						00
Gear: Nets, Trawls, Ropes, Floats, Winches, etc.						00
Wheelhouse Equipment, Radios, Radar, etc.						00
Check if no new equipment purchased during year <input type="checkbox"/>						
FISHING CRAFT OR BOATS (Including Motor)						
DEPARTMENT OF TRANSPORT No.						
LENGTH	NUMBER OF BOATS	TONNAGE (TONS)	VALUE \$			
40 Feet and over			00			
20 Feet to 39 Feet			00			
Under 20 Feet			00			
FISHING GEAR REPORT ALL GEAR ON HAND						
KIND	NUMBER	LENGTH (YARDS)	VALUE \$			
1 Gill Net			00			
2 Pounds-Net			00			
3 Trap-Net			00			
4 Hoop-Net (No. of Pots)			00			
5 Seines			00			
6 Night Lines (No. of Hooks)			00			
7 Trolling Lines			00			
8 Dhp-Net			00			
9 Trawls			00			
SHORE INSTALLATIONS						
KIND	NUMBER	VALUE \$				
Freezers and Ice Houses		00				
Piers and Wharves		00				
Net Sheds		00				

LOCALITY:

DEPARTMENT USE ONLY

This Return contains a complete and correct statement of fishing operations carried on by me during the year.

Date _____ 19__

Signature of Licensee _____

An Annual Commercial Fishing Report is to be made by each holder of a commercial fishing licence within 30 days of the end of the year reported or required under The Game and Fish Act.
 You are required to submit this report whether or not you fished during the year and making sure the left hand portion of this report is completed.



Ministry of
Natural
Resources

Ontario

Form 12

Game and Fish Act

Annual Return By Commercial Bait-Fish Licensees

Year 19.....

Name	Address	Location (or Township) of Public Waters Fished	Bait-Fish Dealers Lic. No.
------	---------	--	----------------------------

Monthly Record of Harvest and Disposition of Bait Fish

Species Caught by Fishermen in Public Waters

Species	Unit of Measure	Jan.	Feb.	March	April	May	June	July	Aug.	Sept.	Oct.	Nov.	Dec.										
Emerald Shiners														<table border="1"> <tr> <td>Men Engaged</td> <td>No.</td> <td>No. of Weeks</td> </tr> <tr> <td>Full time</td> <td></td> <td></td> </tr> <tr> <td>Part time</td> <td></td> <td></td> </tr> </table>	Men Engaged	No.	No. of Weeks	Full time			Part time		
Men Engaged	No.	No. of Weeks																					
Full time																							
Part time																							
Golden Shiners																							
Suckers																							
Chubs																							
Dace																							
Fatheads																							
Other (specify)																							
Other (specify)														Total Catch									

Species Propagated

Species	Jan.	Feb.	March	April	May	June	July	Aug.	Sept.	Oct.	Nov.	Dec.	Annual Total Propagated

Disposition

Annual Total Annual Value

Disposition	Jan.	Feb.	March	April	May	June	July	Aug.	Sept.	Oct.	Nov.	Dec.	Annual Total	Annual Value
Quantity Preserved														\$
Quantity Bought														\$
Sold to Anglers														\$
Sold to Dealers														\$

Capital Equipment

Holding and Transport Equipment

Fishing Gear and Equipment

	Holding and Transport Equipment							Fishing Gear and Equipment						
	Ponds	Tanks	Live Boxes	Mobile Tanks	Aeration Equipment	Trucks	Aircraft	Boats	Dip-Nets	Seines	Traps	Pumps		
Number								Number						
Type or Construction								Size						
Value								Value						

I certify the above return is complete and correct	Signature	Date	<input type="checkbox"/> Check here if reverse of form used for comments
--	-----------	------	--



Ministry of Natural Resources

Ontario

Form 13

Game and Fish Act

NON-RESIDENT/CANADIAN RESIDENT ANGLING LICENCE 19.....

(Not required by a resident of Ontario.)

Under the Game and Fish Act and the regulations, and subject to the limitations thereof, and the limitations of the Fisheries Act (Canada) and of the Ontario Fishery Regulations, 1989, this licence is granted to

Last Name (Print)

Mr./ M. Mrs. [Grid for last name]

First Name

Initial

[Grid for first name] [Grid for initial]

Street Address, Apt. No., P.O. Box or Rural Route

[Grid for street address]

City, Town or Village

[Grid for city]

Prov. or State

Postal Code

[Grid for province]

[Grid for postal code]

This licence is not valid unless appropriate Tag is affixed to reverse side and signed by Licence Issuer

Non-Resident	Tag and Issuing Fee
<input type="checkbox"/> Four Day	\$
<input type="checkbox"/> Twenty one day	\$
<input type="checkbox"/> Seasonal	\$
<input type="checkbox"/> Muskellunge	\$
<input type="checkbox"/> Lake Trout	\$
<input type="checkbox"/> Spousal (per Spouse)	\$

Canadian Resident	
Seasonal	\$
<input type="checkbox"/> Muskellunge	\$
<input type="checkbox"/> Lake Trout	\$

Identification

Date of Birth		
Day	Month	Year
[Grid]	[Grid]	[Grid]
Height	Colour of Hair	
[Grid]	[Grid]	

Issuer Number [Grid]

Signature of Licensee	Date of Issue	Signature of Issuer
-----------------------	---------------	---------------------

O. Reg. 526/86, Form 13.



Ministry of Natural Resources

Ontario

Form 14

Game and Fish Act

NON-RESIDENT FOUR DAY ANGLING TAG 19.....

Valid for 4 consecutive days from

Fee \$.....

Day	Month	Year	to	Day	Month	Year
[Grid]	[Grid]	[Grid]		[Grid]	[Grid]	[Grid]

O. Reg. 526/86, Form 14.



Ministry of Natural Resources

Ontario

Form 15

Game and Fish Act

NON-RESIDENT TWENTY-ONE DAY ANGLING TAG 19.....

Valid for 21 consecutive days from

Fee \$.....

Day	Month	Year	to	Day	Month	Year

O. Reg. 526/86, Form 15.



Ministry of Natural Resources

Ontario

Form 16

Game and Fish Act

NON-RESIDENT SEASONAL ANGLING TAG 19.....

Expires with the 31st day of December 19.....

Fee \$.....

O. Reg. 526/86, Form 16.



Ministry of Natural Resources

Ontario

Form 17

Game and Fish Act

NON-RESIDENT SPOUSAL ANGLING TAG A 19.....

Expires with the 31st day of December 19.....

Fee \$.....

O. Reg. 526/86, Form 17.



Ministry of Natural Resources

Ontario

Form 18

Game and Fish Act

NON-RESIDENT SPOUSAL ANGLING TAG B 19.....

Expires with the 31st day of December 19.....

Fee \$.....

O. Reg. 526/86, Form 18.



Ministry of Natural Resources

Ontario

Form 19

Game and Fish Act

CANADIAN RESIDENT ANGLING TAG (SEASONAL) 19.....

Expires with the 31st day of December 19.....

Fee \$.....

O. Reg. 526/86, Form 19.



Ministry of Natural Resources

Ontario

Form 20

Game and Fish Act

NON-RESIDENT/CANADIAN RESIDENT LAKE TROUT TAG 19.....

This tag is valid only in conjunction with and for time period indicated on valid Time Validation Tag.

Fee \$.....

O. Reg. 526/86, Form 20.

Who is a member of:/Qui est membre du :

Name of Camp/Camp		Location (Lake)/Situé à (lac)
-------------------	--	-------------------------------

Signature of Issuer/Signature du responsable	Date of Issue/Date de délivrance	Signature of Licencee/Signature du titulaire
--	----------------------------------	--

O. Reg. 526/86, Form 23, revised.



Ministry of
Natural
Resources

Ontario

Form 24

Game and Fish Act

Non-Resident Angling Licence to Take Fish By Means Other Than Angling 19.....

Under the *Game and Fish Act*, and the regulations, and subject to the limitations thereof and the limitations of the *Fisheries Act (Canada)* and of the Ontario Fishery Regulations, 1989, this licence is granted to

Licence Fee
Droits
Issuing Fee
Droits de délivrance
Total Fee

Last Name (Print)

Mr./
M.
Mrs./

--

First Name (Print) Initial

--	--

Identification/Renseignements personnels

Date of Birth/Date de naissance		
Day/	Month/	Year/
Height	Colour of Eyes	

Street Address, Apt. No., P.O. Box or Rural Route

--

City, Town or Village

--

Prov./State	Postal/Zip Code

Issuer Number

--	--	--	--

Signature of Issuer	Date of Issue	Signature of Licencee
---------------------	---------------	-----------------------

O. Reg. 526/86, Form 24.



Ministry of
Natural
Resources

Ontario

Form 25

Game and Fish Act

DIP-NET LICENCE TO TAKE FISH FOR PERSONAL USE 19.....

Under the *Game and Fish Act*, and the regulations, and subject to the limitations thereof and the limitations of the *Fisheries Act (Canada)* and of the Ontario Fishery Regulations, 1989, this licence is granted to:

Licence Fee \$2.50

Last Name (Print)

Mr./
M.
Mrs./

--

First Name (Print) Initial

--	--

Street Address, Apt. No., P.O. Box or Rural Route

[Grid for Street Address]

City, Town or Village

[Grid for City, Town or Village]

Prov.

[Grid for Province]

Postal Code

[Grid for Postal Code]

Office

[Box for Office]

Identification

Date of Birth

[Grid for Date of Birth: Day, Month, Year]

Height

Weight

[Grid for Height and Weight]

Colour of Hair

Colour of Eyes

[Grid for Colour of Hair and Eyes]

TO TAKE IN THE WATERS OF:

- pink salmon
herring
whitefish

For personal use by means of a dip-net the dimensions of which are not greater than 183 cm. by 183 cm. if angular, and 183 cm. in diameter, if circular.

This licence expires with December 31 of the year in which it is issued.

Table with 3 columns: Date of Issue, Place of Issue, Signature of Issuer

O. Reg. 526/86, Form 25; O. Reg. 620/89, s. 13.

Form 26

Game and Fish Act

LICENCE TO SHIP OR TRANSPORT FISH IN ONTARIO

Under the Game and Fish Act and the Regulations, and subject to the limitations thereof and the limitations of the Fisheries Act (Canada) and the Ontario Fishery Regulations, 1989, this licence is granted to:

NAME:

ADDRESS (mailing):

to ship and transport

by means of

subject to the following conditions:

- 1.
2.
3.
4.
5.

This licence expires with the day of (Month), (Year)

issued at this day of (Month), (Year)

Signature of licensee

Signature of issuer

O. Reg. 211/89, s. 10.



Ministry of Natural Resources / Ministère des Richesses naturelles

Form 27 / Formule 27

Serial No. / N° de série

Game and Fish Act / Loi sur la chasse et la pêche

Ontario

Lake St. Joseph Angling Validation Tag

Vignette de validation pour la pêche à la ligne dans le lac St. Joseph

19....

Valid for 7 consecutive days from

Valide pendant 7 jours consécutifs du

year année	month mois	day jour

to
au

year année	month mois	day jour

O. Reg. 435/90, s. 2.

REGULATION 491

FUR HARVEST, FUR MANAGEMENT AND CONSERVATION COURSE

1. The Minister may appoint as a fur harvest, fur management and conservation instructor any person who, in the opinion of the Minister, is competent to conduct a course to educate trappers in fur harvest, fur management and conservation. O. Reg. 154/82, s. 1.

2.—(1) Subject to subsection (2), an instructor shall give to any person who applies to the instructor therefor a course in fur harvest, fur management and conservation.

(2) The course shall be given at such times and in such places as the district manager of the administrative district of the Ministry of Natural Resources in which the course is to be given determines.

- (3) The course shall be approved by the Minister, shall deal with,
 - (a) history of fur management, humane trapping, fur laws and policies, and fur-bearing animals and the description of pelts;
 - (b) trapping equipment, trapping and survival; and
 - (c) the biology, management, trapping and handling of pelts of muskrat, mink, beaver, otter, marten, fisher, raccoon, skunk, fox, coyote, wolf, lynx, bobcat, bear, weasel, red squirrel and any other animal as determined by the Minister,

and shall include,

- (d) a written examination or, in the discretion of the district manager of the administrative district in which the course is given, an oral examination, on the subjects listed in clauses (a), (b) and (c); and
- (e) a field demonstration and test of the efficiency and humane operation of trap sets. O. Reg. 154/82, s. 2.

3. Upon successful completion of a course by a candidate and upon the recommendation of the instructor, the district manager of the administrative district of the Ministry of Natural Resources in which the course was given shall issue a certificate certifying that the candidate has completed the course. O. Reg. 154/82, s. 3.

REGULATION 492

FURS

INTERPRETATION

1. In this Regulation "registered trap-line area" means an area designated as a trap-line area in Regulation 526 of Revised Regulations of Ontario, 1990. R.R.O. 1980, Reg. 415, s. 1.

TRAPPER'S LICENCE

2.—(1) A licence to hunt or trap or attempt to trap fur-bearing animals shall be in Form 1. R.R.O. 1980, Reg. 415, s. 2 (1).

- (2) The fee for a licence in Form 1 is,
 - (a) on and after the 1st day of September, 1991, \$6.25 for that part of Ontario that is south of the most northerly east-west line of the Canadian National Railway Company; and
 - (b) \$1 for that part of Ontario that is north of that line. R.R.O. 1980, Reg. 415, s. 2 (2); O. Reg. 700/84, s. 1; O. Reg. 518/86, s. 1; O. Reg. 613/89, s. 1; O. Reg. 602/90, ss. 1, 3 (2).

(3) A licence in Form 1 is valid from the 1st day of September to and including the 31st day of August next following. O. Reg. 203/82, s. 1.

3.—(1) No licence in Form 1 shall be issued to an applicant therefor who has not previously been issued a licence to hunt or trap fur-bearing animals under the regulations, unless the application is supported by the production at the time of the application of,

- (a) a licence to hunt issued to the applicant under the regulations; and
- (b) a certificate issued to the applicant at any time during the five years prior to his or her application by the district manager of an administrative district of the Ministry of Natural Resources certifying that the applicant has successfully completed the course of instruction in fur harvest, fur management and conservation given by the Ministry or in the case of an applicant who has been permitted to hunt or trap fur-bearing animals without a licence under subsection 62 (7) of the Act, or a predecessor thereof, proof that the applicant sealed or sold pelts of fur-bearing animals at any

time during the five years immediately prior to the 1st day of July, 1982. R.R.O. 1980, Reg. 415, s. 3 (1); O. Reg. 203/82, s. 2 (1).

(2) No licence in Form 1 shall be issued to an applicant therefor who has previously been issued a licence to hunt or trap fur-bearing animals under the regulations, unless the application is supported by the production at the time of the application of a licence to hunt or trap fur-bearing animals issued to the applicant at any time during the five years immediately prior to the application. O. Reg. 203/82, s. 2 (2).

(3) No licence in Form 1 shall be issued to an applicant therefor who has previously been issued a licence to hunt or trap fur-bearing animals under the regulations, if the applicant has not held a licence to hunt or trap fur-bearing animals under the regulations at any time during the five years immediately prior to the application, unless the application is supported by the production, at the time of the application of a certificate issued to the applicant by the district manager of an administrative district of the Ministry of Natural Resources certifying that he or she has successfully completed the course of instruction in fur harvest, fur management and conservation given by the Ministry. O. Reg. 203/82, s. 2 (3).

4.—(1) The holder of a licence in Form 1 may hunt or trap or attempt to trap during the open season fur-bearing animals,

- (a) on Crown lands in the registered trap-line area designated in his or her licence; or
- (b) on Crown lands, other than those referred to in clause (a), described in his or her licence and on lands other than Crown lands described in the licence in respect of which he or she has a written permit from the owner thereof to hunt or trap or attempt to trap fur-bearing animals thereon.

(2) Not more than one registered trap-line area shall be designated in a licence in Form 1. O. Reg. 203/82, s. 3, *part*.

(3) Where the holder of a licence in Form 1 is,

- (a) an owner, or the holder of a written permit for the purpose from the owner, of land; or
- (b) a purchaser or locatee, or the holder of a written permit for the purpose from the purchaser or locatee, under the *Public Lands Act*, of land,

within or adjacent to the registered trap-line area designated in the licence, he or she may hunt or trap or attempt to trap fur-bearing animals on that land. R.R.O. 1980, Reg. 415, s. 4 (2).

(4) Despite subsection (2), the holder of a licence in Form 1 that designates more than one registered trap-line area and is valid on the 6th day of April, 1982 may obtain a licence for the trap-line areas, so designated. O. Reg. 203/82, s. 3, *part*.

(5) Except as provided in subsection (3), the holder of a licence in Form 1 shall not, under the authority of that licence, hunt or trap or attempt to trap on any area other than that designated or described in the licence. R.R.O. 1980, Reg. 415, s. 4 (3).

5. The holder of a licence in Form 1 may hunt or trap or attempt to trap fur-bearing animals during the open season in any part of the area described in the Schedule that is designated in the licence. R.R.O. 1980, Reg. 415, s. 5.

6. The holder of a licence in Form 1 shall, during the open season for hunting or trapping fur-bearing animals, take,

- (a) not more than the number of a species of fur-bearing animal fixed by the licence; and
- (b) not less than 75 per cent of the number of a species of fur-

bearing animal fixed by the licence. R.R.O. 1980, Reg. 415, s. 6.

7.—(1) Where the holder of a licence in Form 1 is unable temporarily, through illness or other cause, to comply with section 6, he or she shall,

- (a) notify the district manager of the administrative district of the Ministry of Natural Resources in which he or she is licensed; and
- (b) nominate a person to trap on the registered trap-line in his or her stead.

(2) Where the person nominated is approved in writing by the district manager referred to in subsection (1), he or she shall have all the rights and be subject to the obligations of the holder of a licence in Form 1 until the holder of the licence resumes trapping on his or her registered trap-line area.

(3) The holder of a licence in Form 1 shall notify the district manager referred to in subsection (1) when the holder resumes trapping on his or her registered trap-line area. R.R.O. 1980, Reg. 415, s. 7.

8. The holder of a licence in Form 1 may under the authority of that licence take black bear during the open season therefor from the area described in the licence. O. Reg. 154/81, s. 1.

9.—(1) A licence issued under subsection 62 (8) of the Act shall be in Form 2 and shall be issued without payment of a fee.

(2) A licence in Form 2 is valid from the 1st day of September to and including the 31st day of August next following.

(3) No licence in Form 2 shall be issued to an applicant therefor unless the application is supported by the production at the time of the application of,

- (a) a licence to hunt or trap fur-bearing animals under the regulations issued to the applicant at any time during the five years immediately prior to the application for a licence in Form 2;
- (b) proof that he sealed or sold pelts of fur-bearing animals at any time during the five years prior to the 1st day of July, 1982 taken under subsection 62 (7) of the Act, or a predecessor thereof;
- (c) a licence in Form 2 previously issued to the applicant at any time during the five years immediately prior to the application; or
- (d) a certificate issued to the applicant at any time during the five years immediately prior to the application for a licence in Form 2 by the district manager of an administrative district of the Ministry of Natural Resources certifying that the applicant has successfully completed the course of instruction in fur harvest, fur management and conservation given by the Ministry. O. Reg. 203/82, s. 4.

SEALING OF PELTS

10. The pelt of any fur-bearing animal, other than a muskrat, shall be,

- (a) sealed by inserting through the eye hole or the nose a numbered seal with the letter "ONT" stamped thereon; or
- (b) marked with a stamp provided by the Ministry for that purpose. O. Reg. 203/82, s. 5.

MULTIPLICITY OF LICENCES

11.—(1) No person shall hold more than one licence in Form 1 or 2.

(2) No holder of a licence in Form 1 shall be the holder of a licence in Form 2. O. Reg. 203/82, s. 6, *part*.

(3) Except with the written permission of the regional director of the administrative region of the Ministry of Natural Resources in which the licence is issued,

- (a) no holder of a licence in Form 4;
- (b) no agent named in a licence in Form 4; and
- (c) no member of the family of a person named in clause (a) or (b) who resides with the person,

shall be the holder of a licence in Form 1 or 2.

(4) Except with the written permission of the regional director of the administrative region of the Ministry of Natural Resources in which the licence is issued, no holder of a licence under the *Fur Farms Act* and no member of the holder's family who resides with the holder shall be the holder of a licence in Form 1, 2 or 4 or be the agent named in a licence in Form 4. O. Reg. 4/85, s. 1.

POSSESSION OF PELTS

12.—(1) No person shall apply for or hold a licence issued under section 64 of the Act for a greater number of pelts than he or she has in his or her possession.

(2) A licence issued under section 64 of the Act shall be in Form 3 and expires with the 25th day of October next following the date on which it is issued. R.R.O. 1980, Reg. 415, s. 10; O. Reg. 4/85, s. 2.

FUR DEALERS

13.—(1) A licence issued to a person to buy, sell or trade in pelts shall be in Form 4 and the fee for it is on or after the 1st day of July, 1991 \$36.75. O. Reg. 518/86, s. 2; O. Reg. 613/89, s. 2 (1); O. Reg. 602/90, ss. 2 (1), 3 (1).

(2) A licence issued under subsection (1) in which an agent is named authorizes the agent to buy or possess pelts on behalf of the licensee. O. Reg. 4/85, s. 3.

(3) A licence issued to a person to engage in the business of tanning, plucking or treating of pelts shall be in Form 4 and the fee therefor is on or after the 1st day of July, 1991 \$36.75. O. Reg. 573/87, s. 1; O. Reg. 613/89, s. 2 (2); O. Reg. 602/90, ss. 2 (2), 3 (1).

(4) A licence in Form 4 expires with the 30th day of June next following the date on which it is issued. R.R.O. 1980, Reg. 415, s. 11 (3).

(5) No holder of a licence in Form 4 shall be the holder of a licence in Form 5 during the period that the licence in Form 4 is valid.

(6) No holder of a licence in Form 4 who surrenders the licence shall obtain a licence in Form 5 prior to the 1st day of July next following the date on which the licence in Form 4 was issued. O. Reg. 203/82, s. 7, *part*.

14.—(1) A licence issued to a person to buy pelts at The Wildlife Conservation and Fur Marketing Federation at the City of North Bay in the Territorial District of Nipissing or at Hudson's Bay Fur Sales Canada Inc. in the City of Etobicoke in The Municipality of Metropolitan Toronto shall be in Form 5 and shall be issued without payment of a fee. O. Reg. 628/87, s. 1 (1).

(2) A licence in Form 5 expires with the 30th day of June next following the date on which it is issued. R.R.O. 1980, Reg. 415, s. 12 (2).

(3) No holder of a licence in Form 5 shall take physical possession in Ontario of the pelts bought by him or her.

(4) The holder of a licence in Form 5 may surrender that licence and obtain a licence in Form 4. O. Reg. 203/82, s. 8, *part*.

(5) No holder of a licence in Form 5 shall sell at Hudson's Bay Fur Sales Canada Inc. in the City of Etobicoke pelts bought by the holder at The Wildlife Conservation and Fur Marketing Federation at the City of North Bay in the Territorial District of Nipissing.

(6) No holder of a licence in Form 5 shall sell at The Wildlife Conservation and Fur Marketing Federation at the City of North Bay in the Territorial District of Nipissing pelts bought by the holder at Hudson's Bay Fur Sales Canada Inc. in the City of Etobicoke. O. Reg. 628/87, s. 1 (2).

(7) The holder of a licence in Form 5 may sell pelts bought by him or her at the facility where the pelts are bought. O. Reg. 203/82, s. 8, *part*.

15. The holder of a licence in Form 4 may deal directly with,

- (a) licensed fur-dealers in any part of Ontario; and
- (b) the holder of a licence as an operator of a fur farm under the *Fur Farms Act*. R.R.O. 1980, Reg. 415, s. 13; O. Reg. 519/85, s. 2.

16. The holder of a licence in Form 4 shall record in triplicate,

- (a) the purchase or receipts of pelts in Form 6 at the time of each purchase or receipt; and
- (b) the sale, disposal, tanning, plucking or treating of pelts in Form 7 at the time of each sale, disposal, tanning, plucking or treating thereof. R.R.O. 1980, Reg. 415, s. 14.

17.—(1) The holder of a licence in Form 4 shall,

- (a) submit to the district manager of the administrative district of the Ministry of Natural Resources in which the holder of the licence resides, the completed Forms 6 and 7 for the preceding month, so that the forms are received on or before the tenth day of every month; and
- (b) retain the triplicate original intact in the book in which Forms 6 and 7 are supplied by the Ministry for not less than one year after the day on which the licence in Form 4 expires. R.R.O. 1980, Reg. 415, s. 15 (1); O. Reg. 154/81, s. 2; O. Reg. 15/88, s. 1.

(2) Despite clause (1) (a), the holder of a licence in Form 4 may submit the records required by clause (1) (a) on a computer tape in the manner specified by the Ministry of Natural Resources, if authorized by the district manager of the administrative district of the Ministry of Natural Resources in which the holder of the licence resides. O. Reg. 203/82, s. 9 (1).

(3) The triplicate original of Forms 6 and 7 shall be available for inspection by an officer.

(4) When in any month a holder of a licence in Form 4 has not received or disposed of pelts or has not tanned, plucked or treated pelts, he or she shall so report in his or her return. R.R.O. 1980, Reg. 415, s. 15 (2, 3).

(5) Where a holder of a licence in Form 4 is unable to make a return on or before the tenth day of any month, he or she shall make application to the district manager referred to in clause (1) (a) for an extension of time, which may be granted by the district manager in writing. R.R.O. 1980, Reg. 415, s. 15 (4); O. Reg. 15/88, s. 2.

(6) A licence issued under subsection 69 (3) of the Act shall be in Form 8. R.R.O. 1980, Reg. 415, s. 15 (5).

(7) A licence in Form 8 expires one year after the date on which it is issued and the holder of the licence shall send the licence by mail to the district manager of the administrative district of the Ministry of Natural Resources in which the holder of the licence resides, upon completion of tanning, plucking or treating of the pelts. O. Reg. 203/82, s. 9 (2).

18.—(1) A licence issued to a person purchasing pelts for personal use, restricted as to time and quantity, to be known as a "restricted licence", shall be in Form 9 and shall be issued without payment of a fee.

(2) A licence in Form 9 expires with the thirtieth day after the date on which it is issued. R.R.O. 1980, Reg. 415, s. 16.

EXPORT OF FUR-BEARING ANIMALS OR THEIR PELTS

19.—(1) A licence to take or ship a fur-bearing animal or its pelt to a point outside Ontario shall be in Form 10.

(2) A licence in Form 10 expires with the thirtieth day after the date on which it is issued.

(3) It is a condition of a licence in Form 10 that the name and address of the carrier be shown on the licence.

(4) A licence in Form 10 shall be attached to the,

- (a) freight or express way-bill covering the shipment, if made by a common carrier; or
- (b) parcel or other container containing the pelts, if shipment is made by other means.

(5) A licence in Form 10 is valid for one shipment of pelts only. R.R.O. 1980, Reg. 415, s. 17.

ROYALTIES

20.—(1) The royalties for taking or shipping to a point outside Ontario any fur-bearing animal or its pelt or sending or having sent any fur-bearing animal or its pelt to a tanner or taxidermist to be tanned, plucked or treated in any way are as follows:

1. Badger	\$.15
2. Beaver	1.65
3. Bobcat	2.85
4. Coyote	.50
5. Fisher	5.05
6. Fox (Arctic)	1.90
7. Fox (Coloured)	1.30
8. Fox (Grey)	.20
9. Lynx	13.60
10. Marten	4.80
11. Mink	2.50
12. Muskrat	.15
13. Otter	2.40
14. Raccoon	.30
15. Skunk	.20
16. Timber Wolf	1.85
17. Wolverine	10.20

O. Reg. 656/89, s. 1.

(2) Subsection (1) does not apply to the pelts of fur-bearing animals bred on a farm operating in Ontario under a licence issued under the *Fur Farms Act* or the pelts of fur-bearing animals imported from a place outside Ontario. O. Reg. 857/81, s. 1, *part*.

Schedule

I. Rondeau Provincial Park. R.R.O. 1980, Reg. 415, Sched.



Ministry of
Natural
Resources

Ontario

Trapper's
Licence
19...

Form 1

Trapper's
number

1	2	3	4	5	6	7	8	9	10	11	12
1	2										

Under the Game and Fish Act and the regulations, and subject to the limitations thereof, this licence is issued to

Print last name first

First name or Initials

13		32
----	--	----

Street address, P.O. Box No. or Rural Route

33		52
----	--	----

City, Town or Village

53		69	
----	--	----	--

Location of Residence.

Lot _____ Con. _____ Township _____

to hunt or trap fur-bearing animals during the open season in the parts of Ontario described as follows:

But excepting therefrom all privately owned land on which the licensee does not have written permission to trap, from the owner. If trapping is to be done on private lands by written permission, lots and concessions must be shown on the back of this licence.

Description	Status Code	Quotas
Age 70 71 Height _____ Weight _____ Colour of hair _____ Colour of eyes _____	A means new trapper 72 B means no change in trapper number from last year C means trapper has a number different from last year	Beaver 73 75 Fisher _____ Lynx _____ Marten _____ Wolverine _____ Other Species _____
Date of issue Month Day 76 78 79 80	Land Classification	Site Region Site District 81 82 83 84
This licence is valid from the 1st day of September to and including the 31st day of August next following.		
Signature of Issuer		Signature of Licensee

The holder of this licence has obtained written permission to trap on the following private lands only.

Lot	Concession	Township	AREA (Ha)	Approved by Issuing Officer (Date and Name)

O. Reg. 203/82, s. 10, *part*; O. Reg. 700/84, s. 3 (1); O. Reg. 518/86, s. 3.



Ministry of
Natural
Resources

Ontario

Form 2

No.

Farmer's Licence To Sell Pelts and Carcasses
19-

Farmer's
Trapper's
Number

1	2																						
1	2	3	4	5	6	7	8	9	10	11	12												

Under the Game and Fish Act and the regulations, and subject to the limitations thereof, this licence is issued to:

Print last name first

First name or initials

13													32																				

Street address, P.O. Box No. or Rural Route

33																												52						

City, Town or Village

53																												69	Ontario,				

Location of Residence

Lot _____ Con. _____ Township _____

to sell pelts and carcasses of fur-bearing animals taken during the open season from lands on which he or she resides and described herein.

Description	Status Code	Quotas
Age <input style="width:20px;" type="text"/> <input style="width:20px;" type="text"/> 70 71	A means new trapper <input style="width:20px;" type="text"/> 72	Beaver <input style="width:20px;" type="text"/> <input style="width:20px;" type="text"/> <input style="width:20px;" type="text"/> 73 75
Beight _____	B means no change in trapper number from last year	Fisher _____
Weight _____	C means trapper has a number different from last year	Lynx _____
Colour of hair _____		Marten _____
Colour of eyes _____		Wolverine _____
		Other Species _____
Month Day		Site Region Site District
Date of issue <input style="width:20px;" type="text"/> <input style="width:20px;" type="text"/> <input style="width:20px;" type="text"/> <input style="width:20px;" type="text"/>	Land Classification <input style="width:20px;" type="text"/> <input style="width:20px;" type="text"/> <input style="width:20px;" type="text"/> <input style="width:20px;" type="text"/>	<input style="width:20px;" type="text"/> <input style="width:20px;" type="text"/> <input style="width:20px;" type="text"/> <input style="width:20px;" type="text"/>
	76 78 79 80	81 82 83 84
This licence is valid from the 1st day of September to and including the 31st day of August next following.		
_____ Signature of Issuer		_____ Signature of Licensee

The licensee owns these lands on which he resides

Lot	Concession	Township	AREA (Ha)			

O. Reg. 203/82, s. 10, part.



Ontario

Ministry of Natural Resources

LICENCE TO POSSESS PELTS 19.....

Form 3

Licence No.

Under the Game and Fish Act and the regulations, and subject to the limitations thereof, this licence is issued to:

Name of Licensee (Last Name) (First Name)

Address Street, P.O. Box No. or Rural Route City, Town or Village

Holder of (Type of Licence) Licence Number

Address of Premises

to possess during the closed season on the above mentioned premises the following pelts:

Table with 2 columns: Ontario Pelts, Other than Ontario Pelts

This licence expires with the 25th day of October next following the date on which it is issued.

Signature of Issuer

Date of Issue

Signature of Licensee

R.R.O. 1980, Reg. 415, Form 2; O. Reg. 4/85, s. 4 (1).



Ontario

Ministry of Natural Resources

Fur Dealer's Licence 19.....

Form 4

Game and Fish Act

15 Dealer's Number

Grid for Dealer's Number

1 1. Renewal 2. New Licence

Grid for Renewal/New Licence

Under the Game and Fish Act and the regulations, and subject to the limitations thereof, this licence is issued to

Print last name first First Name Middle Initials



Ministry of
Natural
Resources

Ontario

Form 5

Game and Fish Act

Licence to Buy Pelts

at The Wildlife Conservation and Fur Marketing Federation,
North Bay, Ontario

or

Hudson's Bay Fur Sales Canada Inc., Toronto, Ontario

Under the *Game and Fish Act* and the regulations, and subject to the limitations thereof, this licence is issued to:

.....
Last Name

.....
First Name or Initials

of,
to buy pelts at the above-marked facility.

This licence expires with the 30th day of June next following the date on which it is issued.

Conditions: 1. The holder of this licence shall not take physical possession in Ontario of the pelts the holder has bought.

2. The holder of this licence may surrender it and obtain a fur-dealer's licence.

3. The holder of this licence shall not sell at The Wildlife Conservation and Fur Marketing Federation at the City of North Bay pelts the holder has bought at the Hudson's Bay Fur Sales Canada Inc. in the City of Etobicoke.

4. The holder of this licence shall not sell at the Hudson's Bay Fur Sales Canada Inc. in the City of Etobicoke pelts the holder has bought at The Wildlife Conservation and Fur Marketing Federation at the City of North Bay.

5. The holder of this licence may sell pelts the holder has bought at the facility where the pelts are bought.

.....
Date of Issue

.....
Signature of Issuer

O. Reg. 519/85, s. 3, *part*; O. Reg. 628/87, s. 2.

 Ministry of Natural Resources
 Ontario

Fur Dealer's Return of Pelts
 Purchased or Received
 during the month of 19....
Form 6

List either then Ontario pelts here:

License Number	Dealer's Name	Address	Editing District Numeric Code												Edited by												
Y	Shipping License Number or Ontario Fur Dealer's Number from whom Pelts Purchased or Received	Date Purchased or Received	Y	M	D	01	02	03	04	05	06	07	08	09	10	11	12	13	14	15	16	17	18	19	20	21	22
1 0	10 Name	11 Date	12	13	14	15	16	17	18	19	20	21	22	23	24	25	26	27	28	29	30	31	32	33	34	35	36
316	10 Name	11 Date	12	13	14	15	16	17	18	19	20	21	22	23	24	25	26	27	28	29	30	31	32	33	34	35	36
316	10 Name	11 Date	12	13	14	15	16	17	18	19	20	21	22	23	24	25	26	27	28	29	30	31	32	33	34	35	36
316	10 Name	11 Date	12	13	14	15	16	17	18	19	20	21	22	23	24	25	26	27	28	29	30	31	32	33	34	35	36

10 Name 11 Date 12 13 14 15 16 17 18 19 20 21 22 23 24 25 26 27 28 29 30 31 32 33 34 35 36
 10 Name 11 Date 12 13 14 15 16 17 18 19 20 21 22 23 24 25 26 27 28 29 30 31 32 33 34 35 36
 10 Name 11 Date 12 13 14 15 16 17 18 19 20 21 22 23 24 25 26 27 28 29 30 31 32 33 34 35 36

Pelt Total:

I certify that this return is true
 Signature: Date:

(If Nil) Transference Enter -1-

(A) Tail tip is all black. Back of hind leg is not black.
 (B) Tail tip is only half black. Back of hind leg is black.

O. Reg. 203/82, s. 10, part.



Ministry of Natural Resources

Ontario

Form 8

Fur Dealer's Licence (Permit) to Accept Pelts for Tanning 19__

C.B. No. Receipt No.

Date Issued Year Month Day Dated at District Code No. Licence No.

Under the Game and Fish Act and the regulations, and subject to the limitations thereof, this licence is issued to:

Name Address

Holder of Trapper's Assigned No. or Hunter's No. Dealer's Assigned No. Fur Buyer's Restricted Licence No.

Name of Dealer who will do the tanning Dealer's Assigned No.

is authorized to accept for tanning, plucking or treating at,

Location the following pelts,

1. Ontario Wild Fur

Table with columns: Species, Quantity, Royalty Rate, Royalty Paid. Rows include 101 Beaver, 102 Mink, 103 Marten, 104 Otter, 105 Fisher, 106 Lynx, 107 Bobcat, 108 Muskrat, 109 Raccoon, 110 Red Squirrel, 111 Weasel, 112 Coloured Fox, 113 Arctic Fox, 114 Timber Wolf, 115 Coyote, 116 Black Bear, 117 Wolverine, 118 Skunk, 119 Grey Fox, 120 Polar Bear, 121 Badger, 122 Opossum.

2. Other than pelts and ranch raised fur, exempt from royalty:

Table with columns: Species, Quantity. Rows include 201 Beaver, 202 Mink, 203 Marten, 204 Otter, 205 Fisher, 206 Lynx, 207 Bobcat, 208 Muskrat.

Table with columns: Species, Quantity. Rows include 209 Raccoon, 210 Red Squirrel, 211 Weasel, 212 Coloured Fox, 213 Arctic Fox, 214 Timber Wolf, 215 Coyote, 216 Black Bear.

Table with columns: Species, Quantity. Rows include 217 Wolverine, 218 Skunk, 219 Grey Fox, 220 Polar Bear, 221 Badger, 222 Opossum.

Signature of Issuer Date Received by Dealer Date Delivered by Dealer Signature of Dealer

This licence shall be mailed to the Ministry upon the completion of the tanning or treating of the pelts listed but not later than one year from the date of issue. This licence expires one year after the date on which it is issued.



Ministry of
Natural
Resources
Ontario

Form 9 Fur Buyer's
Restricted
Licence

8	2
1	2

Licence No.

R				
3				7

District Code

18	19

Under the Game and Fish Act, and the regulations, and subject to the limitations thereof, this licence is issued to:

Name of Licensee	
42	61

Address	
62	81

City, Town or Village	
82	101

to purchase from:

Trapper's Assigned No. or Hunter's No.										
32										41

 or

Dealer's Assigned No.						
32						36

for personal use the following pelts:

Species 20 21	Quantity 22	25
01 Beaver	-	
02 Mink		
03 Marten		
04 Otter		
05 Fisher		
06 Lynx		
07 Bobcat		
08 Muskrat		
09 Raccoon		
10 Red Squirrel		
11 Weasel		

Species 20 21	Quantity 22	25
12 Coloured Fox		
13 Arctic Fox		
14 Timber Wolf		
15 Coyote		
16 Black Bear		
17 Wolverine		
18 Skunk		
19 Grey Fox		
20 Polar Bear		
21 Badger		
22 Opossum		

This licence expires with the 30th day after the date on which it is issued.

Date of issue

Year	Month	Day

Signature of Issuer 26 31

Signature of Licensee

--	--



Ministry of Natural Resources

Ontario

Form 10

Export Licence for Fur-Bearing Animals or Their Pelts 19_____

C.B. No.
Receipt No.

Date Issued: Year [13] Month [1P] Day [1P] Detad at _____ District Code No. [19] [20] Licence No. E [2035] [21] [25]

Under the Game and Fish Act and the regulations, and subject to the limitations thereof, this licence to export fur-bearing animals or their pelts is issued to:

Name _____ Address _____

Holder of: Trapper's Assigned No. or Hunter's No. [7] [2] or Dealer's Assigned No. [] [] [] [] or Fur Buyer's Restricted Licence No. [] [] [] []

Name of Carrier _____ Address of Carrier _____

is authorized to accept for export from Ontario, to

Name of Consignee _____ Address of Consignee _____

1. Ontario Wild Fur-bearers

Species	Quantity	Royal-ty Rate	Royalty Paid	Species	Quantity	Royal-ty Rate	Royalty Paid
26-28	29	33	34	26-28	29	33	34
101 Beaver				112 Coloured Fox			
102 Mink				113 Arctic Fox			
103 Marten				114 Timber Wolf			
104 Otter				115 Coyote			
105 Fisher				116 Black Bear			
106 Lynx				117 Wolverine			
107 Bobcat				118 Skunk			
108 Muskrat				119 Grey Fox			
109 Raccoon				120 Polar Bear			
110 Red Squirrel				121 Badger			
111 Weasel				122 Opossum			

999. Total Royalty Paid \$ _____

2. Other than pelts and ranch raised fur, exempt from royalty:

Species	Quantity	Species	Quantity	Species	Quantity
26-28	29	26-28	29	26-28	29
201 Beaver		209 Raccoon		217 Wolverine	
202 Mink		210 Red Squirrel		218 Skunk	
203 Marten		211 Weasel		219 Grey Fox	
204 Otter		212 Coloured Fox		220 Polar Bear	
205 Fisher		213 Arctic Fox		221 Badger	
206 Lynx		214 Timber Wolf		222 Opossum	
207 Bobcat		215 Coyote			
208 Muskrat		216 Black Bear			

This licence expires with the 30th day after the date on which it is issued. Signature of Issuer _____
Way Bill No. (if applicable) _____ Date _____ Piece _____ Signature of Shipping Agent _____

REGULATION 493

GAME BIRD HUNTING PRESERVES

1.—(1) A licence to own or operate a game bird hunting preserve shall be in Form 1 and shall be valid for the species designated therein.

(2) An application for a licence in Form 1 shall be in Form 2. R.R.O. 1980, Reg. 416, s. 1 (1, 2).

(3) On or after the 1st day of September, 1991, the fee payable for a licence in Form 1 is \$131.25. O. Reg. 603/90, s. 1.

(4) A licence in Form 1 expires with the 31st day of August next following the date of issue.

(5) The Minister or a person designated by the Minister may consent in writing to the transfer of a licence in Form 1 upon such terms and conditions as the Minister considers proper. R.R.O. 1980, Reg. 416, s. 1 (4, 5).

2. No licence in Form 1 shall be issued,

- (a) where the issuance of the licence would result in the licensing of more than 600 acres of land in a concession of a township; or
(b) for any land that is situate within 1320 feet of another licensed game bird hunting preserve. R.R.O. 1980, Reg. 416, s. 2.

3.—(1) A game bird hunting preserve shall be not less than 100 acres and not more than 600 acres in area.

(2) Subsection (1) does not apply to an island wholly owned by the holder of a licence in Form 1 or an Indian reserve. R.R.O. 1980, Reg. 416, s. 3.

4.—(1) Bobwhite quail, pheasants and wild turkeys on a game bird hunting preserve may be hunted at any time of the year.

(2) Any regulations under the Act that limit the hours during which bobwhite quail, pheasants or wild turkeys may be hunted and limit the number or sex of bobwhite quail, pheasants or wild turkeys that may be hunted in one day or possessed by any person do not apply to bobwhite quail, pheasants or wild turkeys hunted on a game bird hunting preserve. R.R.O. 1980, Reg. 416, s. 4.

5.—(1) No person shall remove from a game bird hunting preserve a bobwhite quail, pheasant or wild turkey unless the person has first obtained from the owner or operator thereof a statement that shows,

- (a) the name and address of the game bird hunting preserve where the bird was obtained;
(b) the name and address of the person entitled to remove the game bird from the game bird hunting preserve;
(c) the date on which the game bird was obtained; and
(d) the number and species of the game birds obtained.

(2) The person named in the statement referred to in subsection (1) shall retain the statement for as long as any game bird described therein is in his or her possession and he or she shall produce and show the statement to any officer whenever requested by the officer. O. Reg. 447/81, s. 1, part.

6. The holder of a licence in Form 1 shall deliver the statement referred to in subsection 5 (1) to any person who is entitled to remove a bobwhite quail, pheasant or wild turkey from the game bird hunting preserve owned or operated by the holder of the licence

before any such game bird is removed therefrom. O. Reg. 447/81, s. 1, part.

Form 1

Game and Fish Act

LICENCE TO OWN OR OPERATE A GAME BIRD HUNTING PRESERVE 19.....

Under the Game and Fish Act and the regulations, and subject to the limitations thereof, this licence is granted to

..... of

to own or operate a game bird hunting preserve on the following lands:

.....

This licence is valid for the following species:

- *bobwhite quail
*pheasant
*wild turkey

This licence expires with the 31st day of August next following the date of issue.

..... (signature of issuer)

..... (date)

*Strike out if not applicable.

R.R.O. 1980, Reg. 416, Form 1.

Form 2

Game and Fish Act

APPLICATION FOR A LICENCE TO OWN OR OPERATE A GAME BIRD HUNTING PRESERVE

Under the Game and Fish Act and the regulations, and subject to the limitations thereof,

..... (print full name, surname preceding)

of (post office address)

makes application for a licence to own or operate a game bird hunting preserve on the following lands:

(part) Lot Concession or Plan in the Township of

County (or as the case may be)

and more particularly described in Instrument No. for the of containing hectares.

Are bobwhite quail to be propagated by the applicant?

Yes No

Are pheasants to be propagated by the applicant?

Yes No

Are wild turkeys to be propagated by the applicant?

Yes No

Are bobwhite quail to be imported by the applicant from outside the Province of Ontario?

Yes No

Are pheasants to be imported by the applicant from outside the Province of Ontario?

Yes No

Are wild turkeys to be imported by the applicant from outside the Province of Ontario?

Yes No

Dated at in the

of this day of 19.....

.....
(signature of applicant)

R.R.O. 1980, Reg. 416, Form 2.

REGULATION 494

GAME BIRDS—CAPTIVITY, PROPAGATION OR SALE

1.—(1) A licence to,

- (a) keep game birds in captivity for more than ten days;
- (b) to propagate or sell game birds; or
- (c) to possess game birds for propagation or sale,

shall be in Form 1 and shall be valid for the species specified therein.

(2) An application for a licence in Form 1 shall be in Form 2.

(3) A licence in Form 1 expires with the 31st day of December next following the date on which it is issued. O. Reg. 578/86, s. 1 (1-3).

(4) The fee for a licence in Form 1 is \$21. O. Reg. 606/90, s. 1.

(5) The species of game birds specified in a licence in Form 1 may be varied at any time before the expiry of the licence, upon the request of the licensee and without payment of a fee, by the district manager of the administrative district of the Ministry of Natural Resources in which the licence was issued.

(6) No holder of a licence in Form 1 shall possess more than fifty of each of the following species of live game birds at one time:

- 1. Spruce grouse.
- 2. Ruffed grouse.
- 3. Sharp-tailed grouse.

4. Rock ptarmigan.

5. Willow ptarmigan.

6. Hungarian partridge. O. Reg. 578/86, s. 1 (5, 6).

2.—(1) Subject to subsections (2) and (3), a licence in Form 1 authorizes its holder to,

- (a) keep in captivity for more than ten days or to propagate or sell or to possess for propagation or sale live ruffed grouse, spruce grouse, Hungarian partridge, pheasant, sharp-tailed grouse, rock ptarmigan, willow ptarmigan, bobwhite quail, wild turkey and their eggs; and
- (b) sell the carcass of pheasant.

(2) No holder of a licence in Form 1 shall sell, offer for sale or assist in the sale of live ruffed grouse, spruce grouse, Hungarian partridge, sharp-tailed grouse, rock ptarmigan, willow ptarmigan or their eggs, except to a holder of a licence in Form 1.

(3) No person shall sell, offer for sale or assist in the sale of,

- (a) a bobwhite quail or a bobwhite quail egg; or
- (b) a wild turkey or a wild turkey egg,

except to a holder of a licence in Form 1 or the holder of a licence to own or operate a game bird hunting preserve. O. Reg. 578/86, s. 2.

3.—(1) Subject to subsection (2), no holder of a licence in Form 1 shall sell live ruffed grouse, spruce grouse, Hungarian partridge, pheasant, sharp-tailed grouse, rock ptarmigan, willow ptarmigan, bobwhite quail or wild turkey, or the carcass of a pheasant, unless at the time of sale the holder delivers to the purchaser an invoice showing,

- (a) the vendor's name and address;
- (b) the number of the vendor's licence;
- (c) the date of the sale;
- (d) the purchaser's name and address;
- (e) the number of the purchaser's licence, if any; and
- (f) the number and species of game birds sold.

(2) Subsection (1) does not apply to pheasant that is sold in a dressed condition and in a container or package that clearly exhibits the name and address of the holder of the licence who sold the pheasant. O. Reg. 578/86, s. 3.

4.—(1) The purchaser named in an invoice referred to in subsection 3 (1) shall retain the invoice,

- (a) where it relates to the purchase of a live bird, for two years after the purchase; and
- (b) where it relates to the purchase of a carcass, until the carcass is consumed or disposed of or for two years after the purchase, whichever occurs first,

and shall produce and show the invoice upon an officer's request.

(2) The vendor named in an invoice referred to in subsection 3 (1) shall retain a copy of the invoice for two years after the sale and shall produce and show it upon an officer's request. O. Reg. 578/86, s. 4.

5.—(1) The holder of a licence in Form 1 or a person authorized by the holder may kill at any time, by any method other than by shooting, a ruffed grouse, spruce grouse, Hungarian partridge, pheasant, sharp-tailed grouse, rock ptarmigan, willow ptarmigan,

bobwhite quail or wild turkey kept in captivity under the authority of the licence.

(2) Any person may kill a pheasant by any method, other than by shooting, within ten days after purchasing it from the holder of a licence in Form 1. O. Reg. 578/86, s. 5.

Form 1

Game and Fish Act

LICENCE TO KEEP GAME BIRDS IN CAPTIVITY FOR MORE THAN TEN DAYS OR TO PROPAGATE OR SELL GAME BIRDS OR TO POSSESS GAME BIRDS FOR PROPAGATION AND SALE IN 19.....

Licence Serial No.

Under the *Game and Fish Act* and the regulations, and subject to the limitations thereof, this licence is issued to:

Mr.
Mrs.
Ms.
Miss

Last Name	First Name	Middle Initial
Address, Street, No., RR # *		
City, Town, Village		Postal Code
*If RR, please specify: Lot Conc. Township.....		

to keep game birds in captivity for more than ten days or to propagate or sell game birds or to possess game birds for propagation or sale.

This licence is valid for the following species only:

Species	Date of Authorization			Issuer's Signature
	Year	Month	Day	
Pheasant				
Bobwhite Quail				
Wild Turkey				
Spruce Grouse				
Ruffed Grouse				
Sharp-tailed Grouse				
Rock Ptarmigan				
Willow Ptarmigan				
Hungarian Partridge				

This licence expires with the 31st day of December next following the date of issue.

.....
Signature of Issuer

.....
Date of Issue

.....
Signature of Licensee

O. Reg. 578/86, Form 1.

Form 2

Game and Fish Act

APPLICATION FOR A LICENCE TO KEEP GAME BIRDS IN CAPTIVITY OR TO PROPAGATE OR SELL GAME BIRDS OR TO POSSESS GAME BIRDS FOR PROPAGATION AND SALE IN 19...

Under the *Game and Fish Act* and the regulations, and subject to the limitations thereof:

Mr.
Mrs.
Ms.
Miss

Last Name	First Name	Middle Initial
Address, Street, No., RR # *		
City, Town, Village		Postal Code
*If RR, please specify: Lot Conc. Township.....		

makes application for a licence to keep game birds in captivity or to propagate or sell game birds or to possess game birds for propagation or sale at:

the above address, ; or,

Lot Conc.

in the Township of in the County, District or Regional Municipality of, and

further described in Instrument Number registered in the Land Registry Office for the Registry Division (Land Titles Division) of

.....

This application is being made for the following species and number of game birds**:

GAME BIRD*	NUMBER
Bobwhite Quail	
Pheasant	
Wild Turkey	
Spruce Grouse	
Ruffed Grouse	
Sharp-tailed Grouse	
Rock Ptarmigan	
Willow Ptarmigan	
Hungarian Partridge	

*Delete where not applicable.

**NOTE: If this is an application for renewal, you must also complete the table relating to last year's holdings.

PREVIOUS YEAR'S HOLDINGS*

Game Bird	Quantity at start of previous Year	Quantity Bred	Quantity Acquired	Quantity Sold	Quantity Died	Quantity Traded	Balance at year end
Bobwhite Quail							
Pheasant							
Wild Turkey							
Spruce Grouse							
Ruffed Grouse							
Sharp-tailed Grouse							
Rock Ptarmigan							
Willow Ptarmigan							
Hungarian Partridge							

*To be completed only where application is for renewal.

.....
Date of Application

.....
Signature of Applicant

O. Reg. 578/86, Form 2.

REGULATION 495

GUIDES

1. The parts of Ontario described in Schedules 1 and 2 are designated as areas in which no person shall act as a guide except under the authority of a licence. O. Reg. 272/88, s. 1.

2.—(1) A licence to act as a guide shall be in Form 1 and the fee therefor is \$5.25. O. Reg. 500/81, s. 1; O. Reg. 601/90, s. 1.

(2) A licence in Form 1 expires with the 31st day of December in the year in respect of which it is issued.

(3) No licence in Form 1 shall be issued to a non-resident. R.R.O. 1980, Reg. 417, s. 2 (2, 3).

3. The part of Ontario described in Schedule 1 is designated as an area in which no non-resident shall hunt deer or moose without employing or being accompanied by a licensed guide. R.R.O. 1980, Reg. 417, s. 3.

Schedule 1

The Territorial District of Rainy River. R.R.O. 1980, Reg. 417, Sched. 1.

Schedule 2

Lake St. Clair. R.R.O. 1980, Reg. 417, Sched. 2.

Form 1

Game and Fish Act

No.

GUIDE LICENCE

19.....

- Identification
- Age
- Height
- Weight
- Colour of hair
- Colour of eyes

Under the *Game and Fish Act* and the regulations, and subject to the limitations thereof, this licence is granted to of to act as a guide.

This licence expires with the 31st day of December, 19.....

Signature of Issuer

Signature of Licensee

Date

R.R.O. 1980, Reg. 417, Form 1; O. Reg. 500/81, s. 2; O. Reg. 601/90, s. 2.

REGULATION 496

HULLETT HUNTING AREA

1. The Crown lands described in Schedules 1 and 2 are designated in accordance with paragraph 33 of section 92 of the Act. O. Reg. 628/82, s. 1.

2. Except as provided in this Regulation, no person shall hunt in the area described in Schedules 1 and 2 from the 1st day of September to the 31st day of December, both inclusive, in any year. O. Reg. 628/82, s. 2; O. Reg. 547/84, s. 1.

3. The holder of a licence in Form 5 of Regulation 500 of Revised Regulations of Ontario, 1990 may hunt ducks, geese, rails, coots, woodcock, snipe and gallinules during the open season therefor in any year during the hours between one-half hour before sunrise and one-half hour after sunset in the area described in Schedule 1 if,

- (a) the motor vehicle that the holder arrives in at the hunting area is parked in a designated parking area in the area described in Schedule 1;
- (b) the holder hunts only within a radius of thirty metres from a stake planted by an officer of the Ministry of Natural Resources and marked with the number of the parking area where the motor vehicle that he or she arrived in is parked;
- (c) the area from which the holder hunts is not occupied by more than one other person; and
- (d) the holder keeps his or her fire-arm unloaded and encased except while occupying a hunting area. O. Reg. 628/82, s. 3; O. Reg. 547/84, s. 2.

4. The holder of a licence in Form 1, 2 or 5 of Regulation 500 of Revised Regulations of Ontario, 1990 may hunt such game as the licence authorizes during the open season therefor in any year during the hours between one-half hour before sunrise and one-half hour after sunset in the area described in Schedule 2, if the motor vehicle that the holder arrives in at the hunting area is parked in a designated parking area in the area described in Schedule 2. O. Reg. 628/82, s. 4.

5. In this Regulation, a reference to Schedules 1 and 2 are references to Schedules 1 and 2 of Ontario Regulation 628/82, as those Schedules read on December 31, 1990. *New*.

REGULATION 497

HUNTER SAFETY TRAINING COURSE

1. The Minister may appoint as a hunting instructor any person who, in the opinion of the Minister, is competent to conduct a course determined by the Minister in the safe handling of firearms. R.R.O. 1980, Reg. 418, s. 1.

2.—(1) A hunting instructor shall give to any person who applies to the hunting instructor therefor such course in the safe handling of firearms as is determined by the Minister.

(2) The course shall be given at such times and in such places as the hunting instructor determines. R.R.O. 1980, Reg. 418, s. 2.

3. Upon completion of a course by a candidate, the hunting instructor shall issue a certificate certifying that the candidate has completed the course. R.R.O. 1980, Reg. 418, s. 3.

REGULATION 498

HUNTING IN LAKE SUPERIOR PROVINCIAL PARK

1.—(1) The holder of a licence in Form 3 or 8 of Regulation 500 of Revised Regulations of Ontario, 1990 may hunt moose of the age and sex that the licence authorizes him or her to hunt,

- (a) where the licence is in Form 3, from the first Saturday in October to the 15th day of November, both inclusive, in any year; and
- (b) where the licence is in Form 8, from the Monday next following the first Saturday in October to the 15th day of November, both inclusive, in any year,

in the part of Lake Superior Provincial Park described in the Schedule, and may possess or use a firearm for the purpose. O. Reg. 130/83, s. 2, *part*; O. Reg. 220/85, s. 1.

(2) No holder of a licence to hunt moose shall take more than one moose. O. Reg. 130/83, s. 2, *part*.

2. The holder of a licence in Form 5 of Regulation 500 of Revised Regulations of Ontario, 1990 may hunt ruffed grouse, spruce grouse, sharp-tailed grouse and rabbits from the first Saturday in October to the 15th day of December, both inclusive, in any year in the part of Lake Superior Provincial Park described in the Schedule, and may possess or use a firearm for the purpose. O. Reg. 220/85, s. 2.

Schedule

All that part of Lake Superior Provincial Park in the Territorial District of Algoma lying easterly of that part of the King's Highway known as No. 17 and northerly of the southerly boundary of the geographic townships of Brimacombe and Broome. R.R.O. 1980, Reg. 419, Sched.

REGULATION 499

HUNTING IN LONG POINT NATIONAL WILDLIFE AREA

1. In this Regulation,

“antlered deer” means a deer that has at least one antler that is 7.5 centimetres or more in length;

“antlerless deer” means a deer that is not an antlered deer;

“hunting in a party” means hunting in a party of two or more persons each of whom may hunt under this Regulation and who have agreed to hunt co-operatively during a period in an area that can reasonably be hunted by the party during the period. O. Reg. 564/89, s. 1.

2. Regulation 500 of Revised Regulations of Ontario, 1990 (Hunting Licences) and Regulation 512 of Revised Regulations of Ontario, 1990 (Open Seasons—Moose and Deer) except subsection 13 (10) of Regulation 500 do not apply to the hunting of deer on the lands described in Schedule 1. O. Reg. 564/89, s. 2.

3. No person shall hunt any bird or animal on the lands described in Schedule 1 during any of the time periods set out in Schedule 2 except in accordance with this Regulation. O. Reg. 564/89, s. 3.

4.—(1) A holder of a licence in Form 1 or 2 of Regulation 500 of Revised Regulations of Ontario, 1990 (Hunting Licences) who has been issued a permit by the Canadian Wildlife Service and has attached the permit to the licence may, during the period specified in the permit, hunt antlered deer or antlerless deer or both, as the permit allows, on the lands described in Schedule 1.

(2) A person described in subsection (1) shall not take more deer than the number of seals provided with the person's permit.

(3) A person described in subsection (1) who is hunting in a party may hunt deer during the period specified in the person's permit on the lands described in Schedule 1.

(4) No person who is hunting in a party may possess,

- (a) an antlered deer if the number of antlered deer taken by the members of the party is more than the number of seals provided with the permits of the members that allow the hunting of antlered deer;
- (b) an antlerless deer if the number of antlerless deer taken by the members of the party is more than the number of seals provided with the permits of the members that allow the hunting of antlerless deer; or
- (c) a deer if the number of deer taken by the members of the party is more than the number of seals provided with the permits of the members. O. Reg. 564/89, s. 4.

5.—(1) A person who has taken a deer under this Regulation shall, before leaving the lands described in Schedule 1, produce the deer to an officer at one of the Canadian Wildlife Service check points on the lands described in Schedule 1 for inspection and shall allow the head and skin to be removed and retained by the Canadian Wildlife Service.

(2) A person who has taken a deer under this Regulation shall, after the head and skin have been removed, attach one of the seals provided with the permit issued to the person to the tendon of one of the hind legs of the deer and shall keep the seal attached while the deer is being transported. O. Reg. 564/89, s. 5.

6. A person may use only a rifle, shotgun or muzzle-loading gun to hunt deer under this Regulation. O. Reg. 564/89, s. 6.

7. The lands described in Schedule 1 are designated as areas in which no person shall use or be accompanied by a dog while hunting deer. O. Reg. 564/89, s. 7.

Schedule 1

All that part of Long Point National Wildlife Area in The Regional Municipality of Haldimand-Norfolk being composed of those parcels of land in the Township of Norfolk, formerly in the geographic Township of South Walsingham, in the County of Norfolk, more particularly described as all of Long Point Block Number One, the undivided east three-quarters of Block Number Two, Block Number Three, Block Number Four, lots 1, 2 and 3 in Block Number Five, Block Number Six, lots 1 to 11 in Block Number Seven, Block Number Eight, Block Number Nine, Block Number Ten, Block Number Eleven and Block Number Twelve. O. Reg. 564/89, Sched. 1.

Schedule 2

1. October 18 and 19.
2. October 20 and 21.
3. October 25 and 26.
4. October 27 and 28.
5. November 1 and 2.

6. November 3 and 4.
7. November 21 and 22.
8. November 23 and 24. O. Reg. 564/89, Sched. 2.

REGULATION 500

HUNTING LICENCES

1.—(1) In this Regulation,

“antlerless deer” means a deer that,

- (a) does not have antlers, or
- (b) has antlers both of which are less than 7.5 centimetres in length;

“bull moose” means a male moose that is at least one year old at the time of hunt;

“calf moose” means a moose that is less than one year old at the time of hunt;

“cow moose” means a female moose that is at least one year old at the time of hunt;

“immediate relative”, when used with reference to the holder of a licence in Form 3, means a grandparent, father, mother, spouse, son, daughter, brother, sister or grandchild of the holder;

“registered guest” means a person who,

- (a) contracts for accommodation with a tourist outfitter and whose name is entered in the register kept by the tourist outfitter under subsection 11 (1) of Regulation 1037 of Revised Regulations of Ontario, 1990, and
- (b) is actually accommodated either on the premises of the tourist establishment, or on a Crown land site, the occupation of which is authorized by a district manager of an administrative district of the Ministry of Natural Resources;

“tourist outfitter” means a person who,

- (a) operates a licensed tourist outfitter, outpost, cabin or cottage establishment, as defined in Regulation 1037 of Revised Regulations of Ontario, 1990, in a wildlife management unit that has an open season for moose,
- (b) is an air carrier licensed by the Canadian Transport Commission and Transport Canada and provides air transportation to a hunting outpost site, and customary services to moose hunters, in a wildlife management unit that has an open season for moose, or
- (c) operates a tourist establishment that is licensed under Regulation 1037 of Revised Regulations of Ontario, 1990 and provided overnight accommodation and customary services to moose hunters between the 1st day of January, 1978 and the 31st day of December, 1982. O. Reg. 138/83, s. 1, *part*; O. Reg. 499/87, s. 1.

(2) A reference in this Regulation to a wildlife management unit is a reference to that unit as numbered and described in the Schedule to Regulation 936 of Revised Regulations of Ontario, 1980 as that Schedule read on December 31st, 1990. O. Reg. 138/83, s. 1, *part*.

2.—(1) A licence issued to a resident,

- (a) to hunt deer, shall be in Form 1;

(b) who is a farmer, to hunt deer in the county, territorial district, regional municipality or district municipality, as the case may be, in which the farmer resides, shall be in Form 2;

(c) to hunt moose, shall be in Form 3;

(d) to hunt black bear, shall be in Form 4; and

(e) to hunt animals and birds, other than bear, caribou, elk, deer, moose, badger, beaver, bobcat, fisher, lynx, marten, mink, muskrat, otter, red squirrel or wolverine, shall be in Form 5.

(2) A licence issued to a non-resident,

(a) to hunt fox, game birds, rabbits, raccoon, squirrel other than red squirrel and wolf, shall be in Form 5;

(b) to hunt deer, shall be in Form 7;

(c) to hunt moose, shall be in Form 8;

(d) to hunt black bear, shall be in Form 9. O. Reg. 138/83, s. 1, *part*.

(3) No licence in Form 8 shall be issued unless,

(a) where the applicant proposes to hunt as a registered guest, the applicant possesses and produces to the issuer a tag in Form 28; or

(b) in all other cases, the applicant files with the issuer an application in Form 30. O. Reg. 186/84, s. 1.

(4) A licence issued to a hunt club recognized by or registered with the Masters of Foxhounds Association of America Incorporated that authorizes the members thereof to hunt fox shall be in Form 10. O. Reg. 138/83, s. 1, *part*.

3.—(1) A licence in Form 1, 2 or 7 is not valid for hunting deer with a bow and arrow unless a tag in Form 11 is affixed to the licence.

(2) A licence in Form 1 or 2 is not valid for hunting antlerless deer unless a tag in Form 23, 24, 25 or 27 is affixed to the licence.

(3) The holder of a licence in Form 1 or 2 shall not hunt antlerless deer in any wildlife management unit other than the wildlife management unit specified on the tag affixed to the licence.

(4) A licence in Form 7 is not valid for hunting antlerless deer.

(5) An application for a tag in Form 23 or 24 shall be in the form furnished by the Ministry of Natural Resources with the licence in Form 1 or 2. O. Reg. 138/83, s. 1, *part*.

(6) An application for a tag in Form 25, 26 or 27 shall be in a form furnished by the Ministry of Natural Resources. O. Reg. 410/87, s. 1.

(7) No person shall use a form other than the form furnished by the Ministry of Natural Resources with the person's licence in Form 1 or 2 to apply for a tag referred to in subsection (5). O. Reg. 138/83, s. 1, *part*.

(8) No person shall submit more than one application for a controlled deer hunting validation tag and the application may be either for a tag in Form 25 or 26.

(9) No person shall possess more than one controlled deer hunting validation tag and the tag may be either in Form 25 or 26. O. Reg. 58/88, s. 1.

(10) A licence in Form 5 issued to a resident is not valid for hunting raccoon at night unless a tag in Form 13 is affixed to the licence.

- (11) A licence in Form 5 issued to a non-resident is not valid unless a tag in Form 6 or 14 is affixed to the licence and in any case is not valid for hunting raccoon at night. O. Reg. 138/83, s. 1, *part*.
- (12) A licence in Form 5 is not valid for hunting wild turkey unless a tag in Form 12 is affixed to the licence before the hunt.
- (13) A non-resident is not entitled to be issued a tag in Form 12. O. Reg. 688/86, s. 1, *part*.
- (14) It is a condition for receiving a tag in Form 12 that the applicant successfully complete a wild turkey hunter education program sanctioned by the Ministry. O. Reg. 725/88, s. 1.
- (15) An application for a tag in Form 12 shall be in the form furnished by the Ministry. O. Reg. 688/86, s. 1, *part*.
- 4.—(1) A licence in Form 3 is not valid for hunting moose other than calf moose unless a tag in Form 28 is affixed to the licence before the hunt. O. Reg. 138/83, s. 1, *part*; O. Reg. 186/84, s. 2 (1).
- (2) A licence in Form 8 is not valid for hunting moose unless a tag in Form 28 is affixed to the licence before the hunt and the holder,
- (a) is hunting with an immediate relative who is the holder of a licence in Form 3; or
- (b) is, at the time of hunt,
- (i) a registered guest, or
- (ii) the owner of real property in a wildlife management unit that has an open season for non-residents. O. Reg. 138/83, s. 1, *part*; O. Reg. 186/84, s. 2 (2).
- (3) A tag that authorizes the holder of a licence in Form 3 or 8 to hunt moose of the age and sex specified on the tag and under the conditions specified on the tag shall be in Form 28. O. Reg. 186/84, s. 2 (3).
- (4) An application for a tag in Form 28,
- (a) by a resident, shall be in Form 29;
- (b) by a non-resident, shall be in Form 30; or
- (c) by a tourist outfitter applying on behalf of a registered guest, shall be in Form 31. O. Reg. 138/83, s. 1, *part*.
- (5) No resident shall use a form other than the form furnished by the Ministry of Natural Resources with the licence in Form 3 to apply for a tag in Form 28.
- (6) No tag in Form 28 shall be issued to a non-resident who does not propose to hunt as a registered guest unless the non-resident possesses and produces to the issuer a licence in Form 8. O. Reg. 186/84, s. 2 (4).
- (7) Where a holder of a licence in Form 3 has obtained a tag in Form 28 from a tourist outfitter, the holder shall be a registered guest of the tourist outfitter during the hunt.
- (8) No tourist outfitter shall assign a tag in Form 28 to a hunter unless the hunter has contracted with the tourist outfitter for accommodation during the hunt. O. Reg. 499/87, s. 2.
- (9) No person shall submit more than one application in Form 29 or 30, or possess more than one tag in Form 28 at the time of hunt.
- (10) The holder of a licence in Form 3 or 8 shall not hunt bull or cow moose in any wildlife management unit other than the wildlife management unit specified on the tag in Form 28 affixed to the holder's licence.
- (11) A licence in Form 8,
- (a) is valid for hunting calf moose in any wildlife management unit during an open season for non-residents in the wildlife management unit if,
- (i) a tag in Form 28 authorizing the hunting is affixed to the licence, and
- (ii) the holder of the licence is a registered guest or is hunting with an immediate relative who holds a licence in Form 3; and
- (b) is valid for hunting calf moose in a specified wildlife management unit during an open season for non-residents in the wildlife management unit if,
- (i) a tag in Form 28 authorizing the hunting in the wildlife management unit is affixed to the licence, and
- (ii) the holder of the licence is the owner of real property in the wildlife management unit.
- (12) A tag in Form 28 that authorizes hunting moose in a specified wildlife management unit during an open season that is restricted to the use of bows and arrows or flintlock or percussion cap muzzle-loading guns expires with the last day of the open season, but where the holder of the licence in Form 8 to which the tag is affixed has not killed a moose during the open season and,
- (a) is a registered guest or is hunting with an immediate relative who holds a licence in Form 3, the first-named holder may hunt calf moose in any wildlife management unit during an open season for non-residents in the wildlife management unit; or
- (b) is the owner of real property in the specified wildlife management unit, the holder may hunt calf moose during a subsequent open season for non-residents in the wildlife management unit. O. Reg. 138/83, s. 1, *part*.
- 5.—(1) A tag that authorizes the holder of a licence in Form 1, 2 or 7 to hunt deer with a bow and arrow shall be in Form 11. O. Reg. 502/81, s. 2, *part*.
- (2) A tag that authorizes a resident who is the holder of a licence in Form 5 to hunt raccoon at night shall be in Form 13.
- (3) A tag that authorizes a non-resident who is the holder of a licence in Form 5 to hunt fox, game birds, squirrels (other than red squirrel) and wolf and game birds on a game bird hunting preserve shall be in Form 6.
- (4) A tag that authorizes a non-resident who is the holder of a licence in Form 5 to hunt only game birds on a game bird hunting preserve shall be in Form 14. O. Reg. 502/81, s. 2, *part*.
- (5) A tag that authorizes the holder of a licence in Form 1 or 2 whose name has been drawn in a draw conducted by the Ministry of Natural Resources to hunt antlerless deer in the wildlife management unit specified on the tag shall be in Form 23.
- (6) A tag that authorizes the holder of a licence in Form 1 or 2,
- (a) who has a tag in Form 11; and
- (b) whose name has been drawn in a draw conducted by the Ministry of Natural Resources,
- to hunt antlerless deer when only bows and arrows may be used to hunt deer in the wildlife management unit specified in the tag shall be in Form 24.
- (7) A tag that authorizes the holder of a licence in Form 1 or 2 to

hunt deer in the wildlife management unit specified on the tag shall be in Form 25.

(8) A tag that authorizes the holder of a licence in Form 1 or 2 to hunt antlerless deer in the wildlife management unit specified on the tag shall be in Form 27. O. Reg. 397/82, s. 1, *part*.

6.—(1) A licence that authorizes a resident to use a dog while hunting raccoon at night shall be in Form 15.

(2) A licence that authorizes the use of a dog while hunting deer or moose shall be in Form 16. R.R.O. 1980, Reg. 420, s. 4.

7. A licence issued under section 53 or 71 of the Act shall be in Form 17. R.R.O. 1980, Reg. 420, s. 5.

8.—(1) The Minister may appoint as an examiner any employee of the Ministry of Natural Resources who, in the opinion of the Minister, is competent to examine an applicant for a hunting licence examination on the applicant's knowledge of hunter safety, game laws, game identification and the applicant's ability in the safe handling of firearms, and, upon the applicant's successful completion of the examination, the applicant shall be issued with a certificate by the examiner. O. Reg. 127/83, s. 1 (1).

(2) An examination shall be held at such time and place as the examiner determines. R.R.O. 1980, Reg. 420, s. 6 (2).

(3) The fee for an examination is \$8. O. Reg. 608/90, s. 1.

(4) An application for an examination shall be in Form 18. R.R.O. 1980, Reg. 420, s. 6 (4).

(5) Every applicant for an examination shall produce with the application,

- (a) a certificate issued to the applicant by a hunting instructor under section 3 of Regulation 497 of Revised Regulations of Ontario, 1990;
- (b) a certificate indicating that the applicant has completed a hunter safety training course issued to the applicant after the 1st day of January, 1968 by a competent authority in any jurisdiction; or
- (c) a hunting licence issued to the applicant by a competent authority in any jurisdiction as a resident thereof after the 1st day of January, 1968. O. Reg. 127/83, s. 1 (2); O. Reg. 525/86, s. 1.

(6) Where the applicant referred to in subsection (5) is a resident and fails to pass the applicant's first hunting licence examination in Ontario, the applicant shall not apply for re-examination unless the applicant files with the application a certificate issued to the applicant by a hunting instructor under section 3 of Regulation 497 of Revised Regulations of Ontario, 1990. O. Reg. 127/83, s. 1 (3).

9.—(1) A hunting licence verification certificate or a duplicate examiner's certificate shall be in Form 19. R.R.O. 1980, Reg. 420, s. 7 (1).

(2) An application for,

- (a) a hunting licence verification certificate;
- (b) a duplicate hunting licence;
- (c) a new badge; or
- (d) a duplicate examiner's certificate,

shall be in Form 20 and the fee therefor is \$6.50. R.R.O. 1980, Reg. 420, s. 7 (2); O. Reg. 502/81, s. 3; O. Reg. 184/84, s. 1; O. Reg. 519/86, s. 2; O. Reg. 615/89, s. 2; O. Reg. 608/90, s. 2.

10.—(1) An application for a licence in Form 1, 3, 4, 5, 7, 8 or 9 shall be in Form 21.

(2) An application for a licence in Form 2 shall be in Form 22.

(3) An application for renewal that is provided with a hunting licence in Form 1, 3, 4, 5, 7, 8 or 9 shall be deemed to be an application in Form 21. O. Reg. 127/83, s. 2, *part*.

(4) No licence in Form 1, 2, 3, 4 or 5 shall be issued to a resident unless the resident's application therefor is supported by,

- (a) a hunting licence issued to the resident as a resident under subsection 2 (1) after the 1st day of January, 1968;
- (b) a certificate issued to the resident by an examiner under subsection 8 (1) after the 1st day of January, 1968; or
- (c) a hunting licence verification certificate in Form 19 indicating that the applicant was issued a hunting licence as a resident or passed a hunting licence examination. O. Reg. 127/83, s. 2, *part*; O. Reg. 376/83, s. 2 (1).

(5) No licence in Form 5, 7, 8 or 9 shall be issued to a non-resident unless the non-resident's application therefor is supported by,

- (a) a hunting licence issued to the non-resident under subsection 2 (2) after the 1st day of January, 1968;
- (b) a hunting licence issued to the non-resident by a competent authority in any jurisdiction as a resident thereof after the 1st day of January, 1968;
- (c) a certificate issued to the non-resident by an examiner under subsection 8 (1) after the 1st day of January, 1968;
- (d) a hunting licence verification certificate in Form 19; or
- (e) a certificate issued to the non-resident after the 1st day of January, 1968 by a competent authority in any jurisdiction which indicates that the holder thereof was or is authorized to purchase a hunting licence in that jurisdiction. O. Reg. 127/83, s. 2, *part*; O. Reg. 376/83, s. 2 (2).

(6) Despite subsections (4) and (5), a hunting licence may be issued to an applicant who is a representative of a foreign government and has taken a post in Ontario in the capacity of,

- (a) ambassador or high commissioner;
- (b) minister;
- (c) counsellor;
- (d) secretary;
- (e) attaché;
- (f) consul-general, consul or vice-consul; or
- (g) trade commissioner or assistant trade commissioner,

where the application is supported by the production of a hunting licence previously issued to the applicant by a competent authority in any jurisdiction.

(7) Subject to subsection (4), a licence in Form 1, 2, 3, 4 or 5 may be issued to a person who is fifteen years of age if he or she files with the person issuing the licence a consent signed,

- (a) where he or she resides with his or her parents, by both parents; and
- (b) in all other cases, by his or her parent or by the person who has custody of him or her. O. Reg. 127/83, s. 2, *part*.

11.—(1) The holder of a licence in Form 1, 2 or 7 shall attach to the head of a deer the seal provided with the licence by affixing the seal to the cartilage separating the nostrils in the manner prescribed on the seal immediately after the deer has been killed and at the site where it was killed and shall keep the seal attached thereto while the deer is being transported. O. Reg. 499/82, s. 1, *part*.

(2) Subject to subsections (9) and (10), a holder of a licence in Form 3 or 8 who is not hunting in a party and who has killed a moose or who is hunting in a party a member of which has killed a moose, shall attach the seal provided with the licence,

- (a) in the case of a calf moose, to its lower jaw, which shall be kept whole but may be separated from the head;
- (b) in the case of a bull or cow moose, to the tendon of one of its hind legs, keeping the scrotal sac or vulva, as the case may be, attached to that leg or connective tissue,

in the manner prescribed on the seal, immediately after the moose has been killed and at the site where it was killed and shall keep the seal attached to the moose while it is being transported. O. Reg. 571/88, s. 1 (1).

(3) A holder of a licence in Form 4 or 9 who has killed a bear shall attach the seal provided with the licence to the carcass of the bear in the manner prescribed on the seal, immediately after the bear has been killed, and at the site where it was killed, and shall keep the seal attached to the bear while it is being transported. O. Reg. 138/83, s. 3 (1), *part*.

(4) Every holder of a licence in Form 5 who has killed a wild turkey shall,

- (a) immediately after the kill and at the site of the kill, attach the seal provided with the tag in Form 12 to the leg of the turkey in the manner indicated on the seal; and
- (b) keep the seal attached to the leg of the turkey at all times until it is prepared for consumption. O. Reg. 688/86, s. 2 (1).

(5) The seal provided with a licence in Form 1, 2, 3, 4, 7, 8 or 9 expires with the fourth day after the close of the open season. O. Reg. 683/82, s. 1.

(6) The holder of a licence in Form 1, 2, 3, 4, 5, 7, 8 or 9 shall provide the information required on the seal in the manner prescribed on the seal immediately after the animal has been killed. O. Reg. 138/83, s. 3 (2), *part*; O. Reg. 688/86, s. 2 (2).

(7) No holder of a licence in Form 1 or 2 shall attach the seal provided with the licence to an antlerless deer that has been killed by another person. O. Reg. 571/88, s. 1 (2).

(8) No holder of a licence in Form 5 shall attach the seal provided with the tag in Form 12 to a wild turkey that has been killed by another person. O. Reg. 688/86, s. 2 (3), *part*.

(9) No holder of a licence in Form 3 or 8 other than the holder of a licence that has been validated to hunt bull moose shall attach the seal provided with the licence to a bull moose.

(10) No holder of a licence in Form 3 or 8 other than the holder of a licence that has been validated to hunt cow moose shall attach the seal provided with the licence to a cow moose. O. Reg. 571/88, s. 1 (3).

(11) Except as otherwise provided in the regulations, the holder of a licence in Form 1, 2, 3, 4, 7, 8 or 9 shall, at the time of hunt, have the seal provided with the licence on his or her person and shall produce and show it to any officer whenever requested by the officer. O. Reg. 219/85, s. 1.

(12) Except as otherwise provided in this Regulation, the holder

of a licence in Form 5 shall, at the time of the hunt, have a seal provided with the tag in Form 12 on his or her person and shall produce and show it to any officer on request by the officer. O. Reg. 688/86, s. 2 (3), *part*.

12. Subsections 3 (12) and 11 (4) do not apply to a holder of a licence in Form 5 when hunting wild turkeys on a game bird hunting preserve as authorized under Regulation 493 of Revised Regulations of Ontario, 1990. O. Reg. 688/86, s. 3.

13.—(1) Subject to subsection (2), the holder of a licence in Form 1, 2 or 5 shall not,

- (a) carry or use a rifle of greater calibre or projectile power than the rifle known as a .22-calibre rim-fire rifle; or
- (b) while hunting with a shotgun have in his or her gun or on his or her person any shotgun shells loaded with ball or with shot larger than number two shot,

in an area during an open season for moose in that area. R.R.O. 1980, Reg. 420, s. 10 (1); O. Reg. 524/86, s. 1 (1), *part*.

(2) The holder of a licence in Form 1 or 2 may do any of the acts prohibited by subsection (1) in an area during an open season for deer and moose in that area. R.R.O. 1980, Reg. 420, s. 10 (2).

(3) Subject to subsection (4), the holder of a licence in Form 3 or 5 shall not,

- (a) carry or use a rifle of greater calibre or projectile power than the rifle known as a .22-calibre rim-fire rifle; or
- (b) while hunting with a shotgun have in his or her gun or on his or her person any shotgun shells loaded with ball or with shot larger than number two shot,

in an area during an open season for deer in that area. R.R.O. 1980, Reg. 420, s. 10 (3); O. Reg. 524/86, s. 1 (1), *part*.

(4) The holder of a licence in Form 3 may do any of the acts prohibited by subsection (3) in an area during an open season for deer and moose in that area. R.R.O. 1980, Reg. 420, s. 10 (4).

(5) The holder of a licence in Form 4 shall not,

- (a) carry or use a rifle of greater calibre or projectile power than the rifle known as a .22-calibre rim-fire rifle; or
- (b) while hunting with a shotgun have in his or her gun or on his or her person any shotgun shells loaded with ball or with shot larger than number two shot,

in an area during an open season for deer or moose in that area, unless he or she has a valid licence to hunt deer or moose in that area. R.R.O. 1980, Reg. 420, s. 10 (5); O. Reg. 524/86, s. 1 (1), *part*.

(6) The holder of a licence in Form 7 shall not,

- (a) carry or use a rifle of greater calibre or projectile power than the rifle known as a .22-calibre rim-fire rifle; or
- (b) while hunting with a shotgun have in his or her gun or on his or her person any shotgun shells loaded with ball or with shot larger than number two shot,

in an area during an open season for moose in that area, unless there is in addition to an open season for moose, an open season for deer in that area that is not restricted to residents. R.R.O. 1980, Reg. 420, s. 10 (6); O. Reg. 524/86, s. 1 (1), *part*.

(7) The holder of a licence in Form 8 shall not,

- (a) carry or use a rifle of greater calibre or projectile power than the rifle known as a .22-calibre rim-fire rifle; or
- (b) while hunting with a shotgun have in his or her gun or on his or her person any shotgun shells loaded with ball or with shot larger than number two shot,

in an area during an open season for deer in that area, unless there is in addition to an open season for deer, an open season for moose in that area that is not restricted to residents. R.R.O. 1980, Reg. 420, s. 10 (7); O. Reg. 524/86, s. 1 (1), *part*.

(8) The holder of a licence in Form 9 shall not,

- (a) carry or use a rifle of greater calibre or projectile power than the rifle known as a .22-calibre rim-fire rifle; or
- (b) while hunting with a shotgun have in his or her gun or on his or her person any shotgun shells loaded with ball or with shot larger than number two shot,

in an area during an open season for deer or moose in that area, unless he has a valid licence to hunt deer or moose in that area. R.R.O. 1980, Reg. 420, s. 10 (8); O. Reg. 524/86, s. 1 (1), *part*.

(9) The holder of a licence in Form 5 shall not carry or use a rifle of greater calibre than the rifle known as a .275-calibre rifle, except a flint lock or percussion cap muzzle loading rifle, in the counties of Brant, Elgin, Essex, Huron, Kent, Lambton, Middlesex, Northumberland, Oxford, Perth and Wellington, the regional municipalities of Durham, Haldimand-Norfolk, Halton, Hamilton-Wentworth, Niagara, Peel, Waterloo and York and The Municipality of Metropolitan Toronto.

(10) No person shall use a rifle known as a rim-fire rifle, a shotgun smaller than 20 gauge when loaded with shot or any shotgun loaded with shot smaller than SG or number 1 buck for the purpose of hunting bear, caribou, deer, elk or moose. R.R.O. 1980, Reg. 420, s. 10 (9, 10).

(11) The holder of a licence that authorizes the holder to hunt racoon at night shall not carry or use a firearm other than a .22-calibre rim-fire rifle chambered for cartridges known as .22 short, .22 long or .22 long rifle when hunting racoon. O. Reg. 524/86, s. 1 (2).

(12) The holder of a licence that authorizes the holder to hunt racoon at night shall not have in the holder's possession while in a vehicle or vessel a firearm unless it is unloaded and encased. R.R.O. 1980, Reg. 420, s. 10 (12).

14. Despite section 13, where there is an open season for hunting deer with a bow and arrow only, in a part of Ontario lying south of the French and Mattawa rivers, the holder of a licence in Form 5 may carry or use,

- (a) a rifle of greater calibre or projectile power than the rifle known as a .22-calibre rim-fire rifle; or
- (b) a shotgun loaded with ball or with shot larger than number two shot,

to hunt game that the licence authorizes, provided that there is an open season therefor. R.R.O. 1980, Reg. 420, s. 11; O. Reg. 524/86, s. 2.

15. Subject to Regulation 479 of Revised Regulations of Ontario, 1990 and despite subsections 13 (5) and (8), the holder of a licence in Form 4 or 9 may carry or use any firearm other than,

- (a) a rifle known as a rim-fire rifle;
- (b) a shotgun smaller than 20 gauge when loaded with shot; or

- (c) a shotgun loaded with shot smaller than SG or number 1 buck,

to hunt black bear during an open season therefor in a wildlife management unit during an open season in that unit for hunting deer or moose with bow and arrow only. O. Reg. 683/82, s. 2.

16.—(1) No person shall,

- (a) take or capture a fox;
- (b) possess or use a firearm; or
- (c) use or be accompanied by less than twelve or more than fifty dogs,

while hunting under the authority of a licence in Form 10.

(2) It is a condition of a licence in Form 10 that not less than three persons and, subject to subsection 18 (4) of the Act, not more than 125 persons shall hunt at one time under the authority of the licence. R.R.O. 1980, Reg. 420, s. 12.

17.—(1) A licence in Form 1, 2, 3, 4, 7, 8, 9, 16 or 17 expires with the 31st day of December next following the date on which it is issued. R.R.O. 1980, Reg. 420, s. 13 (1).

(2) Except as otherwise provided herein, a licence in Form 5 issued to a resident is valid only,

- (a) from the 1st day of September to and including the 31st day of August next following in that part of Ontario described in Schedule 1 and referred to as the Southern Region; and
- (b) from the 1st day of September to and including the 15th day of June next following in any part of Ontario described in Schedule 2 and referred to as the Northern Region. R.R.O. 1980, Reg. 420, s. 13 (2); O. Reg. 155/83, s. 2 (1).

(3) Except as otherwise provided herein, a licence in Form 5 issued to a non-resident is valid only from the 1st day of September to and including the last day of February next following. R.R.O. 1980, Reg. 420, s. 13 (3).

(4) Despite subsection (2), a licence in Form 5 issued to a resident is valid to hunt game birds on a game bird hunting preserve from and including the 1st day of September to and including the 31st day of August next following. O. Reg. 624/85, s. 1.

(5) Despite subsection (3), a licence in Form 5 issued to a non-resident is valid to hunt game birds on a game bird hunting preserve from and including the 1st day of September to and including the 31st day of August next following, if there is affixed thereto a tag in Form 6 or 14. R.R.O. 1980, Reg. 420, s. 13 (5).

(6) Despite subsection (3), a licence in Form 5 issued to a non-resident is valid to hunt wolves from and including the 1st day of September to and including the 15th day of June next following if there is affixed thereto a tag in Form 6. O. Reg. 187/82, s. 1.

(7) A licence in Form 10 is valid only from and including the 1st day of April to and including the 31st day of December next following.

(8) A licence in Form 15 is valid only from and including the 1st day of September to and including the last day of February next following. R.R.O. 1980, Reg. 420, s. 13 (6, 7).

18. Despite subsection 17 (1) and except as otherwise provided in the regulations, a licence in Form 1, 2, 3, 4, 7, 8 or 9 expires when the seal provided therewith is attached to the carcass of a bear, deer or moose, as the case may be. R.R.O. 1980, Reg. 420, s. 14.

19. Where a holder of a licence in Form 8 is hunting with an immediate relative and the immediate relative kills and seals a

moose, the holder of the licence in Form 8 may continue to hunt for a moose provided he or she is accompanied by the immediate relative. O. Reg. 186/84, s. 4.

20. Where a person holds a licence in Form 3 or 8 and also holds a licence in Form 4 or 9, and the person lawfully kills and seals a moose, the person may continue to hunt for a black bear in the area where the licence in Form 3 or 8 was valid prior to the taking of the moose. O. Reg. 84/86, s. 1.

21. Where a person holds a licence in Form 1, 2 or 7 and also holds a licence in Form 4 or 9, and the person lawfully kills and seals a deer, the person may continue to hunt for a black bear in any part of Ontario in which the licensee is authorized to hunt black bear. O. Reg. 335/86, s. 1.

22.—(1) A tag in Form 6 or 13 is valid from and including the 1st day of September to and including the last day of February next following.

(2) Despite subsection (1), a tag in Form 6 is valid to hunt game birds on a game bird hunting preserve from and including the 1st day of September to and including the 31st day of August next following. R.R.O. 1980, Reg. 420, s. 15 (1, 2).

(3) Despite subsection (1), a tag in Form 6 is valid to hunt wolves from and including the 1st day of September to and including the 15th day of June next following. O. Reg. 187/82, s. 2.

(4) A tag in Form 11 expires with the 31st day of December next following the date on which it is issued. R.R.O. 1980, Reg. 420, s. 15 (3).

(5) A tag in Form 14 is valid from and including the 1st day of September to and including the 31st day of August next following. R.R.O. 1980, Reg. 420, s. 15 (5).

23.—(1) Subject to subsection (2), a licence in Form 1, 2 or 7 is not valid for hunting deer on Barrie Island or Manitoulin Island in the Territorial District of Manitoulin, unless the licence has attached to it a consent,

- (a) in a form furnished by the Ministry of Natural Resources; and
- (b) signed by the owner of the land on any such island on which the holder of the licence is hunting deer.

(2) Subsection (1) does not apply to a licence mentioned therein where the holder thereof is the owner of land and hunts on the owner's own land. R.R.O. 1980, Reg. 420, s. 16.

24.—(1) In this section,

“authorized employee” means an employee of the Ministry of Natural Resources who is authorized to issue a certificate in Form 33;

“black bear guiding or baiting services” means black bear guiding or baiting services rendered by a person who,

- (a) has provided those services to non-resident hunters in at least one of the three years immediately before the coming into force of this section, and
- (b) is authorized in writing by the district manager of the administrative district of the Ministry of Natural Resources where these services have been provided to issue a certificate in Form 33;

“farm vacation house” means a house on land used for agricultural purposes, designed, fitted or employed as a temporary dwelling for a person on vacation;

“houseboat” means a boat designed, fitted or employed as a temporary or permanent dwelling;

“immediate relative”, when used with reference to the holder of a licence in Form 4, means a grandparent, father, mother, spouse, son, daughter, brother, sister or grandchild of the holder;

“operator of a tourist establishment” includes a person who has provided to non-resident hunters in at least one of the three years immediately before the coming into force of this section,

- (a) accommodation in a farm vacation house, on a houseboat or on lands of an Indian band,
- (b) non-resident black bear guiding or baiting services, or
- (c) air transportation to a hunting outpost site and customary services to black bear hunters, where the air carrier is licensed by the Canadian Transport Commission and Transport Canada;

“tourist establishment” means an establishment that accommodated non-resident black bear hunters or provided black bear guiding or baiting services in at least one of the three years immediately before the coming into force of this section where the establishment consists of any one or a combination of any of,

- (a) a cabin establishment,
- (b) a camping establishment,
- (c) a cottage establishment,
- (d) a hotel,
- (e) a motel,
- (f) a motor hotel,
- (g) an outpost establishment,
- (h) a resort, or
- (i) a tourist outfitter establishment,

as defined in Regulation 1037 of Revised Regulations of Ontario, 1990. O. Reg. 27/87, s. 1, *part*; O. Reg. 499/87, s. 3; O. Reg. 629/87, s. 1; O. Reg. 261/89, s. 1 (1).

(2) A licence in Form 9 is not valid for hunting black bear unless a certificate in Form 33 signed by an authorized employee or an operator of a tourist establishment is attached to the licence and the holder of the licence,

- (a) is hunting with an immediate relative who is the holder of a licence in Form 4; or
- (b) at the time of the hunt,
 - (i) owns real property in a wildlife management unit that has an open season for the hunting of black bear for non-residents, or
 - (ii) has contracted for bear guiding or baiting services with the operator of a tourist establishment and is accommodated,
 - (A) on the premises of the tourist establishment,
 - (B) on a Crown land site, the occupation of which is authorized by a district manager of an administrative district of the Ministry of Natural Resources, or
 - (C) on privately owned lands, the occupation of which is authorized by the owner thereof. O. Reg. 27/87, s. 1, *part*; O. Reg. 261/89, s. 1 (2).

(3) An owner of real property referred to in subsection (2) shall not hunt in a wildlife management unit other than the wildlife management unit in which the real property is located.

(4) No person other than an authorized employee or an operator of a tourist establishment to whom certificates in Form 33 have been delivered and whose signature is on file with the district manager of an administrative district of the Ministry of Natural Resources for the purpose of issuing a certificate in Form 33 shall issue the certificate.

(5) No person shall transfer a certificate in Form 33. O. Reg. 27/87, s. 1, *part*.

(6) No operator of a tourist establishment shall issue a certificate in Form 33 to a non-resident hunter unless the hunter has contracted with the operator for black bear guiding or baiting services. O. Reg. 261/89, s. 1 (3).

(7) An application for a certificate in Form 33 by a non-resident who,

- (a) will be hunting with an immediate relative who is the holder of a licence in Form 4; or
- (b) is, at the time of the application and will be at the time of the hunt, the owner of real property in a wildlife management unit that has an open season for the hunting of black bear for non-residents,

shall be in Form 32. O. Reg. 27/87, s. 1, *part*.

(8) A certificate in Form 33 shall be issued in triplicate and the issuer shall,

- (a) issue an original copy to the applicant therefor;
- (b) complete the part of the certificate preceding the hunter's report;
- (c) present the duplicate copy to the applicant for the completion of the report upon conclusion of the hunt;
- (d) retain the triplicate copy for not less than one year after the day on which the certificate expires;
- (e) return the duplicate copy of each issued certificate with the completed hunter's report to the district manager of the administrative district of the Ministry of Natural Resources in which the certificate was issued on or before,
 - (i) the 10th day of July in the year the certificate is issued in the case of a certificate issued before the 30th day of June, and

(ii) the 10th day of December in the year the certificate is issued in all other cases; and

- (f) return all three copies of the unissued, cancelled or void certificates on or before the 10th day of December in the year the certificates are delivered to the issuer to the district manager of the administrative district of the Ministry of Natural Resources in which the certificates were delivered for issuance. O. Reg. 132/87, s. 2; O. Reg. 554/88, s. 1; O. Reg. 261/89, s. 1 (4).

(9) A certificate in Form 33 is valid for the area and for the period specified in the certificate. O. Reg. 261/89, s. 1 (5).

25. A licence in Form 5 issued to a non-resident is not valid for hunting rabbits in the County of,

- (a) Essex, except the Township of Pelee;
- (b) Kent; or
- (c) Lambton. R.R.O. 1980, Reg. 420, s. 17.

26. The fee for a licence or tag in a Form in column 1 of Schedule 3 is,

- (a) the fee in column 2; and
- (b) the issuing fee in column 3,

set opposite thereto. R.R.O. 1980, Reg. 420, s. 18.

Schedule 1

SOUTHERN REGION

That part of Ontario described as follows:

1. The counties of Brant, Bruce, Dufferin, Dundas, Elgin, Essex, Frontenac, Glengarry, Grenville, Grey, Haliburton, Hastings, Huron, Kent, Lambton, Lanark, Leeds, Lennox and Addington, Middlesex, Northumberland, Oxford, Perth, Peterborough, Prescott, Prince Edward, Renfrew, Russell, Simcoe, Stormont, Victoria, and Wellington.

2. The regional municipalities of Durham, Haldimand-Norfolk, Halton, Hamilton-Wentworth, Niagara, Ottawa-Carleton, Peel, Waterloo, and York. R.R.O. 1980, Reg. 420, Sched. 1.

Schedule 2

NORTHERN REGION

Any part of Ontario other than that part described in Schedule 1. R.R.O. 1980, Reg. 420, Sched. 2.

Schedule 3

COLUMN 1	COLUMN 2		COLUMN 3
Form	Fee		Issuing Fee
1	\$ 18.75		\$1.50
2	13.00		.50
3	25.00		1.50
4	18.75		1.50
5	5.75	on or after the 1st day of September, 1991, \$6.00	.50
6	40.25	on or after the 1st day of September, 1991, \$42.25	1.50
7	103.50		1.50
8	229.00		2.00
9	103.50		1.50
10	52.50		NIL
11	.50		.50
12	14.00		NIL
13	5.75	on or after the 1st day of September, 1991, \$6.00	NIL
14	5.75	on or after the 1st day of September, 1991, \$6.00	.50
15	5.75	on or after the 1st day of September, 1991, \$6.00	NIL
16	6.00		.50

O. Reg. 608/90, s. 3.

Form 1

Game and Fish Act

RESIDENT'S LICENCE TO HUNT DEER IN 19.....

Social Insurance Number

Licence Serial Number

--	--	--	--	--	--	--	--	--	--

Under the Game and Fish Act and the regulations, and subject to the limitations thereof, this licence is issued to

Mr./ Last Name (print)

Ms.
Mrs.
Miss

--	--	--	--	--	--	--	--	--	--	--	--	--	--	--	--	--	--	--	--	--	--	--	--

First Name (print)

Initial

--	--	--	--	--	--	--	--	--	--	--	--	--	--	--	--	--	--	--	--	--	--	--	--	--	--	--

Date of Birth		
Year	Month	Day

Street Address, Apt. No., P.O. Box or Rural Route (print)

--	--	--	--	--	--	--	--	--	--	--	--	--	--	--	--	--	--	--	--	--	--	--	--	--	--	--	--

Qualification Produced	
Province, State or Country	Year
Serial No.	

Postal Code

--	--	--	--	--	--

of City, Town or Village (print)

Grid for City, Town or Village name

Height

Weight

Colour of Hair

Colour of Eyes

Table with columns: Lot, Concession, Township of

to hunt deer during the open season in 19.....

This licence is not valid for hunting deer that (a) do not have antlers; or (b) have antlers both of which are less than 7.5 centimetres in length unless there is affixed hereto a tag furnished by the Ministry.

..... (signature of issuer) (date) (signature of licensee)

Table for affixing validation tags

R.R.O. 1980, Reg. 420, Form 1; O. Reg. 184/84, s. 3, part; O. Reg. 699/84, s. 2, part; O. Reg. 519/86, s. 4 (1).

Form 2

Game and Fish Act

FARMER'S LICENCE TO HUNT DEER IN 19.....

Social Insurance Number

Licence Serial Number

Grids for Social Insurance Number and Licence Serial Number

Under the Game and Fish Act and the regulations, and subject to the limitations thereof, this licence is issued to

Mr./ Last Name (print)

Grid for Last Name with title options: Ms., Mrs., Miss

First Name (print)

Grid for First Name

Initial

Grid for Initial

Date of Birth

Table for Date of Birth: Year, Month, Day

Street Address, Apt. No., P.O. Box or Rural Route (print)

Grid for Street Address

Qualification Produced

Table for Qualification Produced: Province, State or Country, Year

Postal Code

Grids for Postal Code

Table for Qualification Produced: Serial No.

of City, Town or Village (print)

Grid for address line 1

Height

Weight

Colour of Hair

Colour of Eyes

a farmer on

Table with columns: Lot, Concession, Township of

to hunt deer during the open season in 19..... in the county (or as the case may be) in which he or she resides.

This licence is not valid for hunting deer that (a) do not have antlers; or (b) have antlers both of which are less than 7.5 centimetres in length unless there is affixed hereto a tag furnished by the Ministry.

..... (signature of issuer) (date) (signature of licensee)

Table for affixing deer-related validation tags

R.R.O. 1980, Reg. 420, Form 2; O. Reg. 184/84, s. 3, part; O. Reg. 699/84, s. 2, part; O. Reg. 519/86, s. 4 (2).

Form 3

Game and Fish Act

RESIDENT'S LICENCE TO HUNT MOOSE IN 19.....

Licence Serial Number

Under the Game and Fish Act and the regulations, and subject to the limitations thereof, this licence is issued to

Mr./ Ms. Mrs. Miss Last Name (print) Grid

First Name (print) Middle Initial Grid

Date of Birth table with columns: Year, Month, Day

Street Address, Apt. No., P.O. Box or *Rural Route (print) Grid

of City, Town or Village (print) Grid

Qualification Produced table with columns: Province, State or Country, Year, Serial No.

Postal Code	Office use only
<input type="text"/> <input type="text"/> <input type="text"/> <input type="text"/> <input type="text"/> <input type="text"/>	<input type="text"/> <input type="text"/>

Height

Weight

Colour of Hair

Colour of Eyes

*If Rural Route, please complete

Lot:	Concession:	Township of:
------	-------------	--------------

to hunt moose during the open season in 19.....

Issuer's Number

This licence is not valid for hunting bull or cow moose unless an appropriate moose validation tag, provided by the Ministry of Natural Resources, is attached.

(signature of issuer)

(date)

(signature of licensee)

Affix a moose validation tag in the place provided.

O. Reg. 138/83, s. 4, *part*; O. Reg. 184/84, s. 3, *part*; O. Reg. 699/84, s. 2, *part*; O. Reg. 519/86, s. 4 (3).

Form 4

Game and Fish Act

RESIDENT'S LICENCE TO HUNT BLACK BEAR IN 19.....

Social Insurance Number

Licence Serial Number

<input type="text"/> <input type="text"/> <input type="text"/>	<input type="text"/> <input type="text"/> <input type="text"/>	<input type="text"/> <input type="text"/> <input type="text"/>
--	--	--

Under the *Game and Fish Act* and the regulations, and subject to the limitations thereof, this licence is issued to

Mr./ Ms. Mrs. Miss	Last Name (print)
	<input type="text"/> <input type="text"/> <input type="text"/> <input type="text"/> <input type="text"/> <input type="text"/> <input type="text"/> <input type="text"/> <input type="text"/> <input type="text"/> <input type="text"/> <input type="text"/> <input type="text"/> <input type="text"/> <input type="text"/> <input type="text"/> <input type="text"/> <input type="text"/> <input type="text"/> <input type="text"/> <input type="text"/>

First Name (print)	Initial
<input type="text"/> <input type="text"/> <input type="text"/> <input type="text"/> <input type="text"/> <input type="text"/> <input type="text"/> <input type="text"/> <input type="text"/> <input type="text"/> <input type="text"/> <input type="text"/> <input type="text"/> <input type="text"/> <input type="text"/> <input type="text"/> <input type="text"/> <input type="text"/> <input type="text"/> <input type="text"/>	<input type="text"/>

Date of Birth		
Year	Month	Day
<input type="text"/> <input type="text"/>	<input type="text"/> <input type="text"/>	<input type="text"/> <input type="text"/>

Street Address, Apt. No., P.O. Box or Rural Route (print)

Grid for street address

Postal Code

Grid for postal code

of City, Town or Village (print)

Grid for city name

Table with columns: Lot, Concession, Township of

Qualification Produced table with fields: Province, State or Country, Year, Serial No.

Height
Weight
Colour of Hair
Colour of Eyes

to hunt black bear during the open season in 19.....

(signature of issuer) (date) (signature of licensee)

R.R.O. 1980, Reg. 420, Form 4; O. Reg. 519/86, s. 4 (4).

Form 5

Game and Fish Act

LICENCE TO HUNT SMALL GAME IN 19..... - 19.....

Licence Serial Number

Under the Game and Fish Act and the regulations, and subject to the limitations thereof, this licence is issued to

Mr./ Last Name (print)

Grid for last name

Licence issued to a:
(mark X) Resident
(where)
(applicable) Non-Resident

First Name (print)

Grid for first name

Middle Initial

Grid for middle initial

Date of Birth table with columns: Year, Month, Day

Street Address, Apt. No., P.O. Box or *Rural Route (print)

Grid for street address

Postal Code

Grid for postal code

Office use only

Grid for office use only

Qualification Produced table with fields: Province, State or Country, Year, Serial No.

of City, Town or Village (print)

Grid for city name

Height
Weight
Colour of Hair
Colour of Eyes

*If Rural Route, please complete

Table with columns: Lot, Concession, Township of

Issuer's Number									

.....
(signature of issuer)

.....
(date)

.....
(signature of licensee)

A) Who being a resident is entitled,

- (i) to hunt birds or animals other than bear, caribou, deer, elk, moose, badger, beaver, bobcat, fisher, lynx, marten, mink, muskrat, otter, red squirrel or wolverine; and
- (ii) to hunt raccoon at night during the open season when authorized by a resident's tag to hunt raccoon at night.

This licence is valid,

- (a) in the Northern Region, from the 1st day of September, 19.... to the 15th day of June, 19....;
- (b) in the Southern Region, from the 1st day of September, 19.... to the 31st day of August, 19....;
- (c) to hunt game birds on a game bird hunting preserve from the 1st day of September, 19.... to the 31st day of August, 19....

B) Who being a non-resident is entitled,

to hunt, during the opening season, only those birds or animals when and as authorized by a non-resident's small game tag or by a non-resident's tag to hunt game birds on a game bird hunting preserve during the validity of the tags indicated on this licence.

Affix Resident's tag to hunt raccoon at night here.	
Non-resident's small game tag is valid (a) for hunting fox, game birds, rabbits, raccoon and squirrel other than red squirrel from the 1st day of September, 19.... to the last day of February, 19... during the open season, (b) for hunting game birds on a game bird hunting preserve from the 1st day of September, 19... to the 31st day of August, 19 ... (c) for hunting wolf from the 1st day of September, 19... to the 15th day of June, 19...	Non-resident's tag to hunt game birds on a game bird hunting preserve is valid from the 1st day of September, 19...., to the 31st day of August, 19....
Affix Non-resident's small game tag here.	Affix Non-resident's tag to hunt game birds on a game bird hunting preserve here.

O. Reg. 624/85, s. 2; O. Reg. 519/86, s. 4 (5).

Form 6

Game and Fish Act

NON-RESIDENT'S SMALL GAME TAG 19..... - 19.....											
Serial Number											
Small Game Licence Serial Number	<table border="1" style="width: 100%;"> <tr> <td></td><td></td><td></td><td></td><td></td><td></td><td></td><td></td><td></td><td></td> </tr> </table>										

R.R.O. 1980, Reg. 420, Form 6; O. Reg. 185/84, s. 2, part; O. Reg. 519/86, s. 4 (6).

Form 7

Game and Fish Act

NON-RESIDENT'S LICENCE TO HUNT DEER IN 19.....

Licence Serial Number

Social Insurance or Social Security Number

<table border="1"> <tr> <td></td><td></td><td></td><td></td><td></td> </tr> </table>						<table border="1"> <tr> <td></td><td></td><td></td><td></td><td></td> </tr> </table>						<table border="1"> <tr> <td></td><td></td><td></td><td></td><td></td> </tr> </table>						

Under the *Game and Fish Act* and the regulations, and subject to the limitations thereof, this licence is issued to

Mr./ Last Name (print)

Ms.
Mrs.
Miss

--	--	--	--	--	--	--	--	--	--	--	--	--	--	--	--	--	--	--	--	--	--	--	--	--	--	--	--	--	--

First Name (print)

--	--	--	--	--	--	--	--	--	--	--	--	--	--	--	--	--	--	--	--	--	--	--	--	--	--	--	--	--	--	--

Initial

--

Date of Birth		
Year	Month	Day

Street Address, Apt. No., P.O. Box or Rural Route (print)

--	--	--	--	--	--	--	--	--	--	--	--	--	--	--	--	--	--	--	--	--	--	--	--	--	--	--	--	--	--	--	--

Postal Code

--	--	--	--	--	--	--	--

Qualification Produced	
Province, State or Country	Year
Serial No.	

of City, Town or Village (print)

--	--	--	--	--	--	--	--	--	--	--	--	--	--	--	--	--	--	--	--	--	--	--	--	--	--	--	--	--	--	--

Lot:	Concession:	Township of:
------	-------------	--------------

Height

Weight

Colour of Hair

Colour of Eyes

to hunt deer during the open season in 19.....

This licence is not valid for hunting deer that (a) do not have antlers; or (b) have antlers both of which are less than 7.5 centimetres in length.

..... (signature of issuer) (date) (signature of licensee)

Affix any deer-related validation tag in the place provided.		

Form 8
Game and Fish Act

NON-RESIDENT'S LICENCE TO HUNT MOOSE IN 19.....

Licence Serial Number

Under the *Game and Fish Act* and the regulations, and subject to the limitations thereof, this licence is issued to

Mr./ Last Name (print)

Ms.
Mrs.
Miss

--	--	--	--	--	--	--	--	--	--	--	--	--	--	--	--	--	--	--	--	--	--	--	--	--	--	--	--	--	--	--

First Name (print)

Grid for first name (15 boxes)

Middle Initial

Box for middle initial

Date of Birth

Table for date of birth with columns for Year, Month, Day

Street Address, Apt. No., P.O. Box or *Rural Route (print)

Grid for street address (25 boxes)

of City, Town or Village (print)

Grid for city name (25 boxes)

Postal Code or Zip Code

Grids for postal code (3 and 4 boxes)

Office use only

Grids for office use only (2 boxes)

*If Rural Route, please complete

Table with columns for Lot, Concession, and Township of

Qualification Produced

Table for qualification produced with columns for Province, State or Country, Year, and Serial No.

Height

Weight

Colour of Hair

Colour of Eyes

to hunt moose during the open season in 19.....

Grid for Issuer's Number (10 boxes)

This licence is not valid for hunting moose unless an appropriate validation tag, provided by the Ministry of Natural Resources, is attached.

(signature of issuer)

(date)

(signature of licensee)

Affix a moose validation tag in the place provided.

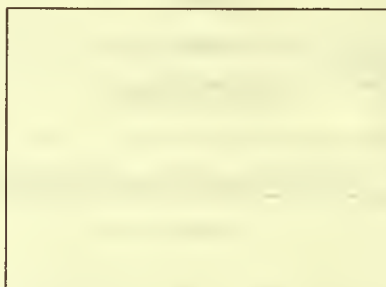

O. Reg. 138/83, s. 4, part; O. Reg. 519/86, s. 4 (8).

Form 9

Game and Fish Act

NON-RESIDENT'S LICENCE TO HUNT BLACK BEAR IN 19.....

Licence Serial Number

Social Insurance or Social Security Number

Grids for social insurance or social security number (3, 3, and 3 boxes)

Form 11

Game and Fish Act

19.....

ARCHERY TAG TO HUNT DEER

Serial Number

Deer Licence
Serial Number

--	--	--	--	--	--	--	--

R.R.O. 1980, Reg. 420, Form 11; O. Reg. 519/86, s. 4 (11).

Form 12

Game and Fish Act

RESIDENT'S WILD TURKEY

VALIDATION TAG 19.....

Tag Serial Number

This tag authorizes

.....

.....
(Last Name)

.....
(First Name) (Middle Initial)

to take a wild turkey with a beard

in WMU
(WMU Number)

.....
(during the open season specified above)

Remove the backing from this tag and stick the tag to the back of your licence to hunt small game. O. Reg. 688/86, s. 5.

Form 13

Game and Fish Act

19..... - 19.....

**RESIDENT'S RACCOON TAG
TO HUNT RACCOON AT NIGHT**

Serial Number

**RACCOON NIGHT
HUNTER'S NUMBER**

--	--

1 2

--	--	--	--	--	--

3 6

--	--	--	--

7 10

--	--

11 12

Small Game Licence
Serial Number

--	--	--	--	--	--	--	--

R.R.O. 1980, Reg. 420, Form 13; O. Reg. 185/84, s. 2, part; O. Reg. 699/84, s. 2, part; O. Reg. 519/86, s. 4 (12).

Form 14

Game and Fish Act

19.....-19.....

**NON-RESIDENT'S TAG TO HUNT GAME BIRDS
ON A GAME BIRD HUNTING PRESERVE**

Serial Number

Small Game Licence
Serial Number

--	--	--	--	--	--	--	--

R.R.O. 1980, Reg. 420, Form 14; O. Reg. 185/84, s. 2, *part*; O. Reg. 519/86, s. 4 (13).

Form 15

Game and Fish Act

RESIDENT'S DOG LICENCE (RACCOON) 19..... - 19.....

Social Insurance Number

Licence Serial Number

--	--	--	--	--	--	--	--	--	--	--	--

Small Game
Hunting Licence
Serial Number

--	--	--	--	--	--	--	--

Under the *Game and Fish Act* and the regulations, and subject to the limitations thereof, this licence authorizes the use of a dog described as follows:

.....
.....

and owned by

.....

to be used to hunt raccoon at night during the open season for raccoon.

This licence is valid only from the 1st day of September, 19....., to the last day of February, 19.....

.....
(signature of issuer)

.....
(signature of licensee)

.....
(date)

R.R.O. 1980, Reg. 420, Form 15; O. Reg. 185/84, s. 2, *part*; O. Reg. 699/84, s. 2, *part*; O. Reg. 519/86, s. 4 (14).

Form 16

Game and Fish Act

DOG LICENCE (CARIBOU, DEER OR MOOSE) 19.....

Social Insurance or Social Security Number

Licence Serial Number

--	--	--	--	--	--	--	--	--	--	--	--

Serial Number of a licence
to hunt deer or moose
held by the licensee

--	--	--	--	--	--	--	--

Under the *Game and Fish Act* and the regulations, and subject to the limitations thereof, this licence authorizes the use of a dog described as follows:

.....
.....

and owned by

.....
to be used to hunt caribou, deer or moose during the open season.

This licence expires with the 31st day of December, 19.....

..... (signature of issuer) (signature of licensee)

..... (date)

R.R.O. 1980, Reg. 420, Form I6; O. Reg. 184/84, s. 3, *part*; O. Reg. 699/84, s. 2, *part*; O. Reg. 519/86, s. 4 (15).

Form 17

Game and Fish Act

LICENCE TO SELL THE MEAT OF MUSKRAT,
BEAVER, RACCOON OR BEAR

Social Insurance or Social Security Number

Licence Serial Number

.....
.....
.....

Under the *Game and Fish Act* and the regulations, and subject to the limitations thereof, this licence is issued to

.....
of
(insert the complete address)

to sell the meat of muskrat, beaver, raccoon or bear.

This licence expires with the 31st day of December, 19...

..... (signature of issuer) (signature of licensee)

..... (date)

R.R.O. 1980, Reg. 420, Form 17.

Form 18

Game and Fish Act

APPLICATION FOR A HUNTING LICENCE EXAMINATION

Please Print:

Mr. Last Name: First Name (Given Name— do not use nickname) Middle Initial
Ms.
Mrs.
Miss

Street Address, P.O. Box or Rural Route Apt. # Postal or Zip Code

City, Town or Village Province, Country or State

Lot number	Concession number	Township of
<input type="text"/>	<input type="text"/>	<input type="text"/>

Telephone Number	Sex
Area Code	Male Female
<input type="text"/>	<input type="checkbox"/> <input type="checkbox"/>

Date of Birth	Height	Weight	Colour of Hair	Colour of Eyes
Year Month Day	<input type="text"/>	<input type="text"/>	<input type="text"/>	<input type="text"/>

I, who have resided in Ontario for a period of months during the 12 months immediately preceding the date of this application, hereby apply to take:

(Please check appropriate box)

- my first hunting licence examination; or
- a re-examination, previous examination record number

I produce with this application the following documentation (please check appropriate box):

<input type="checkbox"/> Hunting Training Course Certificate)	Date of Issue	Serial No.	Name of Jurisdiction of Issue
)	Year Month Day	<input type="text"/>	<input type="text"/>
)	<input type="text"/>	<input type="text"/>	<input type="text"/>

- Resident's Hunting Licence
- Not applicable

I hereby declare that the above information is complete and true.

Date in (signature of applicant)

O. Reg. 127/83, s. 3, part.

Form 19

Game and Fish Act

HUNTING LICENCE VERIFICATION CERTIFICATE

No.

NOT VALID AS A LICENCE TO HUNT

Under the Game and Fish Act and the regulations, and subject to the limitations thereof, this is to certify that the person named hereunder,

- was the owner of 19..... hunting licence number issued to a resident * or non-resident** or
- passed a hunting licence examination; certificate number issued on (year, month, day)

Please Print:

Mr. Ms. Mrs. Miss	Last Name:	First Name (Given Name—do not use nickname)	Middle Initial
	<input type="text"/>	<input type="text"/>	<input type="text"/>

Street Address, P.O. Box or Rural Route	Apt. #	Postal or Zip Code
<input type="text"/>	<input type="text"/>	<input type="text"/>

City, Town or Village

Grid for City, Town or Village

Province, Country or State

Grid for Province, Country or State

Date of Birth

Year Month Day

Grid for Date of Birth

Height

Box for Height

Weight

Box for Weight

Colour of Hair

Box for Colour of Hair

Colour of Eyes

Box for Colour of Eyes

Wildlife Surveys and Records

Date

Rec.

* Strike out where not applicable

O. Reg. 127/83, s. 3, part.

Form 20

Game and Fish Act

APPLICATION FOR SEARCH

Ministry of Natural Resources

Complete and send to:

Wildlife Surveys and Records, Ministry of Natural Resources, Legislative Buildings, Queen's Park, Toronto, Ontario, M7A 1W3.

Send a cheque or money order payable to The Treasurer of Ontario.

DATE 19.....

RETURN TO:

PRINT YOUR NAME

ADDRESS

Under the Game and Fish Act, and the regulations, and subject to the limitations thereof, the undersigned applies for a search of a licence issued under the aforementioned Act and regulations.

Check why search requested

To Obtain:

- checkbox a new identification badge; or
checkbox a replacement for a lost hunting licence that is valid in this hunting season
checkbox a certificate verifying ownership of a lost, expired hunting licence
checkbox a replacement for a lost hunting licence examination certificate

FILE SEARCH INFORMATION—TO BE COMPLETED BY APPLICANT—PLEASE PRINT

1. LICENCE TYPE (The kind of Licence, e.g. Resident's Licence to Hunt Small Game, Resident's Licence to Hunt Moose, etc.)

2. DATE OF PURCHASE (Month & Year) A search can only be made of licences purchased within the previous three years

4. LICENCE NUMBER

3. WHERE PURCHASED (Issuer's Name and Full Address) ONE ONLY

City, Town or Village

[Grid for City, Town or Village]

Province, Country or State

[Grid for Province, Country or State]

Lot number

[Grid for Lot number]

Concession number

[Grid for Concession number]

Township of

[Grid for Township of]

Date of Birth

Year Month Day

[Grid for Date of Birth]

Height

[Grid for Height]

Weight

[Grid for Weight]

Colour of Hair

[Grid for Colour of Hair]

Colour of Eyes

[Grid for Colour of Eyes]

I have resided in Ontario for a period of months during the 12 months immediately preceding the date of this application.

I produce with this application:

(Check and complete where applicable)

certificate issued by a hunting examiner in Ontario dated (year, month, day)

No. and filed with this application;

hunting licence verification certificate dated issued to (year, month, day)

me as a resident*/non-resident* by the Province of Ontario and filed with this application;

certificate dated issued to me by (year, month, day)

..... that indicates that I was or am (a competent authority in Province, Country, State) authorized to purchase a hunting licence in that jurisdiction;

hunting licence No. dated (year, month, day of issue)

issued to me by a competent authority in as a (Province, Country or State)

resident*/non-resident* of that jurisdiction; or

a consent signed by my parents or by the person who has custody of me (in the case of an applicant who is fifteen years of age) and filed with this application.

I hereby declare that the above information is complete and true.

Date in (signature of applicant)

*Strike out where not applicable

O. Reg. 127/83, s. 3, part.

Form 22

Game and Fish Act

APPLICATION FOR A FARMER'S LICENCE TO HUNT DEER

Mr. Ms. Mrs. Miss

Last Name:

[Grid for Last Name]

First Name (Given Name— do not use nickname)

[Grid for First Name]

Middle Initial

[Grid for Middle Initial]

Street Address, P.O. Box or Rural Route

[Grid for Street Address]

Apt. #

[Grid for Apt. #]

Postal or Zip Code

[Grid for Postal or Zip Code]

City, Town or Village

Province, Country or State

Grid for City, Town or Village

Grid for Province, Country or State

Lot number

Concession number

Township of

Grid for Lot number

Grid for Concession number

Grid for Township of

Telephone Number
Area Code

Grid for Area Code

Grid for Telephone Number

Grid for Telephone Number

Date of Birth
Year Month Day

Height

Weight

Colour of Hair

Colour of Eyes

Grid for Date of Birth

Grid for Height

Grid for Weight

Grid for Colour of Hair

Grid for Colour of Eyes

I have resided in Ontario for a period of months during the 12 months preceding the date of this application.

My chief occupation is farming and I,

- (a) live upon and till land which I own or am entitled to possession of for the time being in the County, District, or as the case may be, of ; or (County, District, etc.)
(b) am a genuine settler engaged in clearing land in (County or Territorial District) for the purpose of bringing it to a state of civilization.

I produce with this application:

(Check and complete where applicable)

[] certificate issued by a hunting licence examiner in Ontario dated (year, month, day)

No. and filed with this application;

[] hunting licence verification certificate dated issued to me (year, month, day)

as a resident/non-resident* by the Province of Ontario and filed with this application;

[] a hunting licence No. dated issued to me by the (year, month, day)

Province of Ontario as a resident thereof; or

[] a consent signed by my parents or by the person who has custody of me (in the case of an applicant who is fifteen years of age) and filed with this application.

I hereby declare that the above information is complete and true.

Date in (signature of applicant)

* Strike out where not applicable

O. Reg. 127/83, s. 3, part.

Form 23

19..... Antlerless Deer Tag
Tag Serial Number
This authorizes the holder of licence number
to hunt antlerless deer in WMU

O. Reg. 397/82, s. 2, part.

Form 24

19..... Antlerless Deer Tag
 Tag Serial Number
 This authorizes the holder of licence number
 to hunt antlerless deer in WMU

O. Reg. 397/82, s. 2, part.

Form 27

19..... Antlerless Deer Tag
 Tag Serial Number
 This authorizes
 (initials and last name)
 to hunt antlerless deer in W.M.U.

O. Reg. 397/82 s. 2, part.

Form 25

19..... Controlled Deer Hunt Validation Tag
 Tag Serial Number
 This authorizes
 (initials and last name)
 to hunt antlered and antlerless deer in W.M.U.
, 19..... to, 19.....

O. Reg. 410/87, s. 3.

Form 28

Game and Fish Act

Moose Validation Tag 19.....
 Tag Serial Number
 This tag authorizes
 (Last Name)

 (First Name) (Middle Initial)
 to take
 (a moose of a specific age and sex)
 in WMU
 (WMU Number or any)

 (during the open season for moose with bows

 and muzzle loaders, if appropriate)
 Remove the backing from this tag and stick the tag to the back of
 your moose licence.

O. Reg. 138/83, s. 5, part.

Form 26

19..... Controlled Deer Hunt Validation Tag
 Tag Serial Number
 This authorizes
 (initials and last name)
 to hunt only antlered deer in W.M.U.
, 19..... to, 19.....

O. Reg. 410/87, s. 4.

Form 29

Game and Fish Act

RESIDENT'S APPLICATION FOR A MOOSE VALIDATION TAG 19.....

No.

Please print. No Fee Required

I hereby apply to hunt a bull or a cow moose in the following Wildlife Management Units:

1st Choice	Mark One	2nd Choice	Mark One
WMU <input type="text"/> <input type="text"/> <input type="text"/>	Bull <input type="checkbox"/>	WMU <input type="text"/> <input type="text"/> <input type="text"/>	Bull <input type="checkbox"/>
Special Bow Season Preference <input type="checkbox"/>	Cow <input type="checkbox"/>	Special Bow Season Preference <input type="checkbox"/>	Cow <input type="checkbox"/>

	I applied for a MOOSE VALIDATION TAG in 19..... <input type="checkbox"/> Yes <input type="checkbox"/> No I received a MOOSE VALIDATION TAG in the 19..... draw. <input type="checkbox"/> Yes <input type="checkbox"/> No
--	---

Last Name

Grid for last name input

Date of Birth

Grid for date of birth (Year, Month, Day)

First Name

Grid for first name input

Middle Initial

Grid for middle initial input

Street Address, P.O. Box or Rural Route (Print)

Grid for street address input

of City, Town or Village

Grid for city input

Postal Code

Grid for postal code input

Declaration box: I hereby declare that the above information is correct and that I have submitted only one application. (signature of applicant) (date)

Please complete and return this application to Wildlife Surveys and Records by 5:00 p.m., 19....., if you wish to apply to hunt bull or cow moose. Applications that are incomplete or illegible will not be accepted.

O. Reg. 186/84, s. 5, part.

Form 30

Game and Fish Act

NON-RESIDENT'S APPLICATION FOR A MOOSE VALIDATION TAG 19.....

No.

No Fee Required. Please Print.

Last Name

Grid for last name input

Date of Birth

Grid for date of birth (Year, Month, Day)

First Name

Grid for first name input

Middle Initial

Grid for middle initial input

Office Use Only

Grid for office use only (19, Moose Licence No.)

Street Address, Apt. No., P.O. Box or Rural Route (Print)

Grid for street address input

of City, Town or Village

Grid for city input

Postal Code

Grid for postal code input

I hereby apply to hunt a bull or a calf moose, a cow or calf moose, and if not selected for either of the preceding, a calf moose only.

Application questions: I applied for a MOOSE VALIDATION TAG to take bull or cow moose in 19..... I received a MOOSE VALIDATION TAG to take bull or cow moose in the 19..... draw

(Complete either Part (A) or (B))

Part (A)

I will hunt with an immediate relative*, (name and address)

who is my , and who qualifies to hunt as
(relationship)

an Ontario resident as evidenced by:

Proof of Hunting Experience	
Ont. Lic. No.	Year

NOTE: Where Part (A) is completed, this application must be submitted with your immediate relative's application for a moose validation tag together with an affidavit sworn before a notary public, verifying your relationship to your immediate relative.

Choice of Wildlife Management Unit

1st Choice	Mark One	2nd Choice	Mark One
WMU <input type="checkbox"/> <input type="checkbox"/> <input type="checkbox"/>	Bull or Calf <input type="checkbox"/>	WMU <input type="checkbox"/> <input type="checkbox"/> <input type="checkbox"/>	Bull or Calf <input type="checkbox"/>
Special Bow Season Preference <input type="checkbox"/>	Cow or Calf <input type="checkbox"/>	Special Bow Season Preference <input type="checkbox"/>	Cow or Calf <input type="checkbox"/>

* Immediate relative is defined as a grandparent, father, mother, spouse, son, daughter, brother, sister or grandchild of an applicant; the immediate relative must be the holder of a moose licence at the time of the hunt.

Part (B)

I am the owner of real property located at

Lot Concession or Plan in the of County etc., of
and more particularly described in Instrument No. for the of
registered in the Land Registry Office for the († Registry) († Land Titles) Division of

Your affidavit, sworn before a notary public, verifying that you are the owner of real property as stated in Part B, shall be filed with this application.

† Strike out where not applicable.

Wildlife Management Unit in which the property is located

Animal Choice	(mark one box only)	Bull or Calf <input type="checkbox"/>	Cow or Calf <input type="checkbox"/>	Special Bow Season Preference <input type="checkbox"/>
---------------	---------------------	---------------------------------------	--------------------------------------	--

The submission of more than one application is prohibited and will result in the rejection of all applications.

I hereby declare that the above information is correct and that I have submitted only one application.	
..... (signature of applicant) (date)

Please complete and return this application, if you have completed, Part (A), to a District Manager of the Ministry of Natural Resources, or, if you have completed Part B, to the District Manager of the administrative district of the Ministry of Natural Resources in which the property is located, by 5 P.M., , 19....., if you wish to apply to hunt bull or cow moose. Applications to hunt calf moose only may be submitted after that date. Applications that are incomplete or illegible will not be accepted.

Form 31

Game and Fish Act

TOURIST OUTFITTER'S APPLICATION
FOR MOOSE VALIDATION TAG(S) 19.....

No.

Outfitter's Commercial Name (Print)	Outfitter's Number
-------------------------------------	--------------------

Owned or Operated by:

Last Name	First Name	Middle Initial

Street Address, Apt. No., P.O. Box or Rural Route (Print)

of City, Town or Village	Postal or Zip Code

On behalf of my registered moose hunting guests, I hereby apply for a Moose Validation Tag(s) for the 19..... hunting season for the following hunter(s):

Last Name	First Name	Middle Initial	Date of Birth						
			<table style="width:100%; border-collapse: collapse;"> <tr> <td style="width:33%; text-align: center;">Yr.</td> <td style="width:33%; text-align: center;">Mo.</td> <td style="width:33%; text-align: center;">Dy.</td> </tr> <tr> <td style="border: 1px solid black; height: 20px;"></td> <td style="border: 1px solid black; height: 20px;"></td> <td style="border: 1px solid black; height: 20px;"></td> </tr> </table>	Yr.	Mo.	Dy.			
Yr.	Mo.	Dy.							

Street Address, Apt. No., P.O. Box or Rural Route (Print)

of City, Town or Village	Postal Code

This person is a: Resident of Ontario who will be hunting in WMU

 Non-Res.

for a

Bull or Calf	
Cow or Calf	
Calf	

 moose. This tag is for the Special Bow Season (mark if applicable)

I hereby certify that the above information is correct.

.....
(signature of outfitter)

.....
(date)

O. Reg. 138/83, s. 5, part.

Form 32

Game and Fish Act

**NON-RESIDENT'S APPLICATION FOR A BLACK BEAR
HUNTING LICENCE VALIDATION CERTIFICATE**

Please Print. No fee required.

Date of Birth			
(Last Name)	(First Name)	(Middle Initial)	(Year/Month/Day)

.....
(Street Address, Apt. No., P.O. Box or Rural Route)

.....
(City, Town, Village)

.....
(Province, State, Country)

.....
(Postal/Zip Code)

I hereby make application for a Black Bear Hunting Licence Validation Certificate.

(Complete either Part A or B)

PART A

I will hunt with an immediate relative*,
(Name and Address)

.....
who is my, and is the holder of a resident's licence.
(Relationship)

(Where Part A is completed this application must be accompanied by an affidavit sworn before a commissioner or a notary public verifying your relationship to your immediate relative.)

*Immediate relative is defined as an applicant's grandparent, father, mother, spouse, son, daughter, brother, sister or grandchild.

PART B

I am the owner of real property located at

.....
Lot, Concession or Plan, in the

of registered in the Land Registry Office for the († Registry) († Land Titles) Division of

Your affidavit, sworn before a commissioner or a notary public, verifying that you are the owner of real property as stated in Part B, shall be filed with this application.

† Strike out where not applicable.

Wildlife Management Unit in which the property is located

.....
Please complete this application. If you have completed Part A, return it to the District Manager of the Administrative District of the Ministry of Natural Resources where you intend to hunt. If you have completed Part B, return it to the District Manager of the Administrative District of the Ministry of Natural Resources in which the property is located. Applications that are incomplete or illegible will not be accepted.

.....
(Signature of Applicant)

.....
(Date)

O. Reg. 132/87, s. 3, part.

Form 33

Game and Fish Act

BLACK BEAR HUNTING LICENCE VALIDATION CERTIFICATE

Please Print. No fee required.

*Strike out where not applicable

No.

District Code

Tourist Outfitter No.

I,
(Last Name) (First Name) (Middle Initial)

of (Street Address, Apt. No., P.O. Box or Rural Route)

(City, Town, Village) (Postal/Zip Code)

being the operator* of (Name of Tourist Establishment, Hunting Services or Air Carrier)

..... or an authorized employee* of the Ministry of Natural Resources (Administrative District)

..... certify that

(Last Name) (First Name) (Middle Initial)

of (City, Town, Village) (Province, State or Country) (Postal/Zip Code)

(a) has contracted with me for guiding or baiting services for the period from to, 19.....,

in Black Bear Management Area No.,

or

on private land in Wildlife Management Unit No., for which my clients have permission to hunt black bears;

(Where the certificate is issued under clause (a), it is valid for the period noted above.)

or

(b) alleges that he/she is,

(i) hunting* with (Name of immediate relative)

(relationship) (Hunter's Licence Number)

or

(ii) the owner of real property* in Wildlife Management Unit No.

(Where the certificate is issued under clause (b), it is valid during the open season for black bear.)

(Date) (Signature of Issuer)

The following information must be provided by the hunter to the issuer of this certificate at the end of the hunt:

- 1. The serial number of my Licence to Hunt Black Bear is B.
2. I hunted black bear during the valid period of this Certificate. Yes [] No []
3. I hunted mostly in Wildlife Management Unit (WMU)# for days
4. The total number of live bears I saw while hunting in this WMU was
5. I attached my game seal to:
Female Cub Yes [] No [] Female adult Yes [] No []
Male Cub Yes [] No [] Male adult Yes [] No []
Nothing Yes [] No []

6. This bear was shot on in WMU #
(Date)

O. Reg. 58/88, s. 2; O. Reg. 261/89, s. 2.

REGULATION 501

**HUNTING ON CROWN LANDS IN THE
GEOGRAPHIC TOWNSHIPS OF BRUTON AND
CLYDE**

1. During the open season for deer or moose, no person shall hunt or trap on the Crown lands described in the Schedule except that,

- (a) the holder of a licence in Form 1, 2, 3, 4, 5, 7, 8 or 9 of Regulation 500 of Revised Regulations of Ontario, 1990, who is a member of the camp for which a regulated hunting camp licence is issued, may hunt any game animal or game bird in accordance with the licence during its open season; and
- (b) the holder of a licence in Form 1 of Regulation 492 of Revised Regulations of Ontario, 1990 may hunt or trap furbearing animals in accordance with the licence and hunt game during its open season as permitted by subsection 62 (6) of the Act. O. Reg. 247/83, s. 1.

2. A regulated hunting camp licence shall be in Form 1. R.R.O. 1980, Reg. 421, s. 2.

3. An application for a licence in Form 1 shall be in Form 2. R.R.O. 1980, Reg. 421, s. 3.

4. The fee for a licence in Form 1 is \$21. R.R.O. 1980, Reg. 421, s. 4; O. Reg. 600/90, s. 1.

5. A licence in Form 1 is valid from the fourth day immediately preceding the first day of the open season for deer or for moose in wildlife management unit 54 as numbered and described in Regulation 530 of Revised Regulations of Ontario, 1990, whichever is the earlier, and expires with the fourth day after the close of the open season for deer or moose in wildlife management unit 54, whichever is the later. O. Reg. 247/83, s. 2.

6. It is a condition of a licence in Form 1,

- (a) that no structure, building or accommodation other than a tent or a vehicle used for living accommodation, shall be placed on the area described in the Schedule;
- (b) that no tent or vehicle used for living accommodation shall be placed on any site other than that mentioned in the licence;
- (c) that all tents, including floors and sidewalls, and vehicles used for living accommodation shall be removed from the Crown lands in the geographic townships of Bruton and Clyde in the Provisional County of Haliburton on or before the expiry of the licence;
- (d) that a member of the camp shall hunt only from the site mentioned in the licence; and
- (e) that not more than twelve members of the camp shall hunt at the same time. R.R.O. 1980, Reg. 421, s. 6; O. Reg. 247/83, s. 3.

7.—(1) The holder of a licence in Form 1 of this Regulation shall complete the questionnaire provided by the Ministry of Natural Resources and return the questionnaire to the office of the Ministry specified thereon within ten days after the close of the season for deer or moose in wildlife management unit 54, whichever is the later, in the year in which the licence is issued.

(2) Any person who refuses or neglects to complete the questionnaire and return it to the Ministry as required by subsection (1) is ineligible to receive a licence in Form 1 of this Regulation in the year next following. O. Reg. 247/83, s. 4.

Schedule

The Crown lands in the geographic townships of Bruton and Clyde in the County of Haliburton except:

1. Those lands that lie within 1609 metres of the shoreline of King-scote Lake in the said geographic Township of Bruton.

2. A strip of land 3218 metres in perpendicular width lying 1609 metres on either side of the Hydro line extending from Lot 1, Concession V, on the westerly boundary of the geographic Township of Clyde to Lot 32, Concession XV, on the easterly boundary of that geographic township. O. Reg. 247/83, s. 5.

Form 1

Game and Fish Act

19.....

No.

REGULATED HUNTING CAMP LICENCE

Under the *Game and Fish Act* and the regulations and subject to their limitations, this licence is issued to
(name of licensee)
and the other members of the licensee's camp to place a tent or vehicle used for living accommodation on the site designated as
No. on Lot in
Concession in the Geographic Township
of and to hunt from it on the Crown
lands in the geographic townships of Bruton and Clyde in the County
of Haliburton.

The names, addresses, classes of hunting licences and licence numbers of the members of the camp are:

Name	Address	Classes of Licences	Licence No.

This licence is valid from the day of, 19..... to the day of, 19..... Date

Signature of Issuer O. Reg. 247/83, s. 6; O. Reg. 600/90, s. 2.

Form 2

Game and Fish Act

19.....

APPLICATION FOR A REGULATED HUNTING CAMP LICENCE

Grid for family or surname (print in block letters)

Grid for given names

Residence Address (city, town, village or township) (street and number or lot and concession) (County or District)

The names, addresses, classes of hunting licences and licence numbers of the members of the camp are:

Table with 4 columns: Name, Address, Classes of Licences, Licence No.

(date) (signature of applicant)

R.R.O. 1980, Reg. 421, Form 2.

REGULATION 502

HUNTING ON DESIGNATED CROWN LAND AND IN PROVINCIAL PARKS

DEFINITION

1. In this Regulation, "Seasonal Waterfowl Area" is an area referred to in subsection 10 (1). R.R.O. 1980, Reg. 422, s. 1.

GENERAL

2. Except as provided in this Regulation, no person shall hunt any animal or bird in any area described in Schedules 2 to 66. O. Reg. 516/85, s. 1; O. Reg. 565/86, s. 1; O. Reg. 258/89, s. 1; O. Reg. 292/89, s. 1.

3. The provisions of the Migratory Birds Regulations made under the Migratory Birds Convention Act (Canada) apply to the hunting of ducks, geese, rails, coots and gallinules, except in so far as such regulations are modified by this Regulation. R.R.O. 1980, Reg. 422, s. 3.

4. The holder of a licence in Form 5 of Regulation 500 of Revised Regulations of Ontario, 1990, while proceeding to or from a blind in the area described in paragraphs 1 and 2 of Schedule 4, may possess a firearm in Long Point Provincial Park, provided that he or she keeps the firearm unloaded and encased. R.R.O. 1980, Reg. 422, s. 4.

5.—(1) The holder of a licence in Form 5 of Regulation 500 of Revised Regulations of Ontario, 1990 (Hunting Licences) may possess an unloaded and encased firearm in Presqu'ile Provincial Park between the day after the first Monday in September and the 23rd day of December while,

- (a) occupying a campsite as defined in Regulation 952 of Revised Regulations of Ontario, 1990 (General); (b) travelling on an access road to or from any such campsite; or (c) travelling to or from a blind in the area described in Schedule 2.

(2) The holder of a licence in Form 5 of Regulation 500 of Revised Regulations of Ontario, 1990 (Hunting Licences) may possess in Presqu'ile Provincial Park game birds, rabbits and squirrels that were lawfully taken. O. Reg. 433/89, s. 1.

6. The holder of a licence in Form 1, 2, 3, 4, 5, 7, 8 or 9 of Regulation 500 of Revised Regulations of Ontario, 1990 may possess,

- (a) a firearm that is unloaded and encased; and (b) any animal or bird that was lawfully taken,

in MacGregor Point Provincial Park or Selkirk Provincial Park. O. Reg. 624/84, s. 1; O. Reg. 636/87, s. 1.

7.—(1) The holder of a licence in Form 1, 2, 3, 4, 5, 7, 8 or 9 of Regulation 500 of Revised Regulations of Ontario, 1990 may possess a firearm when occupying a campsite, as defined in Regulation 952 of Revised Regulations of Ontario, 1990, in any of the following provincial parks and while travelling in his or her vehicle on an access road leading to or from any such campsite:

- 1. Esker Lakes. 2. Five Mile Lake. 3. Fushimi Lake. 4. Greenwater. 5. Ivanhoe Lake. 6. Kap-Kig-Iwan. 7. Kettle Lake. 8. Klotz Lake. 9. MacLeod.

10. Middle Falls Provincial Camp and Picnic Grounds.
11. Nagagamisis.
12. Quetico.
13. Rene Brunelle.
14. The Shoals.
15. Tidewater.
16. Wakami Lake.
17. Lady Evelyn—Smoothwater.
18. Restoule.
19. Mississagi.

provided that he or she keeps the firearm unloaded and encased. O. Reg. 127/82, s. 2, *part*; O. Reg. 411/84, s. 1; O. Reg. 258/89, s. 2; O. Reg. 292/89, s. 2.

(2) The holder of a licence in Form 5 of Regulation 500 of Revised Regulations of Ontario, 1990 may possess in the areas referred to in subsection (1) game birds, rabbits and squirrels that were legally taken. O. Reg. 127/82, s. 2, *part*.

(3) In Polar Bear Provincial Park, a person who has a permit issued by the district manager of the Ministry's administrative district at Moosonee may possess the gun specified in the permit, if the person transports the gun in the manner specified in the permit. O. Reg. 323/84, s. 1.

DUCKS, GEESE, RAILS, COOTS AND GALLINULES

8.—(1) The holder of a licence in Form 5 of Regulation 500 of Revised Regulations of Ontario, 1990, upon depositing his or her licence with the officer in charge, may be issued a licence in Form 1 to hunt ducks, geese, rails, coots and gallinules on a Monday, Wednesday, Friday or Saturday during the open season therefor in any year in the areas described in,

- (a) Schedule 2;
- (b) paragraph 1 of Schedule 3; and
- (c) paragraph 1 of Schedule 4. R.R.O. 1980, Reg. 422, s. 6 (1); O. Reg. 10/86, s. 1; O. Reg. 565/86, s. 2.

(2) A licence in Form 1 expires with the day on which it is issued.

(3) The holder of a licence in Form 1 shall not hunt except from a blind that he or she has rented from the officer in charge. R.R.O. 1980, Reg. 422, s. 6 (2, 3).

9. The holder of a licence in Form 5 of Regulation 500 of Revised Regulations of Ontario, 1990 may hunt ducks, geese, rails, coots and gallinules during the open season in any year in the areas described in Schedules 19 and 31. O. Reg. 516/85, s. 2; O. Reg. 258/89, s. 3.

10.—(1) The holder of a licence in Form 5 of Regulation 500 of Revised Regulations of Ontario, 1990 may be issued a licence in Form 2 to hunt ducks, geese, rails, coots and gallinules on a Monday, Wednesday, Friday and Saturday during the open season therefor in any year in the areas described in,

- (a) paragraph 2 of Schedule 3; and
- (b) paragraph 2 of Schedule 4.

(2) A licence in Form 2 expires with the last day of the open season for ducks, geese, rails, coots and gallinules. R.R.O. 1980, Reg. 422, s. 7.

11.—(1) Subject to subsections (2) and (3), no person shall erect a blind in the area described in paragraph 2 of Schedule 3.

(2) The holder of a licence in Form 2 may be issued a licence in Form 5 to erect a blind in the area described in paragraph 2 of Schedule 3 for the purpose of hunting in the area.

(3) The holder of a licence in Form 5 may erect a blind in the area described in paragraph 2 of Schedule 3 for the purpose of hunting in the area.

(4) Where the holder of a licence in Form 5 erects a blind in the area described in paragraph 2 of Schedule 3, he or she shall,

- (a) affix and keep affixed in a conspicuous place on the exterior of the blind erected by him or her the numbered badge supplied to him or her by the officer in charge; and
- (b) on or before the 15th day of March in the year next following the year in which he or she erected the blind, dismantle and remove the blind from the area described in paragraph 2 of Schedule 3. R.R.O. 1980, Reg. 422, s. 8.

12. The holder of a licence in Form 2 may erect a blind for the purpose of hunting in the area described in paragraph 2 of Schedule 4, upon condition that he or she,

- (a) removes the blind therefrom; and
- (b) removes any decoys that he or she places in the area,

before leaving the area on the day on which he or she erected the blind or placed such decoys in the area. R.R.O. 1980, Reg. 422, s. 9.

13. The holder of a licence in Form 5 of Regulation 500 of Revised Regulations of Ontario, 1990 may hunt ducks and geese on any day except Sunday, from the Tuesday following the second Monday in October, during the open season therefor in any year in the area described in Schedule 6, upon condition that,

- (a) he or she hunts only from a blind supplied by the Ministry for the purpose;
- (b) the blind from which he or she hunts is occupied by not more than one other person; and
- (c) he or she keeps his or her firearm unloaded and encased while proceeding to or from a blind. R.R.O. 1980, Reg. 422, s. 10.

14.—(1) No person shall erect a blind for rent in any of the areas described in Schedules 2, 3, 5 and 6 and paragraph 1 of Schedule 4.

(2) No person shall erect a blind for rent in the area described in paragraph 2 of Schedule 4 until after the person has rented the blind for the day to a holder of a licence in Form 2. R.R.O. 1980, Reg. 422, s. 12.

15. Before leaving any of the areas described in Schedules 2 and 4 and paragraph 1 of Schedule 3, the holder of a licence in Form 1 or 2 shall report to the officer in charge and shall produce for inspection any duck, goose, rail, coot or gallinule killed by him. R.R.O. 1980, Reg. 422, s. 13; O. Reg. 10/86, s. 2; O. Reg. 565/86, s. 4.

16. The holder of a licence in Form 5 of Regulation 500 of Revised Regulations of Ontario, 1990 may hunt ducks, geese, rails, coots and gallinules on a Monday, Wednesday or Friday or until 12 o'clock noon on a Saturday during the open season therefor in any year in the area described in Schedule 5 if,

- (a) the holder's motor vehicle is parked in an area designated as a parking area;
- (b) the holder hunts only within a radius of twelve metres from

a blind provided by the Ministry and marked by an officer of the Ministry with the number of the area in which the holder's motor vehicle is parked;

- (c) the area from which the holder hunts is occupied by not more than one other person; and
- (d) the holder keeps his or her firearms unloaded and encased except while occupying the hunting area. O. Reg. 10/86, s. 3.

17. The holder of a licence in Form 5 of Regulation 500 of Revised Regulations of Ontario, 1990, if he or she is a registered guest at Shagamu River Camp or Sutton River Camp, may hunt ducks, geese, rails, coots, snipe and gallinules during the open season therefor in any area described in Schedule 10 and may possess and use a firearm for the purpose in the areas described. R.R.O. 1980, Reg. 422, s. 14.

18. The holder of a licence in Form 5 of Regulation 500 of Revised Regulations of Ontario, 1990 may hunt ducks, geese, rails, coots and gallinules on any day except Sunday from the third Saturday in October to the end of the open season therefor in any year in the area described in Schedule 16 if,

- (a) the holder's motor vehicle is parked in an area designated as a parking area;
- (b) the holder hunts only within a radius of seventy-five metres from a stake planted by an officer of the Ministry and marked with the number of the area in which the holder's motor vehicle is parked;
- (c) the area from which the holder hunts is occupied by no more than two other persons;
- (d) the holder keeps his or her firearm unloaded and encased except while occupying the hunting area; and
- (e) the holder removes the blind before leaving the area after the hunt. O. Reg. 681/83, s. 2.

PHEASANTS

19. The holder of a licence in Form 5 of Regulation 500 of Revised Regulations of Ontario, 1990 may hunt pheasants on any day, except Sunday, from the Wednesday following the second Monday in October to the 30th day of November, both inclusive, during the open season therefor in any year, between the hours of 9 o'clock in the forenoon and 12 o'clock noon, and 1 o'clock in the afternoon and 5 o'clock in the afternoon in the area described in Schedule 7, upon condition that,

- (a) the licensee deposits the licence with the officer in charge;
- (b) there are not more than thirty-nine other persons hunting in the area described in Schedule 7 at the time the licensee presents his or her licence to the officer in charge;
- (c) the licensee reports to the officer in charge between 12 o'clock noon and 12.30 o'clock in the afternoon;
- (d) the licensee does not shoot or attempt to shoot any pheasant that is on the ground;
- (e) the licensee does not shoot or attempt to shoot more than two pheasants in one day in the area described in Schedule 7;
- (f) the licensee uses a shotgun loaded with shot not heavier than No. 5;
- (g) before leaving the area described in Schedule 7, the licensee reports to the officer in charge and produces for inspection any pheasant the licensee has killed; and

- (h) the licensee parks in a designated parking area. O. Reg. 398/86, s. 1, *part*.

20. The holder of a licence in Form 5 of Regulation 500 of Revised Regulations of Ontario, 1990 may hunt pheasants on any day, other than Sunday, Monday or Tuesday, during the open season therefor in any year, between the hours of 9 o'clock in the forenoon and 12 o'clock noon, and 1 o'clock in the afternoon and 4.30 o'clock in the afternoon in the area described in Schedule 8, if,

- (a) the licensee deposits his or her licence with the officer in charge;
- (b) there are not more than forty-four other persons hunting in the area described in Schedule 8 at the time the licensee presents his or her licence to the officer in charge;
- (c) the licensee reports to the officer in charge between 12 o'clock noon and 12.30 o'clock in the afternoon;
- (d) the licensee does not shoot or attempt to shoot any pheasant that is on the ground;
- (e) the licensee does not shoot or attempt to shoot more than two pheasants in one day in the area described in Schedule 8;
- (f) the licensee uses a shotgun loaded with shot not heavier than No. 2; and
- (g) before leaving the area described in Schedule 8, the licensee reports to the officer in charge and produces for inspection any pheasant killed by the licensee. O. Reg. 398/86, s. 1, *part*.

21. A licence in Form 3 expires with the day on which it is issued. R.R.O. 1980, Reg. 422, s. 17.

GAME ANIMALS AND GAME BIRDS

22. The holder of a licence in Form 1, 2, 5 or 7 of Regulation 500 of Revised Regulations of Ontario, 1990 may hunt game animals and game birds on any day, except Sunday, from the 16th day of September to the second Saturday in November, both inclusive, during the open season therefor in any year, between the hours of 9 o'clock in the forenoon and 5 o'clock in the afternoon in the area described in Schedule 9, upon condition that,

- (a) the licensee deposits his or her licence with the officer in charge and obtains a licence in Form 4;
- (b) there are not more than one hundred other persons hunting in the area described in Schedule 9 at the time the licensee presents his or her licence to the officer in charge;
- (c) the licensee does not shoot or attempt to shoot any pheasant that is on the ground;
- (d) the licensee does not erect any blind or other means of concealment in the area described in Schedule 9; and
- (e) before leaving the area described in Schedule 9, the licensee reports to the officer in charge and produces for inspection any game animal or bird killed by the licensee. R.R.O. 1980, Reg. 422, s. 18.

23. A licence in Form 4 expires with the day on which it is issued. R.R.O. 1980, Reg. 422, s. 19.

24. The holder of a licence in Form 1, 2, 3, 4, 5, 7, 8 or 9 of Regulation 500 of Revised Regulations of Ontario, 1990 may hunt any game animal or game bird that his or her licence authorizes him or her to hunt,

- (a) from the first day of the open season therefor or from the

15th day of September, in any year, whichever occurs later, to and including the last day of the open season therefor, or the 15th day of May next following, whichever occurs first, in an area described in Schedules 11, 14 and 15; and

- (b) from the first day of the open season therefor or from the 15th day of September, in any year, whichever occurs later, to and including the last day of the open season therefor, in an area described in Schedules 12, 13, 17, 20, 21, 22, 23, 24, 25, 26, 27, 28, 29, 30, 32, 33, 34, 35, 36, 37, 38 and 39 to 66,

and he or she may possess and use a firearm for the purpose in the above-mentioned areas. O. Reg. 127/82, s. 3; O. Reg. 347/83, s. 1; O. Reg. 411/84, s. 2; O. Reg. 44/85, s. 3; O. Reg. 83/85, s. 2; O. Reg. 280/85, s. 2; O. Reg. 516/85, s. 3; O. Reg. 213/89, s. 1; O. Reg. 258/89, s. 4; O. Reg. 292/89, s. 3.

25. The holder of a licence in Form 5 of Regulation 500 of Revised Regulations of Ontario, 1990 may hunt any animal or bird that his or her licence authorizes him or her to hunt, from the first day of the open season therefor or from the 15th day of October, whichever occurs later, in any year, to and including the last day of the open season therefor, or the last day of February next following, whichever occurs first, in the area described in Schedule 18, and he or she may possess and use a firearm for the purpose in that area. O. Reg. 624/84, s. 2.

SHARP-TAILED GROUSE AND PTARMIGAN

26. The holder of a licence in Form 5 of Regulation 500 of Revised Regulations of Ontario, 1990, if he or she is registered as a guest at Shagamu River Camp or Sutton River Camp, may hunt sharp-tailed grouse and ptarmigan during the open season therefor in any area described in Schedule 10 and may possess and use a firearm for the purpose in the areas described. R.R.O. 1980, Reg. 422, s. 20.

LICENCE FEES

27. The fee for a licence in a Form in Column 1 of Schedule 1 is the fee set opposite thereto in Column 2. R.R.O. 1980, Reg. 422, s. 21.

28.—(1) Schedules 40, 42 and 44 to 66 are revoked.

(2) Subsection (1) comes into force on the 15th day of May, 1992. O. Reg. 258/89, s. 6, *part*; O. Reg. 292/85, s. 5, *part*.

Schedule 1

COLUMN 1	COLUMN 2
Form No.	Fee
1	\$11.50
2	11.50
3	15.75
4	15.75

O. Reg. 605/90, s. 1.

Schedule 2

1. Block "B", Registered Plan Number 145 on Presqu'île Peninsula lying south of the Village of Brighton, in the County of Northumberland described as follows:

Beginning at a point in the northwesterly limit of that Block "B" distant 6,418.22 feet measured south 34° 03' 10" east from a point distant 486.0 feet measured south 25° 28' west from the most southerly corner of Lot 5, Broken Front Concession, Township of Brighton, now in the Village of Brighton, as shown on Registered Plan Number 140 entered in the Land Registry Office for the Registry Division of Northumberland East at Colborne; thence south 34° 03' 10" east 300.0 feet; thence south 24° 27' 10" east 1,222.03 feet; thence south 40° 48' 30" east 206.73 feet; thence south 46° 55' 30" west 4,972.0

feet; thence south 11° 10' 45" east 1,344.7 feet; thence south 25° 30' 30" west 1,650.0 feet; thence south 87° 56' 20" west 1,945.9 feet; thence north 0° 49' 30" east 900.0 feet; thence north 21° 41' east 1,065.2 feet; thence north 62° 47' 30" east 1,700.0 feet; thence north 14° 26' 10" west 1,695.6 feet; thence north 46° 55' 30" east 5,100.0 feet to the place of beginning.

2. Registered Plan Number 135 and part of blocks "A", "C", "G" and "I", Registered Plan Number 145 on Presqu'île Peninsula lying south of the Village of Brighton, in the County of Northumberland, described as follows:

Beginning at a point in the southwesterly limit of Block "A" distant 6,718.22 feet measured south 34° 03' 10" east from a point distant 486.0 feet measured south 25° 28' west from the most southerly corner of Lot 5, Broken Front Concession, Township of Brighton, now in the Village of Brighton, as shown on Registered Plan Number 140 entered in the Land Registry Office for the Registry Division of Northumberland East at Colborne; thence north 57° 04' east 5,900.0 feet; thence south 6° 09' 10" west 1,469.73 feet; thence south 65° 04' 40" west 1,297.73 feet; thence south 40° 53' east 230.0 feet to the northwesterly limit of Bay Shore Road; thence northeasterly along that northwesterly limit of Bay Shore Road to a point distant 1,107.92 feet measured south 67° 26' 40" west from the intersection of the westerly limit of Grave Street with the westerly production of the southerly limit of Water Street as shown on Registered Plan Number 135; thence north 68° 29' east 92.03 feet; thence north 23° 26' west 342.69 feet; thence north 51° 59' 10" east 1,564.88 feet; thence south 79° 56' 20" east 400.0 feet; thence south 10° 03' 30" west 500.0 feet; thence south 55° 03' 30" west 565.67 feet; thence south 79° 56' 30" east 1,860.17 feet; thence south 10° 42' 30" west 209.26 feet; thence south 79° 56' 30" east 300.0 feet; thence south 79° 56' 30" east 417.42 feet; thence south 80° 37' east 1,269.61 feet; thence south 8° 32' west 94.16 feet; thence south 45° 59' east 1,438.83 feet; thence north 74° 28' 30" east 69.79 feet; thence south 45° 59' east 167.03 feet; thence north 43° 53' east 460.0 feet; thence south 47° 13' east 600.0 feet; thence south 43° 53' west 300.0 feet; thence south 72° 12' 50" west 2,912.63 feet; thence south 62° 25' west 3,035.85 feet; thence south 68° 06' 10" west 2,729.83 feet; thence north 88° 11' 10" west 1,364.2 feet; thence north 73° 27' 40" west 1,745.35 feet; thence south 86° 58' west 2,977.03 feet; thence north 40° 48' 30" west 206.73 feet; thence north 24° 27' 10" west 1,222.03 feet, more or less to the place of beginning.

3. Part of Block A, Plan 145, on Presqu'île Peninsula, lying south of the Village of Brighton, in the County of Northumberland, described as follows:

Beginning at the most southerly angle of Lot No. 5, in the Broken Front Concession, of the Township of Brighton, now in the Village of Brighton as shown on Plan No. 28 entered in the Land Registry Office for the Registry Division of Northumberland East at Colborne, Ontario; thence north 25° 28' east 252.73 feet along the southeasterly limit of the said Lot No. 5; thence north 09° 53' east 136.45 feet along the southeasterly limit of the said Lot No. 5; thence north 15° 23' west 232.39 feet along the said southeasterly limit of the said Lot No. 5; thence north 52° 07' west 407.73 feet along the easterly limit of the said Lot No. 5 and along the southwest limit of Lake Street as shown on Plan No. 28 entered in the Land Registry Office for the Registry Division of Northumberland East at Colborne, Ontario; thence north 33° 09' west along the said southwest limit of Lake Street 60.08 feet to a point where the said limit of Lake Street is intersected by the westerly production of the northerly limit of Development Road; thence north 68° 01' east along the said westerly production and the northerly limit of Development Road 851.34 feet; thence on a curve to the left along the northerly limit of said Development Road having a radius of 2,821.79 feet, an arc distance of 881.16 feet, the chord equivalent being 877.5 feet measured north 59° 04' 15" east; thence north 50° 07' 30" east along the said northerly limit of Development Road 909.0 feet, more or less, to a point in the south limit of Lot No. 3 in the Broken Front Concession of the Township of Brighton, now in the Village of Brighton, as shown on said Plan No. 140; thence in a general southeasterly direction following the said south limit of Lot No. 3 to the southeasterly angle of said Lot No. 3; thence south 47° 12' 10" east 864.48 feet; thence south 27°

east 1,500.0 feet; thence south 72° east 2,600.0 feet; thence south 62° east 2,700.0 feet; thence south 06° 09' 10" west 800.0 feet, more or less, to the intersection with a line drawn north 57° 04' east from a point distant 6,718.22 feet measured south 34° 03' 10" east from a point distant 486.0 feet measured south 25° 28' west from the point of commencement; thence south 57° 04' west 5,200.0 feet, more or less, to a survey post planted; thence continuing south 57° 04' west 700.0 feet; thence north 34° 03' 10" west 6,718.22 feet; thence north 25° 28' east 486.0 feet to the place of beginning. R.R.O. 1980, Reg. 422, Sched. 3.

Schedule 3

1. In the Township of Harwich in the County of Kent and described as follows:

Beginning at the intersection of the water's edge of Lake Erie with the north-south dredge cut; thence north 22° 30' east along the said dredge cut 3,280 feet, more or less, to the intersection with the most southerly dredge cut; thence north 77° 30' west along the said dredge cut and its northwesterly production a distance of 1 mile and 3,900 feet; thence north 38° 30' east 5 miles and 1,196 feet, more or less, to the intersection with the westerly production of the north park boundary lying in an easterly and westerly direction at a bearing of north 76° 50' east; thence easterly along that production and the park boundary 3,630 feet, more or less, to the intersection with the easterly limit of Lake Shore Road; thence southerly and westerly along the easterly limit of Lake Shore Road to the intersection with the easterly limit of Rondeau Park Road; thence southerly along the east limit of Rondeau Park Road and its production to the intersection with the water's edge of Lake Erie; thence in a general westerly direction following the said water's edge of Lake Erie to the place of beginning.

2. Beginning at the northwesterly corner of Lot 2 according to a plan of survey of the tract of land known as the Rondeau Peninsula or Point aux Pins dated September 8th, 1864, prepared by Henry Lowe, Provincial Land Surveyor, of record in the Ministry of Natural Resources, Ontario; thence westerly along the production westerly of the northerly limit of that lot to the water's edge of Rondeau Harbour; thence in a general northerly, westerly, southwesterly, southerly and easterly direction following the water's edge on the easterly, northerly, westerly and southerly shores of that harbour to the intersection with the production northerly of the westerly limit of Lot 104 according to a plan registered in the Registry Office for the Registry Division of Kent as No. 314; thence northerly along that production to a point distant 290 feet measured northerly thereon from the southwest corner of that lot; thence easterly parallel to the northerly limit of Bayview Alley according to that plan, 150 feet, more or less, to the intersection with the production northerly of the easterly limit of Lot 100 according to that plan; thence southerly along that production to the water's edge of Rondeau Harbour; thence in a general easterly direction following that water's edge to the most easterly extremity of Shirley Point; thence southeasterly in a straight line to the most northerly extremity of the east face of the west pier of the channel connecting Rondeau Harbour and Lake Erie; thence southerly along that easterly face to a point distant 421.18 feet measured northerly thereon from the production easterly of the southerly limit of Mariner's Road; thence south 77° 14' 25" east, 100 feet; thence north 12° 45' 35" east, 800 feet; thence south 77° 14' 25" east, 700 feet; thence south 12° 45' 35" west, 850 feet, more or less, to the water's edge of Lake Erie; thence in a general easterly direction following the water's edge of Lake Erie to the intersection with the north and south dredge cut; thence north 22° 30' east along the said dredge cut, 3,280 feet, more or less, to the intersection with the most southerly dredge cut; thence north 77° 30' west along the said dredge cut and its northwesterly production, a distance of 1 mile and 3,900 feet; thence north 38° 39' east, 5 miles and 1,196 feet, more or less, to the intersection with the westerly production of the north park boundary lying in an easterly and westerly direction at a bearing of north 76° 50' east; thence easterly along that production and that park boundary 3,630 feet, more or less, to the intersection with the easterly limit of Lake Shore Road; thence southerly and westerly along the easterly limit of Lake Shore Road to the intersection with the easterly limit of Rondeau Park Road; thence southerly along the

east limit of Rondeau Park Road and its production to the intersection with the water's edge of Lake Erie; thence in a general north-easterly and northerly direction following the said water's edge to the intersection with the production easterly of the northerly limit of Lot 2 aforementioned; thence westerly along that production and the northerly limit of that lot to the place of beginning. R.R.O. 1980, Reg. 422, Sched. 4.

Schedule 4

In the Township of Norfolk in The Regional Municipality of Hal-dimand-Norfolk, formerly in the Township of South Walsingham in the County of Norfolk, and described as follows:

1. Beginning at a point in the southerly production of the line between lots 14 and 15 in Concession A in the Township of South Walsingham and which said point is the most northeasterly angle of the lands patented June 11, 1881, to John Woodward and William Anderson; thence southerly along that production 24 chains, more or less, to the northwesterly angle of a plan registered in the Registry Office for the Registry Division of Norfolk as Plan 429; thence easterly along the northerly limit of that plan to the northeasterly angle of that plan; thence southeasterly along the northeasterly limit of that plan to the northerly limit of Erie Boulevard; thence easterly along the northerly limit of Erie Boulevard and continuing easterly along the northerly limit of an existing travelled road to the intersection with the easterly limit of the land expropriated by the Department of Public Works, Ontario, according to a plan registered in the Registry Office for the Registry Division of Norfolk as Plan 537; thence north 19° 20' east astronomically along that easterly limit and its production northerly 1 mile and 61 chains, more or less, to the intersection with a line drawn east astronomically from the intersection of the water's edge on the southerly shore of Big Creek with the northeasterly limit of Long Point Park Road; thence west astronomically 4.5 miles, more or less, to the intersection with the southerly production of the line between lots 14 and 15 in Concession A in the Township of South Walsingham; thence southerly along the said production of the line between lots 14 and 15, a distance of 96 chains, more or less, to the place of beginning.

2. Beginning at a point in the water's edge on the southerly shore of Big Creek where the same is intersected by the northeasterly limit of Long Point Park Road as shown on Department of Highways Plan of Survey P-2267; thence southeasterly along that limit 1 mile and 16 chains, more or less, to the intersection with a line drawn south 60° 03' west astronomically from an angle in the northeasterly limit of the lands patented June 11, 1881, to John Woodward and William Anderson; thence north 60° 03' east astronomically 2.92 chains; thence south 86° 00' east 12.49 chains, more or less, to the intersection with the southerly production of the line between lots 14 and 15 in Concession A in the Township of South Walsingham; thence northerly along the said southerly production of the line between lots 14 and 15, a distance of 96 chains, more or less, to the intersection with a line drawn east astronomically 14 chains, more or less, to the place of beginning. R.R.O. 1980, Reg. 422, Sched. 5.

Schedule 5

Darlington Provincial Park. R.R.O. 1980, Reg. 422, Sched. 6.

Schedule 6

McRae Point Provincial Park. R.R.O. 1980, Reg. 422, Sched. 7.

Schedule 7

In the Township of Georgina in The Regional Municipality of York, formerly in the Township of Georgina in the County of York, and described as follows:

Premising that the bearings hereinafter mentioned are astronomical and are referred to the meridian passing through the northwesterly corner of Lot 7 in Concession VIII in the former Township of Georgina.

FIRSTLY: Beginning at a point in the southerly limit of Lot 9 distant

551.61 feet measured north 72° 19' 20" east along the southerly limit of the said lot from the southwesterly corner thereof; thence south 72° 19' 20" west along the southerly limits of lots 9, 8 and 7 in Concession VIII, 4,425.31 feet to the southwesterly corner of Lot 7; thence north 16° 47' west along the westerly limit of the last mentioned lot a distance of 791.98 feet to the southeasterly limit of the entrance road to Sibbald Point Provincial Park; thence north 53° 22' 30" east along the said southeasterly limit 1,226.92 feet; thence on a curve to the left of radius 1,170.41 feet following the southerly limit of the said entrance road an arc distance of 1,347.36 feet; thence north 12° 35' west along the easterly limit of the said road 1,214.56 feet; thence north 17° 09' west along the said easterly limit of the said road 261.54 feet to the southerly limit of the road along the southerly side of the beach parking area; thence north 79° 26' east along that limit and the easterly production of that limit of road 2,377 feet, more or less, to a point in that part of the easterly limit of the park which is also the westerly limit of Block "A" as shown on Registered Plan No. 268; thence south 17° 44' 10" east along the westerly limit of the said Block "A", a distance of 997 feet, more or less, to an angle therein; thence south 17° 35' 20" east along the easterly limit of Sibbald Point Provincial Park, 2,372.77 feet, more or less, to the place of beginning.

SECONDLY: Beginning at a point in the westerly limit of Lot 7 in Concession VIII being in the northwesterly limit of the entrance road to Sibbald Point Provincial Park and distant 855.76 feet measured north 16° 47' west along the aforesaid westerly limit from the southwesterly corner of that lot; thence north 53° 22' 30" east along that northwesterly limit 1,215.89 feet; thence northeasterly on a curve to the left having a radius of 1,110.41 feet an arc distance of 1,278.29 feet the chord equivalent being 1,208.87 feet measured north 20° 23' 45" east; thence north 12° 35' west along the westerly limit of that road 1,212.16 feet; thence north 17° 19' west continuing along that westerly limit 392.61 feet to the beginning of a curve to the left; thence north 76° 10' west 150 feet to the northerly limit of a swamp; thence south 68° 40' west along that northerly limit 560 feet; thence south 57° 15' west continuing along that northerly limit 1,370 feet, more or less, to the intersection with the westerly limit of said Lot 7; thence southerly along that westerly limit 2,624.24 feet, more or less, to the place of beginning. R.R.O. 1980, Reg. 422, Sched. 8.

Schedule 8

In the Township of Scugog in The Regional Municipality of Durham, formerly in the Township of Scugog in the County of Ontario, and described as follows:

Beginning at the northwesterly corner of Lot 10 in Concession XIV; thence southerly along the westerly limit of that lot to the southwesterly corner thereof; thence southerly in a straight line to the northwesterly corner of Lot 10 in Concession XIII; thence southerly along the westerly limit of that lot to the southwesterly corner thereof; thence easterly along the southerly limit of lots 10, 11 and 12 to the intersection with the westerly limit of Charles Avenue according to registered plan 792; thence northerly along that westerly limit to the intersection with the westerly production of the southerly limit of Lot 3, registered plan 792; thence easterly along that production and the southerly limit of that Lot 3 to the high-water mark of Lake Scugog; thence in a northerly and westerly direction along that high-water mark to the place of beginning. R.R.O. 1980, Reg. 422, Sched. 9.

Schedule 9

Beginning at the intersection of the westerly bank of the Gananoque River with the northerly limit of that part of the King's Highway known as No. 401; thence in a westerly direction along that northerly limit to the intersection with the easterly limit of the road allowance between the Township of Pittsburgh in the County of Frontenac and the Township of Front of Leeds and Lansdowne in the County of Leeds; thence northerly along that easterly limit 394.20 feet; thence north 82° 26' 30" east 635.73 feet; thence north 0° 02' west 1,669.35 feet; thence north 79° 40' 30" east 627.46 feet to the intersection with the line between Lot A and Lot 1 in Concession I in the Township of Front of Leeds and Lansdowne; thence northerly along that line 1,712 feet, more or less, to the centre line of Mud Creek; thence

northeasterly along that centre line and the centre line of the northerly branch of that creek to the intersection with the easterly limit of Lot 7 in Concession I in the Township of Front of Leeds and Lansdowne; thence southerly along that easterly limit to the intersection with the southerly bank of the south branch of Mud Creek; thence easterly along that southerly bank to the intersection with the westerly bank of the Gananoque River; thence southeasterly along that westerly bank to the place of beginning. R.R.O. 1980, Reg. 422, Sched. 10.

Schedule 10

Those portions of Polar Bear Provincial Park in the Territorial District of Kenora, Patricia Portion, described as follows:

1. Beginning at the intersection of the low water mark of the low tide of Hudson's Bay with the water's edge along the easterly bank of Little Shagamu River; thence south 30° 00' west a distance of 5 kilometres; thence north 60° 00' west a distance of 15 kilometres; thence north 30° 00' east a distance of 5 kilometres, more or less to the low water mark of the low tide of Hudson's Bay; thence in a southeasterly direction along the said low water mark to the place of beginning.

2. Beginning at the intersection of latitude 55° 15' north with longitude 83° 45' west; thence south 45° 00' west a distance of 12 kilometres; thence south 45° 00' east a distance of 7 kilometres; thence north 45° 00' east a distance of 14 kilometres, more or less to the low water mark of the low tide of Hudson's Bay; thence in a general northwesterly direction along the said low water mark to a point in a line drawn north 45° 00' east from the place of beginning; thence south 45° 00' west to the east from the place of beginning; thence south 45° 00' west to the place of beginning. O. Reg. 323/84, s. 2.

Schedule 11

All that portion of Obatanga Provincial Park lying southwesterly of the southerly limit of that part of the King's Highway known as No. 17. O. Reg. 127/82, s. 4, *part*.

Schedule 12

Chapleau Nemegosenda River Provincial Park, except that part situate in the Chapleau Crown Game Reserve. O. Reg. 127/82, s. 4, *part*.

Schedule 13

Mississagi River Provincial Park. O. Reg. 127/82, s. 4, *part*.

Schedule 14

That part of the geographic townships of Frost, Elgie and McEwing, in the Territorial District of Algoma and in the Province of Ontario being the land and land under water within Nagagamisis Provincial Park, saving and excepting thereout and therefrom those parts more particularly described as follows:

1. Part of the geographic townships of Frost and McEwing described as follows:

Beginning at the intersection of the easterly limit of the right of way of Secondary Highway No. 631 with the southerly shore of Nagagamisis Lake; thence in a general southwesterly, southerly and southeasterly direction along the easterly limit of the said right of way to the intersection with the northerly shore of Blackwater Creek; thence in a general easterly direction following the northerly shore of Blackwater Creek to the northwesterly shore of Park Lake; thence in a general northeasterly direction following the northwesterly shore of Park Lake to the northerly shore of an unnamed creek draining Park Lake; thence in a general easterly direction following the northerly shore of the said unnamed creek to the westerly shore of Duck Bay; thence in a general northeasterly direction following the westerly shore of Duck Bay to the southerly shore of Nagagamisis Lake; thence in a general westerly and northwesterly direction

following the south shore of Nagagamis Lake to the place of beginning.

2. Part of the geographic Township of Frost described as follows:

Premising that all bearings hereinafter mentioned are astronomical.

Beginning at survey monument No. 334 defining a point on the westerly limit of the right of way of Secondary Highway No. 631 opposite H.O.T. at chainage 299 + 86.25 as shown on Ministry of Transportation and Communications Plan P-3451-1; thence north 85 degrees 00 minutes west 1760.00 metres; thence north 67 degrees 00 minutes west 1810.00 metres; thence north astronomic 400.00 metres, more or less, to a point measured southerly from and 100.00 metres in perpendicular distance to the southerly shore of Nagagamis Lake; thence in a general northeasterly direction parallel to the said southerly shore and 100.00 metres in perpendicular distance therefrom to the intersection with the westerly limit of the right of way of Secondary Highway No. 631; thence in a general southwesterly, southerly and southeasterly direction following the westerly limit of the said right of way to the place of beginning.

3. Part of the geographic Township of Frost described as follows:

Premising that all bearings hereinafter mentioned are astronomical.

Beginning at the southeast corner of the herein described tract of land which is distant 1410.00 metres measured south 64 degrees 41 minutes west from monument No. 334 defining a point on the westerly limit of the right of way of Secondary Highway No. 631 opposite H.O.T. at chainage 299 + 86.25 as shown on Ministry of Transportation and Communications Plan P-3451-1; thence north astronomic 400.00 metres; thence west astronomic 650.00 metres; thence south astronomic 400.00 metres; thence east astronomically 650.00 metres to the place of beginning.

4. Part of the geographic Township of McEwing described as follows:

Beginning at the intersection of the north boundary of Nagagamis Provincial Park with the easterly shore of an unnamed creek draining into Nagagamis Lake being distant 5900.00 metres, more or less, measured westerly along the said north boundary from the northeast corner of said park; thence easterly along the said north boundary 860.00 metres, more or less, to the westerly shore of an unnamed creek draining into Nagagamis Lake; thence in a general southerly direction following the westerly shore of the unnamed creek to the northerly shore of Nagagamis Lake; thence in a general westerly, southwesterly, westerly and northwesterly direction following the northerly shore of Nagagamis Lake to the easterly shore of an unnamed creek on which easterly shore the place of beginning is situated; thence in a general northeasterly direction following the said easterly shore to the place of beginning.

5. Part of the geographic Township of McEwing described as follows:

Premising that all bearings hereinafter mentioned are astronomical.

Beginning at the southeast corner of the herein described tract of land distant 2130.00 metres measured north astronomic from a point on the south boundary of the geographic Township of McEwing distant 12,000.00 metres measured westerly thereon from the southeast corner of the said township; thence north 20 degrees 20 minutes east 550.00 metres; thence west astronomically 100.00 metres, more or less, to the easterly shore of Duck Bay; thence in a general southwesterly direction following the easterly shore of Duck Bay to the intersection with a line drawn on a course of west astronomic from the place of beginning; thence east astronomic 100.00 metres, more or less, to the place of beginning.

6. Part of the geographic Township of McEwing described as follows:

Premising that all bearings hereinafter mentioned are astronomical.

Beginning at the northeast corner of the herein described tract of land distant 1500.00 metres measured north astronomic from a point in the south boundary of the geographic Township of McEwing distant 6700.00 metres measured westerly thereon from the southeast corner of the said township; thence north 80 degrees 00 minutes west 990.00 metres, more or less, to the easterly shore of Nagagamis River; thence in a general southerly, southeasterly and easterly direction following the said shore to the intersection with a line drawn on a course of south astronomic from the place of beginning; thence north astronomic 300.00 metres, more or less, to the place of beginning.

7. Part of the geographic Township of McEwing described as follows:

Premising that all bearings hereinafter mentioned are astronomical.

Beginning at the northeast corner of the northeast corner of the herein described tract of land distant 3140.00 metres measured north astronomic from a point in the south boundary of the geographic Township of McEwing distant 2350.00 metres measured westerly thereon from the southeast corner of the said township; thence west astronomic 700.00 metres; thence south astronomic 2000.00 metres, more or less, to the northerly shore of Nagagamis River; thence in a general easterly direction following the said shore to the intersection with a line drawn on a course of south astronomic from the place of beginning; thence north astronomic 2480.00 metres, more or less, to the place of beginning. O. Reg. 127/82, s. 4, *part*.

Schedule 15

That part of the geographic townships of Bannerman, Fushimi, Hanlan and Stoddart, in the Territorial District of Cochrane and in the Province of Ontario being the land and land under water within Fushimi Lake Provincial Park, saving and excepting thereout and therefrom those parts more particularly described as follows:

1. Part of the geographic townships of Fushimi and Stoddart described as follows:

Premising that the bearings hereinafter mentioned are astronomical.

Beginning at the intersection of the north boundary of the geographic Township of Stoddart with the westerly shore of Achilles Lake being distant 3120.00 metres, more or less, measured westerly thereon from the northeast corner thereof; thence in a general northerly direction following the said westerly shore to the most northerly point thereon; thence east astronomically 1300.00 metres; thence south astronomically 1660.00 metres, more or less, to the intersection with the northerly shore of Fushimi Lake; thence in a general northwesterly, westerly and southwesterly direction following the northerly shore of Fushimi Lake to the west shore of the creek draining Achilles Lake; thence in a general northerly direction following the said westerly shore to the westerly shore of Achilles Lake; thence in a general northerly direction following the westerly shore of Achilles Lake to the place of beginning.

2. Part of the geographic townships of Bannerman and Hanlan described as follows:

Premising that the bearings hereinafter mentioned are astronomical.

Beginning at the southwest corner of the said geographic Township of Bannerman; thence northerly along the west boundary of the geographic Township of Bannerman a distance of 600.00 metres; thence east astronomically 650.00 metres; thence south 17 degrees 00

minutes west 1250.00 metres, more or less, to the intersection with the northerly shore of Fushimi Lake; thence in a general northwesterly, westerly and southwesterly direction following the said northerly shore to the intersection with the west boundary of the geographic Township of Hanlan; thence northerly along the west boundary of the said township to the place of beginning.

3. Part of the geographic Township of Stoddart described as follows:

Premising that the bearings hereinafter mentioned are astronomical.

Beginning at a point within the geographic Township of Stoddart distant 2420.00 metres measured south astronomic from a point on the north boundary of the said township distant 3060.00 metres measured westerly thereon from the northeast corner of the said township; thence east astronomic 520.00 metres, more or less, to the intersection with the westerly shore of Fushimi Lake; thence in a general southerly direction following the westerly shore of Fushimi Lake to the northerly shore of Valentine Creek; thence in a general westerly and northerly direction following the northerly shore of Valentine Creek to the intersection with a line drawn on a course of west astronomic from the place of beginning; thence east astronomic 50.00 metres, more or less, to the place of beginning.

4. Part of the geographic Township of Stoddart described as follows:

Premising that the bearings hereinafter mentioned are astronomical.

Beginning at the intersection of the southerly shore of Valentine Creek with a line drawn on a course of south astronomic from a point on the north boundary of the said township distant 3060.00 metres measured westerly thereon from the northeast corner of the said township; thence south astronomic 250.00 metres; thence east astronomic 510.00 metres, more or less, to the intersection with the westerly shore of Fushimi Lake; thence in a general northwesterly direction following the westerly shore of Fushimi Lake to the southerly shore of Valentine Creek; thence in a general westerly direction following the southerly shore of Valentine Creek to the place of beginning. O. Reg. 127/82, s. 4, *part*.

Schedule 16

Rock Point Provincial Park. O. Reg. 681/83, s. 3.

Schedule 17

Winisk River Provincial Park. O. Reg. 411/84, s. 3.

Schedule 18

Point Farms Provincial Park. O. Reg. 624/84, s. 3.

Schedule 19

The part of Lake of the Woods Provincial Park described as follows:

In the Territorial District of Kenora, containing 11,799.75 hectares, more or less, being composed of those parts of the said Territorial District of Kenora designated as Parts 1 to 9, both inclusive, on a plan known as "Northwestern—Lake of the Woods", approved on the 1st day of August, 1984 and filed in the office of the Regional Director for the Northwestern Administrative Region of the Ministry of Natural Resources at Kenora, Ontario. O. Reg. 44/85, s. 4, *part*.

Schedule 20

The part of The Shoals Provincial Park lying northerly of that part of the King's Highway known as No. 101 and described as follows:

In the geographic townships of Bliss, Cosens, Druillettes, Gilliland

and Peters, in the District of Sudbury, containing 8,010 hectares, more or less, being composed of that part of the said geographic townships designated as Part 1 on a plan known as "Northern—The Shoals", approved on the 3rd day of July, 1984 and filed in the office of the Regional Director for the Northern Administrative Region of the Ministry of Natural Resources at Cochrane, Ontario. O. Reg. 44/85, s. 4, *part*.

Schedule 21

Makobe—Grays River Provincial Park. O. Reg. 44/85, s. 4, *part*.

Schedule 22

Pretty River Valley Provincial Park. O. Reg. 44/85, s. 4, *part*.

Schedule 23

Abitibi-De Troyes Provincial Park. O. Reg. 83/85, s. 3, *part*.

Schedule 24

Aubrey Falls Provincial Park. O. Reg. 83/85, s. 3, *part*.

Schedule 25

Silver Falls Provincial Park. O. Reg. 83/85, s. 3, *part*.

Schedule 26

Wanapitei Provincial Park. O. Reg. 83/85, s. 3, *part*.

Schedule 27

Kashabowie Provincial Park. O. Reg. 280/85, s. 3, *part*.

Schedule 28

La Cloche Provincial Park. O. Reg. 280/85, s. 3, *part*.

Schedule 29

Little Abitibi River Provincial Park. O. Reg. 280/85, s. 3, *part*.

Schedule 30

Opeongo River Provincial Park. O. Reg. 280/85, s. 3, *part*.

Schedule 31

Westmeath Provincial Park. O. Reg. 516/85, s. 4, *part*.

Schedule 32

Middle Falls Provincial Park. O. Reg. 516/85, s. 4, *part*.

Schedule 33

Larder River Provincial Park. O. Reg. 516/85, s. 4, *part*.

Schedule 34

Oxtongue River—Ragged Falls Provincial Park. O. Reg. 516/85, s. 4, *part*.

Schedule 35

RESTOULE PROVINCIAL PARK

The part of Restoule Provincial Park described as follows:

All that parcel or tract of land in the Township of Patterson, in the District of Parry Sound, being composed of part of Part I as shown on a plan of Restoule Provincial Park known as "Northeastern-Restoule", approved on the 3rd day of May, 1985 and filed in the office of the Regional Director for the Northeastern Administrative

Region of the Ministry of Natural Resources at Sudbury, Ontario, and which parcel or tract of land may be more particularly described as follows:

Beginning at the northwesterly corner of Lot 13, Concession X, in the said Township of Patterson; thence southerly along the westerly limit of said Lot 13 and along the southerly production of the said limit across the allowance for road to the water's edge along the northerly shore of Restoule Lake; thence easterly following the said water's edge and water's edge along the northerly shore of Restoule River to the intersection with the southerly production of the westerly limit of Lot 18, Concession VIII; thence northerly along the said southerly production across the allowance for road and along the said westerly limit to the northwesterly corner of said Lot 18; thence northerly in a straight line across the allowance for road between concessions VIII and IX to the southwesterly corner of Lot 18, Concession IX; thence northerly along the westerly limit of said Lot 18 and along the northerly production of the said limit across the allowance for road to the water's edge along the westerly shore of Patterson Lake; thence westerly following the said water's edge and the water's edge along the southerly shore of Restoule River to the intersection with the northerly production of the westerly limit of Lot 13, Concession XI; thence southerly along the said northerly production across the allowance for road and along the said westerly limit to the southwesterly corner of said Lot 13; thence southerly in a straight line across the allowance for road between concessions X and XI to the place of beginning. O. Reg. 516/85, s. 4, *part.*

Schedule 36

Sandpoint Island Provincial Park. O. Reg. 516/85, s. 4, *part.*

Schedule 37

South Bay Provincial Park. O. Reg. 516/85, s. 4, *part.*

Schedule 38

W.J.B. Greenwood Provincial Park. O. Reg. 516/85, s. 4, *part.*

Schedule 39

FRENCH RIVER PROVINCIAL PARK

Excepting those parts thereof that are posted with signs prohibiting hunting. O. Reg. 213/89, s. 2.

Schedule 40

Bonnechere River Provincial Park. O. Reg. 258/89, s. 5 (6), *part.*

Schedule 41

GRUNDY LAKE PROVINCIAL PARK

Excepting those parts thereof that are posted with signs prohibiting hunting. O. Reg. 258/89, s. 5 (6), *part.*

Schedule 42

Kawartha Highlands Provincial Park. O. Reg. 258/89, s. 5 (6), *part.*

Schedule 43

LOWER MADAWASKA RIVER PROVINCIAL PARK

Excepting those parts thereof that are posted with signs prohibiting hunting. O. Reg. 258/89, s. 5 (6), *part.*

Schedule 44

Lake St. Peter Provincial Park. O. Reg. 258/89, s. 5 (6), *part.*

Schedule 45

MISSINAIBI PROVINCIAL PARK

Excepting that part situate in the Chapleau Crown Game Preserve. O. Reg. 258/89, s. 5 (6), *part.*

Schedule 46

Steel River Provincial Park. O. Reg. 258/89, s. 5 (6), *part.*

Schedule 47

Sturgeon River Provincial Park. O. Reg. 258/89, s. 5 (6), *part.*

Schedule 48

Turtle River Provincial Park. O. Reg. 258/89, s. 5 (6), *part.*

Schedule 49

Obabika River Provincial Park. O. Reg. 258/89, s. 5 (6), *part.*

Schedule 50

Solace Provincial Park. O. Reg. 258/89, s. 5 (6), *part.*

Schedule 51

Little Current River. O. Reg. 258/89, s. 5 (6), *part.*

Schedule 52

Albany River Provincial Park. O. Reg. 292/89, s. 4, *part.*

Schedule 53

Biscotasi Lake Provincial Park. O. Reg. 292/89, s. 4, *part.*

Schedule 54

Black Creek Provincial Park. O. Reg. 292/89, s. 4, *part.*

Schedule 55

Blackstone Harbour Provincial Park. O. Reg. 292/89, s. 4, *part.*

Schedule 56

Brightsand River Provincial Park. O. Reg. 292/89, s. 4, *part.*

Schedule 57

Dana-Jowsey Lakes Provincial Park. O. Reg. 292/89, s. 4, *part.*

Schedule 58

Fawn River Provincial Park. O. Reg. 292/89, s. 4, *part.*

Schedule 59

Kopka River Provincial Park. O. Reg. 292/89, s. 4, *part.*

Schedule 60

La Motte Lake Provincial Park. O. Reg. 292/89, s. 4, *part.*

Schedule 61

La Verendrye River Provincial Park. O. Reg. 292/89, s. 4, *part.*

Schedule 62

Otoskwin-Attawapiskat River Provincial Park. O. Reg. 292/89, s. 4, *part.*

Schedule 63

Ottawa River Provincial Park. O. Reg. 292/89, s. 4, *part*.

Schedule 64

Pipstone River Provincial Park. O. Reg. 292/89, s. 4, *part*.

Schedule 65

Severn River Provincial Park. O. Reg. 292/89, s. 4, *part*.

Schedule 66

Upper Madawaska River Provincial Park. O. Reg. 292/89, s. 4, *part*.

Form 1

Game and Fish Act

**PROVINCIAL HUNTING AREA
DAILY WATERFOWL BLIND LICENCE**

Under the *Game and Fish Act* and the regulations, and subject to the limitations thereof, this licence is issued to

Mr. _____
Miss _____
Mrs. (Last Name) (First Name) (Initial)

of _____
(Street Address, P.O. Box, or Rural Route) (City, Town, Village)

and to _____
(Last Name) (First Name) (Initial)

of _____
(Street Address, P.O. Box, or Rural Route) (City, Town, Village)

to hunt ducks, geese, rails, coots and gallinules during the open season in the area described as Blind No. _____ at _____

This licence expires with the date on which it is issued. .

Date of Issue _____, 19..... Signature of Issuer _____
R.R.O. 1980, Reg. 422, Form 1; O. Reg. 521/86, s. 2 (1).

Form 2

Game and Fish Act

**PROVINCIAL HUNTING AREA
SEASONAL WATERFOWL LICENCE**

Under the *Game and Fish Act* and the regulations, and subject to the limitations thereof, this licence is issued to

Mr. _____
Miss _____
Mrs. (Last Name) (First Name) (Initial)

of _____
(Street Address, P.O. Box, or Rural Route) (City, Town, Village)

to hunt ducks, geese, rails, coots and gallinules during the open season in a Seasonal Waterfowl Area.

This licence expires with the last day of the open season for ducks, geese, rails, coots and gallinules.

Date of Issue _____, 19..... Signature of Issuer _____

R.R.O. 1980, Reg. 422, Form 2; O. Reg. 521/86, s. 2 (2).

Form 3

Game and Fish Act

**PROVINCIAL HUNTING AREA
DAILY LICENCE TO HUNT PHEASANT**

Under the *Game and Fish Act* and the regulations, and subject to the limitations thereof, this licence is issued to

Mr. _____
Miss _____
Mrs. (Last Name) (First Name) (Initial)

of _____
(Street Address, P.O. Box, or Rural Route) (City, Town, Village)

to hunt pheasants in the area described as _____

This licence expires with the date on which it is issued _____

Date of Issue _____, 19..... Signature of Issuer _____
R.R.O. 1980, Reg. 422, Form 3; O. Reg. 521/86, s. 2 (3).

Form 4

Game and Fish Act

**PROVINCIAL HUNTING AREA
DAILY LICENCE TO HUNT GAME ANIMALS AND GAME BIRDS**

Under the *Game and Fish Act* and the regulations, and subject to the limitations thereof, this licence is issued to

Mr. _____
Miss _____
Mrs. (Last Name) (First Name) (Initial)

of _____
(Street Address, P.O. Box, or Rural Route) (City, Town, Village)

to hunt game animals and game birds during the open season in the area described as _____

This licence expires with the date on which it is issued.

Date of Issue _____, 19..... Signature of Issuer _____
R.R.O. 1980, Reg. 422, Form 4; O. Reg. 521/86, s. 2 (4).

Form 5

Game and Fish Act

LICENCE TO ERECT A WATERFOWL BLIND

Under the *Game and Fish Act* and the regulations, and subject to the limitations thereof, this licence is issued to

Mr. _____
Miss _____
Mrs. (Last Name) (First Name) (Initial)

of _____
(Street Address, P.O. Box, or Rural Route) (City, Town, Village)

to erect and maintain a blind in the area described in paragraph 2 of Schedule 4 to Regulation 502 of Revised Regulations of Ontario, 1990 until the 15th day of March, 19.....

Date of Issue, 19..... Signature of Issuer

R.R.O. 1980, Reg. 422, Form 5.

REGULATION 503

LAKE ST. LAWRENCE HUNTING AREA

1. The lands in respect of which an agreement has been entered into under section 6 of the Act and described in the Schedule are designated in accordance with paragraph 33 of section 92 of the Act. R.R.O. 1980, Reg. 423, s. 1.

2. Except as provided in this Regulation, no person shall hunt any animal or bird in the area described in the Schedule. R.R.O. 1980, Reg. 423, s. 2.

3. The holder of a Canada Migratory Game Bird Hunting Permit may hunt migratory game birds on any day, except Sunday, during the open season therefor during the hours between one-half hour before sunrise and one-half hour after sunset in the area described in the Schedule upon condition that,

- (a) the holder of the permit parks his or her motor vehicle in an area designated as a parking area;
(b) the holder of the permit hunts only within a radius of thirty feet from a stake planted and marked by an officer of the Ministry with the number of the area in which his or her motor vehicle is parked;
(c) the area from which the holder of the permit hunts is occupied by no more than one other person; and
(d) the holder of the permit keeps his or her firearm encased except while occupying a hunting area. R.R.O. 1980, Reg. 423, s. 3.

4. In this Schedule, a reference to the Schedule is a reference to the Schedule to Regulation 423 of Revised Regulations of Ontario, 1980, as that Schedule read on December 31, 1990. New.

REGULATION 504

LICENCE TO CHASE RACCOON AT NIGHT AND FOX, COYOTE OR WOLF DURING THE DAY

1. In this Regulation,

“association” means an association comprised of natural persons that is incorporated in Ontario for the purpose of hunting or chasing animals or birds, conducting field trials or training dogs;

“field trial” means an activity authorized by an association for the purpose of testing the hunting skills of a dog. O. Reg. 233/82, s. 1.

2.—(1) A licence to chase raccoon at night and to chase fox, coyote or wolf during the day shall be in Form 1 and shall be issued without the payment of a fee.

(2) A licence in Form 1 may be issued to,

- (a) a resident; or
(b) an association.

(3) A licence in Form 1 authorizes,

- (a) when issued to a resident, the holder of the licence; or
(b) when issued to an association, a registered member or, subject to section 7, a guest of the association,

to chase raccoon at night and to chase fox, coyote or wolf during the day. O. Reg. 233/82, s. 2.

3.—(1) A licence in Form 1 may be issued to a resident who is fifteen years of age if the resident files with the issuer a consent signed,

- (a) where the resident resides with his or her parents, by both parents; and
(b) in all other cases, by his or her parent or by the person who has custody of the resident.

(2) No association that holds a licence in Form 1 shall permit a member or guest who is fifteen years of age to chase raccoon at night or to chase fox, coyote or wolf during the day unless the member or guest files with the association a consent signed,

- (a) where the member or guest resides with his or her parents, by both parents; and
(b) in all other cases, by his or her parent or by the person who has custody of the member or guest. O. Reg. 233/82, s. 3.

4.—(1) A licence in Form 1 is valid in the area and during the period specified in the licence.

(2) On an application by the holder of a licence in Form 1, an issuer of the licence may alter the area specified in the licence. O. Reg. 233/82, s. 4.

5.—(1) An association that is applying for a licence in Form 1 shall file with the district manager of the administrative district of the Ministry of Natural Resources in which the application is made a complete list of its registered members.

(2) An association that holds a licence in Form 1 shall, within seven days of any change in its membership, file with the district manager of the administrative district of the Ministry of Natural Resources in the area in which the licence is valid a notice of such change. O. Reg. 233/82, s. 5.

6. An association shall produce upon the request of an officer a complete list of its guests who participate in a field trial for raccoon, fox, coyote or wolf authorized by the association. O. Reg. 233/82, s. 6.

7. No guest of an association shall chase raccoon at night or chase fox, coyote or wolf during the day, except in a field trial authorized by the association. O. Reg. 233/82, s. 7.

8. No person taking part in the chase of raccoon at night or the chase of fox, coyote or wolf during the day shall use or carry a firearm during the chase. O. Reg. 233/82, s. 8.

Form 1

Game and Fish Act

LICENCE TO CHASE RACCOON AT NIGHT AND FOX, COYOTE OR WOLF DURING THE DAY

19.....

Licence Serial Number

Under the *Game and Fish Act* and the regulations, and subject to the limitations thereof, this licence is issued to:

.....
.....
of

for the purpose of chasing raccoon at night and fox, coyote or wolf during the day, without the use of guns and without capturing the animals, in the area specified as follows:

.....
.....
.....
.....

This licence is valid only from and including
..... to, 19.....

Signature of Issuer	Date of Issue	Signature of Licensee
..... Administrative District of Issue		

O. Reg. 233/82, Form 1.

REGULATION 505

LICENCE TO POSSESS NETS

1.—(1) A licence to possess a gill, hoop, pound, seine, trap or trawl net shall be in a form furnished by the Ministry of Natural Resources and shall be issued without payment of a fee.

(2) A licence referred to in subsection (1) expires with the 31st day of January next following the date on which it is issued. R.R.O. 1980, Reg. 424, s. 1.

REGULATION 506

LUTHER MARSH HUNTING AREA

1. The lands in respect of which an agreement has been entered into under section 6 of the Act and described in the Schedule are designated in accordance with paragraph 33 of section 92 of the Act. R.R.O. 1980, Reg. 425, s. 1.

2. Except as provided in this Regulation, no person shall hunt any animal or bird in the area described in the Schedule on,

- (a) the first day of the open season for migrating birds;
- (b) the Saturday next following the day mentioned in clause (a);
- (c) the second Monday in October; and
- (d) the Saturday immediately preceding the day mentioned in clause (c). R.R.O. 1980, Reg. 425, s. 2.

3. During the open season therefor, the holder of a licence in Form 5 of Regulation 500 of Revised Regulations of Ontario, 1990, may hunt the game specified in the licence on the days mentioned in clauses 2 (a), (b), (c) and (d) in the area described in the Schedule upon condition that,

- (a) the holder of the licence deposits the licence with the officer in charge and obtains a licence in Form 1;
- (b) there are not as many as four hundred and fifty other persons hunting in the area described in the Schedule at the time the holder of the licence presents the licence to the officer in charge; and
- (c) if the holder of the licence hunts from a boat, he or she hunts within a radius of twenty-five feet from a stake planted and marked by an officer of the Ministry of Natural Resources. R.R.O. 1980, Reg. 425, s. 3.

4. In this Regulation, a reference to the Schedule is a reference to the Schedule to Regulation 425 of Revised Regulations of Ontario, 1980, as that Schedule read on December 31, 1990. *New.*

Form 1

Game and Fish Act

LUTHER MARSH WILDLIFE MANAGEMENT AREA

FREE DAILY HUNTING LICENCE

Under the *Game and Fish Act* and the regulations and subject to the limitations thereof, this licence is issued to:

Mr.	Last Name (Print)										
Ms.											
Mrs.											
Miss											

First Name (Print)	Initials
<input type="text"/>	<input type="text"/>

Street Address P.O. Box or Rural Route (Print)

City or Town or Village (Print)

Province or State (Print)

to hunt ducks, rails, coots, gallinules, woodcock, snipe, hare, rabbits, grouse and pheasants during the open season.

Valid for this date only

Signature of Issuer

R.R.O. 1980, Reg. 425, Form 1.

REGULATION 507**NASHVILLE TRACT HUNTING AREA**

1. The lands in respect of which an agreement has been entered into under section 6 of the Act, described in the Schedule, are designated in accordance with paragraph 33 of section 92 of the Act. O. Reg. 487/86, s. 1.

2. Regulations 500 and 512 of Revised Regulations of Ontario, 1990 apply to the hunting of deer in the area described in the Schedule except in so far as those Regulations are modified by this Regulation. O. Reg. 487/86, s. 2.

3. Except as provided in this Regulation, no person shall hunt any animal or bird in the area described in the Schedule. O. Reg. 487/86, s. 3.

4.—(1) The holder of a licence in Form 1 or 2 of Regulation 500 of Revised Regulations of Ontario, 1990 may hunt deer of either sex from the first Monday in November to the Thursday next following, both inclusive, and from the second Monday in November to the Thursday next following, both inclusive, in any year in the area described in the Schedule if,

- (a) the holder's name is drawn by lot in a draw administered by the Ministry;
- (b) the holder affixes to the licence a tag in Form 25 of Regulation 500 of Revised Regulations of Ontario, 1990 issued to the holder;
- (c) the holder hunts only on a date set out in the tag; and
- (d) the holder returns to the Cold Creek Conservation Authority station at or before 7.30 o'clock in the afternoon on every day the holder has hunted and reports the day's success and, where successful, produces the deer to the officer for inspection.

(2) No person shall use or be accompanied by a dog while hunting deer in the area described in the Schedule.

(3) Only shotguns may be used while hunting deer in the area described in the Schedule.

(4) The holder of a licence in Form 1 or 2 of Regulation 500 of Revised Regulations of Ontario, 1990 that is valid for hunting deer in the area described in the Schedule shall complete the questionnaire provided with the tag in Form 25 of Regulation 500 of Revised Regulations of Ontario, 1990 by the Ministry and return the questionnaire to the office of the Ministry specified thereon on or before the fourteenth day next following the expiry of the tag.

(5) Any person who refuses or neglects to return the completed questionnaire to the Ministry as required by subsection (4) is ineligible to receive a tag in Form 25 of Regulation 500 of Revised Regulations of Ontario, 1990 in the year next following. O. Reg. 487/86, s. 4.

5. In this Regulation, a reference to the Schedule is a reference to the Schedule to Ontario Regulation 487/86 as that Schedule read on December 31, 1990. *New.*

REGULATION 508**NAVY ISLAND HUNTING AREA**

1. The lands in respect of which an agreement has been entered into under section 6 of the Act and described in the Schedule are designated in accordance with paragraph 33 of section 92 of the Act. O. Reg. 645/81, s. 1.

2. Regulation 512 of Revised Regulations of Ontario, 1990 applies to this Regulation except insofar as that Regulation is modified by this Regulation. O. Reg. 645/81, s. 2.

3. Except as provided in this Regulation, no person shall hunt any animal or bird in the area described in the Schedule. O. Reg. 645/81, s. 3.

4. The holder of a licence in Form 1 or 2 of Regulation 500 of Revised Regulations of Ontario, 1990 may hunt deer on any day from the first Monday in November to the fourth Saturday next following, both inclusive, in any year in the area described in the Schedule, if,

- (a) in the determination of the Ministry, there are sufficient harvestable quantities of deer for the purpose;
- (b) his or her name is drawn by lot in a draw administered by the Ministry; and
- (c) he or she affixes to his or her licence to hunt deer a tag supplied by the Ministry. O. Reg. 156/83, s. 1.

5. The tag mentioned in clause 4 (b) authorizes the hunter to hunt antlered or antlerless deer in the area described in the Schedule and is valid for the dates mentioned therein. O. Reg. 645/81, s. 5.

6.—(1) Only shotguns may be used while hunting deer in the area described in the Schedule.

(2) No person shall use or be accompanied by a dog while hunting deer in the area described in the Schedule. O. Reg. 645/81, s. 6.

7.—(1) The holder of a licence in Form 1 or 2 of Regulation 500 of Revised Regulations of Ontario, 1990 that is valid for hunting deer in the area described in the Schedule shall complete the questionnaire provided with the tag referred to in clause 4 (c) and return the questionnaire to the office of the Ministry specified thereon within fourteen days after the end of the open season for deer in the area described in the Schedule. O. Reg. 156/83, s. 2.

(2) Any person who refuses or neglects to return the completed questionnaire to the Ministry as required by subsection (1) and in accordance therewith is ineligible to receive a tag under clause 4 (b) in the year next following. O. Reg. 645/81, s. 7 (2).

Schedule

Navy Island in the Niagara River in The Regional Municipality of Niagara. O. Reg. 645/81, Sched.

REGULATION 509**OPEN SEASON—BLACK BEAR**

1. This Regulation is subject to Revised Regulations of Ontario, 1990, Regulations 476 and 484 and does not apply to provincial parks other than that part of Algonquin Provincial Park situate in the townships of Bruton and Clyde in the County of Haliburton. R.R.O. 1980, Reg. 426, s. 1.

2. In this Regulation, a reference to a wildlife management unit is a reference to that unit as described and enumerated in Schedule 1 to Revised Regulations of Ontario, 1990, Regulation 530. O. Reg. 339/82, s. 1, *part.*

3. In this Regulation, unless otherwise specified, whenever an open season is set out, the open season includes both the date of commencement and the date of termination. R.R.O. 1980, Reg. 426, s. 3.

4.—(1) In this section, “cub” means a black bear born in the year of the hunt.

(2) Subject to the following subsections, the holder of a licence in Form 4 or 9 of Revised Regulations of Ontario, 1990, Regulation 500, may hunt black bear in the wildlife management unit specified in Column 1 of an item of the Schedule during the open season specified in Column 2 of the item.

(3) Only bows and arrows or flint-lock or percussion cap muzzle-loading guns shall be used in wildlife management unit 7A.

(4) The holder shall not shoot or attempt to shoot a black bear cub or a female black bear accompanied by a cub or cubs,

(a) commencing with the 15th day of April and ending with the 15th day of June in the wildlife management units specified in Column 1 of items 1 to 5 of the Schedule; or

(b) commencing with the 15th day of April and ending with the 30th day of June in wildlife management units 25 and 26.

(5) The holder shall not shoot or attempt to shoot a black bear in a den.

(6) The holder shall not shoot or attempt to shoot a black bear on Crown land within 400 metres of a waste disposal site as defined in section 25 of the *Environmental Protection Act*.

(7) No person shall use or be accompanied by a dog while hunting black bear in a wildlife management unit open for hunting black bear, during the period commencing with the 16th day of May and ending with the 30th day of June in any year.

(8) Subsection (7) does not apply to the holder of a licence in Form 4 of Regulation 500 of Revised Regulations of Ontario, 1990 while hunting black bear during the open season in wildlife management units 61 to 75, inclusive, and 83. O. Reg. 28/87, s. 1.

5.—(1) The holder of a licence in Form 9 of Regulation 500 of Revised Regulations of Ontario, 1990 that is valid for hunting black bear shall complete the report on the duplicate copy of Form 33 of Regulation 500 of Revised Regulations of Ontario, 1990 and return it to the issuer of it on or before,

(a) the 5th day of July of the year in which the certificate is issued, where the closing day of the open season for black bear is on or before the 30th day of June; or

(b) the 30th day of November of the year in which the certificate is issued, in all other cases. O. Reg. 133/87, s. 1; O. Reg. 262/89, s. 1.

(2) A person who refuses or neglects to return the completed questionnaire to the Ministry in accordance with subsection (1) is ineligible to receive a certificate in Form 33 of Regulation 500 of Revised Regulations of Ontario, 1990 in the year next following. O. Reg. 493/83, s. 1, *part*.

Schedule

ITEM	COLUMN 1	COLUMN 2
	Wildlife Management Units	Open Seasons
1.	2, 3, 4, 5, 6, 7B, 8, 9A, 9B and 10	April 15 to June 15 and September 1 to October 31
2.	7A	April 15 to June 15 and September 1 to October 15
3.	1, 11A, 11B, 12A, 12B, 13, 14, 15A, 15B, 16A, 16B, 16C, 17, 18A, 18B, 19, 21A, 21B, 22, 23, 24, 27, 28, 29, 30, 31, 32, 33, 34, 35, 36, 37, 38, 39, 40, 41, 42, 43, 44 and 45	April 15 to June 15 and September 1 to October 15
4.	46, 47, 49, 50, 53A, 53B, 64, 65, 66, 67, 69A, 69B, 71, 72, 73, 74, 75, 76 and 83	April 15 to June 15 and September 15 to November 30
5.	48, 54, 55A, 55B, 56, 57, 58, 59, 60A, 61, 62, 63 and 68	April 15 to June 15 and September 1 to November 30
6.	25 and 26	April 15 to June 30 and September 1 to October 15

O. Reg. 387/90, s. 1.

REGULATION 510

OPEN SEASONS—FUR-BEARING ANIMALS

OPEN SEASON FOR FOX, RACCOON, RED SQUIRREL, SKUNK, WEASEL AND WOLF

1.—(1) Grey fox, red squirrel and weasel may be hunted or trapped, and the pelts thereof may be possessed in any part of Ontario from the 25th day of October in any year to the last day of February in the year next following, both inclusive. R.R.O. 1980, Reg. 427, s. 1 (1); O. Reg. 146/83, s. 1 (1); O. Reg. 306/83, s. 1 (1).

(2) Skunk, wolf and the hybrid of *Canis lupus L.* and *Canis latrans* Say may be hunted or trapped, and the pelts thereof may be possessed, in any part of Ontario from the 1st day of October in any year to the 30th day of September in the year next following, both inclusive. O. Reg. 146/83, s. 1 (2).

(3) Arctic fox may be hunted or trapped, and the pelts thereof may be possessed, in any part of Ontario from the 25th day of Octo-

ber in any year to the 31st day of March in the year next following, both inclusive. O. Reg. 306/83, s. 1 (2).

2.—(1) *Vulpes vulpes L.* commonly known as coloured fox may be trapped, hunted or possessed in the part of Ontario lying north of the French and Mattawa rivers from the 25th day of October in any year to the last day of February in the year next following, both inclusive.

(2) *Vulpes vulpes L.* commonly known as coloured fox may be trapped, hunted or possessed in the part of Ontario described in Schedule 4 from the 1st day of October in any year to the 30th day of September in the year next following, both inclusive. R.R.O. 1980, Reg. 427, s. 2.

3. Raccoon may be hunted or trapped, and the pelt thereof may be possessed, in any part of Ontario from the 15th day of October to the 31st day of December, both inclusive, in any year. R.R.O. 1980, Reg. 427, s. 3.

OPEN SEASON FOR BEAVER AND OTTER

4. Beaver and otter may be trapped, hunted or possessed in the parts of Ontario described in,

- (a) Schedule 1 from the 5th day of October in any year to the 15th day of May in the year next following, both inclusive;
- (b) Schedule 2 from the 5th day of October in any year to the 22nd day of April in the year next following, both inclusive;
- (c) paragraph 1 of Schedule 3 from the 5th day of October in any year to the 31st day of March in the year next following, both inclusive;
- (d) paragraph 2 of Schedule 3 from the 15th day of October in any year to the 31st day of March in the year next following, both inclusive; and
- (e) Schedule 4 from the 25th day of October in any year to the 31st day of March in the year next following, both inclusive. O. Reg. 518/89, s. 1.

OPEN SEASON FOR BOBCAT, FISHER, LYNX, MARTEN AND WOLVERINE

5. Fisher and marten may be trapped, hunted or possessed in the parts of Ontario described in,

- (a) Schedules 1, 2 and 3 from the 25th day of October in any year to the last day of February in the year next following, both inclusive; and
- (b) Schedule 4 from the 25th day of October to the 31st day of December in any year, both inclusive. R.R.O. 1980, Reg. 427, s. 5.

6. Bobcat, lynx and wolverine may be trapped, hunted or possessed in any part of Ontario from the 25th day of October in any year to the last day of February in the year next following, both inclusive. R.R.O. 1980, Reg. 427, s. 6.

OPEN SEASON FOR MINK

7. Mink may be trapped, hunted or possessed in the parts of Ontario described in,

- (a) Schedule 1 from the 15th day of October in any year to the 31st day of January in the year next following, both inclusive;
- (b) Schedule 2 from the 15th day of October to the 31st day of December in any year, both inclusive;
- (c) paragraph 1 of Schedule 3 from the 15th day of October to the 31st day of December in any year, both inclusive; and
- (d) paragraph 2 of Schedule 3 and Schedule 4 from the 25th day of October to the 31st day of December in any year, both inclusive. R.R.O. 1980, Reg. 427, s. 7; O. Reg. 671/81, s. 2.

OPEN SEASON FOR MUSKRAT

8. Muskrat may be trapped, hunted or possessed in the parts of Ontario described in,

- (a) Schedule 1 from the 5th day of October in any year to the 31st day of May in the year next following, both inclusive;
- (b) Schedule 2 from the 5th day of October in any year to the 21st day of May in the year next following, both inclusive;
- (c) paragraph 1 of Schedule 3 from the 5th day of October in

any year to the 21st day of May in the year next following, both inclusive;

- (d) paragraph 2 of Schedule 3 from the 15th day of October in any year to the 21st day of May in the year next following, both inclusive;
- (e) paragraph 1 of Schedule 4 from the 25th day of October in any year to the 10th day of May in the year next following, both inclusive; and
- (f) paragraph 2 of Schedule 4 from the 25th day of October in any year to the 30th day of April in the year next following, both inclusive. R.R.O. 1980, Reg. 427, s. 8; O. Reg. 671/81, s. 3; O. Reg. 381/85, s. 2; O. Reg. 518/89, s. 2.

9. Muskrat may be trapped or possessed in the parts of Ontario described in,

- (a) paragraph 2 of Schedule 3; and
- (b) paragraph 1 of Schedule 4,

from the 15th day to the 24th day of October in any year, both inclusive, upon condition that only underwater traps known as funnel traps are used for trapping muskrat. O. Reg. 308/84, s. 1.

10.—(1) Muskrat may be trapped or possessed in the parts of Ontario described in Schedule 2 and paragraph 1 of Schedule 3 from the 5th day to the 24th day of October in any year, both inclusive.

(2) It is a condition of the trapping of muskrat under subsection (1) that only underwater traps known as funnel traps be used. O. Reg. 518/89, s. 3.

OPEN SEASON FOR BADGER

11. Badger may be trapped, hunted or possessed in the parts of Ontario described in Schedules 1, 2, 3 and 4 from the 25th day of October to the 31st day of December in any year, both inclusive. R.R.O. 1980, Reg. 427, s. 9.

OPEN SEASON FOR OPOSSUM

12. Opossum (*Didelphis marsupialis*) may be hunted or trapped, and the pelts thereof may be possessed, in any part of Ontario from the 25th day of October to the 31st day of December, both inclusive, in any year. O. Reg. 671/81, s. 4.

13. In this Regulation, a reference to a Schedule or to a paragraph of a Schedule is a reference to the Schedule or paragraph of a Schedule bearing the same number as the Schedules and paragraphs of Schedules set out in Regulation 427 of Revised Regulations of Ontario, 1980, as those Schedules and paragraphs of Schedules read on the 31st day of December, 1990. *New*.

REGULATION 511

OPEN SEASONS—GAME BIRDS

1. In this Regulation a reference to a numbered wildlife management unit is a reference to that unit as numbered and described in the Schedule to Revised Regulations of Ontario, 1990, Regulation 530. O. Reg. 156/82, s. 1.

2.—(1) In this Regulation, unless otherwise specified, wherever an open season is set out, the open season includes both the date of commencement and the date of termination. O. Reg. 501/81, s. 2.

(2) Where the day for beginning the open season mentioned in column 2 of Schedule 1, 2, 3, 4 or 5 to this Regulation is the 15th, 20th or 25th day of September and that day falls on a Sunday, the

open season begins on the preceding Saturday. O. Reg. 218/85, s. 1.

3. Except as provided in the regulations, the open seasons set out herein do not apply to provincial parks or Crown game preserves. O. Reg. 501/81, s. 3.

OPEN SEASON FOR HUNGARIAN PARTRIDGE

4. Subject to section 5, Hungarian partridge may be hunted in any wildlife management unit specified in column 1 of an item of Schedule 1 during the open season specified in column 2 of the item. O. Reg. 156/82, s. 2, *part*.

5. No person shall take more than eight Hungarian partridge in one day or possess more than sixteen Hungarian partridge at one time. O. Reg. 501/81, s. 5.

OPEN SEASON FOR RUFFED GROUSE, SPRUCE GROUSE, SHARP-TAILED GROUSE AND PTARMIGAN

6. Subject to section 7, ruffed grouse and spruce grouse may be hunted in any wildlife management unit specified in column 1 of an item of Schedule 2 during the open season specified in column 2 of the item. O. Reg. 156/82, s. 2, *part*.

7. No person shall take more than an aggregate number of five ruffed grouse and spruce grouse in one day, or possess more than an aggregate number of fifteen ruffed grouse and spruce grouse at one time. O. Reg. 501/81, s. 7.

8. Subject to section 9, sharp-tailed grouse and ptarmigan may be hunted in any wildlife management unit specified in column 1 of an

item of Schedule 3 during the open season specified in column 2 of the item. O. Reg. 156/82, s. 2, *part*.

9.—(1) No person shall take more than five sharp-tailed grouse in one day or possess more than fifteen sharp-tailed grouse at one time.

(2) No person shall take more than five ptarmigan in one day, or possess more than fifteen ptarmigan at one time. O. Reg. 501/81, s. 9.

OPEN SEASON FOR BOB-WHITE QUAIL

10. Subject to section 11, bob-white quail may be hunted in any wildlife management unit specified in column 1 of an item of Schedule 4 during the open season specified in column 2 of the item. O. Reg. 156/82, s. 2, *part*.

11. No person shall take more than three bob-white quail in one day, or possess more than six bob-white quail at one time. O. Reg. 501/81, s. 11.

OPEN SEASON FOR PHEASANT

12. Subject to section 13, pheasant may be hunted in any wildlife management unit specified in column 1 of an item of Schedule 5 during the open season specified in column 2 of the item and during the hours specified in column 3 of the item. O. Reg. 156/82, s. 2, *part*.

13. No person shall take, in one day, more than the number of pheasant of the sex specified in column 4 of an item of Schedule 5, or possess, at one time, more than the number of pheasant of the sex specified in column 5 of the item. O. Reg. 156/82, s. 2, *part*.

Schedule 1

HUNGARIAN PARTRIDGE

Item	COLUMN 1 Wildlife Management Units	COLUMN 2 Open Seasons
1.	13	From the fifteenth day of September to the second Saturday in November, in any year.
2.	55 to 59, inclusive, 61 to 67, inclusive, 69B	From the twentieth day of September to the second Saturday in November, in any year.
3.	60A, 68, 69A, 70 to 75, inclusive, 88, 89	From the twenty-fifth day of September to the second Saturday in November, in any year.
4.	87, 90	From the third Wednesday in October to the fifteenth day of December, in any year.
5.	76	From the third Saturday in October to the Friday next following, in any year.

O. Reg. 218/85, s. 2, *part*; O. Reg. 328/85, s. 1 (1); O. Reg. 260/89, s. 1.

Schedule 2

RUFFED GROUSE AND SPRUCE GROUSE

Item	COLUMN 1 Wildlife Management Units	COLUMN 2 Open Seasons
1.	1	From the fifth day of September to the last day in December, in any year.
2.	2 to 21, inclusive, 32 to 41, inclusive, 45	From the fifteenth day of September to the fifteenth day of December, in any year.
3.	22 to 31, inclusive	From the fifteenth day of September to the last day in December, in any year.
4.	42 to 44, inclusive, 46 to 50, inclusive, 53 to 59, inclusive	From the twentieth day of September to the fifteenth day of December, in any year.

Item	COLUMN 1 Wildlife Management Units	COLUMN 2 Open Seasons
5.	60A, 68, 69A, 70, 71	From the twenty-fifth day of September to the last day in December, in any year.
6.	61 to 67, inclusive, 69B	From the twentieth day of September to the last day in December, in any year.
7.	72 to 92, inclusive	From the twenty-fifth day of September in any year to the fifteenth day of January in the year next following.
8.	93	From the last Wednesday in October in any year to the fifteenth day of January in the year next following.

O. Reg. 218/85, s. 2, *part*; O. Reg. 328/85, s. 1 (2); O. Reg. 404/88, s. 1.

Schedule 3

SHARP-TAILED GROUSE AND PTARMIGAN

Item	COLUMN 1 Wildlife Management Units	COLUMN 2 Open Seasons
1.	1	From the fifth day of September in any year to the last day in March in the year next following.
2.	2 to 16, inclusive, 19, 20, 21, 32 to 39, inclusive, 41, 45	From the fifteenth day of September to the fifteenth day of December, in any year.
3.	17, 18, 22 to 31, inclusive, 40	From the fifteenth day of September in any year to the last day in March in the year next following.
4.	42 to 44, inclusive, 46 to 50, inclusive, 53 to 59, inclusive	From the twentieth day of September to the fifteenth day of December, in any year.
5.	60A, 68, 69A, 70, 71	From the twenty-fifth day of September to the last day in December, in any year.
6.	61 to 67, inclusive, 69B	From the twentieth day of September to the last day in December, in any year.

O. Reg. 218/85, s. 2, *part*; O. Reg. 328/85, s. 1 (3).

Schedule 4

BOB-WHITE QUAIL

Item	COLUMN 1 Wildlife Management Units	COLUMN 2 Open Seasons
1.	65	From the twentieth day of September to the fifteenth day of December, in any year.
2.	92	From the last Wednesday in October to the seventh day of November, in any year.

O. Reg. 218/85, s. 2, *part*.

Schedule 5

PHEASANT

Item	COLUMN 1 Wildlife Management Units	COLUMN 2 Open Seasons	COLUMN 3 Hours	COLUMN 4 Daily Limits	COLUMN 5 Possession Limits
1.	2 to 41, inclusive, 45	From the fifteenth day of September to the fifteenth day of December, in any year	½ hr. before sunrise to ½ hr. after sunset	3 of either sex	

Item	COLUMN 1 Wildlife Management Units	COLUMN 2 Open Seasons	COLUMN 3 Hours	COLUMN 4 Daily Limits	COLUMN 5 Possession Limits
2.	42 to 44, inclusive, 46 to 50, inclusive, 53 to 59, inclusive, 61 to 67, inclusive, 69B	From the twentieth day of September to the fifteenth day of December, in any year	½ hr. before sunrise to ½ hr. after sunset	3 of either sex	
3.	60A, 68, 69A, 70 to 77, inclusive, 81 to 86 inclusive	From the twenty-fifth day of September to the fifteenth day of December, in any year	½ hr. before sunrise to ½ hr. after sunset	3 of either sex	
4.	78	From the second Wednesday in October to the fifteenth day of December, in any year	8 a.m. to ½ hr. after sunset	3 of either sex	
5.	88	From the fourth Wednesday in October to the first Saturday in November, in any year	8 a.m. to ½ hr. after sunset	3 males	
6.	89, 90, 91, 92	From the third Wednesday in October to the fifteenth day of December, in any year	½ hr. before sunrise to ½ hr. after sunset	3 of either sex	
7.	79, 80, 87	From the third Wednesday in October to the fifteenth day of December, in any year	½ hr. before sunrise to ½ hr. after sunset	3, not more than 1 of which shall be female	
8.	93	From the last Wednesday in October to the fifteenth day of December, in any year	½ hr. before sunrise to ½ hr. after sunset	3, not more than 1 of which shall be female	
9.	94	From the last Wednesday in October to the Saturday next following, in any year	½ hr. before sunrise to ½ hr. after sunset	2 males	
10.	95	From the last Thursday in October to the Friday next following, from the first Thursday in November to the Friday next following and from the second Thursday in November to the Friday next following, in any year	8 a.m. to 5 p.m.	10 of either sex	10 of either sex
11.	95	From the first day of January to the last day of February, in any year	½ hr. before sunrise to ½ hr. after sunset	5 of either sex	5 of either sex

O. Reg. 192/83, s. 1, *part*; O. Reg. 508/84, s. 2; O. Reg. 782/84, s. 1; O. Reg. 218/85, s. 3; O. Reg. 328/85, s. 1 (4); O. Reg. 404/88, s. 2; O. Reg. 175/90, s. 1.

REGULATION 512

OPEN SEASONS—MOOSE AND DEER

1. This Regulation is subject to Revised Regulations of Ontario, 1990, Regulations 484 and 500 and does not apply to provincial parks other than that part of Algonquin Provincial Park situate in the geographic townships of Bruton and Clyde in the County of Haliburton. O. Reg. 137/83, s. 1.

2. In this Regulation, a reference to a numbered wildlife management unit is a reference to that unit as numbered and described in Schedule 1 to Revised Regulations of Ontario, 1990, Regulation 530. O. Reg. 157/82, s. 1.

3. In this Regulation, unless otherwise specified, whenever an

open season is set out, the open season includes both the date of commencement and the date of termination. R.R.O. 1980, Reg. 428, s. 3.

OPEN SEASON FOR MOOSE

4.—(1) In this section, "hunting in a party" means hunting in a party of two or more persons who each have a valid licence to hunt moose and who have agreed to hunt moose co-operatively during a period in an area that can reasonably be hunted by such persons during the period so that the intended objective of the hunt can be achieved.

(2) The holder of a resident's licence to hunt moose may hunt moose in a wildlife management unit specified in Column 1 of an item of Schedule 1 during the open season specified in Column 2 of the item.

(3) The holder of a non-resident's licence to hunt moose may hunt moose in a wildlife management unit specified in Column 1 of an item of Schedule 1 during the open season specified in Column 3 of the item.

(4) The holder of a resident's licence to hunt moose may hunt moose in a wildlife management unit specified in Column 1 of an item of Schedule 2 during the open season specified in Column 2 of the item subject to the conditions set out in Column 4 of the item.

(5) The holder of a non-resident's licence to hunt moose may hunt moose in a wildlife management unit specified in Column 1 of an item of Schedule 2 during the open season specified in Column 3 of the item subject to the conditions set out in Column 4 of the item.

(6) No holder of a licence to hunt moose shall take more than one moose. O. Reg. 83/86, s. 1, *part*.

(7) Subject to subsection (8), the holder of a licence in Form 3 or 8 of Revised Regulations of Ontario, 1990, Regulation 500 (Hunting Licences) who is authorized to hunt moose, may hunt moose in a party during the open season for moose, even if the holder has previously taken a moose during that open season and affixed to it the seal provided with the licence.

(8) Despite subsection (6), each person hunting in a party for moose may take as many moose as there are seals provided to the members of the party with their licences and not yet affixed to any moose if,

- (a) the total number of bull moose taken by the party does not exceed the total number of seals held by the members of the party licensed to hunt bull moose;
- (b) the total number of cow moose taken by the party does not exceed the total number of seals held by the members of the party licensed to hunt cow moose;
- (c) the total number of calf moose taken by the party does not exceed the total number of seals held by the members of the party licensed to hunt calf moose; and
- (d) the total number of moose taken by the party does not exceed the total number of seals held by the members of the party licensed to hunt moose. O. Reg. 570/88, s. 1.

OPEN SEASON FOR DEER

5. Subject to subsection 6 (4), no person shall during the open season therefor take more than one deer. R.R.O. 1980, Reg. 428, s. 6; O. Reg. 331/83, s. 1.

6.—(1) In this section and section 7,

- (a) "antlered deer" means a deer that has one or both antlers that are 7.5 centimetres or more in length;
- (b) "antlerless deer" means a deer that,
 - (i) does not have antlers, or
 - (ii) has antlers both of which are less than 7.5 centimetres in length;
- (c) "hunting in a party" means hunting in a party of two or more persons who each have a valid licence to hunt deer and who have agreed to hunt deer co-operatively during a period in an area that can reasonably be hunted by such persons during the period so that the intended objective of the hunt can be achieved.

(2) No person, other than the holder of a licence in Form 1 or 2 of Revised Regulations of Ontario, 1990, Regulation 500 that is valid for hunting antlerless deer, shall take antlerless deer or affix thereto the seal provided with his or her licence.

(3) Subject to subsection (4), the holder of a licence in Form 1, 2 or 7 of Revised Regulations of Ontario, 1990, Regulation 500 may hunt antlered deer while hunting in a party during the open season for deer in any part of Ontario.

(4) Where persons are hunting in a party for antlered deer, any one of such persons may take or possess the number of deer that may be hunted while hunting in a party that is equal to the number of seals provided with the licences to hunt deer and held by such persons, but the total number of deer taken or possessed by the persons hunting in a party shall not exceed the total number of such seals. O. Reg. 591/81, s. 1, *part*.

7. The holder of a licence in Form 1 or 2 of Revised Regulations of Ontario, 1990, Regulation 500 that is valid for hunting antlerless deer may hunt antlered deer during the open season therefor while hunting in a party after he or she has taken an antlerless deer and affixed thereto the seal provided with his or her licence. O. Reg. 591/81, s. 1, *part*.

8. The holder of a licence in Form 1 or 2 of Revised Regulations of Ontario, 1990, Regulation 500 may hunt deer in any wildlife management unit specified in Column 1 of an item of Schedule 3 during the open season specified in Column 2 of the item subject to the conditions set out in Column 4 of the item. O. Reg. 297/82, s. 1, *part*.

9.—(1) The holder of a licence in Form 1 or 2 of Revised Regulations of Ontario, 1990, Regulation 500 may hunt deer from the first Monday in November to the Thursday next following, both inclusive, in any year in the area described in Schedule 4.

(2) No person shall use or be accompanied by a dog while hunting deer in the area described in Schedule 4. O. Reg. 347/89, s. 1.

10. The holder of a licence in Form 7 of Revised Regulations of Ontario, 1990, Regulation 500 may hunt deer in any wildlife management unit specified in Column 1 of an item of Schedule 3 during the open season specified in Column 3 of the item subject to the conditions set out in Column 4 of the item. O. Reg. 297/82, s. 1, *part*.

11.—(1) A licence in Form 1 or 2 of Revised Regulations of Ontario, 1990, Regulation 500 is not valid for hunting deer in wildlife management units 53B, 69A-2, 70, 76A, 76B, 76C, 76D, 77A, 77B, 77C, 78A, 78B, 79A, 79C, 79D, 80A, 80B, 81A, 81B, 85A, 85B, 85C, 86A, 86B, 87B, 87C, 87D, 89A, 89B, 90A, 90B, 91A, 91B, 92A, 92B, 92C, 92D, 93A and 93B, unless a tag in Form 25 or 26 of Revised Regulations of Ontario, 1990, Regulation 500 is attached to the licence, and the tag is valid only during the period and in the wildlife management unit specified thereon. O. Reg. 512/88, s. 1 (1), *part*; O. Reg. 346/89, s. 1; O. Reg. 539/89, s. 1; O. Reg. 630/89, s. 1; O. Reg. 586/90, s. 1.

(2) A licence in Form 1 or 2 of Revised Regulations of Ontario, 1990, Regulation 500 is not valid for hunting deer in wildlife management unit 60B, unless the licence has annexed thereto a tag in Form 25 of Revised Regulations of Ontario, 1990, Regulation 500, and a tag in Form 25 is valid only from the first Monday in November to the Saturday next following or from the second Monday in November to the Saturday next following, as specified on the tag.

(3) No more than 500 people may be issued tags under subsection (2) and of those, no more than 250 people may be issued tags for each one-week period.

(4) The holder of a licence in Form 1 or 2 that is valid for hunting deer in wildlife management unit 60B shall,

- (a) if the holder arrives driving a motor vehicle, park it in a designated parking area; and
- (b) before leaving the wildlife management unit, report to the officer in charge at a station designated by the Ministry and produce for inspection deer killed by the holder of the licence. O. Reg. 326/85, s. 1 (1).

(5) The holder of a licence in Form 1 or 2 that is valid for hunting deer under subsection (1) or (2) shall complete the questionnaire provided with the tag in Form 25 or 26 of Revised Regulations of Ontario, 1990, Regulation 500 by the Ministry and return the questionnaire to the office of the Ministry specified thereon on or before the fourteenth day next following the closing day of the hunt. O. Reg. 512/88, s. 1 (2).

(6) Any person who refuses or neglects to return the completed questionnaire to the Ministry as required by subsection (5) and in accordance therewith is ineligible to receive a tag in Form 25 or 26 of Revised Regulations of Ontario, 1990, Regulation 500 in the year next following. O. Reg. 591/81, s. 2, *part*; O. Reg. 409/87, s. 1 (4).

Schedule 1

ITEM	COLUMN 1	COLUMN 2	COLUMN 3
	Wildlife Management Units	Open Seasons Residents	Open Seasons Non-Residents
1.	1A, 1C, 1D, 16A, 16B, 16C, 17, 18B, 25	September 15 to December 15	September 17 to November 15
2.	2, 3, 4, 5, 6, 8, 9A, 12A, 15A, 15B, 18A, 19, 21A, 21B	October 6 to December 15	October 8 to November 15
3.	7B, 9B, 11A, 11B, 12B, 13, 14	October 6 to December 15	
4.	22, 23, 24, 27, 28, 29, 30, 31, 32, 33, 34, 35, 36, 37, 38, 39, 40, 41, 42	October 6 to November 15	October 8 to November 15
5.	26	September 22 to October 31	September 24 to October 31
6.	45	October 8 to October 10	
7.	46, 47, 48, 49, 50, 53, 54, 55A, 55B, 56, 57, 58, 59, 60A, 61, 62, 63	October 15 to October 20	

O. Reg. 434/90, s. 1.

Schedule 2

ITEM	COLUMN 1	COLUMN 2	COLUMN 3	COLUMN 4
	Wildlife Management Units	Open Seasons Residents	Open Seasons Non-Residents	Conditions
1.	7A	October 6 to December 15	October 8 to November 15	Only bows and arrows or flint-lock or percussion cap muzzle-loading guns may be used.
2.	2, 3, 4, 5, 6, 8, 9A, 12A, 15A, 15B, 18A, 19, 21A, 21B, 23, 29, 38	September 15 to October 5	September 15 to October 5	Only bows and arrows may be used.
3.	7B, 9B, 12B, 13, 14	September 15 to October 5		Only bows and arrows may be used.

O. Reg. 434/90, s. 2.

Schedule 3

DEER

ITEM	COLUMN 1	COLUMN 2	COLUMN 3	COLUMN 4
	Wildlife Management Units	Open Seasons Residents	Open Seasons Non-Residents	Conditions
1.	6, 7B, 9A, 9B	September 15 to September 28	September 15 to September 28	Only bows and arrows may be used. No person shall use or be accompanied by a dog.
2.	6, 7B, 9A, 9B	September 29 to October 5	September 29 to October 5	Only flint-lock or percussion cap muzzle-loading guns or bows and arrows may be used. No person shall use or be accompanied by a dog.

ITEM	COLUMN 1	COLUMN 2	COLUMN 3	COLUMN 4
	Wildlife Management Units	Open Seasons Residents	Open Seasons Non-Residents	Conditions
3.	6, 7B, 9A, 9B, 11A	October 6 to December 15	October 6 to November 15	
4.	7A	October 6 to December 15	October 6 to November 15	Only flint-lock or percussion cap muzzle-loading guns or bows and arrows may be used.
5.	8	September 29 to October 12		Only bows and arrows may be used. No person shall use or be accompanied by a dog.
6.	8	October 13 to November 2		Only flint-lock or percussion cap muzzle-loading guns or bows and arrows may be used. No person shall use or be accompanied by a dog.
7.	8	November 3 to December 15		No person shall use or be accompanied by a dog.
8.	10	September 29 to November 2	September 29 to November 2	Only bows and arrows may be used. No person shall use or be accompanied by a dog.
9.	10	November 3 to December 15	November 3 to November 15	No person shall use or be accompanied by a dog.
10.	11A	September 22 to October 5	September 22 to October 5	Only flint-lock or percussion cap muzzle-loading guns or bows and arrows may be used. No person shall use or be accompanied by a dog.
11.	11B, 12A, 12B, 13, 14, 21A	October 6 to December 15		
12.	14	September 15 to October 5		Only bows and arrows may be used. No person shall use or be accompanied by a dog.
13.	36, 37, 38, 46, 47, 48, 49, 50, 53A, 54, 55A, 55B, 56, 57, 58, 59, 60A, 61, 62, 63	November 5 to November 17	November 5 to November 17	
14.	37	October 20 to November 4	October 20 to November 4	Only bows and arrows may be used. No person shall use or be accompanied by a dog.
15.	39, 41, 42	November 5 to November 17		
16.	42	October 6 to November 2	October 6 to November 2	Only bows and arrows may be used. No person shall use or be accompanied by a dog.
17.	43A, 43B	October 6 to November 11	October 6 to November 11	Only bows and arrows may be used. No person shall use or be accompanied by a dog.
18.	43A, 43B	November 19 to November 23	November 19 to November 23	No person shall use or be accompanied by a dog.
19.	44	November 5 to November 17		No person shall use or be accompanied by a dog.
20.	45	October 27 to November 2	October 27 to November 2	Only bows and arrows may be used. No person shall use or be accompanied by a dog.
21.	45	November 5 to November 9	November 5 to November 9	No person shall use or be accompanied by a dog.

ITEM	COLUMN 1	COLUMN 2	COLUMN 3	COLUMN 4
	Wildlife Management Units	Open Seasons Residents	Open Seasons Non-Residents	Conditions
22.	47	October 15 to November 4 and November 19 to December 1	October 15 to November 4 and November 19 to December 1	Only bows and arrows may be used. No person shall use or be accompanied by a dog.
23.	48, 57, 60A	October 15 to November 4	October 15 to November 4	Only bows and arrows may be used. No person shall use or be accompanied by a dog.
24.	53A	November 19 to December 1	November 19 to December 1	Only bows and arrows may be used. No person shall use or be accompanied by a dog.
25.	55A, 55B	November 18 to December 20	November 18 to December 20	Only bows and arrows may be used. No person shall use or be accompanied by a dog.
26.	58, 59	October 15 to November 4 and November 18 to November 30	October 15 to November 4 and November 18 to November 30	Only bows and arrows may be used. No person shall use or be accompanied by a dog.
27.	61, 62, 63	October 15 to November 4 and November 18 to December 15	October 15 to November 4 and November 18 to December 15	Only bows and arrows may be used. No person shall use or be accompanied by a dog.
28.	64, 65, 66A, 67, 69B	October 15 to November 4 and November 11 to December 15	October 15 to November 4 and November 11 to December 15	Only bows and arrows may be used. No person shall use or be accompanied by a dog.
29.	64, 66A, 67, 68, 74	November 5 to November 10	November 5 to November 10	
30.	65	November 5 to November 10	November 5 to November 10	Only flint-lock or percussion cap muzzle-loading guns or bows and arrows or shotguns may be used. No person shall use or be accompanied by a dog.
31.	66B	November 5 to November 11	November 5 to November 11	Only bows and arrows may be used. No person shall use or be accompanied by a dog.
32.	68, 71, 74	October 15 to November 4 and November 11 to December 31	October 15 to November 4 and November 11 to December 31	Only bows and arrows may be used. No person shall use or be accompanied by a dog.
33.	69B	November 5 to November 10	November 5 to November 10	Only flint-lock or percussion cap muzzle-loading guns or bows and arrows or shotguns may be used.
34.	69A-1, 69A-3, 72B	October 15 to December 31	October 15 to December 31	Only bows and arrows may be used. No person shall use or be accompanied by a dog.
35.	70	December 3 to December 6		Only shotguns may be used. No person shall use or be accompanied by a dog.
36.	71	November 5 to November 10		Only shotguns may be used. No person shall use or be accompanied by a dog.
37.	72A, 73, 75	October 15 to November 4 and November 9 to December 31	October 15 to November 4 and November 9 to December 31	Only bows and arrows may be used. No person shall use or be accompanied by a dog.
38.	72A, 73, 75	November 5 to November 8		Only shotguns or flint-lock or percussion cap muzzle-loading guns may be used. No person shall use or be accompanied by a dog.

ITEM	COLUMN 1	COLUMN 2	COLUMN 3	COLUMN 4
	Wildlife Management Units	Open Seasons Residents	Open Seasons Non-Residents	Conditions
39.	76A	November 5 to November 9 and December 3 to December 7		Only rifles, shotguns or flint-lock or percussion cap muzzle-loading guns may be used. No person shall use or be accompanied by a dog.
40.	76B, 76C, 76D, 77A, 77B, 77C, 78A, 78B, 81A, 81B, 90A, 90B, 91A, 91B	November 5 to November 9 and December 3 to December 7		Only shotguns or flint-lock or percussion cap muzzle-loading guns may be used. No person shall use or be accompanied by a dog.
41.	76A, 76B, 76C, 76D, 77A, 77B, 77C, 78A, 78B, 81A, 81B, 90A, 90B, 91A, 91B, 92A, 92B, 92C, 92D	October 15 to November 4 and November 10 to December 2 and December 8 to December 31		Only bows and arrows may be used. No person shall use or be accompanied by a dog.
42.	78C, 78D, 78E, 79B, 87A, 87E, 88, 94A	October 15 to December 31		Only bows and arrows may be used. No person shall use or be accompanied by a dog.
43.	53B, 79A, 79C, 79D, 80A, 80B, 85A, 85B, 85C, 87B, 87C, 87D	November 5 to November 8		Only shotguns or flint-lock or percussion cap muzzle-loading guns may be used. No person shall use or be accompanied by a dog.
44.	79A, 79C, 79D, 80A, 80B, 85A, 85B, 85C, 87B, 87C, 87D	October 15 to November 4 and November 9 to December 31		Only bows and arrows may be used. No person shall use or be accompanied by a dog.
45.	86A, 86B, 93A, 93B	December 3 to December 6		Only shotguns or flint-lock or percussion cap muzzle-loading guns may be used. No person shall use or be accompanied by a dog.
46.	86, 93A, 93B	October 15 to December 2 and December 7 to December 31		Only bows and arrows may be used. No person shall use or be accompanied by a dog.
47.	89A, 89B	November 5 to November 8 and December 3 to December 6		Only shotguns or flint-lock or percussion cap muzzle-loading guns may be used. No person shall use or be accompanied by a dog.
48.	89A, 89B	October 15 to November 4 and November 9 to December 2 and December 7 to December 31		Only bows and arrows may be used. No person shall use or be accompanied by a dog.
49.	92A, 92B, 92C, 92D	November 5 to November 9 and December 3 to December 7		Only flint-lock or percussion cap muzzle-loading guns may be used. No person shall use or be accompanied by a dog.
50.	94B	October 15 to November 4 and November 7 to December 31		Only bows and arrows may be used. No person shall use or be accompanied by a dog.
51.	94B	November 5 to November 6		Only shotguns or flint-lock or percussion cap muzzle-loading guns may be used. No person shall use or be accompanied by a dog.
52.	82A, 82B, 84	October 15 to November 4 and November 10 to December 31		Only bows and arrows may be used. No person shall use or be accompanied by a dog.
53.	82A, 82B, 84	November 5 to November 9	November 5 to November 9	No person shall use or be accompanied by a dog.

ITEM	COLUMN 1	COLUMN 2	COLUMN 3	COLUMN 4
	Wildlife Management Units	Open Seasons Residents	Open Seasons Non-Residents	Conditions
54.	83A	October 6 to November 4 and November 11 to December 2 and December 7 to December 15		Only bows and arrows may be used. No person shall use or be accompanied by a dog.
55.	83A	November 5 to November 10	November 5 to November 10	No person shall use or be accompanied by a dog.
56.	82, 83A	December 3 to December 6	December 3 to December 6	Only flint-lock or percussion cap muzzle-loading guns may be used. No person shall use or be accompanied by a dog.
57.	83B	October 15 to December 31	October 15 to December 31	
58.	83C	October 15 to November 4	October 15 to November 4	
59.	69A-2	October 15 to November 25 and November 30 to December 31	October 15 to November 25 and November 30 to December 31	Only bows and arrows may be used. No person shall use or be accompanied by a dog.
60.	69A-2	November 26 to November 29		Only shotguns may be used. No person shall use or be accompanied by a dog.

O. Reg. 329/90, s. 1; O. Reg. 586/90, s. 2.

Schedule 4

That part of the Territorial District of Timiskaming described as follows:

Beginning at the intersection of the interprovincial boundary between the Provinces of Ontario and Quebec with the centre line of the King's Highway No. 66;

Thence westerly along that centre line to its intersection with the centre line of the King's Highway No. 11;

Thence southeasterly along that centre line to its intersection with the centre line of the King's Highway No. 66;

Thence westerly along that centre line to its intersection with the centre line of the Englehart River;

Thence southwesterly along the centre line of the Englehart River, Kushog Lake, Kinogami Lake and Robillard Lake to its intersection with the westerly boundary of the geographic Township of Robillard;

Thence southerly along the westerly boundary of the geographic townships of Robillard, Bryce and Cane to the southwest corner of the geographic Township of Cane;

Thence easterly along the southerly boundary of the geographic townships of Cane, Henwood, Kerns, Harley and Casey to its intersection with the interprovincial boundary between the Provinces of Ontario and Quebec;

Thence northerly along the interprovincial boundary to the place of beginning;

Except that portion of the geographic Township of Cane lying westerly of the centre line of the Montreal River. O. Reg. 347/89, s. 2.

REGULATION 513

OPEN SEASONS—RABBITS AND SQUIRRELS

1. In this Regulation, a reference to a wildlife management unit is a reference to that unit as numbered and described in the Schedule to Revised Regulations of Ontario, 1990, Regulation 530. O. Reg. 171/82, s. 1.

2.—(1) In this Regulation, unless otherwise specified, wherever an open season is set out, the open season includes both the date of commencement and the date of termination.

(2) The open seasons set out herein do not apply to provincial parks or Crown game preserves. O. Reg. 421/81, s. 2 (1, 2).

(3) If a 15th, 20th or 25th day of September mentioned in Column 2 of Schedule 1 or 2 is a Sunday, the open season begins on the preceding Saturday. O. Reg. 213/85, s. 1.

OPEN SEASON FOR RABBITS

3. Subject to section 4, rabbits may be hunted or trapped in a wildlife management unit specified in Column 1 of an item of Schedule 1 during the open season specified in Column 2 of the item. O. Reg. 171/82, s. 2.

4.—(1) No person shall take more than,

(a) six cottontail rabbits; and

(b) six European hares,

in one day. O. Reg. 421/81, s. 4 (1).

(2) No person shall take, in one day, more than six varying hare in wildlife management units 60 to 95, both inclusive. O. Reg. 171/82, s. 3.

OPEN SEASON FOR SQUIRRELS

5. Subject to section 6, black, grey or fox squirrels may be hunted or trapped in a wildlife management unit specified in Column 1 of an item of Schedule 2 during the open season specified in Column 2 of the item. O. Reg. 171/82, s. 4.

6.—(1) No person shall take, in one day more squirrels in the aggregate than the number specified in Column 3 of an item of Schedule 2. O. Reg. 171/82, s. 5.

(2) No person shall possess more than an aggregate number of ten squirrels at one time. O. Reg. 421/81, s. 6 (2).

Schedule 1

Rabbits (Cottontail, Varying Hare, European Hare)

ITEM	COLUMN 1	COLUMN 2
	Wildlife Management Units	Open Seasons
1.	1 to 50, inclusive, 53 to 59, inclusive	From the first day of September in any year to the fifteenth day of June in the year next following.
2.	60A, 68, 69A, 70, 71, 74, 75	From the twenty-fifth day of September in any year to the last day of March in the year next following.
3.	61 to 67, inclusive, 69B	From the twentieth day of September in any year to the last day of March in the year next following.
4.	72, 73, 76, 77, 81 to 86, inclusive	From the twenty-fifth day of September in any year to the last day of February in the year next following.
5.	78, 79, 80, 87, 90, 91 and 92	From the third Wednesday in October in any year to the last day of February in the year next following.
6.	88, 89	From the fourth Wednesday in October in any year to the last day of February in the year next following.
7.	93, 94	From the last Wednesday in October in any year to the last day of February in the year next following.
8.	95	From the first day of January to the last day of February in any year.

O. Reg. 213/85, s. 2; O. Reg. 321/85, s. 1.

Schedule 2

Black, Grey and Fox Squirrels

ITEM	COLUMN 1	COLUMN 2	COLUMN 3
	Wildlife Management Units	Open Seasons	Daily Limit
1.	36 to 41, inclusive, 45	From the fifteenth day of September to the fifteenth day of December, in any year.	10

ITEM	COLUMN 1	COLUMN 2	COLUMN 3
	Wildlife Management Units	Open Seasons	Daily Limit
2.	42 to 44, inclusive, 46 to 50, inclusive, 53 to 59, inclusive, 61 to 67, inclusive, 69B	From the twentieth day of September to the fifteenth day of December, in any year.	10
3.	60A, 68, 69A, 70 to 92, inclusive	From the twenty-fifth day of September to the fifteenth day of December, in any year.	5
4.	93, 94	From the last Wednesday in October to the seventh day of November, in any year.	5

O. Reg. 213/85, s. 3; O. Reg. 321/85, s. 2.

REGULATION 514

OPEN SEASONS—SNAPPING TURTLES

1.—(1) In this Regulation,

“non-resident licensee” means a holder of a licence in Form 13 (Non-Resident/Canadian Resident Angling Licence) of Regulation 490 of Revised Regulations of Ontario, 1990 (Fishing Licences) to which a tag in Form 14 (Non-Resident Four Day Angling Tag), Form 15 (Non-Resident Twenty-One Day Angling Tag) or Form 16 (Non-Resident Seasonal Angling Tag) of the said Regulation is affixed;

“resident licensee” means a holder of a licence in Form 1 (Ontario Resident Sport Fishing Licence) of Regulation 490 of Revised Regulations of Ontario, 1990 (Fishing Licences) to which a tag in Form 2 (Ontario Resident Four Day Sport Fishing Tag) or Form 3 (Ontario Resident Seasonal Sport Fishing Tag) of the said Regulation is affixed.

(2) In this Regulation, a reference to a numbered wildlife management unit is a reference to that unit as numbered and described in the Schedule to Regulation 530 of Revised Regulations of Ontario, 1990 (Wildlife Management Units). O. Reg. 88/90, s. 1.

2. A resident licensee may hunt snapping turtles for personal use in a wildlife management unit specified in Column 1 of the Schedule during the open season specified for the unit in Column 2. O. Reg. 88/90, s. 2.

3. A non-resident licensee may hunt snapping turtles for personal use in a wildlife management unit specified in Column 1 of the Schedule during the open season specified in Column 3. O. Reg. 88/90, s. 3.

4. No person shall take more than two snapping turtles a day. O. Reg. 88/90, s. 4.

5. No person shall possess more than five snapping turtles. O. Reg. 88/90, s. 5.

Schedule

ITEM	COLUMN 1	COLUMN 2	COLUMN 3
	Wildlife Management Units	Open Season (Residents)	Open Season (Non-Residents)
1.	2 to 45	Year Round	Year Round
2.	61 and 62	Year Round	July 15 to September 15
3.	46 to 50 53 to 60 63 to 95	July 15 to September 15	July 15 to September 15

O. Reg. 88/90, Sched.

REGULATION 515**ORANGEVILLE RESERVOIR HUNTING AREA**

1. The lands in respect of which an agreement has been entered into under section 6 of the Act and described in the Schedule are designated in accordance with paragraph 33 of section 92 of the Act. R.R.O. 1980, Reg. 429, s. 1.

2. Except as provided in this Regulation, no person shall hunt any animal or bird in the area described in the Schedule. R.R.O. 1980, Reg. 429, s. 2.

3. The holder of a licence in Form 5 of Regulation 500 of Revised Regulations of Ontario, 1990 may hunt ducks, geese, rails, coots, snipe and gallinules during the open season therefor on any Tuesday or Thursday during the hours between 4 p.m. and one-half hour after sunset and on any Saturday during the hours between one-half hour before sunrise and noon, in the area described in the Schedule, if,

- (a) the holder of the licence parks any motor vehicle in which he or she arrives at the area described in the Schedule in a designated parking area;
- (b) the holder of the licence hunts from within a hunting area the radius of which is not more than ten metres from a stake planted by an officer of the Ministry of Natural Resources;
- (c) the area from which the holder of the licence hunts is occupied by no more than one other person; and
- (d) the holder of the licence keeps his or her firearm unloaded and encased except while occupying a hunting area. O. Reg. 595/83, s. 1.

4. In this Regulation, a reference to the Schedule is a reference to the Schedule to Regulation 429 of Revised Regulations of Ontario, 1980, as that Schedule read on December 31, 1990. *New.*

REGULATION 516**PETROGLYPHS PROVINCIAL PARK HUNTING AREA**

1. Except as provided in this Regulation, no person shall hunt any

animal or bird in any area described in the Schedule. O. Reg. 646/81, s. 1.

2. Regulation 512 of Revised Regulations of Ontario, 1990 applies to this Regulation except in so far as such Regulation is modified by this Regulation. O. Reg. 646/81, s. 2.

3.—(1) The holder of a licence in Form 1 or 2 of Regulation 500 of Revised Regulations of Ontario, 1990 may hunt deer from the third Saturday in October to the last day in October, both inclusive, in any year in the area described in the Schedule, if,

- (a) he or she obtains a licence in Form 1; and
- (b) there are not more than ninety-nine other persons hunting in the area described in the Schedule.

(2) An application for a licence in Form 1 shall be in Form 2.

(3) A licence in Form 1 authorizes the hunter to hunt antlered or antlerless deer in the area described in the Schedule and is valid for the dates mentioned therein. O. Reg. 646/81, s. 3.

4.—(1) Subject to Regulation 479 of Revised Regulations of Ontario, 1990, only bows and arrows, other than crossbows, may be used while hunting deer in the area described in the Schedule.

(2) No person shall use or be accompanied by a dog while hunting deer in the area described in the Schedule. O. Reg. 646/81, s. 4.

5.—(1) The holder of a licence in Form 1 or 2 of Regulation 500 of Revised Regulations of Ontario, 1990 that is valid for hunting deer in the area described in the Schedule shall complete the questionnaire provided with the licence in Form 1 and return the questionnaire to the office of the Ministry specified thereon within twenty-one days after the last day for which the licence is issued.

(2) Any person who refuses or neglects to return the completed questionnaire to the Ministry as required by subsection (1) and in accordance therewith is ineligible to receive a licence in Form 1 in the year next following. O. Reg. 646/81, s. 5.

Schedule

Petroglyphs Provincial Park, excepting those parts thereof that are posted with signs prohibiting hunting. O. Reg. 646/81, Sched.

Form 1

Game and Fish Act

PETROGLYPHS PROVINCIAL PARK HUNTING AREA

Free Archery Licence to Hunt Deer and Antlerless Deer Tag—Licence #

Under the Game and Fish Act and the regulations and subject to the limitations thereof, this licence is issued to:

Mr.
Ms.
Miss
Mrs.
(Last Name) (First Name) (Initial)

of
(Street Address, P.O. Box, or Rural Route) (City, Town or Village)

being the holder of valid licence number
(Resident or Farmer's Licence to Hunt Deer in 19....)

to hunt antlered and antlerless deer in the area described in the Schedule to Regulation 516 of Revised Regulations of Ontario, 1990

on
(date(s) of authorization)

This licence expires with the

.....
(Signature of Issuer) (Date of Issue) (Signature of Licensee)

O. Reg. 646/81, Form 1.

Form 2

Game and Fish Act

PETROGLYPHS PROVINCIAL PARK HUNTING AREA

Application for an Archery Licence to Hunt Deer—Application #

Mr.
Ms.
Miss
Mrs.
(Last Name) (First Name) (Initial)

of
(Street Address, P.O. Box, or Rural Route) (City, Town or Village)

being the holder of a Resident or Farmer's Licence to hunt deer issued in 19....., Licence Serial Number

requests authorization to hunt on
(date(s) requested—3 days only)

(a) Alone, or

(b) With the following hunting party:

- 1.
2.
3.
4.
5.

(Names, Addresses, Hunting Licence #'s of other hunters in party)

.....
(date) (Signature of Applicant)

Approved

Office use only:

Licence number(s) assigned.

O. Reg. 646/81, Form 2.

REGULATION 517

POLAR BEARS

1. The holder of a licence in Form 3 of Regulation 492 of Revised Regulations of Ontario, 1990 may,

- (a) take or kill a polar bear in defence of the person's property on the area described in the licence; and
- (b) sell the pelt of the polar bear taken in accordance with clause (a), provided that the pelt is sealed in the manner set out in section 10 of Regulation 492 of Revised Regulations of Ontario, 1990. R.R.O. 1980, Reg. 431, s. 1.

REGULATION 518

PROHIBITION OF HUNTING AND POSSESSION OF FIREARMS

1.—(1) No person shall, for the purpose of hunting in the areas described in Schedules 1 and 2 to Ontario Regulation 614/88, as those Schedules read on December 31, 1990,

- (a) possess a firearm, except where the firearm is unloaded and encased; or
- (b) use a firearm. O. Reg. 614/88, s. 1, *revised*.

(2) In this section, "thoroughfare" means the King's Highway or a secondary highway or what is commonly known as a county road, a regional road or an improved local municipal road.

(3) No person, for the purpose of hunting, shall possess a loaded firearm while on or within eight metres of the travelled portion of a thoroughfare unless,

- (a) the person is on privately owned property; or
- (b) there is, between the person and the travelled portion of the thoroughfare, a fence that demarcates the boundary between the thoroughfare and the adjoining land.

(4) No person, for the purpose of hunting, shall possess a loaded firearm while the person is between a thoroughfare and a fence that demarcates the boundary between the thoroughfare and the adjoining land.

(5) This section applies only in a county or regional municipality described in Schedule 1 or 2 to Ontario Regulation 603/89 as it read on the 31st day of December, 1990 (Discharge of Firearms From or Across Highways and Roads).

(6) This section applies in a county or regional municipality described in Schedule 2 to Ontario Regulation 603/89 as it read on the 31st day of December, 1990 (Discharge of Firearms From or Across Highways and Roads) only during an open season for deer in that county or regional municipality other than a season during which only bows and arrows may be used to hunt deer. O. Reg. 604/89, s. 1.

REGULATION 519

REPORTING AND REGISTERING POSSESSION OF CERTAIN GAME

1. In this Regulation,

"carcass" includes any part of a carcass;

"report" means a communication, in person or by telephone, by a person who is required to make a report under subsection 2 (1) advising of,

- (a) the name and address of the reporter,
- (b) the species and number of carcasses acquired, and
- (c) the date, place and circumstances of the acquisition;

"working day" means any day other than a Saturday or a holiday. O. Reg. 217/86, s. 1.

2.—(1) Every person who acquires a carcass of a black bear, caribou, deer, elk, moose, eagle, falcon, hawk, owl, vulture or fur-bearing animal shall report the acquisition within the time set out in subsection (2) to the district manager of the administrative district of the Ministry in which the carcass was acquired.

(2) For the purpose of subsection (1), the acquisition of a carcass of a black bear, deer or moose must be reported immediately and the acquisition of a carcass of any other animal or bird referred to in subsection (1) must be reported within two working days after the acquisition.

(3) Every person who acquires a carcass of an eagle, falcon, hawk, owl or vulture shall take the carcass to an office of an administrative district of the Ministry within five working days after the acquisition for registration by an official of the Ministry.

(4) Subsections (1) and (3) do not apply to,

- (a) a person who lawfully kills, traps or possesses an animal or bird under the authority of a licence or subsection 62 (7) of the Act;
- (b) a person who received the carcass, other than the carcass of a fur-bearing animal, as a gift from a person described in clause (a); or
- (c) a person who is engaged commercially in taxidermy and who has received the carcass from a person described in clause (a) or (b) or from a person who has reported the acquisition under subsection (1).

(5) Every person who makes a report under subsection (1) with respect to a carcass of a fur-bearing animal is entitled to receive from the district manager a licence referred to in section 65 of the Act in respect of the carcass reported.

(6) Despite subsection (5), no person who acquired a carcass by unlawfully killing or trapping the animal is entitled to a licence under subsection (5). O. Reg. 217/86, s. 2.

3.—(1) Every person who is engaged commercially in taxidermy shall keep a register and record therein,

- (a) the name and address of every person from whom the taxidermy

dermist receives an animal or bird carcass and the date on which the carcass is received;

- (b) the species and number of carcasses received;
- (c) if a certificate of a report under subsection 2 (1) is provided by a person referred to in clause (a), particulars of the certificate or, if no certificate is provided, a notation of that fact and a notation of the authority under which the animal or bird was taken; and
- (d) if a licence to possess a fur-bearing animal is provided, particulars of the licence.

(2) Every person who is required to keep a register under subsection (1) shall submit to an officer, on request, a report setting out the information in the register. O. Reg. 217/86, s. 3.

REGULATION 520

REPTILES

1. The following species and subspecies of Reptilia are declared to be reptiles:

1. *Clemmys guttata*, commonly known as spotted turtle.
2. *Clemmys insculpta*, commonly known as wood turtle.
3. *Chrysemys picta belli*, commonly known as western painted turtle.
4. *Chrysemys picta marginata*, commonly known as Midland painted turtle.
5. *Emydoidea blandingii*, commonly known as Blanding's turtle.
6. *Graptemys geographica*, commonly known as map turtle.
7. *Sternotherus odoratus*, commonly known as musk turtle.
8. *Trionyx spiniferus spiniferus*, commonly known as eastern spiny softshell.
9. *Regina septemvittata*, commonly known as queen snake.
10. *Heterodon platyrhinos*, commonly known as eastern hog-nose snake.
11. *Elaphe obsoleta obsoleta*, commonly known as black rat snake.
12. *Elaphe vulpina gloydi*, commonly known as eastern fox snake.
13. *Coluber constrictor foxi*, commonly known as blue racer.
14. *Nerodia sipedon insularum*, commonly known as Lake Erie water snake.
15. *Nerodia sipedon sipedon*, commonly known as northern water snake.
16. *Crotalus horridus horridus*, commonly known as timber rattlesnake.
17. *Chelydra serpentina*, commonly known as snapping turtle.
18. *Thamnophis butleri* (Cope), commonly known as Butler's garter snake.
19. *Sistrurus catenatus catenatus* (Rafinesque), commonly

known as eastern massasauga. O. Reg. 397/84, s. 1; O. Reg. 113/88, s. 1; O. Reg. 87/90, s. 1; O. Reg. 263/90, s. 1.

REGULATION 521

SALE OF BASS AND TROUT AND FISHING PRESERVES

SALE OF BASS AND TROUT

1. A licence under subsection 72 (1) of the Act shall be in Form 1 in respect of bass or trout propagated in Ontario and in Form 2 in respect of the sale for human consumption of,

- (a) trout taken from waters outside Ontario;
- (b) live trout propagated in Ontario and offered for sale in restaurants and retail stores; or
- (c) surplus stocks of trout held by the licensee under a fishing preserve licence. R.R.O. 1980, Reg. 433, s. 1.

2. An application for a licence in Form 1 shall be in Form 3 and an application for a licence in Form 2 shall be in Form 4. R.R.O. 1980, Reg. 433, s. 2.

3. The fee for a licence in Form 1 is \$41. R.R.O. 1980, Reg. 433, s. 3; O. Reg. 755/84, s. 1; O. Reg. 619/89, s. 1.

4. A licence in Form 1 shall be issued only in respect of a parcel of land owned or leased by the applicant and containing,

- (a) an artificial body of water lying wholly within such parcel of land, containing water from surface run-off, natural springs, ground water or water diverted or pumped from a stream or lake, but not being composed of natural streams, ponds or lakes or water impounded by the damming of natural streams;
- (b) a natural pond or lake the bed of which is owned by the applicant and from which no water flows into any other natural body of water;
- (c) the source of a natural stream; or
- (d) waters that were in 1970 licensed under a licence to sell largemouth bass, smallmouth bass, brook trout or rainbow trout for the purpose of stocking. R.R.O. 1980, Reg. 433, s. 4.

5.—(1) Every person who sells for human consumption a brook trout or rainbow trout in respect of which the person has a bill of sale or other evidence of the purchase referred to in section 10 is deemed to be the holder of a licence to sell trout.

(2) Section 11 does not apply to a person mentioned in subsection (1). R.R.O. 1980, Reg. 433, s. 5.

6. A licence in Form 1 or Form 2 is valid only for the species of fish specified in the licence. R.R.O. 1980, Reg. 433, s. 6.

7. The holder of a licence in Form 1 shall not sell a fish mentioned in the licence that has not been taken from the waters on the land in Ontario that is specified in the licence. R.R.O. 1980, Reg. 433, s. 7.

8. The holder of a licence in Form 1 shall not sell any fish taken from the waters on the land specified in the licence if any fish in the waters is infected with organisms causing bacterial kidney disease, infectious pancreatic necrosis, viral hemorrhagic septicemia, infectious hematopoietic necrosis or whirling disease. R.R.O. 1980, Reg. 433, s. 8.

9.—(1) A licence in Form 1 expires with the 31st day of December next following the date of issue.

(2) A licence in Form 2 expires with the 31st day of December next following the date of issue or such earlier date as may be specified in the licence. R.R.O. 1980, Reg. 433, s. 9.

10.—(1) The holder of a licence in Form 1 or in Form 2 shall not sell brook or rainbow trout for human consumption unless at the time of the sale the holder of the licence delivers to the purchaser a bill of sale or other evidence of the purchase in a form supplied by the Ministry of Natural Resources.

(2) The bill of sale or other evidence of the purchase referred to in subsection (1) shall be retained by the purchaser for as long as the fish described therein are in the purchaser's possession and the purchaser shall produce the bill of sale or other evidence of the purchase and show it to any officer whenever requested by the officer. R.R.O. 1980, Reg. 433, s. 10.

11. The holder of a licence in Form 1 shall not sell bass or trout for stocking unless the holder has obtained or the purchaser produces a licence in Form 8 authorizing the transporting and stocking of fish. O. Reg. 619/89, s. 2.

FISHING PRESERVES

12. A licence to own or operate a fishing preserve shall be in Form 6 and the fee therefor is \$82. R.R.O. 1980, Reg. 433, s. 12; O. Reg. 755/84, s. 2; O. Reg. 619/89, s. 3.

13. An application for a licence in Form 6 shall be in Form 7. R.R.O. 1980, Reg. 433, s. 13.

14. A licence in Form 6 expires with the 31st day of December next following the date of issue. R.R.O. 1980, Reg. 433, s. 14.

15.—(1) No person shall remove from a fishing preserve any brook trout or rainbow trout,

- (a) during the closed season therefor; or
(b) in excess of the daily catch limit,

unless the person has in possession and retains in possession for as long as the trout is in the person's possession, a document given to the person by the owner or operator of the fishing preserve evidencing that the trout was taken on the preserve.

(2) The document mentioned in subsection (1) shall be in a form supplied by the Ministry of Natural Resources. R.R.O. 1980, Reg. 433, s. 15.

16. A fishing preserve in respect of which an application under section 13 of this Regulation has not been made is exempt from section 73 of the Act and sections 12 to 15 of this Regulation. R.R.O. 1980, Reg. 433, s. 16.

17. A licence issued to transport and stock fish shall be in Form 8. O. Reg. 619/89, s. 4.

Form 1

Game and Fish Act

No.

19.....

LICENCE TO PROPAGATE AND SELL BASS AND TROUT

Under the Game and Fish Act and the regulations and subject to the limitations thereof, this licence is granted to:

.....

of

to propagate and sell for the purposes of,

- (strike out inapplicable species, if any) (a) stocking, smallmouth bass, largemouth bass, brook trout and rainbow trout; and
(b) human consumption, brook trout and rainbow trout.

The fish sold under this licence shall be taken from the waters on the following parcel of land:

.....
.....

This licence expires with the 31st day of December next following the date on which it is issued.

.....
(date) (signature of issuer)

R.R.O. 1980, Reg. 433, Form 1.

Form 2

Game and Fish Act

No.

19.....

LICENCE TO SELL TROUT

Under the Game and Fish Act and the regulations and subject to the limitations thereof, this licence is granted to:

.....
of

to sell for human consumption,

- (strike out inapplicable species and clauses) (a) brook trout and rainbow trout taken from waters outside Ontario;
(b) live brook trout and rainbow trout propagated in Ontario, in a restaurant or retail store;
(c) surplus stocks of brook trout and rainbow trout held by the licensee under Fishing

Preserve Licence No.

at the following address:

.....
.....

This licence expires with the day of
....., 19.....

.....
(date) (signature of issuer)

R.R.O. 1980, Reg. 433, Form 2.

Form 3

Game and Fish Act

No.

19.....

APPLICATION FOR A LICENCE TO PROPAGATE AND SELL BASS AND TROUT

Under the *Game and Fish Act* and the regulations and subject to the limitations thereof,

.....
(print full name, surname preceding)

.....
(post office address)

makes application for a licence to propagate and sell for the purpose of,

(strike out inapplicable species, if any)

- (a) stocking, smallmouth bass, largemouth bass, brook trout and rainbow trout; and
- (b) human consumption, brook trout and rainbow trout.

1. From whom will you obtain your fish stock?

.....
(name)

.....
(address)

2. Will brood stock be retained for propagation?

3. The fish to be sold will be taken from the water on the parcel of land described as follows:

Lot Concession

Township County or

District

4. I enclose cheque—money order—in the amount of \$41 in payment of the licence fee.

.....
(date)

.....
(signature of applicant)

R.R.O. 1980, Reg. 433, Form 3; O. Reg. 755/84, s. 3; O. Reg. 619/89, s. 5.

Form 4

Game and Fish Act

No.

19.....

APPLICATION FOR A LICENCE TO SELL TROUT

Under the *Game and Fish Act* and the regulations and subject to the limitations thereof,

.....
(print full name, surname preceding)

.....
(post office address)

makes application for a licence to sell for human consumption,

(strike out inapplicable species and clauses, if any)

- (a) brook trout and rainbow trout taken from waters outside Ontario; and
- (b) live brook trout and rainbow trout propagated in Ontario, in a restaurant or retail store;
- (c) surplus stocks of brook trout and rainbow trout held by me under Fishing Preserve

Licence No.

at the following address:

.....
.....

at which is situate a,

processing or packaging plant:

restaurant:

retail store:

other
(specify)

State province or country from which fish are to be imported (if applicable)

.....
.....
(date) (signature of applicant)

R.R.O. 1980, Reg. 433, Form 4.

Form 5

Game and Fish Act

ANNUAL REPORT AS TO BROOK TROUT AND RAINBOW TROUT SOLD FOR HUMAN CONSUMPTION

Name of Licensee

Address of Licensee

Number of Licence expiring December 31, 19....

Sale of Fish by Licensee From

January 1, 19..... to December 31, 19.....

Species	Number	Weight
.....
.....

.....
(date)

.....
(signature of licensee)

R.R.O. 1980, Reg. 433, Form 5.

Form 6

Game and Fish Act

No.

19.....

FISHING PRESERVE LICENCE

Under the *Game and Fish Act* and the regulations and subject to the limitations thereof, this licence is granted to:

.....
(print full name, surname preceding)

.....
(post office address)

to own or operate a fishing preserve on the following parcel of land:

.....
.....
.....

This licence expires with the 31st day of December next following the date on which it is issued.

.....
(date)

.....
(signature of issuer)

R.R.O. 1980, Reg. 433, Form 6.

Form 7

Game and Fish Act

No.

19.....

APPLICATION FOR A FISHING PRESERVE LICENCE

Under the *Game and Fish Act* and the regulations and subject to the limitations thereof,

.....
(print full name, surname preceding)

.....
(post office address)

makes application for a licence to own or operate a fish preserve on the following parcel of land:

Lot Concession

Township County or District

Other

1. What is the source of your water supply?

.....

2. What species of fish will you be providing for angling purposes?

3. I enclose cheque—money order—in the amount of \$82 in payment of the licence fee.

.....
(date)

.....
(signature of applicant)

R.R.O. 1980, Reg. 433, Form 7; O. Reg. 755/84, s. 4; O. Reg. 619/89, s. 6.

Form 8

Game and Fish Act

LICENCE TO TRANSPORT AND STOCK FISH

Ministry of
Natural Resources

Under the *Game and Fish Act* and the regulations, and subject to the limitations of the *Fisheries Act* (Canada) and the Ontario Fisheries Regulations, this licence is granted to:

.....
Name

.....
Mailing Address

.....
Telephone

To Transfer

.....
Quantity

.....
Species

.....
Size

.....
Age

FROM WATERS OWNED OR LEASED BY:

.....
Name

.....
Name of hatchery or water

.....
Licence Number

.....
Mailing Address

Location of Waters

.....
 County Township Lot Conc.

TO STOCK THE ABOVE MENTIONED FISH IN WATERS KNOWN AS:

.....
 Name County Township Lot Conc.

LOCATED AT:

.....
 Mailing Address Telephone

OWNED OR OPERATED BY:

Name

Distribute copies to:

1. Purchaser/Permittee
2. Private Hatchery/Supplier
3. District Preparing Permit

.....
District Manager

O. Reg. 619/89, s. 7.

REGULATION 522**SNARES**

1.—(1) Subject to subsections (2) and (3), no person shall use a body-gripping or leg-hold trap in the part of Ontario lying north of the French and Mattawa rivers.

(2) Subsection (1) does not apply to a person who, to hunt or trap rabbits, sets a snare,

- (a) constructed of copper or brass wire of between 22 and 24 gauge, both inclusive; and
- (b) the wire loop of which is not more than 10 centimetres.

(3) Subject to section 2, subsection (1) does not apply to a person referred to in clause 30 (3) (a) or (b) of the Act. O. Reg. 156/81, s. 1.

2.—(1) Subject to subsection (2), no person referred to in clause 30 (3) (a) or (b) of the Act shall use a snare for any purpose,

- (a) in those parts of Ontario described in Schedule 1; or
- (b) during the open season for deer in those parts of Ontario described in Schedule 2, except where the open season is subject to the condition that no person shall use or be accompanied by a dog. O. Reg. 156/81, s. 2 (1); O. Reg. 674/87, s. 1.

(2) Subsection (1) does not apply to a person referred to in clause 30 (3) (a) or (b) of the Act who sets,

- (a) a snare under the surface of any body of water;
- (b) a foot snare or cable-live trap in a horizontal position on the ground; or
- (c) a snare referred to in subsection 1(2) to hunt or trap rabbits

in the part of Ontario lying north of the French and Mattawa rivers. O. Reg. 156/81, s. 2 (2).

Schedule 1

1. The counties of:

- i. Brant.
- ii. Bruce.
- iii. Dufferin.
- iv. Dundas.
- v. Elgin.
- vi. Essex.
- vii. Frontenac, except the townships of Barrie, Bedford, Clarendon and Miller, Hinchinbrooke, Kennebec, Olden, Oso and Palmerston and North and South Canonto.
- viii. Glengarry.
- ix. Grenville.
- x. Grey.
- xi. Huron.
- xii. Kent.
- xiii. Lambton.
- xiv. Lanark, except the townships of Darling, Lavant and Pak-
enham.
- xv. Leeds.
- xvi. Lennox and Addington, except the Township of Sheffield and that part of the Township of Kaladar lying south of that

- part of the King's Highway known as No. 7 and those parts of the said county lying north of that part of the King's Highway known as No. 7.
- xvii. Middlesex.
 - xviii. Northumberland.
 - xix. Oxford.
 - xx. Perth.
 - xxi. Peterborough, except the townships of Anstruther, Burleigh, Cavendish, Chandos, Galway, Harvey and Methuen.
 - xxii. Prescott.
 - xxiii. Prince Edward.
 - xxiv. Russell.
 - xxv. Simcoe.
 - xxvi. Stormont.
 - xxvii. Victoria, except the townships of Carden, Dalton, Digby, Laxton, Longford and Somerville.
 - xxviii. Wellington.
2. The regional municipalities of:
- i. Durham.
 - ii. Haldimand-Norfolk.
 - iii. Halton.
 - iv. Hamilton-Wentworth.
 - v. Niagara.
 - vi. Ottawa-Carleton.
 - vii. Peel.
 - viii. Waterloo.
 - ix. York.
3. The Municipality of Metropolitan Toronto. O. Reg. 156/81, Sched. 1; O. Reg. 579/86, s. 1.

Schedule 2

1. The counties of:
- i. Hastings.
 - ii. Renfrew.
2. Those parts of the County of Lennox and Addington lying north of that part of the King's Highway known as No. 7.
3. The county of Haliburton.
4. The townships of:
- i. Barrie, Bedford, Clarendon and Miller, Hinchinbrooke, Kennebec, Olden, Oso and Palmerston and North and South Canonto in the County of Frontenac.
 - ii. Darling, Lavant and Pakenham, in the County of Lanark.
- iii. Carden, Dalton, Digby, Laxton, Longford and Somerville in the County of Victoria.
 - iv. Sheffield and that part of the Township of Kaladar in the County of Lennox and Addington lying south of that part of the King's Highway known as No. 7.
 - v. Anstruther, Burleigh, Cavendish, Chandos, Galway, Harvey and Methuen, in the County of Peterborough.
5. The District Municipality of Muskoka.
6. The territorial districts of:
- i. Manitoulin.
 - ii. Nipissing.
 - iii. Parry Sound.
 - iv. Those parts of the territorial districts of Algoma, Sudbury and Timiskaming, lying south of a line described as follows:
- Beginning at the intersection of the boundary between Ontario and Quebec with the northerly shore of Lake Timiskaming; thence southerly and westerly along the northerly shore of that lake to the southerly boundary of the geographic Township of Dymond, in the Territorial District of Timiskaming; thence westerly along the southerly boundaries of the geographic townships of Dymond, Hudson, Lundy, Auld, Speight, Banks and Wallis, to the southwesterly corner of the last-mentioned township; thence southerly along the easterly boundaries of the geographic townships of Brewster and Gamble to the southeasterly corner of the last-mentioned geographic township; thence westerly along the southerly boundaries of the geographic townships of Gamble, Corley, Leckie and Dufferin, to the southwesterly corner of the last-mentioned geographic township; thence northerly along the westerly boundaries of the geographic townships of Dufferin, North Williams, Leonard and Tyrrell, to the intersection with the centre line of the highway known as the Elk Lake Westree Road; thence southwesterly along that centre line to Westree Station of the Canadian National Railway Company; thence southerly along the centre line of the Canadian National Railway Company to the southerly boundary of the geographic Township of Hennessy in the Territorial District of Sudbury; thence westerly along the southerly boundaries of the geographic townships of Hennessy and Inverness to the southwesterly corner of the last-mentioned geographic township; thence southerly along the easterly boundary of the geographic townships of Paudash, Marquette, Battersby, Athlone and Morse, to the southeasterly corner of the last-mentioned geographic township; thence westerly along the southerly boundaries of the geographic townships of Morse and Dennie, and the geographic townships of Del Villano, Beebe, Avis, Assef, Assad and Shulman, in the Territorial District of Algoma, to the southwesterly corner of the last-mentioned geographic township; thence northerly along the westerly boundaries of the geographic townships of Shulman, Parrot, McKeough and Guindon, to the northwesterly corner of the last-mentioned geographic township; thence westerly along the southerly boundaries of the geographic townships of Eaton, Duksza, Drea, Deans, Cassidy, Carruthers, Carton, Sherratt, Scriven and Schembri, in the Territorial District of Sudbury, to the southwesterly corner of the last-mentioned geographic township; thence southerly along the easterly boundary of the geographic Township of Running, in the Territorial District of Algoma, to the southeasterly corner thereof; thence westerly and along the southerly boundaries of the geographic townships of Running, Runnalls, Raaflaub, Home, Peever and Rix, and the production of the southerly boundary of the last-mentioned geographic township to its intersection with the southerly production of the boundary

between the territorial districts of Algoma and Thunder Bay. O. Reg. 156/81, Sched. 2; O. Reg. 579/86, s. 2.

REGULATION 523

STAG ISLAND HUNTING AREA

1. The Crown lands described in the Schedule are designated in accordance with paragraph 33 of section 92 of the Act. R.R.O. 1980, Reg. 434, s. 1.

2. Except as provided in this Regulation, no person shall hunt any animal or bird in the area described in the Schedule. R.R.O. 1980, Reg. 434, s. 2.

3. The holder of a licence in Form 5 of Regulation 500 of Revised Regulations of Ontario, 1990, may hunt ducks, geese, rails, coots and gallinules on any day, except Sunday, during their open season in any year during the hours between one-half hour before sunrise and one-half hour after sunset in the area described in the Schedule, upon condition that,

- (a) he or she anchors his or her boat at a stake planted and numbered by an officer of the Ministry;
- (b) he or she hunts only from a blind supplied by the Ministry, the number of which corresponds with the number of the stake referred to in clause (a);
- (c) the blind from which he or she hunts is occupied by no more than one other person; and
- (d) he or she keeps his or her firearm unloaded and encased while proceeding to or from a blind. R.R.O. 1980, Reg. 434, s. 3.

4. In this Regulation, a reference to the Schedule is a reference to the Schedule to Regulation 434 of Revised Regulations of Ontario, 1980, as that Schedule read on December 31, 1990. *New.*

REGULATION 524

TINY MARSH HUNTING AREA

1. The Crown lands described in the Schedule are designated in accordance with paragraph 33 of section 92 of the Act. R.R.O. 1980, Reg. 435, s. 1.

2. Except as provided in this Regulation, no person shall hunt in the area described in the Schedule,

- (a) pheasants;
- (b) migratory game birds from the first day of the open season therefor to the 15th day of October, both inclusive; or
- (c) any animals or birds other than those referred to in clause (a) or (b) on the first day of the open season for migratory game birds. O. Reg. 572/88, s. 1.

3.—(1) The holder of a licence to hunt small game in Form 5 under Regulation 500 of Revised Regulations of Ontario, 1990 (Hunting Licences) may hunt ducks, geese, coots, rails, gallinules, woodcock, snipe, grouse, rabbits, fox and wolf on the first day of the open season for migratory game birds in the area described in the Schedule if the holder deposits the licence with and obtains a permit from the officer in charge.

(2) A permit referred to in subsection (1) shall not be issued unless there are no more than 299 other licence holders with permits

hunting in the area described in the Schedule at the time the holder presents the licence to the officer in charge. O. Reg. 572/88, s. 2.

4. The holder of a licence to hunt small game in Form 5 of Regulation 500 of Revised Regulations of Ontario, 1990 (Hunting Licences), may hunt pheasants on the second Monday in October and on any day, other than Sunday, Monday or Tuesday, during the open season therefor in any year, between the hours of 9 o'clock in the forenoon and 12 o'clock noon and between the hours of 1 o'clock and 4 o'clock in the afternoon in the area described in the Schedule, upon condition that,

- (a) the licensee deposits the licence with the officer in charge;
- (b) there are not more than twenty-nine other persons hunting pheasants in the area described in the Schedule at the time the licensee presents the licence to the officer in charge;
- (c) the licensee reports to the officer in charge between 12 o'clock noon and 12.30 o'clock in the afternoon;
- (d) the licensee does not shoot or attempt to shoot any pheasant that is on the ground;
- (e) the licensee does not shoot or attempt to shoot more than two pheasants in one day in the area described in the Schedule;
- (f) the licensee uses a shotgun loaded with shot not heavier than No. 2;
- (g) before leaving the area described in the Schedule, the licensee reports to the officer in charge and produces for inspection any pheasant the licensee has killed; and
- (h) the licensee parks in a designated parking area. O. Reg. 399/86, s. 1; O. Reg. 572/88, s. 3.

5. The holder of a licence to hunt small game in Form 5 under Regulation 500 of Revised Regulations of Ontario, 1990 (Hunting Licences) may hunt ducks, geese, coots, rails, gallinules and snipe in the area described in the Schedule from the first day of the open season therefor to the 15th day of October, both inclusive, during the hours between one-half hour before sunrise and 12 o'clock noon. O. Reg. 572/88, s. 4.

6. In this Regulation, a reference to the Schedule is a reference to the Schedule to Regulation 435 of Revised Regulations of Ontario, 1980, as that Schedule read on December 31, 1990. *New.*

REGULATION 525

TRADE IN GAME ANIMAL HIDES AND CAST ANTLERS

1. In this Regulation,

“cast antlers” means intact and untreated antlers that have dropped naturally from living caribou, deer or moose;

“hide” means the untanned and untreated skin of black bear, deer or moose and includes, in the case of black bear, the head and the claws attached to the skin, but does not include the head in the case of deer or moose;

“purchase” and “sale” include acquisition and disposition by barter. O. Reg. 541/90, s. 1.

2.—(1) A licence to sell hides and cast antlers shall be in Form 1.

(2) A licence to purchase, for personal use, hides and cast antlers shall be in Form 2.

(3) A licence to purchase and sell hides and cast antlers shall be in Form 3.

(4) A licence to sell cast antlers shall be in Form 4.

(5) A licence in Form 1, 3 or 4 expires with the 31st day of December following the date on which it is issued.

(6) A licence in Form 2 expires with the thirtieth day after the date on which it is issued.

(7) The fee for a licence in Form 3 or 4 is \$35. O. Reg. 541/90, s. 2.

3.—(1) A licence in Form 1 authorizes the holder to sell, to a holder of a licence in Forms 2 and 3, the hide of a black bear, a deer or moose that he or she has lawfully taken and cast antlers.

(2) A person is authorized to sell, to a holder of a licence in Form 2 or 3, the hide of a black bear, deer or moose that he or she has lawfully taken and cast antlers if the person holds a licence,

(a) in Form 1 or 2 of Revised Regulations of Ontario, 1990, Regulation 492 (Furs); or

(b) in Form 1, 2, 3, 4, 7, 8 or 9 of Revised Regulations of Ontario, 1990, Regulation 500 (Hunting Licences).

(3) Subject to section 4, a licence in Form 2 authorizes the holder to purchase for his or her personal use,

(a) hide and cast antlers from a holder of a licence in Form 1 or 3 or a holder of a licence referred to in clause (2) (a) or (b); and

(b) cast antlers from a holder of a licence in Form 4.

(4) A licence in Form 3 authorizes the holder to,

(a) purchase hides and cast antlers from a holder of a licence referred to in clause (2) (a) or (b), a holder of a licence in Form 1 or another holder of a licence in Form 3;

(b) purchase cast antlers from a holder of a licence in Form 4;

(c) sell hides and cast antlers to a holder of a licence in Form 2 or another holder of a licence in Form 3; and

(d) sell hides and cast antlers to a person who accepts delivery of the hide or cast antlers outside Ontario.

(5) A licence in Form 4 authorizes the holder to sell cast antlers to a holder of a licence in Form 2, a holder of a licence in Form 3 or a person who accepts delivery of the cast antlers outside Ontario. O. Reg. 541/90, s. 3.

4. The holder of a licence in Form 2 is authorized to purchase only the type and quantity of hides and cast antlers specified in the licence and only from those licensees identified in the licence. O. Reg. 541/90, s. 4.

5.—(1) The holder of a licence in Form 3 or 4 shall keep a register and record in it,

(a) at the time of each purchase,

(i) the date,

(ii) the name and address of the person from whom the holder purchased the hide or cast antlers,

(iii) in the case of a hide purchased from a holder of a licence referred to in clause 3 (2) (a) or (b), the hunting or trapping licence number under which the animal was taken,

(iv) in the case of a hide purchased from a person other than a person referred to in subclause (iii), the dealer's number of that person,

(v) the number and species of hides purchased, and

(vi) the number and species of cast antlers purchased;

(b) at the time of each sale, disposal, tanning or treating of a hide and at the time of each sale, disposal or treating of cast antlers,

(i) the date,

(ii) the name, address and licence number or dealer's number of the person to whom the holder sold or disposed of the hide or cast antlers, or to whom the holder sent the hide for tanning or treating or the cast antlers for treating,

(iii) the number and species of hides sold, disposed of or sent for tanning or treating, and

(iv) the number and species of cast antlers sold, disposed of or sent for treating.

(2) Every licence holder who is required to keep a register under subsection (1) shall submit to an officer, on request, a report setting out the information in the register.

(3) The licence holder shall keep the register for at least two years after the year in which the licence was issued, and shall make the register available for inspection by an officer upon request. O. Reg. 541/90, s. 5.

Form 1

Game and Fish Act

Licence Number

Game Hides and Cast Antlers
Seller's Restricted Licence 19...

Dealer's
Number

1. Renewal
2. New Licence

Under the *Game and Fish Act* and the regulations, and subject to their limitations, this licence is issued to:

Last Name

First Name

Middle Initial

--	--	--

Street Address, P.O. Box No. or Rural Route

[Empty text box for street address]

City, Town or Village

[Empty text box for city/town/village]

, Ontario

Postal Code

[Empty text box for postal code]

Telephone Number

[Empty text box for telephone number]

Name of Licensee's Firm

[Empty text box for licensee's firm name]

Licensee's Date of Birth

[Empty text box for licensee's date of birth]

Year

Month

Day

to sell hides of black bear, deer and moose and cast antlers of caribou, deer and moose.

Signature of Issuer

[Empty text box for issuer signature]

Signature of Licensee

[Empty text box for licensee signature]

Date of Issue

[Empty text box for date of issue]

Year

Month

Day

This licence expires with the 31st day of December following the date on which it is issued.

O. Reg. 541/90, Form 1.

Form 2

Game and Fish Act

Game Hides and Cast Antlers
Buyer's Restricted Licence

Licence Number

[Empty text box for licence number]

District Code

[Empty text box for district code]

Under the *Game and Fish Act* and the regulations, and subject to their limitations, this licence is issued to:

Last Name

First Name

Middle Initial

[Empty text box for licensee name]

Street Address, P.O. Box No. or Rural Route

[Empty text box for street address]

City, Town or Village

[Empty text box for City, Town or Village]

, Ontario

to purchase from:

Hunter's or Trapper's Licence No.

[Empty text box for Hunter's or Trapper's Licence No.]

Game Hides and Antlers Dealer's Assigned No.

[Empty text box for Game Hides and Antlers Dealer's Assigned No.]

or

or

Game Hides and Cast Antlers Seller's Restricted Licence No.

[Empty text box for Game Hides and Cast Antlers Seller's Restricted Licence No.]

for personal use the following hides:

Species	Quantity
1. Black Bear	
2. Deer	
3. Moose	

and

for personal use the following cast antlers:

Species	Quantity
1. Caribou	
2. Deer	
3. Moose	

This licence expires with the thirtieth day after the date on which it is issued.

Date of Issue

Year

Month

Day

[Empty text box for Date of Issue]

Signature of Issuer

Signature of Licensee

O. Reg. 541/90, Form 2.

Form 3

Game and Fish Act

Game Hides and Cast Antlers Dealer's Licence 19...

Licence Number

[Empty text box for Licence Number]

Dealer's Number

[Empty text box for Dealer's Number]

- 1. Renewal
- 2. New Licence

Under the *Game and Fish Act* and the regulations, and subject to their limitations, this licence is issued to:

Last Name

First Name

Middle Initial

[Empty text box for Name fields]

Street Address, P.O. Box No. or Rural Route

[Empty text box for Street Address, P.O. Box No. or Rural Route]

City, Town or Village

[Empty text box for City, Town or Village]

, Ontario

Postal Code

[Empty text box for Postal Code]

Telephone Number

[Empty text box for Telephone Number]

Name of Licensee's Firm

[Empty text box for Name of Licensee's Firm]

Licensee's Date of Birth

[Empty text box for Licensee's Date of Birth]

Year

Month

Day

to purchase and sell hides of black bear, deer and moose and cast antlers of caribou, deer and moose.

Signature of Issuer

[Empty text box for Signature of Issuer]

Signature of Licensee

[Empty text box for Signature of Licensee]

Date of Issue

[Empty text box for Date of Issue]

Year

Month

Day

This licence expires with the 31st day of December following the date on which it is issued.

O. Reg. 541/90, Form 3.

Form 4

Game and Fish Act

Cast Antlers
Dealer's Licence 19...

Licence Number

[Empty text box for Licence Number]

Dealer's
Number

[Empty text box for Dealer's Number]

1. Renewal
2. New Licence

[Empty checkboxes for Renewal and New Licence]

Under the *Game and Fish Act* and the regulations, and subject to their limitations, this licence is issued to:

Last Name

First Name

Middle Initial

[Empty text box for Name fields]

Street Address, P.O. Box No. or Rural Route

[Empty text box for Street Address]

City, Town or Village

[Empty text box for City, Town or Village]

, Ontario

Postal Code

[Empty text box for Postal Code]

Telephone Number

[Empty text box for Telephone Number]

Name of Licensee's Firm

[Empty text box for Name of Licensee's Firm]

Licensee's Date of Birth

Year	Month	Day

to sell cast antlers of caribou, deer and moose.

Signature of Issuer		
Signature of Licensee		
Date of Issue		
Year	Month	Day

This licence expires with the 31st day of December following the date on which it is issued.

O. Reg. 541/90, Form 4.

REGULATION 526

TRAP-LINE AREAS

1. Part of Ontario is divided into those trap-line areas shown outlined in black on the maps or plans filed in the office of the Director of the Wildlife Branch of the Ministry of Natural Resources at Toronto under the numbers in column 1 of each Schedule and the areas are designated by the identifying initials and numbers in column 2 of each Schedule and are situate in the county or territorial district set opposite thereto in column 3 of each Schedule. R.R.O. 1980, Reg. 436, s. 1.

Schedule 1

Abbreviations:

- Nip for Nipissing
- Ren for Renfrew
- Hal for Haliburton

ITEM	COLUMN 1	COLUMN 2	COLUMN 3
1	1	AP-3	Nip & Ren
2	1	AP-4	Hal
3	1	AP-5	Nip
4	1	AP-6	Nip
5	1	AP-7	Nip
6	1	AP-8	Nip & Ren
7	1	AP-9	Hal
8	1	AP-10	Nip
9	1	AP-12	Nip
10	120	AP-13	Nip
11	1	AP-14	Nip
12	1	AP-15	Nip
13	1	AP-23	Hal
14	1	AP-39	Hal
15	120	AP-40	Nip
16	1	AP-43	Nip
17	1	AP-59	Nip
18	1	AP-63	Nip

ITEM	COLUMN 1	COLUMN 2	COLUMN 3
19	1	AP-64	Nip
20	1	AP-65	Nip
21	1	AP-66	Nip
22	1	AP-67	Nip
23	1	AP-68	Nip
24	1	AP-69	Nip
25	1	AP-70	Nip
26	1	AP-71	Nip
27	1	AP-72	Nip
28	1	AP-73	Nip
29	1	AP-74	Nip
30	1	AP-75	Nip
31	1	AP-76	Nip
32	1	AP-77	Nip
33	1	AP-78	Nip
34	1	AP-79	Nip
35	1	AP-80	Nip
36	1	AP-81	Nip

O. Reg. 149/89, s. 1.

Schedule 2

Abbreviations:

- Ken for Kenora
- R.R. for Rainy River

ITEM	COLUMN 1	COLUMN 2	COLUMN 3
1	2	AT-1	R.R.
2	123	AT-2	R.R.
3	66	AT-4	R.R.
4	2	AT-5	R.R.
5	2	AT-6	R.R.
6	2	AT-7	R.R.
7	2	AT-8	R.R.
8	2	AT-9	R.R.

ITEM	COLUMN 1	COLUMN 2	COLUMN 3
9	2	AT-10	R.R.
10	2	AT-11	R.R.
11	2	AT-12	R.R.
12	2	AT-13	R.R.
13	2	AT-14	R.R.
14	2	AT-15	R.R.
15	2	AT-16	R.R.
16	2	AT-17	R.R.
17	2	AT-18	R.R.
18	2	AT-19	R.R.
19	2	AT-20	R.R.
20	2	AT-21	R.R.
21	2	AT-22	R.R.
22	2	AT-23	R.R.
23	2	AT-24	R.R.
24	106	AT-25	R.R.
25	2	AT-26	R.R.
26	2	AT-28	R.R.
27	66	AT-29	R.R.
28	123	AT-32	R.R.
29	2	AT-34	R.R.
30	2	AT-35	R.R.
31	72	AT-37	R.R.
32	2	AT-38	R.R.
33	2	AT-39	R.R.
34	2	AT-40	R.R. & Ken
35	123	AT-41	R.R.
36	123	AT-43	R.R.
37	123	AT-44	Ken
38	66	AT-45	Ken
39	2	AT-46	Ken
40	2	AT-47	Ken
41	2	AT-48	Ken
42	2	AT-49	Ken
43	66	AT-50	R.R.
44	66	AT-51	Ken
45	123	AT-30	R.R.

O. Reg. 149/89, s. 2.

Schedule 3

Abbreviations:

- Hal for Haliburton
- Has for Hastings
- Pet for Peterborough
- Ren for Renfrew

ITEM	COLUMN 1	COLUMN 2	COLUMN 3
1	3	BA-1	Has
2	3	BA-2	Has
3	3	BA-3	Has
4	3	BA-4	Has
5	3	BA-5	Has
6	3	BA-6	Has
7	67	BA-7	Has
8	3	BA-9	Has
9	3	BA-10	Has
10	3	BA-11	Has
11	3	BA-12	Has
12	3	BA-13	Has

ITEM	COLUMN 1	COLUMN 2	COLUMN 3
13	3	BA-14	Has
14	3	BA-16	Ren
15	3	BA-17	Has
16	3	BA-18	Has
17	3	BA-20	Has
18	3	BA-22	Has
19	3	BA-44	Pet
20	3	BA-51	Hal
21	3	BA-55	Pet
22	3	BA-56	Pet
23	3	BA-57	Pet
24	3	BA-58	Pet
25	3	BA-59	Pet
26	3	BA-60	Pet
27	3	BA-64	Pet
28	3	BA-65	Hal
29	3	BA-66	Pet
30	3	BA-70	Hal
31	3	BA-72	Hal & Pet
32	3	BA-73	Pet
33	3	BA-79	Hal
34	3	BA-90	Pet
35	3	BA-91	Pet
36	3	BA-92	Pet
37	3	BA-99	Pet
38	3	BA-100	Pet
39	3	BA-101	Pet
40	3	BA-102	Pet
41	3	BA-103	Hal
42	3	BA-104	Pet
43	3	BA-109	Hal
44	3	BA-120	Pet
45	3	BA-122	Pet
46	3	BA-124	Pet
47	3	BA-125	Pet
48	3	BA-127	Pet
49	3	BA-128	Pet
50	3	BA-135	Hal
51	3	BA-138	Hal

R.R.O. 1980, Reg. 436, Sched. 3.

Schedule 4

Abbreviations:

- Al for Algoma

ITEM	COLUMN 1	COLUMN 2	COLUMN 3
1	4	BL-1	Al
2	4	BL-2	Al
3	4	BL-3	Al
4	4	BL-4	Al
5	4	BL-5	Al
6	4	BL-6	Al
7	4	BL-7	Al
8	4	BL-8	Al
9	4	BL-9	Al
10	4	BL-10	Al
11	4	BL-11	Al
12	4	BL-12	Al
13	4	BL-13	Al

ITEM	COLUMN 1	COLUMN 2	COLUMN 3
14	4	BL-14	Al
15	4	BL-15	Al
16	4	BL-16	Al
17	4	BL-17	Al
18	4	BL-18	Al
19	4	BL-19	Al
20	4	BL-20	Al
21	4	BL-21	Al
22	4	BL-22	Al
23	4	BL-23	Al
24	4	BL-24	Al
25	4	BL-25	Al
26	4	BL-26	Al
27	4	BL-27	Al
28	4	BL-28	Al
29	4	BL-29	Al
30	4	BL-30	Al
31	4	BL-31	Al
32	4	BL-32	Al
33	4	BL-33	Al
34	4	BL-34	Al
35	4	BL-35	Al
36	4	BL-36	Al
37	4	BL-37	Al
38	4	BL-38	Al
39	4	BL-39	Al
40	4	BL-40	Al
41	4	BL-41	Al
42	4	BL-42	Al
43	4	BL-43	Al
44	4	BL-44	Al
45	111	BL-45	Al
46	4	BL-46	Al
47	4	BL-48	Al
48	4	BL-49	Al
49	4	BL-50	Al
50	4	BL-51	Al
51	4	BL-52	Al
52	4	BL-53	Al
53	4	BL-54	Al
54	4	BL-55	Al
55	4	BL-56	Al
56	4	BL-57	Al
57	4	BL-58	Al
58	4	BL-59	Al
59	4	BL-60	Al
60	4	BL-61	Al
61	4	BL-62	Al
62	4	BL-63	Al
63	4	BL-64	Al
64	4	BL-65	Al
65	4	BL-66	Al
66	4	BL-67	Al
67	4	BL-68	Al
68	4	BL-69	Al
69	4	BL-70	Al
70	4	BL-71	Al
71	4	BL-72	Al
72	4	BL-73	Al
73	4	BL-74	Al

ITEM	COLUMN 1	COLUMN 2	COLUMN 3
74	4	BL-75	Al
75	4	BL-76	Al
76	4	BL-77	Al
77	4	BL-78	Al
78	4	BL-79	Al
79	4	BL-80	Al
80	4	BL-81	Al
81	4	BL-82	Al
82	4	BL-83	Al
83	4	BL-84	Al
84	4	BL-85	Al
85	4	BL-86	Al
86	4	BL-87	Al
87	4	BL-88	Al
88	4	BL-89	Al

R.R.O. 1980, Reg. 436, Sched. 4; O. Reg. 475/84, s. 3.

Schedule 5

Abbreviations:

Hal for Haliburton
Mus for Muskoka
Nip for Nipissing
P.S. for Parry Sound

ITEM	COLUMN 1	COLUMN 2	COLUMN 3
1	5	BR-1	Mus
2	5	BR-2	Mus
3	5	BR-3	Mus
4	5	BR-4	Mus
5	5	BR-5	Mus
6	5	BR-6	Mus
7	5	BR-7	Mus
8	5	BR-8	Mus
9	5	BR-9	Hal & Mus
10	5	BR-10	Hal & Mus
11	5	BR-12	Hal
12	121	BR-14	Hal
13	121	BR-17	Hal, Mus & Nip
14	121	BR-18	Hal & Nip
15	121	BR-19	Mus, P.S. & Nip
16	5	BR-20	Mus & P.S.
17	5	BR-21	Hal
18	121	BR-22	P.S. & Nip
19	5	BR-23	P.S. & Nip
20	121	BR-24	P.S.
21	5	BR-25	Nip
22	5	BR-26	Nip
23	121	BR-27	P.S.
24	5	BR-28	P.S.
25	5	BR-29	P.S.
26	121	BR-30	P.S. & Nip
27	5	BR-31	P.S. & Nip
28	5	BR-32	P.S. & Nip
29	5	BR-33	P.S. & Nip
30	5	BR-34	P.S. & Nip
31	5	BR-35	P.S.
32	5	BR-36	P.S.
33	121	BR-38	P.S. & Nip
34	121	BR-39	P.S.

ITEM	COLUMN 1	COLUMN 2	COLUMN 3
35	5	BR-40	P.S.
36	5	BR-41	Hal

R.R.O. 1980, Reg. 436, Sched. 5; O. Reg. 475/84, s. 4.

Schedule 6

Abbreviations:

Al for Algoma
Co for Cochrane
Sud for Sudbury

ITEM	COLUMN 1	COLUMN 2	COLUMN 3
1	124	CP-1	Al
2	124	CP-2	Al
3	124	CP-3	Al
4	124	CP-4	Co
5	124	CP-5	Co
6	124	CP-6	Co
7	124	CP-7	Al
8	124	CP-8	Co
9	124	CP-9	Co
10	124	CP-10	Sud
11	124	CP-11	Sud
12	124	CP-12	Sud
13	124	CP-13	Sud
14	124	CP-14	Sud
15	124	CP-15	Sud
16	124	CP-16	Sud
17	6	CP-17	Sud
18	124	CP-18	Sud
19	6	CP-19	Sud
20	124	CP-20	Sud
21	6	CP-21	Sud
22	6	CP-22	Sud
23	124	CP-23	Sud
24	124	CP-24	Sud
25	124	CP-25	Sud
26	6	CP-26	Sud
27	124	CP-27	Sud
28	124	CP-28	Sud
29	6	CP-29	Sud
30	6	CP-30	Sud
31	124	CP-31	Sud
32	124	CP-32	Sud
33	124	CP-33	Sud
34	124	CP-34	Sud
35	124	CP-35	Sud
36	124	CP-36	Sud
37	6	CP-37	Sud
38	6	CP-38	Sud
39	6	CP-39	Sud
40	6	CP-40	Sud
41	124	CP-41	Sud
42	124	CP-42	Sud
43	124	CP-43	Sud
44	124	CP-44	Sud
45	124	CP-45	Sud
46	6	CP-46	Sud
47	6	CP-47	Sud
48	6	CP-48	Sud

ITEM	COLUMN 1	COLUMN 2	COLUMN 3
49	6	CP-49	Sud
50	124	CP-50	Sud
51	6	CP-52	Sud
52	6	CP-53	Sud
53	6	CP-54	Sud
54	6	CP-55	Sud
55	6	CP-56	Sud
56	6	CP-57	Sud
57	6	CP-58	Sud
58	6	CP-59	Sud
59	124	CP-60	Sud
60	6	CP-61	Sud
61	124	CP-62	Sud
62	124	CP-63	Sud
63	124	CP-64	Sud
64	6	CP-65	Sud
65	6	CP-66	Sud
66	6	CP-67	Sud
67	6	CP-68	Sud
68	6	CP-69	Sud
69	6	CP-70	Sud
70	6	CP-71	Sud
71	6	CP-72	Sud
72	124	CP-73	Sud
73	124	CP-74	Sud
74	6	CP-75	Sud
75	6	CP-76	Sud
76	6	CP-77	Sud
77	124	CP-78	Sud
78	6	CP-79	Sud
79	6	CP-80	Sud
80	6	CP-81	Sud
81	6	CP-82	Sud
82	6	CP-83	Sud
83	6	CP-84	Sud
84	6	CP-85	Sud
85	124	CP-86	Sud
86	6	CP-87	Sud
87	6	CP-88	Sud
88	6	CP-89	Sud
89	6	CP-90	Sud
90	6	CP-91	Sud
91	6	CP-92	Sud
92	6	CP-93	Sud
93	6	CP-94	Sud
94	6	CP-95	Sud
95	6	CP-97	Sud
96	6	CP-98	Sud
97	124	CP-99	Sud
98	6	CP-100	Al
99	6	CP-101	Sud
100	6	CP-102	Sud
101	6	CP-103	Sud
102	6	CP-104	Sud
103	124	CP-105	Al
104	6	CP-106	Sud
105	124	CP-107	Sud
106	6	CP-108	Sud
107	6	CP-109	Sud
108	6	CP-110	Sud

ITEM	COLUMN 1	COLUMN 2	COLUMN 3
109	6	CP-111	Sud

O. Reg. 149/89, s. 3.

Schedule 7Abbreviations:
Co for Cochrane

ITEM	COLUMN 1	COLUMN 2	COLUMN 3
1	125	CC-31	Co
2	125	CC-32	Co
3	125	CC-33	Co
4	125	CC-34	Co
5	125	CC-35	Co
6	125	CC-36	Co
7	125	CC-37	Co
8	125	CC-38	Co
9	125	CC-40	Co
10	125	CC-41	Co
11	125	CC-42	Co
12	125	CC-43	Co
13	125	CC-44	Co
14	125	CC-45	Co
15	125	CC-46	Co
16	125	CC-47	Co
17	125	CC-48	Co
18	125	CC-49	Co
19	125	CC-50	Co
20	125	CC-51	Co
21	125	CC-52	Co
22	125	CC-53	Co
23	125	CC-54	Co
24	125	CC-55	Co
25	125	CC-56	Co
26	125	CC-57	Co
27	125	CC-58	Co
28	125	CC-59	Co
29	125	CC-60	Co
30	125	CC-61	Co
31	125	CC-62	Co
32	125	CC-63	Co
33	125	CC-64	Co
34	125	CC-65	Co
35	125	CC-66	Co
36	125	CC-67	Co
37	125	CC-69	Co
38	125	CC-70	Co
39	125	CC-72	Co
40	125	CC-73	Co
41	125	CC-74	Co
42	125	CC-75	Co
43	125	CC-76	Co
44	125	CC-77	Co
45	125	CC-78	Co
46	125	CC-79	Co
47	125	CC-80	Co
48	125	CC-81	Co
49	125	CC-82	Co
50	125	CC-83	Co
51	125	CC-85	Co

ITEM	COLUMN 1	COLUMN 2	COLUMN 3
52	125	CC-86	Co
53	125	CC-87	Co
54	125	CC-88	Co
55	125	CC-89	Co
56	125	CC-90	Co
57	125	CC-91	Co
58	125	CC-92	Co
59	125	CC-93	Co
60	125	CC-94	Co
61	125	CC-95	Co
62	125	CC-96	Co
63	125	CC-97	Co
64	125	CC-98	Co
65	125	CC-99	Co
66	125	CC-100	Co
67	125	CC-101	Co
68	125	CC-102	Co
69	125	CC-103	Co
70	125	CC-104	Co
71	125	CC-105	Co
72	125	CC-106	Co
73	125	CC-107	Co
74	125	CC-108	Co
75	125	CC-109	Co
76	125	CC-110	Co
77	125	CC-111	Co
78	125	CC-112	Co
79	125	CC-113	Co
80	125	CC-114	Co
81	125	CC-115	Co
82	125	CC-117	Co
83	125	CC-119	Co
84	125	CC-120	Co
85	125	CC-121	Co
86	125	CC-122	Co
87	125	CC-163	Co
88	125	CC-164	Co
89	125	CC-165	Co
90	125	CC-166	Co
91	125	CC-167	Co
92	125	CC-171	Co
93	125	CC-181	Co
94	125	CC-182	Co
95	125	CC-184	Co
96	125	CC-185	Co
97	125	CC-186	Co
98	125	CC-189	Co
99	125	CC-194	Co
100	125	CC-195	Co
101	125	CC-196	Co
102	125	CC-199	Co
103	125	CC-227	Co
104	125	CC-240	Co

O. Reg. 149/89, s. 4.

Schedule 8

Abbreviations:
Ken for Kenora

ITEM	COLUMN 1	COLUMN 2	COLUMN 3
1	8	DR-1	Ken
2	8	DR-2	Ken
3	8	DR-3	Ken
4	8	DR-4	Ken
5	8	DR-5	Ken
6	8	DR-6	Ken
7	8	DR-7	Ken
8	8	DR-8	Ken
9	8	DR-9	Ken
10	8	DR-10	Ken
11	8	DR-11	Ken
12	8	DR-12	Ken
13	8	DR-13	Ken
14	127	DR-14	Ken
15	8	DR-15	Ken
16	8	DR-16	Ken
17	127	DR-17	Ken
18	127	DR-18	Ken
19	8	DR-19	Ken
20	8	DR-20	Ken
21	8	DR-21	Ken
22	8	DR-22	Ken
23	8	DR-23	Ken
24	8	DR-24	Ken
25	8	DR-25	Ken
26	8	DR-26	Ken
27	8	DR-27	Ken
28	8	DR-28	Ken
29	8	DR-29	Ken
30	8	DR-30	Ken
31	8	DR-31	Ken
32	8	DR-32	Ken
33	8	DR-33	Ken
34	8	DR-34	Ken
35	127	DR-35	Ken
36	8	DR-36	Ken
37	8	DR-37	Ken
38	8	DR-38	Ken
39	87 & 88	DR-39	Ken
40	87	DR-40	Ken
41	8	DR-41	Ken
42	8	DR-42	Ken
43	8	DR-43	Ken
44	8	DR-44	Ken
45	8	DR-45	Ken
46	8	DR-46	Ken
47	8	DR-47	Ken
48	8	DR-48	Ken
49	8	DR-49	Ken
50	8	DR-50	Ken
51	8	DR-51	Ken
52	8	DR-52	Ken
53	8	DR-53	Ken
54	8	DR-54	Ken
55	8	DR-55	Ken
56	8	DR-56	Ken

ITEM	COLUMN 1	COLUMN 2	COLUMN 3
57	8	DR-57	Ken
58	8	DR-58	Ken
59	8	DR-59	Ken
60	8	DR-60	Ken
61	8	DR-61	Ken
62	8	DR-62	Ken
63	8	DR-63	Ken
64	8	DR-64	Ken
65	8	DR-65	Ken
66	8	DR-66	Ken
67	8	DR-67	Ken
68	85 & 86	DR-68	Ken

R.R.O. 1980, Reg. 436, Sched. 8; O. Reg. 338/82, s. 2; O. Reg. 149/89, s. 5.

Schedule 9

Abbreviations:
Al for Algoma
Man for Manitoulin
Sud for Sudbury

ITEM	COLUMN 1	COLUMN 2	COLUMN 3
1	9	EP-1	Sud & Al
2	9	EP-2	Sud & Al
3	9	EP-3	Al
4	9	EP-4	Al
5	9	EP-5	Al
6	9	EP-6	Al
7	9	EP-7	Al
8	9	EP-8	Al
9	9	EP-9	Al
10	80	EP-10	Al
11	9	EP-11	Al
12	9	EP-12	Al
13	9	EP-13	Al
14	9	EP-14	Al
15	9	EP-15	Al
16	9	EP-16	Sud & Al
17	128	EP-17	Al
18	128	EP-20	Sud & Al
19	128	EP-21	Sud & Al
20	128	EP-22	Sud & Al
21	128	EP-23	Sud
22	9	EP-24	Sud
23	9	EP-25	Sud
24	9	EP-26	Sud
25	9	EP-27	Al & Sud
26	9	EP-29	Sud
27	9	EP-30	Sud
28	9	EP-31	Sud
29	9	EP-32	Sud
30	128	EP-33	Sud
31	9	EP-34	Sud
32	9	EP-35	Sud
33	128	EP-36	Sud
34	128	EP-37	Sud
35	128	EP-38	Sud
36	128	EP-39	Sud
37	9	EP-40	Sud

ITEM	COLUMN 1	COLUMN 2	COLUMN 3
38	128	EP-41	Sud
39	9	EP-43	Sud
40	9	EP-44	Man
41	9	EP-45	Al & Man
42	80	EP-46	Al

O. Reg. 149/89, s. 6.

Schedule 10

Abbreviations:

Ken for Kenora

R.R. for Rainy River

ITEM	COLUMN 1	COLUMN 2	COLUMN 3
1	10	FF-1	R.R.
2	10	FF-2	R.R.
3	10	FF-3	R.R.
4	130	FF-4	R.R.
5	130	FF-5	R.R.
6	10	FF-6	R.R.
7	10	FF-7	R.R.
8	10	FF-8	R.R. & Ken
9	10	FF-9	Ken
10	130	FF-10	R.R. & Ken
11	130	FF-11	R.R.
12	10	FF-12	R.R.
13	10	FF-13	R.R.
14	10	FF-14	R.R.
15	130	FF-15	R.R.
16	130	FF-16	R.R.
17	130	FF-17	R.R.
18	130	FF-18	R.R. & Ken
19	10	FF-19	Ken
20	130	FF-20	Ken
21	10	FF-21	Ken
22	130	FF-22	Ken
23	10	FF-23	R.R.
24	10	FF-24	R.R.
25	10	FF-25	R.R.
26	10	FF-26	R.R.
27	10	FF-27	R.R.
28	10	FF-28	R.R.
29	10	FF-29	R.R.
30	10	FF-30	R.R.
31	10	FF-31	R.R.
32	130	FF-32	R.R.
33	10	FF-33	Ken
34	130	FF-34	Ken
35	130	FF-35	R.R. & Ken
36	10	FF-36	R.R.
37	10	FF-37	R.R.
38	10	FF-38	R.R.
39	10	FF-39	R.R.
40	10	FF-40	R.R.
41	10	FF-41	R.R.
42	10	FF-42	R.R.
43	10	FF-43	R.R.
44	10	FF-44	R.R.
45	10	FF-45	R.R. & Ken
46	130	FF-46	Ken

ITEM	COLUMN 1	COLUMN 2	COLUMN 3
47	10	FF-47	Ken
48	10	FF-48	Ken
49	10	FF-49	Ken
50	10	FF-50	R.R.
51	10	FF-51	R.R.
55	10	FF-55	R.R.
56	130	FF-56	R.R.
57	130	FF-57	R.R.
58	130	FF-58	Ken

O. Reg. 149/89, s. 7.

Schedule 11

Abbreviations:

Al for Algoma

Co for Cochrane

Ken for Kenora

T.B. for Thunder Bay

ITEM	COLUMN 1	COLUMN 2	COLUMN 3
1	11	GE-1	T.B.
2	11	GE-2	T.B.
3	11 & 12	GE-3	Co
4	12	GE-4	Co
5	11	GE-8	T.B.
6	11	GE-9	T.B. & Co.
7	11 & 12	GE-10	T.B.
8	131	GE-11	T.B. & Co
9	131	GE-12	T.B.
10	11	GE-13	T.B.
11	11 & 12	GE-14	T.B.
12	131	GE-15	T.B.
13	12	GE-16	T.B.
14	11	GE-20	T.B.
15	11	GE-21	T.B.
16	11	GE-22	T.B.
17	11	GE-23	T.B.
18	11	GE-25	T.B.
19	11 & 12	GE-26	T.B.
20	12	GE-27	T.B.
21	11	GE-32	T.B.
22	11	GE-34	T.B.
23	11	GE-35	T.B.
24	11	GE-36	T.B.
25	11	GE-37	T.B.
26	11	GE-38	T.B.
27	11	GE-39	T.B.
28	11	GE-40	T.B.
29	11	GE-41	T.B.
30	11	GE-42	T.B.
31	11	GE-45	T.B.
32	11 & 12	GE-46	T.B.
33	12	GE-48	T.B.
34	12	GE-51	T.B.
35	12	GE-53	T.B. & Co
36	11	GE-65	T.B.
37	11	GE-66	T.B.
38	11	GE-67	T.B.
39	11	GE-68	T.B.
40	11	GE-69	T.B.

ITEM	COLUMN 1	COLUMN 2	COLUMN 3
41	11	GE-70	T.B.
42	11	GE-76	T.B.
43	11	GE-120	T.B.
44	11	GE-121	T.B.
45	11	GE-122	T.B.
46	11	GE-123	T.B.
47	11	GE-124	T.B.
48	11	GE-135	T.B.
49	11	GE-136	T.B. & Co
50	11	GE-137	T.B.
51	11	GE-138	T.B. & Co
52	11	GE-139	T.B.
53	11	GE-140	T.B. & Co
54	11	GE-141	T.B.
55	11	GE-142	T.B.
56	11	GE-143	Co
57	11	GE-144	Co
58	11	GE-145	T.B.
59	11	GE-146	T.B.
60	11	GE-147	T.B.
61	11 & 15	GE-148	T.B. & Co
62	11	GE-149	T.B. & Co
63	11	GE-150	T.B.
64	11 & 15	GE-152	T.B.
65	15	GE-153	T.B., Co & Ken
66	15	GE-154	T.B. & Co
67	15	GE-155	Ken
68	16	GE-156	Ken
69	11 & 15	GE-157	T.B. & Co
70	11, 15 & 16	GE-158	Co
71	15	GE-159	Ken
72	15 & 16	GE-160	Ken
73	12 & 16	GE-161	Co
74	12 & 16	GE-162	Co
75	15 & 16	GE-163	Ken
76	15 & 16	GE-164	Co
77	11 & 12	GE-165	Co
78	14 & 15	GE-204	Ken
79	13 & 15	GE-206	T.B.
80	17	GE-207	Ken
81	14	GE-208	Ken
82	14	GE-209	Ken
83	15	GE-210	T.B. & Ken
84	14, 15 & 17	GE-211	Ken
85	11	GE-212	T.B.
86	14	GE-213	Ken
87	14	GE-214	Ken
88	14	GE-215	Ken
89	11, 13 & 15	GE-216	T.B.
90	11	GE-217	T.B.
91	11 & 15	GE-218	T.B.
92	17	GE-219	Ken
93	15 & 17	GE-220	Ken
94	17	GE-221	Ken
95	15 & 17	GE-222	Ken
96	11	GE-223	T.B.
97	11	GE-224	T.B.
98	11	GE-225	T.B.
99	13 & 15	GE-227	Ken
100	15	GE-228	Ken

ITEM	COLUMN 1	COLUMN 2	COLUMN 3
101	15	GE-229	Ken
102	12	GE-230	T.B. & Co
103	15	GE-231	Ken
104	15	GE-232	Ken
105	14	GE-234	Ken
106	13, 14 & 15	GE-235	Ken
107	11 & 12	GE-240	Co
108	12	GE-241	Co
109	12	GE-300	Co, T.B. & Al
110	12	GE-301	Co, T.B. & Al
111	12	GE-304	T.B. & Al
112	12	GE-305	Al
113	13 & 15	GE-306	T.B. & Ken
114	13	GE-307	T.B. & Ken
115	13	GE-308	Ken
116	13	GE-309	T.B.
117	13	GE-310	Ken
118	13	GE-311	T.B.
119	13	GE-312	T.B. & Ken
120	13 & 15	GE-313	Ken
121	15	GE-314	Ken
122	13	GE-315	T.B. & Ken
123	13 & 15	GE-316	T.B.
124	15	GE-317	Ken
125	15 & 17	GE-318	Ken
126	14	GE-319	Ken
127	14 & 15	GE-320	Ken
128	14	GE-321	Ken
129	17	GE-322	Ken
130	17	GE-323	Ken
131	15	GE-324	Ken
132	17	GE-325	Ken
133	15	GE-326	Ken
134	15	GE-327	Ken
135	15	GE-328	Ken
136	15	GE-329	Ken

R.R.O. 1980, Reg. 436, Sched. 11; O. Reg. 149/89, s. 8.

Schedule 12Abbreviations:
Sud for Sudbury

ITEM	COLUMN 1	COLUMN 2	COLUMN 3
1	18	GO-1	Sud
2	116	GO-2	Sud
3	116	GO-3	Sud
4	116	GO-4	Sud
5	116	GO-5	Sud
6	18	GO-8	Sud
7	18	GO-9	Sud
8	116	GO-10	Sud
9	116	GO-11	Sud
10	132	GO-12	Sud
11	132	GO-13	Sud
12	18	GO-14	Sud
13	18	GO-15	Sud
14	18	GO-16	Sud
15	18	GO-17	Sud
16	132	GO-18	Sud

ITEM	COLUMN 1	COLUMN 2	COLUMN 3
17	18	GO-19	Sud
18	18	GO-20	Sud
19	18	GO-21	Sud
20	18	GO-22	Sud
21	18	GO-23	Sud
22	18	GO-24	Sud
23	132	GO-25	Sud
24	132	GO-26	Sud
25	18	GO-27	Sud
26	18	GO-28	Sud
27	18	GO-29	Sud
28	18	GO-30	Sud
29	18	GO-31	Sud
30	18	GO-32	Sud
31	18	GO-33	Sud
32	18	GO-34	Sud
33	18	GO-35	Sud
34	18	GO-36	Sud
35	18	GO-37	Sud
36	18	GO-38	Sud
37	18	GO-39	Sud
38	18	GO-40	Sud
39	18	GO-41	Sud
40	132	GO-42	Sud
41	132	GO-43	Sud
42	18	GO-44	Sud
43	18	GO-46	Sud
44	132	GO-47	Sud
45	18	GO-48	Sud
46	132	GO-50	Sud
47	132	GO-51	Sud
48	132	GO-54	Sud
49	18	GO-55	Sud
50	18	GO-56	Sud
51	18	GO-57	Sud
52	18	GO-58	Sud
53	132	GO-59	Sud
54	18	GO-60	Sud

O. Reg. 149/89, s. 9.

Schedule 13

Abbreviations:

Al for Algoma
Co for Cochrane

ITEM	COLUMN 1	COLUMN 2	COLUMN 3
1	19	HE-1	Co
2	19	HE-2	Co
3	19	HE-3	Co
4	19	HE-4	Co
5	19	HE-5	Co
6	19	HE-6	Co
7	19	HE-7	Co
8	19	HE-8	Co
9	19	HE-9	Co
10	19	HE-10	Co
11	19	HE-11	Co
12	19	HE-12	Co
13	19	HE-13	Co

ITEM	COLUMN 1	COLUMN 2	COLUMN 3
14	19	HE-14	Co
15	19	HE-15	Co
16	19	HE-16	Co
17	19	HE-17	Co
18	19	HE-18	Co
19	19	HE-19	Co
20	19	HE-20	Co
21	19	HE-26	Co
22	19	HE-27	Co
23	19	HE-28	Co
24	19	HE-29	Co
25	19	HE-30	Co
26	19	HE-31	Co
27	133	HE-32	Co
28	133	HE-33	Co
29	19	HE-35	Co
30	19	HE-36	Co
31	19	HE-37	Al
32	19	HE-38	Al
33	19	HE-39	Co
34	19	HE-40	Co
35	19	HE-41	Co
36	19	HE-47	Co
37	19	HE-48	Co
38	19	HE-49	Al
39	19	HE-50	Al
40	19	HE-51	Al
41	19	HE-53	Al
42	19	HE-54	Co
43	19	HE-55	Al
44	19	HE-56	Al
45	19	HE-57	Al
46	19	HE-60	Co
47	19	HE-66	Al
48	91, 92, 93 & 95	HE-67	Al
49	19	HE-68	Al
50	19	HE-69	Al
51	19	HE-70	Al
52	19	HE-71	Al
53	19	HE-72	Al
54	19	HE-73	Al
55	19	HE-76	Al
56	19	HE-77	Al
57	19	HE-78	Al
58	19	HE-79	Al
59	19	HE-80	Al
60	19	HE-86	Al
61	19	HE-87	Al
62	19	HE-88	Al
63	19	HE-89	Al
64	19	HE-90	Al
65	19	HE-91	Al
66	19	HE-92	Al
67	133	HE-93	Al
68	19	HE-94	Al
69	19	HE-95	Al
70	19	HE-96	Al
71	19	HE-97	Al
72	19	HE-98	Al

ITEM	COLUMN 1	COLUMN 2	COLUMN 3
73	19	HE-99	Al
74	19	HE-101	Al
75	19	HE-102	Al
76	19	HE-103	Al
77	95	HE-75	Al
78	133	HE-34	Co
79	133	HE-104	Co
80	133	HE-100	Co

R.R.O. 1980, Reg. 436, Sched. 13; O. Reg. 338/82, s. 3; O. Reg. 149/89, s. 10.

Schedule 14

Abbreviations:

Mus for Muskoka

Sim for Simcoe

ITEM	COLUMN 1	COLUMN 2	COLUMN 3
1	20	HU-1	Mus
2	20	HU-5	Mus & Sim
3	20	HU-6	Mus & Sim
4	20	HU-7	Sim
5	20	HU-10	Sim
6	20	HU-13	Sim
7	20	HU-15	Sim
8	20	HU-17	Sim
9	20	HU-20	Sim
10	20	HU-21	Sim
11	20	HU-22	Mus
12	20	HU-23	Mus
13	20	HU-29	Sim

R.R.O. 1980, Reg. 436, Sched. 14.

Schedule 15

Abbreviations:

Ken for Kenora

T.B. for Thunder Bay

ITEM	COLUMN 1	COLUMN 2	COLUMN 3
1	134	IG-1	Ken
2	21	IG-2	Ken & T.B.
3	21	IG-3	T.B.
4	21	IG-4	T.B.
5	21	IG-5	T.B.
6	21	IG-6	T.B.
7	21	IG-7	T.B.
8	21	IG-8	T.B.
9	21	IG-10	T.B.
10	21	IG-11	T.B.
11	21	IG-12	T.B.
12	21	IG-13	T.B.
13	21	IG-14	T.B.
14	21	IG-15	T.B.
15	21	IG-16	T.B.
16	21	IG-17	Ken
17	21	IG-19	Ken
18	21	IG-20	Ken
19	21	IG-21	T.B.
20	21	IG-23	T.B.
21	21	IG-24	T.B.

ITEM	COLUMN 1	COLUMN 2	COLUMN 3
22	21	IG-25	T.B.
23	21	IG-26	Ken
24	21	IG-27	Ken
25	21	IG-28	Ken
26	21	IG-29	Ken
27	21	IG-30	Ken
28	134	IG-31	Ken
29	21	IG-32	Ken
30	21	IG-33	Ken
31	21	IG-34	Ken
32	21	IG-35	Ken
33	134	IG-36	Ken
34	134	IG-37	Ken
35	21	IG-39	Ken & T.B.
36	21	IG-40	T.B.
37	21	IG-41	T.B.
38	21	IG-42	T.B.
39	21	IG-43	Ken
40	21	IG-44	T.B.
41	134	IG-45	Ken
42	21	IG-46	Ken
43	134	IG-47	Ken
44	134	IG-48	Ken
45	21	IG-50	Ken
46	21	IG-51	Ken
47	21	IG-52	Ken
48	21	IG-53	Ken
49	21	IG-54	Ken
50	21	IG-55	Ken
51	21	IG-56	Ken
52	21	IG-57	Ken

R.R.O. 1980, Reg. 436, Sched. 15; O. Reg. 149/89, s. 11.

Schedule 16

Abbreviations:

Al for Algoma

Co for Cochrane

ITEM	COLUMN 1	COLUMN 2	COLUMN 3
1	22	KA-1	Al
2	22	KA-2	Al
3	22	KA-3	Al
4	22	KA-4	Al
5	22	KA-5	Al & Co
6	22	KA-6	Co
7	22	KA-7	Co
8	22	KA-8	Co
9	22	KA-9	Co
10	22	KA-10	Co
11	22	KA-11	Co
12	22	KA-12	Co
13	22	KA-13	Al & Co
14	22	KA-14	Al
15	22	KA-15	Al
16	22	KA-16	Al
17	22	KA-17	Al
18	22	KA-18	Al
19	22	KA-19	Al & Co
20	22	KA-20	Al & Co

ITEM	COLUMN 1	COLUMN 2	COLUMN 3
21	22	KA-21	Co
22	22	KA-22	Co
23	22	KA-23	Co
24	22	KA-24	Co
25	22	KA-25	Co
26	22	KA-26	Co
27	22	KA-27	Co
28	22	KA-28	Co
29	22	KA-29	Al & Co
30	22	KA-30	Al & Co
31	22	KA-31	Al & Co
32	22	KA-32	Al & Co
33	22	KA-33	Co
34	22	KA-34	Al & Co
35	22	KA-35	Al & Co
36	22	KA-36	Al & Co
37	22	KA-37	Co
38	22	KA-38	Co
39	22	KA-39	Co
40	22	KA-40	Co
41	22	KA-41	Co
42	22	KA-42	Co
43	22	KA-43	Co
44	22	KA-44	Co
45	22	KA-45	Co
46	112	KA-46	Co
47	22	KA-48	Co
48	22	KA-49	Co
49	22	KA-50	Co
50	22	KA-51	Co
51	22	KA-52	Co
52	73	KA-53	Co
53	73	KA-54	Co
54	22	KA-55	Co
55	22	KA-56	Co
56	22	KA-57	Co
57	22	KA-58	Co
58	22	KA-59	Co
59	135	KA-60	Co
60	135	KA-61	Co
61	22	KA-62	Co
62	22	KA-63	Co
63	22	KA-64	Co
64	22	KA-65	Co
65	22	KA-66	Co
66	136	KA-67	Co
67	22	KA-68	Co
68	22	KA-69	Co
69	136	KA-70	Co
70	22	KA-71	Co
71	22	KA-72	Co
72	22	KA-73	Co
73	22	KA-74	Co
74	22	KA-75	Co
75	22	KA-76	Co
76	22	KA-77	Co
77	22	KA-78	Co
78	22	KA-79	Co
79	22	KA-80	Co
80	22	KA-81	Co

ITEM	COLUMN 1	COLUMN 2	COLUMN 3
81	22	KA-82	Co
82	22	KA-83	Co
83	22	KA-84	Co
84	22	KA-85	Co

R.R.O. 1980, Reg. 436, Sched. 16; O. Reg. 475/84, s. 8; O. Reg. 149/89, s. 12.

Schedule 17

Abbreviations:
Ken for Kenora

ITEM	COLUMN 1	COLUMN 2	COLUMN 3
1	23	KE-1	Ken
2	23	KE-2	Ken
3	23	KE-3	Ken
4	23	KE-4	Ken
5	23	KE-5	Ken
6	23	KE-6	Ken
7	23	KE-7	Ken
8	23	KE-8	Ken
9	23	KE-9	Ken
10	23	KE-10	Ken
11	23	KE-11	Ken
12	23	KE-12	Ken
13	23	KE-13	Ken
14	23	KE-14	Ken
15	23	KE-15	Ken
16	23	KE-16	Ken
17	23	KE-17	Ken
18	23	KE-18	Ken
19	23	KE-20	Ken
20	23	KE-21	Ken
21	23	KE-22	Ken
22	23	KE-23	Ken
23	23	KE-24	Ken
24	23	KE-25	Ken
25	23	KE-26	Ken
26	23	KE-27	Ken
27	23	KE-29	Ken
28	23	KE-30	Ken
29	23	KE-31	Ken
30	23	KE-32	Ken
31	23	KE-33	Ken
32	23	KE-34	Ken
33	23	KE-35	Ken
34	23	KE-36	Ken
35	23	KE-37	Ken
36	23	KE-38	Ken
37	23	KE-39	Ken
38	23	KE-40	Ken
39	23	KE-41	Ken
40	23	KE-42	Ken
41	23	KE-43	Ken
42	23	KE-44	Ken
43	23	KE-45	Ken
44	23	KE-46	Ken
45	23	KE-47	Ken
46	23	KE-48	Ken
47	23	KE-49	Ken

ITEM	COLUMN 1	COLUMN 2	COLUMN 3
48	23	KE-50	Ken
49	23	KE-51	Ken
50	23	KE-52	Ken
51	23	KE-53	Ken
52	23	KE-54	Ken
53	23	KE-55	Ken
54	23	KE-56	Ken
55	23	KE-57	Ken
56	23	KE-58	Ken
57	23	KE-59	Ken
58	23	KE-60	Ken
59	23	KE-61	Ken
60	23	KE-62	Ken
61	23	KE-63	Ken
62	23	KE-64	Ken
63	23	KE-65	Ken
64	23	KE-66	Ken
65	23	KE-67	Ken
66	23	KE-68	Ken
67	23	KE-69	Ken
68	23	KE-70	Ken
69	23	KE-71	Ken
70	23	KE-72	Ken
71	23	KE-73	Ken
72	23	KE-74	Ken
73	23	KE-75	Ken
74	23	KE-76	Ken
75	23	KE-77	Ken
76	23	KE-78	Ken
77	23	KE-79	Ken
78	23	KE-80	Ken
79	23	KE-81	Ken
80	23	KE-82	Ken
81	23	KE-84	Ken
82	23	KE-85	Ken
83	23	KE-86	Ken
84	23	KE-87	Ken
85	23	KE-88	Ken
86	23	KE-89	Ken
87	23	KE-90	Ken
88	23	KE-91	Ken
89	23	KE-92	Ken
90	23	KE-93	Ken
91	23	KE-94	Ken
92	23	KE-95	Ken
93	23	KE-96	Ken
94	23	KE-97	Ken
95	23	KE-98	Ken
96	23	KE-99	Ken
97	23	KE-100	Ken
98	23	KE-101	Ken
99	23	KE-102	Ken
100	23	KE-103	Ken
101	23	KE-104	Ken
102	23	KE-105	Ken
103	23	KE-106	Ken
104	23	KE-107	Ken
105	23	KE-108	Ken
106	23	KE-109	Ken
107	23	KE-110	Ken

ITEM	COLUMN 1	COLUMN 2	COLUMN 3
108	23	KE-111	Ken
109	23	KE-112	Ken
110	23	KE-114	Ken
111	23	KE-116	Ken
112	23	KE-117	Ken
113	23	KE-118	Ken
114	23	KE-119	Ken
115	23	KE-120	Ken
116	23	KE-121	Ken
117	23	KE-122	Ken
118	23	KE-123	Ken
119	23	KE-124	Ken
120	23	KE-125	Ken
121	23	KE-126	Ken
122	23	KE-127	Ken
123	23	KE-129	Ken
124	23	KE-131	Ken
125	23	KE-132	Ken
126	23	KE-133	Ken
127	23	KE-134	Ken
128	23	KE-135	Ken
129	23	KE-136	Ken
130	23	KE-137	Ken
131	23	KE-138	Ken
132	23	KE-139	Ken
133	23	KE-140	Ken
134	23	KE-141	Ken
135	23	KE-142	Ken
136	23	KE-143	Ken
137	23	KE-144	Ken
138	23	KE-145	Ken
139	23	KE-146	Ken
140	23	KE-147	Ken
141	23	KE-148	Ken
142	23	KE-149	Ken
143	23	KE-150	Ken
144	23	KE-151	Ken
145	23	KE-152	Ken
146	23	KE-153	Ken
147	23	KE-154	Ken
148	23	KE-155	Ken
149	23	KE-156	Ken
150	23	KE-157	Ken
151	23	KE-158	Ken
152	23	KE-159	Ken
153	23	KE-160	Ken

R.R.O. 1980, Reg. 436, Sched. 17; O. Reg. 475/84, s. 9.

Schedule 18

Abbreviations:

Co for Cochrane

Tim for Timiskaming

ITEM	COLUMN 1	COLUMN 2	COLUMN 3
1	24	KL-1	Co
2	24	KL-2	Co
3	137	KL-3	Co
4	138	KL-4	Co
5	24	KL-5	Co

ITEM	COLUMN 1	COLUMN 2	COLUMN 3
6	24	KL-6	Co & Tim
7	137	KL-7	Co
8	24	KL-8	Co
9	24	KL-9	Co
10	24	KL-10	Co
11	24	KL-11	Co
12	24	KL-12	Co
13	24	KL-13	Tim
14	24	KL-14	Co
15	24	KL-15	Co & Tim
16	24	KL-16	Co
17	24	KL-17	Co & Tim
18	137	KL-18	Co & Tim
19	24	KL-19	Co & Tim
20	24	KL-20	Tim
21	24	KL-21	Tim
22	24	KL-23	Co
23	24	KL-24	Co
24	24	KL-25	Co
25	24	KL-26	Tim
26	24	KL-27	Tim
27	24	KL-28	Tim
28	24	KL-29	Tim
29	24	KL-30	Tim
30	24	KL-31	Tim
31	24	KL-32	Tim
32	24	KL-33	Tim
33	24	KL-34	Tim
34	24	KL-35	Tim
35	24	KL-36	Tim
36	24	KL-38	Tim
37	24	KL-39	Tim
38	24	KL-40	Tim
39	24	KL-41	Tim
40	24	KL-42	Tim
41	24	KL-43	Tim
42	24	KL-44	Tim
43	24	KL-45	Tim
44	24	KL-46	Tim
45	24	KL-47	Tim
46	24	KL-48	Tim
47	24	KL-49	Tim
48	24	KL-50	Tim
49	24	KL-51	Co & Tim
50	24	KL-52	Tim
51	24	KL-53	Tim
52	24	KL-54	Tim
53	24	KL-55	Tim
54	24	KL-56	Tim
55	24	KL-57	Tim
56	24	KL-58	Tim
57	24	KL-59	Tim
58	114	KL-60	Tim
59	113	KL-61	Tim
60	24	KL-62	Tim
61	24	KL-63	Tim
62	24	KL-64	Tim
63	24	KL-65	Tim
64	24	KL-66	Co & Tim
65	24	KL-67	Tim

ITEM	COLUMN 1	COLUMN 2	COLUMN 3
66	24	KL-68	Tim
67	24	KL-69	Tim
68	24	KL-70	Tim
69	24	KL-71	Tim
70	24	KL-72	Tim
71	24	KL-73	Tim
72	24	KL-74	Tim
73	24	KL-75	Tim
74	24	KL-76	Tim
75	24	KL-77	Tim
76	24	KL-78	Tim
77	24	KL-79	Tim
78	24	KL-80	Tim
79	24	KL-81	Tim
80	24	KL-82	Tim
81	24	KL-85	Tim
82	24	KL-86	Tim
83	24	KL-87	Tim
84	24	KL-88	Tim
85	24	KL-89	Tim
86	24	KL-90	Tim
87	24	KL-91	Tim
88	24	KL-92	Tim
89	24	KL-93	Tim
90	24	KL-94	Tim
91	24	KL-95	Tim
92	24	KL-96	Tim
93	24	KL-97	Tim
94	24	KL-98	Tim
95	24	KL-99	Tim
96	115	KL-100	Tim
97	24	KL-102	Tim
98	115	KL-103	Tim
99	24	KL-106	Tim
100	24	KL-107	Tim
101	24	KL-108	Tim
102	24	KL-110	Tim
103	24	KL-111	Tim

R.R.O. 1980, Reg. 436, Sched. 18; O. Reg. 475/84, s. 10; O. Reg. 149/89, s. 13.

Schedule 19

Abbreviations:

Hal for Haliburton
 Pet for Peterborough
 Vic for Victoria

ITEM	COLUMN 1	COLUMN 2	COLUMN 3
1	97	MD-01	Hal
2	97	MD-02	Hal
3	97	MD-03	Hal
4	97	MD-04	Hal
5	97	MD-05	Hal
6	97	MD-06	Hal
7	97	MD-07	Hal
8	97	MD-08	Hal
9	97	MD-09	Hal
10	97	MD-10	Hal
11	97	MD-12	Hal

ITEM	COLUMN 1	COLUMN 2	COLUMN 3
12	97	MD-13	Hal
13	97	MD-14	Vic
14	97	MD-15	Hal
15	97	MD-16	Vic
16	97	MD-17	Vic
17	97	MD-18	Vic
18	97	MD-19	Vic
19	97	MD-23	Vic
20	97	MD-24	Vic
21	97	MD-25	Vic
22	97	MD-26	Vic
23	139	MD-27	Vic
24	139	MD-28	Hal
25	97	MD-30	Hal & Vic
26	97	MD-32	Hal
27	97	MD-33	Hal
28	97	MD-34	Hal
29	97	MD-35	Hal
30	97	MD-36	Hal
31	97	MD-37	Hal
32	97	MD-39	Pet
33	97	MD-40	Pet
34	97	MD-41	Pet
35	97	MD-42	Pet
36	97	MD-43	Pet
37	97	MD-44	Pet
38	97	MD-46	Pet
39	97	MD-49	Pet
40	97	MD-50	Pet
41	97	MD-52	Pet
42	97	MD-53	Pet
43	97	MD-54	Pet
44	97	MD-55	Pet
45	97	MD-56	Pet
46	97	MD-58	Pet
47	97	MD-59	Pet
48	97	MD-60	Hal & Pet
49	97	MD-62	Hal
50	97	MD-63	Hal
51	97	MD-64	Hal
52	97	MD-65	Hal
53	97	MD-67	Hal
54	139	MD-68	Hal
55	97	MD-69	Hal
56	97	MD-70	Hal
57	97	MD-71	Hal
58	97	MD-72	Hal
59	97	MD-73	Pet
60	97	MD-74	Pet
61	139	MD-76	Hal

O. Reg. 338/82, s. 4; O. Reg. 149/89, s. 14.

Schedule 20

Abbreviations:
Co for Cochrane
Ken for Kenora

ITEM	COLUMN 1	COLUMN 2	COLUMN 3
1	26	MO-112	Co
2	26	MO-113	Co
3	26 & 27	MO-114	Co
4	27	MO-115	Co
5	26 & 27	MO-116	Co
6	28 & 30	MO-117	Co
7	28 & 30	MO-118	Co
8	27 & 28	MO-119	Co
9	28 & 30	MO-120	Co
10	28	MO-121	Co
11	27 & 28	MO-122	Co
12	27, 30 & 31	MO-123	Co
13	30	MO-124	Co
14	28 & 30	MO-125	Co
15	27	MO-126	Co
16	27	MO-127	Co
17	27	MO-128	Co
18	26 & 27	MO-129	Co
19	30 & 31	MO-130	Ken
20	27	MO-131	Co
21	30 & 31	MO-132	Ken
22	30 & 31	MO-133	Ken
23	27 & 31	MO-135	Ken
24	30 & 31	MO-136	Ken
25	31	MO-137	Ken
26	31	MO-138	Ken
27	26, 27, 31 & 32	MO-139	Ken
28	27, 31 & 32	MO-140	Ken
29	27	MO-141	Co
30	27 & 31	MO-142	Ken
31	30 & 31	MO-143	Co
32	26 & 27	MO-144	Ken
33	27	MO-145	Co
34	26 & 27	MO-146	Co
35	27 & 31	MO-147	Ken
36	27 & 31	MO-148	Ken
37	31	MO-149	Ken
38	27 & 31	MO-150	Ken
39	27	MO-151	Ken
40	28 & 30	MO-152	Co
41	28	MO-154	Co
42	27	MO-155	Co
43	26 & 32	MO-156	Ken
44	28	MO-157	Co
45	27 & 28	MO-158	Co
46	27 & 28	MO-159	Co
47	29	MO-160	Co
48	28 & 29	MO-161	Co
49	28 & 29	MO-162	Co
50	28	MO-168	Co
51	28 & 29	MO-169	Co
52	28	MO-170	Co
53	28	MO-172	Co
54	28	MO-173	Co
55	28	MO-174	Co

ITEM	COLUMN 1	COLUMN 2	COLUMN 3
56	28	MO-175	Co
57	28	MO-176	Co
58	28	MO-177	Co
59	28	MO-178	Co
60	28	MO-180	Co
61	28	MO-181	Co
62	27 & 28	MO-183	Co
63	28	MO-185	Co
64	28	MO-187	Co
65	27	MO-188	Co
66	28	MO-190	Co
67	28	MO-191	Co
68	27 & 28	MO-192	Co
69	29	MO-196	Co
70	29	MO-197	Co
71	29	MO-198	Co
72	27 & 28	MO-200	Co
73	28 & 29	MO-201	Co
74	28	MO-202	Co
75	36	MO-203	Ken
76	36	MO-204	Ken
77	31 & 36	MO-205	Ken
78	36	MO-206	Ken
79	35 & 36	MO-207	Ken
80	35 & 36	MO-208	Ken
81	35 & 36	MO-209	Ken
82	32 & 35	MO-210	Ken
83	35	MO-211	Ken
84	32 & 35	MO-212	Ken
85	31 & 36	MO-213	Ken
86	31	MO-214	Ken
87	31	MO-215	Ken
88	31 & 32	MO-216	Ken
89	31	MO-217	Ken
90	31 & 32	MO-218	Ken
91	31 & 32	MO-219	Ken
92	31 & 32	MO-220	Ken
93	32	MO-222	Ken
94	32	MO-223	Ken
95	32	MO-224	Ken
96	32 & 33	MO-225	Ken
97	32 & 33	MO-226	Ken
98	28	MO-228	Co
99	32 & 33	MO-229	Ken
100	31 & 32	MO-230	Ken
101	31 & 32	MO-231	Ken
102	31	MO-232	Ken
103	31	MO-233	Ken
104	31	MO-234	Ken
105	28	MO-237	Co
106	31	MO-238	Ken
107	33 & 34	MO-386	Ken
108	34	MO-387	Ken
109	33 & 34	MO-388	Ken
110	35	MO-389	Ken
111	32, 33, 34 & 35	MO-390	Ken
112	34 & 35	MO-391	Ken
113	34 & 35	MO-392	Ken
114	34 & 35	MO-393	Ken

ITEM	COLUMN 1	COLUMN 2	COLUMN 3
115	34	MO-394	Ken
116	34	MO-395	Ken
117	35	MO-396	Ken
118	35	MO-397	Ken
119	33	MO-398	Ken
120	140	MO-360	Ken
121	140	MO-361	Ken
122	140	MO-362	Ken
123	140	MO-363	Ken
124	140	MO-364	Ken
125	140	MO-365	Ken
126	140	MO-366	Ken
127	140	MO-367	Ken
128	140	MO-368	Ken

R.R.O. 1980, Reg. 436, Sched. 20; O. Reg. 149/89, s. 15.

Schedule 21

Abbreviations:

T.B. for Thunder Bay

ITEM	COLUMN 1	COLUMN 2	COLUMN 3
1	37	NG-1	T.B.
2	37	NG-2	T.B.
3	37	NG-3	T.B.
4	37	NG-4	T.B.
5	37	NG-5	T.B.
6	37	NG-6	T.B.
7	37	NG-7	T.B.
8	37	NG-8	T.B.
9	37	NG-9	T.B.
10	37	NG-10	T.B.
11	37	NG-11	T.B.
12	37	NG-12	T.B.
13	37	NG-13	T.B.
14	37	NG-14	T.B.
15	37	NG-15	T.B.
16	141	NG-16	T.B.
17	37	NG-17	T.B.
18	37	NG-18	T.B.
19	37	NG-19	T.B.
20	37	NG-20	T.B.
21	37	NG-21	T.B.
22	37	NG-22	T.B.
23	37	NG-23	T.B.
24	37	NG-24	T.B.
25	37	NG-25	T.B.
26	37 & 38	NG-26	T.B.
27	37	NG-27	T.B.
28	37 & 38	NG-28	T.B.
29	38	NG-29	T.B.
30	38	NG-30	T.B.
31	37 & 38	NG-31	T.B.
32	37 & 38	NG-32	T.B.
33	38	NG-34	T.B.
34	38	NG-35	T.B.
35	38	NG-36	T.B.
36	38	NG-37	T.B.
37	38	NG-38	T.B.
38	38	NG-39	T.B.

ITEM	COLUMN 1	COLUMN 2	COLUMN 3
39	38	NG-40	T.B.
40	38	NG-41	T.B.
41	38	NG-42	T.B.
42	38	NG-43	T.B.
43	38	NG-44	T.B.
44	38	NG-45	T.B.
45	38	NG-46	T.B.
46	38	NG-47	T.B.
47	38	NG-48	T.B.
48	38	NG-49	T.B.
49	38	NG-50	T.B.
50	38	NG-51	T.B.
51	38	NG-52	T.B.
52	38	NG-53	T.B.
53	38	NG-54	T.B.
54	38	NG-55	T.B.
55	38	NG-56	T.B.
56	38	NG-57	T.B.
57	38	NG-58	T.B.
58	38	NG-59	T.B.
59	38	NG-60	T.B.
60	38	NG-61	T.B.
61	38	NG-62	T.B.
62	38	NG-63	T.B.
63	38	NG-64	T.B.
64	38	NG-65	T.B.
65	38	NG-66	T.B.
66	38	NG-67	T.B.
67	38	NG-68	T.B.
68	38	NG-69	T.B.
69	38	NG-70	T.B.
70	38	NG-71	T.B.
71	38	NG-73	T.B.
72	109	NG-74	T.B.
73	38	NG-75	T.B.
74	38	NG-76	T.B.
75	38	NG-77	T.B.
76	38	NG-78	T.B.
77	38	NG-79	T.B.
78	38	NG-80	T.B.
79	37 & 38	NG-82	T.B.
80	38	NG-83	T.B.
81	38	NG-84	T.B.
82	37 & 38	NG-85	T.B.
83	141	NG-86	T.B.
84	38	NG-87	T.B.
85	38	NG-88	T.B.
86	38	NG-89	T.B.
87	38	NG-90	T.B.
88	38	NG-91	T.B.
89	38	NG-92	T.B.
90	38	NG-93	T.B.
91	38	NG-94	T.B.
92	38	NG-95	T.B.
93	38	NG-96	T.B.
94	38	NG-97	T.B.
95	38	NG-98	T.B.
96	38	NG-99	T.B.
97	38	NG-100	T.B.
98	38	NG-101	T.B.

ITEM	COLUMN 1	COLUMN 2	COLUMN 3
99	38	NG-102	T.B.
100	38	NG-103	T.B.
101	38	NG-104	T.B.
102	38	NG-105	T.B.
103	38	NG-106	T.B.
104	38	NG-107	T.B.
105	38	NG-108	T.B.
106	38	NG-109	T.B.
107	38	NG-110	T.B.
108	38	NG-111	T.B.
109	38	NG-112	T.B.
110	38	NG-113	T.B.
111	38	NG-114	T.B.
112	38	NG-116	T.B.
113	141	NG-117	T.B.
114	38	NG-118	T.B.
115	38	NG-119	T.B.
116	38	NG-120	T.B.
117	108	NG-33	T.B.

R.R.O. 1980, Reg. 436, Sched. 21; O. Reg. 475/84, s. 11; O. Reg. 149/89, s. 16.

Schedule 22

Abbreviations:

Nip for Nipissing
P.S. for Parry Sound
Sud for Sudbury

ITEM	COLUMN 1	COLUMN 2	COLUMN 3
1	107	NB-1	Sud & Nip
2	107	NB-2	Sud & Nip
3	107	NB-3	Sud & Nip
4	107	NB-4	Sud & Nip
5	107	NB-5	Nip
6	107	NB-6	Nip
7	107	NB-7	Nip
8	107	NB-8	Nip
9	107	NB-9	Nip
10	107	NB-10	Nip
11	107	NB-11	Nip
12	107	NB-12	Sud & Nip
13	107	NB-13	Nip
14	107	NB-14	Nip
15	107	NB-15	Nip
16	107	NB-16	Nip
17	107	NB-17	Nip
18	107	NB-18	Sud & Nip
19	107	NB-19	Nip
20	107	NB-20	Nip
21	107	NB-21	Nip
22	107	NB-22	Nip
23	107	NB-23	Nip
24	107	NB-24	Nip
25	107	NB-25	Nip
26	107	NB-26	Nip
27	107	NB-28	Nip
28	107	NB-29	Nip
29	107	NB-30	Nip
30	107	NB-31	Nip

ITEM	COLUMN 1	COLUMN 2	COLUMN 3
31	107	NB-32	Nip
32	107	NB-33	Nip
33	107	NB-34	Nip
34	107	NB-35	Nip
35	107	NB-36	Sud & Nip
36	107	NB-37	Nip
37	107	NB-38	Nip
38	107	NB-40	Nip
39	107	NB-41	Sud & Nip
40	107	NB-42	Nip
41	107	NB-43	Nip
42	107	NB-44	Nip
43	107	NB-45	Nip
44	107	NB-46	Nip
45	107	NB-47	Nip
46	107	NB-48	Nip
47	107	NB-49	Nip
48	107	NB-50	Sud & Nip
49	107	NB-51	Sud & Nip
50	107	NB-52	Nip
51	107	NB-53	P.S.
52	107	NB-54	P.S.
53	107	NB-55	Nip
54	107	NB-56	Nip
55	107	NB-57	Nip
56	107	NB-58	Nip
57	107	NB-59	Nip
58	107	NB-60	P.S.
59	107	NB-61	P.S.
60	107	NB-62	P.S.
61	107	NB-63	P.S.
62	107	NB-64	Nip
63	107	NB-65	Nip
64	107	NB-66	P.S.
65	107	NB-67	P.S.
66	107	NB-68	P.S.
67	107	NB-69	P.S.
68	107	NB-70	P.S.
69	107	NB-72	Nip
70	107	NB-73	P.S.
71	107	NB-74	P.S.
72	107	NB-75	P.S.
73	107	NB-76	P.S.
74	107	NB-77	P.S.
75	107	NB-78	P.S.
76	107	NB-79	P.S.
77	107	NB-80	Nip
78	107	NB-81	Nip
79	107	NB-82	P.S.
80	107	NB-83	Nip
81	107	NB-84	Nip
82	107	NB-85	Nip
83	107	NB-86	Nip
84	142	NB-87	Nip
85	107	NB-88	Nip

Schedule 23

Abbreviations:
P.S. for Parry Sound

ITEM	COLUMN 1	COLUMN 2	COLUMN 3
1	143	PS-17	P.S.
2	40	PS-40	P.S.
3	40	PS-41	P.S.
4	40	PS-42	P.S.
5	40	PS-43	P.S.
6	40	PS-44	P.S.
7	40	PS-45	P.S.
8	40	PS-46	P.S.
9	143	PS-60	P.S.
10	40	PS-61	P.S.
11	40	PS-62	P.S.
12	40	PS-63	P.S.
13	40	PS-64	P.S.
14	40	PS-66	P.S.
15	40	PS-67	P.S.
16	40	PS-70	P.S.
17	40	PS-72	P.S.
18	40	PS-73	P.S.
19	40	PS-74	P.S.
20	40	PS-76	P.S.
21	40	PS-77	P.S.
22	143	PS-78	P.S.
23	143	PS-79	P.S.
24	143	PS-80	P.S.
25	40	PS-84	P.S.
26	40	PS-85	P.S.
27	40	PS-86	P.S.
28	40	PS-88	P.S.
29	40	PS-89	P.S.
30	144	PS-90	P.S.
31	143	PS-91	P.S.
32	40	PS-94	P.S.
33	40	PS-95	P.S.
34	40	PS-97	P.S.
35	40	PS-110	P.S.
36	40	PS-115	P.S.
37	143	PS-116	P.S.
38	40	PS-117	P.S.
39	143	PS-118	P.S.
40	40	PS-119	P.S.
41	144	PS-129	P.S.
42	40	PS-132	P.S.
43	40	PS-133	P.S.
44	40	PS-134	P.S.
45	40	PS-135	P.S.
46	143	PS-137	P.S.
47	143	PS-139	P.S.
48	40	PS-145	P.S.
49	40	PS-146	P.S.
50	40	PS-147	P.S.
51	144	PS-150	P.S.
52	144	PS-152	P.S.
53	96	PS-153	P.S.
54	96	PS-154	P.S.
55	96	PS-155	P.S.
56	96	PS-156	P.S.

O. Reg. 475/84, s. 12; O. Reg. 149/89, s. 17.

ITEM	COLUMN 1	COLUMN 2	COLUMN 3
57	96	PS-157	P.S.
58	96	PS-158	P.S.
59	96	PS-159	P.S.
60	96	PS-160	P.S.
61	96	PS-161	P.S.
62	96	PS-162	P.S.
63	96	PS-163	P.S.
64	96	PS-164	P.S.
65	98	PS-165	P.S.
66	98	PS-166	P.S.
67	98	PS-167	P.S.
68	98	PS-168	P.S.
69	98	PS-169	P.S.
70	98	PS-170	P.S.
71	98	PS-171	P.S.
72	98	PS-172	P.S.
73	98	PS-173	P.S.
74	98	PS-174	P.S.
75	143	PS-175	P.S.
76	143	PS-176	P.S.
77	144	PS-177	P.S.
78	144	PS-178	P.S.
79	144	PS-179	P.S.
80	144	PS-180	P.S.
81	144	PS-181	P.S.
82	144	PS-182	P.S.
83	144	PS-183	P.S.

O. Reg. 149/89, s. 18.

Schedule 24

Abbreviations:

Ren for Renfrew

ITEM	COLUMN 1	COLUMN 2	COLUMN 3
1	41	PE-1	Ren
2	41	PE-2	Ren
3	41	PE-9	Ren
4	146	PE-15	Ren
5	146	PE-17	Ren
6	41	PE-18	Ren
7	41	PE-19	Ren
8	41	PE-20	Ren
9	41	PE-21	Ren
10	41	PE-22	Ren
11	41	PE-24	Ren
12	41	PE-25	Ren
13	41	PE-26	Ren
14	41	PE-35	Ren
15	41	PE-37	Ren
16	146	PE-38	Ren
17	41	PE-39	Ren
18	120	PE-41	Ren
19	41	PE-42	Ren
20	41	PE-43	Ren
21	41	PE-44	Ren
22	41	PE-46	Ren
23	41	PE-48	Ren
24	41	PE-53	Ren
25	41	PE-54	Ren

ITEM	COLUMN 1	COLUMN 2	COLUMN 3
26	41	PE-55	Ren
27	41	PE-56	Ren
28	41	PE-59	Ren
29	41	PE-60	Ren
30	41	PE-66	Ren
31	41	PE-67	Ren
32	41	PE-68	Ren
33	41	PE-69	Ren
34	41	PE-70	Ren
35	41	PE-71	Ren
36	41	PE-75	Ren
37	41	PE-76	Ren
38	41	PE-77	Ren
39	41	PE-78	Ren
40	41	PE-79	Ren
41	41	PE-80	Ren
42	41	PE-82	Ren
43	41	PE-85	Ren
44	41	PE-86	Ren
45	145	PE-27	Ren
46	145	PE-28	Ren
47	145	PE-29	Ren
48	145	PE-30	Ren
49	145	PE-31	Ren
50	145	PE-32	Ren
51	145	PE-33	Ren
52	145	PE-34	Ren

R.R.O. 1980, Reg. 436, Sched. 24; O. Reg. 475/84, s. 14; O. Reg. 149/89, s. 19.

Schedule 25

Abbreviations:

Ken for Kenora

ITEM	COLUMN 1	COLUMN 2	COLUMN 3
1	43	RL-1	Ken
2	43	RL-2	Ken
3	43	RL-4	Ken
4	43	RL-5	Ken
5	43	RL-6	Ken
6	147	RL-7	Ken
7	43	RL-8	Ken
8	43	RL-9	Ken
9	43	RL-13	Ken
10	43	RL-14	Ken
11	43	RL-15	Ken
12	43	RL-16	Ken
13	43	RL-17	Ken
14	43	RL-18	Ken
15	43	RL-19	Ken
16	43	RL-20	Ken
17	43	RL-21	Ken
18	43	RL-22	Ken
19	43	RL-23	Ken
20	43	RL-24	Ken
21	43	RL-25	Ken
22	43	RL-26	Ken
23	43	RL-27	Ken
24	43	RL-28	Ken

ITEM	COLUMN 1	COLUMN 2	COLUMN 3
25	43	RL-29	Ken
26	43	RL-30	Ken
27	43	RL-31	Ken
28	43	RL-32	Ken
29	43	RL-33	Ken
30	43	RL-34	Ken
31	43	RL-35	Ken
32	43	RL-36	Ken
33	43	RL-37	Ken
34	43	RL-38	Ken
35	43	RL-39	Ken
36	43	RL-40	Ken
37	43	RL-41	Ken
38	43	RL-42	Ken
39	43	RL-43	Ken
40	43	RL-44	Ken
41	43	RL-51	Ken
42	43	RL-52	Ken
43	43	RL-53	Ken
44	43	RL-54	Ken
45	43	RL-56	Ken
46	147	RL-57	Ken
47	43	RL-58	Ken
48	43	RL-59	Ken
49	43	RL-60	Ken
50	43	RL-61	Ken
51	43	RL-63	Ken
52	43	RL-64	Ken
53	43	RL-65	Ken
54	43	RL-66	Ken
55	43	RL-67	Ken
56	43	RL-68	Ken
57	43	RL-69	Ken
58	43	RL-70	Ken
59	43	RL-71	Ken
60	43	RL-72	Ken
61	43	RL-73	Ken
62	43	RL-74	Ken
63	43	RL-75	Ken
64	43	RL-76	Ken
65	43	RL-77	Ken
66	43	RL-86	Ken
67	43	RL-87	Ken
68	43	RL-88	Ken
69	43	RL-89	Ken
70	42 & 43	RL-90	Ken
71	42 & 43	RL-91	Ken
72	43	RL-92	Ken
73	43	RL-93	Ken
74	42 & 43	RL-94	Ken
75	43	RL-95	Ken
76	43	RL-96	Ken
77	43	RL-97	Ken
78	42 & 43	RL-98	Ken
79	42	RL-99	Ken
80	42	RL-100	Ken
81	42 & 43	RL-101	Ken
82	42	RL-102	Ken
83	42	RL-103	Ken
84	42	RL-104	Ken

ITEM	COLUMN 1	COLUMN 2	COLUMN 3
85	43	RL-105	Ken
86	43	RL-106	Ken
87	43	RL-111	Ken
88	42	RL-112	Ken
89	42	RL-113	Ken
90	42 & 43	RL-114	Ken
91	42 & 43	RL-115	Ken
92	43	RL-116	Ken
93	43	RL-117	Ken
94	42	RL-118	Ken
95	42	RL-119	Ken
96	42	RL-120	Ken
97	42	RL-121	Ken
98	42	RL-122	Ken
99	42	RL-123	Ken
100	42	RL-124	Ken
101	42	RL-125	Ken
102	42	RL-126	Ken
103	42	RL-127	Ken
104	42	RL-128	Ken
105	42	RL-130	Ken
106	42	RL-131	Ken
107	42	RL-132	Ken
108	42	RL-133	Ken
109	42	RL-134	Ken
110	148	RL-135	Ken
111	42	RL-136	Ken
112	42	RL-137	Ken
113	148	RL-138	Ken
114	42	RL-139	Ken
115	42	RL-140	Ken
116	42	RL-141	Ken
117	42	RL-142	Ken
118	42	RL-143	Ken
119	42	RL-144	Ken
120	42	RL-145	Ken
121	74	RL-151	Ken
122	42	RL-147	Ken
123	42	RL-148	Ken
124	42	RL-150	Ken
125	75	RL-154	Ken
126	42	RL-152	Ken
127	148	RL-153	Ken
128	42	RL-155	Ken
129	42	RL-156	Ken
130	42	RL-157	Ken
131	42	RL-158	Ken
132	42	RL-159	Ken
133	42	RL-160	Ken
134	42	RL-161	Ken
135	42	RL-162	Ken
136	42	RL-163	Ken
137	42	RL-164	Ken
138	42	RL-165	Ken
139	42	RL-166	Ken
140	42	RL-167	Ken
141	42	RL-168	Ken
142	42	RL-169	Ken
143	42	RL-170	Ken
144	148	RL-171	Ken

ITEM	COLUMN 1	COLUMN 2	COLUMN 3
145	148	RL-172	Ken
146	148	RL-173	Ken
147	42	RL-174	Ken
148	42	RL-175	Ken
149	42	RL-176	Ken
150	42	RL-177	Ken
151	42	RL-178	Ken
152	42	RL-179	Ken
153	42	RL-180	Ken
154	42	RL-181	Ken

R.R.O. 1980, Reg. 436, Sched. 25; O. Reg. 149/89, s. 20.

Schedule 26Abbreviations:
Al for Algoma

ITEM	COLUMN 1	COLUMN 2	COLUMN 3
1	44	SS-1	Al
2	44	SS-2	Al
3	44	SS-3	Al
4	44	SS-4	Al
5	44	SS-5	Al
6	44	SS-6	Al
7	44	SS-7	Al
8	44	SS-8	Al
9	44	SS-9	Al
10	44	SS-10	Al
11	44	SS-11	Al
12	44	SS-12	Al
13	44	SS-13	Al
14	44	SS-14	Al
15	44	SS-15	Al
16	44	SS-16	Al
17	44	SS-17	Al
18	44	SS-18	Al
19	44	SS-19	Al
20	44	SS-20	Al
21	44	SS-21	Al
22	44	SS-22	Al
23	44	SS-23	Al
24	44	SS-24	Al
25	44	SS-25	Al
26	44	SS-26	Al
27	44	SS-27	Al
28	44	SS-28	Al
29	44	SS-29	Al
30	44	SS-30	Al
31	44	SS-31	Al
32	44	SS-32	Al
33	44	SS-33	Al
34	44	SS-34	Al
35	44	SS-35	Al
36	44	SS-36	Al
37	44	SS-37	Al
38	44	SS-38	Al
39	44	SS-39	Al
40	44	SS-40	Al
41	44	SS-41	Al
42	44	SS-42	Al

ITEM	COLUMN 1	COLUMN 2	COLUMN 3
43	44	SS-43	Al
44	44	SS-44	Al
45	44	SS-45	Al
46	44	SS-46	Al
47	44	SS-47	Al
48	44	SS-48	Al
49	44	SS-49	Al
50	44	SS-50	Al
51	44	SS-51	Al
52	44	SS-52	Al
53	44	SS-53	Al
54	44	SS-54	Al
55	44	SS-55	Al
56	44	SS-56	Al
57	44	SS-57	Al
58	44	SS-58	Al
59	44	SS-59	Al

R.R.O. 1980, Reg. 436, Sched. 26.

Schedule 27Abbreviations:
Ken for Kenora
T.B. for Thunder Bay

ITEM	COLUMN 1	COLUMN 2	COLUMN 3
1	85 & 86	SL-2	Ken
2	45 & 46	SL-3	Ken
3	46	SL-4	Ken
4	46	SL-5	Ken
5	46	SL-6	Ken
6	46	SL-7	Ken
7	46	SL-8	Ken
8	46	SL-9	Ken
9	46	SL-10	Ken
10	46	SL-11	Ken
11	46	SL-12	Ken
12	45 & 46	SL-13	Ken
13	84 & 85	SL-14	Ken
14	45	SL-15	Ken
15	45	SL-16	Ken
16	45 & 46	SL-17	Ken
17	45 & 46	SL-18	Ken
18	46	SL-20	Ken
19	46	SL-21	Ken
20	45	SL-22	Ken
21	45	SL-100	Ken
22	45	SL-101	Ken
23	45	SL-102	Ken
24	45	SL-103	Ken
25	45	SL-104	Ken
26	45	SL-105	Ken
27	45	SL-106	Ken
28	45	SL-107	Ken
29	45 & 46	SL-108	Ken
30	45 & 46	SL-109	Ken
31	45	SL-110	Ken
32	45	SL-111	Ken
33	45	SL-112	Ken
34	45	SL-113	Ken

ITEM	COLUMN 1	COLUMN 2	COLUMN 3
35	45 & 46	SL-114	Ken
36	45 & 46	SL-115	Ken
37	46	SL-116	Ken
38	46	SL-117	Ken
39	45 & 46	SL-118	Ken
40	45	SL-119	Ken
41	45	SL-120	Ken
42	45	SL-121	Ken
43	45	SL-122	Ken
44	45 & 46	SL-125	Ken
45	45 & 46	SL-126	Ken
46	46	SL-127	Ken
47	46	SL-128	Ken
48	46	SL-129	Ken
49	46	SL-130	Ken
50	45 & 46	SL-135	Ken
51	46	SL-136	Ken
52	46	SL-137	Ken
53	46	SL-138	Ken
54	46	SL-139	Ken
55	46	SL-140	Ken
56	46	SL-141	Ken
57	46	SL-142	Ken
58	46	SL-143	Ken
59	46	SL-144	Ken
60	46	SL-145	Ken
61	46	SL-146	Ken
62	46	SL-152	T.B.
63	46	SL-153	T.B.
64	46	SL-154	T.B.
65	46	SL-155	T.B.
66	46 & 47	SL-156	T.B.
67	46	SL-157	T.B.
68	46	SL-158	T.B.
69	46	SL-159	T.B.
70	46	SL-160	T.B.
71	46	SL-161	T.B.
72	46	SL-162	T.B.
73	46	SL-163	T.B.
74	46	SL-164	Ken
75	46	SL-165	T.B.
76	47	SL-168	T.B.
77	47	SL-169	T.B.
78	46	SL-170	Ken
79	46	SL-171	Ken
80	46	SL-172	T.B.
81	46 & 48	SL-173	T.B.
82	46	SL-174	T.B.
83	46, 47 & 48	SL-175	T.B.
84	46 & 48	SL-176	T.B.
85	47 & 48	SL-177	T.B.
86	47	SL-178	T.B.
87	47 & 48	SL-179	Ken
88	48	SL-180	Ken
89	46 & 48	SL-181	Ken
90	46 & 48	SL-182	T.B.
91	46	SL-183	Ken
92	46 & 48	SL-184	Ken
93	48	SL-185	Ken
94	46 & 48	SL-186	Ken

ITEM	COLUMN 1	COLUMN 2	COLUMN 3
95	48	SL-187	Ken
96	48	SL-188	Ken
97	48	SL-189	Ken
98	48	SL-190	Ken
99	45, 46, 48 & 49	SL-191	Ken
100	48 & 49	SL-192	Ken
101	48 & 49	SL-193	Ken
102	48 & 49	SL-194	Ken
103	48	SL-195	Ken
104	49	SL-196	Ken
105	49	SL-197	Ken
106	45 & 49	SL-198	Ken
107	49	SL-200	Ken
108	49	SL-201	Ken
109	48 & 49	SL-202	Ken
110	48	SL-203	Ken
111	48 & 49	SL-204	Ken
112	48 & 49	SL-205	Ken
113	48	SL-206	Ken
114	48	SL-207	Ken
115	48 & 49	SL-208	Ken
116	48	SL-209	Ken
117	49	SL-210	Ken
118	48 & 49	SL-211	Ken
119	48	SL-212	Ken
120	48	SL-213	Ken
121	48	SL-214	Ken
122	49	SL-215	Ken
123	49	SL-216	Ken
124	48	SL-220	Ken
125	48	SL-221	Ken
126	48	SL-222	Ken
127	48	SL-223	Ken
128	48	SL-224	Ken
129	48	SL-225	Ken
130	48	SL-226	Ken
131	48	SL-227	Ken
132	48	SL-228	Ken
133	48	SL-229	Ken
134	47, 48 & 52	SL-230	Ken
135	47	SL-231	Ken
136	47	SL-232	Ken
137	47 & 52	SL-233	Ken
138	47 & 52	SL-235	Ken
140	48 & 52	SL-236	Ken
141	48	SL-237	Ken
142	48	SL-238	Ken
143	48	SL-239	Ken
144	48	SL-240	Ken
145	48 & 52	SL-241	Ken
146	48 & 52	SL-242	Ken
147	52	SL-243	Ken
148	52	SL-244	Ken
149	49	SL-250	Ken
150	48 & 49	SL-251	Ken
151	48	SL-252	Ken
152	48	SL-253	Ken
153	48	SL-254	Ken
154	48	SL-255	Ken

ITEM	COLUMN 1	COLUMN 2	COLUMN 3
155	48 & 52	SL-256	Ken
156	48	SL-257	Ken
157	48 & 51	SL-258	Ken
158	48	SL-259	Ken
159	48	SL-260	Ken
160	48 & 51	SL-261	Ken
161	51	SL-262	Ken
162	48 & 51	SL-263	Ken
163	48, 49 & 51	SL-264	Ken
164	48 & 49	SL-265	Ken
165	48 & 49	SL-266	Ken
166	49	SL-267	Ken
167	48, 51 & 52	SL-275	Ken
168	48 & 52	SL-276	Ken
169	52	SL-277	Ken
170	52	SL-278	Ken
171	51 & 52	SL-279	Ken
172	52	SL-280	Ken
173	52	SL-281	Ken
174	51 & 52	SL-282	Ken
175	52	SL-283	Ken
176	51	SL-290	Ken
177	51	SL-291	Ken
178	50	SL-292	Ken
179	50 & 51	SL-293	Ken
180	51	SL-294	Ken
181	51	SL-295	Ken
182	51	SL-296	Ken
183	51	SL-297	Ken
184	51	SL-298	Ken
185	50 & 51	SL-299	Ken
186	51 & 52	SL-310	Ken
187	51 & 52	SL-311	Ken
188	52	SL-312	Ken
189	52	SL-313	Ken
190	52	SL-314	Ken
191	52, 53 & 55	SL-315	Ken
192	52 & 55	SL-316	Ken
193	52 & 55	SL-317	Ken
194	51, 52 & 55	SL-318	Ken
195	51	SL-319	Ken
196	51	SL-320	Ken
197	55	SL-321	Ken
198	55	SL-322	Ken
199	55	SL-323	Ken
200	53 & 55	SL-324	Ken
201	51	SL-330	Ken
202	51	SL-331	Ken
203	51 & 55	SL-332	Ken
204	55	SL-333	Ken
205	51 & 55	SL-334	Ken
206	51 & 55	SL-335	Ken
207	51, 55 & 56	SL-336	Ken
208	51	SL-337	Ken
209	51	SL-338	Ken
210	51 & 55	SL-339	Ken
211	51, 55 & 56	SL-340	Ken
212	50, 51 & 56	SL-350	Ken
213	51 & 56	SL-351	Ken
214	52	SL-375	Ken

ITEM	COLUMN 1	COLUMN 2	COLUMN 3
215	52 & 53	SL-376	Ken
216	53	SL-377	Ken
217	53	SL-378	Ken
218	52 & 53	SL-379	Ken
219	53	SL-380	Ken

R.R.O. 1980, Reg. 436, Sched. 27; O. Reg. 338/82, s. 6; O. Reg. 149/89, s. 21.

Schedule 28

Abbreviations:

Man for Manitoulin
P.S. for Parry Sound
Sud for Sudbury

ITEM	COLUMN 1	COLUMN 2	COLUMN 3
1	149	SU-41	Sud
2	149	SU-42	Sud
3	149	SU-43	Sud
4	149	SU-54	Sud
5	149	SU-55	Sud
6	149	SU-56	Sud
7	149	SU-57	Sud
8	149	SU-59	Sud
9	149	SU-60	Sud
10	149	SU-61	Sud
11	149	SU-70	Man
12	149	SU-73	Sud
13	149	SU-74	Sud
14	149	SU-75	Sud
15	149	SU-76	Sud
16	149	SU-77	Sud
17	149	SU-79	Sud
18	149	SU-80	Sud
19	149	SU-89	Sud
20	149	SU-90	Sud
21	149	SU-91	Sud
22	149	SU-92	Sud
23	149	SU-98	Sud
24	149	SU-99	Sud
25	149	SU-102	Man
26	149	SU-105	Sud
27	149	SU-106	Sud
28	149	SU-107	Sud
29	149	SU-108	Sud
30	149	SU-113	Sud
31	149	SU-120	Sud
32	149	SU-121	Sud
33	149	SU-127	Sud
34	149	SU-128	Sud
35	149	SU-129	Man & Sud
36	149	SU-130	Man
37	149	SU-131	Man
38	149	SU-132	Sud
39	149	SU-133	Sud
40	149	SU-134	Sud
41	149	SU-135	Sud
42	149	SU-141	Sud
43	149	SU-142	Sud
44	149	SU-143	Sud

ITEM	COLUMN 1	COLUMN 2	COLUMN 3
45	149	SU-144	P.S.
46	149	SU-145	Sud
47	149	SU-146	Sud
48	149	SU-147	Sud
49	149	SU-148	Sud
50	149	SU-149	Sud
51	149	SU-150	Sud
52	149	SU-151	Sud
53	149	SU-157	Sud
54	149	SU-158	Sud
55	149	SU-160	Sud
56	149	SU-161	Sud
57	149	SU-162	Sud
58	149	SU-163	Sud
59	149	SU-164	Sud
60	149	SU-169	Sud
61	149	SU-170	Sud
62	149	SU-171	Sud
63	149	SU-173	Sud
64	149	SU-174	Sud
65	149	SU-175	Sud
66	149	SU-176	Sud
67	149	SU-177	Sud
68	149	SU-178	Sud
69	149	SU-179	Sud
70	149	SU-180	Sud
71	149	SU-181	Sud
72	149	SU-182	Sud
73	149	SU-183	Sud
74	149	SU-184	Sud
75	149	SU-185	Sud
76	149	SU-186	Sud
77	149	SU-187	Sud
78	149	SU-188	Sud
79	149	SU-189	Sud
80	149	SU-190	Sud
81	149	SU-191	Sud
82	149	SU-192	Sud
83	149	SU-193	Sud
84	149	SU-194	Sud
85	149	SU-195	Sud
86	149	SU-196	Sud
87	149	SU-197	Sud
88	149	SU-200	Sud
89	149	SU-201	Sud
90	149	SU-257	Sud
91	149	SU-265	Sud
92	149	SU-266	Sud
93	149	SU-267	Sud
94	149	SU-269	Sud
95	149	SU-270	Sud
96	149	SU-272	P.S.
97	149	SU-275	P.S.
98	149	SU-276	P.S.
99	149	SU-277	Sud

O. Reg. 149/89, s. 22.

Schedule 29

Abbreviations:

Nip for Nipissing

Sud for Sudbury

Tim for Timiskaming

ITEM	COLUMN 1	COLUMN 2	COLUMN 3
1	59	TE-1	Nip, Tim & Sud
2	59	TE-2	Tim
3	59	TE-3	Tim
4	59	TE-4	Tim
5	59	TE-5	Tim
6	59	TE-6	Tim
7	59	TE-7	Tim
8	59	TE-8	Tim
9	59	TE-9	Tim
10	150	TE-11	Tim & Nip
11	59	TE-12	Tim & Nip
12	59	TE-13	Tim
13	59	TE-15	Tim & Nip
14	59	TE-16	Tim & Nip
15	59	TE-17	Tim & Nip
16	59	TE-19	Nip
17	59	TE-20	Nip
18	59	TE-21	Tim & Nip
19	59	TE-22	Nip
20	59	TE-23	Nip
21	59	TE-24	Nip
22	59	TE-25	Nip
23	59	TE-26	Nip
24	70	TE-27	Nip
25	59	TE-28	Nip
26	59	TE-29	Nip
27	59	TE-31	Tim
28	70	TE-32	Nip
29	150	TE-33	Tim & Nip

R.R.O. 1980, Reg. 436, Sched. 29; O. Reg. 149/89, s. 23.

Schedule 30

Abbreviations:

T.B. for Thunder Bay

ITEM	COLUMN 1	COLUMN 2	COLUMN 3
1	60	TR-1	T.B.
2	60	TR-2	T.B.
3	60	TR-3	T.B.
4	60	TR-4	T.B.
5	60	TR-5	T.B.
6	60	TR-6	T.B.
7	71	TR-7	T.B.
8	71	TR-8	T.B.
9	60	TR-9	T.B.
10	60	TR-10	T.B.
11	104	TR-11	T.B.
12	104	TR-12	T.B.
13	104	TR-13	T.B.
14	60	TR-14	T.B.
15	154	TR-15	T.B.
16	154	TR-16	T.B.
17	60	TR-17	T.B.
18	60	TR-18	T.B.

ITEM	COLUMN 1	COLUMN 2	COLUMN 3
19	60	TR-19	T.B.
20	60	TR-20	T.B.
21	60	TR-21	T.B.
22	60	TR-22	T.B.
23	60	TR-23	T.B.
24	60	TR-24	T.B.
25	60	TR-25	T.B.
26	60	TR-26	T.B.
27	60	TR-27	T.B.
28	60	TR-28	T.B.
29	60	TR-29	T.B.
30	60	TR-30	T.B.
31	60	TR-31	T.B.
32	60	TR-32	T.B.
33	60	TR-33	T.B.
34	60	TR-34	T.B.
35	60	TR-36	T.B.
36	60	TR-37	T.B.
37	60	TR-38	T.B.
38	60	TR-39	T.B.
39	60	TR-40	T.B.
40	60	TR-41	T.B.
41	60	TR-42	T.B.
42	60	TR-43	T.B.
43	60	TR-44	T.B.
44	60	TR-45	T.B.
45	60	TR-46	T.B.
46	60	TR-47	T.B.
47	60	TR-48	T.B.
48	60	TR-49	T.B.
49	60	TR-50	T.B.
50	60	TR-51	T.B.
51	60	TR-52	T.B.
52	60	TR-53	T.B.
53	60	TR-54	T.B.
54	60	TR-55	T.B.
55	60	TR-56	T.B.
56	60	TR-57	T.B.
57	60	TR-58	T.B.
58	60	TR-59	T.B.
59	60	TR-60	T.B.
60	60	TR-61	T.B.
61	60	TR-62	T.B.
62	60	TR-65	T.B.
63	102 & 103	TR-66	T.B.
64	60	TR-67	T.B.
65	60	TR-68	T.B.
66	60	TR-69	T.B.
67	60	TR-70	T.B.
68	60	TR-71	T.B.
69	60	TR-72	T.B.
70	60	TR-73	T.B.
71	60	TR-74	T.B.
72	60	TR-75	T.B.
73	102 & 103	TR-63	T.B.
74	104	TR-64	T.B.

Schedule 31

Abbreviations:

T.B. for Thunder Bay

ITEM	COLUMN 1	COLUMN 2	COLUMN 3
1	61	TB-4	T.B.
2	61	TB-10	T.B.
3	61	TB-12	T.B.
4	61	TB-13	T.B.
5	61	TB-14	T.B.
6	61	TB-15	T.B.
7	61	TB-16	T.B.
8	61	TB-21	T.B.
9	61	TB-22	T.B.
10	61	TB-23	T.B.
11	61	TB-24	T.B.
12	61	TB-25	T.B.
13	61	TB-26	T.B.
14	61	TB-27	T.B.
15	61	TB-29	T.B.
16	61	TB-30	T.B.
17	61	TB-31	T.B.
18	61	TB-33	T.B.
19	61	TB-34	T.B.
20	61	TB-35	T.B.
21	61	TB-36	T.B.
22	61	TB-37	T.B.
23	61	TB-41	T.B.
24	61	TB-42	T.B.
25	151	TB-43	T.B.
26	61	TB-44	T.B.
27	61	TB-45	T.B.
28	61	TB-46	T.B.
29	151	TB-47	T.B.
30	151	TB-48	T.B.
31	61	TB-49	T.B.
32	61	TB-50	T.B.
33	61	TB-51	T.B.
34	61	TB-52	T.B.
35	151	TB-53	T.B.
36	151	TB-54	T.B.
37	61	TB-55	T.B.
38	77	TB-56	T.B.
39	61	TB-57	T.B.
40	61	TB-59	T.B.
41	61	TB-60	T.B.
42	61	TB-61	T.B.
43	61	TB-62	T.B.
44	61	TB-63	T.B.
45	61	TB-64	T.B.
46	61	TB-65	T.B.
47	61	TB-66	T.B.
48	61	TB-67	T.B.
49	61	TB-68	T.B.
50	61	TB-69	T.B.
51	61	TB-70	T.B.
52	61	TB-72	T.B.
53	61	TB-73	T.B.
54	61	TB-74	T.B.
55	61	TB-75	T.B.
56	61	TB-76	T.B.

ITEM	COLUMN 1	COLUMN 2	COLUMN 3
57	61	TB-77	T.B.
58	151	TB-78	T.B.
59	61	TB-79	T.B.
60	61	TB-80	T.B.
61	61	TB-81	T.B.
62	61	TB-82	T.B.
63	61	TB-83	T.B.
64	61	TB-84	T.B.
65	151	TB-85	T.B.
66	61	TB-86	T.B.
67	61	TB-87	T.B.
68	61	TB-88	T.B.
69	61	TB-89	T.B.
70	61	TB-90	T.B.
71	61	TB-91	T.B.
72	61	TB-92	T.B.
73	61	TB-93	T.B.
74	61	TB-94	T.B.
75	61	TB-95	T.B.
76	61	TB-96	T.B.
77	151	TB-97	T.B.
78	61	TB-98	T.B.
79	61	TB-99	T.B.
80	61	TB-100	T.B.
81	61	TB-101	T.B.
82	61	TB-102	T.B.
83	61	TB-103	T.B.
84	61	TB-104	T.B.
85	61	TB-105	T.B.
86	151	TB-106	T.B.
87	61	TB-107	T.B.
88	61	TB-108	T.B.
89	61	TB-109	T.B.
90	151	TB-111	T.B.
91	61	TB-112	T.B.
92	61	TB-113	T.B.
93	61	TB-114	T.B.
94	61	TB-115	T.B.
95	61	TB-117	T.B.
96	61	TB-118	T.B.
97	61	TB-120	T.B.
98	61	TB-121	T.B.
99	61	TB-123	T.B.
100	61	TB-124	T.B.
101	61	TB-125	T.B.
102	61	TB-126	T.B.
103	61	TB-128	T.B.
104	61	TB-129	T.B.
105	61	TB-130	T.B.
106	61	TB-131	T.B.
107	61	TB-132	T.B.
108	61	TB-133	T.B.
109	61	TB-134	T.B.
110	61	TB-135	T.B.
111	61	TB-136	T.B.
112	61	TB-137	T.B.
113	61	TB-138	T.B.
114	61	TB-139	T.B.
115	61	TB-140	T.B.
116	61	TB-141	T.B.

ITEM	COLUMN 1	COLUMN 2	COLUMN 3
117	61	TB-142	T.B.
118	61	TB-143	T.B.
119	61	TB-144	T.B.
120	61	TB-145	T.B.
121	61	TB-147	T.B.
122	61	TB-148	T.B.
123	61	TB-149	T.B.
124	61	TB-150	T.B.
125	61	TB-151	T.B.
126	78	TB-152	T.B.
127	61	TB-153	T.B.
128	61	TB-154	T.B.
129	61	TB-158	T.B.
130	61	TB-159	T.B.
131	61	TB-161	T.B.
132	61	TB-162	T.B.
133	61	TB-163	T.B.
134	61	TB-164	T.B.
135	61	TB-165	T.B.
136	61	TB-166	T.B.
137	61	TB-167	T.B.
138	61	TB-170	T.B.
139	61	TB-172	T.B.
140	61	TB-173	T.B.
141	61	TB-176	T.B.
142	61	TB-184	T.B.
143	61	TB-193	T.B.
144	151	TB-194	T.B.
145	76	TB-146	T.B.
146	77	TB-17	T.B.
147	77	TB-38	T.B.
148	77	TB-71	T.B.
149	78	TB-119	T.B.
150	151	TB-157	T.B.
151	151	TB-119	T.B.

R.R.O. 1980, Reg. 436, Sched. 31; O. Reg. 149/89, s. 25.

Schedule 32

Abbreviations:

Co for Cochrane

Sud for Sudbury

Tim for Timiskaming

ITEM	COLUMN 1	COLUMN 2	COLUMN 3
1	152	TI-1	Sud & Tim
2	152	TI-2	Sud
3	152	TI-3	Tim
4	152	TI-4	Tim
5	152	TI-5	Sud & Tim
6	152	TI-6	Sud
7	152	TI-7	Sud
8	152	TI-8	Sud
9	152	TI-9	Sud & Tim
10	152	TI-10	Co
11	152	TI-11	Tim
12	152	TI-12	Tim
13	152	TI-13	Tim & Co
14	152	TI-14	Tim & Co
15	152	TI-15	Tim & Sud

ITEM	COLUMN 1	COLUMN 2	COLUMN 3
16	152	TI-16	Tim & Sud
17	152	TI-17	Tim, Co & Sud
18	152	TI-18	Tim, Co & Sud
19	152	TI-19	Tim & Co
20	152	TI-20	Co
21	152	TI-21	Tim & Co
22	152	TI-22	Tim & Co
23	152	TI-23	Co
24	152	TI-24	Tim & Co
25	152	TI-25	Co
26	152	TI-26	Co
27	152	TI-27	Sud & Tim
28	152	TI-28	Co
29	152	TI-29	Sud & Co
30	152	TI-30	Sud & Tim
31	152	TI-31	Co
32	152	TI-32	Co
33	152	TI-33	Co
34	152	TI-34	Sud & Tim
35	152	TI-35	Co
36	152	TI-36	Co
37	152	TI-37	Co
38	152	TI-38	Co
39	152	TI-39	Co
40	152	TI-40	Co
41	152	TI-41	Co
42	152	TI-42	Sud & Co
43	152	TI-43	Co
44	152	TI-44	Co
45	152	TI-45	Tim
46	152	TI-46	Tim & Co
47	152	TI-47	Co
48	152	TI-48	Co
49	152	TI-49	Tim
50	152	TI-50	Co
51	152	TI-51	Sud
52	152	TI-53	Sud

O. Reg. 149/89, s. 26.

Schedule 33

Abbreviations:

- Fro for Frontenac
- Has for Hastings
- L&A for Lennox and Addington
- Lan for Lanark
- Ren for Renfrew

ITEM	COLUMN 1	COLUMN 2	COLUMN 3
1	153	TW-1	Has
2	153	TW-2	L&A
3	153	TW-3	Has
4	153	TW-4	Has
5	153	TW-5	Has
6	153	TW-6	Has
7	153	TW-7	Has
8	153	TW-8	Has
9	153	TW-9	L&A
10	153	TW-10	L&A
11	153	TW-11	L&A
12	153	TW-12	Has & L&A

ITEM	COLUMN 1	COLUMN 2	COLUMN 3
13	153	TW-13	L&A
14	153	TW-14	L&A
15	153	TW-15	L&A
16	153	TW-16	L&A
17	153	TW-17	L&A
18	153	TW-18	L&A
19	153	TW-19	L&A
20	153	TW-20	L&A
21	153	TW-21	L&A
22	153	TW-22	L&A
23	153	TW-23	L&A
24	153	TW-24	L&A
25	153	TW-25	L&A
26	153	TW-26	Fro
27	153	TW-27	Fro
28	153	TW-28	L&A
29	153	TW-29	Fro
30	153	TW-30	Fro & L&A
31	153	TW-31	Fro
32	153	TW-32	Fro
33	153	TW-33	Fro & L&A
34	153	TW-34	Fro
35	153	TW-35	Fro
36	153	TW-36	Fro
37	153	TW-37	Fro
38	153	TW-38	Fro
39	153	TW-39	Fro
40	153	TW-41	Fro
41	153	TW-42	Fro
42	153	TW-44	Fro
43	153	TW-45	Fro
44	153	TW-46	Fro
45	153	TW-47	Fro, Lan & Ren
46	153	TW-48	Fro
47	153	TW-49	Fro
48	153	TW-50	Fro

O. Reg. 149/89, s. 27.

Schedule 34

Abbreviations:

- Al for Algoma
- Sud for Sudbury
- T.B. for Thunder Bay

ITEM	COLUMN 1	COLUMN 2	COLUMN 3
1	82	WA-1	T.B. & Al
2	82	WA-2	T.B. & Al
3	82	WA-3	Al
4	82	WA-4	Al
5	82	WA-5	Al & T.B.
6	82	WA-7	T.B.
7	82	WA-8	T.B.
8	82	WA-9	T.B.
9	82	WA-10	T.B.
10	82	WA-11	T.B.
11	82	WA-6	Al & T.B.
12	82	WA-12	Al & T.B.
13	82	WA-13	Al
14	82	WA-14	Al

ITEM	COLUMN 1	COLUMN 2	COLUMN 3
15	82	WA-15	Al
16	82	WA-16	Al
17	82	WA-17	Al
18	82	WA-26	Al
19	82	WA-27	Al
20	82	WA-28	Al
21	82	WA-36	T.B. & Al
22	82	WA-29	Al & T.B.
23	82	WA-30	T.B.
24	82	WA-31	T.B.
25	82	WA-32	T.B.
26	82	WA-33	T.B.
27	82	WA-122	T.B.
28	82	WA-34	T.B.
29	82	WA-35	T.B. & Al
30	82	WA-37	T.B. & Al
31	82	WA-50	Al
32	82	WA-38	Al
33	82	WA-39	Al
34	82	WA-18	Al
35	82	WA-19	Al
36	82	WA-20	Al
37	82	WA-21	Al
38	82	WA-22	Al
39	82	WA-23	Al
40	82	WA-24	Al
41	82	WA-25	Al
42	82	WA-40	Al
43	82	WA-41	Al
44	82	WA-42	Al
45	82	WA-43	Al
46	82	WA-46	Al
47	82	WA-47	Al
48	82	WA-48	Al
49	82	WA-49	Al
50	82	WA-53	Al
51	82	WA-65	Al
52	82	WA-66	Al
53	82	WA-52	Al & T.B.
54	82	WA-71	Al & T.B.
55	82	WA-51	T.B.
56	82	WA-68	T.B. & Al
57	82	WA-69	T.B.
58	82	WA-70	T.B.
59	82	WA-72	Al
60	82	WA-54	Al
61	82	WA-55	Al
62	82	WA-56	Al
63	82	WA-57	Al
64	82	WA-45	Al
65	82	WA-44	Al
66	82	WA-58	Al
67	82	WA-62	Al
68	82	WA-63	Al
69	82	WA-64	Al
70	82	WA-73	Al
71	82	WA-74	Al
72	82	WA-75	Al
73	82	WA-76	Al
74	82	WA-61	Al

ITEM	COLUMN 1	COLUMN 2	COLUMN 3
75	82	WA-59	Al
76	82	WA-60	Al
77	82	WA-78	Al
78	82	WA-77	Al
79	82	WA-81	Al
80	82	WA-82	Al
81	82	WA-83	Al
82	82	WA-84	Al
83	82	WA-85	Al
84	82	WA-86	Al
85	82	WA-80	Al
86	82	WA-79	Al & Sud
87	82	WA-88	Al
88	82	WA-87	Al
89	82	WA-92	Al
90	82	WA-93	Al
91	82	WA-94	Al
92	82	WA-95	Al
93	82	WA-96	Al
94	82	WA-97	Al
95	82	WA-98	Al
96	82	WA-99	Al
97	82	WA-100	Al
98	82	WA-101	Al
99	82	WA-91	Al
100	82	WA-90	Al & Sud
101	82	WA-89	Al & Sud
102	82	WA-102	Al & Sud
103	82	WA-104	Al
104	82	WA-105	Al
105	82	WA-106	Al
106	82	WA-107	Al
107	82	WA-108	Al
108	82	WA-109	Al
109	82	WA-110	Al
110	82	WA-111	Al
111	82	WA-103	Al & Sud
112	82	WA-112	Al & Sud
113	82	WA-113	Al
114	82	WA-114	Al
115	82	WA-115	Al
116	82	WA-116	Al
117	82	WA-117	Al
118	82	WA-118	Al
119	82	WA-119	Al
120	82	WA-120	Al & Sud
121	82	WA-121	Al & Sud
122	82	WA-123	T.B.
123	82	WA-67	Al & T.B.

R.R.O. 1980, Reg. 436, Sched. 34.

REGULATION 527**TRAPS**

1.—(1) No person shall use a trap that has a hook or sharpened device capable of impaling a fur-bearing animal.

- (2) No person shall use a spring pole set except with a killing trap.
- (3) No person shall use a deadfall.
- (4) No person shall set a leg-hold trap in a tree or on a pole or other location so that the captured animal may be suspended in mid-air.
- (5) No person shall use a trap that has teeth or serrations on its jaws. O. Reg. 673/82, s. 1 (1-5).
- (6) No person shall set a leg-hold trap, except a footsnare, for a fur-bearing animal other than bobcat, coyote, fox, lynx or wolf.
- (7) Subsection (6) does not apply to a person who sets a leg-hold trap for beaver, muskrat, otter or mink if the trap is,
- (a) set under ice; or
 - (b) attached to,
 - (i) a sliding lock on a drowning wire or a device that will immediately submerge the captured animal in water and prevent it from resurfacing, or
 - (ii) a heavy object that will dislodge immediately upon springing of the trap and will submerge the captured animal in water and prevent it from resurfacing. O. Reg. 5/85, s. 1 (1), *part*.
- (8) Subsection (6) does not apply to a person who sets a leg-hold trap for mink or muskrat if the trap will submerge the captured animal in water immediately upon springing of the trap and is sufficiently heavy to prevent it from resurfacing. O. Reg. 5/85, s. 1 (1), *part*; O. Reg. 329/85, s. 1.
- (9) Subsection (6) does not apply to a person who sets a leg-hold trap on land for red squirrel or weasel if the trap is enclosed and set so as to kill the captured animal immediately upon springing of the trap.
- (10) No person shall use a suspended snare unless,
- (a) the snare is set for rabbit or red squirrel; or
 - (b) a snare lock is used in such a manner that the noose is prevented from expanding.
- (11) No person shall use a body-gripping trap known as a Number 110 Conibear trap or any trap that is of similar construction and has equivalent or less killing power unless,
- (a) the trap is set for muskrat; or
 - (b) the trap is set for mink in such a manner that the captured animal will be drowned immediately upon springing of the trap. O. Reg. 5/85, s. 1 (1), *part*.
- (12) Except as part of a water set used in the trapping of beaver and otter, no person shall use a body-gripping trap with a jaw spread greater than 21 centimetres (8.27 inches) in the part of Ontario described in paragraph 2 of Schedule 4 to Regulation 427 of Revised Regulations of Ontario, 1980, as that paragraph read on the 31st day of December, 1990.
- (13) No person shall trap for bear except with a footsnare, box or culvert trap. O. Reg. 673/82, s. 1 (7, 8).
- (14) No person shall set or use a leg-hold trap for the purpose of taking a bird except with the written authority of the Minister and subject to the terms and conditions that the Minister may impose. O. Reg. 136/89, s. 1.
- (15) No person shall use a leg-hold trap with a jaw spread greater than,
- (a) 17 centimetres (6.69 inches), when set on land; or
 - (b) 21 centimetres (8.27 inches), when set in water for beaver or otter.
- (16) Despite subsection (15), a person who is entitled to use a leg-hold trap may trap for timber wolf (*Canis lupus*) with a leg-hold trap with a jaw spread not exceeding 23 centimetres (9.06 inches), if the person is authorized to do so in the area and with respect to the time, number of traps, type of traps, and in accordance with the terms and conditions specified in the written permission issued therefor by the district manager of the administrative district of the Ministry of Natural Resources in which the permission is sought. O. Reg. 673/82, s. 1 (9, 10).
- (17) No person shall, on land, use a leg-hold trap with a trap chain whose length exceeds 31 centimetres (12.2 inches), unless drags are used. O. Reg. 5/85, s. 1 (2).
- (18) In subsection (17), "trap chain" includes a chain, cable, rope, wire or similar device and any combination thereof, and the length of a trap chain is the distance,
- (a) where the trap chain is attached above ground to an object, measured between the object and the nearest part of the trap; or
 - (b) where the trap chain is attached under ground to an object, measured between the intersection of the trap chain with the surface of the ground and the nearest point of the trap. O. Reg. 377/83, s. 1.
- (19) In subsection (20), "live holding trap" means a trap that is not designed to kill or set to kill or drown the captured animal immediately upon springing of the trap.
- (20) A person referred to in clause 30 (3) (a) or (b) of the Act (licensed trapper, farmer) shall inspect at least once daily every live holding trap set by the person. O. Reg. 5/85, s. 1 (3), *part*.
- (21) Subsection (20) does not apply in the parts of Ontario lying north of the line formed by the centre line of the most northerly east-west line of the Canadian National Railway Company and the centre line of the forest access road constructed on the site of what was formerly part of that east-west line of the Canadian National Railway Company between the villages of Calstock and Nakina. O. Reg. 11/90, s. 1, *part*.
- 2.—(1) No person shall possess a body-gripping trap designed to kill an animal or bird or a leg-hold trap unless the person,
- (a) is lawfully entitled to use such traps;
 - (b) was lawfully entitled to use such traps within the preceding five years;
 - (c) is engaged or concerned in the business of manufacturing, repairing, selling, transporting or storing such traps or the business of conducting research with respect to such traps;
 - (d) is a collector of such traps and the trap is rendered incapable of being used for trapping;
 - (e) is conducting research into such traps in the course of engagement or employment by an educational institution or a government; or
 - (f) possesses such traps for educational purposes in the course of employment by an educational institution or a government.
- (2) Subsection (1) does not apply with respect to traps in a

museum or public display if most of the funding for the museum or display comes from a government or governments in Canada. O. Reg. 12/90, s. 1.

REGULATION 528

TRAPS—ORDER UNDER SUBSECTION 30 (4) OF THE ACT

1. The prohibition set out in subsection 30 (2) of the Act does not apply to the area of Ontario lying north of the French and the Mat-tawa rivers. O. Reg. 155/81, s. 1.

REGULATION 529

WATERS SET APART—FROGS

1. The waters described in the Schedule are set apart for the conservation of frogs. R.R.O. 1980, Reg. 437, s. 1.

Schedule

All that part of Nogies Creek in the townships of Galway and Harvey in the County of Peterborough, lying south of the dam at the southerly extremity of Bass Lake in the said Township of Galway, and lying within lots 9 and 10 in Concession I and Lot 9 in Concession II in the said Township of Galway and lots 27, 28, 29 and 30 in Concession XVII and lots 27, 28, 29, 30, 31 and 32 in Concession XVI in the said Township of Harvey. R.R.O. 1980, Reg. 437, Sched.

REGULATION 530

WILDLIFE MANAGEMENT UNITS

1. The parts of Ontario numbered and described in the Schedule are designated as wildlife management units. O. Reg. 155/82, s. 1.

2. In the Schedule, "WMU" means Wildlife Management Unit. O. Reg. 155/82, s. 2.

Schedule

WILDLIFE MANAGEMENT UNITS

WMU 1

All that land in the Territorial District of Kenora, Patricia Portion, in the Province of Ontario described in WMUs 1A, 1B, 1C and 1D.

WMU 1A

All that land in the Territorial District of Kenora, Patricia Portion, in the Province of Ontario described as follows:

Beginning at the intersection of the Interprovincial Boundary between Ontario and Manitoba with the southern shore of Hudson Bay; thence in a southwesterly direction along that Interprovincial Boundary to the intersection of the northwesterly production of a straight line joining the intersection of longitude 89° 00' and latitude 54° 00' with the intersection of longitude 91° 30' and latitude 55° 00'; thence southeasterly in a straight line along that production and that straight line to the intersection of longitude 89° 00' and latitude 54° 00'; thence easterly along latitude 54° 00' to longitude 83° 45'; thence northerly along longitude 83° 45' to latitude 55° 00'; thence westerly along latitude 55° 00' to longitude 87° 00'; thence northerly along longitude 87° 00' to the southern shore of Hudson Bay; thence northwesterly along the shore of Hudson Bay to the place of beginning.

WMU 1B

All that land in the Territorial District of Kenora, Patricia Portion, in the Province of Ontario described as follows:

Beginning at the intersection of longitude 87° 00' with the southern shore of Hudson Bay, thence southerly along longitude 87° 00' to latitude 55° 00'; thence easterly along latitude 55° 00' to longitude 83° 45'; thence southerly along longitude 83° 45' to latitude 54° 00'; thence easterly along latitude 54° 00' to the westerly shore of James Bay; thence northerly, westerly and northwesterly along the shore of James Bay and Hudson Bay to the place of beginning.

WMU 1C

All that land in the Territorial District of Kenora, Patricia Portion, in the Province of Ontario described as follows:

1. Beginning at the intersection of the Interprovincial Boundary between Ontario and Manitoba with the centre line of Moar Lake; thence in an easterly, northeasterly and southeasterly direction along the centre line of Moar Lake and the main channel of the Berens River System, composed of Sharpstone Lake, Stout Lake, Pikangikum Lake, Berens Lake and Nechigona Lake to the centre line of Goose Lake; thence easterly and northerly along the centre line of Goose Lake and the most northerly bay of Goose Lake to the intersection with the 11th Base Line; thence easterly along that base line to longitude 92° 30'; thence northerly along longitude 92° 30' to the intersection with the Interprovincial Boundary between Ontario and Manitoba; thence southwestwardly and southerly along that Interprovincial Boundary to the place of beginning.

2. Beginning at the intersection of the longitude 92° 30' with the 11th Base Line; thence easterly along that base line to longitude 89° 00'; thence northerly along longitude 89° 00' to the intersection with the southwestwardly boundary of Wunnumin Lake Indian Reserve 86; thence southeasterly along that southwestwardly boundary to the southeasterly boundary of that Indian Reserve; thence northeasterly along that southeasterly boundary to the northeasterly boundary of that Indian Reserve; thence northwesterly along that northeasterly boundary to the intersection with longitude 89° 00'; thence northerly along longitude 89° 00' to latitude 54° 00'; thence northwesterly in a straight line to the intersection of longitude 91° 30' and latitude 55° 00'; thence northwesterly on a production of that straight line to the intersection with the Interprovincial Boundary between Ontario and Manitoba; thence southwestwardly along that Interprovincial Boundary to the intersection with longitude 92° 30'; thence southerly along longitude 92° 30' to the place of beginning.

WMU 1D

All that land in the Territorial District of Kenora, Patricia Portion, in the Province of Ontario described as follows:

1. Beginning at the intersection of longitude 89° 00' with the 11th Base Line; thence easterly along that base line to the centre line of the Wabassi River; thence easterly, southerly, northeasterly and easterly along the sinuosities of that centre line to the centre line of the Albany River; thence southeasterly, easterly and southeasterly along the sinuosities of the last mentioned centre line to the intersection with the northerly production of the westerly boundary of the geographic Township of Bicknell; thence northerly along that northerly production to latitude 54° 00'; thence westerly, along latitude 54° 00' to longitude 89° 00'; thence southerly along longitude 89° 00' to the intersection with the northeasterly boundary of Wunnumin Lake Indian Reserve 86; thence southeasterly along that northeasterly boundary to the southeasterly boundary of that Indian Reserve; thence southwestwardly along that southeasterly boundary to the southwestwardly boundary of that Indian Reserve; thence northwesterly along that southwestwardly boundary to the intersection with longitude 89° 00'; thence southerly along longitude 89° 00' to the place of beginning.

2. Beginning at the intersection of the northerly production of the westerly boundary of the geographic Township of Bicknell with lati-

tude 54° 00'; thence southerly along that northerly production to the centre line of the Albany River; thence in a southeasterly and north-easterly direction along the sinuosities of that centre line and the centre line of the South channel of that river to the western shore of James Bay; thence northerly along that western shore to latitude 54° 00'; thence westerly along latitude 54° 00' to the place of beginning.

WMU 2

All that land in the Territorial District of Kenora, Patricia Portion, in the Province of Ontario described as follows:

Beginning at the intersection of the Interprovincial Boundary between Ontario and Manitoba with the 7th Base Line; thence easterly along that base line to the centre line of the Sturgeon River flowing through Fletcher Lake; thence in a northeasterly and northerly direction along the centre line of the Sturgeon River flowing through Fletcher Lake, Roger Lake and Right Lake to the centre line of Sydney Lake; thence in a northeasterly direction along that centre line to the centre line of the most northeasterly bay of Sydney Lake; thence along that centre line to the intersection with the high water mark on the most northeasterly bay of Sydney Lake; thence continuing in a northeasterly direction along connecting waterways and portages to the intersection with the high water mark on the south shore of Longlegged Lake; thence in a northeasterly direction across Longlegged Lake to a small stream draining into the said lake; thence in a northerly direction along portages and interconnecting waters to the intersection with the high water mark on the most southerly extremity of Upper Medicine Stone Lake; thence in a general northeasterly direction along the centre line of Upper Medicine Stone Lake to the southerly production of the centre line of the stream connecting Upper Medicine Stone Lake and Medicine Stone Lake; thence northerly along that production and the centre line of that stream and its northerly production across Medicine Stone Lake to a stream flowing into Tack Lake; thence northerly along that stream, the centre line of Tack Lake and the stream connecting Tack Lake and Parker Lake, the centre line of Parker Lake and the northeasterly production of the centre line of Parker Lake to the centre line of Red Lake; thence in a general westerly and northwesterly direction along the centre line of Red Lake through Middle Narrows, Pipestone Narrows and Pipestone Bay to the intersection with the high water mark along the northerly shore of Pipestone Bay; thence easterly in a straight line to the intersection with the high water mark at the most westerly extremity of Hammell Lake; thence in a northeasterly direction along the centre line of Hammell Lake to the intersection with the high water mark at the most northerly extremity of Hammell Lake; thence northerly in a straight line to the intersection with the high water mark at the most southwesterly extremity of Alford Lake; thence in a southeasterly, northeasterly and northwesterly direction along the centre line of interconnecting waters composed of Alford Lake, Corallen Lake and Little Vermilion Lake to the intersection with the southeasterly production of the centre line of the Chukuni River; thence in a northwesterly and northerly direction along that production and the centre line of the Chukuni River composed of Rathouse Lake and Odin Lake to the intersection with the high water mark at the most northwesterly extremity of Odin Lake; thence northwesterly in a straight line to the intersection with the high water mark at the most southerly extremity of Borel Lake; thence in a northerly direction along the centre line of Borel Lake to the intersection with the centre line of the Dowling River; thence in a northeasterly and northerly direction along the centre line of the Dowling River composed of Harding Lake, Hornblendite Lake, Dowling Lake and Pikangikum Lake to the intersection with the southeasterly production of the centre line of the main channel of the Berens River; thence in a northwesterly, westerly and southwesterly direction along that production and the centre line of the main channel of the Berens River composed of Stout Lake and Sharpstone Lake to the centre line of Moar Lake; thence westerly along that centre line to the intersection with the Interprovincial Boundary between Ontario and Manitoba; thence southwesterly along the Interprovincial Boundary between Ontario and Manitoba to the place of beginning.

WMU 3

All that land in the Territorial District of Kenora, Patricia Portion, in the Province of Ontario described as follows:

Beginning at the intersection of the centre line of the Sturgeon River flowing through Fletcher Lake with the 7th Base Line; thence easterly along that base line to the intersection with the centre line of the English River; thence in a northeasterly direction along that centre line composed of Oak Lake, Wilcox Lake, Goose Lake, Wegg Lake, Barnston Lake and Camping Lake to the intersection with the centre line of that part of the King's Highway known as No. 105; thence in a northerly direction along that centre line to the intersection with the centre line of that part of the King's Highway known as Secondary Highway No. 657; thence in a northeasterly direction along that centre line to the intersection with the centre line of the right of way of Ontario Hydro in the geographic Township of Knott; thence in a northeasterly and northerly direction along that centre line to the intersection with the high water mark on the easterly shore of Shabumeni Lake; thence in a northerly direction along that high water mark, along the stream between Little Shabumeni Lake and Shabumeni Lake and the high water mark of Little Shabumeni Lake to the most northerly extremity of Little Shabumeni Lake; thence northwesterly in a straight line to the intersection with the high-water mark along the most southeasterly extremity of Mainprize Lake; thence in a northerly direction along the centre line of Mainprize Lake to the intersection with the centre line of the Berens River; thence in a northerly, northwesterly and westerly direction along the centre line composed of Southwest Lake, Upper Goose Lake, Mamakwash Lake, Goose Lake, Berens Lake and Pikangikum Lake to the intersection with the centre line of Pikangikum Lake; thence in a southerly direction along that centre line to the intersection with the centre line of the Dowling River; thence in a southerly and westerly direction along that centre line composed of Dowling Lake, Hornblendite Lake, Harding Lake and Borel Lake to the intersection with the high water mark along the most southerly extremity of Borel Lake; thence in a southeasterly direction along a straight line to the intersection of the high water mark along the most northwesterly extremity of Odin Lake; thence in a southerly direction along the centre line of Odin Lake to the intersection with the centre line of Chukuni River; thence in a southeasterly direction along that centre line composed of Rathouse Lake and the southeasterly production of the Chukuni River to the centre line of Little Vermilion Lake; thence in a southwesterly direction along that centre line and the centre line of interconnecting waters composed of Corallen Lake and Alford Lake to the intersection with the high water mark along the most southwesterly extremity of Alford Lake; thence southerly in a straight line to the intersection with the high water mark along the most northerly extremity of Hammell Lake; thence in a southwesterly direction along the centre line of Hammell Lake to the most westerly extremity thereof; thence westerly in a straight line to the high water mark along the most northeasterly extremity of Pipestone Bay; thence in a southerly, easterly and southerly direction along the centre line of Pipestone Bay, Pipestone Narrows and Middle Narrows of Red Lake and Red Lake to the northeasterly production of the centre line of Parker Lake; thence southwesterly along that production and the centre line of Parker Lake, the stream connecting Parker Lake and Tack Lake, and the centre line of Tack Lake, to the stream between Tack Lake and Medicine Stone Lake; thence southerly along that stream and its southerly production across Medicine Stone Lake to the stream between Medicine Stone Lake and Upper Medicine Stone Lake; thence southerly along that stream and its southerly production to the centre line of Upper Medicine Stone Lake; thence in a southwesterly direction along the centre line of Upper Medicine Stone Lake to the most southwesterly extremity thereof; thence in a southerly direction along connecting waterways and portages to a stream flowing into Longlegged Lake; thence southwesterly across Longlegged Lake to and along portages and waterways to the most northeasterly bay of Sydney Lake, the centre line of Sydney Lake and the centre line of the Sturgeon River composed of Right Lake and Roger Lake to the centre line of Fletcher Lake; thence southwesterly along that centre line to the place of beginning.

WMU 4

All that land in the Territorial District of Kenora, Patricia Portion, in the Province of Ontario described as follows:

Beginning at the intersection of the centre line of that part of the King's Highway known as No. 105 with the centre line of the English River; thence easterly along that centre line of the English River; thence easterly along that centre line and the easterly production of that centre line to the centre line of Lac Seul; thence in a southeasterly and easterly direction along that centre line through Shanty Narrows, Poplar Narrows, Manitou Narrows and Sen Bay and Bindo Lake to the most easterly extremity of Bindo Lake; thence southeasterly to the most northerly extremity of Stranger Lake; thence in a southwesterly direction along the centre line of Stranger Lake, the creek between McDougall Bay of Marchington Lake and Stranger Lake and McDougall Bay to the most southwesterly extremity thereof; thence south astronomically to the centre line of the right of way of the Canadian National Railway Company; thence easterly along that centre line to the connecting waters between Singapore Lake and Tawatina Lake; thence in a northeasterly direction along the centre line of that stream, Tawatina Lake, Tawatina River and Lewis Lake to the portage at the northerly limit of Lewis Lake; thence northeasterly along that portage to the southerly extremity of Farrington Lake; thence in a northerly and westerly direction along the centre line of Farrington Lake and Schist Lake, both forming part of the Marchington River, to a stream flowing from Runway Lake; thence northeasterly along that stream to the most southerly extremity of Runway Lake; thence in a westerly direction along small lakes and portages to the most southerly extremity of Moose Lake; thence in a northeasterly direction along the centre line of Moose Lake, Moose Creek and Elam Lake to the most southerly bay of Ragged Wood Lake, thence westerly and northerly along the centre line of the most southerly bay of Ragged Wood Lake, the connecting waters between the most southerly bay of Ragged Wood Lake and Mask Lake, and Mask Lake to the centre line of the Vermilion River; thence northerly and westerly along that centre line, the waters connecting the Vermilion River and Enrae Lake, and Enrae Lake to the high water mark along the northerly bank of the waters connecting Enrae Lake and Sleen Lake; thence westerly along that high water mark and the high water mark along the northerly shore of Sleen Lake to the most northerly extremity of Sleen Lake; thence westerly in a straight line to the most southerly extremity of McNeely Lake; thence in a northeasterly direction along the centre lines of McNeely Lake, Free Creek, Adamhay Lake, Root River, Root Bay and the West Channel of Lake St. Joseph, Blackstone Lake, Roadhouse Lake, Bamaji Lake and North Bamaji Lake to the centre line of the right-of-way of Ontario Hydro at Slate Falls; thence in a westerly direction along that centre line to the intersection with the centre line of the north-south right-of-way of Ontario Hydro in the geographic Township of Dent; thence in a southwesterly direction along that centre line to the intersection with the centre line of that part of the King's Highway known as Secondary Highway No. 657; thence in a westerly direction along that centre line to the intersection with the centre line of that part of the King's Highway known as No. 105; thence in a southeasterly direction along that centre line to the place of beginning.

WMU 5

All that land in the Territorial District of Kenora in the Province of Ontario described as follows:

Beginning at the intersection of the centre line of the right-of-way of the Canadian National Railway Company with the centre line of that part of the King's Highway known as Secondary Highway No. 647 in the Town of McIntosh; thence in a southeasterly direction along the centre line of that King's Highway to the intersection with the southwesterly production of the centre line of Smellie Lake; thence in a northeasterly direction along that production and the centre line of Smellie Lake and along the centre line of the stream connecting Smellie Lake and Bowden Lake to the intersection with the centre line of the right of way of the Canadian National Railway Company; thence in an easterly direction along that centre line to the

intersection with the westerly boundary of the geographic Township of Breithaupt; thence southerly and easterly along the westerly and southerly boundaries of that township to the northeasterly corner of the geographic Township of Drope; thence southerly along the easterly boundary of the geographic townships of Drope and Brownridge to the southeast corner of the geographic Township of Brownridge; thence easterly along the southerly boundary of the geographic Township of Hartman; thence southerly and easterly along the westerly and southerly boundary of that township to the intersection with the centre line of that part of the King's Highway known as No. 72; thence in a southwesterly direction along that centre line to the intersection with the centre line of that part of the King's Highway known as No. 17; thence in a southeasterly direction along that centre line to the intersection with the easterly boundary of the geographic Township of Hodgson; thence northerly along that boundary, the easterly boundary of the geographic Township of Hyndman and the production of that boundary to the intersection with the centre line of the stream flowing into Basket Lake; thence in a northeasterly direction along that centre line to the intersection of the high water mark at the most southerly extremity of Basket Lake; thence in a northerly and northeasterly direction along the centre line of that lake to the intersection with the high water mark of the most northeasterly bay of that lake; thence northerly in a straight line to the intersection with the high water mark of the most southwesterly lake connecting with the Amik River; thence northerly along the centre line of that lake to the intersection with the centre line of the Amik River; thence in a northerly and northeasterly direction along that centre line composed of Amik Lake and Loggers Lake to the intersection with the centre line of the English River; thence in an easterly direction along that centre line composed of Flying Loon Lake and Jarvis Lake to the intersection with the centre line of Jarvis Lake; thence in a northeasterly direction along that centre line to the intersection with the high water mark at the most northerly extremity of that lake; thence northerly along a straight line to the intersection with the high water mark at the most westerly extremity of Lake of Bays; thence in a northeasterly and northwesterly direction along a centre line connecting Lake of Bays, Lake of Bays River, Conver Lake and Singapore Lake to the intersection of the connecting waters between Singapore Lake and Tawatina Lake with the centre line of the right of way of the Canadian National Railway Company; thence westerly along that centre line to a line drawn south astronomically from the most southwesterly extremity of McDougall Bay; thence north astronomically along that line to the southwesterly extremity of McDougall Bay; thence northeasterly along the centre line of McDougall Bay, the stream between McDougall Bay and Stranger Lake, and the centre line of Stranger Lake to the most northerly extremity thereof; thence northwesterly to the most easterly extremity of Bindo Lake; thence westerly and northerly along the centre line of Bindo Lake to the centre line of Sen Bay of Lac Seul; thence in a westerly and northwesterly direction along the centre line of Sen Bay and the centre line of Lac Seul composed of Manitou Narrows, Poplar Narrows and Shanty Narrows to the easterly production of the centre line of the English River; thence westerly along that production in a southwesterly, southerly and southeasterly direction along the centre line of the English River composed of Camping Lake, Barnston Lake, Wegg Lake, Goose Lake, Wilcox Lake, Oak Lake, Maynard Lake, Tide Lake and Ball Lake and the Wabigoon River composed of Segise Lake and Canyon River to the most northerly extremity of Outlet Bay of Canyon Lake; thence in a southerly and easterly direction along the centre line of Outlet Bay and Canyon Lake to the intersection with a straight line extending northerly from the high water mark of Canyon Lake at the Town of McIntosh; thence southerly along that straight line to the place of beginning.

WMU 6

All that land in the territorial districts of Kenora and Kenora, Patricia Portion, in the Province of Ontario described as follows:

Beginning at the intersection of the Interprovincial Boundary between Ontario and Manitoba with the centre line of the right of way of the Canadian National Railway Company; thence easterly along that centre line to the intersection with a straight line extending southerly from the high water mark of Canyon Lake at the Town of McIntosh; thence northerly along that straight line to the intersec-

tion of the high water mark of Canyon Lake; thence northwesterly, northerly and westerly along a centre line connecting Canyon Lake, Outlet Bay, Canyon River, Segise Lake and the Wabigoon River to the intersection with the centre line of the English River System; thence in a northwesterly, northeasterly and northerly direction along that centre line composed of Ball Lake, Tide Lake and Maynard Lake to the intersection with the 7th Base Line; thence westerly along that base line to the intersection with the Interprovincial Boundary between Ontario and Manitoba; thence southerly along that Interprovincial Boundary to the place of beginning.

WMU 7

All that land in the Territorial District of Kenora in the Province of Ontario described in WMUs 7A and 7B.

WMU 7A

All that land in the Territorial District of Kenora in the Province of Ontario described as follows:

Aulneau Peninsula west of Turtle Portage excluding all off-shore islands in Lake of the Woods.

WMU 7B

All that land in the Territorial District of Kenora in the Province of Ontario described as follows:

Beginning at the intersection of the Interprovincial Boundary between Ontario and Manitoba with the International Boundary between Canada and the United States of America; thence easterly and southerly along that boundary to the intersection with latitude 49° 00'; thence easterly along that latitude to the intersection with the high water mark on the easterly shore of Lake of the Woods; thence northerly following that high water mark to the intersection with the centre line of a road known as No. 4; thence easterly along that road to the intersection with the centre line of that part of the King's Highway known as Secondary Highway No. 619; thence southerly along that centre line to the intersection with the centre line of that part of the King's Highway known as Secondary Highway No. 600; thence easterly along that centre line to the intersection with the centre line of the southerly production of a road running north and east across the geographic townships of Dewart, Rowe and Menary; thence northerly and easterly along that production and that centre line to the intersection with the centre line of that part of the King's Highway known as No. 71; thence northerly along that centre line to the intersection with the centre line of Regina Bay of Lake of the Woods at Sioux Narrows; thence easterly along that centre line and its easterly production to the centre line of Dogpaw Lake; thence easterly, northerly and westerly along the centre lines of lakes and connecting waterways composed of Dogpaw Lake, Caviar Lake, Denmark Lake, Atikwa Lake, Populus Lake and Betula Lake to the intersection with the high water mark on the westerly shore of the most westerly extremity of Betula Lake; thence westerly in a straight line to the intersection with the high water mark on the easterly shore of the most easterly extremity of Warclub Lake, thence westerly, northerly and easterly along the centre line of Warclub Lake, Dryberry Lake, Point Bay, Point Lake, Teggau Lake and Vermilion Bay to the intersection with the high water mark on the northerly shore of Vermilion Bay at the Town of Vermilion Bay; thence northerly in a straight line to the intersection with the centre line of that part of the King's Highway known as Secondary Highway No. 647; thence northwesterly along that centre line to the intersection with the centre line of the right of way of the Canadian National Railway Company; thence westerly along that centre line to the intersection with the Interprovincial Boundary between Ontario and Manitoba; thence southerly along that boundary to the place of beginning.

Saving and excepting therefrom all those lands known as Aulneau Peninsula west of Turtle Portage excluding all off-shore islands in the Lake of the Woods.

WMU 8

All that land in the Territorial District of Kenora in the Province of Ontario described as follows:

Beginning at the intersection of the centre line of that part of the King's Highway known as No. 17 with the centre line of that part of the King's Highway known as Secondary Highway No. 647; thence northwesterly along the centre line of that part of the King's Highway known as Secondary Highway No. 647 to the intersection with the southwesterly production of the centre line of Smellie Lake; thence in a northeasterly direction along that production and the centre line of Smellie Lake, along the centre line of the stream connecting Smellie Lake and Bowden Lake to the intersection with the centre line of the right of way of the Canadian National Railway Company; thence easterly along that centre line to the intersection with the westerly boundary of the geographic Township of Breithaupt; thence southerly and easterly along the westerly and southerly boundaries of that township to the northeast corner of the geographic Township of Drope; thence southerly along the easterly boundaries of the geographic townships of Drope and Brownbridge to the southeast corner of the geographic Township of Brownbridge; thence easterly along the southerly boundary of the geographic Township of Laval to the northwest corner of the geographic Township of Hartman; thence southerly and easterly along the westerly and southerly boundary of that township to the intersection with the centre line of that part of the King's Highway known as No. 72; thence southwesterly along that centre line to the intersection with the centre line of that part of the King's Highway known as No. 17; thence southeasterly along that centre line to the intersection with the centre line of McKenzie Creek; thence westerly, southwesterly and southerly along that centre line and connecting waters composed of McKenzie Creek, Dinorwic Lake, Stanawan Bay, Minnehaha Lake and Peak Lake to the intersection with the production of the centre line of the portage between Peak Lake and Sasakwei Lake; thence westerly along that centre line to the intersection with the centre line of Sasakwei Lake; thence southerly along that centre line and connecting waters and portage composed of Saskewei Lake and Kabagukski Lake to the intersection with the easterly production of a straight line from the most northerly extremity of Trafalgar Bay of Upper Manitou Lake; thence westerly along that straight line to the intersection with the centre line of Trafalgar Bay; thence southwesterly, northwesterly, westerly and northerly along that centre line and connecting waters and portage composed of Upper Manitou Lake, Manitou Straits, Lower Manitou Lake, Calder Lake, Syndicate Lake, Picture Narrows Lake, Clefrock Lake, Pan Lake, Lawrence Lake, Hill Lake, Brooks Lake, Rowan Lake, Denmark Lake, Atikwa Lake, Populus Lake and Betula Lake to the intersection with the high water mark on the westerly shore of the most westerly extremity of Betula Lake; thence westerly in a straight line to the intersection with the high water mark on the easterly shore of the most easterly extremity of Warclub Lake; thence westerly, northerly and easterly along the centre line of Warclub Lake and connecting waters composed of Warclub Lake, Dryberry Lake, Point Bay, Point Lake, Teggau Lake and Vermilion Bay to the intersection with the high water mark on the northerly shore of Vermilion Bay at the Dispersed Rural Community of Vermilion Bay; thence northerly in a straight line to the place of beginning.

WMU 9

All that land in the territorial districts of Kenora and Rainy River in the Province of Ontario described in WMUs 9A and 9B.

WMU 9A

All that land in the Territorial District of Kenora in the Province of Ontario described as follows:

Beginning at the intersection of that part of the King's Highway known as No. 17 with the centre line of McKenzie Creek; thence westerly, southwesterly and southerly along the centre line of McKenzie Creek and connecting waters composed of McKenzie Creek, Dinorwic Lake, Stanawan Bay, Minnehaha Lake and Peak Lake to the intersection with the production of the centre line of the

portage between Peak Lake and Sasakwei Lake; thence westerly along that centre line to the intersection with the centre line of Sasakwei Lake; thence southerly along that centre line and connecting waters and portages composed of Sasakwei Lake and Kabagukski Lake to the intersection with the easterly production of a straight line from the most northerly extremity of Trafalgar Bay of Upper Manitou Lake; thence westerly along that straight line to the intersection with the centre line of Trafalgar Bay; thence southwesterly, northwesterly, westerly and northerly along the centre line of lakes, connecting waters and portage composed of Upper Manitou Lake, Manitou Straits, Lower Manitou Lake, Calder Lake, Syndicate Lake, Picture Narrows Lake, Clefrock Lake, Pan Lake, Lawrence Lake, Hill Lake, Brooks Bay, Rowan Lake, Denmark Lake, Caviar Lake, Dogpaw River, Dogpaw Lake, the westerly production of the centre line of Dogpaw Lake and Regina Bay of Lake of the Woods to the intersection with the centre line of that part of the King's Highway known as No. 71 at Sioux Narrows; thence in a southerly direction along that centre line to the intersection with the southerly boundary of the Territorial District of Kenora; thence in an easterly direction along that boundary to the intersection with the centre line of Eltrut Lake, being part of the Turtle River System; thence in a northerly, easterly and northeasterly direction along the centre line of that river system composed of Eltrut Lake, Jones Lake, Pekaoging Lake, Bending Lake and Bending Creek to the intersection with the southerly boundary of the geographic Township of Hodgson; thence easterly along that boundary to the intersection with the centre line of Revell Lake; thence northerly along that centre line to the intersection with the centre line of the Revell River; thence northerly along that centre line to the intersection with the centre line of that part of the King's Highway known as No. 17; thence northwesterly along that centre line to the place of beginning.

WMU 9B

All that land in the Territorial District of Rainy River in the Province of Ontario described as follows:

Beginning at the intersection of the northerly boundary of the Territorial District of Rainy River with the centre line of that part of the King's Highway known as No. 71; thence in a southerly direction along that centre line to the intersection with the centre line of a road known as Camp 404 Road; thence easterly along that centre line to the intersection with the centre line of the right-of-way of Ontario Hydro; thence southeasterly along that centre line to the intersection with the westerly production of the southerly boundary of Indian Reserve 16A; thence easterly along that production and that southerly boundary to the intersection with the high water mark on the westerly shore of Sand Bay of Rainy Lake; thence in a northeasterly and northerly direction along that high water mark to the intersection with the centre line of that part of the King's Highway known as No. 11; thence in an easterly direction along that centre line to the intersection with a straight line drawn south from the most easterly extremity of Little Turtle Lake; thence northerly along that straight line to the high water mark of that extremity of Little Turtle Lake; thence westerly, northeasterly, northerly and easterly along the centre line of that part of the Turtle River System composed of Little Turtle Lake, Turtle River, Robinson Lake and Eltrut Lake to the intersection with the northerly boundary of the Territorial District of Rainy River; thence westerly along that boundary to the place of beginning.

WMU 10

All that land in the Territorial District of Rainy River in the Province of Ontario described as follows:

Beginning at the intersection of the International Boundary between the United States of America and Canada with latitude 49° 00'; thence easterly along that latitude to the intersection with the high water mark on the easterly shore of Lake of the Woods; thence northerly following that high water mark to the intersection with the centre line of a road known as No. 4; thence easterly along that road to the intersection with the centre line of that part of the King's Highway known as Secondary Highway No. 619; thence southerly along that centre line to the intersection with the centre line of that part of the King's Highway known as Secondary Highway No. 600;

thence easterly along that centre line to the intersection with the centre line of the southerly production of a road running north, east and west across the geographic townships of Dewart, Rowe and Menary; thence northerly and easterly along that production and that centre line to the intersection with the centre line of that part of the King's Highway known as No. 71; thence continuing easterly along the centre line of a road known as Camp 404 Road to the intersection with the centre line of the right-of-way of Ontario Hydro; thence southeasterly along that centre line to the intersection with the westerly production of the southerly boundary of Indian Reserve 16A; thence easterly along that production and that southerly boundary to the intersection with the high water mark on the westerly shore of Sand Bay of Rainy Lake; thence southerly along that high water mark to the intersection with the centre line of the right of way of the former Duluth, Winnipeg and Pacific Railway Company, now the right of way of the Canadian National Railway Company; thence easterly along that centre line to the intersection with the International Boundary between the United States of America and Canada; thence westerly, southerly and northerly along that boundary to the place of beginning.

WMU 11

All that land in the territorial districts of Rainy River and Thunder Bay described in WMUs 11A and 11B.

WMU 11A

All that land in the Territorial District of Rainy River in the Province of Ontario described as follows:

1. Beginning at the intersection of the centre line of the right of way of the Duluth, Winnipeg and Pacific Railroad Company with the centre line of that part of the King's Highway known as No. 11; thence southeasterly along the centre line of the right of way of the Duluth, Winnipeg, and Pacific Railroad Company to the International Boundary between the United States of America and Canada; thence in a general easterly direction along that International Boundary to the intersection with the westerly boundary of Quetico Provincial Park at Lac La Croix; thence in an easterly, northerly, westerly, northerly and northeasterly direction along the boundary of Quetico Provincial Park to the intersection with a point on the southerly limit of the right of way of that part of the King's Highway known as No. 11, said point being distant 116.827 metres measured on a course of north 75° 28' west from monument number 30 planted in the southern limit of said right of way; thence north 14° 32' east 45.720 metres to the centre line of the said right-of-way; thence westerly along that centre line to the place of beginning.

2. Premising that the bearings hereinafter mentioned are astronomical:

1. Beginning at monument Number 30 planted in the southerly limit of the right-of-way of that part of the King's Highway known as No. 11 as shown on Ministry of Transportation Plan P.3076-4; thence north 75° 28' west along that southerly limit 116.827 m; thence south 63° 38' 50" west 6,386.243 m; thence south 78° 03' 40" west 693.383 m; thence north 64° 30' 30" west 3,978.679 m; thence south 64° 29' east 1,092.809 m; thence south 60° 28' 40" west, 1,748.007 m; thence north 86° 29' 20" west, 2,760.769 m; thence north 64° 59' 40" west 323.932 m; thence south 65° 30' west 3,038.536 m; thence south 64° 29' 40" west 1,699.071 m; thence south 68° 29' 20" west 1,076.084 m; thence north 8° 31' 10" west 591.129 m; thence north 8° 31' west 816.715 m; thence 8° 30' 50" west 730.947 m; thence north 66° 33' 50" west 461.425 m; thence north 66° 33' 40" west 555.608 m; thence north 66° 33' 30" west 1,429.616 m; thence north 66° 33' 10" west 661.108 m; thence north 66° 32' 50" west 633.624 m; thence north 66° 32' 30" west 1,816.084 m; thence north 66° 32' 10" west 1,854.955 m; thence south 32° 14' 30" west 5,588.532 m; thence north 67° 45' 50" west 2,360.789 m; thence north 89° 45' 30" west, 3,747.784 m; thence north 84° 35' 10" west 400.260 m; thence south 34° 44' 10" west 398.127 m; thence south 82° 54' 50" west 1,797.951 m; thence north 81° 20' west 7,164.385 m; thence south 81° 42' 20" west 11,196.471 m; thence south 31° 37' 00" west 1,872.087 m; thence south 1° 56' 40" west 551.505 m; thence south 79° 51' 30" west 875.270 m; thence south 79° 51' 10" west 899.008 m; thence south 79°

50' 50" west 660.255 m; thence south 79° 50' 20" west 873.099 m; thence south 73° 38' 10" west 710.282 m; thence south 73° 38' 00" west 1,469.115 m; thence south 35° 46' 00" west 2,693.585 m; thence south 53° 36' 00" west 3,454.073 m; thence south 42° 12' 30" west 2,807.144 m; thence north 57° 23' 00" west 2,637.233 m; thence south 53° 43' 10" west 4,869.567 m; thence south 11° 15' 30" west 2,749.473 m; thence south 47° 09' 50" west 3,803.517 m; thence south 27° 46' 50" west 2,444.932 m; thence south 72° 01' 10" west 1,235.364 m; thence south 44° 15' 20" west 1,747.866 m more or less to the water's edge along the northerly shore of Namakan River; thence in a southeasterly direction along that water's edge to the northerly limit of Neguaguon Lake Indian Reserve No. 25D; thence easterly along that northerly limit to the northeasterly corner thereof; thence southerly along the easterly limit of Neguaguon Lake Indian Reserve No. 25D and its southerly production to the water's edge along the northerly shore of Bell Island, thence in a southwesterly direction along that water's edge to the most westerly extremity of Bell Island; thence west astronomically 60.960 m more or less to the water's edge along the easterly shore of Lac La Croix; thence in a southwesterly direction along that water's edge to the confluence with the waters of Martin Bay; thence in an easterly, southerly and westerly direction along the water's edge of Martin Bay to the confluence with the waters of Lac La Croix; thence in a general southerly direction along the water's edge of Lac La Croix and Rice Bay of Lac La Croix to the northerly limit of Namakan rapids at the mouth of Namakan River; thence west astronomically to the confluence of the waters of Lac La Croix with the waters of Namakan River; thence in a southerly, easterly and northerly direction along the water's edge of Lac La Croix to a point in a line drawn east astronomically from monument 615 planted in the survey of the International Boundary between Canada and the United States of America; thence east astronomically to that International Boundary; thence in a southeasterly and northeasterly direction along that International Boundary to the westerly boundary of the Territorial District of Thunder Bay; thence northerly along that boundary to the four mile post planted by O.S. Gillon, Ontario Land Surveyor in 1926; thence north 0° 03' 20" west 1,220.380 m; thence north 89° 56' 00" east 2,850.328 m; thence north 2° 28' 20" east 1,366.165 m; thence north 77° 21' 40" east 3,624.218 m; thence north 54° 10' 20" east 2,108.634 m; thence north 2° 10' 30" east 1,782.269 m; thence north 89° 49' 50" west 1,234.062 m; thence south 58° 26' 30" west 859.658 m; thence north 89° 49' 00" west 3,006.931 m; thence south 79° 24' 30" west 3,308.372 m; more or less to the westerly boundary of the Territorial District of Thunder Bay; thence northerly along that boundary to the water's edge along the southerly shore of Smally Lake; thence in a westerly, northwesterly and northeasterly direction along that water's edge to the westerly boundary of the Territorial District of Thunder Bay; thence northerly along that westerly boundary to the water's edge along the southerly shore of Bitchu Lake; thence in a northwesterly and northeasterly direction along that water's edge to the westerly boundary of the Territorial District of Thunder Bay; thence northerly along that westerly boundary to the water's edge along the southerly shore of Ross Lake; thence in a westerly, northerly and easterly direction along that water's edge to the westerly boundary of the Territorial District of Thunder Bay; thence northerly along that westerly boundary to the two mile post; thence northerly along that westerly boundary 1,062.338 m; thence north 58° 00' 30" east 624.843 m; thence north 20° 00' 30" east 504.008 m; thence north 26° 59' 30" west 571.463 m; thence south 73° 00' 30" west 462.991 m; to the westerly boundary of the Territorial District of Thunder Bay; thence northerly along that westerly boundary 895.036 m; thence south 89° 59' 30" east 301.758 m; thence north 57° 00' 30" east 552.517 m; thence north 12° 00' 30" west 386.075 m; thence north 76° 00' 30" west 705.371 m; to the westerly boundary of the Territorial District of Thunder Bay; thence northerly along that boundary to the five mile post 838.877 m; thence continuing northerly along that westerly boundary 428.214 m; thence north 74° 59' 50" east 826.901 m; thence north 19° 01' 10" west 1,219.468 m; thence north 56° 49' west 478.277 m to the westerly boundary of the Territorial District of Thunder Bay; thence northerly along that westerly boundary to the water's edge along the southerly shore of Tilly Lake; thence in a general southwesterly and northeasterly direction along that water's edge to the westerly boundary of the Territorial District of Thunder Bay; thence northerly along that westerly boundary to the water's edge of a small bay of Tilly Lake; thence in a general

westerly and northeasterly direction along that water's edge to the westerly boundary of the Territorial District of Thunder Bay; thence northerly along that westerly boundary to the southerly limit of the right of way of that part of the King's Highway known as No. 11; thence westerly along that southerly limit to the place of beginning.

2. Beginning at a point in the northerly limit of the right of way of that part of the King's Highway known as No. 11 distant 91.440 m measured north 17° 31' 30" east from monument number 86 as shown on Ministry of Transportation Plan P.3076-9; thence southeasterly along that highway limit on a course to the right having a radius of 918.908 m, an arc distance of 30.480 m, the chord equivalent being 30.480 m measured south 71° 31' 29" east; thence north 17° 31' 30" east 305.306 m; thence north 72° 28' 30" west, 1,188.720 m, thence south 17° 31' 30" west 304.800 m to the intersection with the northerly limit of the right of way of that part of the King's Highway known as No. 11, and shown on Ministry of Transportation Plan P.3076-4; thence south 72° 28' 30" east along that highway limit 1,158.240 m, more or less to the place of beginning.

WMU 11B

All that land in the Territorial District of Thunder Bay in the Province of Ontario described as follows:

Beginning at the intersection of the centre line of that part of the King's Highway known as No. 11 with the northerly production of the easterly boundary of Quetico Provincial Park; thence in a southerly direction along that northerly production and that easterly boundary to the intersection with the centre line of Saganaga Lake; thence in a northeasterly direction along the centre line of interconnecting lakes and waterways composed of Saganaga Lake, Northeast Arm, North Channel, Trafalgar Bay, Weikwabinow River, Nelson Creek and Nelson Lake to the intersection with the high water mark at the most northerly extremity of Nelson Lake; thence in a north-easterly direction along a straight line to the intersection with the centre line of Clovenhoof Lake; thence in a general easterly direction along that centre line to the intersection with the high water mark at the most easterly extremity of Clovenhoof Lake; thence in a southeasterly direction along a straight line to the intersection with the high water mark at the most westerly extremity of Hoof Lake; thence in a general easterly and northerly direction along the centre line of interconnecting lakes and waterways composed of Hoof Lake, Hoof Creek, Kekekuab Lake, Kekek Creek, Blossom Lake, Matawin River, Shebandowan River and the Oskondaga River to the intersection with the centre line of that part of the King's Highway known as No. 11; thence in a westerly direction along that centre line to the place of beginning.

WMU 12

All that land in the territorial districts of Kenora, Rainy River and Thunder Bay in the Province of Ontario described in WMUs 12A and 12B.

WMU 12A

All that land in the territorial districts of Kenora and Thunder Bay in the Province of Ontario, described as follows:

Beginning at the intersection of the centre line of that part of the King's Highway known as No. 17 with the centre line of the Revell River; thence in a southerly direction along that centre line and the centre line of Revell Lake to the intersection with the southerly boundary of the geographic Township of Hodgson; thence in a westerly direction along that boundary to the intersection with the centre line of Bending Creek, being part of the Turtle River System; thence in a southerly, westerly and southwesterly direction along the centre line of that river system composed of Bending Creek, Bending Lake, Pekagoning Lake, Turtle River, Jones Lake and Eltrut Lake to the intersection with the southerly boundary of the Territorial District of Kenora; thence in an easterly direction along that boundary to the centre line of the Seine River; thence in a southeasterly direction along that centre line to the Ontario Hydro dam at the end of the Blind Bay Road; thence in a northeasterly direction along the centre line of the Blind Bay Road to the intersection with the centre line of

that part of the King's Highway known as No. 17; thence in a north-westerly direction along that centre line to the place of beginning.

WMU 12B

All that land in the Territorial District of Rainy River in the Province of Ontario described as follows:

1. Beginning at the intersection of the centre line of that part of the King's Highway known as No. 11 with the centre line of that part of the King's Highway known as No. 623; thence westerly along the centre line of the King's Highway No. 11 to the intersection with a straight line drawn south astronomically from the high water mark at the most easterly extremity of Little Turtle Lake; thence northerly along that line to the intersection with high water mark on the most easterly extremity of Little Turtle Lake; thence in a westerly, north-easterly, northerly and easterly direction along that part of the Turtle River System composed of Little Turtle Lake, Turtle River, Robinson Lake and Eltrut Lake to the intersection with the northerly boundary of the Territorial District of Rainy River; thence in an easterly direction along that boundary to the intersection with the centre line of the Seine River; thence in a southwesterly direction along the centre line of that river to the intersection with the centre line of the gravel road known locally as the Premier Lake Road; thence in a generally southerly direction along the centre line of that road to the intersection with the centre line of that part of the King's Highway known as No. 625; thence southerly along that centre line to the place of beginning.

2. Beginning at the intersection of the centre line of that part of the King's Highway known as No. 11 with the centre line of that part of the King's Highway known as No. 623; thence in a general northerly direction along the centre line of the King's Highway to the intersection with a gravel road known locally as the Premier Lake Road; thence continuing in a general northerly direction along the centre line of the Premier Lake Road to the intersection with the centre line of the Seine River; thence in a northeasterly, easterly and southeasterly direction along the centre line of the Seine River to the Ontario Hydro dam at the end of the Blind Bay Road; thence in a northeasterly direction along the centre line of the Blind Bay Road to the intersection with the centre line of that part of the King's Highway known as No. 17; thence in a generally southeasterly direction along the centre line of that highway to the intersection with the centre line of that part of the King's Highway known as No. 11; thence in a westerly direction along the centre line of that highway to a point distant 45.720 metres measured north $17^{\circ} 31' 30''$ east from the monument number 86, as shown on Ministry of Transportation Plan P.3076-9;

Thence southeasterly along that highway limit on a course to the right having a radius of 918.908 m, an arc distance of 30.480 m, the chord equivalent being 30.480 metres measured south $71^{\circ} 31' 29''$ east; thence north $17^{\circ} 31' 30''$ east 305.306 m; thence north $72^{\circ} 28' 30''$ west 1188.720 m; thence south $17^{\circ} 31' 30''$ west 350.520 m to the intersection with the centre line of the right-of-way of that part of the King's Highway known as No. 11, and shown on Ministry of Transportation Plan P.3076-4; thence in a westerly direction along the centre line to the place of beginning.

WMU 13

All that land in the Territorial District of Thunder Bay in the Province of Ontario described as follows:

Beginning at the intersection of the centre line of that part of the King's Highway known as No. 17 with the centre line of the right-of-way of TransCanada Pipelines Limited in the geographic Township of Gibbard; thence in an easterly direction along the last mentioned centre line to the intersection with the centre line of the Nipigon River; thence in a southerly direction along the centre line of the Nipigon River System composed of the Nipigon River, Helen Lake and Nipigon Bay of Lake Superior to the intersection with a straight line drawn west astronomically from Hughes Point to the intersection of the centre line of the right-of-way of the Canadian National Railway Company with the centre line of that part of the King's Highway known as Secondary Highway No. 628; thence in a westerly direction

along that straight line to that intersection; thence in a southwesterly direction along the centre line of the right-of-way of the Canadian National Railway Company to the intersection with the centre line of the Black Sturgeon River; thence in a general southeasterly and southwesterly direction along that centre line to the intersection with the high water mark of Black Bay of Lake Superior; thence in a westerly and southwesterly direction along that high water mark to the most southerly extremity of Middlebrun Point of Sibley Peninsula; thence south astronomically to the intersection with the International Boundary between the United States of America and Canada; thence in a southwesterly and westerly direction along that boundary to the intersection with the centre line of Saganaga Lake; thence in a northeasterly direction along the centre line of interconnecting lakes and waterways composed of Saganaga Lake, Northeast Arm, North Channel, Trafalgar Bay, Weikwabinonaw River, Nelson Creek and Nelson Lake to the intersection with the high water mark at the most northerly extremity of Nelson Lake; thence in a northeasterly direction along a straight line to the intersection with the centre line of Clovenhoof Lake; thence in a generally easterly direction along that centre line to the intersection with the high water mark at the most easterly extremity of Clovenhoof Lake; thence in a southeasterly direction along a straight line to the high water mark at the most westerly extremity of Hoof Lake; thence in a generally easterly and northerly direction along the centre line of interconnecting lakes and waterways composed of Hoof Lake, Hoof Creek, Kekekuab Lake, Kekek Creek, Blossom Lake, Matawin River, Shebandowan River and the Oskondaga River to the intersection with the centre line of that part of the King's Highway known as No. 17; thence in a northerly and northwesterly direction along that centre line to the place of beginning.

WMU 14

All that land in the Territorial District of Thunder Bay in the Province of Ontario described as follows:

Beginning at the intersection of the right-of-way of the Canadian National Railway Company with the centre line of that part of the King's Highway known as Secondary Highway No. 628 in the geographic Township of Nipigon; thence east astronomically to the intersection with the high water mark of Nipigon Bay at Hughes Point; thence in an easterly direction along that high water mark to the most westerly extremity of Schreiber Point; thence due south astronomically to the intersection with the International Boundary between the United States of America and Canada; thence in a westerly direction along that boundary to the intersection with a straight line running due south astronomically from the high water mark at the most southerly extremity of Middlebrun Point; thence due north astronomically along that line to the high water mark of Lake Superior at Middlebrun Point; thence in a northeasterly direction along that high water mark to the intersection with the centre line of the Black Sturgeon River in Black Bay; thence in a general northeasterly and northwesterly direction along that centre line to the intersection with the centre line of the right-of-way of the Canadian National Railway Company; thence in a northeasterly direction along that centre line to the place of beginning.

WMU 15

All that land in the territorial districts of Kenora and Thunder Bay in the Province of Ontario described in WMUs 15A and 15B.

WMU 15A

All that land in the territorial districts of Kenora and Thunder Bay, in the Province of Ontario, described as follows:

Beginning at the intersection of the centre line of that part of the King's Highway known as No. 17 with the easterly boundary of the geographic Township of Hodgson; thence in a northerly direction along that boundary, the easterly boundary of the geographic Township of Hyndman and the northerly production of that boundary to the intersection with the centre line of the stream flowing into Basket Lake; thence in a northeasterly direction along that centre line to the intersection with the high water mark at the most southerly extremity of Basket Lake; thence in a northerly and northeasterly direction

along the centre line of that lake to the intersection with the high water mark of the most northeasterly bay of that lake; thence northerly in a straight line to the intersection with the high water mark of the most southeasterly lake connecting with the Amik River; thence northerly along the centre line of that lake to the intersection with the centre line of the Amik River; thence in a northerly and northeasterly direction along that centre line composed of Amik Lake and Loggers Lake to the intersection with the centre line of the English River; thence in an easterly direction along that centre line composed of Flying Loon Lake and Jarvis Lake to the intersection with the centre line of Jarvis Lake; thence in a northeasterly direction along that centre line to the intersection with the high water mark at the most northerly extremity of that lake; thence northerly along a straight line to the intersection with the high water mark at the most westerly extremity of Lake of Bays; thence in a northeasterly and northwesterly direction along a centre line connecting Lake of Bays, Lake of Bays River, Conver Lake and Singapore Lake to the intersection with the connecting waters between Singapore Lake and Tawatinau Lake and the centre line of the right-of-way of the Canadian National Railway Company; thence easterly along that centre line to the intersection with the centre line of the northwestern arm of McEwen Lake; thence southeasterly along that centre line and the centre line of McEwen Lake to the centre line of the Brightsand River System; thence in a general southerly direction along the centre line of the said Brightsand River System composed of Antler Lake, Wapikaimaski Lake and Harmon Lake to the intersection with a point on the said centre line and a line drawn on a course of north 45° 00' west from a point on the Graham Road, known locally as the Graham Road Bridge Crossing; thence south 45° 00' east to the said point on the Graham Road; thence in a southwesterly direction along the centre line of the Graham Road to the intersection with the centre line of that part of the King's Highway known as No. 17; thence northwesterly along that centre line to the place of beginning.

WMU 15B

All that land in the territorial districts of Kenora and Thunder Bay in the Province of Ontario described as follows:

Beginning at the intersection of the right-of-way of the Canadian National Railway Company with the centre line of the Little Jackfish River; thence in a southerly direction along that centre line to the intersection with the high water mark of Lake Nipigon in Ombabika Bay; thence in a general westerly, southerly and easterly direction along that high water mark to the intersection with the centre line of the Nipigon River east of Jardine Island; thence in a southerly direction along the centre line of the Nipigon River System composed of the Nipigon River, Forgan Lake and Jessie Lake to the intersection with the centre line of the right-of-way of TransCanada Pipelines Limited; thence in a westerly direction along that centre line to the intersection with the centre line of that part of the King's Highway known as No. 17; thence in a northwesterly direction along that centre line to the intersection with the centre line of Graham Road; thence northeasterly along that centre line to a point on that road known locally as the Graham Road Bridge Crossing; thence north 45° 00' west to the intersection with the centre line of Brightsand River System; thence northeasterly along the centre line of the Brightsand River System composed of Harmon Lake, Wapikaimaski Lake and Antler Lake to the intersection with the centre line of McEwen Lake; thence northwesterly along that centre line and the centre line of the northwestern arm of that lake to the intersection with the centre line of the Canadian National Railway Company; thence easterly along that centre line to the place of beginning.

WMU 16

All that land in the territorial districts of Kenora, Patricia Portion, and Thunder Bay in the Province of Ontario described in WMUs 16A, 16B, and 16C.

WMU 16A

All that land in the territorial districts of Kenora, Patricia Portion, and Thunder Bay in the Province of Ontario described as follows:

1. Beginning at the intersection of a line drawn north astronomi-

cally from the most easterly extremity of Cleary Lake, with the 11th Base Line; thence in a westerly direction along the 11th Base Line to the intersection with the centre line of the most northerly bay of Goose Lake; thence in a southerly and southeasterly direction along the centre line of Goose Lake and the waters connecting Goose Lake and Mamakwash Lake, Upper Goose Lake, the Berens River and Mainprize Lake to the intersection with the most southeasterly extremity of Mainprize Lake; thence southeasterly in a straight line to the intersection with the most northerly extremity of Little Shabumeni Lake; thence in a southerly direction along the high water mark along the easterly shore of Little Shabumeni Lake and Shabumeni Lake to the intersection with the centre line of the right-of-way of Ontario Hydro; thence in a southerly, southeasterly and easterly direction along that centre line to Slate Falls on North Bamaji Lake; thence in a general southerly direction along the centre line of North Bamaji Lake and Bamaji Lake, the waters connecting Bamaji Lake and Roadhouse Lake, the centre line of Roadhouse Lake and Blackstone Lake, the waters connecting Roadhouse Lake and the West Channel of Lake St. Joseph, the centre line of the West Channel of Lake St. Joseph to the most northerly extremity of Carling Island; thence northerly in a straight line to the most easterly extremity of Knupp Lake; thence northwesterly in a straight line to the confluence of the centre line of the Kaminiskag River and Wright Lake; thence northerly along the centre line of the Kaminiskag River to the intersection with the centre line of the Dobie River; thence westerly along the centre line of the Dobie River to its confluence with Hergott Lake; thence north astronomically to the centre line of Wettlaufer Lake; thence northeasterly along that centre line to the confluence of the Otoskwin River; thence northwesterly along the centre line of an unnamed stream, connecting the Otoskwin River to Cleary Lake, to the shore of Cleary Lake; thence northeasterly along that shore to the most easterly extremity of Cleary Lake; thence north astronomically to the place of beginning.

2. Beginning at the intersection of the centre line of the Trading River with the 11th Base Line; thence westerly along the 11th Base Line to the intersection with a line drawn north astronomically from the most easterly extremity of Cleary Lake; thence south astronomically to the most easterly extremity of Cleary Lake; thence southwesterly along the shore of Cleary Lake to the centre line of an unnamed stream connecting Cleary Lake to the Otoskwin River; thence southeasterly along that centre line to the centre line of the Otoskwin River; thence southwesterly along that centre line to the confluence with the centre line of Wettlaufer Lake; thence southwesterly along the centre line of Wettlaufer Lake to the intersection with a line drawn north astronomically from the intersection of the centre line of the Dobie River and Hergott Lake; thence westerly along the centre line of the Dobie River to the intersection with the centre line of the Kaminiskag River; thence southerly along that centre line to the confluence with Wright Lake; thence southeasterly in a straight line to the most easterly extremity of Knupp Lake; thence southerly in a straight line joining the said easterly extremity with the most northerly extremity of Carling Island to the Judicial Boundary between the District of Kenora and the District of Thunder Bay; thence easterly along that boundary to the intersection with the centre line of De Palma Lake; thence northerly to the confluence of the centre line of the Etowamani River and Dujal Lake; thence northeasterly along that centre line to the intersection with the centre line of the Trading River; thence northeasterly along the centre line of the Trading River to the place of beginning.

WMU 16B

All that land in the territorial districts of Kenora and Thunder Bay in the Province of Ontario, described as follows:

Beginning on the centre line of the northeastern bay of Achapi Lake at the intersection of the Albany River and the Kenora-Thunder Bay Judicial District Boundary; thence westerly along that boundary through Lake St. Joseph and the centre line of Lake St. Joseph, the northwest arm of Lake St. Joseph, and Blackstone Lake to the intersection with the centre line of the connecting waters between Blackstone Lake and Root Bay of Lake St. Joseph; thence in a southerly direction along the centre line of those connecting waters to the intersection with the centre line of Root Bay of Lake

St. Joseph; thence southwesterly along the centre line of Root Bay to the intersection with the centre line of the Root River; thence in a southerly direction along the centre line of the Root River, Adam-hay Lake, Free Creek and McNeely Lake to the intersection with the most southerly extremity of McNeely Lake; thence easterly in a straight line to the intersection with the most northerly extremity of Sleen Lake; thence easterly following the high water mark along the northerly shore of Sleen Lake and the waters connecting Sleen Lake and Enrae Lake to the intersection with the centre line of Enrae Lake; thence northeasterly along the centre line of Enrae Lake and the waters connecting Enrae Lake and the Vermilion River to the intersection with the centre line of the Vermilion River; thence southerly along the centre line of the Vermilion River, Mask Lake and the connecting waters to the intersection with the most southerly bay of Ragged Wood Lake; thence in a northeasterly, southeasterly and southwesterly direction along the centre line of the most southerly bay of Ragged Wood Lake, Elam Lake, Moose Creek and Moose Lake to the intersection with the most southerly extremity of Moose Lake; thence in an easterly direction across portages and small waterways to the intersection with the most southerly extremity of Runway Lake; thence in a southeasterly direction along the centre line of the Marchington River, Schist Lake, the waters between Schist Lake and Farrington Lake, and the centre line of Farrington Lake to the intersection with the most southerly extremity of Farrington Lake; thence in a southerly direction across a portage to the intersection with the northerly extremity of Lewis Lake; thence in a southerly direction along the centre line of Lewis Lake, Tawatinaw River, Tawatinaw Lake and the stream between Tawatinaw Lake and Singapore Lake to the intersection with the centre line of the right of way of the Canadian National Railway Company; thence easterly along the centre line of the Canadian National Railway Company to the intersection with the centre line of the connecting waters between Redhead Lake and Noname Lake; thence in a northerly direction following the centre line of the connecting waters between Redhead Lake and Noname Lake, Redhead Lake, Nemo River, Osprey Lake and Nemo River to the most easterly point of Snake Lake; thence in a straight line in a northeasterly direction to the most westerly extremity of Dagger Lake; thence easterly to the intersection with the centre line of Dagger Lake; thence southeasterly along that centre line to the southeastern extremity of Dagger Lake; thence easterly and northerly following the centre line of the stream connecting Dagger Lake and Otter Bluff Lake, Otter Bluff Lake, the waters connecting Otter Bluff Lake and Granite Lake, Granite Lake and the Allan Water River to the southern extremity of Wabakimi Lake; thence in a northeasterly direction in a straight line to the intersection with the centre line of River Bay of Wabakimi Lake; thence in a northeasterly direction along the centre line of River Bay of Wabakimi Lake, the connecting waters between River Bay and Kenoji Lake, Kenoji Lake, the connecting waters between Kenoji Lake and the Palisade River, the Palisade River, Redman Lake and Webster Creek to the intersection with the centre line of Webster Lake; thence in a northerly direction along that centre line to the most northerly extremity of Webster Lake; thence in a northeasterly direction in a straight line to the most southerly extremity of Achapi Lake; thence in a northeasterly direction along the centre line Achapi Lake to the place of beginning.

WMU 16C

All that land in the territorial districts of Kenora and Thunder Bay in the Province of Ontario described as follows:

Beginning at the intersection of the centre line of the Shabuskwia River with the centre line of the Albany River; thence in a northerly and westerly direction along the centre line of the Albany River to the intersection with the centre line of Etowamami River; thence in a northerly and southwesterly direction along the centre line of the Etowamami River to the most southerly extremity of Dugal Lake; thence southerly in a straight line to the intersection of the centre line of the Albany River; thence southerly along the centre line of the Albany River and Achapi Lake to the most southerly extremity of Achapi Lake; thence in a straight line in a southwesterly direction to the northerly extremity of Webster Lake; thence in a southerly direction to the intersection with the centre line of Webster Lake; thence in a southerly direction along the centre line of Webster

Lake, Webster Creek, Redman Lake, the Palisade River, the waters between the Palisade River and Kenoji Lake, Kenoji Lake, the connecting waters between Kenoji Lake and River Bay of Wabakimi Lake to the intersection with the centre line of River Bay of Wabakimi Lake; thence in a southwesterly direction along the centre line of River Bay to the intersection with a straight line to the southern extremity of Wabakimi Lake at the Allenwater River; thence in a southerly direction along the centre line of the Allenwater River, Granite Lake, the waters connecting the Granite Lake and Otter Bluff Lake, Otter Bluff Lake, and the waters connecting Otter Bluff Lake and Dagger Lake to the intersection with the centre line of Dagger Lake; thence along the centre line of Dagger Lake to its most westerly extremity; thence in a straight line in a southwesterly direction to the most easterly extremity of Snake Lake; thence in a southwesterly direction to the intersection with the centre line of the Nemo River; thence in a southerly direction along the centre line of the Nemo River, Osprey Lake, the Nemo River, Redhead Lake and connecting waters between Redhead Lake and Noname Lake to the intersection with the centre line of the right-of-way of the Canadian National Railway Company; thence in an easterly direction along the centre line of the right-of-way of the Canadian National Railway Company to the intersection with the centre line of the Little Jackfish River; thence in a northerly and northwesterly direction along the centre line of Little Jackfish River, Zigzag Lake, Moule Lake, Stork Lake, South Summit Lake, Mojikit Lake, the Ogoki Reservoir to Eight Flume Falls; thence in a northerly direction along the easterly shore of Whiteclay Lake and across a portage to the intersection with the most southerly extremity of Witchwood Lake; thence in a northeasterly, northwesterly and southwesterly direction along the centre line of Witchwood Lake, Witchwood River, Felsia Lake, Hurst Lake, Attwood Lake and Attwood River to the intersection with the centre line of Luella Lake; thence in a southwesterly direction following the centre line of Luella Lake, the connecting waters between Luella Lake and Kilbarry Lake, the centre line of Kilbarry Lake, Musgrave Lake and the portages and connecting waters between Musgrave Lake and Linsey Bay of Shabuskwia Lake to the intersection with the most southerly extremity of Linsey Bay; thence in a northerly direction along the centre line of Linsey Bay, Pucill Lake, Shabuskwia Lake, Shabuskwia River and Patte Lake to the place of beginning.

WMU 17

All that land in the territorial districts of Cochrane, Thunder Bay and Kenora in the Province of Ontario described as follows:

1. Beginning at the intersection of the centre line of Ogoki River with the centre line of the Albany River; thence in a northwesterly direction along the centre line of the Albany River to the intersection with the centre line of the Wabassi River; thence in a westerly and northerly direction along that centre line to the intersection with the 11th Base Line; thence in a westerly direction along that base line to the intersection with the centre line of Trading River; thence southwesterly along the centre line of the Trading River to the intersection with the centre line of the Etowamami River; thence in a northeasterly and southerly direction along that centre line to the intersection with the centre line of the Albany River; thence in a southerly direction along that centre line to the intersection with the centre line of the Shabuskwia River; thence in a southerly, northeasterly and southerly direction along the centre line of the Shabuskwia River and Shabuskwia Lake to the intersection with a most southerly extremity of Linsey Bay of Shabuskwia Lake; thence southerly in a straight line to the intersection with the most northerly extremity of Musgrave Lake; thence in a southeasterly and northeasterly direction along the centre line of Musgrave Lake and the waters connecting Musgrave Lake and Kilbarry Lake, the centre line of Kilbarry Lake and the waters connecting Kilbarry Lake and Luella Lake and the centre line of Luella Lake to the intersection with the centre line of Attwood River; thence in a northeasterly and southerly direction along the centre line of the Attwood River, Attwood Lake, Hurst Lake, Felsia Lake, Witchwood River and Witchwood Lake to the intersection with the most southerly extremity of Witchwood Lake; thence southerly across a portage to the intersection with the most northerly extremity of Whiteclay Lake; thence continuing in a southerly direction along the easterly shore of Whiteclay Lake to the centre line of

the Ogoki Reservoir at Eight Flume Falls; thence southerly, easterly and southerly along the centre line of the Ogoki Reservoir, Ogoki River and Ottertail River to the intersection with a line drawn west astronomically from the most northerly extremity of the Makoki Lake; thence east astronomically along the said straight line to the intersection with the most northerly extremity of Makoki Lake; thence southeasterly, southerly, easterly and northeasterly along the centre line of Makoki Lake, the connecting waters between Makoki Lake and Berger Lake, Berger Lake, Kapikotongwa River, Tennant Lake, and Kapikotongwa Lake to the intersection with a line drawn south astronomically from the portage between Kapikotongwa Lake and Kayedon Lake; thence north astronomically along that line, along the portage between Kapikotongwa Lake and Kayedon Lake, the centre line of Kayedon Lake to the intersection with the centre line of the Ogoki River;

Thence in a northeasterly direction along the centre line of the Ogoki River System through Harrogate Lake, Patience Lake, and Esser Lake to the place of beginning.

2. Beginning at the intersection of the centre line of the Kapikotongwa Lake and a line drawn south astronomically from a portage between Kapikotongwa Lake and Kayedon Lake; thence north astronomically along that straight line, through the portage between Kapikotongwa Lake and Kayedon Lake, the centre line of Kayedon Lake to the intersection with the centre line of the Ogoki River; thence in a northeasterly direction along the centre line of the Ogoki River system through Harrogate Lake, Patience Lake, Esser Lake to the point of intersection with the centre line of the Albany River; thence in an easterly and southeasterly direction along the centre line of the Albany River to the intersection with the centre line of the Kenogami River; thence in a southwesterly direction along the centre line of the Kenogami River to the intersection with the centre line of the Little Current River; thence in a westerly, southwesterly, and northwesterly direction along the centre line of the Little Current River system through Percy Lake to the intersection with the centre line of the Kapikotongwa River; thence in a westerly direction along the centre line of the Kapikotongwa River system composed of Jungfrau Lake, Saga Lake, Durer Lake, Nass Lake, Melchett Lake to the place of beginning.

WMU 18

All that land in the territorial districts of Cochrane and Thunder Bay in the Province of Ontario described in WMUs 18A and 18B.

WMU 18A

All that land in the territorial districts of Cochrane and Thunder Bay in the Province of Ontario described as follows:

Beginning at the point of intersection of the centre line of the Squaw River and the centre line of the Little Current River; thence westerly along the centre line of Little Current River through Percy Lake to the intersection with the centre line of the Kapikotongwa River; thence in a westerly direction along the centre line of the Kapikotongwa River system composed of Jungfrau Lake, Saga Lake, Durer Lake, Nass Lake, Melchett Lake, Kapikotongwa Lake, Tennant Lake and Berger Lake to the intersection with the centre line of the connecting waters between Makoki Lake and Berger Lake; thence northerly and northwesterly along that centre line and the centre line of Makoki Lake to the most northerly extremity thereof; thence west astronomically to the intersection with the centre line of the Ottertail River; thence northerly and westerly along the centre line of the Ottertail River, the Ogoki River and the Ogoki Reservoir to the intersection with the centre line of Mojikit Lake; thence southerly along the centre line of Mojikit Lake, South Summit Lake, Stork Lake, Moule Lake, Zigzag Lake and the Little Jackfish River to the intersection with the centre line of the forest access road constructed on the site of what was formerly part of the most northerly east-west line of the Canadian National Railway Company; thence in an easterly direction along that centre line to the intersection with the centre line of the connecting waters between Prairie Lake and Johnson Lake; thence northerly along the centre line of the waters connecting Prairie Lake and Johnson Lake, Prairie Lake, the waters connecting Prairie Lake, and Jemar Lake, Jemar Lake, the waters

connecting Jemar Lake and Relief Lake, and the waters connecting Relief Lake and the Drowning River, to the intersection with the centre line of the Drowning River; thence northerly and northeasterly along that centre line to the intersection with the first creek entering the north side of the Drowning River northeast of Peter Falls; thence north astronomically to the intersection with the centre line of the Little Squaw River; thence in a northerly direction along that centre line to the intersection with the centre line of the Squaw River; thence in a northeasterly direction along that centre line to the place of beginning.

WMU 18B

All that land in the territorial districts of Cochrane and Thunder Bay in the Province of Ontario described as follows:

Beginning at the intersection of the centre line of the forest access road constructed on the site of what was formerly part of the most northerly east-west line of the Canadian National Railway Company with the centre line of the Otasawian River; thence in the northeasterly and northerly direction along that centre line and the centre line of the Nagagami River and the Kenogami River to the intersection with the centre line of the Little Current River; thence in a westerly direction along the centre line of that river to the intersection with the centre line of the Squaw River; thence in a southerly direction along that centre line to the intersection with the centre line of Little Squaw River; thence in a southwesterly direction to the intersection with a straight line drawn north astronomically from the intersection of the centre line of the first creek entering the north side of the Drowning River northeast of Peter Falls and the centre line of the Drowning River; thence south astronomically along that straight line to the intersection with the centre line of the Drowning River; thence southerly and westerly along the centre line of the Drowning River, the waters connecting the Drowning River and Jemar Lake, Jemar Lake, the waters connecting Jemar Lake and Prairie Lake and the waters connecting Prairie Lake and Johnson Lake to the intersection with the centre line of the forest access road constructed on the site of what was formerly part of the most northerly east-west line of the Canadian National Railway Company; thence southeasterly along that centre line to the place of beginning.

WMU 19

All that land in the territorial districts of Cochrane and Thunder Bay in the Province of Ontario described as follows:

Beginning at the confluence of the waters of Lake Nipigon with the waters of the Blackwater River; thence in a northeasterly direction along the centre line of the Blackwater River to the intersection with the centre line of that part of the King's Highway known as No. 11; thence easterly along that centre line to the intersection with the centre line of the Otasawian River; thence northeasterly along that centre line to the intersection with the centre line of the right-of-way of the Canadian National Railway Company; thence in a westerly direction along that centre line and the centre line of the forest access road constructed on the site of what was formerly part of the most northerly east-west line of the Canadian National Railway Company and continuing along the centre line of the most northerly east-west line of the Canadian National Railway Company to the intersection with the centre line of the Little Jackfish River; thence in a southerly direction along that centre line to the intersection with the high water mark of Lake Nipigon; thence in a general southerly direction along that high water mark on the easterly shore of Lake Nipigon to the place of beginning.

WMU 20

All that land in the Territorial District of Thunder Bay in the Province of Ontario described as follows:

Beginning at the confluence of the waters of the Little Jackfish River with the waters of Lake Nipigon; thence in a westerly direction along a straight line to the intersection with the high water mark on the northerly shore of Lake Nipigon; thence in a westerly, southerly, easterly and northerly direction along that high water mark to the place of beginning.

WMU 21

All that land in the territorial districts of Algoma, Cochrane and Thunder Bay described in WMUs 21A and 21B.

WMU 21A

All that land in the Territorial District of Thunder Bay in the Province of Ontario described as follows:

Beginning at the intersection of the centre line of that part of the King's Highway known as Secondary Highway No. 625 with the centre line of that part of the King's Highway known as No. 11; thence in a westerly direction along that centre line to the intersection with the centre line of the Blackwater River in the geographic Township of Summers; thence in a southwesterly direction along that centre line to the intersection with the high water mark along the easterly shore of Lake Nipigon; thence in a southerly, northerly and westerly direction along that high water mark to the intersection with the centre line of the Nipigon River east of Jardine Island; thence in a southerly direction along the centre line of the Nipigon River system composed of the Nipigon River, Forgan Lake, Jessie Lake and Helen Lake to the intersection with a straight line extending easterly from the intersection of the centre line of that part of the King's Highway known as Secondary Highway No. 628 with the centre line of the right-of-way of the Canadian National Railway Company to the high water mark of the most southerly extremity of Hughes Point of Nipigon Bay of Lake Superior; thence easterly along that straight line to the intersection with the high water mark of the most southerly extremity of Hughes Point on the north shore of Nipigon Bay of Lake Superior; thence in an easterly direction along that high water mark to the most westerly extremity of Schreiber Point; thence south astronomically to the intersection where the International Boundary between Canada and United States of America; thence northeasterly in a straight line to the confluence of the centre line of the White River and Lake Superior; thence northerly and westerly along the shore of Lake Superior to the confluence with the centre line of the Pic River; thence in a northerly direction along the centre line of the Pic River to the intersection with the centre line of a road crossing the Pic River running westerly from the Village of Caramat; thence in an easterly direction along this road to the intersection with the centre line of that part of the King's Highway known as Secondary Highway No. 625; thence in a northerly direction along that centre line to the place of beginning.

WMU 21B

All that land in the territorial districts of Algoma, Cochrane and Thunder Bay in the Province of Ontario described as follows:

Beginning at the intersection of the high water mark of Lake Superior with the centre line of the White River; thence in an easterly and northeasterly direction along that centre line to the intersection with the centre line of White Lake; thence in a northerly direction along that centre line to the intersection with the centre line of that part of the King's Highway known as No. 17; thence in an easterly direction along that centre line to the intersection with the centre line of that part of the King's Highway known as Secondary Highway No. 631; thence in an easterly and northerly direction along that centre line to the intersection with the centre line of that part of King's Highway known as No. 11; thence westerly along the centre line of a King's Highway known as No. 11 to the intersection with the centre line of that part of the King's Highway known as Secondary Highway No. 625; thence in a southerly and southeasterly direction along that centre line to the intersection with the centre line of a road running westerly from the Village of Caramat; thence westerly along that centre line to the intersection with the centre line of the Pic River; thence southerly along the centre line of that river to the intersection with the high water mark of Lake Superior; thence southerly along that high water mark to the place of beginning.

WMU 22

All that land in the territorial districts of Algoma and Cochrane in the Province of Ontario described as follows:

Beginning at the intersection of the centre line of that part of the King's Highway known as No. 17 with the centre line of that part of the King's Highway known as Secondary Highway No. 631; thence in an easterly and northerly direction along that centre line to the intersection with the centre line of that part of the King's Highway known as No. 11; thence in an easterly direction along that centre line to the intersection with the centre line of the right-of-way of the Algoma Central Railway near the Town of Hearst; thence in a southwesterly direction along that centre line to the intersection with the centre line of the right of way of Canadian Pacific Limited at the Dispersed Rural Community of Franz; thence in a westerly direction along that centre line to the intersection with the centre line of that part of the King's Highway known as No. 17; thence in a northwesterly direction along that centre line to the place of beginning.

WMU 23

All that land in the territorial districts of Algoma and Cochrane in the Province of Ontario described in WMUs 23A and 23B.

WMU 23A

All that land in the territorial districts of Algoma and Cochrane in the Province of Ontario described as follows:

Beginning at the intersection of the centre line of that part of the King's Highway known as No. 11 with the centre line of the Missinaibi River; thence southeasterly along the centre line of that part of the King's Highway known as No. 11 to the centre line of the Opatatika River; thence southerly along that centre line to the northerly boundary of the geographic Township of Opatatika; thence easterly along that boundary to the northeasterly corner of that geographic township; thence southerly along the easterly boundary of that township to the southeasterly corner thereof; thence westerly along the southerly boundary of the geographic townships of Opatatika and Abbott to the centre line of the Missinaibi River; thence northerly along that centre line to the place of beginning.

WMU 23B

All that land in the territorial districts of Algoma and Cochrane in the Province of Ontario described as follows:

Beginning at the intersection of the centre line of that part of the King's Highway known as No. 11 with the centre line of the right-of-way of the Algoma Central Railway Company near the Town of Hearst; thence in a southwesterly direction along the centre line of that right-of-way to the intersection with the centre line of the right-of-way of the Canadian National Railway Company at the Dispersed Rural Community of Oba; thence in a southeasterly direction along that centre line to the intersection with the centre line of the Kapuskasing River; thence in a northerly direction along that centre line to the intersection with the centre line of that part of the King's Highway known as No. 11; thence in a northwesterly direction along that centre line to the centre line of the Opatatika River; thence in a southerly direction along that centre line to the northerly boundary of the geographic Township of Opatatika; thence easterly along that boundary to the northeasterly corner of that geographic township; thence southerly along the easterly boundary of that geographic township to the southeasterly corner thereof; thence westerly along the southerly boundary of the geographic townships of Opatatika and Abbott to the centre line of the Missinaibi River; thence northerly along that centre line to the centre line of that part of the King's Highway known as No. 11; thence in a northwesterly direction along that centre line to the place of beginning.

WMU 24

All that land in the Territorial District of Cochrane in the Province of Ontario described as follows:

Beginning at the intersection of the centre line of that part of the King's Highway known as Secondary Highway No. 807 with the centre line of that part of the King's Highway known as No. 11 near the Town of Smooth Rock Falls; thence in a northwesterly and westerly direction along the last mentioned centre line to the intersection with

the centre line of the Otasawian River; thence in a northerly and northeasterly direction along that centre line to the intersection with the centre line of the Nagagami River; thence due east astronomically to the intersection of the centre line of the Kabinakagami River with the centre line of the Fox River; thence in a southeasterly and southerly direction along the centre line of the Fox River to the intersection with the northerly boundary of the geographic Township of Bannerman; thence easterly along that boundary and the northerly boundary of the geographic Township of Ritchie to the intersection with the centre line of the Pivabiska River; thence in a northeasterly direction along that centre line to the intersection with the centre line of the Missinaibi River; thence in a northeasterly direction along that centre line to the intersection with the centre line of the Moose River on the south side of Portage Island; thence in a northeasterly direction along that centre line lying south of Grey Goose, Nicoll and Mike Islands to the intersection with the centre line of the right-of-way of the Ontario Northland Transportation Commission; thence in a southwesterly direction along that centre line to the intersection with the centre line of Medicine Creek; thence in a northeasterly direction along that centre line to the intersection with the centre line of the Abitibi River; thence in a southwesterly and southeasterly direction along that centre line to the intersection with the centre line of the right-of-way of the Ontario Northland Transportation Commission; thence northwesterly along that centre line to the intersection with the centre line of a road running westerly through the geographic townships of Menapia and Adanac to that part of the King's Highway known as Secondary Highway No. 807; thence in a westerly direction along that centre line to the intersection with the centre line of that part of the King's Highway known as Secondary Highway No. 807; thence in a southerly and southwesterly direction along that centre line to the place of beginning.

WMU 25

All that land in the Territorial District of Cochrane in the Province of Ontario described as follows:

Beginning at the confluence of the waters of James Bay with the centre line of the south channel of the Albany River lying southerly of Albany Island; thence in a southwesterly direction along that centre line lying southerly of all islands to the intersection with the centre line of the Kenogami River; thence southerly along that centre line and the centre line of the Nagagami River to the centre line of the Otasawian River; thence easterly in a straight line to the intersection with the centre line of the waters of the Kabinakagami River and the waters of the Fox River; thence in a southeasterly and easterly direction along the centre line of the Fox River to the intersection with the northerly boundary of the geographic Township of Bannerman; thence in an easterly direction along that boundary and the northerly boundary of the geographic Township of Ritchie to the intersection with the centre line of the Pivabiska River; thence in a northeasterly direction along that centre line to the intersection with the centre line of the Missinaibi River; thence in a northeasterly direction along that centre line to the intersection with the centre line of the Moose River on the south side of Portage Island; thence in a northeasterly direction along that centre line lying south of Grey Goose, Nicoll and Mike Islands to the intersection with the centre line of the right-of-way of Ontario Northland Transportation Commission; thence in a southwesterly direction along that centre line to the intersection with the centre line of Medicine Creek; thence in a northeasterly direction along that centre line to the intersection with the centre line of the Abitibi River; thence in a northeasterly direction along that centre line lying southerly and easterly of all islands to the intersection with the centre line of the Moose River; thence in a northeasterly direction along that centre line lying southerly of all islands including Bushy, Poplar, Flats, Pilgrim, Middleboro, Horseshoe and Ship Sands Islands to the confluence with the waters of James Bay; thence in a northwesterly direction along the water's edge of James Bay to the place of beginning.

WMU 26

All that land in the Territorial District of Cochrane in the Province of Ontario described as follows:

Beginning at the intersection of the Interprovincial Boundary

between Ontario and Quebec with the high water mark of James Bay; thence in a southwesterly and northwesterly direction along that high water mark to the intersection with the centre line of the Moose River; thence in a southwesterly direction along that centre line lying southerly of all islands, including Ship Sands, Horseshoe, Middleboro, Pilgrim, Flats, Poplar and Bushy Islands, to the intersection with the production of the centre line of the Abitibi River; thence in a southwesterly and southeasterly direction along that production and that centre line lying southerly and easterly of all islands to the intersection with the centre line of the right-of-way of the Ontario Northland Transportation Commission; thence southeasterly along that centre line to the intersection with the centre line of the Sucker River; thence in an easterly and southeasterly direction along that centre line to the intersection with the centre line of the Chin River; thence in a northerly and northeasterly direction along that centre line to the intersection with the southerly boundary of the geographic Township of Potter; thence easterly along the southerly boundary of the geographic townships of Potter, Sangster, Bragg, Newman and Tomlinson to the intersection with the centre line of the Kabika River; thence in a northeasterly direction along that centre line to the intersection with the centre line of the Burntbush River; thence in a northeasterly direction along that centre line to the intersection with the centre line of Riviere Turgeon; thence northerly along that centre line to the intersection with the Interprovincial Boundary between Ontario and Quebec; thence northerly along that boundary to the place of beginning.

WMU 27

All that land in the Territorial District of Cochrane in the Province of Ontario described as follows:

Beginning at the intersection of the Interprovincial Boundary between Ontario and Quebec with the high water mark on the southerly shore of Lake Abitibi; thence in a westerly and northwesterly direction along that high water mark to the intersection with the centre line of the Abitibi River; thence in a westerly, southwesterly and northwesterly direction along that centre line to the intersection with the centre line of Meadow Creek; thence in a southwesterly direction along that centre line to the intersection with the centre line of that part of the King's Highway known as Secondary Highway No. 577; thence in a northerly direction along that centre line to the intersection with the centre line of that part of the King's Highway known as No. 67; thence in a southwesterly direction along that centre line to the intersection with the centre line of that part of the King's Highway known as No. 11; thence in a northerly and northwesterly direction along that centre line to the intersection with the centre line of that part of the King's Highway known as Secondary Highway No. 807; thence in a northeasterly and northerly direction along that centre line to the intersection with the centre line of a road leading through the geographic townships of Adanac and Menapia to Island Falls; thence in an easterly direction along that centre line to the intersection with the centre line of the right-of-way of the Ontario Northland Transportation Commission; thence in a southeasterly direction along that centre line to the intersection with the centre line of the Sucker River; thence in an easterly and southeasterly direction along that centre line to the intersection with the centre line of the Chin River; thence in a northerly and northeasterly direction along that centre line to the intersection with the southerly boundary of the geographic Township of Potter; thence easterly along the southerly boundary of the geographic townships of Potter, Sangster, Bragg, Newman and Tomlinson to the intersection with the centre line of the Kabika River; thence in a northeasterly direction along that centre line to the intersection with the centre line of the Burntbush River; thence in a northeasterly direction along that centre line to the intersection with the centre line of the Riviere Turgeon; thence northeasterly along that centre line to the intersection with the Interprovincial Boundary between Ontario and Quebec; thence southerly along that boundary to the place of beginning.

WMU 28

All that land in the territorial districts of Cochrane and Timiskaming in the Province of Ontario described as follows:

Beginning at the intersection of the Interprovincial Boundary

between Ontario and Quebec with the high water mark along the southerly shore of Lake Abitibi; thence in a westerly and northwesterly direction along that high water mark to the intersection with the centre line of the Abitibi River; thence in a westerly and southwesterly direction along that centre line to the intersection with the centre line of the Black River; thence in a southeasterly direction along that centre line to the intersection with the centre line of the Watabeag River; thence in a southerly direction along the centre line of the Watabeag River and Watabeag Lake to the intersection with the northwesterly production of the centre line of the North Englehart Management Unit Forest Access Road in the geographic Township of Sheba; thence in a southeasterly direction along that production and that centre line to the intersection with the centre line of the Englehart River; thence in a southeasterly direction along that centre line to the intersection with the centre line of that part of the King's Highway known as No. 66; thence in a westerly and southwesterly direction along that centre line to the intersection with the centre line of that part of the King's Highway known as No. 65; thence in a southwesterly direction along that centre line to the intersection with the centre line of the West Montreal River; thence in a southerly direction along that centre line to the intersection with the centre line of the Montreal River; thence in a southeasterly direction along the centre line of the Montreal River System composed of the Montreal River, Elk Lake, Mountain Lake and Bay Lake and the southeasterly production of that centre line to the intersection with the Inter-provincial Boundary between Ontario and Quebec; thence in a northerly direction along that boundary to the place of beginning.

WMU 29

All that land in the territorial districts of Cochrane, Sudbury and Timiskaming in the Province of Ontario described in WMUs 29A and 29B.

WMU 29A

All that land in the territorial districts of Cochrane, Sudbury and Timiskaming in the Province of Ontario described as follows:

Beginning at the northwesterly corner of the geographic Township of Deloro in the Territorial District of Cochrane; thence southerly along the westerly boundary of that geographic township to the northeasterly corner of the geographic Township of Price; thence westerly along the northerly boundary of that geographic township to the northwesterly corner thereof; thence southerly along the westerly boundary of the geographic townships of Price, Fripp and Musgrove to the southwesterly corner of the geographic Township of Musgrove; thence easterly along the southerly boundary of the geographic Township of Musgrove to the northwesterly corner of the geographic Township of Beemer in the Territorial District of Sudbury; thence southerly along the westerly boundary of the geographic Township of Beemer to the southwesterly corner thereof; thence easterly along the southerly boundary of the geographic Township of Beemer to the northwesterly corner of the geographic Township of Semple; thence southerly along the westerly boundary of that geographic township to the southwesterly corner thereof; thence easterly along the southerly boundary of the geographic townships of Semple and Hutt to the southeasterly corner of the geographic Township of Hutt; thence northerly along the easterly boundary of the geographic townships of Hutt, Zavitz and Geikie to the southwesterly corner of the geographic Township of Fallon in the Territorial District of Timiskaming; thence easterly along the southerly boundary of that geographic township to the southeasterly corner thereof; thence northerly along the easterly boundary of the geographic townships of Fallon, Langmuir and Carman to the northwesterly corner of the geographic Township of Carman; thence westerly along the northerly boundary of the geographic townships of Carman, Shaw and Deloro to the place of beginning.

WMU 29B

All that land in the territorial districts of Cochrane, Sudbury and Timiskaming in the Province of Ontario described as follows:

Beginning at the intersection of the centre line of that part of the King's Highway known as Secondary Highway No. 560 with the cen-

tre line of the right of way of the Canadian National Railway Company in the geographic Township of Westbrook; thence in a westerly direction along the centre line of that part of the King's Highway known as Secondary Highway No. 560 to the intersection with the centre line of that part of the King's Highway known as No. 144; thence in a northerly direction along that centre line to the intersection with the centre line of that part of the King's Highway known as No. 101 in the geographic Township of Bristol; thence in a northeasterly direction along that centre line to the intersection with the centre line of the right-of-way of the Ontario Northland Transportation Commission in the geographic Township of Whitney; thence in a northeasterly direction along that centre line to the intersection with the centre line of that part of the King's Highway known as No. 11; thence in a northerly direction along that centre line to the intersection with the centre line of that part of the King's Highway known as No. 67; thence in a northeasterly direction along that centre line to the intersection with the centre line of that part of the King's Highway known as Secondary Highway No. 577; thence southerly along that centre line to the intersection with the centre line of Meadow Creek; thence in a northeasterly direction along that centre line to the intersection with the centre line of the Abitibi River; thence in a southeasterly direction along that centre line to the intersection with the centre line of the Black River; thence in a southeasterly direction along that centre line to the intersection with the centre line of the Watabeag River; thence in a southerly direction along the centre line of the Watabeag River and Watabeag Lake to the intersection with the northwesterly production of the centre line of the North Englehart Management Unit Forest Access Road in the geographic Township of Sheba; thence in a southeasterly direction along that production and that centre line to the intersection with the centre line of the Englehart River; thence in a southwesterly and southeasterly direction along that centre line to the intersection with the centre line of that part of the King's Highway known as No. 66; thence in a westerly and southwesterly direction along that centre line to the intersection with the centre line of that part of the King's Highway known as No. 65; thence in a southwesterly direction along that centre line to the intersection with the centre line of the West Montreal River; thence in a northerly, westerly, southerly and southwesterly direction along the centre line of the West Montreal River System composed of the West Montreal River, Matachewan Lake, Mistinikon Lake and Penassi Lake to the intersection with the centre line of that part of the King's Highway known as Secondary Highway No. 560; thence in a westerly and southwesterly direction along that centre line to the place of beginning.

Saving and excepting therefrom all that land described in WMU 29A.

WMU 30

All that land in the territorial districts of Algoma, Cochrane, Sudbury and Timiskaming in the Province of Ontario described as follows:

Beginning at the intersection of the centre line of the right-of-way of the Canadian National Railway Company with the centre line of the Kapuskasing River in the geographic Township of Kapuskasing; thence in a northerly and northeasterly direction along the centre line of the Kapuskasing River to the intersection with the centre line of that part of the King's Highway known as No. 11; thence in a southeasterly and southerly direction along that centre line to the intersection with the centre line of the right of way of the Ontario Northland Transportation Commission in the geographic Township of Clergue; thence in a southwesterly direction along that centre line to the intersection with the centre line of that part of the King's Highway known as No. 101 in the geographic Township of Whitney; thence in a westerly and southwesterly direction along that centre line to the intersection with the centre line of the right of way of the Canadian National Railway Company in the geographic Township of Foley; thence in a northwesterly direction along that centre line to the place of beginning.

WMU 31

All that land in the territorial districts of Algoma, Cochrane, Sud-

bury and Timiskaming in the Province of Ontario described as follows:

Beginning at the intersection of the centre line of that part of the King's Highway known as No. 101 with the centre line of that part of the King's Highway known as No. 144 in the geographic Township of Bristol; thence in a southerly and southwesterly direction along the centre line of that part of the King's Highway known as No. 144 to the point of intersection with the centre line of that road known locally as the Ramsey Road in the geographic Township of Invergary; thence in a general westerly direction along that centre line in the geographic townships of Invergary, Smuts, Arbutus, Alcona, Fingal and Carew to the point of intersection with the centre line of Webbwood Road; thence southerly along that centre line to the intersection with the centre line of the right-of-way of the Canadian Pacific Railway Company; thence in a northwesterly direction along that centre line to the intersection with the northwesterly bank of the Chapleau River, locally known as the Kepsquashing River; thence in a northeasterly direction along the westerly bank of the Chapleau River System composed of the Chapleau River, Chapleau Lake, Henderson Lake, D'Arcy Lake, Robinson Lake, Schewabik Lake and Kapuskasing Lake to the intersection with the centre line of the right-of-way of the Canadian National Railway Company; thence in a southeasterly direction along that centre line to the intersection with the centre line of that part of the King's Highway known as No. 101; thence in an easterly and northeasterly direction along that centre line to the place of beginning.

WMU 32

All that land in the territorial districts of Algoma and Sudbury in the Province of Ontario described as follows:

1. Beginning at the intersection of the centre line of the right-of-way of the Canadian Pacific Railway Company with the centre line of the right-of-way of the Algoma Central Railway Company in the geographic Township of Pearkes; thence southeasterly along the centre line of the right-of-way of the Canadian Pacific Railway Company to the intersection with the northwesterly bank of the Chapleau River, locally known as the Kepsquashing River; thence in a northeasterly direction along the westerly bank of the Chapleau River System composed of Chapleau Lake, Henderson Lake, D'Arcy Lake, Robinson Lake, Schewabik Lake, the Chapleau River and Kapuskasing Lake to the intersection of the centre line of the right-of-way of the Canadian National Railway Company; thence northwesterly along the centre line of that right-of-way to the intersection with the centre line of the right-of-way of the Algoma Central Railway Company in the geographic Township of Franz; thence southwestward along the centre line of the right of way of the Algoma Central Railway Company to the place of beginning.

2. Beginning at the intersection of the centre line of that part of the King's Highway known as No. 17 with the centre line of the right of way of the Canadian Pacific Railway Company in the geographic Township of Vasiloff; thence in an easterly and southeasterly direction along the centre line of the right-of-way of the Canadian Pacific Railway Company to the intersection with the centre line of a road in the geographic Township of Gallagher known locally as the Devon Road; thence southwestward and northerly along the centre line of that road to the intersection with the centre line of that part of the King's Highway known as No. 101 and No. 129; thence southwestward along the centre line of that part of the King's Highway known as No. 101 and No. 129 to the intersection with the centre line of that part of the King's Highway known as No. 101 leading to Wawa; thence northwesterly along that centre line to the intersection with the centre line of the Michipicoten River; thence westerly along that centre line to the intersection with the high water mark on the easterly shore of Lake Superior; thence northerly and westerly along that high water mark and the high water mark of Michipicoten Bay to the intersection with a line drawn south astronomically from the terminus of the centre line of the right-of-way of the Algoma Central Railway Company; thence north astronomically along that line to that terminus; thence northeasterly along the centre line of the right-of-way of the Algoma Central Railway Company to the intersection with the centre line of that part of the King's Highway known as No.

17; thence northwesterly along that centre line to the place of beginning.

WMU 33

All that land in the territorial districts of Algoma, Cochrane and Thunder Bay in the Province of Ontario described as follows:

Beginning at the intersection of a line drawn south astronomically from the high water mark at the most westerly extremity of Schreiber Point with the International Boundary between Canada and the United States of America; thence northeasterly in a straight line to the intersection with the centre line of the White River; thence in an easterly and northeasterly direction along that centre line to the intersection with the centre line of White Lake; thence in a northerly direction along that centre line to the intersection with No. 17; thence southeasterly along the centre line of that part of the King's Highway known as No. 17 to the intersection with the centre line of the right of way of the Algoma Central Railway Company in the geographic Township of Lendum; thence southwestward along that centre line to its terminus; thence south astronomically to the high water mark of Michipicoten Bay; thence in an easterly and southerly direction along that high water mark and the high water mark along the easterly shore of Lake Superior to the intersection with the centre line of the Michipicoten River; thence southwestward in a straight line to the intersection of the International Boundary between Canada and the United States of America with latitude 47° 18' 04"; thence northwesterly along that International Boundary to the place of beginning.

WMU 34

All that land in the Territorial District of Algoma in the Province of Ontario described as follows:

Beginning at the intersection of the centre line of the Michipicoten River with the centre line of the right of way of the Algoma Central Railway; thence southerly along that centre line to the intersection with the centre line of the right-of-way of the Great Lakes Power Corporation Limited in the geographic Township of Larson; thence in a southerly direction along that centre line to the intersection with the centre line of the right-of-way of the Algoma Central Railway in the geographic Township of Home; thence in a southerly direction along that centre line to the intersection with the centre line of the Montreal River; thence in a westerly direction along that centre line to the water's edge of Lake Superior; thence west astronomically to the International Boundary between Canada and the United States of America; thence in a northeasterly direction to the intersection with the centre line of the Michipicoten River; thence easterly along that centre line to the place of beginning.

WMU 35

All that land in the territorial districts of Algoma and Sudbury in the Province of Ontario described as follows:

Beginning at the intersection of the centre line of that part of the King's Highway known as No. 101 with the centre line of that part of the King's Highway known as No. 129 in the geographic Township of Chappise; thence in a southeasterly and southerly direction along that centre line to the intersection with the centre line of Ranger Lake Road in the geographic Township of Villeneuve; thence in a westerly direction along that centre line to the intersection with the centre line of a road known locally as Hult Road in the geographic Township of Whitman; thence in a westerly direction along that centre line to the intersection with the centre line of the right-of-way of the Algoma Central Railway; thence in a northerly and northwesterly direction along that centre line to the intersection with the centre line of the right-of-way of the Great Lakes Power Corporation Limited in the geographic Township of Home; thence in a northerly direction along that centre line to the intersection with the centre line of the right-of-way of the Algoma Central Railway; thence in a northerly direction along that centre line to the intersection with the centre line of the Michipicoten River; thence in a northeasterly direction along that centre line to the intersection with the centre line of that part of the King's Highway known as No. 101; thence in a

southeasterly direction along that centre line to the place of beginning.

WMU 36

All that land in the Territorial District of Algoma in the Province of Ontario described as follows:

Beginning at the intersection of the centre line of the Montreal River with the centre line of the right-of-way of the Algoma Central Railway; thence in a southeasterly and southerly direction along that centre line to the intersection with the centre line of a road known locally as Hult Road in the geographic Township of Hodgins; thence in an easterly direction along that centre line to the intersection with the centre line of Ranger Lake Road in the geographic Township of Whitman; thence in a northeasterly and southerly direction along that centre line to the intersection with the centre line of that part of the King's Highway known as No. 129; thence in a southerly and southwesterly direction along that centre line to the intersection with the centre line of that part of the King's Highway known as No. 17; thence in a southwesterly direction along that centre line to the intersection with the centre line of the Thessalon River; thence in a southerly direction along that centre line to the intersection with the high water mark on the northerly shore of the North Channel of Lake Huron; thence in a southerly direction along that high water mark to the most southerly extremity of Thessalon Point; thence south astronomically to the intersection with the International Boundary between Canada and the United States of America; thence in a westerly direction along that boundary to the intersection with the easterly boundary of the Township of Hilton; thence in a northerly and northwesterly direction along that boundary to the intersection with the northeasterly boundary of the Township of St. Joseph; thence in a northwesterly and westerly direction along that boundary to the intersection with the International Boundary between Canada and the United States of America; thence in a northerly direction along that boundary to the intersection with the westerly production of the centre line of the Montreal River; thence easterly along that production and that centre line to the place of beginning.

WMU 37

All that land in the Territorial District of Algoma in the Province of Ontario described as follows:

Beginning at the intersection of the centre line of that part of the King's Highway known as No. 17 with the centre line of that part of the King's Highway known as No. 129; thence in a northerly and northeasterly direction along that centre line to the intersection with the centre line of the Mississagi River in the geographic Township of Rollins; thence in an easterly and southerly direction along that centre line to the intersection with the high water mark of Aubrey Lake; thence in a southerly, easterly and northerly direction along that high water mark on the westerly, southerly and easterly shore of that lake to the intersection with the high water mark on the westerly shore of Rocky Island Lake; thence in a southerly, easterly and northerly direction along that high water mark on the westerly, southerly and easterly shore of that lake to the intersection with the northerly boundary of the geographic Township of Winkler; thence easterly and southerly along the northerly and easterly boundaries of that geographic township to the intersection with the centre line of Kindiogami Lake; thence in an easterly and southerly direction along that centre line and the centre line of the Kindiogami River to the intersection with the centre line of that part of the King's Highway known as Secondary Highway No. 546; thence in a southerly direction along that centre line to the intersection with the centre line of that part of the King's Highway known as Secondary Highway No. 639; thence in a southeasterly direction along that centre line to the intersection with the centre line of the Serpent River; thence in a southeasterly direction along the centre line of the Serpent River System composed of the Serpent River, Quirke Lake, Nook Lake, Kindie Lake and Whiskey Lake to the intersection with the northerly boundary of the geographic Township of Gaiashk; thence easterly along the northerly boundary of the geographic townships of Gaiashk, Gerow, Boon, Shibananing and Dunlop to the intersection with the centre line of the Spanish River; thence in a southerly and easterly direction along the centre line of the Spanish River System

composed of the Spanish River and Agnew Lake to the intersection with the easterly boundary of the geographic Township of Shakespear; thence southerly along that boundary to the intersection with the centre line of that part of the King's Highway known as No. 17; thence in a westerly direction along that centre line to the intersection with the centre line of the Serpent River; thence in a westerly direction along that centre line to the intersection with the high water mark on the northerly shore of the North Channel of Lake Huron; thence in a southwesterly direction along that high water mark on the westerly shore of Serpent River Indian Reserve No. 7 to the most southwesterly extremity of Long Point; thence south astronomically to the intersection with the Territorial District boundary between Algoma and Manitoulin; thence westerly along that boundary to the intersection with the International Boundary between Canada and the United States of America; thence in a northwesterly direction along that boundary to the intersection with the straight line drawn south astronomically from the most southerly extremity of Thessalon Point; thence northerly along that straight line to the intersection with the high water mark on the north shore of the North Channel of Lake Huron; thence in a northerly direction along that high water mark to the intersection with the centre line of the Thessalon River; thence in a northerly direction along that centre line to the intersection with the centre line of that part of the King's Highway known as No. 17; thence in a northeasterly direction along that centre line to the place of beginning.

WMU 38

All that land in the territorial districts of Algoma and Sudbury in the Province of Ontario described in WMUs 38A and 38B.

WMU 38A

All that land in the territorial districts of Algoma and Sudbury in the Province of Ontario described as follows:

Beginning at the intersection of the centre line of the Serpent River System with the westerly boundary of the geographic Township of Lehman; thence northerly along that westerly boundary to the southeasterly corner of the geographic Township of Hughson; thence westerly along the southerly boundary of the geographic Township of Hughson to the southwesterly corner thereof; thence northerly along the westerly boundary of the geographic townships of Hughson, Piche, Landriault and Fabro to the southeasterly corner of the Township of Shulman; thence westerly along the southerly boundary of the geographic townships of Shulman, Scrivener, Ruston and Royal to the southwesterly corner of the geographic Township of Royal; thence northerly along the westerly boundary of the geographic townships of Royal and Meen to the northwesterly corner of the geographic Township of Meen; thence easterly along the northerly boundary of the geographic townships of Meen, Morningstar, Nuttall, Parrott, Comox, Ethel and Durban to the northeasterly corner of the geographic Township of Durban; thence southerly along the easterly boundary of the geographic Township of Durban to the northerly boundary of the geographic Township of Avis; thence easterly along the said northerly boundary to the northeasterly corner of the geographic Township of Avis; thence southerly along the easterly boundary of the geographic townships of Avis, Foucault and Monestime to the northwesterly corner of the geographic Township of Redden; thence easterly along the northerly boundary of that geographic township to the northeasterly corner of the geographic Township of Redden; thence southerly along the easterly boundary of the geographic townships of Redden, Strain and Mandamin to the southeasterly corner of the geographic Township of Mandamin; thence westerly along the southerly boundary of the geographic townships of Mandamin, Lockeye and Lehman to the intersection with the centre line of Whiskey Lake in the Serpent River System; thence in a northwesterly direction along the centre line of the Serpent River System composed of Whiskey Lake, Kindie Lake and the Serpent River to the place of beginning.

WMU 38B

All that land in the territorial districts of Algoma and Sudbury in the Province of Ontario described as follows:

1. Beginning at the intersection of the centre line of a road in the geographic Township of Gallagher, known locally as the Devon Road with the centre line of the right-of-way of the Canadian Pacific Railway Company; thence in a southeasterly direction along the centre line of the Canadian Pacific Railway to the intersection with the centre line of the Webbwood Road; thence northerly along that centre line to the intersection with the centre line of a road known locally as the Ramsey Road at the community of Ramsey in the geographic Township of Carew; thence in a general easterly direction along that centre line in the geographic townships of Carew, Fingal, Arbutus, Alcona, Smuts and Invergarry to the intersection with the centre line of that part of the King's Highway known as No. 144; thence in a southerly direction along that centre line to the intersection with the centre line of the Eastsand Creek; thence in a south-westerly direction along that centre line to the intersection with the centre line of the East Spanish River System; thence in a southerly direction along that centre line flowing through Eleventh Lake, Duke Lake, Tenth Lake, Ninth Lake, Eighth Lake, Seventh Lake, Sixth Lake, Fifth Lake, Fourth Lake, Third Lake, Second Lake, First Lake and Expanse Lake to the intersection with the centre line of the Spanish River; thence in a southerly direction along the Spanish River System composed of the Spanish River, Spanish Lake, The Elbow, Graveyard Rapids and Boswell Rapids to the intersection with the northerly boundary of the geographic Township of Dunlop; thence westerly along the northerly boundary of the geographic townships of Dunlop and Shibananing to the southeasterly corner of the geographic Township of Mandamin; thence northerly along the easterly boundary of the geographic townships of Mandamin and Strain to the northeasterly corner of the geographic Township of Strain; thence westerly along the northerly boundary of the geographic Township of Strain to the southeasterly corner of the geographic Township of Redden; thence northerly along the easterly boundary of the geographic Township of Redden to the northeasterly corner thereof; thence westerly along the northerly boundary of the geographic Township of Redden to the southeasterly corner of the geographic Township of Monestime; thence northerly along the easterly boundary of the geographic townships of Monestime, Foucault and Avis to the northeasterly corner of the geographic Township of Avis; thence westerly along the northerly boundary of the geographic Township of Avis to the southeasterly corner of the geographic Township of Durban; thence northerly along the easterly boundary of the geographic Township of Durban to the northeasterly corner thereof; thence westerly along the northerly boundary of the geographic townships of Durban, Ethel, Comox, Parrott, Nuttall, Morningstar and Meen to the northwesterly corner of the geographic Township of Meen; thence southerly along the westerly boundary of the geographic townships of Meen and Royal to the intersection with the high water mark on the southerly shore of Rocky Island Lake; thence in a westerly direction along that high water mark to the intersection with the high water mark of Aubrey Lake; thence in a southerly, westerly and northerly direction along that high water mark on the easterly, southerly and westerly shore of that lake to the intersection with the centre line of the Mississagi River; thence in a westerly direction along that centre line to the intersection with the centre line of the Mississagi River; thence in a westerly direction along that centre line to the intersection with the centre line of that part of the King's Highway known as No. 129; thence in a northerly direction along that centre line to the point of intersection with the centre line of that part of the King's Highway known as No. 101 and No. 129; thence in a northeasterly direction along that centre line to the point of intersection with the centre line of a road known locally as the Devon Road, in the geographic Township of Chappise; thence in a southeasterly and northwesterly direction along that centre line to the place of beginning.

WMU 39

All that land in the Territorial District of Sudbury in the Province of Ontario described as follows:

Beginning at the intersection of the centre line of the right of way of the Canadian National Railway Company with the centre line of that part of the King's Highway known as No. 17; thence in a south-westerly direction along that centre line to the intersection with the easterly boundary of the geographic Township of Shakespeare;

thence northerly along that boundary to the intersection with the centre line of Agnew Lake; thence in a westerly and northerly direction along the centre line of the Spanish River System composed of Agnew Lake, the Spanish River, Boswell Rapids, Graveyard Rapids, The Elbow and Spanish Lake to the intersection with the centre line of the East Spanish River; thence in a northerly direction along the centre line of the East Spanish River System composed of the East Spanish River, Expanse Lake, First Lake, Second Lake, Third Lake, Fourth Lake, Fifth Lake, Sixth Lake, Seventh Lake, Eighth Lake, Ninth Lake, Tenth Lake, Duke Lake and Eleventh Lake to the intersection with the centre line of Eastsand Creek; thence in a northeasterly direction along that centre line to the intersection with the centre line of that part of the King's Highway known as No. 144; thence in a northerly direction along that centre line to the intersection with the centre line of that part of the King's Highway known as Secondary Highway No. 560; thence in an easterly direction along that centre line to the intersection with the centre line of the right-of-way of the Canadian National Railway Company; thence in a south-easterly direction along that centre line to the place of beginning.

WMU 40

All that land in the territorial districts of Nipissing, Sudbury and Timiskaming in the Province of Ontario described as follows:

Beginning at the intersection of the centre line of the right-of-way of the Canadian National Railway Company with the centre line of that part of the King's Highway known as Secondary Highway No. 560 in the geographic Township of Westbrook; thence in a northeasterly direction along the centre line of that part of the King's Highway known as Secondary Highway No. 560 to the intersection with the centre line of the West Montreal River; thence in a northeasterly, northerly, easterly and southerly direction along the centre line of the West Montreal River System composed of Duncan Lake, the West Montreal River, Penassi Lake, Mistinikon Lake, Matachewan Lake and Lower Matachewan Lake to the intersection with the centre line of the Montreal River; thence in a southeasterly direction along the centre line of the Montreal River System composed of the Montreal River, Elk Lake, Mountain Lake and Bay Lake to the intersection with the Interprovincial Boundary between Ontario and Quebec; thence in a southeasterly direction along that boundary to the intersection with the northeasterly production of the centre line of Ottertail Creek; thence in a southwesterly direction along that production and that centre line composed of Ottertail Creek, Otter Lake and a stream flowing into Otter Lake, to the intersection with the northerly boundary of the geographic Township of Hammell; thence westerly along the northerly boundary of the geographic townships of Hammell and Gladman to the intersection with the centre line of Marten Lake; thence westerly and northerly along the centre line of lakes and connecting waterways composed of Marten Lake, the Marten River, Red Cedar Lake, the Temagami River, Cross Lake, Outlet Bay, Lake Temagami, Northwest Arm and Obabika Inlet to the intersection with the high water mark at the most westerly extremity of Obabika Inlet; thence west astronomically to the intersection with the centre line of Obabika Lake; thence in a southerly and westerly direction along that centre line and the production of that centre line to the intersection with the centre line of Wawigama Lake; thence southwesterly along that centre line to the intersection with the centre line of Wawigama Creek; thence in a southwesterly direction along that centre line to the intersection with the centre line of the Obabika River; thence in a southwesterly direction along that centre line to the intersection with the centre line of the Sturgeon River; thence in a northwesterly direction along that centre line to the intersection with the centre line of Oshawatagan Creek; thence in a westerly direction along that centre line to the intersection with the easterly boundary of the geographic Township of Stull; thence westerly along a straight line to the intersection with the centre line of Silvester Creek; thence in a southerly and westerly direction along that centre line to the intersection with the centre line of the Wanapitei River; thence in a southwesterly direction along that centre line to the intersection with the centre line of the right-of-way of the Canadian National Railway Company; thence in a north-westerly direction along that centre line to the place of beginning.

WMU 41

All that land in the territorial districts of Nipissing and Sudbury in the Province of Ontario described as follows:

Beginning at the intersection of the centre line of the right-of-way of the Canadian National Railway Company with the centre line of that part of the King's Highway known as No. 17 at the Town of Coniston; thence in an easterly direction along the centre line of that part of the King's Highway known as No. 17 and the northeasterly production of that centre line to the intersection with the Interprovincial Boundary between Ontario and Quebec; thence in a northwesterly direction along that boundary to the intersection with the northeasterly production of the centre line of Ottertail Creek; thence in a southwesterly direction along that production and centre line composed of Ottertail Creek, Otter Lake and a stream flowing into Otter Lake, to the intersection with the northerly boundary of the geographic Township of Hammell; thence westerly along the northerly boundary of the geographic townships of Hammell and Gladman to the intersection with the centre line of Marten Lake; thence westerly and northerly along the centre line of lakes and connecting waterways composed of Marten Lake, the Marten River, Red Cedar Lake, the Temagami River, Cross Lake, Outlet Bay, Lake Temagami, Northwest Arm and Obabika Inlet, to the intersection with the high water mark at the most westerly extremity of Obabika Inlet; thence west astronomically to the intersection with the centre line of Obabika Lake; thence in a southerly and westerly direction along that centre line and the production of that centre line to the intersection with the centre line of Wawigama Lake; thence southwesterly along that centre line to the intersection with the centre line of Wawigama Creek; thence in a southwesterly direction along that centre line to the intersection with the centre line of the Obabika River; thence in a southwesterly direction along that centre line to the intersection with the centre line of the Sturgeon River; thence in a northwesterly direction along that centre line to the intersection with the centre line of the Oshawatagan Creek; thence in a westerly direction along that centre line to the intersection with the easterly boundary of the geographic Township of Stull; thence westerly along a straight line to the intersection with the centre line of Silvester Creek; thence in a southerly and westerly direction along that centre line to the intersection with the centre line of the Wanapitei River; thence in a southwesterly direction along that centre line to the intersection with the centre line of the right-of-way of the Canadian National Railway Company; thence in a southeasterly direction along that centre line to the place of beginning.

WMU 42

All that land in the territorial districts of Algoma, Manitoulin, Nipissing and Sudbury in the Province of Ontario described as follows:

Beginning at the intersection of the centre line of that part of the King's Highway known as No. 17 with the centre line of the Serpent River; thence in a westerly direction along the centre line of the Serpent River to the intersection with the high water mark on the North Channel of Lake Huron; thence in a southwesterly direction along that high water mark on the westerly boundary of the Serpent River Indian Reserve No. 7 to the most southwesterly extremity of Long Point; thence south astronomically to the intersection with the Territorial District Boundary between Algoma and Manitoulin; thence in an easterly direction along that boundary to the intersection with the high water mark on the northerly shore of the North Channel of Lake Huron at the southwesterly corner of the geographic Township of Harrow; thence in an easterly direction along that high water mark to the intersection with the centre line of that part of the King's Highway known as No. 6; thence in a southerly direction along that centre line to the intersection with the northerly boundary of Whitefish Indian Reserve No. 4; thence in an easterly direction along that boundary to the intersection with the high water mark of Iroquois Bay; thence in a northerly, easterly, southeasterly and southwesterly direction along the high water mark of Iroquois Bay, East Channel, McGregor Bay, Finn Bay, Frazer Bay and Killarney Bay to the intersection with the straight line drawn north astronomically from the most westerly extremity of Phillip Edward Island; thence in a south-

erly direction along that straight line to the intersection with the high water mark on the westerly shore of Phillip Edward Island; thence in a southerly and easterly direction along that high water mark to the most southeasterly extremity of Phillip Edward Island; thence east astronomically to the intersection with the high water mark on the north shore of Georgian Bay; thence in an easterly direction along that high water mark to the intersection with the centre line of Fort Channel of the French River; thence in a northeasterly and easterly direction along that centre line and the centre line of Main Channel of the French River lying south of and off the most easterly extremity of Blueberry Island; thence easterly in a straight line across Lake Nipissing along the boundary between the territorial districts of Nipissing and Parry Sound to the high water mark of Lake Nipissing; thence in a northerly direction along the said high water mark to the northerly boundary of West Ferris as shown on the plan of the geographic Township of Ferris now in the City of North Bay; thence northeasterly along the said northerly boundary to the intersection with the centre line of that part of the King's Highway known as No. 17; thence in a northerly and westerly direction along the said centre line to the place of beginning.

WMU 43

All that land in the Territorial District of Manitoulin in the Province of Ontario described in WMUs 43A and 43B.

WMU 43A

All that land in the Territorial District of Manitoulin in the Province of Ontario described as follows:

Beginning at the southeasterly corner of the Township of Burpee; thence southerly along the southerly production of the easterly boundary of the Township of Burpee to the intersection with the International Boundary between Canada and the United States of America; thence northwesterly along the said International Boundary to the intersection with the southerly production of the centre line of Mississagi Strait, lying between Cockburn Island and Dawson Township; thence northerly along the said southerly production and the centre line of Mississagi Strait and its northerly production to the intersection with the northerly boundary of the Territorial District of Manitoulin; thence easterly along the said northerly boundary to a line drawn north astronomically from the mid point between the most easterly extremity of Henry Island and Fishery Point on Barrie Island; thence south astronomically to the said mid point; thence southeasterly to the centre of Bayfield Sound; thence southeasterly to the intersection with the northerly production of the easterly boundary of the Township of Burpee; thence southerly along the said northerly production and the easterly boundary of the Township of Burpee to the place of beginning.

WMU 43B

All that land in the Territorial District of Manitoulin described as follows:

1. Beginning at the northeasterly corner of the Township of Allan; thence northerly along the northerly production of the easterly boundary of the Township of Allan to the centre of Clapperton Channel; thence north 45° west astronomically to the northerly boundary of the Territorial District of Manitoulin; thence southwesterly and westerly along the said northerly boundary to a line drawn north astronomically from the mid point between the most easterly extremity of Henry Island and Fisherly Point on Barrie Island; thence south astronomically to the said mid point; thence southeasterly to the centre of Bayfield Sound; thence southeasterly to the intersection with the northerly production of the easterly boundary of the Township of Burpee; thence southerly along the said northerly production and the easterly boundary of the Township of Burpee and its southerly production to the intersection with the International Boundary between Canada and the United States of America; thence in a southeasterly direction along the said International Boundary to a point distant 40 miles measured south astronomically from the southeasterly corner of the geographic Township of Humboldt; thence easterly along that line to the southerly production of

the easterly boundary of the Township of Campbell; thence northerly along that southerly production and the easterly boundary of the townships of Campbell and Allan to the place of beginning.

2. Beginning at the northeasterly corner of the Township of Allan; thence northerly along the northerly production of the easterly boundary of the Township of Allan to the centre of Clapperton Channel; thence north 45° west astronomically to the northerly boundary of the Territorial District of Manitoulin; thence easterly along the said boundary to the intersection with the high water mark on the northerly shore of the North Channel of Lake Huron at the southwest corner of the Township of Harrow; thence in an easterly direction along that high water mark to the intersection with the centre line of that part of the King's Highway known as No. 6; thence in a southerly direction along that centre line to the intersection with the northerly boundary of Whitefish Indian Reserve No. 4; thence in an easterly direction along that boundary to the intersection with the high water mark of Iroquois Bay; thence in a northerly, easterly, southeasterly, and southwesterly direction along the high water mark of Iroquois Bay, East Channel, McGregor Bay, Finn Bay, Frazer Bay and Killarney Bay to the intersection with a straight line drawn north astronomically from the most westerly extremity of Phillip Edward Island; thence in a southerly direction along that straight line to the intersection with the high water mark on the westerly shore of Phillip Edward Island; thence in a southerly and easterly direction along that high water mark to the most southeasterly extremity of Phillip Edward Island; thence east astronomically to the intersection with a high water mark on the north shore of Georgian Bay; thence in an easterly direction along that high water mark to the intersection with the southeasterly corner of the geographic Township of Humboldt; thence south in a straight line to a point distant 40 miles measured south astronomically from the southeasterly corner of the geographic Township of Humboldt; thence west astronomically to the intersection with the southerly production of the easterly boundary of the Township of Campbell; thence northerly along the said southerly production and the easterly boundary of the townships of Campbell and Allan to the place of beginning.

WMU 44

All that land in the Territorial District of Manitoulin in the Province of Ontario described as follows:

Beginning at the intersection of the International Boundary between Canada and the United States of America with the Territorial District Boundary between Algoma and Manitoulin opposite Drummond Island; thence in an easterly direction along that boundary a distance of 20 kilometers; thence south 32° west astronomically through the waters of the North Channel to the confluence of those waters with the waters of the Mississagi Strait; thence southwesterly along the centre line of Mississagi Strait to the confluence with the waters of Lake Huron; thence continuing south 32° west astronomically to the intersection with the International Boundary between Canada and the United States of America; thence in a northwesterly and northeasterly direction along that boundary to the place of beginning.

WMU 45

All that land in the Territorial District of Algoma in the Province of Ontario described as follows:

Beginning at the intersection of the International Boundary between Canada and the United States of America with the easterly boundary of the Township of Hilton; thence in a northerly and northwesterly direction along that boundary to the intersection with the northeasterly boundary of the Township of St. Joseph; thence in a northwesterly and westerly direction along that boundary to the intersection with the International Boundary between Canada and the United States of America; thence in a southeasterly and easterly direction along that centre line to the place of beginning.

WMU 46

All that land in the Territorial District of Parry Sound and The

District Municipality of Muskoka in the Province of Ontario described as follows:

Beginning at the intersection of the centre line of the Main Channel of the French River with the centre line of that part of the King's Highway known as No. 69; thence southeasterly along the centre line of that highway to the intersection with the centre line of that part of the King's Highway known as No. 169; thence in a southeasterly direction along that centre line to the intersection with the centre line of that part of the King's Highway known as No. 11 at Gravenhurst; thence southerly along that centre line to the intersection with the centre line of the Severn River; thence westerly, northerly, northwesterly and southwesterly along that centre line and the centre line of Sparrow Lake to the intersection with the centre line of Gloucester Pool; thence continuing southwesterly along the centre line of Gloucester Pool and Little Lake to the intersection with the locks at the Compact Rural Community of Port Severn; thence westerly along those locks to the boundary between the district Municipality of Muskoka and the County of Simcoe; thence southwesterly and northwesterly along that boundary to the intersection with a straight line astronomically west to the most northerly extremity of Giant's Tomb Island; thence northwesterly in a straight line to the intersection of latitude of 45° 00' north with longitude 80° 30' west; thence northwesterly in a straight line to a point distant 40 miles measured on a course of south astronomic from the southeast corner of the Township of Humboldt; thence north astronomically to the said southeast corner; thence easterly along the southerly boundary of the geographic Township of Travers to the intersection with the centre line of the western channel of French River; thence easterly along that centre line and the centre line of the Main Channel of the French River to the place of beginning.

Saving and excepting that part of the Township of Muskoka Lakes, formerly the Township of Medora, in The District Municipality of Muskoka lying easterly of the centre line of the right of way of the Canadian National Railway Company and westerly of the centre line of that part of the King's Highway known as No. 169, and saving and excepting that part of the Township of Muskoka Lakes and the Town of Gravenhurst, formerly the Township of Wood, lying southerly of the centre line of that part of the King's Highway known as No. 169, easterly of the centre line of the right-of-way of the Canadian National Railway Company and northerly of the line between concessions XV and XVI in the said Township of Wood.

WMU 47

All that land in the territorial districts of Nipissing and Parry Sound described as follows:

Beginning at the intersection of the centre line of that part of the King's Highway known as No. 69 with the centre line of the Main Channel of the French River; thence in a general northeasterly direction along the centre line of the Main Channel of the French River to a point lying south of and off the most easterly extremity of Blueberry Island; thence easterly in a straight line across Lake Nipissing along the boundary between the Territorial District of Nipissing and Parry Sound to the high water mark of Lake Nipissing; thence easterly along the northerly boundary of the Township of North Himsforth, as shown on a plan of the Township of Himsforth, to the centre line of that part of the King's Highway known as No. 11; thence in a southerly direction along that centre line to the intersection with the centre line of that part of the King's Highway known as No. 124; thence in a southwesterly direction along that centre line to the intersection with the northerly bank of the Magnetawan River; thence continuing in a westerly direction along the northerly bank of the Magnetawan River to the intersection with the centre line of that part of the King's Highway known as No. 69; thence in a northerly direction along that centre line to the place of beginning.

WMU 48

All that land in the territorial districts of Nipissing and Parry Sound and the County of Renfrew in the Province of Ontario described as follows:

Beginning at the intersection of the northerly boundary of the

Township of West Ferris as shown on the plan of the Township of Ferris now in the City of North Bay with the centre line of that part of the King's Highway known as No. 17; thence in an easterly direction along the centre line of that part of the King's Highway known as No. 17 and the northeasterly production of that centre line in the Town of Mattawa to the intersection with the Interprovincial Boundary between Ontario and Quebec; thence in an easterly and south-easterly direction along that boundary to the intersection with the northeasterly production of the centre line of Trafalgar Road in the City of Pembroke being also of that part of the King's Highway known as No. 62; thence in a southwesterly direction along that production and the centre line of that part of the King's Highway known as No. 62 to the intersection with the centre line of the Indian River; thence in a westerly direction along that centre line to the intersection with the boundary of Algonquin Provincial Park; thence in a northwesterly, southwesterly and southeasterly direction along that boundary to the intersection with the centre line of the Amable du Fond River in the geographic Township of Ballantyne; thence in a westerly direction along that centre line to the intersection with the waters of Kawawaymog Lake; thence in a westerly direction along that water's edge to the intersection with the southerly production of the centre line of a road known locally as the South River Access Road; thence in a southwesterly direction along that centre line to the intersection with the centre line of that part of the King's Highway known as No. 11 at the Village of South River; thence in a northerly direction along that centre line to the intersection with the northerly boundary of the Township of North Himsforth, as shown on the plan of the Township of Himsforth; thence in a westerly direction along that northerly boundary to the intersection with the high water mark of Lake Nipissing; thence in a northerly direction along that high water mark to the intersection with the northerly boundary of the Township of West Ferris as shown on a plan of the Township of Ferris now in the City of North Bay; thence in an easterly direction along that northerly boundary to the place of beginning.

WMU 49

All that land in the Territorial District of Parry Sound and The District Municipality of Muskoka in the Province of Ontario described as follows:

Beginning at the intersection of the centre line of that part of the King's Highway known as No. 69 with the water's edge along the northerly bank of the north branch of the Magnetawan River; thence in a general easterly direction along that water's edge to the intersection with the centre line of that part of the King's Highway known as No. 124; thence in a general easterly direction along that centre line to the intersection with the centre line of that part of the King's Highway known as No. 11; thence in a general southerly direction along that centre line to the intersection with the centre line of that part of the King's Highway known as No. 141; thence in a general southwesterly and northwesterly direction along that centre line to the intersection with the centre line of that part of the King's Highway known as No. 69; thence in a general northwesterly direction along that centre line to the place of beginning.

WMU 50

All that land in the territorial districts of Parry Sound and Nipissing, The District Municipality of Muskoka and the Provisional County of Haliburton in the Province of Ontario described as follows:

Beginning at the intersection of the centre line of that part of the King's Highway known as No. 11 with the centre line of a road known locally as the South River Access Road at the Village of South River; thence in a northeasterly direction along the centre line of the South River Access Road to the intersection with the water's edge along the north shore of Kawawaymog Lake; thence in a general easterly direction along that water's edge to the intersection with the centre line of the Amable du Fond River; thence in a general easterly direction along that centre line to the intersection with the westerly boundary of Algonquin Provincial Park in the geographic Township of Ballantyne; thence in a southerly direction along that boundary to the intersection with the centre line of that part of the

King's Highway known as No. 60; thence in a general southwesterly and northwesterly direction along that centre line to the intersection with the centre line of that part of the King's Highway known as No. 11; thence in a general northwesterly direction along that centre line to the place of beginning.

WMU 51

All that land in the Territorial District of Nipissing and the Provisional County of Haliburton in the Province of Ontario described as follows:

1. Beginning at the intersection of the north boundary of Algonquin Provincial Park with the centre line of a road known locally as the Brent Road in the geographic Township of Deacon; thence in a southerly direction along that centre line to the intersection with the centre line of the right-of-way of the Canadian National Railway Company at the Dispersed Rural Community of Brent; thence in a southeasterly direction along that centre line to the intersection with the centre line of the Little Madawaska River at the Railway Point of Odenback; thence in a southwesterly direction along that centre line, the centre line of Charles Creek and the centre line of Charles Lake to the intersection with the water's edge at the most westerly extremity of Charles Lake; thence in an southeasterly direction along a straight line running from the most westerly extremity of Charles Lake to the most northerly extremity of Annie Bay of Opeongo Lake; thence in a general southeasterly, northwesterly, westerly and southerly direction along the water's edge of Opeongo Lake to the intersection with the centre line of a road known locally as Opeongo Lake Access Road; thence in a southerly direction along that centre line to the intersection with the centre line of that part of the King's Highway known as No. 60; thence in a general southeasterly direction along that centre line to the intersection with the boundary of Algonquin Provincial Park in the geographic Township of Airy; thence in a southwesterly and southeasterly direction along that boundary to the intersection with the northerly boundary of the townships of Dysart, Bruton, Clyde, Dudley, Eyre, Guilford, Harburn, Harcourt and Havelock which was formerly the Township of Clyde; thence in a southwesterly direction along the northerly boundary of that part to the intersection with the boundary of Algonquin Provincial Park at the northeasterly corner of the townships of Dysart, Bruton, Clyde, Dudley, Eyre, Guilford, Harburn, Harcourt and Havelock which was formerly the Township of Eyre; thence in a southwesterly, northwesterly and northeasterly direction along the southerly, westerly and northerly boundaries of Algonquin Provincial Park to the place of beginning.

2. Beginning at the intersection of the north boundary of Algonquin Provincial Park with the centre line of a road known locally as the Brent Road in the geographic Township of Deacon; thence in a southerly direction along that centre line to the intersection with the centre line of the right-of-way of the Canadian National Railway Company at the Dispersed Rural Community of Brent; thence in a southeasterly direction along that centre line to the intersection with the centre line of the Little Madawaska River at the Railway Point of Odenback; thence in a southwesterly direction along that centre line, the centre line of Charles Creek, and the centre line of Charles Lake to the intersection with the water's edge at the most westerly extremity of Charles Lake; thence in a southeasterly direction along a straight line running from the most westerly extremity of Charles Lake to the most northerly extremity of Annie Bay of Opeongo Lake; thence southeasterly, northwesterly, westerly and southerly along the water's edge of Opeongo Lake to the intersection with the centre line of a road known locally as the Opeongo Lake Access Road; thence in a southerly direction along that centre line to the intersection with the centre line of that part of the King's Highway known as No. 60; thence in a southeasterly direction along that centre line to the intersection with the boundary of Algonquin Provincial Park in the geographic Township of Airy; thence in a northeasterly, northwesterly and southwesterly direction along the south, east and north boundaries of Algonquin Provincial Park to the place of beginning.

WMU 53

All that land in the Territorial District of Parry Sound, The Dis-

tract Municipality of Muskoka, the counties of Simcoe and Victoria and the Provisional County of Haliburton in the Province of Ontario described in WMUs 53A and 53B.

WMU 53A

All that land in the Territorial District of Parry Sound, The District Municipality of Muskoka, the counties of Simcoe and Victoria and the Provisional County of Haliburton in the Province of Ontario described as follows:

Beginning at the intersection of the centre line of that part of the King's Highway known as No. 141 with the centre line of that part of the King's Highway known as No. 69; thence in a southerly direction along the centre line of that part of the King's Highway known as No. 69 to the centre line of that part of the King's Highway known as No. 169; thence in a southeasterly direction along that centre line to the centre line of that part of the King's Highway known as No. 11; thence in a southerly direction along that centre line to the centre line of the Severn River; thence in an easterly and southerly direction along that centre line to the westerly production of the centre line of the Black River; thence in an easterly and northerly direction along that production and the centre line of the Black River to the centre line of that part of the King's Highway known as No. 35; thence in a northwesterly direction along that centre line to the intersection with the centre line of that part of the King's Highway known as No. 60; thence in a westerly direction along that centre line to the intersection with the centre line of that part of the King's Highway known as No. 11; thence in a southerly direction along that centre line to the centre line of that part of the King's Highway known as No. 141; thence in a southwesterly and northwesterly direction along that centre line to the place of beginning.

Saving and excepting that part of the Township of Muskoka Lakes in The District Municipality of Muskoka, formerly the Township of Medora, lying easterly of that part of the King's Highway known as No. 169 and the centre line of the right-of-way of the Canadian National Railway Company.

Also saving and excepting that part of the Township of Muskoka Lakes in The District Municipality of Muskoka, formerly the Township of Wood, lying easterly of the centre line of the right-of-way of the Canadian National Railway Company and northerly of the centre line of that part of the King's Highway known as No. 169.

Also saving and excepting that part of the Township of Rama lying easterly of the centre line of the Severn River and northerly and westerly of the Black River.

WMU 53B

All that land in The District Municipality of Muskoka described as follows:

1. That part of the Township of Muskoka Lakes in The District Municipality of Muskoka, formerly the Township of Medora, lying easterly of that part of the King's Highway known as No. 169 and the centre line of the right-of-way of the Canadian National Railway Company.

2. That part of the Township of Muskoka Lakes in The District Municipality of Muskoka, formerly the Township of Wood, lying easterly of the centre line of the right-of-way of the Canadian National Railway Company and northerly of the centre line of that part of the King's Highway known as No. 169.

3. That part of the Township of Muskoka Lakes, formerly the Township of Medora, in The District Municipality of Muskoka lying easterly of the centre line of the right of way of the Canadian National Railway Company and westerly of the centre line of that part of the King's Highway known as No. 169.

4. That part of the Township of Muskoka Lakes and the Town of Gravenhurst, formerly the Township of Wood, lying southerly of the centre line of that part of the King's Highway known as No. 169, easterly of the centre line of the right-of-way of the Canadian

National Railway Company and northerly of the line between concessions XV and XVI in the said Township of Wood.

WMU 54

All that land in The District Municipality of Muskoka and the Provisional County of Haliburton in the Province of Ontario described as follows:

Beginning at the intersection of the centre line of that part of the King's Highway known as No. 60 with the centre line of that part of the King's Highway known as No. 35; thence in a southeasterly direction along the centre line of that part of the King's Highway known as No. 35 to the intersection with the centre line of the river connecting Boshkung Lake and Beech Lake, being part of the Gull River System; thence in a northeasterly direction along the centre line of that river system comprised of Beech Lake, Maple Lake, Green Lake, Pine Lake, Cranberry Lake, Eagle Lake, Moose Lake, Oblong Lake, Haliburton Lake and Percy Lake to the intersection with the boundary of Algonquin Provincial Park; thence in a southeasterly, northeasterly and northwesterly direction along that boundary to the intersection with the northerly boundary of the Township of Dysart, Bruton, Clyde, Dudley, Eyre, Guilford, Harburn, Harcourt and Havelock, formerly the Township of Clyde; thence in a southwesterly direction along that boundary of that part to the intersection with the boundary of Algonquin Provincial Park at the northeast corner of the Township of Dysart, Bruton, Clyde, Dudley, Eyre, Guilford, Harburn, Harcourt and Havelock which was formerly the Township of Eyre; thence in a southwesterly and northwesterly direction along that boundary to the intersection with the centre line of that part of the King's Highway known as No. 60; thence in a southwesterly direction along that centre line to the place of beginning.

WMU 55

All that land in the Territorial District of Nipissing and the County of Renfrew in the Province of Ontario, described as WMU's 55A and 55B.

WMU 55A

All that land in the Territorial District of Nipissing and the County of Renfrew in the Province of Ontario described as follows:

Beginning at the intersection of the centre line of the King's Highway Number 60 with the centre line of the King's Highway Number 62 in the Village of Barry's Bay;

Thence southerly along the centre line of the said Highway 62 to the intersection with the southerly boundary of the Township of Sherwood;

Thence southwesterly along the southerly boundary of the townships of Sherwood, Jones, Lyell and Sabine to the intersection with an easterly boundary of Algonquin Provincial Park;

Thence northwesterly and northeasterly along an easterly and southeasterly boundary of the said Park to the northwesterly corner of the Township of Burns;

Thence southeasterly along the westerly boundary of the said township to the southwesterly corner thereof;

Thence northeasterly along the southerly boundary of the said township to the intersection with the high water mark of the southerly shore of Paugh Lake;

Thence easterly along the said high water mark to the intersection with the centre line of Paugh Creek;

Thence southerly along the said centre line to the intersection with the centre line of the Paugh Lake Road;

Thence southerly along the centre line of the said road to the inter-

section with the centre line of the King's Highway Number 60 in the Village of Barry's Bay;

Thence easterly along the centre line of Highway 60 to the place of beginning.

WMU 55B

All that land in the County of Renfrew in the Province of Ontario described as follows:

Beginning at the intersection of the centre line of the King's Highway Number 62 with the centre line of the King's Highway Number 41 in the City of Pembroke;

Thence southerly along the centre line of the said Highway 41 to the intersection with the centre line of the King's Highway Number 60;

Thence westerly and southwesterly along the centre line of the said Highway 60 to the intersection with the centre line of the Paugh Lake Road in the Village of Barry's Bay;

Thence northerly along the centre line of the said Paugh Lake Road to the intersection with the centre line of Paugh Creek;

Thence northwesterly along the said centre line of Paugh Creek to the intersection with the high water mark of the southerly shore of Paugh Lake;

Thence westerly along the said high water mark to the intersection with the southerly boundary of the Township of Burns;

Thence southwesterly along the southerly boundary of the said township to the southwesterly corner thereof;

Thence northwesterly along the westerly boundary of the said township to the intersection with a southeasterly boundary of Algonquin Provincial Park;

Thence northeasterly along the said southeasterly boundary to the intersection with the center line of the Indian River;

Thence easterly along the centre line of the said river to the intersection with the centre line of the King's Highway Number 62;

Thence northeasterly along the centre line of the said highway to the place of beginning.

WMU 56

All that land in The District Municipality of Muskoka and the counties of Peterborough, Simcoe and Victoria and the Provisional County of Haliburton in the Province of Ontario described as follows:

Beginning at the intersection of the centre line of the Black River with the centre line of that part of the King's Highway known as No. 35; thence in a southerly direction along the centre line of that part of the King's Highway known as No. 35 to the intersection with the centre line of the river connecting Boshkung Lake and Beech Lake, being part of the Gull River System; thence in a northeasterly direction along the centre line of Gull River System composed of Beech Lake, Maple Lake, Green Lake, Pine Lake, Cranberry Lake, Eagle Lake, Moose Lake, Oblong Lake, Haliburton Lake and Percy Lake to the intersection with the westerly boundary of the Township of Bruton; thence in a southeasterly direction along the westerly boundary of the townships of Bruton and Harcourt to the intersection with the centre line of County Road No. 15 running in a southeasterly direction near the west boundary of the Township of Harcourt; thence in a southeasterly direction along that centre line to the intersection with that part of the King's Highway known as Secondary Highway No. 648 near the Compact Rural Community of Wilberforce; thence in a southwesterly direction along that centre line to the intersection with the centre line of that part of the King's Highway known as No. 121; thence in a southwesterly direction along that

centre line to the intersection with the centre line of that part of the King's Highway known as Secondary Highway No. 503 at the Compact Rural Community of Tory Hill; thence in a southwesterly direction along that centre line and the centre line of County Road No. 45 to the intersection with the centre line of that part of the King's Highway known as No. 169; thence in a northwesterly direction along that centre line to the intersection with the centre line of the Black River; thence in a northerly and northeasterly direction along that centre line to the place of beginning.

Saving and excepting that part of the Township of Rama lying easterly of the centre line of the right-of-way of that part of the King's Highway known as No. 169 and southerly and easterly of the centre line of the Severn River and the Black River and northerly of the centre line of County Road No. 45.

WMU 57

All that land in the counties of Hastings and Renfrew and the Provisional County of Haliburton in the Province of Ontario described as follows:

Beginning at the intersection of the centre line of that part of the King's Highway known as No. 121 with the centre line of that part of the King's Highway known as Secondary Highway No. 648 in the Township of Monmouth; thence in a northerly direction along the centre line of that part of the King's Highway known as Secondary Highway No. 648 to the intersection with the centre line of County Road No. 15 north of the Compact Rural Community of Wilberforce and running in a northwesterly direction west of the westerly boundary of the Township of Harcourt; thence in a northwesterly and northeasterly direction along that centre line to the intersection with the westerly boundary of the Township of Harcourt; thence in a northerly direction along that westerly boundary to the intersection with the southerly boundary of the Township of Bruton; thence in an easterly and northerly direction along the southerly and easterly boundary of the Township of Bruton to the northerly boundary of the Township of McClure; thence in an easterly direction along the northerly boundary of the townships of Wicklow and Bangor and the northerly boundary of the Township of Radcliffe to the intersection with the centre line of that part of the King's Highway known as No. 62; thence in a southeasterly direction along that centre line to the intersection with the centre line of that part of the King's Highway known as Secondary Highway No. 515 near the Dispersed Rural Community of Combermere; thence in a southeasterly direction along that centre line to the intersection with the centre line of that part of the King's Highway known as Secondary Highway No. 514 at the Dispersed Rural Community of Latchford Bridge; thence in a southerly direction along that centre line to the intersection with the centre line of that part of the King's Highway known as Secondary Highway No. 500 at the Dispersed Rural Community of Hardwood Lake; thence in a southwesterly and westerly direction along that centre line to the intersection with the centre line of that part of the King's Highway known as No. 28 at the Village of Bancroft; thence in a southwesterly direction along that centre line to the intersection with the centre line of that part of the King's Highway known as No. 121; thence in a westerly direction along that centre line to the place of beginning.

WMU 58

All that land in the counties of Lennox and Addington and Renfrew in the Province of Ontario described as follows:

Beginning at the intersection of the centre line of that part of the King's Highway known as No. 60 with the centre line of that part of the King's Highway known as No. 62 at the Village of Barry's Bay; thence in a southeasterly direction along that centre line to the intersection with the centre line of that part of the King's Highway known as Secondary Highway No. 515 near the Dispersed Rural Community of Combermere; thence in a southeasterly direction along that centre line to the intersection with the centre line of that part of the King's Highway known as Secondary Highway No. 514 at the Dispersed Rural Community of Latchford Bridge; thence in a southerly direction along that centre line to the intersection with the centre line of that part of the King's Highway known as Secondary Highway No.

500 at the Dispersed Rural Community of Hardwood Lake; thence in a southeasterly direction along that centre line to the intersection with the centre line of that part of the King's Highway known as No. 41 at the Compact Rural Community of Denbigh; thence in a northeasterly direction along that centre line to the intersection with the centre line of the Madawaska River; thence in a southeasterly and northeasterly direction along that centre line to the intersection with the centre line of that part of the King's Highway known as Secondary Highway No. 511; thence in a northwesterly direction along that centre line to the intersection with the centre line of that part of the King's Highway known as Secondary Highway No. 508 at the Compact Rural Community of Calabogie; thence in a southwesterly direction along that centre line to the intersection in the Township of Bagot and Blithfield, formerly the Township of Blithfield, with the centre line of the road running in a northwesterly direction from that part of the King's Highway known as Secondary Highway No. 508 to the Dispersed Rural Community of Dacre; thence in a northwesterly direction along that centre line to the intersection with the centre line of that part of the King's Highway known as No. 132; thence in a westerly direction along that centre line to the intersection with the centre line of that part of the King's Highway known as No. 41; thence in a northwesterly direction along that centre line to the intersection with the centre line of that part of the King's Highway known as No. 60; thence in a general westerly direction along that centre line to the place of beginning.

WMU 59

All that land in the County of Renfrew in the Province of Ontario described as follows:

Beginning at the intersection of the centre line of that part of the King's Highway known as No. 62 with the centre line of that part of the King's Highway known as No. 41 in the City of Pembroke; thence in an easterly direction along the easterly production of the centre line of that part of the King's Highway known as No. 62 to the intersection with the Interprovincial Boundary between Ontario and Quebec; thence in a general southeasterly direction along that boundary to the intersection with the northeasterly production of the centre line of the Madawaska River near the Town of Arnprior; thence in a southwesterly direction along that production and that centre line to the intersection with the centre line of that part of the King's Highway known as Secondary Highway No. 511; thence in a northwesterly direction along that centre line to the intersection with the centre line of that part of the King's Highway known as Secondary Highway No. 508 at the Compact Rural Community of Calabogie; thence in a southwesterly direction along that centre line to the intersection in the Township of Bagot and Blithfield, formerly the Township of Blithfield, with the centre line of that road running in a northwesterly direction from that part of the King's Highway known as Secondary Highway No. 508 to the Dispersed Rural Community of Dacre; thence in a northwesterly direction along that centre line to the intersection with the centre line of that part of the King's Highway known as No. 132; thence in a westerly direction along that centre line to the intersection with the centre line of that part of the King's Highway known as No. 41; thence in a northwesterly and northerly direction along that centre line to the place of beginning.

WMU 60

All that land in the counties of Haliburton, Hastings, Peterborough and Victoria, in the Province of Ontario, described as WMU's 60A and 60B.

WMU 60A

All that land in the counties of Haliburton, Hastings, Peterborough and Victoria described as follows:

Beginning at the intersection of the centre line of that part of the King's Highway known as No. 35 with the centre line of that part of the King's Highway known as Secondary Highway No. 503 in the Compact Rural Community of Norland; thence in a northeasterly direction along that centre line to the intersection with the centre line of that part of the King's Highway known as No. 121 at the Compact Rural Community of Tory Hill; thence in an easterly direction along

that centre line to the intersection with the centre line of that part of the King's Highway known as No. 28; thence in a northeasterly direction along that centre line of the intersection with the centre line of that part of the King's Highway known as No. 62 at the Village of Bancroft; thence in a southeasterly direction along that centre line to the intersection with the centre line of that part of the King's Highway known as No. 7; thence in a southwesterly direction along that centre line to the intersection near the Village of Havelock with the centre line of County Road No. 44 running in a northwesterly direction from that part of the King's Highway known as No. 7 to the Compact Rural Community of Nephton; thence in a northwesterly direction along that centre line and the centre line of County Road No. 6 to the intersection with the easterly production of the centre line of Stony Lake; thence in a westerly, southerly, northerly and southwesterly direction along that production and the centre line of the Kawartha Lake System including Stony Lake, Lower Buckhorn Lake, Buckhorn Lake, Pigeon Lake and Sturgeon Lake to the intersection with the centre line of that part of the King's Highway known as No. 35A at the Village of Fenelon Falls; thence in a southwesterly direction along that centre line to the intersection with the centre line of that part of the King's Highway known as No. 35; thence in a northerly direction along that centre line to the place of beginning.

Saving and excepting those parts of the townships of Verulam and Fenelon lying northerly of the centre line of Sturgeon Lake and that part of the King's Highway known as No. 35A and easterly of that part of the King's Highway known as No. 35.

Also saving and excepting that part of the townships of Belmont and Methuen and Burleigh and Anstruther, in the County of Peterborough, described as WMU 60B.

Also saving and excepting Petroglyphs Provincial Park in the Township of Burleigh and Anstruther, in the County of Peterborough, as described in Schedule 120 to Regulation 821 of Revised Regulations of Ontario, 1980, as that Schedule read on the 31st day of December, 1990.

Also saving and excepting part of the Peterborough Crown Game Preserve in the townships of Belmont and Methuen and Burleigh and Anstruther, in the County of Peterborough, described as follows:

Beginning at the southwesterly corner of Lot 3, Concession XV, New Survey, as shown on the plan of the Township of Burleigh; thence northerly along the westerly limit of lots 3, 4, and 5, Concession XV, New Survey, to the northwesterly corner of that Lot 5; thence northerly in a straight line across the allowance for road between lots 5 and 6 to the southwesterly corner of Lot 6, Concession XV, New Survey; thence northerly along the westerly limit of lots 6, 7, 8, 9 and 10, Concession XV, New Survey, to the northwesterly corner of that Lot 10; thence northerly in a straight line across the allowance for road between lots 10 and 11 to the southwesterly corner of Lot 11, Concession XV, New Survey; thence northerly along the westerly limit of lots 11, 12, 13 and 14, Concession XV, New Survey, to the northwesterly corner of that Lot 14; thence easterly along the northerly limit of Lot 14, concessions XV and XVI, New Survey and along the easterly production of that Lot 14, Concession XVI, across the allowance for road along the shore of Jack Lake to the water's edge along the northerly shore of that lake; thence easterly along that water's edge to the intersection with the water's edge along the easterly shore of Redmond Creek; thence easterly and northeasterly along that water's edge to the intersection with the northerly limit of Lot 31, Concession VIII, as shown on the plan of the Township of Methuen; thence easterly along the northerly limit of that Lot 31 to the northeasterly corner thereof; thence southerly along the easterly limit of that Lot 31 to the southeasterly corner thereof; thence southerly in a straight line across the allowance for road between lots 30 and 31 to the northeasterly corner of Lot 30, Concession VIII; thence southerly along the easterly limit of lots 30, 29, 28, 27 and 26, Concession VIII, to the southeasterly corner of that Lot 26; thence southerly in a straight line across the allowance for road between lots 25 and 26 to the northeasterly corner of Lot 25, Concession VIII; thence southerly along the easterly limit of lots 25, 24 and 23, Concession VIII to the southeasterly corner of that Lot 23; thence westerly along the southerly limit of Lot 23, Con-

cession VIII to the southwesterly corner of the easterly half of that Lot 23; thence southerly along the easterly limit of the westerly half of Lot 22, Concession VIII, to the southeasterly corner thereof; thence westerly along the southerly limit of the westerly half of that Lot 22 to the southwesterly corner thereof; thence westerly in a straight line across the allowance for road between concessions VIII and IX to the southeasterly corner of Lot 22, Concession IX; thence westerly along the southerly limit of that Lot 22 to the southwesterly corner thereof; thence westerly in a straight line across the allowance for road between concessions IX and X to the southeasterly corner of Lot 22, Concession X; thence westerly along the southerly limit of that Lot 22 to the southwesterly corner thereof; thence westerly in a straight line across the allowance for road between concessions X and XI to the southeasterly corner of Lot 22, Concession XI; thence westerly along the southerly limit of that Lot 22 to the southwesterly corner thereof; thence westerly in a straight line across the allowance for road between concessions XI and XII to the southeasterly corner of Lot 22, Concession XII; thence westerly along the southerly limit of that Lot 22 to the southwesterly corner thereof; thence westerly in a straight line across the allowance for road adjoining Lot 22, Concession XII, as shown on the plan of the Township of Methuen and across the allowance for road adjoining Lot 3, Concession XVI, New Survey, as shown on the plan of the Township of Burleigh, to the southeasterly corner of that Lot 3; thence westerly along the southerly limit of Lot 3, concessions XVI and XV, New Survey, as shown on the plan of the Township of Burleigh, to the place of beginning.

WMU 60B

All that land in the townships of Belmont and Methuen and Burleigh and Anstruther, in the County of Peterborough, also known as the Peterborough Crown Game Preserve, described as follows:

Beginning at the intersection of the water's edge along the easterly shore of Jack Creek with the water's edge along the northerly shore of Stony Lake; thence northeasterly following the water's edge along the easterly shore of Jack Creek to the centre line of the allowance for road between lots 5 and 6, Concession XII, Old Survey, as shown on the plan of the township of Burleigh; thence easterly along that centre line to the centre line of a road known as the Nephelene Mine Road; thence in a easterly and northeasterly direction along that centre line to the water's edge along the westerly shore of Kasshabog Lake opposite Lot 14, Concession VIII, as shown on the plan of the Township of Methuen; thence in a general northeasterly direction along that water's edge to the southerly production of the centre line of the allowance for road between concessions VI and VII; thence northerly along that production and the centre line of the allowance for road between concessions VI and VII to the easterly production of the northerly limit of Lot 31, Concession VII; thence westerly along that easterly production and the northerly limit of Lot 31, Concession VII, to the northwesterly corner thereof; thence westerly in a straight line across the allowance for road between concessions VII and VIII to the northeasterly corner of Lot 31, Concession VIII; thence westerly along the northerly limit of that Lot 31 to the water's edge along the westerly shore of Redmond Creek; thence in a southwesterly and westerly direction along that water's edge to the intersection with the water's edge along the northerly shore of Redmond Bay of Jack Lake; thence in a general westerly direction following that water's edge and the water's edge along the northerly shore of Jack Lake and along the water's edge along the northerly shore of Brook Bay of Jack Lake to the easterly production of the northerly limit of Lot 14, Concession XVI, New Survey, as shown on the plan of the Township of Burleigh; thence westerly along that production and the northerly limit of Lot 14, Concessions XVI and XV, to the northwesterly corner of said Lot 14, Concession XV; thence westerly in a straight line across the allowance for road between concessions XIV and XV to the northeasterly corner of Lot 14, Concession XIV; thence westerly along the northerly limit of Lot 14, Concession XIV, to the northwesterly corner thereof; thence southerly along the easterly limit of lots 14 and 13, Concession XIII, to the southeasterly corner of that Lot 13; thence westerly along the southerly limit of that Lot 13 to the southwesterly corner thereof; thence westerly in a straight line across the allowance for road between concessions XIII and XII to the southeasterly corner of Lot 13, Concession XII; thence westerly along the southerly limit of that Lot 13 and along the

westerly prolongation of the said southerly limit across the allowance for road along the easterly shore of Eels Creek to the water's edge thereof; thence southerly along that water's edge to the westerly prolongation of the northerly limit of Lot 10, Concession XI; thence easterly along that westerly prolongation and the northerly limit of said Lot 10 to the northeasterly corner thereof; thence southerly along the easterly limit of lots 10 and 9, Concession XI, to the southeasterly corner of that Lot 9; thence westerly along the southerly limit of Lot 9, Concession XI, to the southwesterly corner thereof; thence northerly along the westerly limit of that Lot 9 and along the northerly prolongation of that westerly limit across the allowance for road along the easterly shore of Eels Creek to the water's edge thereof; thence in a southwesterly and southeasterly direction along that water's edge to the intersection with the water's edge along the northerly shore of Stony Lake; thence in a general easterly direction along that water's edge to the place of beginning.

Saving and excepting Petroglyphs Provincial Park as described in Schedule 120, Regulation 821 of R.R.O. 1980, as that Schedule read on the 31st day of December, 1990.

Also saving and excepting part of the Peterborough Crown Game Preserve in the townships of Belmont and Methuen and Burleigh and Anstruther, in the County of Peterborough, described as follows:

Beginning at the southwesterly corner of Lot 3, Concession XV, New Survey, as shown on the plan of the Township of Burleigh; thence northerly along the westerly limit of lots 3, 4 and 5, Concession XV, New Survey, to the northwesterly corner of that Lot 5; thence northerly in a straight line across the allowance for road between lots 5 and 6 to the southwesterly corner of Lot 6, Concession XV, New Survey; thence northerly along the westerly limit of Lots 6, 7, 8, 9 and 10, Concession XV, New Survey, to the northwesterly corner of that Lot 10; thence northerly in a straight line across the allowance for road between lots 10 and 11 to the southwesterly corner of Lot 11, Concession XV, New Survey; thence northerly along the westerly limit of lots 11, 12, 13 and 14, Concession XV, New Survey, to the northwesterly corner of that Lot 14; thence easterly along the northerly limit of Lot 14, concessions XV and XVI, New Survey and along the easterly production of that Lot 14, Concession XVI, across the allowance for road along the shore of Jack Lake to the water's edge along the northerly shore of that lake; thence easterly along that water's edge to the intersection with the water's edge along the easterly shore of Redmond Creek; thence easterly and northeasterly along that water's edge to the intersection with the northerly limit of Lot 31, Concession VIII, as shown on the plan of the Township of Methuen; thence easterly along the northerly limit of that Lot 31 to the northeasterly corner thereof; thence southerly along the easterly limit of that Lot 31 to the southeasterly corner thereof; thence southerly in a straight line across the allowance for road between lots 30 and 31 to the northeasterly corner of Lot 30, Concession VIII; thence southerly along the easterly limit of lots 30, 29, 28, 27 and 26, Concession VIII, to the southeasterly corner of that Lot 26; thence southerly in a straight line across the allowance for road between lots 25 and 26 to the northeasterly corner of Lot 25, Concession VIII; thence southerly along the easterly limit of lots 25, 24 and 23, Concession VIII to the southeasterly corner of that Lot 23; thence westerly along the southerly limit of Lot 23, Concession VIII to the southwesterly corner of the easterly half of that Lot 23; thence southerly along the easterly limit of the westerly half of Lot 22, Concession VIII, to the southeasterly corner thereof; thence westerly along the southerly limit of the westerly half of that Lot 22 to the southwesterly corner thereof; thence westerly in a straight line across the allowance for road between concessions VIII and IX to the southeasterly corner of Lot 22, Concession IX; thence westerly along the southerly limit of that Lot 22 to the southwesterly corner thereof; thence westerly in a straight line across the allowance for road between concessions IX and X to the southeasterly corner of Lot 22, Concession X; thence westerly along the southerly limit of that Lot 22 to the southwesterly corner thereof; thence westerly in a straight line across the allowance for road between concessions X and XI to the southeasterly corner of Lot 22, Concession XI; thence westerly along the southerly limit of that Lot 22 to the southwesterly corner thereof; thence westerly in a straight line across the allowance for road between concessions XI and XII to the southeasterly corner

of Lot 22, Concession XII; thence westerly along the southerly limit of that Lot 22 to the southwesterly corner thereof; thence westerly in a straight line across the allowance for road adjoining Lot 22, Concession XII, as shown on the plan of the Township of Methuen and across the allowance for road adjoining Lot 3, Concession XVI, New Survey, as shown on the plan of the Township of Burleigh, to the southeasterly corner of that Lot 3; thence westerly along the southerly limit of Lot 3, concessions XVI and XV, New Survey, as shown on the plan of the Township of Burleigh, to the place of beginning.

WMU 61

All that land in the counties of Frontenac, Hastings and Lennox and Addington and Renfrew in the Province of Ontario described as follows:

Beginning at the intersection of the centre line of that part of the King's Highway known as No. 62 with the centre line of that part of the King's Highway known as Secondary Highway No. 500 at the Village of Bancroft; thence in a northeasterly and southeasterly direction along that centre line to the intersection with the centre line of that part of the King's Highway known as No. 41 at the Compact Rural Community of Denbigh; thence in a southeasterly direction along that centre line to the intersection with the centre line of that part of the King's Highway known as No. 7 at the Town of Kaladar; thence in a southwesterly direction along that centre line to the intersection with the centre line of that part of the King's Highway known as No. 62; thence in a northwesterly direction along that centre line to the place of beginning.

WMU 62

All that land in the counties of Frontenac, Hastings and Lennox and Addington in the Province of Ontario described as follows:

Beginning at the intersection of the centre line of that part of the King's Highway known as No. 41 with the centre line of that part of the King's Highway known as Secondary Highway No. 506; thence in a northeasterly direction along that centre line to the intersection with the centre line of that part of the Mississippi River System known as Swamp Creek; thence in a general easterly direction along that centre line and the centre line of the Mississippi River System to the intersection with the centre line of that part of the King's Highway known as Secondary Highway No. 509; thence in a southerly direction along that centre line to the intersection with the centre line of that part of the King's Highway known as No. 7; thence in a northeasterly direction along that centre line to the intersection with the centre line of that part of the King's Highway known as No. 38; thence in a southerly direction along that centre line to the intersection with the centre line of County Roads No. 7 and 14 running in a westerly and southwesterly direction from the intersection with the centre line of that part of the King's Highway known as No. 38, through the Compact Rural Communities of Bellrock and Enterprise, and the Dispersed Rural Communities of Lens and Croydon to the intersection with the centre line of that part of the King's Highway known as No. 41; thence along the centre line of that road to the intersection with the centre line of that part of the King's Highway known as No. 41; thence in a northwesterly direction along that centre line to the intersection with the centre line of County Roads No. 3, 32 and 13 running in a northwesterly and westerly direction from that intersection through the Compact Rural Community of Marlbank and the Dispersed Rural Communities of Larkins and Stoco to the intersection with the centre line of that part of the King's Highway known as No. 37; thence in a northwesterly direction along the centre line of that road to the intersection with the centre line of that part of the King's Highway known as No. 37; thence in a northerly direction along that centre line to the intersection with the centre line of that part of the King's Highway known as No. 7; thence in a northeasterly direction along that centre line to the intersection with the centre line of that part of the King's Highway known as No. 41; thence in a northerly direction along that centre line to the place of beginning.

WMU 63

All that land in the counties of Frontenac, Lanark, Lennox and

Addington and Renfrew and The Regional Municipality of Ottawa-Carleton in the Province of Ontario described as follows:

Beginning at the intersection of the centre line of the Madawaska River with the centre line of that part of the King's Highway known as No. 41; thence in a southerly and southeasterly direction along that centre line to the intersection with the centre line of that part of the King's Highway known as Secondary Highway No. 506; thence in a northeasterly direction along that centre line to the intersection with the centre line of that part of the Mississippi River System known as Swamp Creek; thence in a general easterly direction along that centre line and the centre line of the Mississippi River System to the intersection with the centre line of that part of the King's Highway known as Secondary Highway No. 509; thence in a southerly direction along that centre line to the intersection with the centre line of that part of the King's Highway known as No. 7; thence in a northeasterly direction along that centre line to the intersection with the centre line of the King's Highway known as No. 511 running in a northwesterly direction from the Town of Perth through the Village of Lanark to the Compact Rural Community of Hopetown; thence in a northwesterly direction along that centre line to the intersection with the centre line of County Road No. 16 running in a northeasterly direction from the Compact Rural Community of Hopetown to the Town of Almonte; thence in a northeasterly direction along that centre line to the intersection with the centre line of that part of the King's Highway known as No. 15; thence in a northwesterly direction along that centre line to the intersection with the centre line of that part of the King's Highway known as No. 17; thence in a northwesterly direction along that centre line to the intersection with the centre line of the Madawaska River; thence in a westerly direction along that centre line to the place of beginning.

WMU 64

All that land in the counties of Lanark and Renfrew and The Regional Municipality of Ottawa-Carleton in the Province of Ontario described as follows:

1. That part of The Regional Municipality of Ottawa-Carleton lying west of the centre line of the Rideau River and east of the centre line of that part of the King's Highway known as No. 15.
2. That part of the County of Renfrew lying east of the centre line of the Madawaska River and north of the centre line of that part of the King's Highway known as No. 17.
3. That part of the County of Lanark described as follows:

Beginning at the intersection of that part of the King's Highway known as No. 15, with the easterly boundary of the Township of Pakenham; thence in a southerly direction along the easterly boundary of the townships of Pakenham, Ramsay and Beckwith to the southeasterly corner of the Township of Beckwith; thence westerly along the southerly boundary of the Township of Beckwith to the southeasterly corner of the Township of Beckwith; thence westerly along the southerly boundary of the Township of Beckwith to the north-easterly corner of the Township of Montague; thence southerly along the easterly boundary of the Township of Montague to the intersection with the centre line of the Rideau River; thence in a westerly direction along that centre line to the intersection with that part of the King's Highway known as No. 15; thence in a northerly direction along that centre line to the intersection with that part of the King's Highway known as No. 43; thence in a westerly direction along that centre line to the intersection with that part of the King's Highway known as No. 7; thence in a westerly direction along that centre line to the intersection with County Road No. 1; thence in a northwesterly direction along that centre line through the Village of Lanark to the Compact Rural Community of Hopetown; thence in a northwesterly direction along that centre line to the intersection with the centre line of County Road No. 16 running in a northeasterly direction from the Compact Rural Community of Hopetown to the Town of Almonte; thence in a northeasterly direction along that centre line to the intersection with the centre line of that part of the King's Highway known as No. 15; thence in a northwesterly direction along that centre line to the place of beginning.

WMU 65

All that land in the united counties of Stormont, Dundas and Glengarry, Prescott and Russell and The Regional Municipality of Ottawa-Carleton in the Province of Ontario described as follows:

1. The united counties of Stormont, Dundas and Glengarry, and of Prescott and Russell.
2. That part of The Regional Municipality of Ottawa-Carleton lying east of the centre line of the Rideau River.

WMU 66

All that land in the united counties of Leeds and Grenville in the Province of Ontario described in WMUs 66A and 66B.

WMU 66A

All that land in the united counties of Leeds and Grenville in the Province of Ontario described as follows:

That part of the united counties of Leeds and Grenville lying north of the centre line of that part of the King's Highway known as No. 401 and east of the centre line of that part of the King's Highway known as No. 29 and excluding the G. Howard Ferguson Nursery in the Township of Oxford.

WMU 66B

The G. Howard Ferguson Nursery in the Township of Oxford in the united counties of Leeds and Grenville in the Province of Ontario.

WMU 67

All that land in the counties of Frontenac and Lanark and the united counties of Leeds and Grenville in the Province of Ontario described as follows:

Beginning at the intersection of the centre line of that part of the King's Highway known as No. 38 with the centre line of that part of the King's Highway known as No. 7; thence in an easterly direction along that centre line to the intersection with the centre line of that part of the King's Highway known as No. 43; thence in an easterly direction along that centre line to the intersection with the centre line of that part of the King's Highway known as No. 29; thence in a southerly direction along that centre line to the intersection with the centre line of that part of the King's Highway known as No. 401; thence in a westerly direction along that centre line to the intersection with the centre line of that part of the King's Highway known as No. 38; thence in a northerly direction along that centre line to the place of beginning.

WMU 68

All that land in the counties of Frontenac, Hastings, Lennox and Addington and Northumberland in the Province of Ontario described as follows:

Beginning at the intersection of the westerly boundary of the Township of Marmora in the County of Hastings with the centre line of that part of the King's Highway known as No. 7; thence in an easterly direction along that centre line to the intersection with the centre line of that part of the King's Highway known as No. 37; thence in a southerly direction along that centre line to the intersection with the centre line of Hastings County Road No. 13; thence in an easterly direction along that centre line to the intersection with the centre line of Hastings County Road No. 32; thence in a southeasterly direction along that centre line to the intersection with Lennox and Addington County Road No. 3; thence in an easterly direction along that centre line to the intersection with that part of the King's Highway known as No. 41; thence in a southerly direction along that centre line to the intersection with the centre line of Lennox and Addington County Road No. 14; thence in an easterly direction along that centre line to the intersection with the centre line of

Frontenac Country Road No. 7; thence in an easterly direction along that centre line to the intersection with the centre line of that part of the King's Highway known as No. 38; thence in a southerly direction along that centre line to the intersection with the centre line of that part of the King's Highway known as No. 401; thence in a westerly direction along that centre line to the intersection with the centre line of the Trent River; thence in a northerly direction along that centre line to the intersection with the centre line of the Crowe River; thence in a northerly direction along that centre line to the intersection with the westerly boundary of the Township of Rawdon; thence in a northwesterly direction along the westerly boundaries of the townships of Rawdon and Marmora to the place of beginning.

WMU 69

All that land in the counties of Frontenac, Hastings, Lennox and Addington and the united counties of Leeds and Grenville in the Province of Ontario described in WMUs 69A and 69B.

WMU 69A

All that land in the counties of Hastings, Frontenac and Lennox and Addington in the Province of Ontario more particularly described in WMU's 69A-1, 69A-2 and 69A-3.

WMU 69A-1

All that land in the counties of Hastings and Lennox and Addington more particularly described as follows:

Beginning at the southeasterly corner of the municipal Township of Murray in the County of Northumberland; thence northeasterly and southwesterly along the northerly boundary of the County of Prince Edward to the intersection with the westerly boundary of the municipal Township of North Fredericksburgh in the County of Lennox and Addington; thence southerly along the westerly boundary of the municipal Township of North Fredericksburgh to the southerly boundary; thence easterly along the southerly boundary to the easterly boundary of the township; thence northerly along the easterly boundary to the centre-line of the Macdonald Cartier Freeway also known as Highway 401; thence westerly along the centre-line to the intersection with the easterly boundary of the municipal Township of Murray; thence southerly along the easterly boundary to the place of beginning.

WMU 69A-2

All that land in the County of Lennox and Addington more particularly described as follows:

Beginning at the intersection of the westerly boundary of the municipal Township of Ernestown with the centre-line of the Macdonald Cartier Freeway also known as Highway 401; thence easterly along the centre-line to the easterly boundary of the municipal Township of Ernestown; thence southerly along the easterly boundary of the township to the intersection with the centre-line of County Road No. 23, known as the Taylor-Kidd Boulevard; thence westerly along the said centre-line to the intersection with the centre-line of County Road No. 6; thence southerly along the centre-line of County Road No. 6 and its production southerly to the southerly boundary of the municipal Township of Ernestown; thence southwesterly along the southerly boundary of the municipal townships of Ernestown and South Fredericksburgh to the southwest corner of the municipal Township of South Fredericksburgh; thence continuing southwesterly, northerly and northeasterly along the southerly, westerly and northwesterly boundary of the municipal Township of Adolphustown to the most northerly corner; thence southerly along the boundary between the municipal townships of Adolphustown and North Fredericksburgh to the southwest corner of the municipal Township of North Fredericksburgh; thence easterly along the boundary between the municipal townships of North and South Fredericksburgh to the intersection with the westerly boundary of the municipal Township of Ernestown; thence northerly along the westerly boundary of the municipal Township of Ernestown to the place of beginning.

WMU 69A-3

All that land in the County of Frontenac and the County of Lennox and Addington, in the Province of Ontario, more particularly described as follows:

Beginning at a point in the southerly boundary of the municipal Township of South Fredericksburgh at the intersection with a line drawn north astronomically from the most easterly point of the geographic Township of Marysburgh; thence south 45° east to the intersection with the International Boundary between Canada and the United States of America; thence northeasterly along the international boundary to the intersection with the easterly boundary of the County of Frontenac; thence northerly along the easterly boundary of the County of Frontenac to the intersection with the centre-line of the Macdonald Cartier Freeway; thence easterly along the centre-line to the easterly boundary of the municipal Township of Ernestown; thence southerly along the easterly boundary of the township to the intersection with the centre-line of County Road No. 23, known as the Taylor-Kidd Boulevard; thence westerly along the centre-line to the intersection with the centre-line of County Road No. 6; thence southerly along the centre-line of County Road No. 6 and its production southerly to the southerly boundary of the municipal Township of Ernestown; thence southwesterly along the southerly boundary of the municipal townships of Ernestown and South Fredericksburgh to the place of beginning.

WMU 69B

All that land in the united counties of Leeds and Grenville in the Province of Ontario described as follows:

Those parts of the united counties of Leeds and Grenville lying south of the centre line of that part of the King's Highway known as No. 401.

WMU 70

All that land in the County of Prince Edward in the Province of Ontario described as follows:

Beginning at the intersection of the southerly production of the westerly boundary of the Township of Cramahe with the International Boundary between Canada and the United States of America; thence northeasterly in a straight line to the most northerly point of Becroft Point; thence northeasterly in a straight line to the southeasterly corner of the Township of Murray; thence northeasterly, southerly and northeasterly along the northerly boundary of the county of Prince Edward to the intersection with a line drawn north astronomically from the most easterly point of the geographic Township of Marysburgh; thence south 45° east to the intersection with the International Boundary between Canada and the United States of America; thence southwesterly and westerly along that International Boundary to the place of beginning.

WMU 71

All that land in the counties of Northumberland and Hastings in the Province of Ontario described as follows:

1. That part of the County of Hastings lying west and south of the centre line of the Trent River.
2. That part of the County of Northumberland described as follows:

Beginning at the intersection of the water's edge of Lake Ontario with the westerly boundary of the Township of Cramahe; thence in a northwesterly direction along the said westerly boundary to the intersection with the centre line of that part of the King's Highway known as No 2; thence in an easterly direction along that centre line to the intersection with the centre line of County Road No. 25; thence in a northwesterly and northeasterly direction along that centre line to the intersection with the centre line of that part of the King's Highway known as No. 45; thence in a northerly direction along that centre line to the intersection with the centre line of the Trent River;

thence in a northeasterly, easterly and southerly direction along that centre line to the intersection with the easterly boundary of the Township of Murray; thence in a southerly direction along the easterly boundary of the Township of Murray to the southeasterly corner of the Township of Murray; thence southwesterly in a straight line to the most northerly point of Becroft Point; thence southwesterly in a straight line to the intersection of the southerly production of the westerly boundary of the Township of Cramahe with the International Boundary between Canada and the United States; thence in a northerly direction along that production to the place of beginning.

WMU 72

All that land in the County of Northumberland and the Regional Municipality of Durham in the Province of Ontario described in WMU's 72A and 72B.

WMU 72A

All that land in the County of Northumberland and the Regional Municipality of Durham in the Province of Ontario described as follows:

Beginning at the intersection of the centre line of Durham Regional Road 4 and the centre line of the King's Highway Number 35 and 115:

Thence northerly along the said centre line of the King's Highway to the intersection with the centre line of Durham Regional Road 9;

Thence easterly along the said centre line of Road 4, to and along the centre line of Northumberland County Road 9, to the intersection with the westerly boundary of the Township of Hamilton;

Thence northerly along the said boundary to the northwesterly corner of the said township;

Thence northeasterly along the northwesterly boundaries of the townships of Hamilton, Alnwick, and Percy to the intersection with the centre line of the King's Highway Number 45;

Thence southerly along the said centre line to the intersection with the centre line of Northumberland County Road 25;

Thence southerly and westerly along the said centre line of Road 25 to the intersection with the centre line of the King's Highway Number 2;

Thence westerly along the said centre line of Highway 2 to the intersection with the westerly boundary of the Township of Cramahe;

Thence southerly along the said westerly boundary to the intersection with the International Boundary between Canada and the United States;

Thence westerly along the said International Boundary to the intersection with the southeasterly prolongation of Durham Regional Road 17;

Thence northwesterly along the said prolongation, to and along the centre line of the said Road 17, to and along the centre line of the aforesaid Highway 35 and 115, to the place of beginning.

WMU 72B

All that land in the County of Northumberland and the Regional Municipality of Durham in the Province of Ontario described as follows:

Beginning at the intersection of the westerly boundary of the Town of Newcastle with the centre line of Durham Regional Road No. 4;

Thence easterly along the said centre line to the intersection with the centre line of the King's Highway Number 35 and 115;

Thence southerly along the said centre line of Highway 35 and 115; to and along the centre line of Durham Regional Road 17 to the intersection with the King's Highway Number 401;

Thence southerly along the southeasterly prolongation of the centre line of said Road 17 to the intersection with the International Boundary between Canada and the United States;

Thence westerly along the said International Boundary to the intersection with the westerly boundary of the Town of Newcastle;

Thence northerly along the said westerly boundary of the Town of Newcastle to the place of beginning.

WMU 73

All that land in the counties of Northumberland, Peterborough and Victoria and The Regional Municipality of Durham in the Province of Ontario described as follows:

1. The municipal townships of Manvers and Mariposa in the County of Victoria.

2. Those parts of the municipal townships of Emily and Ops in the County of Victoria lying south of the centre line of the King's Highway No. 7.

3. The municipal Township of Scugog in The Regional Municipality of Durham.

4. That part of the Town of Newcastle in The Regional Municipality of Durham described as follows:

Beginning at the intersection of the easterly boundary of the Town of Newcastle with the centre line of Durham Regional Road No. 9; thence westerly along that centre line to its intersection with the centre line of the King's Highway No. 35 and No. 115; thence southerly along that centre line to its intersection with the centre line of Durham Regional Road No 4; thence westerly along that centre line to its intersection with the westerly boundary of the Town of Newcastle; thence northerly along that westerly boundary to the northwest corner of the Town of Newcastle; thence easterly along the northerly boundary of the Town of Newcastle to the northeast corner thereof; thence southerly along the easterly boundary of the Town of Newcastle to the place of beginning.

5. The municipal townships of Cavan and South Monaghan in the County of Peterborough.

6. Those parts of the municipal townships of North Monaghan and Otonabee in The County of Peterborough lying south of the King's Highway No. 7.

7. Those parts of the municipal Township of Asphodel in the County of Peterborough and the municipal Township of Seymour in the County of Northumberland described as follows:

Beginning at the intersection of the westerly boundary of the Township of Asphodel with the centre line of the King's Highway No. 7; thence easterly along that centre line to its intersection with the centre line of the King's Highway No. 45; thence southerly along that centre line to its intersection with the centre line of Peterborough County Road No. 36; thence easterly along that centre line to its intersection with the King's Highway No. 30; thence southerly along that centre line to its intersection with the centre line of the Trent River; thence southerly along that centre line to the southwest corner of the municipal Township of Asphodel; thence northerly along the westerly boundary of the municipal Township of Asphodel to the place of beginning.

8. That part of the municipal Township of Hope in the County of Northumberland lying north of the centre line of Northumberland County Road No. 9.

WMU 73A, WMU 73B REVOKED: O. Reg. 563/89, s. 1.

WMU 74

All that land in the counties of Northumberland and Peterborough in the Province of Ontario described as follows:

1. The townships of Douro, Dummer, Ennismore and Smith in the County of Peterborough.

2. Those parts of the townships of North Monaghan and Otonabee in the County of Peterborough lying northerly of the centre line of that part of the King's Highway known as No. 7.

3. That part of the Township of Asphodel in the County of Northumberland described as follows:

Beginning at the intersection of the centre line of that part of the King's Highway known as No. 7 with the westerly boundary of the Township of Asphodel; thence in a northerly direction along that westerly boundary to the northwest corner of the Township of Asphodel; thence in an easterly direction along the northerly boundary of the Township of Asphodel to the northeast corner thereof; thence in a southerly direction along the easterly boundary of the Township of Asphodel to the intersection with the centre line of Peterborough County Road No. 36; thence in a westerly direction along that centre line to the intersection with the centre line of that part of the King's Highway known as No. 45; thence in a northerly direction along that centre line to the intersection in a northerly direction along that centre line to the intersection with the centre line of that part of the King's Highway known as No. 7; thence in a southwesterly and westerly direction along that centre line to the place of beginning.

4. That part of the Township of Seymour in the County of Northumberland lying north of the centre lines of the Crowe and Trent Rivers.

5. That part of the Township of Methuen and Belmont in the County of Peterborough described as follows:

Beginning at the intersection of the centre line of Peterborough County Road No. 44 with the westerly boundary of the Township of Methuen and Belmont which was formerly the Township of Methuen; thence in a southerly direction along the westerly boundary of that part to the southwest corner of the Township of Methuen and Belmont which was formerly the Township of Methuen; thence in an easterly direction along the southerly boundary of that part to the southeast corner of the Township of Methuen and Belmont which was formerly the Township of Methuen; thence in a northerly direction along the easterly boundary of that part which was formerly the Township of Methuen to the intersection with that part of the King's Highway known as No. 7; thence in a westerly direction along the centre line to the intersection with the centre line of Peterborough County Road No. 44; thence in a northerly and westerly direction along that centre line to the place of beginning.

WMU 75

All that land in the County of Victoria in the Province of Ontario described as follows:

1. The townships of Carden, Eldon, Fenelon and Verulam.

2. That part of the Township of Somerville lying westerly of the centre line of that part of the King's Highway known as No. 35.

3. The Township of Bexley saving and excepting thereout and therefrom that part of the said township lying east of the centre line of that part of the King's Highway known as No. 35.

4. That part of the Township of Laxton, Digby and Longford lying south and west of the centre line of that part of Secondary Highway known as No. 503 and lying west of the centre line of that part of the King's Highway known as No. 35.

5. That part of the Township of Dalton lying south of the centre line of that part of Secondary Highway known as No. 503.

6. Those parts of the townships of Emily and Ops lying north and east of the centre line of that part of the King's Highway known as No. 7.

WMU 76

All that land in the County of Simcoe in the Province of Ontario described in WMUs 76A, 76B, 76C and 76D.

WMU 76A

All that land in the County of Simcoe described as follows:

Beginning at the northeasterly corner of the Township of Rama; thence in a southerly direction along the easterly boundary of the townships of Rama and Mara to the southeasterly corner of the Township of Mara; thence in a westerly direction along the southerly boundary of the Township of Mara to the intersection with the water's edge along the easterly shore of Lake Simcoe; thence in a northerly direction following the water's edge along the easterly shore of Lake Simcoe, The Narrows and Lake Couchiching to the intersection with the centre line of the Trent Canal; thence in a northerly direction along that centre line to the intersection with the line between lots 13 and 14, Concession XV, in the Township of Orillia; thence in a westerly direction along the line between lots 13 and 14 to the intersection with the centre line of the allowance for road between concessions XIV and XV in the Township of Orillia; thence in a westerly direction along the centre line of a travelled road constructed within lots 13 and 14, Concession XIV, to the intersection with the centre line of the allowance for road between concessions XIII and XIV, in the Township of Orillia; thence in a southerly direction along that centre line to the intersection with the centre line of a travelled road constructed within Lot 11, Concession XIII, in the Township of Orillia; thence in a westerly direction along that centre line to the intersection with the centre line of the allowance for road between concessions XII and XIII, in the Township of Orillia; thence in a westerly direction along the centre line of the allowance for road between lots 10 and 11, across concessions XII, XI, X and IX and the intervening allowances for road to the intersection with the centre line of the allowance for road between concessions VIII and IX, in the Township of Orillia; thence in a northerly direction along that centre line to the intersection with the centre line of the allowance for road between lots 15 and 16, Concession VIII, in the Township of Orillia; thence in a westerly direction along the centre line of the allowance for road between lots 15 and 16, across concessions VIII, VII and VI and the intervening allowances for road to the intersection with the centre line of the allowance for road between concessions V and VI, in the Township of Orillia; thence in a northerly direction along that centre line to the intersection with the north boundary of the Township of Orillia; thence in a northerly direction along the centre line of the travelled road leading to Swift Rapids on the Severn River to the intersection with the water's edge along the southerly shore of Matchedash River at the most northerly bridge across that river; thence in a westerly direction following the water's edge along the southerly shore of Matchedash River, MacLean Lake and Black River to the intersection with the westerly boundary of the Township of Matchedash; thence in a northerly direction along that boundary to the northwesterly corner of the Township of Matchedash in accordance with the Township limits in the Severn River established by subsection 8 (1) of the *Territorial Division Act*; thence in a northerly, northeasterly, easterly and southeasterly direction along the northerly boundary of the townships of Matchedash and Orillia as established by that Act to the northwesterly corner of the Township of Rama; thence in an easterly direction along the northerly boundary of the Township of Rama to the place of beginning.

WMU 76B

All that land in the County of Simcoe described as follows:

Beginning at the intersection of the centre line of the King's Highway known as number 93 with the centre line of the Simcoe County Road known as number 23; thence in a southerly direction along the

centre line of the King's Highway known as number 93 to the intersection with the centre line of the King's Highway known as number 11; thence in a southwesterly direction along that centre line to the intersection with the northerly boundary of the City of Barrie; thence in an easterly direction along that boundary to the intersection with the westerly boundary of the Township of Oro; thence in a southerly direction along that boundary to the intersection with the water's edge along the shore of Kempenfelt Bay, Lake Simcoe; thence in a westerly and southerly direction along that water's edge to the intersection with the production easterly of the centre line of Tiffin Street in the City of Barrie; thence easterly in a straight line to the southwesterly corner of the Township of Oro in accordance with the Township Limits in Lake Simcoe established by subsection 8 (1) of the *Territorial Division Act*; thence in an easterly direction along the southerly boundary of the townships of Oro, Orillia and Mara and the City of Orillia within Lake Simcoe as established by that Act to the intersection with the water's edge along the easterly shore of Lake Simcoe; thence in a northerly direction following the water's edge along the easterly shore of Lake Simcoe, The Narrows and Lake Couchiching to the intersection with the centre line of the Trent Canal; thence in a northerly direction along that centre line to the intersection with the line between lots 13 and 14, Concession XV, in the Township of Orillia; thence in a westerly direction along the line between lots 13 and 14 to the intersection with the centre line of the allowance for road between concessions XIV and XV in the Township of Orillia; thence in a westerly direction along the centre line of a travelled road constructed within lots 13 and 14, Concession XIV, to the intersection with the centre line of the allowance for road between concessions XIII and XIV, in the Township of Orillia; thence in a southerly direction along that centre line to the intersection with the centre line of a travelled road constructed within Lot 11, Concession XIII, in the Township of Orillia; thence in a westerly direction along that centre line to the intersection with the centre line of the allowance for road between concessions XII and XIII, in the Township of Orillia; thence in a westerly direction along the centre line of the allowance for road between lots 10 and 11, across concessions XII, XI, X and IX and the intervening allowances for road to the intersection with the centre line of the allowance for road between concessions VIII and IX, in the Township of Orillia; thence in a northerly direction along that centre line to the intersection with the centre line of the allowance for road between lots 15 and 16, Concession VIII, in the Township of Orillia; thence in a westerly direction along the centre line of the allowance for road between lots 15 and 16, across concessions VIII, VII and VI and the intervening allowances for road to the intersection with the centre line of the allowance for road between concessions V and VI, in the Township of Orillia; thence in a northerly direction along that centre line to the intersection with the north boundary of the Township of Orillia; thence in a northerly direction along the centre line of the travelled road leading to Swift Rapids on the Severn River to the intersection with the water's edge along the southerly shore of Matchedash River at the most northerly bridge across that river; thence in a westerly direction following the water's edge along the southerly shore of Matchedash River, MacLean Lake and Black River to the intersection with the westerly boundary of the Township of Matchedash; thence in a northerly direction along that boundary to the northwesterly corner of the Township of Matchedash in accordance with the Township Limits in the Severn River established by subsection 8 (1) of the *Territorial Division Act*; thence in a westerly direction along the northerly boundary of the Township of Tay as established by that Act to the intersection with the centre line of the King's Highway known as number 69; thence in a southerly direction along that centre line to the intersection with the centre line of Simcoe County Road known as number 23; thence in a westerly direction along that centre line to the place of beginning.

Saving and excepting therefrom that part of the Township of Medonte known as the Copeland Forest Resource Management Area.

WMU 76C

All that land in the County of Simcoe described as follows:

Beginning at the intersection of the centre line of the King's High-

way known as number 69 with the northerly boundary of the Township of Tay; thence in a southerly direction along that centre line to the intersection with the centre line of Simcoe County Road known as number 23; thence in a westerly direction along that centre line to the intersection with the centre line of the King's Highway known as number 93; thence in a southerly direction along that centre line to the intersection with the centre line of Simcoe County Road known as number 22; thence in a westerly direction along that centre line to the intersection with the centre line of the King's Highway known as number 26; thence in a westerly and northerly direction along that centre line to the intersection with the centre line of Simcoe County Road known as number 7; thence in a northerly direction along the centre line of the travelled road within the allowance for road between concessions II and III, in the Township of Nottawasaga, now in the Town of Wasaga Beach, and its production northerly to the water's edge along the shore of Nottawasaga Bay; thence north-westerly in a straight line to the northwesterly corner of the Township of Nottawasaga in Nottawasaga Bay established by subsection 8 (1) of the *Territorial Division Act*; thence in a northeasterly, easterly and southeasterly direction along the northerly boundary of the townships of Nottawasaga, Tiny and Tay as established by that Act to the place of beginning.

WMU 76D

All that land in the County of Simcoe described as follows:

Beginning at the intersection of the centre line of the King's Highway known as number 93 with the intersection of the centre line of Simcoe County Road known as number 22; thence in a westerly direction along the centre line of that county road to the intersection with the centre line of the King's Highway known as number 26; thence in a westerly direction along that centre line to the intersection with the centre line of Simcoe County Road known as number 42; thence in a southerly direction along that centre line to the intersection with the southerly boundary of the Township of Nottawasaga; thence in an easterly direction along the southerly boundary of the Township of Nottawasaga to the southeasterly corner thereof; thence in a northerly direction along the easterly boundary of the Township of Nottawasaga to the southwesterly corner of the Township of Sunnidale; thence in an easterly direction along the southerly boundary of the townships of Sunnidale and Vespra to the intersection with the centre line of the King's Highway known as number 90; thence continuing in an easterly direction along that centre line to the intersection with the westerly limit of the right-of-way of the King's Highway known as number 400; thence easterly in a straight line to the westerly extremity of the centre line of Tiffin Street in the City of Barrie; thence in an easterly direction along that centre line and continuing along its production easterly to the water's edge along the westerly shore of Kempenfelt Bay; thence in a northerly and easterly direction along that water's edge to the intersection with the westerly boundary of the Township of Oro; thence in a northerly direction along that boundary to the intersection with the northerly boundary of the City of Barrie; thence in a westerly direction along that boundary to the intersection with the centre line of the King's Highway known as number 11; thence in a northerly direction along that centre line to the intersection with the centre line of the King's Highway known as number 93; thence northerly along that centre line to the place of beginning.

WMU 77

All that land in the counties of Dufferin and Simcoe in the Province of Ontario described in WMUs 77A, 77B and 77C.

WMU 77A

All that land in the townships of Essa and Tosorontio in the County of Simcoe composed of Canadian Forces Base Borden.

WMU 77B

All that land in the counties of Dufferin and Simcoe described as follows:

1. The Township of Adjala in the County of Simcoe.

2. The Township of Tosorontio in the County of Simcoe except that part known as Canadian National Forces Base Borden.

3. That part of the Township of Tecumseth in the County of Simcoe lying west of the centre line of the right-of-way of the Canadian National Railway Company.

4. That part of the Township of Essa in the County of Simcoe lying west of the centre line of the right-of-way of the Canadian National Railway Company and saving and excepting that part of the Township of Essa known as Canadian National Forces Base Borden.

5. That part of the Township of Innisfil in the County of Simcoe lying west of the centre line of that part of the King's Highway known as No. 27.

6. Those parts of the townships of Mono and Mulmur in the County of Dufferin lying east of the centre line of Dufferin County Road No. 18.

WMU 77C

All that land in the County of Simcoe described as follows:

Beginning at the intersection of the centre line of that part of the King's Highway known as No. 27 with the centre line of that part of the King's Highway known as No. 90; thence easterly along that centre line to the intersection with the centre line of Essa Road in Barrie; thence easterly along that centre line and the easterly production of that centre line to the intersection with a line drawn south astronomically from the most westerly point of the Township of Mara; thence south astronomically to the intersection with the centre line of Lake Simcoe; thence westerly and southerly along that centre line and the centre line of Cook Bay to the confluence of the centre line of the Schomberg River; thence southerly and westerly along that centre line to the intersection with the centre line of that part of the King's Highway known as No. 9; thence westerly along that centre line to the intersection with the centre line of the right of way of the Canadian National Railway in the Township of Tecumseth; thence northerly along that centre line to the intersection with the centre line of that part of the King's Highway known as No. 27; thence northerly along that centre line to the place of beginning.

WMU 78

All that land in the regional municipalities of Durham, York and Peel and The Municipality of Metropolitan Toronto described in WMUs 78A, 78B, 78C, 78D and 78E.

WMU 78A

All that land in the regional municipalities of Durham and York in the Province of Ontario described as follows:

Beginning at the northeasterly corner of the Township of Brock; thence southerly along the easterly boundary of the Township of Brock to the southeasterly corner of the Township of Brock; thence westerly along the southerly boundary of the Township of Brock to the intersection with the easterly boundary of the former Township of Scott; thence southerly along that boundary to the southerly boundary of the former Township of Scott; thence westerly along that boundary to the intersection with the westerly boundary of the Township of Uxbridge; thence northerly along that boundary to the intersection with the southerly boundary of the Township of Georgina; thence easterly along that boundary to the southeasterly corner of the Township of Georgina; thence northerly along the easterly boundary of the Township of Georgina and its northerly production to the intersection with the centre line of Lake Simcoe; thence easterly along that centre line to the intersection with a line drawn west astronomically from the confluence of the high water mark of Lake Simcoe with the centre line of the Talbot River; thence east astronomically to that confluence; thence northeasterly, southeasterly and easterly along the centre line of the Talbot River to the place of beginning.

WMU 78B

All that land in The Regional Municipality of York described as follows:

1. The Town of East Gwillimbury.
2. Beginning at the southeasterly corner of the Township of Georgina; thence westerly along the southerly boundary of the Township of Georgina to the intersection with the centre line of the Holland River; thence northeasterly along that centre line to the confluence with the high water mark of Cook's Bay; thence northerly and northeasterly along the centre line of Cook's Bay and Lake Simcoe to the intersection with the northerly production of the easterly boundary of the Township of Georgina; thence southerly along that northerly production and along that easterly boundary to the place of beginning.

WMU 78C

All that land in the regional municipalities of Durham and York described as follows:

1. That part of The Regional Municipality of Durham described as follows:
 1. That part of the Township of Uxbridge lying south of the southerly boundary of the former Township of Scott.
 2. That part of the Town of Pickering lying north of the centre line of that part of the King's Highway known as No. 7.
2. That part of The Regional Municipality of York described as follows:
 1. That part of the Town of Whitchurch-Stouffville lying north of the centre line of York Regional Road No. 14.
 2. The Town of Newmarket.
 3. That part of the Town of Richmond Hill lying north of the centre line of York Regional Road No. 14 and its production westerly.
 4. The Township of King.
 5. That part of the Town of Vaughan lying north of the centre line of King-Vaughan Road.
 6. The Town of Aurora.

WMU 78D

All the land in The Regional Municipality of Peel, being the Town of Caledon.

WMU 78E

All that land in the regional municipalities of Durham, York and Peel and The Municipality of Metropolitan Toronto described as follows:

Beginning at the northeasterly corner of the City of Oshawa, in The Regional Municipality of Durham; thence southerly along the easterly boundary of the City of Oshawa and the southerly production of that boundary to the intersection with the International Boundary between Canada and the United States; thence westerly along that International Boundary to the intersection with a line drawn east astronomically from the intersection of the westerly boundary of the City of Mississauga with the water's edge of Lake Ontario; thence west astronomically to the intersection of the westerly boundary of the City of Mississauga with the said water's edge; thence northerly along the said westerly boundary to the intersection with the centre line of Peel Regional Road No. 19; thence northerly along that centre line to the intersection with the centre line of Burnhamthorpe Road; thence westerly along that centre line to the inter-

section with the westerly boundary of The Regional Municipality of Peel; thence northerly, easterly and northerly along that boundary to the intersection with the centre line of Peel Regional Road No. 14; thence easterly along that centre line to the intersection with the easterly boundary of The Regional Municipality of Peel; thence northerly along that boundary to the intersection with the westerly production of the centre line of King-Vaughan Road; thence easterly along that production and along the King-Vaughan Road to the intersection with the westerly boundary of the Town of Richmond Hill; thence northerly along that boundary to the intersection with the westerly production of the centre line of York Regional Road No. 14; thence easterly along that production and along that centre line to the intersection with the easterly boundary of The Regional Municipality of York; thence southerly along that said easterly boundary to the intersection with the centre line of that part of the King's Highway known as No. 7; thence easterly along that centre line to the intersection with the centre line of Durham Regional Road No. 23; thence northerly along that centre line to the intersection with the northerly boundary of the Town of Whitby; thence easterly along that boundary and the northerly boundary of the City of Oshawa to the place of beginning.

Excepting therefrom all that land known as the Nashville Tract Hunting Area as described in Regulation 507 of Revised Regulations of Ontario, 1990.

WMU 79

All that land in The Regional Municipality of Halton and the County of Wellington in the Province of Ontario described in WMUs 79A, 79B, 79C and 79D.

WMU 79A

The Township of Guelph in the County of Wellington.

WMU 79B

The townships of Erin and Eramosa in the County of Wellington.

WMU 79C

1. That part of The Regional Municipality of Halton lying north of the centre line of that part of the King's Highway known as No. 401.

WMU 79D

That part of The Regional Municipality of Halton in the Province of Ontario described as follows:

Beginning at the intersection of the easterly boundary of the Town of Milton with the centre line of that part of the King's Highway known as No. 401; thence westerly along that centre line to the intersection with the westerly boundary of the Town of Milton; thence southerly, westerly along that boundary and the westerly boundary of the City of Burlington to the intersection with the water's edge of Hamilton Harbour; thence in a straight line to the intersection with the centre line of the connecting waters between Hamilton Harbour and Lake Ontario; then northeasterly along that centre line to the water's edge of Lake Ontario; thence east astronomically to the intersection with the northerly production of the westerly boundary of the Town of Grimsby in the Regional Municipality of Niagara; thence northeasterly to a point on the International Boundary between Canada and the United States of America said point being at latitude 43° 27' 01.51" north and longitude 79° 12' 03.18" west; thence northeasterly along that International Boundary to the intersection with a line drawn east astronomically from the intersection of the easterly boundary of the Town of Oakville with the water's edge of Lake Ontario; thence west astronomically to the eastern boundary of the Town of Oakville; thence northwesterly, southwesterly and northwesterly along that boundary and the easterly boundary of the Town of Milton, to the place of beginning.

WMU 80

All that land in the counties of Dufferin and Wellington in the Province of Ontario described in WMUs 80A and 80B.

WMU 80A

All that land in the counties of Dufferin and Wellington in the Province of Ontario described as follows:

1. The townships of Arthur, Maryborough, Nichol, Peel, Pilkington, West Garafraxa and West Luther in the County of Wellington.
2. The Township of East Luther in the County of Dufferin.

Saving and excepting thereout and therefrom all that land described in WMU 80B.

WMU 80B

All that land in the Township of East Luther in the County of Dufferin as shown on the township plan of the Township of Luther and the Township of West Luther in the County of Wellington as shown on the township plan of the Township of Luther, more particularly described as follows:

1. Lots 20, 21, the south half of the north half of Lot 22 and the south half of the west half of the north half of Lot 23 in Concession IV; lots 19, 20, 21 and 23 in Concession V; lots 19, 20 and 21 in Concession VI; lots 19, 20 and 21 in Concession VII; lots 19, 20 and 21 in Concession VIII; lots 19, 20 and 21 in Concession IX; and lots 19, 20 and 21 in Concession X, all in the said Township of East Luther.

2. Lot 13, the north half of Lot 16 and all of lots 17 and 18 in Concession V; the east half of Lot 13 and all of lots 14, 15, 16, 17 and 18 in Concession VI; the south half of Lot 13 and all of lots 14, 15, 16, 17 and 18 in Concession VII; the north half of Lot 13, the north half of Lot 14, the east half of the south half of Lot 14, the east half of the west half of the south half of Lot 14 and all of lots 15, 16, 17 and 18 in Concession VIII; lots 13, 14, 15, 16, 17 and 18 in Concession IX; and lots 13, 14, 15, 16, 17 and 18 in Concession X, all in the said Township of West Luther.

WMU 81

All that land in the counties of Dufferin and Simcoe in the Province of Ontario described in WMUs 81A and 81B.

WMU 81A

All that land in the County of Dufferin in the Province of Ontario described as follows:

1. The townships of Amaranth and East Garafraxa.
2. That part of the Township of Mono lying west of the centre line of that part of the King's Highway known as No. 10 and No. 24.
3. That part of the Township of Melancthon lying west of the centre line of that part of the King's Highway known as No. 24.

WMU 81B

All that land in the counties of Dufferin and Simcoe in the Province of Ontario described as follows:

1. That part of the Township of Nottawasaga in the County of Simcoe described as follows:

Beginning at the intersection of Simcoe County Road No. 42 with the southerly boundary of the Township of Nottawasaga; thence westerly along the southerly boundary to the southwesterly corner of the Township of Nottawasaga; thence in a northerly direction along the westerly boundary of the Township of Nottawasaga to the water's edge of Nottawasaga Bay of Georgian Bay; thence northwesterly to the intersection of latitude 45° 00' north with longitude

80° 30' west; thence southeasterly to the intersection of the northerly production of the centre line of that part of the King's Highway known as No. 26 with the water's edge of Nottawasaga Bay of Georgian Bay; thence southerly along that production and that centre line to the intersection with the centre line of Simcoe County Road No. 42; thence southerly along that centre line to the place of beginning.

2. That part of the Township of Mulmur in the County of Dufferin lying west of the centre line of Dufferin County Road No. 18.

3. That part of the Township of Melancthon in the County of Dufferin lying east of the centre line of that part of the King's Highway known as No. 24.

4. That part of the Township of Mono in the County of Dufferin lying west of the centre line of Dufferin County Road No. 18 and east of the centre line of that part of the King's Highway known as No. 10 and No. 24.

WMU 82

All that land in the counties of Bruce and Grey in the Province of Ontario described in WMUs 82A and 82B.

WMU 82A

All that land in the counties of Bruce and Grey in the Province of Ontario described as follows:

Beginning at the intersection of latitude 45° 00' north with longitude 80° 30' west; thence southeasterly in a straight line to the intersection of the easterly boundary of the Township of Collingwood with the water's edge of Nottawasaga Bay; thence southeasterly along the easterly boundary of the Township of Collingwood and the easterly boundary of the Township of Osprey to the southeast corner of the Township of Osprey; thence southwesterly along the southerly boundary of that township to the southeasterly corner of the Township of Artemesia; thence southwesterly along the southerly boundary of that township to the northwest corner of the Township of Melancthon; thence southerly along the easterly boundary of the Township of Proton to the southeast corner thereof; thence westerly along the southerly boundary of the townships of Proton, Egremont and Normanby to the southwest corner of the Township of Normanby; thence northerly along the westerly boundary of the townships of Normanby, Bentinck and Sullivan, to the intersection with the centre line of Bruce County Road No. 10; thence westerly and northerly along that centre line to the intersection with the centre line of that part of the King's Highway known as No. 21; thence easterly along that centre line to the intersection with the centre line of that part of the King's Highway known as No. 6 and No. 10; thence southerly along that centre line to the intersection of that part of the King's Highway known as No. 10; thence southeasterly along that centre line to the intersection with the centre line of Grey County Road No. 4; thence easterly along that centre line to the intersection with the westerly boundary of the Township of Collingwood; thence northerly along that westerly boundary to the water's edge of Nottawasaga Bay; thence northerly in a straight line to the place of beginning.

WMU 82B

All that land in the County of Grey in the Province of Ontario described as follows:

Beginning at the intersection of the centre line of that part of the King's Highway known as No. 10 with the centre line of County Road No. 4; thence easterly, northerly and easterly along that centre line to the intersection with the westerly boundary of the Township of Collingwood; thence northerly along that boundary to the intersection with the water's edge of Nottawasaga Bay; thence northerly in a straight line to the intersection of latitude 45° 00' north with longitude 80° 30' west; thence northwesterly a distance of 10 kilometres in a straight line joining a point distant 40 miles measured south astronomically from the southeasterly corner of the geographic Township of Humboldt with the intersection of latitude 45° 00' north and longitude 80° 30' west; thence southwesterly in a straight line to the water's edge at the southerly extremity of Owen Sound; thence

continuing southwesterly along the production of that straight line to the intersection with the centre line of that part of the King's Highway known as No. 6 and No. 21; thence easterly along that centre line to the intersection with the centre line of that part of the King's Highway No. 6 and No. 10; thence southerly along that centre line to the intersection with the centre line of that part of the King's Highway known as No. 10; thence southeasterly along that centre line to the place of beginning.

Saving and excepting thereout and therefrom that area known as the Meaford Armed Fighting Vehicle Range.

WMU 83

All that land in the counties of Bruce and Grey described in WMUs 83A, 83B and 83C.

WMU 83A

All that land in the counties of Bruce and Grey described as follows:

Beginning at a point on the line joining the northeasterly corner of the Township of Collingwood in Nottawasaga Bay in accordance with township limits in Georgian Bay established by subsection 8 (1) of the *Territorial Division Act* and a point distant 64.3738 kilometres measured south astronomically from the southeast corner of the geographic Township of Humboldt, in the Territorial District of Sudbury, and which point is distant 10 kilometres measured northwesterly thereon from the northeasterly corner of the Township of Collingwood, thence southwesterly in a straight line to a point in the water's edge at the most southerly extremity of Owen Sound; thence continuing southwesterly along the production of that straight line to the intersection with the centre line of the King's Highway known as number 6 and 21; thence in a westerly direction to the junction of the King's Highway known as number 6 and the King's Highway known as number 21; thence continuing in a westerly direction along the centre line of the King's Highway known as number 21 to the intersection with the easterly boundary of the Town of Southampton; thence west astronomically to the intersection with the International Boundary between Canada and the United States of America; thence in a northwesterly direction along that International Boundary to the intersection with a line drawn on a course of west astronomic from a point distant 64.3738 kilometres measured south astronomically from the southeast corner of the geographic Township of Humboldt, in the Territorial District of Sudbury; thence east astronomically to that point; thence in a southeasterly direction to the place of beginning.

Except Griffith Island in the Township of Keppel, Hay Island in the Township of Albemarle and all those lands known immediately before the 1st day of December, 1987 as Cyprus Lake Provincial Park and Fathom Five Provincial Park.

WMU 83B

All that land in the County of Grey in the Province of Ontario described as follows:

Griffith Island in the Township of Keppel.

WMU 83C

All that land in the County of Grey described as follows:

Hay Island in the Township of Albemarle.

WMU 84

All that land in the County of Bruce in the Province of Ontario described as follows:

Beginning at the intersection of the centre line of that part of the King's Highway known as No. 21 with the centre line of Bruce County Road No. 10; thence southerly along that centre line to the intersection with the centre line of Bruce County Road No. 10B;

thence easterly and southerly along that centre line to the intersection with the centre line of Bruce County Road No. 10; thence southerly along that centre line to the intersection with the southerly boundary of the Township of Carrick; thence westerly along the southerly boundaries of the townships of Carrick and Culross to the intersection with the easterly boundary of the Township of Kinloss; thence southerly along that boundary to the intersection with the centre line of that part of the King's Highway known as No. 86; thence northwesterly along that centre line and the northwesterly production of that centre line to the intersection with the water's edge of Lake Huron; thence west astronomically to the intersection with the International Boundary between Canada and the United States of America; thence in a northerly direction along that International Boundary to the intersection with a line drawn west astronomically from the most westerly point of the centre line of that part of the King's Highway known as No. 21 in the Town of Southampton; thence east astronomically along that line to the intersection with the centre line of that part of the King's Highway known as No. 21; thence northerly and easterly along that centre line to the place of beginning.

WMU 85

All that land in the counties of Huron and Wellington in the Province of Ontario described in WMUs 85A, 85B and 85C.

WMU 85A

All that land in the County of Huron in the Province of Ontario described as follows:

Beginning at the intersection of the northerly boundary of the Township of Ashfield with the water's edge of Lake Huron; thence southeasterly along that boundary and the northerly boundaries of the townships of West Wawanosh and East Wawanosh to the intersection with the centre line of that part of the King's Highway known as No. 4; thence south westerly along that centre line to the intersection with the centre line of that part of the King's Highway known as No. 8; thence northwesterly along that centre line to the intersection with the centre line of that part of the King's Highway known as No. 21; thence west astronomically to the intersection with the International Boundary between Canada and the United States of America; thence in a northerly direction along that boundary to the intersection with a line drawn west astronomically from the place of beginning; thence east astronomically to the place of beginning.

WMU 85B

All that land in the counties of Huron and Wellington in the Province of Ontario described as follows:

1. The townships of Grey, Howick, McKillop, Morris and Turnberry in the County of Huron.

2. That part of the Township of Hullett in the County of Huron lying east of the centre line of that part of the King's Highway known as No. 4.

3. The Township of Minto in the County of Wellington.

WMU 85C

All that land in the County of Huron in the Province of Ontario described as follows:

Beginning at the intersection of the centre line of that part of the King's Highway known as No. 21 with the centre line of that part of the King's Highway known as No. 8; thence southeasterly along that centre line to the westerly boundary of the Township of Hibbert; thence southwesterly along that boundary to the southwest corner of the Township of Hibbert; thence southeasterly along the southerly boundary of that township to the intersection with the centre line of that part of the King's Highway known as No. 83; thence easterly along that centre line to the intersection with the easterly boundary of the Township of Osborne; thence southerly and southwesterly along that boundary to the southeast corner of that township; thence

northwesterly along the southerly boundary of that township to the easterly boundary of the Township of Stephen; thence southerly along that boundary to the southeast corner of that township; thence westerly along the southerly boundary of that township to the intersection with the centre line of the Ausable River; thence northerly along the centre line to the intersection with the centre line of that part of the King's Highway known as No. 21; thence west astronomically to the intersection with the International Boundary between Canada and the United States of America; thence northerly along that boundary to the intersection with a line drawn west astronomically from the place of beginning; thence east astronomically to the place of beginning.

WMU 86

All that land in the County of Perth in the Province of Ontario more particularly described in WMU's 86A and 86B.

WMU 86A

The townships of Ellice, Elma, Logan, Mornington, North Easthope and Wallace in the County of Perth.

WMU 86B

The townships of Blanshard, Downie, Fullarton, Hibbert and South Easthope in the County of Perth.

WMU 87

All that land in the regional municipalities of Hamilton-Wentworth and Waterloo and the counties of Brant and Wellington in the Province of Ontario described in WMUs 87A, 87B, 87C, 87D and 87E.

WMU 87A

All that land in the Regional Municipality of Waterloo, excepting thereout and therefrom the Township of North Dumfries.

WMU 87B

All that land in the Township of South Dumfries in the County of Brant and in the Township of North Dumfries, in the Regional Municipality of Waterloo.

WMU 87C

All that land in the Township of Puslinch in the County of Wellington in the Province of Ontario.

WMU 87D

All that land in the Township of Flamborough in The Regional Municipality of Hamilton-Wentworth in the Province of Ontario.

WMU 87E

All that land in The Regional Municipality of Hamilton-Wentworth and the County of Brant in the Province of Ontario described as follows:

Beginning at the intersection of the northerly boundary of the Township of Brantford with the easterly bank of the Grand River; thence in a southerly, northeasterly and southwesterly direction along that easterly and northerly bank to the intersection with the easterly boundary of the Township of Onondaga; thence northeasterly along that boundary to the intersection with the southerly boundary of the Town of Ancaster; thence southeasterly along that boundary and the southerly boundary of the Township of Glanbrook to the southeasterly corner of the Township of Glanbrook; thence northerly along the easterly boundary of the Township of Glanbrook to the intersection with the southerly boundary of the Town of Stoney Creek; thence easterly along the southerly boundary of the Town of Stoney Creek to the southeasterly corner thereof; thence northerly along the easterly boundary of the Town of Stoney Creek

and the northerly production of that boundary to the intersection with the line drawn east astronomically from the intersection of the water's edge of Lake Ontario and Hamilton Harbour; thence west astronomically to that intersection; thence westerly along the centre line of the waters connecting Lake Ontario and Hamilton Harbour to the intersection with the water's edge of Hamilton Harbour; thence westerly in a straight line to the intersection of the water's edge of Hamilton Harbour with the westerly boundary of the City of Burlington; thence northerly along that boundary to the intersection with the southerly boundary of the Township of Flamborough; thence westerly along that southerly boundary and the northerly boundary of the Township of Brantford to the place of beginning.

WMU 88

All that land in The Regional Municipality of Niagara in the Province of Ontario described as follows:

Beginning at the intersection of the water's edge of Lake Ontario with the westerly boundary of the Town of Grimsby; thence southerly along that boundary to the intersection with the centre line of Niagara Regional Road No. 73; thence easterly along the centre line to the intersection with the centre line of Niagara Regional Road No. 24; thence in a southerly direction along that centre line to the intersection with the centre line of Niagara Regional Road No. 669; thence in an easterly direction along that centre line to the intersection with the centre line of Niagara Regional Road No. 69; thence in an easterly direction along that centre line to the intersection with the centre line of Niagara Regional Road No. 28; thence in a southerly direction along that centre line to the intersection with the centre line of Niagara Regional Road No. 32; thence in a southerly direction along that centre line to the intersection with the centre line of that part of the King's Highway known as No. 20; thence in an easterly direction along that centre line to the intersection with the easterly bank of the Welland Canal; thence in a southerly direction along that easterly bank to the intersection with the southerly bank of the Welland River; thence in an easterly direction along that southerly bank to the confluence with the waters of the Niagara River; thence, north 45° east to the intersection with the International Boundary between Canada and the United States; thence in a northerly direction along that International Boundary to a point on that International Boundary said point being at latitude 43° 27' 01.51" north and longitude 79° 12' 03.18" west; thence in a straight line in a southwesterly direction to a point which point is at the intersection of the northerly production of the westerly limit of the Town of Grimsby and a line drawn east astronomically from the intersection of the centre line of the waters connecting Hamilton Harbour and the water's edge of Lake Ontario; thence southwesterly along that northerly production to the place of beginning.

WMU 89

All that land in the regional municipalities of Niagara and Haldimand-Norfolk and the counties of Brant, Elgin and Oxford in the Province of Ontario described in WMUs 89A and 89B.

WMU 89A

All that land in The Regional Municipality of Niagara in the Province of Ontario described as follows:

Beginning at the intersection of the water's edge of Lake Erie with the line between lots 19 and 20, Concession I as shown on the plan of the Township of Wainfleet; thence in a northerly direction along that line to the intersection with the centre line of Niagara Regional Road No. 3; thence in a northerly and easterly direction along that centre line to the intersection with the centre line of that part of the King's Highway known as No. 3; thence in a northerly direction along that centre line to the intersection with the centre line of Niagara Regional Road No. 24; thence in a northerly direction along that centre line to the intersection with the centre line of Niagara Regional Road No. 669; thence in an easterly direction along that centre line to the intersection with the centre line of Niagara Regional Road No. 69; thence in an easterly direction along that centre line to the intersection with the centre line of Niagara Regional Road No. 28; thence in a southerly direction along that centre line to

the intersection with the centre line of Niagara Regional Road No. 32; thence in a southerly direction along that centre line to the intersection with the centre line of that part of the King's Highway known as No. 20; thence in an easterly direction along that centre line to the intersection with the easterly bank of the Welland Canal; thence in a southerly direction along that easterly bank to the intersection with the southerly bank of the Welland River; thence in an easterly direction along that southerly bank to the confluence with the waters of the Niagara River; thence north 45° east to the International Boundary between Canada and the United States of America; thence in a southerly and southwesterly direction along that International Boundary to the intersection with a line drawn south astronomically from the place of beginning; thence north astronomically to the place of beginning.

Saving and expecting thereout and therefrom Navy Island in the Niagara River.

WMU 89B

All that land in the regional municipalities of Haldimand-Norfolk and Niagara in the Province of Ontario described as follows:

Beginning at the intersection of the water's edge of Lake Erie with the easterly bank of the Grand River; thence in a northwesterly direction along that easterly bank to the intersection with the northwesterly boundary of the Township of Haldimand, in the Regional Municipality of Haldimand-Norfolk; thence in a northeasterly direction along that westerly boundary to the northwestern corner of the said town; thence in a southeasterly direction along the northerly boundary of the said town to the intersection with the westerly boundary of the Township of West Lincoln, in The Regional Municipality of Niagara; thence in a northeasterly direction along the westerly boundary of the Township of West Lincoln in the Regional Municipality of Niagara, to the northwesterly corner thereof; thence in a southeasterly and northeasterly direction along the westerly and northerly boundary of the said township to the intersection with the centre line of Niagara Regional Road No. 73; thence in a southeasterly and easterly direction along that centre line to the intersection with the centre line of Niagara Regional Road No. 24; thence in a southerly direction along that centre line to the intersection with the centre line of that part of the King's Highway known as No. 3; thence in a westerly direction along that centre line to the intersection with the centre line of Niagara Regional Road No. 3; thence in a westerly and southerly direction along that centre line to the intersection with the line between lots 19 and 20, Concession I as shown on the plan of the Township of Wainfleet; thence in a southerly direction along that line to the water's edge of Lake Erie; thence south astronomically to the intersection with the International Boundary between Canada and the United States of America; thence in a westerly direction along that International Boundary to the intersection with a line drawn south astronomically from the place of beginning; thence north astronomically to the place of beginning.

WMU 90

All that land in The Regional Municipality of Haldimand-Norfolk and the counties of Brant, Elgin and Oxford in the Province of Ontario described in WMUs 90A and 90B.

WMU 90A

All that land in The Regional Municipality of Haldimand-Norfolk in the Province of Ontario described as follows:

Beginning at the intersection of the easterly bank of the Grand River with the centre line of that part of the King's Highway known as No. 5; thence westerly along that centre line to the intersection with the centre line of that part of the King's Highway known as No. 24A; thence southerly along that centre line to the intersection with the centre line of that part of King's Highway No. 24; thence southerly along that centre line to the intersection with the centre line of Regional Road No. 57; thence southerly along that centre line and the southerly production of that centre line to the intersection with the water's edge of Long Point Bay of Lake Erie; thence in a south-

easterly direction, in a straight line to the most easterly point of Long Point; thence continuing in a southeasterly direction along the southeasterly production of that line to the intersection with the International Boundary between Canada and the United States of America; thence northeasterly along that International Boundary to the intersection with a line drawn south astronomically from the intersection with the easterly bank of the Grand River and the water's edge of Lake Erie; thence north astronomically to that intersection; thence in a northerly and westerly direction along the easterly bank of the Grand River to the place of beginning.

WMU 90B

All that land in The Regional Municipality of Haldimand-Norfolk and the counties of Brant, Elgin and Oxford in the Province of Ontario described as follows:

Beginning at the intersection with the centre line of that part of the King's Highway known as No. 2 with the centre line of that part of the King's Highway known as No. 24A; thence southerly along that centre line to the intersection with the centre line of that part of the King's Highway known as No. 24; thence southerly along that centre line to the intersection with the centre line of Regional Road No. 57; thence southerly along that centre line and the southerly production of that centre line to the intersection with the water's edge of Long Point Bay of Lake Erie; thence in a southeasterly direction in a straight line to the most easterly point of Long Point; thence continuing in a southeasterly direction along the southeasterly production of that line to the intersection with the International Boundary between Canada and the United States of America; thence southwesterly along that International Boundary to the intersection with a line drawn south astronomically from the intersection of the southerly production of the centre line of that part of the King's Highway known as No. 19 with the water's edge of Lake Erie; thence north astronomically to that intersection; thence northerly along the southerly production of the centre line of that part of the King's Highway known as No. 19 and that centre line to the intersection with the centre line of that part of the King's Highway known as No. 2; thence easterly along that centre line to the place of beginning.

WMU 91

All that land in the counties of Middlesex and Oxford in the Province of Ontario described in WMUs 91A and 91B.

WMU 91A

All that land in the counties of Middlesex and Oxford in the Province of Ontario described as follows:

1. That part of the County of Middlesex lying east of the centre line of that part of the King's Highway known as No. 4 and north of the centre line of Middlesex County Road No. 35.

2. That part of the County of Oxford lying west of the centre line of that part of the King's Highway known as No. 19 and north of the centre line of Oxford County Road No. 27.

WMU 91B

All that land in the County of Oxford in the Province of Ontario described as follows:

That part of the County of Oxford lying east of the centre line of that part of the King's Highway known as No. 19 and north of the centre line of that part of the King's Highway known as No. 2.

WMU 92

All that land in the counties of Middlesex, Elgin and Oxford in the Province of Ontario described in WMUs 92A, 92B, 92C and 92D.

WMU 92A

All that land in the County of Middlesex in the Province of Ontario described as follows:

Beginning at the southwest corner of the Township of Adelaide; thence easterly, northerly, easterly and northeasterly along the southerly boundary of that township to the most northerly corner of the Township of Caradoc; thence southeasterly along the easterly boundary of that township to the intersection with the centre line of the Thames River; thence in an easterly direction along that centre line to the intersection with the centre line of that part of the King's Highway known as No. 4; thence northerly along that centre line to the intersection with the northerly boundary of the Township of McGillivray; thence westerly along that northerly boundary to the westerly boundary of that township; thence in a southerly direction along the westerly boundaries of the townships of McGillivray and West Willams to the southwest corner of the Township of West Willams; thence easterly along the southerly boundary of that township to the northwest corner of the Township of Adelaide; thence southerly along the westerly boundary of that township to the place of beginning.

WMU 92B

All that land in the counties of Elgin and Middlesex in the Province of Ontario described as follows:

Beginning at the northwest corner of the Township of Metcalfe; thence southerly and southwesterly along the westerly boundary of that township to the easterly boundary of the Township of Mosa; thence northwesterly along that easterly boundary to the most northerly corner of that township; thence southerly along the westerly boundary of the Township of Mosa to the southwest corner of that township; thence southeasterly along the westerly boundary of the Township of Aldborough and its production to the intersection with the International Boundary between Canada and the United States of America; thence northerly in a straight line to the intersection of the easterly boundary of Dunwich with the water's edge of Lake Erie; thence northwesterly along the easterly boundaries of the townships of Dunwich, Ekfrid and Metcalfe to the northwest corner of the Township of Caradoc; thence northeasterly along the northerly boundary of that township to the intersection with the northerly boundary of the Township of Metcalfe; thence westerly along that boundary to the place of beginning.

WMU 92C

All that land in the counties of Elgin and Middlesex in the Province of Ontario described as follows:

Beginning at the intersection of the southeasterly production of the westerly boundary of the Township of Aldborough with the International Boundary between Canada and the United States of America; thence northerly in a straight line to the intersection of the easterly boundary of Dunwich with the water's edge of Lake Erie; thence northwesterly along the easterly boundaries of the townships of Dunwich, Ekfrid and Metcalfe to the northwest corner of the Township of Caradoc; thence northeasterly along the northerly boundary of that township to the intersection with the northerly boundary of the Township of Metcalfe; thence northerly, easterly and northeasterly along the southeasterly boundary of the Township of Adelaide to the most northerly corner of the Township of Caradoc; thence southeasterly along the easterly boundary of that township to the intersection with the centre line of the Thames River; thence in an easterly direction along that centre line to the intersection with the centre line of that part of the King's Highway known as No. 4; thence southerly along that centre line and that centre line produced to the intersection with the water's edge of Lake Erie; thence south astronomically to the International Boundary between Canada and the United States of America; thence southwesterly along that International Boundary to the place of beginning.

WMU 92D

All that land in the counties of Elgin, Middlesex and Oxford in the Province of Ontario, described as follows:

Beginning at the intersection of the International Boundary between Canada and the United States of America with the southerly production of the centre line of that part of the King's Highway

known as No. 4; thence northerly along that southerly production and that centre line to the intersection with the centre line to Middlesex County Road No. 35; thence easterly along that centre line to the intersection with Oxford County Road No. 27; thence easterly along that centre line to the intersection with the centre line of that part of the King's Highway known as No. 19; thence southerly along that centre line and the southerly production of that centre line to the intersection with the water's edge of Lake Erie; thence south astronomically to the intersection with the International Boundary between Canada and the United States of America; thence southwesterly along that International Boundary to the place of beginning.

WMU 93

All that land in the counties of Lambton and Kent described in WMUs 93A and 93B.

WMU 93A

All that land in the counties of Lambton and Kent described as follows:

Beginning at the southeasterly corner of the Township of Sombra; thence in a southeasterly direction along the southwesterly boundary of the Township of Camden to the most westerly corner of the Township of Howard; thence in a southeasterly direction along the southwesterly boundary of that township to the intersection with the centre line of the right of way of the Macdonald-Cartier Freeway; thence northeasterly along that centre line to the easterly boundary of the Township of Orford; thence northerly along the easterly boundary of the townships of Orford, Zone, Euphemia, Brooke and Warwick to the northeasterly corner of the Township of Warwick; thence in a westerly direction along the northerly boundary of the Township of Warwick to the intersection with the easterly boundary of the Township of Bosanquet; thence in a northerly direction along that boundary to the southwesterly corner of the Township of Stephen being a point on the centre line of the Ausable River; thence continuing in a northerly direction along the centre line of the Ausable River to the intersection with the centre line of the King's Highway known as number 21; thence west astronomically to the intersection with the International Boundary between Canada and the United States of America; thence in a southerly direction along that boundary to the southwesterly corner of the Township of Sombra in accordance with the township limits in St. Clair River established by subsection 5 (1) of the *Territorial Division Act*; thence in an easterly direction along the southerly boundary of the Township of Sombra to the place of beginning.

WMU 93B

All that land in the County of Kent described as follows:

Beginning at the intersection of the centre line of the right of way of the Macdonald-Cartier Freeway with the southwesterly boundary of the Township of Harwich; thence in a southeasterly direction along the southwesterly boundary of that township to the intersection with the water's edge along the shore of Lake Erie; thence in a southeasterly direction along the production of the southwesterly boundary of the Township of Harwich to the intersection with the International Boundary between Canada and the United States of America; thence in a northeasterly direction along that boundary to the intersection with the southeasterly production of the northeasterly boundary of the Township of Orford; thence in a northwesterly direction along that production and the northeasterly boundary of the Township of Orford to the intersection with the centre line of the right-of-way of the Macdonald-Cartier Freeway; thence southwesterly along that centre line to the place of beginning.

WMU 94

All that land in the counties of Essex and Kent in the Province of Ontario described in WMUs 94A and 94B.

WMU 94A

All that land in the counties of Essex and Kent described as follows:

Beginning at the most northeasterly corner of the Township of Chatham; thence in a southeasterly direction along the northeasterly boundary of the townships of Chatham and Harwich to the intersection with the centre line of the right-of-way of the Macdonald-Cartier Freeway; thence southwesterly along that centre line to the northeasterly boundary of the Township of Raleigh; thence southeasterly along the northeasterly boundary of that township to the intersection with the water's edge along the shore of Lake Erie; thence southeasterly along the production of the northeasterly boundary of the Township of Raleigh to the intersection with the International Boundary between Canada and the United States of America; thence in a southwesterly, northerly and northeasterly direction along that boundary to the northwesterly corner of the Township of Chatham in accordance with the township limits in St. Clair River established by subsection 5 (1) of the *Territorial Division Act*; thence in an easterly direction along the northerly boundary of the Township of Chatham to the place of beginning.

Excepting thereout and therefrom WMU 94B and WMU 95.

WMU 94B

All that land in the County of Essex described as follows:

Beginning at the northeasterly corner of the Township of Malden; thence in a southerly direction along the easterly boundary of the Township of Malden to the southeasterly corner thereof in accordance with the township limits in Lake Erie established by subsection 5 (1) of the *Territorial Division Act*; thence in a northwesterly direction along that boundary to the northwesterly corner of the Township of Malden in accordance with subsection 5 (1) of the *Territorial Division Act*; thence in an easterly direction along the northerly boundary of the Township of Malden to the place of beginning.

WMU 95

Pelee Island in the Township of Pelee in the County of Essex in the Province of Ontario.

O. Reg. 155/82, Sched.; O. Reg. 685/82, s. 1; O. Reg. 509/84, s. 1; O. Reg. 325/85, s. 1; O. Reg. 518/85, ss. 1, 2; O. Reg. 337/86, s. 1; O. Reg. 488/86, s. 1; O. Reg. 638/87, s. 1; O. Reg. 304/88, s. 1; O. Reg. 344/89, s. 1; O. Reg. 538/89, s. 1; O. Reg. 563/89, s. 1; O. Reg. 10/90, s. 1; O. Reg. 585/90, ss. 1, 2.

REGULATION 531**WOLVES AND BLACK BEARS IN CAPTIVITY**

1. A licence to keep a live male wolf in captivity in an immovable cage or pen shall be in Form 1. R.R.O. 1980, Reg. 438, s. 1.

2. A licence to keep a live male wolf in captivity is subject to the terms and conditions that the holder of the licence,

- keep the wolf in an immovable cage or pen in accordance with the specifications in the Schedule;
- observe the specifications in the Schedule;
- supply food and water at twelve-hour intervals to the wolf kept in captivity; and
- keep the cage or pen in a sanitary condition. R.R.O. 1980, Reg. 438, s. 2.

3. A licence in Form 1 expires with the 31st day December of the year in which it is issued. R.R.O. 1980, Reg. 438, s. 3.

4. A licence to keep a live male black bear in captivity in an immovable cage or pen shall be in Form 2. R.R.O. 1980, Reg. 438, s. 4.

5. The conditions set out in section 2 apply with necessary modifications to a licence to keep a live male black bear in captivity. R.R.O. 1980, Reg. 438, s. 5.

6. A licence in Form 2 expires with the 31st day of December of the year in which it is issued. R.R.O. 1980, Reg. 438, s. 6.

Schedule

The immovable cage or pen shall,

- have a floor area of not less than 150 square feet as shown in Figure 1;
- be erected on a minimum 4" concrete slab constructed as shown in Figure 2;
- have an overall height of not less than 6' 0" as shown in Figure 3;
- be constructed of material not less than 2" x 2" x 3/16" angle iron or 2" diameter galvanised pipe as shown in Figure 3 and enclosed by chain link fence with a mesh size not more than 2" x 2", of number 8 gauge or heavier wire secured at the bottom edge to the angle iron installed 2" above the concrete slab;
- be completely covered with a roof constructed of materials other than transparent or translucent materials with an overhang all around of not less than 18"; and
- have weatherproof sleeping quarters of a size not less than 30" x 30".

FIG. 1

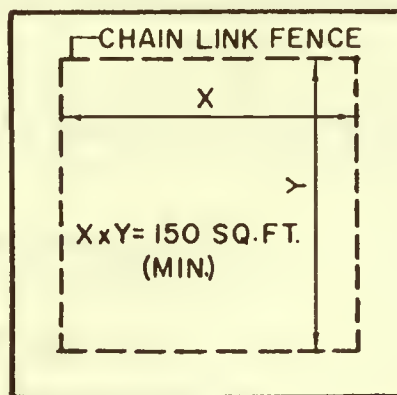
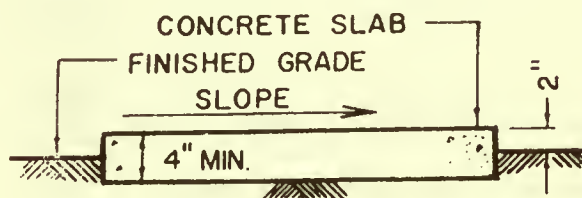
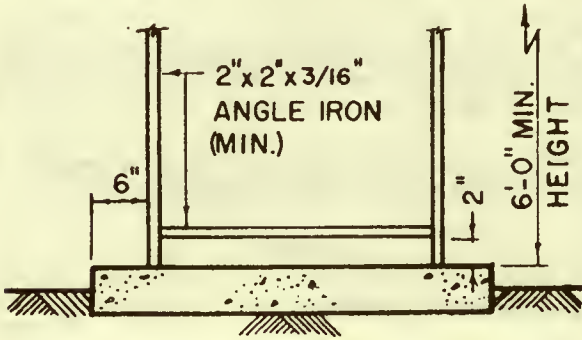

FIG. 2



Form 2

FIG. 3



LICENCE TO KEEP A BLACK BEAR IN CAPTIVITY

No.

Ministry of Natural Resources

R.R.O. 1980, Reg. 438, Sched.

Form 1

LICENCE TO KEEP A WOLF IN CAPTIVITY

No.

Ministry of Natural Resources

Under the Game and Fish Act and the regulations and subject to the limitations thereof, this licence is issued to:

..... (name)

of (address)

to keep in captivity one (1) live male wolf in an immovable cage or pen at:

..... This licence expires with the 31st day of December, 19.....

Issued at

..... (signature of issuer) (signature of licensee)

..... (date)

R.R.O. 1980, Reg. 438, Form 1.

Under the Game and Fish Act and the regulations and subject to the limitations thereof, this licence is issued to:

..... (name)

of (address)

to keep in captivity one (1) live male black bear in an immovable cage or pen at:

..... This licence expires with the 31st day of December, 19.....

Issued at

..... (signature of issuer) (signature of licensee)

..... (date)

R.R.O. 1980, Reg. 438, Form 2.

Gasoline Handling Act

Loi sur la manutention de l'essence

REGULATION 532

GASOLINE HANDLING CODE

DEFINITIONS

1. In this Regulation,

“approved” means,

- (a) where applied to a specification, that the specification is approved by the Director,
- (b) where applied to equipment, including portable containers, that the equipment bears a label of a designated testing organization, certifying conformance with a specification approved by the Director or conforming with a laboratory test report accepted by the Director, or bears certification as to manufacture or fabrication to a standard or specification acceptable to the Director,
- (c) in addition to the requirements of clause (b), where applied to steel tanks installed or intended for installation underground, that the tanks meet the requirements prescribed by this Regulation, or
- (d) where applied to an installation, that the installation conforms with this Regulation;

“baffle” means a non-liquid-tight transverse partition in a cargo tank;

“bulk storage tank”, “storage tank” or “tank” includes any static storage tank in which gasoline or an associated product is contained, but does not include a supply tank that is connected to the heating appliance that it serves;

“Director” means the Director of the Fuels Safety Branch of the Ministry of Consumer and Commercial Relations;

“earthwork” means construction composed of clay, shale or heavy loam and containing not more than 10 per cent by volume of sand, gravel or stone;

“empty”, when used with reference to a container or tank for gasoline or an associated product, means voided of its contents as far as is practicable by suction or pouring;

“explosion-hazard location” means any location where gasoline or an associated product that can produce a dangerous atmosphere is stored, or where leakage or spillage of the gasoline or associated product could occur and includes retail outlets, bulk plants, tank truck or tank car filling facilities, storage areas for packaged Class I or Class II gasoline or associated products, or empty containers and pump houses;

“gallon” means a Canadian gallon, which for the purpose of this Regulation may be considered equivalent to an Imperial gallon;

“gas-proof room” means a room so constructed and maintained that combustible gases or fumes cannot enter the room;

“hazard-area limit” means,

- (a) in respect of areas that are fenced in accordance with this Regulation, the extent of the areas within that fencing, or

- (b) in respect of other areas, the property line but not less than the distances prescribed by column 3 of Table 1 to subsection 6 (23);

“highway” includes a common and public highway, street, avenue, parkway, driveway, square, place, bridge, viaduct or trestle, designed and intended for, or used by, the general public for the passage of vehicles;

“Ministry” means the Ministry of Consumer and Commercial Relations;

“motor vehicle” means an automobile, motorcycle, and any other vehicle propelled or driven by an internal combustion engine, and licensed under the *Highway Traffic Act*;

“nominal gauge” means, when used with reference to thickness of the shell or other part of a tank, that the plate used in construction of that shell or other part is known in the plate-mill industry as having the specified thickness;

“operator” means,

- (a) the person who is responsible for the day to day operation of a retail outlet, marina, private outlet or bulk plant, as the case may be, and who is normally located on the premises during the hours of operation, and
- (b) when referring to a vehicle, the driver in charge of the vehicle;

“psig” means pounds per square inch gauge;

“pump island” means a concrete base, raised at least four inches above the vehicle travelled portion of an area adjacent to dispensing equipment, upon which dispensing equipment is mounted;

“Reid vapour pressure” means the vapour pressure of gasoline or an associated product at 37.8°C. or 100°F.;

“semi-trailer” means a conveyance designed for carrying goods and so constructed that a part of the conveyance rests upon a part of a tractor;

“Specification approved by the Minister” means a Specification the title of which is contained in the List of Specifications Approved by the Minister for use in Ontario;

“tank truck” means a motor vehicle having one or more tanks mounted on the frame or chassis of the vehicle;

“tank vehicle” means a vehicle designed for or capable of transporting gasoline or associated products in bulk;

“trailer” means a vehicle designed for carrying goods and so constructed that it is drawn by a motor vehicle but no part of it rests upon the motor vehicle;

“unprotected underground tank” means a steel underground tank installed without corrosion protection set out in ULC Standard S603.1 or without impressed voltage corrosion protection;

“US DOT Specs.” means the Specifications of the United States Department of Transportation;

“USSMSG” means United States standard metals gauge for sheet iron and steel;

“waterway” means stream, river, lake, and includes a dry water-course;

“wholly enclosed” means a structure having doors or other means capable of impeding the entrance or exit of persons or the escape of fumes. R.R.O. 1980, Reg. 439, s. 1; O. Reg. 436/82, s. 1; O. Reg. 620/88, s. 1.

APPLICATION

2. This Regulation,

(a) applies to,

- (i) the handling of gasoline and associated products identified in section 3,
- (ii) portable and transportable containers,
- (iii) above and below ground storage tanks and piping systems connected therewith,
- (iv) vehicles,
- (v) dispensing pumps, and
- (vi) transfer facilities,

and associated equipment used and operated by the operators of retail outlets, marinas, private outlets and bulk plants and by transporters;

(b) applies to the offering for sale, and sale of approved equipment for use with gasoline and associated products; and

(c) applies to the certification, approval and maintenance requirements for equipment for handling gasoline and associated products including portable and transportable containers, storage tanks, automatic dispensing nozzles, hand fire extinguishers, piping system components and tank trucks, trailers and semi-trailers. R.R.O. 1980, Reg. 439, s. 2; O. Reg. 620/88, s. 1.

PRODUCT IDENTIFICATION

3.—(1) All gasoline and associated products shall be identifiable within the scope of the current Petroleum and Associated Products Standards listed in the Canadian General Standards Board Catalogue published annually.

(2) The following products shall conform to the specific standard set out for the product in the Catalogue referred to in subsection (1):

Automotive Gasoline (leaded)

Automotive Gasoline (unleaded)

Fuel Oil Heating

Diesel Fuel

Kerosene

Lighting Naphtha

Dry Cleaning Solvent.

O. Reg. 436/82, s. 2.

(3) Gasoline and associated products are categorized as follows:

1. Class I products, having flash points below 100°F. and

including such products as automotive gasoline, aviation gasoline, naphtha and alcohol-based antifreeze.

2. Class II products, having flash points from 100°F. to 150°F., both inclusive, and including such products as fuel oil, diesel fuel, kerosene, brake fluid and cleaning fluid.

3. Class III products, having flash points above 150°F., and including heavy fuel oil, engine oil, gear oil, shock absorber fluid and glycol-based antifreeze. R.R.O. 1980, Reg. 439, s. 3 (3).

(4) Automotive gasoline shall not have an oxygen content that is greater than 0.5 per cent mass. O. Reg. 67/89, s. 1.

REGISTRATION

4.—(1) An application for a licence,

- (a) to operate a bulk plant;
- (b) to operate a retail outlet or marina; or
- (c) to transport,

or a renewal thereof shall be filed with the Director. R.R.O. 1980, Reg. 439, s. 4 (1); O. Reg. 620/88, s. 1.

(2) A licence,

- (a) to operate a bulk plant;
- (b) to operate a retail outlet or marina; or
- (c) to transport,

or a renewal thereof, shall be issued to an applicant upon evidence being supplied to the Director of the applicant's compliance with the Act and this Regulation. R.R.O. 1980, Reg. 439, s. 4 (2); O. Reg. 620/88, s. 1.

(3) The fee payable on an application,

- (a) for a licence to operate a bulk plant or a renewal thereof, issued for one year, if the storage capacity of the bulk plant is,

(i) less than 350,000 litres, \$100,

(ii) 350,000 litres or more but less than 2,300,000 litres, \$500, or

(iii) 2,300,000 litres or more, \$1,000;

- (b) for a licence to operate a service station or marina or a renewal thereof, issued for one year, \$75 for each location; and

- (c) for a licence to transport or a renewal thereof, issued for one year, \$50 for each vehicle.

(4) The fee payable for an inspection by an inspector upon an application for a licence is \$100 per hour or part thereof. O. Reg. 458/89, s. 1 (1), *part*.

(5) The holder of a licence,

- (a) to operate a bulk plant;
- (b) to operate a retail outlet or marina; or
- (c) to transport,

shall notify the Director within six days of any change of business address, of any change in any other particulars noted on the licence

or that the holder of the licence is no longer the operator of the facility or owner of the tank vehicle, as the case may be. R.R.O. 1980, Reg. 439, s. 4 (4); O. Reg. 620/88, s. 1.

(6) Where a vehicle is used or hired temporarily for a period of thirty days or less to replace a licensed vehicle that is,

- (a) off the road for inspection or repairs; and
- (b) used to transport packaged gasoline and associated products,

the vehicle is exempt from the requirements of a licence to transport. R.R.O. 1980, Reg. 439, s. 4 (5).

- (7) Every application for a licence,
- (a) to operate a bulk plant;
 - (b) to operate a retail outlet or marina; or
 - (c) to transport,

or a renewal thereof shall be signed by the person responsible for the operation of the facility or equipment to which the application applies. R.R.O. 1980, Reg. 439, s. 4 (6); O. Reg. 620/88, s. 1.

- (8) A licence,
- (a) to operate a bulk plant; or
 - (b) to operate a retail outlet or marina,

shall at all times be displayed in a conspicuous position on the licensed premises, and a licence to transport shall be carried with the licensed vehicle. R.R.O. 1980, Reg. 439, s. 4 (7); O. Reg. 620/88, s. 1.

- (9) A licence,
- (a) to operate a bulk plant;
 - (b) to operate a retail outlet or marina; or
 - (c) to transport,

expires on the date indicated on the licence, and

- (d) a licence for a bulk plant, retail outlet or marina is not valid for or transferrable to any other location; and
- (e) a licence for a vehicle is not valid for or transferrable to any other vehicle. R.R.O. 1980, Reg. 439, s. 4 (8); O. Reg. 620/88, s. 1.

(10) An application for registration as a contractor or a renewal thereof shall be filed with the Director.

(11) Evidence of registration as a contractor or a renewal thereof shall be issued to the applicant by the Director when the applicant is registered or the registration is renewed. R.R.O. 1980, Reg. 439, s. 4 (9, 10).

(12) The fee payable on an application for a registration as a contractor or a renewal thereof issued for one year is \$100. O. Reg. 458/89, s. 1 (1), *part*.

(13) A contractor shall display evidence of registration in a conspicuous position in the contractor's business premises and shall notify the Director forthwith of any change in business address. R.R.O. 1980, Reg. 439, s. 4 (12).

(14) The holder of a licence or registration who has lost the licence or evidence of registration shall, on the payment of a \$15 fee, be issued a duplicate thereof. O. Reg. 436/82, s. 3 (3).

CODE

VEHICLES AND TRANSPORTATION

5.—(1) This section does not apply to fuel tanks used in the operation of motor vehicles.

(2) No Class I or Class II product shall be tendered for transportation or transported in a container having a capacity of less than fifty gallons but more than ten gallons, unless the container,

- (a) for Class I products is clearly marked as conforming to the requirements of Shipping Container Specification 5, 5A, 5B, 5C, 5L or 5M dated the 29th day of April, 1972 of the Canadian Transport Commission, or of the Department of Transportation of the United States of America in force on the 29th day of April, 1972; and
- (b) for Class II products is of at least 18 gauge and conforms to the safety requirements of the specifications listed in clause (a).

(3) Where gasoline or associated products are transported by a vehicle so constructed that the containers of the gasoline or associated products are not permanently attached to the chassis of the vehicle and, where each container is in excess of ten gallons in capacity, there shall be only a single tier of containers of Class I products on the vehicle. R.R.O. 1980, Reg. 439, s. 5 (1-3).

(4) A container used for road conveyance of a Class I or Class II product in bulk shall be approved. O. Reg. 436/82, s. 4 (1).

(5) Except in the case of the transportation or movement of any empty tank, a tank that is not permanently attached to the chassis of a vehicle shall be firmly secured to a cradle or sill, and the cradle or sill shall be anchored to the chassis of the vehicle by means of hook-bolts or other equally secure devices.

(6) A tank permitted to be used under subsection (5) shall not have a capacity greater than the carrying capacity of the vehicle.

(7) Every tank truck, trailer or semi-trailer constructed before the 1st day of December, 1967 shall have been constructed and marked in accordance with US DOT Specs. MC 300, 302, 303, 304 or 305 dated January, 1965 or MC 306 or 307 dated March, 1967.

(8) Subject to subsection (10), every tank vehicle constructed on or after the 1st day of December, 1967 to transport Class I products shall be constructed and marked in accordance with the requirements of this Regulation and US DOT Specs. MC 306 or 307 in effect at the time of construction and so identified in the List of Specifications referred to in subsection 10 (4) and the marking plate shall indicate the capacity in Imperial gallons.

(9) Every tank truck, trailer or semi-trailer constructed on or after the 1st day of June, 1970 for carrying petroleum products other than Class I products shall be constructed and marked in accordance with Energy Branch Standard MC 306M and the requirements of this Regulation.

(10) In the construction of a tank truck, trailer, and semi-trailer, the pressure limitations of the *Boiler and Pressure Vessels Act* shall apply.

(11) Tank trucks, trailers and semi-trailers with compartments carrying liquids of different classes shall be provided with a vented air space between compartments and each air space shall be constructed and maintained to ensure that any liquid in it will drain to the ground, at all times.

(12) All remounted tanks and new delivery equipment dispensing Class I and Class II products from the same vehicle through a reel and meter system shall be equipped with a separate unloading system for each Class of product.

(13) A hose reel used for dispensing a Class I or Class II product shall be equipped with a braking device designed and maintained to eliminate uncontrolled discharge of the hose from the reel.

(14) Each compartment of each tank vehicle shall be equipped with a shut-off valve,

- (a) located in the outlet that is inside the shell, or located in the sump when the sump is an integral part of the shell; and
- (b) so designed and maintained that the valve shall be closed at all times except during loading or unloading operations.

(15) The operating mechanism for the shut-off valve referred to in subsection (14) shall be provided with a secondary control,

- (a) readily accessible for use in case of accident or fire during loading or unloading operations;
- (b) as far as practicable from any fill-opening or discharge-faucet; and
- (c) provided with a fusible section to close automatically in case of fire.

(16) All shut-off valves referred to in subsection (14) shall be so designed that,

- (a) they are as close as is physically possible to the shell of the tank; and
- (b) immediately downstream from such valves there shall be a connection designed to separate upon impact or strain in such a manner as not to damage the valve or to separate the valve from the tank shell.

(17) Every tank truck, trailer or semi-trailer that is used for the transportation of gasoline or associated products is exempt from subsection (14) if it was in use on the 2nd day of September, 1966.

(18) An emergency valve, manhole or vent on a tank vehicle shall be approved.

(19) A flexible connector, sump or manifold on a tank vehicle shall be constructed in accordance with approved specifications.

(20) All valves, piping and associated connections shall be protected from damage due to collision from the rear.

(21) In addition to the requirements of US DOT Specs. MC 300, 302, 303, 304 and 305, dated January, 1965 and MC 306 and 307 dated July, 1971, the protection required by subsection (20) shall be such that it will prevent damage to the valves, piping and associated connections, which damage could result from collision with an object that could override or under-pass the protective bumper.

(22) Every draw-off valve and faucet shall be threaded at the discharge end or designed to permit tight connection to the delivery hose.

(23) Every draw-off valve and faucet shall be designed and maintained to prevent leakage.

(24) Vehicle tanks and vehicle chassis shall be constructed and maintained to provide electrical continuity between them.

(25) All tank trucks, trailers, and semi-trailers that may be loaded or unloaded through an open dome shall be provided with an approved electric bonding clip.

(26) Tank vehicles not equipped as required by subsection (25) shall be modified to comply with the requirements of subsection (25).

(27) Every transporter shall ensure that the transporter's vehicles

are conspicuously and legibly marked on each side and on the rear in letters at least three inches high and of a colour that contrasts sharply with the background,

- (a) with the word "flammable";
- (b) with the common name of the product being transported; or
- (c) with the name of the carrier if the name includes the common name of the product being transported,

and in the case of tank vehicles the marking requirements apply whether the vehicle is loaded or empty.

(28) All new and replacement markings required by subsection (27) shall be made in letters at least four inches high.

(29) Every vehicle used in the transportation of gasoline or associated products shall be equipped in front with a heavy-duty bumper and the fuel tank for the vehicle shall be so located that it is not over the engine and is equipped to vent while it is being filled.

(30) The exhaust system of vehicles used for transporting gasoline or associated products, including the exhaust line and muffler, shall be so located as to be clear from the fuel system and all combustible materials and shall be terminated in such a position that fumes or heat from the exhaust shall not create a hazard to the tank contents or to a facility being refuelled or from which the tank truck is being refilled.

(31) No container or tank that leaks, or that has become so worn or been so damaged as to show visual evidence of being likely to spring a leak, shall be used to transport any gasoline or associated product.

(32) No tank truck, trailer or semi-trailer having one or more tanks mounted on the chassis thereof, shall be operated unless,

- (a) it is designed to have good road stability;
- (b) it is maintained in good operating condition; and
- (c) inspection before each use shows that the tank and its liquid carrying components are not so worn or damaged as to be likely to spring a leak.

(33) Every tank truck and every trailer, other than tracked vehicles, shall be operated on not less than four wheels.

(34) Every semi-trailer shall be operated on not less than two wheels.

(35) Subject to subsection (36), no vehicle shall be used for the refuelling of another vehicle or motor vehicle.

(36) Subsection (35) does not apply to the use of approved vehicles in refuelling a contractor's construction equipment on a job site.

(37) When the outlet valve of tank trucks, trailers or semi-trailers carrying Class I or Class II products is not in actual use the valve handle shall be detached or, where the handle cannot be detached, the valve, or cabinet containing the valve, shall be kept locked.

(38) Despite subsection (37), where immobilization of the pump by locking the ignition effectively prevents the escape of product, the valve handle of any valve supplied by the pump need not be detached and the valve or cabinet need not be locked.

(39) Before loading a Class I product into a tank truck, trailer or semi-trailer through an open dome or loading a Class II product into a compartment that previously contained a Class I product, all possible static electricity shall be discharged by the loader. R.R.O. 1980, Reg. 439, s. 5 (5-39).

(40) The discharge of static electricity and prevention of further

build-up of a difference in electrical potential shall be accomplished by fastening the bond wire from the loading facility to the bonding clip on the vehicle. O. Reg. 436/82, s. 4 (2).

(41) While bulk deliveries are being made by gravity into underground storage facilities, the engine ignition of the vehicle shall be shut off.

(42) Except where a tank truck, trailer or semitrailer compartment is in the same service continuously and will remain in that service, no meter air-release mechanism shall be vented back into that compartment.

(43) No tank conforming to DOT Specs. MC 302, 303, 304 or 305 and having a capacity greater than 3,500 gallons shall be used to transport Class I products unless,

- (a) it is divided into compartments;
- (b) none of the compartments has a capacity greater than 3,500 gallons; and
- (c) baffles are provided where and as required by the US DOT Specs.

(44) No cargo tank or compartment shall be completely filled with liquid, and the air space shall be at least 1 per cent of the compartment volume and shall always be sufficient to allow for temperature-volume expansion of the liquid.

(45) Where a compartment that has been used to carry a Class I product is to be used to carry a Class II or Class III product, all of the Class I product shall be completely drained from the compartment, and from the piping and accessory delivery equipment connected thereto, before the Class II or Class III product is loaded.

(46) Every compartment discharge control on a tank truck, trailer or semi-trailer shall have securely attached to it a tag of anodized or enamelled metal, substantial fibre or petroleum-resistant plastic to denote which class of product is contained in the tank or compartment from which the control leads.

(47) A tag, referred to in subsection (46), to denote,

- (a) a Class I product shall be coloured red and shall be octagonal in shape; and
- (b) a Class II product shall be coloured any colour other than red, green or red-orange shades, and shall be round in shape.

(48) All tags, in addition to being coloured and of the specified shape, shall bear in clearly legible permanent characters the name of the product.

(49) Every tag shall at all times be kept clean and bright so that its colour is readily recognizable, and its inscription is readily legible.

(50) It shall be the responsibility of the loader at the point of loading to attach the correct tags.

(51) It shall be the responsibility of the driver to ensure that the correct tags have been attached before the driver leaves the point of loading.

(52) Vehicle lighting and power circuits shall be maintained at all times in good condition and shall be fused or protected so that a short-circuit or sparking is not likely to occur.

(53) No gasoline or associated product having a Reid vapour pressure greater than 18 psig shall be transported in a vehicle that does not conform to the US DOT Specs. requirements for such pressures.

(54) Before a vehicle is unloaded, the operator of the vehicle

shall gauge the tank or tanks, or shall use such other means as are reasonable in the circumstances to satisfy himself or herself that the tank or tanks can accept the volume the operator proposes to unload. R.R.O. 1980, Reg. 439, s. 5 (41-54).

(55) Despite subsection (54), the operator of a vehicle shall perform the gauging required by subsection (54) when making deliveries to retail outlets, private outlets and marinas. R.R.O. 1980, Reg. 439, s. 5 (55); O. Reg. 620/88, s. 1.

(56) While the vehicle is being unloaded, the operator of the vehicle shall not remain in the vehicle but shall remain in close proximity to the discharge control.

(57) When an operator of a vehicle has reason to believe that the vent from a tank may be obstructed, the operator shall cease transferring the gasoline or associated product from the vehicle and shall report the obstruction to the person having the care and custody of the tank or, where the operator is unable to contact that person the operator shall report the obstruction to the operator's supervisor.

(58) While a vehicle is being loaded, the loader shall remain in such a position that in an emergency the loader can immediately shut off the flow of product.

(59) The person in charge of a vehicle, while the vehicle is being driven, repaired, loaded or unloaded, shall not have in his or her possession any,

- (a) lighted match;
- (b) lighted lighter;
- (c) lighted pipe;
- (d) lighted cigar; or
- (e) lighted cigarette,

and shall do everything in his or her power to prevent any other person from having in his or her possession any article referred to in clause (a), (b), (c), (d) or (e) while that person is in the vehicle or taking delivery from the vehicle, or while that person is within twenty-five feet of a vehicle while it is parked, being loaded, being unloaded or being repaired.

(60) Every stake truck, tank truck, tractor, trailer or semi-trailer operated or parked singly or in combination, shall at all times be equipped with a parking brake of the design referred to in subsection (62) or chock blocks, or both, adequate to prevent movement of the vehicle when parked either singly or in combination on any grade on which the vehicle is operated or parked and under any condition of loading.

(61) The parking brake or brakes shall at all times be capable of being applied in conformance with the requirements of subsection (60) by the driver's muscular effort or by spring action or by other energy, provided that, if such other energy is depended on for application of the parking brake, an accumulation of such energy shall be isolated from any common source and used exclusively for the operation of the parking brake.

(62) The parking brake shall be so designed, constructed and maintained that when once applied,

- (a) it shall remain in the applied condition, with the effectiveness required by subsection (60), despite exhaustion of any source of energy or leakage of any kind; and
- (b) it cannot be released unless adequate energy is available in the brake system upon release to make an immediate further effective application.

(63) Every vehicle equipped with the type of brake referred to in

subsection (62) shall be conspicuously and legibly marked with a symbol or marking in evidence thereof.

(64) The parking brake referred to in subsection (62) shall be set, or the chock blocks shall be positioned, whenever the vehicle is parked, including parking for loading and unloading.

(65) Before a tank vehicle undergoes repair work involving cutting or welding, it shall be made gas-free.

(66) Before a tank vehicle is parked inside a building, the driver shall check to ensure that there are no leaks in the tank, piping or valving, and shall ensure that the provisions of subsection (44) have been followed.

(67) In the event of spillage or other loss of a product during the filling, emptying or operation of a tank vehicle, the operator of the vehicle shall take immediate corrective action and shall notify the nearest inspector as soon as is practicable and in no case more than twenty-four hours after the loss or spillage. R.R.O. 1980, Reg. 439, s. 5 (56-67).

(68) A new tank vehicle that is to be filled by bottom loading or any other method where the liquid level in the compartment cannot be observed and controlled directly by the loader shall be constructed and equipped in accordance with the applicable requirements of the 1981 edition of Standard PTT-101 listed in "Titles of Equipment, Accessory and Component Standards Authorized for Use in Ontario Under the *Gasoline Handling Act*". O. Reg. 436/82, s. 4 (3).

(69) No tank vehicle shall be filled by a method referred to in subsection (68) unless the vehicle conforms to the applicable requirements of the standard referred to in subsection (68).

(70) Where a tank vehicle is to be filled by a method referred to in subsection (68) the operator of the vehicle shall ensure that the vehicle is connected to a loading facility such that the automatic overflow protection system installed on the loading facility will respond and respond to the signals from the automatic overflow protection system installed on the vehicle.

(71) The information required by subsection (8) shall be stamped or embossed on the certification plate, including both legend and specific data, and the plate shall specify the maximum operating pressure for all the tank vehicle liquid-carrying components.

(72) Pumps, meters and other liquid-carrying components installed on tank vehicles shall be designed for use at the pressures indicated on the tank vehicle certification plate.

(73) The engaged and the disengaged positions of the power take off actuation lever shall be clearly and permanently marked on every tank vehicle unit manufactured on and after the 1st day of July, 1979.

(74) The owner of every tank vehicle equipped with the operating mechanism referred to in subsection (15) shall ensure that the mechanism is exercised and serviced and is maintained in good operating condition. R.R.O. 1980, Reg. 439, s. 5 (69-74).

ABOVE GROUND STORAGE TANKS

6.—(1) This section applies to above ground storage tanks used for storing gasoline and associated products, including their design, construction, and siting requirements and the manner of operation of such tanks and their associated equipment.

(2) This section applies to every bulk-storage tank other than a bulk-storage tank that was in use on the 11th day of June, 1954, in which case the owner of the tank is exempt from subsection (3) whether the owner,

- (a) owned the tank at that date; or
- (b) acquired the tank at any time subsequent to that date,

but only so long as the tank remains installed in the same place and position as it was at that date.

(3) Tanks shall be approved and shall meet the requirements of the specifications approved by the Minister.

(4) A tank installed above ground shall be supported on a firm base designed and installed in accordance with good engineering practice, and shall be protected as necessary from vehicle impact or other physical damage.

(5) No tank installed above ground and consisting of two or more compartments shall be used for any gasoline or associated product unless the compartments are separated by,

- (a) double bulkheads having between them a drained air space; or
- (b) a flanged single bulkhead so constructed that any liquid or vapour seeping or leaking through any seam or joint will escape directly to open air and not between compartments.

(6) Subject to subsection (7), the outside of every tank fabricated of any ferrous substance, whether galvanized or not, shall be thoroughly coated with rust-resisting material compatible with the substance of which the tank is fabricated.

(7) Where there is evidence to indicate a higher degree of corrosion than that provided for in the design formula used, additional metal thickness or protective coatings or linings shall be provided to compensate for the corrosion loss expected during the design life of the tank.

(8) All piping associated with a gasoline or associated products storage tank shall be of American Petroleum Institute Specification 5L or equivalent standard and shall be protected from external corrosion,

- (a) where above ground, by painting, wrapping, coating or other approved manner; and
- (b) where underground, by wrapping, coating with asphaltic material, galvanizing, cathodic protection or other approved manner,

and shall be firmly supported and protected when necessary from vehicle impact or other physical damage by substantial barriers.

(9) Where a bulk-storage tank installed above ground has piping or a fitting connected to it at any point below the highest level to which the gasoline or associated product will rise, the piping or fitting shall be provided with an internal or external steel control valve located as near as practicable to the shell of the tank and such valve shall be closed when the plant operator is absent from the plant. R.R.O. 1980, Reg. 439, s. 6 (1-9).

(10) The valve described in subsection (9) shall be automatically controlled when located in a bulk plant that is unattended and in which the loading equipment is operated by the tank vehicle operators authorized to use the plant. R.R.O. 1980, Reg. 439, s. 6 (10), *revised*.

(11) Connections to pipelines through which tank cars or tank vehicles discharge by means of pumps into above ground tanks shall be,

- (a) provided with check valves for automatic protection against back flow; and
- (b) designed, installed and maintained to prevent leakage and spillage.

(12) Interconnected systems carrying different classes of products shall be separated, wherever possible, with steel blinds or locked valves.

(13) The normal operating pressure of a tank shall not exceed its design pressure.

(14) Every tank shall be vented.

(15) Vent openings shall be of cross-sectional area sufficient to permit free escape of air and vapour when the tank is being filled at its maximum intake capacity.

(16) In the case of vents equipped with a weather-proof hood or a flame arrestor, or both, the effective opening shall be not less than that of a pipe of two inches internal diameter.

(17) A tank installed above ground shall,

(a) have vent openings sufficient to permit free outflow or inflow of air normal to,

(i) filling or emptying operations, and

(ii) temperature changes,

so that neither the shell nor the roof will be distorted under normal pressures;

(b) be equipped with,

(i) a weather-proof hood, or

(ii) venting devices that normally remain closed except when subjected to pressure or vacuum; and

(c) be fabricated or equipped with devices so that abnormal internal pressures in the tank that might rupture the shell or bottom will be relieved.

(18) A battery of tanks containing gasoline or associated products of the same class may be individually vented into a common header.

(19) Where a common header is used under subsection (18),

(a) the common header shall be at least one pipe size larger than the largest individual vent pipe connected to it;

(b) pipe sizes shall be such as to discharge the vapours freely when the manifolded tanks are filled simultaneously; and

(c) no individual vent pipes shall be connected to the common header at a point lower than one foot above the top of any fill pipe in the same system.

(20) Every common header and every individual vent pipe not connected into a common header shall,

(a) be provided with a weather-proof hood or a pressure-vacuum vent; and

(b) terminate in open air,

(i) not less than seven feet for Class II products and twelve feet for Class I products, above general grade level,

(ii) outside buildings, in such a position that fumes from the vent cannot enter nor be drawn into any building through a window, door or other opening, including air intakes, or

(iii) when venting Class I product tanks, located in bulk plants or at railway tank car unloading facilities, in a safe manner and as far as practicable horizontally from truck loading or parking facilities, or other likely sources of ignition; and

(c) be firmly supported and protected.

(21) In a vertical or horizontal tank, relief of abnormal internal pressure shall be provided by,

(a) a self-closing manhole cover;

(b) a manhole cover so constructed that it lifts when the internal pressure exceeds a predetermined amount; or

(c) a system of emergency relief-valving.

(22) In a vertical tank the relief of abnormal internal pressure may also be provided by means of a weakened seam or joint in the roof.

(23) Every bulk-storage tank shall be so located that,

(a) no part of a tank referred to in column 1 of Table 1 of this subsection shall be closer to the dike centre line or to the nearest building or to the property line than the distances prescribed opposite thereto in columns 2 and 3; and

(b) any two tanks referred to in column 1 of Table 2 of this subsection that are installed above ground shall have clear air space between them not less than the distance prescribed opposite thereto in column 2.

TABLE 1

LOCATION OF BULK-STORAGE TANKS ABOVE GROUND

ITEM No.	COLUMN 1	COLUMN 2	COLUMN 3
	Tank Capacity (gallons)	Minimum Distance Tank Shell to Centre Line of Dike (feet)***	Minimum Distance Tank Shell to Nearest Building or to Property Line
1	Up to 1,000	one-half the tank height*	10**
2	1,001 to 50,000	} 10 feet or one-half tank height, whichever is greater. }	10
3	50,001 to 100,000		15
4	100,001 to 500,000		30
5	500,001 to 1,000,000		40
6	over 1,000,000		50

*When diking necessary for compliance with clause (26) (b).

**For Class II products may be 3 feet.

***Where the distance required by column 2 exceeds that required by column 3, the column 2 distance shall prevail.

TABLE 2
SPACING BETWEEN BULK-STORAGE TANKS ABOVE GROUND

ITEM NO.	COLUMN 1	COLUMN 2
	Tanks	Minimum Clear Air-Space
1	Tanks of equal capacity neither of which exceeds 50,000 gallons.	3 feet.
2	Tanks of unequal capacity and only one of which exceeds 50,000 gallons.	One-half the diameter of the smaller tank but not in any event less than 3 feet.
3	Tanks of equal capacity each exceeding 50,000 gallons.	One-half the diameter of either tank.
4	Tanks of unequal capacity each exceeding 50,000 gallons.	One-half the diameter of the smaller tank.
5	A tank of any capacity used for storage of any gasoline or associated product, and a tank of any capacity used for storage of crude petroleum.	The greater of (a), the distance prescribed under items 1, 2, 3 or 4; or (b), the full diameter of the smaller tank (where the tanks are of unequal capacity).

(24) Equipment for unloading tank cars may be located in accordance with good engineering practice and no set-back from the property line is required.

(25) Subject to subsection 8 (5), no storage tank shall be,

- (a) inside a building, unless the tank is a Class II or Class III product supply tank; or
- (b) under a building.

(26) Where an above-ground bulk-storage tank is used or is capable of being used for the storage of Class I products, Class II products or Class III products, and in the event of an escape of Class I products, Class II products or Class III products from the tank, the products are likely to flow in a manner that would,

- (a) create a hazard to public health or safety;
- (b) contaminate any fresh water source or waterway;
- (c) interfere with the rights of any person; or
- (d) allow entry of product into a sewer system, or underground stream or drainage system,

the above-ground bulk-storage tank shall be diked in accordance with subsections (27), (28) and (29).

(27) Every dike shall consist of,

- (a) natural ground conformation;
- (b) bonded masonry;
- (c) concrete; or
- (d) earthwork, conforming to subsection (29).

(28) Every dike shall,

- (a) be impervious to gasoline or associated products and designed and maintained to be liquid tight;
- (b) be of solid, uninterrupted construction without any openings except openings that conform to subsection (30); and
- (c) have dimensions that will ensure that the volume of liquid it will contain is equal to,

(i) where the dike contains one tank, 110 per cent of the capacity of the tank, or

(ii) where the dike contains more than one tank, the capacity of the largest tank plus 10 per cent of the aggregate capacity of all the other tanks, or 110 per cent of the largest tank, whichever is greater.

(29) A dike shall,

- (a) where it is of earthwork construction,
 - (i) have a flat top not less than two feet wide,
 - (ii) have a height of not less than two feet,
 - (iii) be sloped in such a manner as to ensure the stability of the dike, and,
 - (iv) be protected against erosion; or
- (b) where it is of bonded masonry or concrete construction, have a minimum height of at least twelve inches.

(30) Where it is necessary to pass piping through or under a dike, the passage shall be designed, constructed and maintained to prevent the seepage of gasoline or associated products from the diked area.

(31) Except as permitted by subsection (30), every pipe traversing a dike shall pass under the dike, at least three feet below its base, or, where this is not practicable, the pipe shall pass over the dike.

(32) Combustible materials of any nature, exclusive of walkways, shall be at all times kept cleared away from,

- (a) the space within the dike;
- (b) the sides and top of the dike;
- (c) the area extending under or around an undiked above ground tank for a minimum distance of fifteen feet from the shell of the tank; and
- (d) dispensing facilities, tank truck loading or unloading facilities and underground tank fill pipe and gauge pipe locations for a minimum distance of fifteen feet.

(33) Subject to subsections 9 (3) and (5), facilities shall be provided to permit speedy removal of accumulated surface water that would reduce the fluid volume capacity of a dike, and provision shall

be made for such facilities to be locked in the closed position when not engaged in a supervised draining operation.

(34) Where the aggregate capacity of the bulk-storage tanks at a bulk plant exceeds 120,000 gallons of products of any class, the plant, or so much thereof as is occupied by the tanks and diking, shall be so located that the tanks and diking are entirely surrounded by continuous, strong fencing and gates, conforming to the specifications set forth in subsections (35) and (36).

(35) The fencing shall,

- (a) be not less than six feet high;
- (b) be of firmly meshed metal wire,
 - (i) of a gauge not smaller than USSMSG No. 9 for steel, or equivalent strength for other metals, and
 - (ii) so fabricated that mesh openings shall not have sides greater than six inches; and
- (c) be rigidly supported by substantial posts securely embedded in the ground at appropriate intervals.

(36) There shall be at least two gates, located as remote from each other as practicable, and each gate shall,

- (a) conform to the requirements of subsection (35); and
- (b) be equipped with such devices as will ensure that the gate is securely closed when required by subsection (45).

(37) Gasoline and associated products shall not be taken out of a bulk storage tank by any method that increases the internal pressure within the tank. R.R.O. 1980, Reg. 439, s. 6 (11-37).

(38) To reduce the likelihood of product mixing, such as gasoline in fuel oil,

- (a) plans of storage tank, piping and pumping layouts shall be available within divisional or regional offices;
- (b) all above ground valves shall be permanently marked to provide product identification;
- (c) all above ground storage tanks shall be permanently marked, to identify the product they contain, on at least two sides, in a size to ensure easy legibility from at least fifteen feet or from outside the dike, whichever distance is greater; and
- (d) where the content of above ground pipelines cannot otherwise easily be determined, such lines shall be marked at reasonable intervals to provide product identification. R.R.O. 1980, Reg. 439, s. 6 (38); O. Reg. 436/82, s. 5 (1).

(39) Markings required under subsection (38),

- (a) on tanks, may be of any colour if the colour is on a contrasting background and does not conflict with the colours set forth in subsection 5 (47);
- (b) on the sides or ends of tanks, shall be situated to provide clear identification both to operating and to fire-fighting personnel;
- (c) on valves, shall conform to the description set forth in subsections 5 (47) and (48);
- (d) on lines, may be of any colour or shape not in conflict with subsection 5 (47); and
- (e) shall be maintained to be clearly legible at all times.

(40) At all times when gasoline or associated product is being received, or loaded into conveyances, or handled at a bulk plant or delivered from a bulk plant, a person competent to undertake the operation shall be in constant immediate attendance at the specific place where the operation is being controlled, and the person shall take all possible steps to eliminate spillage, and to ensure immediate safe disposal of spilled product when a spill occurs.

(41) When an operator has reason to believe that the vent is obstructed, the operator shall cease transferring product and shall report the circumstances to the person having the care and custody of the tank or, where the operator is unable to contact that person, the operator shall report the circumstances to his or her supervisor.

(42) Subject to subsection (43), to facilitate early detection of hidden leaks, the operators of bulk plants and of other facilities having above ground tanks shall,

- (a) ensure the tanks are gauged or dipped at least once weekly;
- (b) maintain for each tank a permanent record of gauge or dip readings;
- (c) reconcile gauge or dip readings weekly with records of receipts and deliveries; and
- (d) retain the records required by clause (b) for at least two years.

(43) Where the requirements of subsection (42) are not considered practicable, the owner of such facilities shall file with the Ministry an alternative procedure that shall not be implemented until it has been approved by the Director.

(44) When a leak is found or suspected in an above-ground storage tank, the operator or other person responsible for the tank shall report immediately to the owner of the facility who shall,

- (a) take prompt action to stop the leak; and
- (b) forward all available details to the Fuels Safety Branch as soon as is practicable but not later than twenty-four hours after receiving the report of the operator or other person.

(45) Subject to subsection (46), at all times when a bulk plant that is required to be fenced is not in actual operation, or is without the attendance of any person competent to undertake operations, all gates and other modes of ingress shall be securely closed and locked and in a bulk plant that is not fenced, all tank valves or end-of-line valves in the plant shall be securely fastened in the closed position by locks.

(46) Subsection (45) does not apply to remotely controlled bulk plants, nor does the locking of valves required by subsection (45) apply in those plants where shutting off and locking of the electrical power effectively prevents the withdrawal of product.

(47) Tank vehicle and tank car loading or unloading facilities shall be separated from above-ground storage tanks and buildings by a distance of at least ten feet measured horizontally.

(48) Equipment, including piping, pumps, and meters, used for the transfer of Class I products between storage tanks and the loading rack facilities shall not be used for the transfer of Class II or Class III products.

(49) Valves used for the final control when filling tank vehicles with Class I or Class II products shall be of the self-closing type and shall be manually held open except where automatic means are provided for shutting off the flow when the vehicle is full or after filling of a preset amount.

(50) Filling through an open dome into the tank of tank vehicles or tank cars with a Class I product or into tank vehicles or tank cars that contained a Class I product on their previous loading, shall be

through a downspout that terminates near the bottom of the tank, and that is shaped to minimize turbulence.

ABOVE GROUND FACILITIES

(51) To ensure compliance with subsections 5 (39) and (40), every facility where loading of a Class I product through an open dome of a tank vehicle or tank car or where loading a Class II product into a compartment that previously contained a Class I product may occur, shall be equipped with a bond wire electrically connected to the fill stem or piping.

(52) The bond wire referred to in subsection (51) shall be connected to the rails in the case of tank car facilities.

(53) The bond wire referred to in subsection (51) shall be capable of being clipped to the bonding clip on the tank vehicle in the case of tank vehicle facilities.

(54) The owner of an above-ground facility shall ensure that the installation of the above-ground facility complies with the installation requirements of this Regulation. R.R.O. 1980, Reg. 439, s. 6 (39-54).

(55) Where a loading facility is installed or where a loading facility is modified with equipment for the purpose of filling a tank vehicle by bottom loading or any other method where the liquid level in the compartment of the vehicle cannot be observed and controlled by the loader, the loading facility shall not be used in loading a tank vehicle by any method referred to above unless the installation and equipment is in accordance with the applicable requirements of the 1981 edition of Standard PTT-101 listed in "Titles of Appliances, Accessory and Component Standards Authorized for Use in Ontario Under the *Gasoline Handling Act*". O. Reg. 436/82, s. 5 (2).

(56) No loading facility shall be employed in the filling of tank vehicles by a method referred to in subsection (55) unless the loading facility conforms to the applicable requirements of the standard referred to in subsection (55).

(57) Where a tank vehicle is to be filled by a method referred to in subsection (55), the operator of the bulk plant shall ensure that no gasoline or associated product is loaded from the loading facility to the tank vehicle unless the automatic overflow protection system installed on the loading facility will receive and respond to the signals from the automatic overflow protection system installed on the vehicle. R.R.O. 1980, Reg. 439, s. 6 (56, 57).

UNDERGROUND STORAGE TANKS

7.—(1) This section applies to underground storage tanks used for storing gasoline and associated products, including requirements for their design, construction, installation and location and the manner of the operation of such tanks and their associated equipment.

(2) Tanks shall be constructed, tested and marked in accordance with approved specifications and shall be approved.

(3) Without prior authority from the Director, no underground tank consisting of more than one compartment may be installed.

(4) Where a tank is delivered with its shell damaged it shall be rejected by the owner.

(5) Where a steel tank is delivered with its coating damaged, the coating may only be repaired with the approved kit provided in accordance with ULC Standard S603.1.

(6) All piping associated with gasoline or associated products underground tanks shall conform to approved standards or test reports, and shall be firmly supported and protected by substantial barriers to protect it from vehicle impact or other physical damage. R.R.O. 1980, Reg. 439, s. 7 (1-6).

(7) Protection from external corrosion shall be provided for,

(a) above-ground suction piping by painting, wrapping, coating or other approved manner;

(b) all underground steel suction and pressure piping, in accordance with Underwriters' Laboratories of Canada Standard S603.1M. R.R.O. 1980, Reg. 439, s. 7 (7); O. Reg. 436/82, s. 6 (1).

(8) All steel underground tanks shall be installed, protected against corrosion and monitored by the owner in accordance with subsection (39) and the procedures and schedule set forth in the Underwriters' Laboratories of Canada Standard ULC S603.1M. O. Reg. 436/82, s. 6 (2).

(9) Where a tank is installed in accordance with subsection (8), it shall be so installed that the new tank and its connected piping and corrosion protection system is in permanent physical and electrical isolation from any other existing underground facilities, including storage tanks, piping and electrical conduits.

(10) All underground fibreglass reinforced plastic (FRP) tanks shall be installed in accordance with the approved installation instructions and subsection (39).

(11) Subject to subsection (45), all piping that is connected to an underground tank shall be connected on the top of the tank and shall be so installed and maintained that,

(a) it is without traps or pockets;

(b) where it is used with a suction system, it is sloped toward the tank; and

(c) where it is used with a submersible system, it has no part below the top of the tank.

(12) A minimum slope, towards the tank, of 1/8 inch per foot shall be maintained in suction piping and where necessary the tank depth shall be increased accordingly.

(13) Vent piping shall not extend into the tank more than one inch, except where the vent is equipped with a vent alarm.

(14) Vent openings shall be of cross-sectional area sufficient to permit free escape of air and vapour when the filling of the connected tank or tanks is being performed at maximum intake capacity. R.R.O. 1980, Reg. 439, s. 7 (9-14).

(15) In the case of vents equipped with a weather-proof hood, the effective opening shall be not less than that of a pipe of two inches internal diameter and a screen used on such a vent shall be not less than 1/8 inch mesh size. O. Reg. 436/82, s. 6 (3).

(16) Subject to subsections (17) and (18), every tank shall be individually vented.

(17) A battery of tanks containing gasoline or associated products of the same class may be individually vented into a common header.

(18) Where a common header is used under subsection (17),

(a) the common header shall be at least one pipe size larger than the largest individual vent pipe connected to it;

(b) no individual vent pipes shall be connected to the common header at a point lower than one foot above the top of any fill pipe in the same system; and

(c) to permit segregation of individual lines for test purposes, the installation shall be so designed that the unions are above ground and accessible for testing.

(19) Every common header and every individual vent pipe not connected into a common header shall,

- (a) be provided with a weather-proof hood or a pressure-vacuum vent;
- (b) terminate in open air,
- (i) not less than seven feet for Class II products, and twelve feet for Class I products, above general grade level,
 - (ii) outside buildings, in such a position that fumes from the vent cannot enter or be drawn into any building through a window, door or other opening, including air intakes, and
 - (iii) when venting Class I product tanks, located in bulk plants or at railway tank car unloading facilities, in a safe manner and as far as practicable horizontally from truck loading or parking facilities, or other likely sources of ignition;
- (c) be firmly supported and protected;
- (d) be located not less than twenty-five feet horizontally from the nearest dispensing pump when venting Class I products; and
- (e) not enter a building.
- (20) The intake end of a fill pipe for an underground tank shall not be located,
- (a) inside any building; or
 - (b) at a distance less than five feet measured horizontally from any door, window, basement opening, or cellar opening, fire-escape or other mode of exit from a building.
- (21) The intake end of a fill pipe for an underground tank shall be equipped with a tight-fitting cap that shall be kept closed except during filling operations and, where the fill pipe extends above ground level, it shall be protected against physical damage, and where it is below or at ground level, shall be set in,
- (a) a metal box;
 - (b) a concrete box; or
 - (c) a box of metal and concrete construction,
- equipped with a cover, and so designed, installed and maintained that it will not transmit traffic loads to the tank.
- (22) Subsections (20) and (21) apply to a gauging pipe where it is separate from the filling pipe, and when one pipe fulfills both purposes, subsection (21) applies to both filling and gauging operations.
- (23) Equipment for loading or unloading tank cars may be located in accordance with good engineering practice and no setback from the property line is required. R.R.O. 1980, Reg. 439, s. 7 (16-23).
- (24) A storage tank installed,
- (a) underground, shall be,
 - (i) not less than three feet from a building or street line,
 - (ii) not less than two feet from an adjacent tank,
 - (iii) so located with respect to existing building foundations and supports that the loads carried by the foundations or supports could not be transmitted to the tank, and
 - (iv) located in relation to a property line not closer than five feet measured horizontally from the property line; and
 - (b) underground at any retail outlet or private outlet, shall have a capacity that is not greater than 50,000 litres. R.R.O. 1980, Reg. 439, s. 7 (24); O. Reg. 568/88, s. 1.
- (25) Every underground bulk-storage tank shall be so installed that its top is below the level of any piping connected to the tank.
- (26) An underground tank that is not likely to be subjected to vehicular traffic shall be so installed that its top is at least two feet below grade level.
- (27) Subject to subsection (28), when an underground tank referred to in subsection (25) is, or is likely to be, subjected to traffic, the top of the tank shall be at least three feet below grade level.
- (28) In lieu of the depth referred to in subsection (27), eighteen inches of sand plus six inches of reinforced concrete or eighteen inches of sand plus eight inches of unreinforced concrete may be used.
- (29) The concrete slabs referred to in subsection (28) shall extend at least one foot horizontally beyond the outline of the tank in all directions.
- (30) Where, by reason of solid rock substratum, or for any other reason acceptable to the Director, it is not practicable to comply with subsection (26) or (27) a tank may be so installed that,
- (a) at least 75 per cent of its mass is below ground level; and
 - (b) the part above ground level is provided with an earth covering at least two feet thick.
- (31) With prior authorization from the Director, in special cases the 75 per cent referred to in clause (30) (a) may be reduced to 50 per cent, in which case the two feet referred to in clause (30) (b) shall be increased to three feet.
- (32) To reduce the likelihood of product mixing, such as gasoline in fuel oil,
- (a) plans of storage tank, piping and pumping layouts at licensed facilities shall be available within divisional and regional offices; and
 - (b) all valves in above-ground piping associated with underground tanks and the fill pipes of all underground storage tanks shall be permanently marked to indicate the product in each valve and tank.
- (33) The markings on valves and fill pipes referred to in clause (32) (b) shall conform to the requirements of subsections 5 (47) and (48) and shall be maintained to be clearly legible at all times.
- (34) At all times when gasoline or associated product is being received, or loaded into conveyances, or handled at a bulk plant or delivered from a bulk plant, a person competent to undertake the operation shall be in constant immediate attendance at the specific place where the operation is being controlled.
- (35) The person referred to in subsection (34) shall take all possible steps to eliminate spillage, and to ensure immediate safe disposal of spilled product when a spill occurs.
- (36) At all times when an underground bulk plant that is fenced and is not in actual operation, or is without the attendance of any person competent to undertake operations, all gates and other modes of ingress shall be securely closed and locked and in a bulk plant that is not fenced, all fill and gauge pipe caps in the plant shall be securely fastened in the closed position by locks.
- (37) In remotely controlled and in unfenced bulk plants the elec-

trical power to pumps and controls shall be shut off and locked when the plant is unattended.

(38) When an operator has reason to believe that the vent is obstructed, the operator shall cease transferring product and shall report the circumstances to the person having the care and custody of the tank or, where the operator is unable to contact that person, the operator shall report the circumstances to his or her supervisor. R.R.O. 1980, Reg. 439, s. 7 (25-38).

(39) The installation of underground storage tanks and lines and dispensing equipment in all new gasoline and associated product storage and handling outlets, including marinas, and in all such outlets being excavated for repair or replacement shall conform to the following requirements:

1. Where a steel tank is to be installed underground,

- (a) it shall be inspected at the time of installation and where necessary, corrective action shall be taken under subsections (4) and (5);
- (b) corrosion protection shall be provided in accordance with subsection (7);
- (c) the tank shall be carefully lowered into the excavation by use of lifting lugs and hooks and, where necessary, by the use of spreader bars, but no chains or slings shall be used around the tank and no method of handling shall be used that might result in damage to the protective coating of the steel tank;
- (d) after the tank has been positioned in the excavation, and subject to the conditions of clause (f) the tank and the vent shall each be subjected to a recorded 5 psig pressure test with air or nitrogen, and
 - (i) tank and vent line shall retain the pressure for a minimum of two hours after the source of pressure has been removed,
 - (ii) where a pressure drop is recorded, the tank or vent lines, as the case may be, shall be inspected to locate every source of leakage,
 - (iii) all vent line leaks shall be repaired and a leaking tank shall be rejected,
 - (iv) the pressure tests shall be continued until the requirements of subclause (i) have been met,
 - (v) the owner or the owner's authorized representative shall certify on the record of the pressure test that he or she has witnessed the pressure test and the records shall be retained by the owner for a period of two years from the date of the test and shall be available for inspection, and
 - (vi) the pressure required in this clause shall be measured by an instrument calibrated in increments not greater than one-tenth of one pound per square inch;
- (e) the tank shall be set on clean sand not less than six inches in depth and the tank shall be backfilled with clean sand that is free of cinders and stones and that is compacted in not greater than twelve-inch layers to maximum density, in a thickness not less than twelve inches on each side of the tank and at each end of the tank and above the tank;
- (f) where the tank must be held in place with a petroleum product while being pressure tested in accor-

dance with clause (d), no product shall be placed in the tank until,

- (i) the fill pipe and a vent line complying with subclause (19) (b) (i) have been installed in the tank, and
 - (ii) all other openings have been plugged,
- and the pressure shall be applied using nitrogen;
- (g) where high water is anticipated, the tank shall be anchored,
 - (i) by use of a concrete slab under the tank and anchor straps,
 - (ii) by use of ground anchors, or
 - (iii) by use of a concrete slab above the tank;
 - (h) the concrete slabs referred to in clause (g) shall be of reinforced concrete and the size of the slabs shall be determined on the basis of tank size, ground cover, water-table elevation and the calculated up-lift stress of the tank when empty;
 - (i) the tank shall not be placed in direct contact with a concrete slab but shall be separated from any slab by the use of a minimum of six inches of sand, or an inter-layer of composite materials, as the case may be;
 - (j) the strength of the anchor straps and ground anchors referred to in clause (g) shall be calculated for the stresses indicated in clause (h) and they shall be installed in such a manner that they do not interfere with the surface of the tank and the anchor straps shall not be tighter than handtight; and
 - (k) if spillage occurs when a steel tank is being filled with product in accordance with clause (f), all soil that has been contaminated by the spilled product around any tank shall be replaced and any damage to the tank coating shall be repaired.
2. Where an FRP tank is to be installed underground,
- (a) it shall be inspected at the time of installation and, where necessary, corrective action shall be taken;
 - (b) the backfill material shall be pea gravel or washed crushed stone conforming to the following requirements,
 - (i) pea gravel shall be a naturally rounded aggregate ¼ inch in nominal size and may range in size from ⅛ inch to ¾ inch and shall be clean and free flowing,
 - (ii) crushed stone shall be clean angular material with a particle size of not less than ⅛ inch and not more than ½ inch diameter;
 - (c) the tank shall be carefully lowered into the excavation by use of lifting lugs and hooks and, where necessary, by the use of spreader bars, but no chains or slings shall be used around the tank and no method of handling shall be used that might result in damage to the surface of the tank;
 - (d) after the tank has been positioned in the excavation, and subject to the conditions of clause (f), the tank and the vent shall each be subjected to a recorded 5 psig pressure test with air or nitrogen, and,

- (i) tank and vent line shall retain the pressure for a minimum of two hours after the source of pressure has been removed,
 - (ii) where a pressure drop is recorded, the tank or vent lines, as the case may be, shall be inspected to locate every source of leakage,
 - (iii) all vent line leaks shall be repaired and a leaking tank shall be rejected,
 - (iv) the pressure tests shall be continued until the requirements of subclause (i) have been met,
 - (v) the owner or the owner's authorized representative shall certify on the record of the pressure test that he or she has witnessed the pressure test and the records shall be retained by the owner for a period of two years from the date of the test and shall be available for inspection, and
 - (vi) the pressure required in this clause shall be measured by an instrument calibrated in increments not greater than one-tenth of one pound per square inch;
- (e) the tank shall be set on not less than 12 inches of pea gravel, or crushed stone as the case may be, and in accordance with the approved installation instructions;
- (f) where the tank must be held in place with a petroleum product while being pressure tested in accordance with clause (d), no product shall be placed in the tank until,
- (i) the fill pipe and a vent line complying with subclause (19) (b) (i) have been installed in the tank, and
 - (ii) all other openings have been plugged,
- and the level of the product in the tank shall not vary from the level of the backfill by more than 24 inches, and the pressure shall be applied using nitrogen;
- (g) where high water is anticipated, the tank shall be anchored,
- (i) by use of a concrete slab under the tank and anchor straps,
 - (ii) by use of ground anchors, or
 - (iii) by use of a concrete slab on top of the tank;
- (h) the concrete slabs referred to in clause (g) shall be of reinforced concrete and the size of the slabs shall be determined on the basis of tank size, ground cover, water-table elevation and the calculated up-lift stress of the tank when empty;
- (i) the tank shall not be placed in direct contact with a concrete slab but shall be separated from any slab by at least 12 inches of bedding material;
- (j) the strength of the anchor straps and ground anchors referred to in clause (g) shall be calculated for the stresses indicated in clause (h) and they shall be installed in such a manner that they do not interfere with the surface of the tank and the anchor straps shall not be tighter than handtight; and
- (k) if spillage occurs when an FRP tank is being filled with product in accordance with clause (f), all soil that has been contaminated by the spilled product around any tank shall be replaced.
3. Underground steel lines connected to a tank,
- (a) shall be fabricated of new, approved pipe;
 - (b) shall be installed with at least 150-pound standard screwed, or schedule 40 welded, fittings;
 - (c) shall have all unions of the ground-joint type;
 - (d) shall have swing joints or approved underground flexible connectors installed in all piping at the tank except piping that terminates at or above grade at a point that is vertically above its point of connection to the tank, and threaded 45° elbows shall not be used in swing joints;
 - (e) shall not contain close nipples or right and left hand threaded couplings or street elbows;
 - (f) shall have all threaded connections made with approved connectors and approved pipe sealing compound, and have all welded connections made by certified welders;
 - (g) shall, where the lines pass through concrete, be protected from longitudinal stress by pipe sleeves, swing joints or other means;
 - (h) where made of galvanized pipe shall not have welded joints;
 - (i) shall be installed in a manner and at a depth to ensure that the underground lines are protected against expansion, contraction, vibration, settling and stresses from vehicular traffic;
 - (j) shall be bedded on six inches of clean sand and shall be supported throughout their length in a manner that will not cause damage to the lines;
 - (k) before being connected to the tank shall be pressure tested with air, or hydraulically, to at least 50 psig or one and one-half times the maximum operating pressure, whichever is the greater, but no pressure test performed with air shall exceed 100 psig, and where tested,
 - (i) with air, the lines shall be soaped and shall retain the pressure for a minimum of two hours after the source of pressure has been removed,
 - (ii) with fluid, the lines shall retain the pressure for a minimum of two hours after the source of pressure has been removed, and
 - (iii) the pressure shall be measured by an instrument calibrated in increments not greater than one-half of one pound per square inch;
 - (l) shall be protected in accordance with subsection (7);
 - (m) that have been pressure tested and proven tight shall be backfilled with at least six inches of clean sand and the backfilling shall be compacted in layers not greater than six inches; and
 - (n) shall have the test record sheets for the test in clause (k) certified by the owner or the owner's authorized representative that the lines have been proven tight and the records shall be retained by the owner for a

- period of two years from the date of the test and shall be available for inspection.
4. Underground FRP pipe connected to a tank,
 - (a) shall be fabricated of new approved pipe and fittings;
 - (b) shall be installed only by trained personnel supervised by persons instructed by the pipe manufacturer;
 - (c) shall be installed in accordance with the manufacturer's approved installation instructions and this Regulation;
 - (d) having steel components shall have all exposed steel protected from corrosion by wrapping and coating with materials accepted for the purpose;
 - (e) shall have approved underground flexible connectors with non-corrosive, swivel-type end connections for connecting to the tank except for piping terminating at or above grade directly above its point of connection to the tank;
 - (f) where the lines pass through concrete, shall be protected from longitudinal stress by pipe sleeves, swing joints or other means;
 - (g) shall be installed in a manner and at a depth to ensure that the underground lines are protected against expansion, contraction, vibration, settling and stresses from vehicular traffic;
 - (h) shall be bedded on at least six inches of pea gravel, or washed crushed stone, and shall be so bedded that it is continuously supported throughout its length;
 - (i) before being connected to the underground tank shall be pressure tested with air, or hydraulically, to at least 50 psig or one and one-half times the maximum operating pressure, whichever is the greater, but no pressure test performed with air shall exceed 100 psig, and where tested,
 - (i) with air, the lines shall be soaped and shall retain the pressure for a minimum of two hours after the source of pressure has been removed,
 - (ii) with fluid, the lines shall retain the pressure for a minimum of two hours after the source of pressure has been removed, and
 - (iii) the pressure shall be measured by an instrument calibrated in increments not greater than one-half of one pound per square inch;
 - (j) that have been pressure tested and proven tight shall be backfilled to grade with the material detailed in clause (h); and
 - (k) shall have the test record sheets for the test in clause (i) certified by the owner or the owner's authorized representative that the lines have been proven tight and the records shall be retained by the owner for a period of two years from the date of the test and shall be available for inspection.
 5. Where an underground steel line or an underground FRP line connected to a tank contains a Class I product and is pressure tested hydraulically, all safety precautions required by this Regulation for Class I flammable liquids shall be observed.
 6. To ensure that the final connections are tight, after,
 - (a) a tank has been tested in accordance with clause (d) of paragraph 1 or 2, as applicable;
 - (b) the underground lines have been tested in accordance with clause (k) of paragraph 3 or clause (i) of paragraph 4; and
 - (c) the final connections have been made to the tank,

the entire system shall be subjected to a fifteen minute 5 psig test using an instrument of the type referred to in subclause (d) (vi) of paragraph 1 and by using soap, oil or other acceptable liquid on the final connections.
 7. Where a submerged pump is used, it shall be so controlled that the pressure created does not exceed the safe working pressure for any component of the piping system and the piping system shall be tested in accordance with clause (k) of paragraph 3, and equipped with a safety valve.
 8. Where a safety valve is required, an approved safety valve having a 160°F. maximum fusible link shall be used and no shear point of the safety valve shall be set,
 - (a) higher than; or
 - (b) more than one inch below,

the base of the dispenser.
 9. The owner of a safety valve referred to in paragraph 8 shall ensure that the safety valve is serviced at least once every twelve months and is maintained in good operating condition.
 10. Where a dispenser is connected to a line supplied by a submerged pump the connection shall be by rigid pipe and fittings and a slip joint connection shall not be used. R.R.O. 1980, Reg. 439, s. 7 (39); O. Reg. 136/81, s. 1.
 - (40) Where a dispenser is connected to a line supplied by a submerged pump, a leak detector system acceptable to the Director shall be installed in all new installations and in those installations being excavated for modification or repair of leaking or damaged pressure piping.
 - (41) A leak detector system shall be tested at least once each twelve months and maintained in good operating condition.
 - (42) The owner of underground facilities shall be responsible for the inspection of the installation of the underground facilities and for taking all precautions reasonable in the circumstances to ensure that the installation requirements of this Regulation are met.
 - (43) The owner of a marina shall ensure that every gasoline dispensing facility is firmly installed on shore, or on a strong dock, wharf or pier.
 - (44) Where practicable, the provisions of subsection (11) regarding connected piping shall apply and where compliance with subsection (11) is not practicable, and the tank must be located at an elevation above the dispensing unit, there shall be installed in the line at or near the exit from the tank a suitable check valve that will prevent syphoning or pressure action from the tank in the event of line rupture.
 - (45) At a marina, no Class I or Class II product storage tank shall be located closer than fifteen feet horizontally from the normal annual high-water mark and all such tanks shall be anchored to prevent dislodgement in the event of flood conditions, and dispensing nozzles shall be of the type identified in clause 8 (20) (a) or (b) without the latch-open device and shall be approved.

(46) Pipe lines attached to piers, wharves or docks shall be protected from damage and shall be provided with an easily accessible valve to shut off fuel supply at or within six feet of the approach to the pier, wharf or dock.

(47) Tank truck and tank car loading and unloading facilities associated with underground tanks shall conform to the requirements of subsections 6 (47), (48), (49), (50), (51), (52), (53), (55) and (56).

(48) Where a tank vehicle is to be filled by bottom loading or any method where the liquid level in the compartment cannot be observed and controlled directly by the loader, the operator of the bulk plant shall ensure that no gasoline or associated product is loaded from the loading facility to the tank vehicle unless the automatic overflow protection system installed on the loading facility will receive and respond to the signals from the automatic overflow protection system installed on the vehicle. R.R.O. 1980, Reg. 439, s. 7 (40-48).

(49) As of the 1st day of January, 1991, all underground unprotected steel tanks and all underground steel suction and pressure piping installed prior to the 1st day of May, 1974, and not protected from external corrosion by wrapping, coating, galvanizing or cathodic protection shall not be approved.

(50) The owner of an underground unprotected steel tank and underground steel suction and pressure piping referred to in subsection (49) shall by the 1st day of January, 1991, either remove the tank and piping from the ground or upgrade the tank and piping in accordance with subsection (52).

(51) An underground steel tank installed with taping as corrosion protection in accordance with ULC S603.1 shall be approved unless anode monitoring records indicate that the tank is not protected, and where such records are not available, the tank shall not be approved.

(52) An underground unprotected steel tank and piping referred to in subsection (49) may be upgraded by,

- (a) replacement;
- (b) lining the tank in accordance with Branch Standard GH 10;
- (c) corrosion protection provided by impressed current; or
- (d) any other method acceptable to the Director,

and any tank or piping upgraded in accordance with this subsection shall be approved.

(53) When an owner removes or replaces a leaking tank the owner shall remove or upgrade the owner's remaining underground unprotected tanks and associated piping on the same property within 180 days.

(54) Subsection (52) does not apply to an unprotected tank used as a waste oil tank or a bulk plant.

(55) Where an owner of underground tanks undertakes a major renovation associated with the tanks, the owner shall remove or upgrade all of the owner's unprotected tanks and associated piping during such renovations except as provided for in subsection (57) or (58).

(56) An owner of underground unprotected steel tanks or piping referred to in subsection (49) shall establish a program to remove the equipment or upgrade it in accordance with subsection (52) and such program shall take into consideration the age of the tanks, the soil conditions, the location of the tanks relative to potable water sources as shown in the approved map referred to in the publication set out in subsection 10 (4) and the owners contractual obligations.

(57) In establishing a program under subsection (56) priority shall be given to underground unprotected steel tanks or suction and pressure piping located at service stations.

(58) Where an underground unprotected tank or group of tanks at one location is installed in benign soil, and the owner submits an engineering report to the Director as evidence thereof, approval for the tank or group of tanks may be granted.

(59) The owner of underground unprotected steel tanks shall report to the Director the number of such tanks still in use as of the 31st day of December in each year until the owner's program is completed and such report shall be submitted by the 1st day of April of the following year. O. Reg. 436/82, s. 6 (4).

OPERATING PROCEDURES

8.—(1) This section applies to the operations of a retail outlet, marina or private outlet, and to a bulk plant where applicable. R.R.O. 1980, Reg. 439, s. 8 (1); O. Reg. 620/88, s. 1.

(2) Each retail outlet storage capacity shall be restricted to,

- (a) not more than 50,000 gallons of Class I products; and
- (b) not more than 20,000 gallons of Class II products. R.R.O. 1980, Reg. 439, s. 8 (2); O. Reg. 620/88, s. 1.

(3) No more than forty-five gallons of a Class I product and 250 gallons of Class II product may be stored above ground at a retail outlet. R.R.O. 1980, Reg. 439, s. 8 (3); O. Reg. 620/88, s. 1.

(4) Subject to subsection (3), where a Class I product is stored above ground at a retail outlet, it shall,

- (a) be contained in approved containers or in containers that comply with subsection (6);
- (b) be located in an area remote from sources of ignition; and
- (c) be protected from physical damage. R.R.O. 1980, Reg. 439, s. 8 (4); O. Reg. 620/88, s. 1.

(5) Despite subsection 6 (25), Class III products may be stored and dispensed inside a building from tanks of not more than 500 gallons individual capacity and not more than 2,000 gallons aggregate capacity if the fill and vent pipes are located outside the building in accordance with subsections 7 (19), (20) and (21), and marked in accordance with subsection 7 (32).

(6) All packaged gasoline and associated products stored above ground shall be stored in closed metal containers or other approved containers distinctly marked with the common name of the container contents, such as "gasoline", "kerosene" or "diesel fuel", as the case may be.

(7) No sale or purchase of any Class I, Class II or Class III product shall be made,

- (a) if prepackaged, in other than containers that are clearly marked with the name of the product they contain and are sealed, in an acceptable leak-proof manner; and
- (b) in transportable containers unless,
 - (i) the containers are clearly marked with the name of the product dispensed into the container,
 - (ii) the transportable container complies with subsection 5 (2), and
 - (iii) the containers are securely closed to prevent leaks or spills. R.R.O. 1980, Reg. 439, s. 8 (5-7).

(8) Every container at a retail outlet shall be kept tightly closed when disconnected from the pumping apparatus and a standard drum or other metal container that is equipped with a pump shall be deemed to be closed only when the connection between the pump

and the container is of a vapour-tight type. R.R.O. 1980, Reg. 439, s. 8 (8); O. Reg. 620/88, s. 1.

(9) At a retail outlet, marina or private outlet, no Class I products shall be stored, dispensed or transferred within a building, other than a building that has been designed and accepted by the local fire prevention authority, as a Class I products storage facility. R.R.O. 1980, Reg. 439, s. 8 (9); O. Reg. 620/88, s. 1.

(10) Subsections (3), (8) and (9) also apply to the storage and movement of empty containers.

(11) No Class I product shall be dispensed from a container having a capacity of less than fifty gallons but more than ten gallons except by use of a barrel pump having a vapour-tight seal. R.R.O. 1980, Reg. 439, s. 8 (10, 11).

(12) Without the use of moveable, completely enclosed pumping equipment approved by the Director, no person shall dispense or transfer a Class I product or knowingly allow a Class I product to be dispensed or transferred, inside a building at a service station, marina or consumer outlet. O. Reg. 436/82, s. 7 (1).

(13) No person shall fill a portable container,

- (a) beyond its nominal capacity; or
- (b) while the container is in a vehicle.

(14) Where used or waste oil is collected,

- (a) in a tank,
 - (i) the tank shall be installed underground outside the building,
 - (ii) the fill pipe shall be tightly capped at all times when not in actual use, and fill pipes connected after the 2nd day of February, 1970 shall be located outside the building,
 - (iii) the tank shall be vented to outside air in accordance with subsection 7 (19), and
 - (iv) the fill pipe and the pipe through which the used or waste oil is removed shall be installed and protected in accordance with subsections 7 (20) and (21); or
- (b) in a container other than an underground tank, the requirements of this Regulation governing Class I products apply to the handling of the used or waste oil and to the container.

(15) Despite subclauses (14) (a) (ii) and (iv), where the used or waste oil is being collected in a building where Class I products are not being handled and where repair work involving sources of ignition is not being conducted, the fill pipe may be located inside the building if it is provided with means acceptable to the Director to prevent emission of petroleum vapours from the fill pipe inlet.

(16) All waste tank fill pipes shall be equipped with a tight fitting cover. R.R.O. 1980, Reg. 439, s. 8 (13-16).

(17) Fixed dispensing equipment within the premises of a retail outlet or other gasoline or associated products outlet shall be installed,

- (a) at a distance of at least ten feet from the limit of any highway as defined in the *Highway Traffic Act*;
- (b) at a distance of at least ten feet from any property line;
- (c) at a distance of at least twenty-five feet from any open flame or any tank, pump, dispensing operation or filling

point for propane or any material so hot as to be likely to cause ignition of Class I or Class II product vapours;

- (d) on a pump island in a retail outlet, private outlet or bulk plant and on a firm base in a marina; and
- (e) a minimum distance of fifteen feet from any opening into a building,

but shall not be installed within any wholly enclosed part of a building. R.R.O. 1980, Reg. 439, s. 8 (17); O. Reg. 620/88, s. 1.

(18) Gasoline and associated products shall be transferred from the tanks or containers in which they are stored to the dispensing equipment only by means of pumping.

(19) Every electrically-operated pump shall have an easily accessible remote control switch.

(20) Every hose through which a Class I or Class II product is dispensed other than a hose through which the product is dispensed manually shall be equipped with a valved nozzle of non-magnetic material so constructed that the valve,

- (a) can be kept open only by manual pressure and closes automatically immediately the manual pressure is released; or
- (b) has a latch-open device as an integral part of the assembly and automatically shuts off when,
 - (i) the gasoline tank is filled,
 - (ii) the valved nozzle falls from the filling neck of the vehicle tank, or
 - (iii) the valved nozzle is subject to rough usage,

and the valved nozzle having such latch-open device shall be of a type tested and certified by a designated testing agency as conforming to an approved specification.

(21) Subsection (20) does not apply to tank truck and similar hoses that are equipped for making tight connections.

(22) Every nozzle of the type referred to in clause (20) (b), when required to be serviced or repaired, shall be serviced or repaired in accordance with the Underwriters' Laboratories of Canada program and shall bear the Underwriters' Laboratories of Canada Rebuilt Label attesting to satisfactory compliance therewith. R.R.O. 1980, Reg. 439, s. 8 (18-22).

(23) Every hose through which a Class I or Class II product is dispensed at a retail outlet or private outlet shall be restricted to a maximum length of fifteen usable feet unless retracting mechanism is used, in which case the maximum hose length shall not exceed twenty usable feet. R.R.O. 1980, Reg. 439, s. 8 (23); O. Reg. 620/88, s. 1.

(24) At a retail outlet or private outlet, no person shall dispense gasoline or an associated product to the fuel tank of a motor vehicle while the engine of the motor vehicle is running. R.R.O. 1980, Reg. 439, s. 8 (24); O. Reg. 620/88, s. 1.

(25) Where a diesel fuel dispenser is more than twenty-five feet from a gasoline dispenser, the restriction of subsection (24) does not apply to the dispensing of diesel fuel.

(26) Subject to subsection (27), no Class I or Class II product shall be dispensed to the fuel tank of a motor vehicle while any part of the motor vehicle or of any vehicle attached to it is on a highway. R.R.O. 1980, Reg. 439, s. 8 (25, 26).

(27) Subsection (26) does not apply to dispensing a quantity of Class I or Class II products, not exceeding five gallons, from a portable container to a motor vehicle immobilized on a highway by reason

of lacking sufficient fuel to enable it to proceed to a retail outlet. R.R.O. 1980, Reg. 439, s. 8 (27); O. Reg. 620/88, s. 1.

(28) No person shall dispense a Class I or Class II product at a retail outlet or other gasoline or associated products outlet unless the person is a competent trained employee authorized by the operator or owner of the outlet, and the operator or owner shall ensure that the employee remains in constant attendance at the motor vehicle when dispensing is being performed with an automatic nozzle. R.R.O. 1980, Reg. 439, s. 8 (28); O. Reg. 620/88, s. 1.

(29) Subsection (28) does not apply to the dispensing of Class I or Class II product at a retail outlet or other gasoline and associated products outlet approved for self-service. R.R.O. 1980, Reg. 439, s. 8 (29); O. Reg. 620/88, s. 1.

(30) No person shall install or use a nozzle with a spout terminal end that has an outside diameter of less than 23.62 millimetres for the purpose of dispensing leaded gasoline at a retail outlet, marina or private outlet. O. Reg. 561/83, s. 1, *part*; O. Reg. 620/88, s. 1.

(31) No operator shall install, provide or use any device at a retail outlet, marina or private outlet that would, when used in conjunction with or attached to a nozzle with a spout terminal end having an outside diameter of 23.62 millimetres or greater, reduce the outside diameter of the nozzle spout terminal end to less than 23.62 millimetres. O. Reg. 561/83, s. 1, *part*; O. Reg. 620/88, s. 1.

(32) No person shall offer for sale or sell a portable container or portable fuel tank for gasoline or naphtha unless the container is approved. R.R.O. 1980, Reg. 439, s. 8 (30).

(33) No person shall offer for filling or fill a container with gasoline or naphtha at a retail outlet, marina or other gasoline or associated products outlet unless the container is in safe condition and is,

- (i) an approved metal or plastic portable container bearing the label of ULC or of CSA, or
- (ii) a portable fuel tank for marine use, or
- (iii) a jerrican bearing the embossed certification marking "CTC-5L", "BTC-5L", "ICC-5L" or "DOT-5L", or
- (iv) a drum bearing the embossed certification marking "CTC", "BTC", "ICC" or "DOT" followed by "5", "5A", "5B", "5C" or "5M". R.R.O. 1980, Reg. 439, s. 8 (31); O. Reg. 561/83, s. 2; O. Reg. 620/88, s. 1.

(34) The special sample containers used in the taking of test samples by an authorized representative of the Government of Canada or of Ontario, by the wholesaler who supplied the product to the retail outlet, or by an analytical chemist whose expert opinion is required with respect to the product, shall be deemed to meet the requirements of this Regulation. R.R.O. 1980, Reg. 439, s. 8 (32); O. Reg. 620/88, s. 1.

(35) Dispensing of Class I products or Class II products at a gasoline or associated products outlet shall be through approved dispensing equipment. R.R.O. 1980, Reg. 439, s. 8 (33).

(36) To facilitate the early detection of an underground leak, the operator of a retail outlet or other facility having an underground tank shall,

- (a) ensure that the tank in other than a bulk plant is gauged or dipped, including a water dip, at least daily, except Sunday for a facility closed on that day;
- (b) ensure that the tank in a bulk plant is gauged or dipped, including a water dip, at least weekly;

(c) maintain a record for each tank to provide a permanent record of gauge, dip and water dip readings;

(d) reconcile gauge or dip readings daily in other than bulk plants with meter readings;

(e) reconcile gauge or dip readings weekly in bulk plants with receipt and issue records;

(f) when the reconciliation required by clauses (d) and (e) shows a possible product loss or when the water dip exceeds two inches, report immediately to the owner of the facility; and

(g) retain all gauge, dip and water dip records for at least two years. R.R.O. 1980, Reg. 439, s. 8 (34); O. Reg. 620/88, s. 1.

(37) Where there is a change in the operator of a retail outlet, the departing operator shall transfer the records referred to in subsection (36) to the incoming operator. O. Reg. 436/82, s. 7 (2); O. Reg. 620/88, s. 1.

(38) When a leak is suspected, or when the Director so requests, the owner of underground tanks or lines shall,

(a) arrange for recorded pressure tests with readings four hours and twelve hours from commencement, on underground tanks and piping at pressures of,

(i) 5 psig maximum for uncovered tanks,

(ii) not less than 5 psig and not more than 10 psig for covered tanks, and

(iii) a maximum of 50 psig or one and one-half times the operating pressure, whichever is greater, but not more than 100 psig, for piping;

(b) when applying pressures in accordance with clause (a), take appropriate measures to guard against the hazards that may be associated with pressure testing where explosive mixtures of gasoline and air may be present;

(c) ensure that all lines are disconnected at the tank prior to application of the line pressure test;

(d) ensure that no pressure test is performed with product in the tank;

(e) where after completion of the pressure tests there is doubt as to whether or not there is a leak, arrange to uncover sufficient surface of the tank or line to permit visual inspection thereof;

(f) arrange for immediate repair or replacement of leaking systems;

(g) take all steps reasonable in the circumstances to recover escaped product and to remove product-contaminated soil before installing a replacement tank or backfilling a repaired line;

(h) report all leaks to the nearest inspector or fire prevention authority as soon as is practicable but no later than twenty-four hours after discovery of the leak; and

(i) ensure that the pressure gauges used in the tests required by this subsection are calibrated in increments not greater than,

(i) one-tenth of one pound per square inch for the tank test, and

(ii) one-half of one pound per square inch for the line

pressure tests. R.R.O. 1980, Reg. 439, s. 8 (35); O. Reg. 436/82, s. 7 (3).

(39) The owner or the owner's authorized representative shall certify on the record that he or she has witnessed all tests and repairs required by subsection (38) and the records shall be retained by the owner for a period of two years from the date of the test and shall be available for inspection.

(40) Where a leak is suspected or where the Director so requests, the owner of above ground tanks or lines shall make the facilities available to test the tanks or lines in a manner acceptable to the Director.

(41) Where monitoring in accordance with subsection 7 (8) indicates inadequate protection against corrosion, immediate corrective measures shall be taken by the owner.

(42) At locations where both attended and self-service facilities are to be operated, no attended island shall be located between the console and any self-serve island.

(43) The console operator's position shall be separated from any accommodation provided for the merchandising of commodities other than gasoline or associated products.

(44) Control equipment for self-serve dispensers shall be of the console type, and

- (a) shall be so interconnected with the dispensing equipment that no delivery of product can be effected until the console operator has set the console controls for each delivery after the customer has arrived at the dispenser;
- (b) shall be equipped with an easily reached single action control that can shut off all dispensers simultaneously in event of an emergency;
- (c) shall be so located that the console operator has an unobstructed view of all dispensers, and can observe the dispensing nozzles regardless of their use position either directly or by use of permanently installed mirrors; and
- (d) shall be located not more than sixty feet from the console and in such a manner that the angle of vision through which the console operator must keep surveillance shall not exceed 140 degrees.

(45) At each self-serve location, there shall be installed a means of two-way communication between the console operator and each dispenser location.

(46) Certified nozzles, without coil retention springs and latch open devices, shall be used and no inanimate object shall be used to hold the nozzle open.

(47) At each self-serve dispenser there shall be prominently displayed a legible sign, approximately 7¼ inches by 3¾ inches, bearing the following warning:

WARNING: TO AVOID SPILLAGE EASE UP ON THE NOZZLE TRIGGER WHEN FILLING THE TOP PORTION OF THE TANK,

and the sign shall be colored "Traffic Sign Black" on a "Safety Yellow" background.

(48) Signs shall be posted at each self-serve station directing all high outline vehicles that could interrupt the line of vision of a console operator to refuel only on the outside of the island farthest from the kiosk. R.R.O. 1980, Reg. 439, s. 8 (36-45).

(49) At a self-serve station, the dispensing equipment shall be so installed that no individual console operator shall be able to activate

more than 12 dispensing operations simultaneously. O. Reg. 436/82, s. 7 (4).

(50) At a self-serve station, the console operator shall,

- (a) remain in constant and immediate attendance at the console while the self-serve equipment is in operation, and shall have no function other than the control of the self-serve operation;
- (b) be a competent trained employee of the station operator and shall be instructed in the recognition of hazards and how to react in emergency situations;
- (c) ensure compliance with clause (13) (b) and subsections (24) and (33) of this section and subsection 9 (2); and
- (d) in the event of a spill or fire, use the master control to shut off all dispensers until the emergency situation has been rectified.

(51) The owner of a self-serve facility shall,

- (a) provide for each console operator a manual that sets forth the company policy on self-serve operation, including,
 - (i) safety requirements,
 - (ii) preventive maintenance,
 - (iii) fire prevention and spill prevention, and
 - (iv) emergency procedures; and
- (b) provide the Director with a reference copy of the manual referred to in clause (a).

(52) Where dispensing equipment for refuelling of vehicles is connected to an above ground tank there shall be,

- (a) on each dispensing system, a positive automatically operated valve to close down the system when the dispenser is not being operated; and
- (b) at the dispenser, a valve conforming to paragraph 8 of subsection 7 (39). R.R.O. 1980, Reg. 439, s. 8 (47-49).

(53) At a retail outlet or other gasoline and associated products outlet, a diesel dispenser shall be identified with the generic name DIESEL and no other trade names shall be used with or added to the word "diesel". O. Reg. 436/82, s. 7 (5); O. Reg. 620/88, s. 1.

FIRE AND OTHER SAFETY PRECAUTIONS

9.—(1) This section applies to the prevention of fire and to other hazards that may be associated with the handling of gasoline and associated products and to the related equipment. R.R.O. 1980, Reg. 439, s. 9 (1).

(2) At bulk plants, retail outlets, marinas and private outlets,

- (a) a person dispensing gasoline or associated products,
 - (i) shall take all precautions necessary to prevent overflow or spillage of the product being dispensed,
 - (ii) shall not knowingly overfill the fuel system after the automatic nozzle shuts off,
 - (iii) shall not draw, or pour, Class I or Class II products from any dispensing equipment in proximity to fire or flame or any item referred to in clause (b) or any material so hot as to be likely to cause ignition of Class I or Class II product vapour, and

- (iv) in the event of spillage, as indicated in subclause (i), shall immediately apply an absorbent to the spilled product; and
- (b) no person shall have in the person's possession within ten feet of the dispensing location any,
 - (i) lighted match,
 - (ii) lighted lighter,
 - (iii) lighted pipe,
 - (iv) lighted cigar, or
 - (v) lighted cigarette. R.R.O. 1980, Reg. 439, s. 9 (2); O. Reg. 620/88, s. 1.

(3) The owners and the operators of bulk plants, retail outlets, marinas and private outlets, and of transportation facilities for gasoline and associated products shall take every possible precaution to ensure that Class I, Class II or Class III products do not escape from storage, distribution or dispensing facilities in such a manner as,

- (a) to create a hazard to public health or safety;
- (b) to contaminate any fresh water source or waterway;
- (c) to interfere with the rights of any person; or
- (d) to allow entry of product into a sewer system or underground stream or drainage system. R.R.O. 1980, Reg. 439, s. 9 (3); O. Reg. 620/88, s. 1.

(4) Adequate, properly vented traps or similar apparatus shall be furnished at any premises at which a violation of subsection (3) could otherwise occur.

(5) No person shall discard any Class I, Class II or Class III product except in properly vented traps or similar safe disposal facilities.

(6) In the event of the escape of any product in the manner described in clauses (3) (a), (b), (c) or (d), or subsection 5 (67), the operator, owner or owner's authorized representative, as the case may be, shall take immediate corrective action and shall notify the nearest inspector as soon as possible and in no case more than twenty-four hours after the loss or spillage.

(7) In the event of the escape of any product from a tank vehicle, tank, piping or any other container used for the handling or storage of gasoline or an associated product, the owner or operator, as the case may be, shall immediately take the necessary action to recover and safely dispose of as much as possible of the escaped product, including any of the product that is temporarily confined within a dike or other containment. R.R.O. 1980, Reg. 439, s. 9 (4-7).

(8) At every retail outlet and private outlet, there shall be on each pump island or at each dispensing position at least one sign,

- (a) not smaller than 8½ inches by 11 inches; and
 - (b) bearing either,
 - (i) the words "No Smoking Within 10 Feet—Turn Ignition Off While Being Refuelled" in letters not less than one inch in height, or
 - (ii) the international "No Smoking—Ignition Off" symbol signs, using symbols at least four inches in diameter as shown in the Appendix. R.R.O. 1980, Reg. 439, s. 9 (8); O. Reg. 620/88, s. 1.
- (9) The signs referred to in subsection (8) shall be coloured,
- (a) for the purpose of subclause (8) (b) (i), in black on yellow

background, the colours to conform to the standard colours "Safety Yellow" and "Traffic Sign Black"; and

- (b) for the purpose of subclause (8) (b) (ii), in red and black on a white background, the colours to conform to the standard "Traffic Sign Black" and "Traffic Sign Red",

and shall be so located that they are visible to all drivers as they approach the pump island or dispensing position.

(10) Where a kiosk is placed within eighteen inches horizontally from the exterior casing of any dispensing equipment, the kiosk shall be approved for a Class I, Division I location as set out in the Ontario Electrical Safety Code made under the *Power Corporation Act*.

(11) Where a kiosk is placed more than eighteen inches and up to twenty feet horizontally from the exterior casing of any dispensing equipment, the kiosk shall be approved for a Class I, Division II location as set out in the Ontario Electrical Safety Code made under the *Power Corporation Act*.

(12) A kiosk shall be designated as a no smoking area when it is located within ten feet of any dispensing location.

(13) No kiosk doorway shall be located within ten feet of any dispensing equipment it faces.

(14) Where any part of a heating, cooling, operating or other appliance or device is installed in a kiosk, the appliance or device and any electrical connections shall be approved for a Class I, Division I location where installed less than four feet from the floor in a kiosk described in subsection (10) and for a Class I, Division II location where installed less than eighteen inches from the floor in a kiosk described in subsection (11).

(15) Subject to the *Occupational Health and Safety Act* and the regulations thereunder, insofar as they apply to industrial processing installations, no fixed dispensing equipment for any Class I or Class II product shall be installed within the confines of any wholly enclosed building.

(16) Class I products shall not be offered for sale, sold or used for cleaning or solvent purposes.

(17) Regardless of location, underground storage tanks for gasoline and associated products that are not in use shall be handled as follows:

1. If the disuse is temporary and will not exceed 180 days, the owner of the tank or tanks shall,
 - (a) notify the chief inspector;
 - (b) arrange for monthly gauging of each tank and maintain a record of such gauge readings, and hold the record available for inspection by the Ministry; and
 - (c) keep locked, when not in use, all fill pipe and gauge pipe covers, dispensing facilities and power controls.
2. If the disuse is temporary and will exceed 180 days, the owner of the tank or tanks shall,
 - (a) notify the chief inspector;
 - (b) empty Class I content tanks and all connected piping and dispensing facilities of all Class I product and,
 - (i) refill the tanks, piping and dispensing facilities with a Class II product, or
 - (ii) insert dry ice into the tank at the ratio of two pounds for each 100 gallons of tank capacity

to ensure the removal of the hazard of an explosion or fire;

reconcile the readings thereof with the dip readings recorded in subclause (a) (i); and

(c) if Class II product is used as referred to in subclause (b) (i), arrange for monthly gauging of each tank and maintain a record of such gauge readings, and keep the record available for inspection by the Ministry; and

(c) if the reconciliation referred to in clause (b) reflects a loss of product or water intrusion, take immediate action to determine and correct the cause of the loss or intrusion. R.R.O. 1980, Reg. 439, s. 9 (21); O. Reg. 136/81, s. 2.

(d) after complying with subclause (b) (i) or (ii) ensure that fill pipe and gauge pipe covers, dispensing facilities and power controls are kept locked.

(22) Where an above ground bulk storage tank is taken out of use for a period not exceeding 180 days, the owner shall,

(a) block the flow in the piping in such a manner as to isolate the disused tank or close and permanently lock the necessary valving to achieve such isolation;

(b) arrange for monthly gauging of the tank and maintain a record of such gauge readings available for inspection; and

(c) before reuse, inspect the tank and perform any necessary tests to ensure the tank is in safe condition for use.

3. When a tank is reactivated for use for the storage of gasoline or associated products after a period of not having been used for that purpose, the owner of the tank shall immediately notify the Director that the tank has been reactivated.

4. If the disuse has exceeded twelve months the owner shall test the tank and lines in accordance with subsection 8 (38) before the tank is reused.

(23) Where the disuse referred to in subsection (22) is to be permanent or cannot be certified to be for less than 180 days, the owner or the owner's representative shall,

(a) empty the tank and all connected piping of fluid content and make the tank and connected piping vapour-free; and

(b) delete the tank marking and substitute the word "EMPTY".

5. The owner of the tank or the owner's authorized representative shall certify on the record that he or she has witnessed all tests and repairs required by this section and the records shall be retained by the owner for a period of two years from the date of the test and shall be available for inspection.

(18) When it is known that an underground tank will not again be used, or where an underground tank has been out of use for five years, whichever comes first, the owner of the tank shall,

(24) Where a property having gasoline or associated products storage tanks is sold or leased, the owner of the property shall inform the purchaser or lessee of the existence of the tank or tanks and shall provide proof to the purchaser or lessee that the tank or tanks comply with subsection (17), (18), (20) or (22), as the case may be. R.R.O. 1980, Reg. 439, s. 9 (22-24).

(25) At every retail outlet or marina, there shall be fire-extinguishing apparatus, comprising at least two extinguishers,

(a) remove any product from the tank and connected piping and dispensing equipment;

(b) remove the tank from the ground, and

(i) remove the piping from the ground; or

(ii) purge the piping of flammable vapours and products and permanently seal the ends of the piping by capping or plugging;

(c) if the soil around and under the tank is contaminated with product, remove such contaminated soil and product;

(d) fill the cavities to grade level with clean permanent fill; and

(e) notify the chief inspector.

(a) suitable for extinguishing gasoline or associated product fires;

(b) so located as to be readily accessible from every part of the retail outlet or marina;

(c) maintained at all times in efficient fire-fighting condition; and

(d) having an effective total rating equivalent to at least 20-B, C. R.R.O. 1980, Reg. 439, s. 9 (25); O. Reg. 620/88, s. 1.

(19) Before disposing of a tank that is not to be reused, the owner of the tank shall render the tank gas-free and shall cut sufficient openings in the tank to render it unfit for further use.

(20) Immediately upon removal from the excavation, an excavated tank shall be made gas-free and care shall be taken not to spill product or sludge from the tank and to recover any product or sludge that may be spilled, and no excavated tank shall be used again underground for the storage of gasoline or associated products. R.R.O. 1980, Reg. 439, s. 9 (9-20).

(26) No fire-fighting equipment other than portable, self-contained approved fire extinguishers shall be installed at a retail outlet without prior approval of the Director. R.R.O. 1980, Reg. 439, s. 9 (26); O. Reg. 620/88, s. 1.

(27) At every private outlet, there shall be fire-extinguishing apparatus comprising at least one extinguisher,

(21) Despite subsection (17), operators of underground storage facilities that are operated on a seasonal basis shall,

(a) at the close of each season of operation,

(i) dip each tank, maintain a record of such dips and hold the record available for inspection for a period of two years from the date of dips, and

(ii) securely fasten all fill pipe and gauge pipe covers, dispensing facilities and power controls;

(b) prior to the start of an operating season dip each tank and

(a) suitable for extinguishing gasoline or associated product fires;

(b) so located as to be readily accessible from every part of the private outlet;

(c) maintained at all times in efficient fire-fighting condition; and

(d) having an effective total rating equivalent to at least 10-B, C. R.R.O. 1980, Reg. 439, s. 9 (27); O. Reg. 620/88, s. 1.

(28) Subject to subsection (29), at every bulk plant there shall be fire-extinguishing apparatus, comprising at least two extinguishers,

- (a) suitable for extinguishing gasoline or associated product fires;
- (b) so located as to be readily accessible from every part of the bulk plant;
- (c) maintained at all times in efficient fire-fighting condition; and
- (d) having an effective total rating equivalent to at least 40-B, C.

(29) Despite subsection (28), in bulk plants where security for fire-fighting apparatus is inadequate because such plants are not required to be fenced in accordance with this Regulation, the total bulk plant fire-extinguisher equipment may be carried on vehicles that are operated by the owner of the bulk plant and that regularly frequent the bulk plant for the purpose of loading or unloading gasoline or associated products.

(30) Every tank truck and every tank-truck trailer combination employed in the transportation of gasoline or associated products shall be equipped with a dry-chemical fire extinguisher or fire extinguishers having a total rating of at least 20-B, C of which at least 4-B, C shall be in or on the cab.

(31) Every vehicle, other than a tank truck or tank-truck trailer combination, employed in the transportation of packaged petroleum products shall be equipped with at least one dry-chemical fire extinguisher having a rating of not less than 4-B. R.R.O. 1980, Reg. 439, s. 9 (28-31).

(32) The person responsible to ensure that fire extinguishing apparatus is provided as required by subsections (25), (27), (28), (30) and (31) shall be the person named on the licence or, in the case of a private outlet, the owner of the private outlet. R.R.O. 1980, Reg. 439, s. 9 (32); O. Reg. 620/88, s. 1.

(33) Every fire extinguisher shall be located on the vehicle in a readily accessible position and shall be maintained in operating condition.

(34) Every fire extinguisher required by this Regulation shall be approved.

(35) The owner of the fire extinguishers referred to in subsections (25), (27), (28), (30) and (31) shall maintain their approval by,

- (a) inspecting and servicing the fire extinguishers at least annually and, in addition, shall have the fire extinguishers inspected and serviced,
 - (i) when the fire extinguishers have been used or otherwise emptied,
 - (ii) when there is evidence of tampering with the fire extinguishers, or
 - (iii) when the fire extinguishers have been impaired, as evidenced by leaking;
- (b) having the fire extinguishers recharged with the recharging materials specified on the extinguisher name plate or with materials certified by Underwriters' Laboratories of Canada or by the Canadian Government Specifications Board as meeting the requirements of the applicable Canadian Government Specifications Board Standard 28-GP-17, 28-GP-20 or 28-GP-71;
- (c) when the recharging or inspection of the fire extinguishers has been completed, having a tag or label, that shall remain

legible for at least one year, affixed to each extinguisher so as to indicate,

- (i) the month and year of the inspection or recharging,
- (ii) the identification of the recharging material used,
- (iii) the initials or special mark of the examiner, and
- (iv) the company identification of the examiner.

(36) A stationary internal combustion engine shall not be installed within the bounds of a bulk plant unless the engine is of an explosion-protected type and a safe installation is made, in accordance with good engineering principles.

(37) Where an internal combustion engine or turbine using a Class I product or a Class II product for fuel is installed for operation within a building at a bulk plant,

- (a) it shall be so located that it is not underneath a tank or within an explosion hazard location;
- (b) the fuel supply tank inside the building shall not exceed forty-five gallons capacity;
- (c) the vent and fill pipes shall conform with subsections 7 (19) and (20); and
- (d) the piping or tubing from the supply tank to the engine or turbines shall conform to the requirements of the Ontario Fuel Oil Code made under the *Energy Act*. R.R.O. 1980, Reg. 439, s. 9 (33-37).

GENERAL ADMINISTRATION

10.—(1) The Fire Marshal, Deputy Fire Marshal, district deputy fire marshals, inspectors and assistants to the Fire Marshal, under the *Fire Marshals Act*, are appointed to assist the Minister in the proper carrying out of the *Gasoline Handling Act* and this Regulation.

(2) In any case where deviation from the requirements of this Regulation may be necessary, special permission in writing shall be obtained from the chief inspector in advance and this special permission shall apply only to the particular installation or equipment for which it is given.

(3) The Canadian Standards Association Testing Laboratories and the Underwriters' Laboratories of Canada are designated as organizations to test equipment used in the handling of gasoline and associated products to specifications approved by the Minister and, where the equipment conforms to the specifications, to place their labels thereon.

(4) The List of Specifications approved by the Minister is contained in "Titles of Equipment, Accessory and Component Specifications Approved for Use in the Province of Ontario Under the *Gasoline Handling Act*".

(5) In hazardous locations as defined in the Ontario Electrical Safety Code, made under the *Power Corporation Act*, all electrical installations shall conform to the requirements of that Code. R.R.O. 1980, Reg. 439, s. 10 (1-5)

(6) Prior to the commencement of construction or modification of,

- (a) a marina or bulk plant; or
- (b) a retail outlet or other outlet where dispensing is by the mode commonly known as "self-serve",

the owner of the facility shall submit drawings of the proposed facility or modification to the Director for approval and no work shall

begin without the drawings being approved by the Director. R.R.O. 1980, Reg. 439, s. 10 (6); O. Reg. 620/88, s. 1.

(7) Every retail outlet, marina, private outlet and bulk plant and every vehicle shall be maintained in a safe operating condition by the owner and shall be operated safely, and,

- (a) any leaks that occur shall be repaired;
- (b) any defective equipment or component shall be repaired or replaced;
- (c) all possible action shall be taken to prevent escape or spillage of gasoline, or associated products, during handling operations;
- (d) every person engaged in the installation, maintenance or repair of such facilities or equipment shall ensure that all unconnected tank or pipe openings are effectively plugged or capped to prevent the loss of a product until such time as the tank or pipe openings are connected into the system;

(e) defective dispensing equipment shall be repaired or replaced by a registered contractor. R.R.O. 1980, Reg. 439, s. 10 (7); O. Reg. 436/82, s. 8; O. Reg. 620/88, s. 1.

(8) Where it appears that a fire or explosion has occurred because of the handling or use of gasoline or any associated product at a retail outlet, marina, private outlet or bulk plant or on or adjacent to a tank vehicle, the owner and the operator of the retail outlet, marina, private outlet, bulk plant or tank vehicle shall,

- (a) notify the Director verbally or in writing as quickly as possible and in any event within twenty-four hours of the fire or explosion; and
- (b) on request from the Director or an inspector, supply such additional information as may be required concerning the occurrence. R.R.O. 1980, Reg. 439, s. 10 (8); O. Reg. 620/88, s. 1.

APPENDIX



R.R.O. 1980, Reg. 439, Appendix.

Gasoline Tax Act *Loi de la taxe sur l'essence*

REGULATION 533

GENERAL

RETURNS

1.—(1) On or before the 21st day of each month, every collector shall deliver to the Minister, with respect to the calendar month immediately preceding, a return of taxes collectable and taxes payable by the collector, in which return the collector shall also report,

- (a) quantities of gasoline, aviation fuel and propane on hand, produced, received, consumed, imported, sold and otherwise disposed of by the collector; and
- (b) quantities of gasoline, aviation fuel or propane which are lost on account of shrinkage due to variations in temperature or evaporation. R.R.O. 1980, Reg. 440, s. 1 (1); O. Reg. 105/90, s. 1.

(2) Where a loss occurs due to a cause other than temperature variations or evaporation, the collector shall notify the Minister within thirty days of the occurrence of the loss. R.R.O. 1980, Reg. 440, s. 1 (2).

2.—(1) For the purposes of subsections 4 (1) and 6 (3) of the Act, every importer or collector shall collect,

- (a) from every wholesaler or retailer to whom the importer or collector sells gasoline, aviation fuel or propane, at the time of the sale, an amount as security equal to the tax imposed under section 2 of the Act; and
- (b) from every purchaser to whom the importer or collector sells gasoline, aviation fuel or propane, at the time of the sale, the tax payable under section 2 of the Act.

(2) For the purposes of subsection 4 (2) of the Act, every importer who is a collector shall remit the tax and security collected under subsection (1) and the tax payable by the importer under section 2 of the Act in accordance with section 1.

(3) Every importer who is not a collector shall, on or before the fifteenth day of the month following the month in which the gasoline, aviation fuel or propane was imported into or received in Ontario, remit the tax and security collectable and payable by the importer in respect of the sales of gasoline, aviation fuel or propane under subsection (1) with the statement required by subsection 1 (3) of Regulation 534 of Revised Regulations of Ontario, 1990 (General).

(4) An importer who has complied with subsection 4 (3) of the Act may deduct from remittances required under subsection (3) all amounts paid under clause 4 (3) (a) of the Act in respect of gasoline, aviation fuel or propane imported during the previous month. O. Reg. 105/90, s. 2.

ALLOWANCE TO RETAILERS

3.—(1) A person who applies to the Minister and,

- (a) who is not a collector but is licensed under the *Gasoline Handling Act*; or
- (b) is an employee of a collector who by reason of an agreement between the employee and the collector is held responsible for and must pay the collector for all losses and

shortages incurred with respect to gasoline delivered to the person and sold by the person for the account of the collector,

and collects and pays over the tax under the Act may be paid a refund of 0.21 per cent of the amount by which the amount of tax paid by the person to the supplier of the person on gasoline sold by the person at retail exceeds any amount of tax with respect to which the person is or was or will be entitled to make an application for refund under any other section of the Act or regulations. O. Reg. 685/86, s. 2 (1).

(2) An application for a refund under subsection (1) shall be accompanied by properly receipted invoices covering the gasoline in respect of which the applicant is claiming a refund.

(3) No refund shall be paid if the tax has been paid more than three years before the date on which the application for refund is mailed or delivered to the Minister. O. Reg. 685/86, s. 2 (2).

(4) Each invoice submitted in support of an application under subsection (1) shall clearly show the date upon which the tax was paid in respect of the gasoline and the quantity of such gasoline, and no refund shall be paid in respect of an invoice or invoices on or in connection with which the applicant has misrepresented any material fact.

(5) Where an application for a refund under subsection (1) is supported in whole or in part by an invoice or invoices on or in connection with which the applicant has misrepresented a material fact, the amount of the refund that may be granted by the Minister in respect of the application shall be reduced by the greater of \$5 or 200 per cent of the amount of the refund claimed in respect of the invoice or invoices on or in connection with which such misrepresentation is made. R.R.O. 1980, Reg. 440, s. 3 (3, 4).

UNCOLLECTABLE ACCOUNTS

4.—(1) In this section, "debtor" means a person to whom a collector, importer, wholesaler or retailer has sold gasoline or aviation fuel.

(2) Subject to subsection (3), upon receipt of an application in Form 7 of Regulation 534 of Revised Regulations of Ontario, 1990 made by an applicant who is a collector, importer, wholesaler or retailer, together with such other information as may be required under this section, the Minister may refund an amount on account of tax collectable or payable under the Act that has been remitted by the applicant to the Treasurer or paid over by the applicant to a collector, importer or other supplier of gasoline or aviation fuel for subsequent remittance to the Treasurer, with respect to gasoline or aviation fuel, equal to,

- (a) where all or a portion of the sale price of the gasoline or aviation fuel sold by the applicant has not been paid and has become an uncollectable debt, that portion of the amount remitted or paid over by the applicant on account of tax with respect to the gasoline or aviation fuel that the uncollectable debt bears to the total sale price including the total amount on account of tax; and
- (b) where the gasoline or aviation fuel has been lost or cannot be sold or used by the applicant by reason of destruction, theft or contamination, the amount remitted or paid over by the applicant on account of tax with respect to the gasoline or aviation fuel.

- (3) No refund shall be made under this section where,
- (a) the collectable or uncollectable portion of the debt arising on the sale of the gasoline or aviation fuel referred to in clause (2) (a) has been assigned, with or without recourse, by private contract to another person other than for security purposes; or
 - (b) where the application is with respect to gasoline, the applicant did not hold a valid licence under the *Gasoline Handling Act* at the time of the sale of the gasoline referred to in clause (2) (a) or of the loss of the gasoline referred to in clause (2) (b), as the case may be; or
 - (c) the applicant is otherwise entitled under the Act or the regulations to receive or to apply to receive a refund of or an allowance in compensation for the amount remitted or paid over by the applicant on account of the tax with respect to the gasoline or aviation fuel.

(4) For the purposes of this section,

- (a) a debt is not an uncollectable debt until,
 - (i) the applicant has claimed a deduction for the amount of the debt under paragraph 20 (1) (p) of the *Income Tax Act* (Canada) in the calculation of the applicant's income for a taxation year for the purposes of that Act, and
 - (ii) the deduction referred to in subclause (i) has been allowed by the Minister of National Revenue, by a court on an appeal under Division J of the *Income Tax Act* (Canada) or by a court on an appeal of a previous court decision; and
- (b) a debt shall cease to be an uncollectable debt if the deduction referred to in clause (a) is subsequently denied on an assessment, reassessment or additional assessment of tax or in a determination of the applicant's non-capital loss under the *Income Tax Act* (Canada), or on an appeal referred to in subclause (a) (ii).

(5) An application for a refund under clause (2) (a) shall be accompanied by,

- (a) copies of all invoices in respect of which a refund is being claimed;
- (b) proof that the amount being claimed was remitted to the Treasurer or paid over to a collector, importer or other supplier for subsequent remittance to the Treasurer; and
- (c) proof that the debt in respect of which the refund is being claimed is an uncollectable debt.

(6) An application for a refund under clause (2) (b) shall be accompanied by,

- (a) a copy of any settlement by or written confirmation from an insurance company confirming settlement of any claim for the loss with respect to which the refund is being claimed;
- (b) a copy of any police report made with respect to the loss;
- (c) a copy of any fire marshal's report made with respect to the cause of the loss; and
- (d) such other information as is necessary to verify the loss or contamination of the gasoline or aviation fuel and the remittance or payment over by the applicant of the amount being claimed.

(7) Where a refund has been made under clause (2) (a) or under this section as it existed on the 21st day of July, 1988, the tax in

respect of the gasoline or aviation fuel, as the case may be, shall remain payable to the Treasurer and the applicant shall pay to the Treasurer an amount on account of tax payable under the Act as determined under subsection (8) at any time when the applicant receives any payment from or on behalf of the debtor or receives any payment from any person in satisfaction of part or all of the debt in respect of which the refund was made.

(8) For the purpose of subsection (7), the amount payable to the Treasurer shall be the amount on account of the tax determined by the Minister to have been paid to the applicant after allocation of the payment to amounts payable to the applicant by the debtor on account of gasoline and tax or aviation fuel and tax in the order of the date of sale by the applicant.

(9) Where a refund has been made under clause (2) (a) and the debt in respect of which the refund was made has ceased to be an uncollectable debt, the applicant shall become liable to pay to the Treasurer the amount of the refund and such amount shall be deemed, for the purposes of the recovery thereof, to be tax payable by the applicant under the Act.

(10) Where a refund has been made under clause (2) (a) and the applicant has paid an amount to the Treasurer under subsection (9), the Minister may make a refund to the applicant under clause (2) (a) in an amount that is not in excess of the amount paid to the Treasurer under subsection (9) if,

- (a) the debt in respect of which the refund was originally made subsequently becomes an uncollectable debt by reason of the subsequent allowance of the deduction referred to in clause (4) (a) by the Minister of National Revenue or by a court on an appeal of an assessment of tax under the *Income Tax Act* (Canada); and
- (b) neither the applicant nor the Minister of National Revenue has any further right of appeal, either with or without leave of a court, with respect to the issue of the deductibility of the debt or part thereof from the applicant's taxable income under that Act.

(11) No refund shall be made under this section unless application therefor is made within three years of,

- (a) in the case of a refund under clause (2) (a), the date of a notice of assessment or a determination of a non-capital loss made under the *Income Tax Act* (Canada) or of a judgment or order of a court, whereby the debt in respect of which the refund is claimed is allowed as a deduction referred to in clause (4) (a); and
- (b) in the case of a refund under clause (2) (b), the date of the loss or contamination of the gasoline or aviation fuel in respect of which the refund is claimed. O. Reg. 472/88, s. 1.

DELEGATION OF POWERS

5.—(1) The Deputy Minister of Revenue may exercise the powers or perform the duties conferred or imposed upon the Minister under the following provisions of the Act,

- (a) subsection 6 (1);
- (b) subsections 7 (1) and (2);
- (c) section 11;
- (d) subsection 13 (3);
- (e) subsections 16 (1) and (4);
- (f) section 18;
- (g) subsection 19 (1);

- (h) subsection 20 (1);
- (i) subsection 28 (1);
- (j) section 30. R.R.O. 1980, Reg. 440, s. 5 (1); O. Reg. 685/86, s. 3 (1).

(2) The officer in the Ministry of Revenue holding the position of Assistant Deputy Minister, Tax Revenue may exercise the powers or perform the duties conferred or imposed upon the Minister under,

- (a) subsections 6 (1) and (6);
- (b) subsections 7 (1) and (2);
- (c) subsection 13 (3);
- (d) subsection 14 (11);
- (e) subsection 15 (2);
- (f) subsections 16 (1) and (4);
- (g) section 18;
- (h) subsection 19 (1);
- (i) subsection 20 (1);
- (j) subsection 28 (1);
- (k) section 30; and
- (l) subsections 31 (5) and (6),

of the Act; and

- (m) subsections 2 (1) and (2) of this Regulation. R.R.O. 1980, Reg. 440, s. 5 (2); O. Reg. 685/86, s. 3 (2).

(3) The officer in the Ministry of Revenue holding the position of Director of the Motor Fuels and Tobacco Tax Branch may exercise the power or perform the duty conferred or imposed upon the Minister under,

- (a) subsections 6 (1) and (6);
- (b) subsections 7 (1) and (2);
- (c) subsection 15 (2);
- (d) clauses 16 (1) (a), (b) and (c) and 16 (2), (3) and (5);
- (e) section 18;
- (f) subsection 20 (1);
- (g) subsection 28 (1);
- (h) section 30; and
- (i) subsections 31 (5) and (6),

of the Act; and

- (j) subsections 2 (1) and (2) of this Regulation.

(4) The officer in the Motor Fuels and Tobacco Tax Branch of the Ministry of Revenue holding the position of Manager of Operations may exercise the powers or perform the duties conferred or imposed upon the Minister under,

- (a) subsection 15 (2); and
- (b) clauses 16 (1) (a), (b) and (c) and 16 (2) and (3),

of the Act; and

- (c) subsections 2 (1) and (2) of this Regulation.

(5) The officer in the Motor Fuels and Tobacco Tax Branch of the Ministry of Revenue holding the position of Manager, Tax Advisory Services, may exercise the powers or perform the duties conferred or imposed upon the Minister under subsection 6 (6) of the Act and under section 18 of the Act.

(6) The officer of the Motor Fuels and Tobacco Tax Branch of the Ministry of Revenue holding the position of Manager of Audit may exercise the powers or perform the duties conferred or imposed upon the Minister under clauses 16 (1)(a), (b) and (c) and subsections 16 (2) and (3) of the Act.

(7) The officer in the Ministry of Revenue holding the position of Director of the Special Investigations Branch may exercise the powers or perform the duties conferred or imposed upon the Minister under subsections 16 (1) and (5) of the Act.

(8) The officer in the Ministry of Revenue holding the position of the Director of the Legal Services Branch may exercise the powers or perform the duties conferred or imposed upon the Minister under the following provisions of the Act,

- (a) subsection 14 (11);
- (b) subsections 16 (2) and (3);
- (c) clause 19 (1) (b); and
- (d) subsections 31 (5) and (6).

(9) The officer in the Ministry of Revenue holding the position of Director, Tax Appeals Branch may exercise the power or perform the duty conferred or imposed upon the Minister under subsection 14 (11) of the Act. R.R.O. 1980, Reg. 440, s. 5 (3-9).

REFUNDS

6.—(1) Subject to subsection (2), where gasoline or aviation fuel is exported in bulk from Ontario, the Minister may, on application from an exporter, refund to the exporter the tax paid by the exporter in respect of such gasoline or aviation fuel, if,

- (a) the gasoline or aviation fuel was not exported in the fuel tank of a motor vehicle;
- (b) the gasoline or aviation fuel was exported for the purposes of sale or resale; and
- (c) the application for the refund in the form required by the Minister is mailed or delivered to the Minister not more than three years after the date on which the tax was paid on the exported gasoline or aviation fuel and is supported by,
 - (i) invoices showing the purchase of the gasoline or aviation fuel, and
 - (ii) documentary evidence sufficient to satisfy the Minister that the gasoline or aviation fuel was exported from Ontario and was not subsequently imported into Ontario in bulk. R.R.O. 1980, Reg. 440, s. 8 (1); O. Reg. 254/85, s. 1; O. Reg. 685/86, s. 6.

(2) Where an applicant for a refund under this section misrepresents a material fact on or in connection with an application form for refund or any document used to support such application, no refund shall be made with respect to the gasoline or aviation fuel with respect to which the application is made. R.R.O. 1980, Reg. 440, s. 8 (2).

RECORDS TO BE KEPT

7. For the purpose of subsection 15 (1) of the Act, every collector shall maintain a record of,

- (a) the quantities of gasoline and aviation fuel imported, purchased or otherwise received from suppliers or the collector's own production;
- (b) the quantities of gasoline and aviation fuel sold, delivered or exported or consumed by the collector including sales and deliveries to other collectors, importers, wholesalers, retailers and purchasers;
- (c) the collector's inventory of gasoline and aviation fuel; and
- (d) the tax collectable and payable by the collector,

and shall retain each such record and all invoices, books of account and other documents related thereto for at least five years from the date of the making of the record, invoice or document or last entry in the book of account. O. Reg. 685/86, s. 8.

RATES OF INTEREST

8. The rate of interest payable per annum under the Act shall be reviewed semi-annually and adjusted effective on the 1st day of April and the 1st day of October in each year, and shall remain in force until the next adjustment date, and the rate shall be the mean rate rounded to the nearest whole percentage point of the lowest interest rates charged to their most credit-worthy borrowers for prime business loans by the Royal Bank of Canada, the Bank of Nova Scotia, the Canadian Imperial Bank of Commerce, the Bank of Montreal and the Toronto-Dominion Bank, and

- (a) where the date of the interest adjustment is the 1st day of April, the rate shall be based on the mean interest rates effective on the immediately preceding 15th day of January; and
- (b) where the date of the interest adjustment is the 1st day of October, the rate shall be based on the mean interest rates effective on the immediately preceding 15th day of July,

and the Minister shall cause the rate to be printed in *The Ontario Gazette* published next after the coming into force of the adjusted rate. O. Reg. 509/83, s. 1, *part*.

PERSONS EXEMPT

9. The following classes of persons are exempt from payment of the tax imposed by the Act:

1. Those persons serving in or employed by a diplomatic or consular mission, high commission or trade commission, their spouses and families as authorized by the Department of External Affairs Canada if such persons are not Canadian citizens or "permanent residents" of Canada as defined in the *Immigration Act* (Canada) and if such persons are assigned to duty from the state they represent and are not engaged locally by the mission or commission.
2. Members of the armed forces of a country other than Canada with respect to gasoline or aviation fuel intended for use exclusively in the service vehicles, aircraft or vessels of a visiting force as defined in the *Visiting Forces Act* (Canada) when such gasoline or aviation fuel is exempt from taxation under section 26 of that Act and regulations made thereunder.
3. Indians who for their exclusive use purchase gasoline on a reserve, or who for their exclusive use purchase gasoline not on a reserve when the retailer from whom the gasoline is purchased delivers the gasoline on to the reserve, and "reserve" for the purposes of this paragraph means a reserve, as defined under the *Indian Act* (Canada), or an Indian Settlement

located on Crown land, the Indian inhabitants of which are treated by the Department of Indian Affairs and Northern Development (Canada) in the same manner as Indians residing on a reserve as defined under the *Indian Act* (Canada). R.R.O. 1980, Reg. 440, s. 12; O. Reg. 685/86, s. 9.

PRODUCTS EXCLUDED

10. The following products are excluded from the Act:

1. Distillate.
2. The products commonly known as diesel fuel, furnace oil, stove oil and bunker fuel.
3. Any product that is a solvent, naphtha or thinner that is obtained from a petroleum origin or from the destructive distillation of coal, wood or wood products, or is produced by fermentation or by synthetic chemical reaction.
4. Any product that is a compound or blend comprised wholly of two or more of the products mentioned in paragraph 3.
5. Kerosene certified by the vendor on the invoice as meeting the standard for type I-K Kerosene specified by the American Society for Testing and Materials (A.S.T.M.). R.R.O. 1980, Reg. 440, s. 13; O. Reg. 603/83, s. 1.

REGULATION 534

RETURNS AND REFUNDS

1.—(1) The Minister may require a wholesaler or retailer of gasoline or aviation fuel who is not a collector to deliver a return to the Minister on or before the 15th day of every month showing the quantity of gasoline or aviation fuel sold by the wholesaler or retailer and the names and addresses of all persons to whom the gasoline or aviation fuel was sold during the preceding month.

(2) The Minister may require a purchaser of gasoline or aviation fuel who is not a collector to deliver a return to the Minister on or before the 15th day of every month showing the quantity of gasoline or aviation fuel or both, purchased or received and the names and addresses of the persons from whom the gasoline or aviation fuel or both, was purchased or received during the preceding month. O. Reg. 648/86, s. 1.

(3) Every importer who is not a collector shall, on or before the fifteenth day of the month following the month in which the importer imported into or received in Ontario gasoline, aviation fuel or propane, deliver a statement to the Minister specifying,

- (a) the quantity of the gasoline, aviation fuel or propane; and
- (b) the name and address of the person from whom the gasoline, aviation fuel or propane was purchased and the date of the purchase.

(4) For the purpose of subsection 4 (5) of the Act, every importer who imports gasoline or aviation fuel into Ontario from outside Canada shall deliver a statement to the Minister, or to a person authorized by the Minister, at the time of entry into Ontario of each shipment of gasoline or aviation fuel.

(5) The statement required by subsection (4) shall set out the quantity of gasoline or aviation fuel imported into Ontario by the importer, the name and address of the consignee and the name of the person transporting the gasoline or aviation fuel. O. Reg. 75/90, s. 1.

2.—(1) A refund of tax may be made to a person who paid the tax where the person applies for the refund in a form provided by the Minister and,

- (a) the tax was paid by the person in respect of a product that is excluded by regulation from the application of the Act; or
- (b) the person is exempt under the regulations from the payment of tax under the Act.

(2) No refund of tax shall be made under subsection (1) where the tax was paid more than three years before the date on which the application for a refund is mailed or delivered to the Minister. O. Reg. 648/86, s. 2.

3.—(1) In this section, “motor vehicle” means a machine operated, propelled or driven other than by muscular power.

(2) The Minister may, upon application from a purchaser, refund the tax paid on gasoline where,

- (a) the gasoline has been used in Ontario exclusively in a business, industry or institution and for business, industrial or institutional purposes that are not excluded by regulation from the application of this subsection; or
- (b) the gasoline has been used in Ontario to operate the auxiliary equipment of a motor vehicle where the power from the auxiliary equipment is not used or designed for the propulsion of a motor vehicle on a highway, and the motor vehicle to which the equipment is auxiliary is not principally used by its owner or operator for the transportation of passengers, whether for hire or not, or for the pleasure or recreation of the owner or operator.

(3) No refund of tax shall be made under subsection (2) with respect to gasoline used to operate a motor vehicle for which a permit issued under subsection 7 (7) of the *Highway Traffic Act* is required or in force, or with respect to gasoline used in the operation of any motor vehicle used or intended to be used principally for the recreation or pleasure of its owner or operator.

(4) An application for a refund of tax under subsection (2) shall be accompanied by invoices covering the purchase of the gasoline in respect of the tax on which the applicant is claiming a refund.

(5) Every invoice submitted in support of an application for refund under subsection (2) shall clearly show the invoice number, the name of the purchaser of the gasoline, the name and address of the person who sold the gasoline to the purchaser, the quantities of gasoline sold to the purchaser and the date upon which the gasoline was purchased.

(6) No refund of tax shall be made under subsection (2) where the tax was paid more than three years before the date on which the application is mailed or delivered to the Minister.

(7) The amount of a refund that may be granted by the Minister in respect of an application under subsection (2) shall be reduced by the greater of \$5 or 200 per cent of the amount of the refund of tax claimed if the applicant for the refund misrepresents a material fact in the application for the refund or on or in connection with any document used to support an application for a refund of tax, other than an invoice referred to in subsection (5).

(8) No refund of tax shall be made under subsection (2) where the applicant has misrepresented a material fact on an invoice referred to in subsection (5). O. Reg. 648/86, s. 3.

4.—(1) The Minister may, upon application from a purchaser made within three years from the date on which the tax is paid, refund the tax paid on aviation fuel where the aviation fuel is delivered directly to the fuel tanks of an aircraft making a technical stop at Ottawa International Airport for the sole purpose of refuelling.

(2) No refund of tax shall be made with respect to the fuel delivered to an aircraft that is not, at the time of making the stop, on a transoceanic flight entitling the aircraft to make the stop.

(3) An application for a refund of tax referred to in subsection (1) shall be in a form provided by the Minister and shall be accompanied by invoices relating to the aviation fuel with respect to which the refund is claimed and by information that clearly sets out whether or not the aircraft was making a technical stop under the conditions set out in subsection (1). O. Reg. 648/86, s. 4.

5. For the purposes of subsection 15 (1) of the Act, every importer, wholesaler and retailer shall maintain a record of,

- (a) the quantities of gasoline and aviation fuel imported, purchased or otherwise received from suppliers or the person's own production;
- (b) the quantities of gasoline and aviation fuel sold, delivered or exported or consumed by the person including sales and deliveries to other collectors, importers, wholesalers, retailers and purchasers;
- (c) the person's inventory of gasoline and aviation fuel; and
- (d) the tax collectable and payable,

and shall retain each such record and all invoices, books of account and other documents related thereto for at least five years from the making of the record, invoice or document or the last entry in the book of account. O. Reg. 648/86, s. 5.

6.—(1) Every applicant for a refund of tax paid shall keep records and books of account in such form and containing such information as will enable an accurate determination to be made of the amount refundable to the applicant.

(2) The records, invoices, books of account and other documents required to be kept by every wholesaler or retailer under subsection 15 (1) of the Act and section 5 of this Regulation and documents required to be kept under subsection (1) need not be maintained where,

- (a) the records, invoices, books of account or other documents to be destroyed relate to a period for which all returns required under the Act and regulations have been filed and for which all taxes assessed under the Act or the regulations have been paid;
- (b) the records, invoices, books of account or other documents to be destroyed relate to a period for which there is no outstanding dispute between the person retaining the records, invoices, books of account or other documents and the Minister with regard to any tax payable or to be remitted by the person;
- (c) the time limit for filing a notice of objection to any assessment or statement of disallowance for the period referred to in clause (b) has expired without the filing of the notice of objection;
- (d) no demand of the Minister for the production of the records, invoices, books of account or other documents that are to be destroyed has been made that remains unsatisfied;
- (e) no written notice from the Minister has been given to the wholesaler or retailer requiring the retention of the records, invoices, books of account or other documents that are to be destroyed; and
- (f) a period of five years has expired since the end of the calendar year to which the records, invoices, books of account or other documents relate. O. Reg. 648/86, s. 6.

7.—(1) A notice of assessment under section 11 of the Act shall be in Form 1.

(2) An application for a refund under section 3 of Regulation 533 of Revised Regulations of Ontario, 1990 shall be in Form 2.

(3) An application for a refund under section 3, 4 or 5 of this Regulation or under section 6 of Regulation 533 of Revised Regulations of Ontario, 1990 shall be in Form 3.

(4) The return made by a collector under subsection 1 (1) of Regulation 533 of Revised Regulations of Ontario, 1990 shall be in Form 4. O. Reg. 648/86, s. 7 (1-4).

(5) The statement made by an importer under subsection 1 (3) shall be in Form 5. O. Reg. 75/90, s. 2 (1).

(6) A statement of disallowance made under section 11 of the Act shall be in Form 6. O. Reg. 648/86, s. 7 (6).

(7) An application for a refund under section 4 of Regulation 533 of Revised Regulations of Ontario, 1990 shall be in Form 7. O. Reg. 473/88, s. 1.

(8) A notice of objection under section 13 of the Act shall be in Form 8.

(9) A notice of appeal under section 14 of the Act shall be in Form 9. O. Reg. 25/90, s. 1.

(10) The statement made by an importer under subsection 1 (4) shall be in Form 10. O. Reg. 75/90, s. 2 (2).

Form 1

Gasoline Tax Act



Ministry of Revenue
Motor Fuels and Tobacco Tax Branch

P.O. Box 625
33 King Street West
Oshawa, Ontario
L1H 8H9

Notice of Assessment
GT 53

Date of Mailing or Delivery	Due Date	Please quote this ASSESSMENT NUMBER in all correspondence pertaining to this Notice of Assessment
-----------------------------	----------	---

Explanation of Assessment

Inquiries concerning this assessment may be made in writing or by telephoning (416) 433-

You have been assessed the amount indicated in respect of Gasoline Tax due and payable to the Treasurer of Ontario. If the tax due is not paid by the due date, interest will be charged to the date of payment.

This liability is for the period From _____ To _____	Gasoline Tax Due \$ _____	Interest \$ _____	Other/Penalty \$ _____	TOTAL AMOUNT OF THIS ASSESSMENT \$ _____
---	------------------------------	----------------------	---------------------------	---

NOTICE OF OBJECTION

You have the right to appeal this Notice of Assessment by filing an objection with the Minister of Revenue in the prescribed form within 180 days from the date this notice was mailed.

STATEMENT OF ACCOUNT

Net account balance as of	
Total of above assessment	
Amount credited	
Net account balance as of	

Deputy Minister of Revenue

DETACH HERE



Ministry of Revenue
Motor Fuels and Tobacco Tax Branch

Remittance Advice
Gasoline Tax Act

ASSESSMENT NUMBER	
-------------------	--

CREDIT	\$ _____
--------	----------

- Claim as an authorized adjustment on your next return.
- A cheque in the above amount will be mailed to you.

PAYMENT DUE	\$ _____
-------------	----------

Mailing Address, if different from above (include Postal Code)

DETACH AND RETURN THIS REMITTANCE ADVICE TOGETHER WITH YOUR CHEQUE OR MONEY ORDER MADE PAYABLE TO THE TREASURER OF ONTARIO, TO
 Ministry of Revenue
 Taxation Data Centre
 Motor Fuels and Tobacco Tax Branch
 P.O. Box 620
 33 King Street West
 Oshawa, Ontario
 L1H 8E9

Form 2

Gasoline Tax Act



Ministry of Revenue Motor Fuels and Tobacco Tax Branch P.O. Box 625 33 King Street West Oshawa, Ontario L1H 8H9

Application for Refund - GT260 (Allowance to Retailers)

For use by Retail Vendors of Gasoline only

Is this your first claim? Yes [] No []

GTR Number

Branch Use Only table with columns: Trans Code, Name, Act, Type, Class, County. Values: 3, A, 010.

A Gasoline Handling Licence Number GH Number MUST be shown

GHL Expiry Date Year Month Day

B Complete Name and Address Section if above information is incorrect or if label is missing. Trade or Business Name

County or District in which business is operated.

Form B address section with fields for name, address, postal code.

C CLAIM PERIOD

Form C claim period section with fields for date of first and last invoice.

Form D-F tax calculation section with fields for total tax paid, less refund, tax on wholesale distribution, tax on retail sales, and total amount of claim.

J DECLARATION

I certify that gasoline tax was paid with respect to all invoices supporting this application and that the information given in this application and in any documents attached in support thereof is true, correct and complete in every detail.

Signature Title Telephone No. (Area Code)

Warning: Fraudulent claims submitted may result in charges being laid under the Criminal Code.

Form 3

Gasoline Tax Act



Ministry of Revenue Motor Fuels and Tobacco Tax Branch P.O. Box 825 33 King Street West Oshawa, Ontario L1H 8H9

Application for Refund of Gasoline Tax - GT 257 Gasoline Tax Act

This form is not for completion or use by a collector under the Act

Important: Shaded areas are for Ministry Use Only.

Is this your first claim? Yes No

GTR Number

Large empty rectangular box for information.

Trans Code, Memo, Act, Type, Check, County, Bus. Code, Index

A Complete Name and Address Section if above information is incorrect or if label is missing

Name of Proprietor or Business Name, Address, Postal Code

B County or District in which business is operated

Farm Claimant only

Lot No, Concession No, Township

C Describe nature of business operated and refundable use of gasoline. (Type of unlicensed equipment operated)

Large empty rectangular box for description.

D Do you operate licensed gasoline vehicles? Do you fuel licensed gasoline vehicles from your own storage?

CLAIM PERIOD: Date of first Invoice, Date of last Invoice

Important: Complete only Line F or Line G. Do not complete both.

F Declaration of Gasoline Purchases and Refundable use

G Declaration of gasoline Purchases and Exports

Note: 1. If the worksheet in the guide is not completed, your refund will be calculated on your behalf on the basis of the information submitted. 2. To calculate your refund, the worksheet in the guide should be completed and attached.

H Refund Claimed

J CERTIFICATION

- 1. I HEREBY CERTIFY that all gasoline in respect of which this refund is claimed has been taxed under the Gasoline Tax Act and that the gasoline was not used to power a motor vehicle licensed or required to be licensed under the Highway Traffic Act. 2. I FURTHER CERTIFY that the gasoline covered by this claim was consumed or used in one or more of the following ways: (a) for business, industrial or institutional purposes in UNLICENSED equipment, machinery or vehicles, or, (b) for business, industrial or institutional purposes in a power take-off application, or, (c) for sale to Indians on a reserve who have presented, at the time of purchase valid Certificates of Exemption, or, (d) for export by me from Ontario. 3. I FURTHER CERTIFY that the gasoline relating to this claim for rebate of tax was NOT used in a motor vehicle operated for personal or recreational purposes. 4. I FURTHER CERTIFY that the information supplied by me in this application and its supporting documents is true, complete and correct.

Signature, Title, Telephone Number & Area Code

Warning: Fraudulent claims submitted may result in charges being laid under the Criminal Code. Remarque: Cette formule est disponible en français sur demande à la Direction de la taxe sur le tabac et sur les carburants, Ministère du Revenu, 33, rue King ouest, C.P. 825 Oshawa (Ontario) L1H 8H9

Form 4

Gasoline Tax Act



Ministry of Revenue
Motor Fuels and Tobacco Tax Branch

P.O. Box 620
33 King Street West
Oshawa, Ontario
L1H 8E9

Gasoline Tax Return-GT66
Gasoline Tax Act

Month

Year

Collector's Name and Address

⌈

TAX DUE

①	Gasoline	\$	
②	Aviation Fuel	\$	
③	Total Tax for the Month	\$	

DEDUCTIONS

④	Authorized Adjustments: (Bad Debts / Bankruptcies, Product Losses as per attached approvals)	\$	
⑤	Ontario Gasoline Tax paid on purchases	\$	
⑥	Refund claimed on sales to registered Indians per attached Vouchers	\$	
⑦	TOTAL CREDITS (Line 4 plus Lines 5 and 6)	\$	
⑧	NET TAX DUE (Line 3 minus Line 7)	\$	
⑨	Other Adjustments (Please explain)	\$	
	<input type="checkbox"/> Plus <input type="checkbox"/> Minus		
⑩	BALANCE DUE (Attach remittance)	\$	

Total Quantity Imported Into Ontario (as per GT schedule 3 (5))	Litres
Total Quantity Exported Out of Ontario (as per GT schedule 5 (5))	Litres

CERTIFICATION

I hereby certify that the financial and other statements of information included herein or attached hereto are in agreement with the books of the importer and exhibit truly, correctly and completely all information for the period covered by this Return.

..... Signature Title Date

Remarque: Cette formule est disponible en français sur demande à la Direction de la taxe sur le tabac et sur les carburants ministère du Revenu, 33, rue King ouest, C.P. 625 Oshawa Ontario L1H 8H9

Form 5

Gasoline Tax Act



Ministry of Revenue
Motor Fuels and Tobacco Tax Branch
P.O. Box 620
33 King Street West
Oshawa, Ontario
L1H 8E9

Statement of Gasoline Imports - GT61
Gasoline Tax Act

This form is to be completed by a gasoline importer who is not a Collector under the Act.
IMPORTANT: Shaded areas are for Ministry use only.

Name of Importer		Calendar Month and Year
Postal Address - Number and Street or Rural Route	Telephone No.	
City, Town and Province	Postal Code	

Instructions

- Statement of Gasoline Imports must be delivered to the Ministry of Revenue, together with payment, on or before the 15th day of the month following the calendar month indicated above.
- Submit this Statement of Gasoline Imports together with your cheque or money order for the amount due made payable to the TREASURER OF ONTARIO at the address shown above.
- GT SCHEDULE 3^(B) must accompany this statement.

AS PER GT SCHEDULE 3

Province / State	Litres Imported			Note: 1 U.S. Gal = 3.785
	Aviation Fuel	Leaded Gasoline	Unleaded Gasoline	
Total	L	L	L	

(1)	Ontario Tax Rate	X	Ontario Tax Rate	X	Ontario Tax Rate	X	
	=		=		=		A
	Tax Amount	+	Tax Amount	+	Tax Amount	=	\$

To be completed ONLY if product was Imported from Quebec. (Complete either (2) or (3), NOT BOTH.)

If Quebec tax rate is higher than Ontario's complete (2).

(2) Quebec-tax-paid gasoline imported into Ontario

Leaded	X	Ont. Tax Rate	=	Tax Amount	= \$
Unleaded	X	Ont. Tax rate	=	Tax Amount	

If Quebec tax rate is lower than Ontario's, complete (3).

(3) Quebec-tax-paid gasoline imported into Ontario

Leaded	X	Que. Tax Rate	=	Tax Amount	= \$
Unleaded	X	Que. Tax Rate	=	Tax Amount	

(4) Amount of tax/security remitted with respect to the imports declared in this return = \$

(5) Amount Due (Box A minus Boxes B, C, or D as applicable) ▷ \$

CERTIFICATION

I hereby certify that the financial and other statements of information included herein or attached hereto are in agreement with the books of the importer and exhibit truly, correctly and completely all information for the period covered by this statement.

Signature of Importer or Signing Officer _____ Title _____ Date _____

Formule 5

Loi de la taxe sur l'essence



Ministère du Revenu Direction de la taxe sur les carburants et le tabac C.P. 620 33, rue King ouest Oshawa (Ontario) L1H 8E9

Déclaration d'importation d'essence - GT61
Loi de la taxe sur l'essence

Cette formule doit être remplie par un importateur d'essence qui n'est pas un percepteur aux termes de la Loi.
IMPORTANT : Les parties ombrées sont réservées au ministère.

Nom de l'importateur		Mois et année civile
Adresse postale - Numéro et rue ou route rurale	N° de téléphone	
Ville et province	Code postal	

Instructions

- La Déclaration d'importation d'essence doit parvenir au ministère du Revenu, accompagnée du paiement, au plus tard le 15 du mois qui suit le mois indiqué ci-dessus.
- Envoyer la Déclaration d'importation d'essence, accompagnée d'un chèque ou d'un mandat établi à l'ordre du TRÉSORIER DE L'ONTARIO, à l'adresse indiquée ci-dessus.
- Un (des) exemplaire(s) de l'annexe 3 doit(vent) être joint(s) à cette déclaration.

DONNÉES À REPORTER DE L'ANNEXE 3

Province / État	Quantité importée (litres)		
	Carburant aviation	Essence au plomb	Essence sans plomb
Total	L	L	L

Remarque : 1 gal. É.U. = 3,785 litres

(1)

X	X	X	
Taxe de l'Ontario	Taxe de l'Ontario	Taxe de l'Ontario	A
=	=	=	
Montant de la taxe	+	Montant de la taxe	+
		Montant de la taxe	=
			\$

À remplir SEULEMENT si la produit a été importé du Québec (remplir (2) ou (3) et NON LES DEUX).

Si la taxe du Québec est plus élevée que celle de l'Ontario, remplir (2)

(2) Essence importée en Ontario pour laquelle la taxe du Québec a été payée

au plomb	X	Taxe de l'Ontario	=	Montant de la taxe	=	B
sans plomb	X	Taxe de l'Ontario	=	Montant de la taxe		\$

Si la taxe du Québec est moins élevée que celle de l'Ontario, remplir (3)

(3) Essence importée en Ontario pour laquelle la taxe du Québec a été payée

au plomb	X	Taxe du Québec	=	Montant de la taxe	=	C
sans plomb	X	Taxe du Québec	=	Montant de la taxe		\$

(4) Montant de la taxe/de la garantie versée à l'égard des importations déclarées sur la présente formule = D \$

(5) Montant dû (Case A moins case B, C ou D, selon le cas) = \$

Attestation

J'atteste, par le présente, que les états financiers et autres états informatifs inclus dans le présente ou annexé à celle-ci concordent avec les livres de l'importateur et présentent de façon véridique, exacte et complète, les renseignements pour la période visée par la présente déclaration.

Signature du propriétaire ou d'une personne autorisée _____ Titre _____ Date _____

Form 6

Gasoline Tax Act



Ministry of Revenue Motor Fuels and Tobacco Tax Branch

P.O. Box 625 33 King Street West Oshawa, Ontario L1H 8H9

Statement of Disallowance - GT 262

Date of Mailing or Delivery

Please quote this DISALLOWANCE NUMBER on all correspondence pertaining to this Statement of Disallowance

Refund of tax claimed by you in respect of Gasoline Tax has been disallowed in the amount and for the reason(s) indicated below.

Type of claim received

Gasoline Tax Return(s) or Refund Claim

GTR No.

Refund Claim No.

Period covered by refund claim - From To

Table with 2 columns: Description, Amount. Rows: Amount of refund claimed, Amount of refund disallowed, Amount of refund allowed.

Reason(s) for disallowance

Inquiries concerning this disallowance may be made in writing or by telephoning (416) 433-

NOTICE OF OBJECTION

You have the right to appeal this Statement of Disallowance of your claim by filing an objection with the Minister of Revenue in the prescribed form within 180 days from the date this notice was mailed.

Tax Appeals Branch Ontario Ministry of Revenue P.O. Box 627 Oshawa, Ontario L1H 8H5 Phone: (416) 433-6029 in Oshawa (416) 965-5836 in Toronto (ask operator for Tax Appeals Branch)

Deputy Minister of Revenue

Form 7

Gasoline Tax Act



Ministry of Revenue
 Motor Fuels and Tobacco Tax Branch
 P.O. Box 625
 33 King Street West
 Oshawa, Ontario
 L1H 8H9

Application for Gasoline Tax Refund - GT 52

Type of Claim Bad Debt Claim Loss of Product Claim Contaminated Product Claim
 Type of Business Collector Importer Wholesaler Retailer

Applicant's Name: _____ Gasoline Holding License Number: _____
 Address: _____

A - Bad Debt Claim

Debtor's Legal Name: _____
 Address: _____

If in Bankruptcy, state name and address of the trustee and date of assignment
 Trustee's Name and Address: _____

_____ Date of Assignment: _____

List in chronological order details of all unpaid invoices on which refund of the tax is claimed. (Please attach invoices) Use separate listing if space is insufficient.

Date of Invoice	Invoice Number	Grade of Gasoline / Aviation Fuel	Number of Litres	Tax Rate	Tax Amount Claimed

State the Taxation Year in which the Bad Debt was written off under the Income Tax Act (Canada) 19____ Total Tax Claimed \$ _____

B - Loss of Product / Contaminated Product Claim

Date of Loss / Contamination _____

Type of Loss (Place an "X" in the appropriate box)
 Fire Vehicle Accident Other (Please specify) _____

Theft Contamination _____

Number of Litres	Tax Rate	Amount of Tax
Total Tax Claimed		\$ _____

Certification
 I hereby certify that the statements and information included herein or attached hereto are true, complete and accurate in every respect.

Authorized Signature _____	Title _____	Date _____
----------------------------	-------------	------------

NOTE: No relief from tax will be permitted until authorized by the Branch.

Remarque: Cette formule est disponible en français sur demande à la Direction de la taxe sur les carburants et le tabac, ministère du Revenu, 33, rue King ouest, C.P. 625 Oshawa (Ontario) L1H 8H9

Form 8

Gasoline Tax Act



Ministry
of
Revenue
Ontario

Notice of Objection

Name of Taxpayer (Corporation, Purchaser, Registrant, Vendor)	Telephone No ()
---	------------------------

Street Number and Name		
Mailing Address		
City/Town	Province	Postal Code _ _ _ _ _ _ _

NOTICE OF OBJECTION is hereby given to the:

<input type="checkbox"/> Assessment No.	Date of Notice of Assessment	Amount of Tax \$	for Period ending
	Year Month Day		Year Month Day
<input type="checkbox"/> OR Statement of Disallowance	Statement Date	Rebate/Refund Amount \$	
of Rebate/Refund Claim No _____	Year Month Day		

under the following act (check one only and indicate account/permit number)

<input type="checkbox"/> <u>CORPORATIONS TAX ACT</u>	- Account Number	_ _ _ _ _ _ _
<input type="checkbox"/> <u>GASOLINE TAX ACT</u>	- Permit Number	_ _ _ _ _ _ _
<input type="checkbox"/> <u>LAND TRANSFER TAX ACT</u>		
<input type="checkbox"/> <u>RETAIL SALES TAX ACT</u>	- Permit Number	_ _ _ _ _ _ _
<input type="checkbox"/> <u>TOBACCO TAX ACT</u>	- Permit Number	_ _ _ _ _ _ _
<input type="checkbox"/> <u>FUEL TAX ACT</u>	- Permit Number	_ _ _ _ _ _ _
<input type="checkbox"/> <u>MINING TAX ACT</u>	- Account Number	_ _ _ _ _ _ _
<input type="checkbox"/> <u>RACE TRACKS TAX ACT</u>	- Permit Number	_ _ _ _ _ _ _

The following are the reasons for objection and the relevant facts:

(If space is insufficient, a separate memorandum should be attached setting forth the full statement of reasons for objection and relevant facts.)

Check here if additional sheets are attached.

Appointment of Representative

I confirm that _____
has the authority to communicate on my/the company's behalf concerning this Notice of Objection.
I authorize the Tax Appeals Branch to collect personal information from and disclose personal information to my representative in accordance with the Freedom of Information and Protection of Privacy Act.

This NOTICE OF OBJECTION must be signed by the person objecting or an authorized signing officer of the company.

Date	Name (print)	Signature	Position or Office

Form 9

Gasoline Tax Act



Notice of Appeal

IN THE ONTARIO COURT (GENERAL DIVISION)

In The Matter of the (Check one only):

- | | |
|---|--|
| <input type="checkbox"/> Corporations Tax Act | <input type="checkbox"/> Land Transfer Tax Act |
| <input type="checkbox"/> Gasoline Tax Act | <input type="checkbox"/> Fuel Tax Act |
| <input type="checkbox"/> Retail Sales Tax Act | <input type="checkbox"/> Mining Tax Act |
| <input type="checkbox"/> Tobacco Tax Act | <input type="checkbox"/> Race Tracks Tax Act |

BETWEEN

- AND -
THE MINISTER OF REVENUE

Appellant,
Respondent.

TAKE NOTICE that pursuant to (Check one only):

- | | |
|--|---|
| <input type="checkbox"/> Section 85 of the <u>Corporations Tax Act</u> | <input type="checkbox"/> Section 14 of the <u>Land Transfer Tax Act</u> |
| <input type="checkbox"/> Section 14 of the <u>Gasoline Tax Act</u> | <input type="checkbox"/> Section 14 of the <u>Fuel Tax Act</u> |
| <input type="checkbox"/> Section 25 of the <u>Retail Sales Tax Act</u> | <input type="checkbox"/> Section 10 of the <u>Mining Tax Act</u> |
| <input type="checkbox"/> Section 22 of the <u>Tobacco Tax Act</u> | <input type="checkbox"/> Section 11 of the <u>Race Tracks Tax Act</u> |

the Appellant appeals to the Ontario Court (General Division) from the decision of the Minister of Revenue

dated the _____ day of _____ 19____
in respect of

<input type="checkbox"/>	Assessment No.	Date of Notice of Assessment	Amount of Tax	for Period ending
		Year Month Day	\$	Year Month Day
OR	Statement of Disallowance		Statement Date	Rebate/Refund Amount
<input type="checkbox"/>			Year Month Day	\$

STATEMENT OF REASONS FOR APPEAL

(Set out relevant facts and law to be relied on in support of the appeal in a separate memorandum attached to this form.)

Appointment of Representative

I confirm that _____ has the authority to communicate on my/the company's behalf concerning this Notice of Appeal. I authorize the Ministry of Revenue to collect personal information from and disclose personal information to my representative in accordance with the Freedom of Information and Protection of Privacy Act.

This NOTICE OF APPEAL must be signed by the Appellant or by an authorized representative.

Date	Name (print)	Signature	Position or Office

**Form 10
Formule 10**

*Gasoline Tax Act
Loi de la taxe sur l'essence*



Ministry of Revenue / Ministère du Revenu
P.O. Box 620 / 33 King Street West / Oshawa, Ontario / L1H 8E9
C.P. 620 / 33, rue King ouest / Oshawa (Ontario) / L1H 8E9

**Ontario Fuel and Gasoline Tax
(Border) FGTB-1
Gasoline Tax Act/Fuel Tax Act**

**Taxe ontarienne sur les carburants et sur
l'essence (Frontière) FGTB-1
Loi de la taxe sur l'essence/Loi de la taxe sur les carburants**

Note: This form must be completed in triplicate and be in the possession of the driver of the vehicle on entry into Ontario. A certified cheque drawn on a Canadian Chartered bank in Canadian Funds or money order for the total tax due is also required.

Remarque: Cette formule doit être remplie en trois exemplaires et le conducteur doit l'avoir avec lui lorsqu'il entre en Ontario. Un chèque visé tiré sur une banque à charte canadienne en fonds canadiens ou un mandat pour le montant total de la taxe due est aussi exigé.

Name of Importing Consignee Nom du consignataire important le carburant		Importer's Federal Sales Tax Number Numéro de la taxe de vente fédérale de l'importateur	
Postal Address Adresse postale	Telephone No./N° de téléphone	Importer's Federal Excise Tax Number Numéro de la taxe d'accise fédérale de l'importateur	
City, Town and Province Ville, province		Postal Code/Code postal	If applicable, Ontario Gasoline Tax Collector No. Si applicable, N° du percepteur de la taxe sur l'essence de l'Ontario
Name of Carrier Nom du transporteur		Ontario Fuel Tax Collector No. N° du percepteur de la taxe sur les carburants de l'Ontario	
Ontario Point of Entry/Point d'entrée en Ontario		Canada Customs Control Document No./N° du document de contrôle des douanes canadiennes	

**Tax on Gasoline / Aviation Fuel Imports
Taxe sur les importations d'essence / de carburant aviation**

Product/Produit Gasoline/Essence	Litres Imported Litres importés		Tax Rate Taux de la taxe		Tax Amount Montant de la taxe
Leaded/Avec plomb	<input type="text"/>	X	<input type="text"/>	-	\$ <input type="text"/>
Unleaded/Sans plomb	<input type="text"/>	X	<input type="text"/>	-	\$ <input type="text"/>
Aviation Fuel Carburant aviation	<input type="text"/>	X	<input type="text"/>	-	\$ <input type="text"/>

Note: 1 US Gallon = 3.785 litres
Remarque: 1 gallon É.U. = 3,785 litres

Tax Due / Taxe due "A" \$

Tax on Fuel Imports/Taxe sur les importations de carburant

Product/Produit	Litres Imported Litres importés		Tax Rate Taux de la taxe		Tax Amount Montant de la taxe
Clear Fuel Carburant incolore	<input type="text"/>	X	<input type="text"/>	- "B"	\$ <input type="text"/>
Coloured fuel dyed under supervision of a customs officer Carburant coloré sous la supervision d'un douanier	<input type="text"/>	X	Tax Exempt Exonéré de la taxe		
1-K Kerosene as certified by manufacturers Kérosène 1K certifié comme tel par les fabricants	<input type="text"/>	X	Tax Exempt Exonéré de la taxe		

Total Tax Due / Taxe due = "C" \$
("A" + "B" = "C")

Make cheque payable to Treasurer of Ontario / Libeller le chèque à l'ordre du trésorier de l'Ontario

Certification
I hereby certify that the statements made herein or attached hereto are in agreement with the books of the importer and exhibit truly, correctly and completely all information concerned by this statement.

Attestation
J'atteste, par la présente, que les renseignements contenus dans cette formule ou joints à celle-ci sont conformes aux livres de l'importateur et présentent de façon véridique, exacte et complète tous les renseignements s'y rapportant.

Signature of Signing Officer/Signature du signataire autorisé	Title/Titre	Date
<input type="text"/>	<input type="text"/>	<input type="text"/>

General Welfare Assistance Act
Loi sur l'aide sociale générale

REGULATION 535

CIVIL LEGAL AID

1. In this Regulation,

“assistance” means assistance of the class established under section 2;

“civil legal aid” means professional services provided under the *Legal Aid Act* and the regulations thereunder on behalf of a person in respect of any matter that is not criminal in nature;

“cost of civil legal aid” means the cost of civil legal aid incurred by the legal aid plan;

“Fund” means “Fund” as defined in section 1 of the *Legal Aid Act*;

“legal aid plan” means the legal aid plan established under section 2 of the *Legal Aid Act*;

“liquid assets” means cash, bonds, stocks, debenture, an interest in real property, a beneficial interest in assets held in trust and available to be used for maintenance and any other asset that can be readily converted into cash, but does not include,

- (a) that portion of the sale price of a person's real property that is applied or where the Director approves, that will be applied to the purchase price of a principal residence of the person, or
- (b) an interest in real property used by the person as the person's principal residence. O. Reg. 829/82, s. 1.

2. Assistance in respect of the cost of civil legal aid is established as a class of assistance for the purposes of the Act and this Regulation. O. Reg. 829/82, s. 2.

3.—(1) An application for civil legal aid that has been referred for a financial assessment under subsection 16 (2) of the *Legal Aid Act* shall be deemed to be an application for assistance and the information gathered for the purposes of the financial assessment shall be deemed to be part of the application for assistance.

(2) No application for assistance under this Regulation shall be received except in accordance with subsection (1). O. Reg. 829/82, s. 3.

4.—(1) A person is eligible for assistance where,

- (a) no lien under section 18 of the *Legal Aid Act* is placed on any interest the person has in real property;
- (b) the liquid assets of the person do not exceed an amount established by the Director; and
- (c) the person,
 - (i) is in receipt of or meets the financial eligibility requirements for an allowance under the *Family Benefits Act* and the regulations thereunder or for general assistance under the *General Welfare Assistance Act* and Regulation 537 of Revised Regulations of Ontario, 1990, or
 - (ii) is determined to be a person in need under section

18 of Regulation 537 of Revised Regulations of Ontario, 1990.

(2) For the purposes of determining whether a person referred to in subclause (1) (c) (ii) is a person in need, the cost of civil legal aid with respect to the person shall be deemed to be a service, item or payment authorized by the Director under paragraph 17 of subsection 18 (4) of Regulation 537 of Revised Regulations of Ontario, 1990. O. Reg. 829/82, s. 4.

5. A person who received civil legal aid and who was in receipt of an allowance under the *Family Benefits Act* or *General Welfare Assistance Act* at the time the civil legal aid was provided shall be deemed to have met with all the requirements of this Regulation and to have obtained assistance in accordance with this Regulation. O. Reg. 829/82, s. 5, revised.

6. Payments to the Fund by the Ministry of the Attorney General in respect of the cost of civil legal aid for which a person is eligible for assistance shall, to the extent that the person is eligible for assistance, be deemed to be payments of assistance under this Regulation. O. Reg. 829/82, s. 6, revised.

REGULATION 536

DENTAL SERVICES

1. In this Regulation, “eligible person” means a person described in subsection 9 (2) and in clause 9 (3) (a) or (b) of Regulation 564 of Revised Regulations of Ontario, 1990 made under the *Health Protection and Promotion Act*. O. Reg. 131/90, s. 1.

2. Assistance in respect of the cost of dental treatment services listed in the Schedule to section 9 of Regulation 564 of Revised Regulations of Ontario, 1990 made under the *Health Protection and Promotion Act* is established as a class of assistance. O. Reg. 131/90, s. 2.

3. The Director may provide assistance in respect of the cost of dental treatment services on behalf of eligible persons in an amount that does not exceed the amount specified in the Schedule referred to in section 2 for those dental treatment services. O. Reg. 131/90, s. 3.

REGULATION 537

GENERAL

1.—(1) In this Regulation,

“adult” means a person sixteen years of age or over;

“approved band” means a band approved by the Minister and listed in the Schedule to Regulation 538 of Revised Regulations of Ontario, 1990;

“child” means a person under sixteen years of age;

“dental surgeon” means a member of The Royal College of Dental Surgeons of Ontario;

“dependant” means a dependent child or a dependent adult;

“dependent adult” means an adult who,

- (a) lives with a head of a family or a parent or a person who has demonstrated an intention to treat the adult as a member of his or her family, and
- (b) is dependent for support and maintenance on the head of the family or the parent or the person who has demonstrated an intention to treat the adult as a member of his or her family,

and includes a spouse;

“dependent child” means a child who,

- (a) lives with a head of a family or a parent or a person who has demonstrated an intention to treat the child as a child of his or her family,
- (b) is dependent for support and maintenance on the head of the family or the parent or the person who has demonstrated an intention to treat the child as a child of his or her family, and
- (c) is,
 - (i) of pre-school age,
 - (ii) attending school,
 - (iii) unable to attend school because of physical or mental disability, or
 - (iv) conforming to a program prescribed for the child under Regulation 308 of Revised Regulations of Ontario, 1990;

“energy for heat” means any energy source used for heating a dwelling;

“extended care services” means skilled nursing and personal care given by or under the supervision of a registered nurse or registered nursing assistant who holds a certificate under the *Health Disciplines Act* under the direction of a physician, to a resident of a nursing home for a minimum of one and one-half hours per day;

“head of a family” means a person who has charge of a household and who has one or more dependants therein;

“hostel” means a place of board or lodging maintained and operated by a municipality or the council of an approved band or by a person or organization under an agreement with a municipality, the council of an approved band, or the Province of Ontario, for needy persons but does not include a nursing home or a home for the aged under the *Homes for the Aged and Rest Homes Act* or a charitable institution other than a hostel under the *Charitable Institutions Act*;

“liquid assets” means cash, bonds, stocks, debentures, an interest in real property, a beneficial interest in assets held in trust and available to be used for maintenance and any other assets that can be readily converted into cash, but does not include,

- (a) that portion of the sale price of an applicant’s or recipient’s real property that is applied, or where the welfare administrator approves, that will be applied to the purchase price of a principal residence of the applicant or recipient,
- (b) an interest in real property used by the applicant or recipient as his or her principal residence,
- (c) a prepaid funeral plan up to a maximum amount approved by the Director, or

(d) an amount, up to a maximum of \$25,000, received as damages or compensation for,

- (i) pain and suffering, or
- (ii) expenses actually and reasonably incurred or to be incurred as a result of injury to, or the death of, an applicant, recipient, dependent adult or dependent child;

“nursing home” means a nursing home licensed under the *Nursing Homes Act*;

“physician” means a legally qualified medical practitioner;

“single person” means an unmarried adult, a widow, a widower or a separated or divorced person but does not include a person,

- (a) who is a head of a family,
- (b) who is an employable person under the age of twenty-one years living with either of his or her parents or with a person in the role of a parent, or
- (c) who is living with his or her spouse;

“special assistance” means the provision of one or more of the following items, services and payments,

- (a) drugs prescribed by a physician or a dental surgeon,
- (b) surgical supplies and dressings,
- (c) travel and transportation allowance,
- (d) moving allowance,
- (e) funerals and burials,
- (f) dental services,
- (g) prosthetic appliances including eyeglasses,
- (h) vocational training or retraining,
- (i) a personal needs allowance where the applicant or recipient is a resident in a nursing home, and
- (j) any other special service, item or payment in addition to those set out in clauses (a) to (i), both inclusive, authorized by the Director;

“spouse” means,

- (a) a person of the opposite sex to an applicant or recipient who together with the applicant or recipient have declared to a welfare administrator or the Director that they are spouses,
- (b) a person who is required under the provisions of a court order or domestic contract to support the applicant, recipient or any of his or her dependants,
- (c) a person who has an obligation to support the applicant, recipient or any of his or her dependants under section 30 or 31 of the *Family Law Act* despite a domestic contract or other agreement between the person and the applicant or recipient whereby they purport to waive or release such obligation to support, or
- (d) a person of the opposite sex to the applicant or recipient who has resided continuously with the applicant or recipient for a period of not less than three years;

“unemployable person” means a person who is unable to engage in

remunerative employment by reason of physical or mental disability;

“welfare administrator” means a municipal welfare administrator, a regional welfare administrator or a welfare administrator for an approved band, as the case may be;

“work activity project” means a project approved by the Minister, the purpose of which is to prepare for entry or return to employment, persons who because of environmental, personal or family reasons have unusual difficulty in obtaining or holding employment or in improving through participation in technical or vocational training programs their ability to obtain and hold employment. R.R.O. 1980, Reg. 441, s. 1 (1); O. Reg. 655/82, s. 1; O. Reg. 786/82, s. 1; O. Reg. 708/84, s. 1 (1-3); O. Reg. 395/86, s. 1; O. Reg. 639/86, s. 1 (1, 2); O. Reg. 590/87, s. 1 (1); O. Reg. 549/88, s. 1; O. Reg. 164/89, s. 1, *revised*.

(2) In determining whether or not a person is a spouse within the meaning of this Regulation, sexual factors shall not be investigated or considered. O. Reg. 639/86, s. 1 (3).

(3) Clause (d) of the definition of “spouse” in subsection (1) does not apply to a person who has resided continuously for a period of not less than three years with the applicant or recipient and the applicant or recipient provides evidence to a welfare administrator that the economic, social and familial aspects of the relationship between the person and the applicant or recipient were such that the continuous residing did not amount to cohabitation. O. Reg. 590/87, s. 1 (2).

(4) For the purpose of the Act and this Regulation, “person in need” means a person who by reason of,

- (a) inability to obtain regular employment;
- (b) being a head of a family whose spouse is absent;
- (c) lack of a parent for support and maintenance;
- (d) disability; or
- (e) old age,

has budgetary requirements as determined in accordance with sections 13 and 31 that exceed the person’s income as determined under section 15 and who is not otherwise ineligible for assistance under the Act or this Regulation. O. Reg. 708/84, s. 1 (4); O. Reg. 590/87, s. 1 (3).

(5) Subject to subsection (6), an applicant or recipient shall be deemed for the purposes of the Act and this Regulation to reside or to have resided in the municipality, the territory without municipal organization or on the reserve, as the case may be, where the applicant is or was ordinarily resident at the date of the application, so long as he or she remains in the municipality, territory or reserve, but where the applicant or recipient is a resident,

- (a) in a nursing home; or
- (b) where the Director approves, in a hostel,

the applicant or recipient shall be deemed to reside or have resided in the municipality, territory without municipal organization or on the reserve, as the case may be, where the applicant is or was ordinarily resident other than in an institution, immediately before admission to the nursing home or to the hostel.

(6) For the purpose of subsection (5), a transient or homeless person shall be deemed to reside or have resided in the municipality, territory without municipal organization, or on the reserve, as the case may be, in which he or she applies for assistance. R.R.O. 1980, Reg. 441, s. 1 (4, 5).

ELIGIBILITY

2. The classes of persons who are recipients of governmental benefits in addition to those specified in the definition of “recipient of a governmental benefit” in section 1 of the Act are,

- (a) recipients of an increment under the *Ontario Guaranteed Annual Income Act*;
- (b) recipients of a spouse’s allowance under the *Old Age Security Act* (Canada); and
- (c) recipients of a benefit under the *Canada Pension Plan* or the *Quebec Pension Plan* (Quebec). R.R.O. 1980, Reg. 441, s. 2; O. Reg. 743/86, s. 1.

3. The regional welfare administrator may receive applications for assistance and shall determine the eligibility of each applicant for assistance and, where the applicant is eligible, shall determine the amount of assistance and direct provision thereof, and the regional welfare administrator may from time to time vary any amount so determined. O. Reg. 656/82, s. 1.

4.—(1) In determining whether a person in need is eligible for assistance and the amount of assistance payable or provided to the person, a welfare administrator shall,

- (a) take into account the budgetary requirements of the applicant and any of his or her dependants and the liquid assets and income that are available;
- (b) where the person is not engaged in full-time regular employment but is employable, be satisfied that, subject to clause (d) and subsections 7 (1), (3) and (4),
 - (i) the person is willing to undertake any full-time, part-time and casual employment for which he or she is physically capable,
 - (ii) the person is making reasonable efforts to secure all such employment, and
 - (iii) any history of unemployment was due and any current unemployment is due to circumstances beyond the control of the applicant or recipient;
- (c) in the case of an applicant or recipient with one or more dependent adults, be satisfied that, subject to clause (d) and subsection 7 (4), each of the dependent adults who is an employable person and who is not attending a course of education or program of training approved by the welfare administrator,
 - (i) is engaged in or is willing to undertake any full-time, part-time and casual employment for which he or she is physically capable,
 - (ii) is making reasonable efforts to secure all such full-time, part-time and casual employment, and
 - (iii) any history of unemployment was due and any current unemployment is due to circumstances beyond the control of the dependent adult;
- (d) despite clauses (b) and (c), in the case of an unemployed but employable person who is the head of the family or any dependent adult of the applicant or recipient, be satisfied that he or she is prevented from obtaining full-time, part-time and casual employment because it is necessary and appropriate for him or her to remain at home to give personal care and supervision to one or more dependent children of the household of the applicant or recipient where in the opinion of the welfare administrator,
 - (i) the household is without an adult able to give ade-

quate personal care and supervision to such child or children, and

- (ii) no alternative and adequate child care service that allows such child or children to remain part of the household is available or appropriate in the circumstances. R.R.O. 1980, Reg. 441, s. 3 (1); O. Reg. 402/84, s. 2.

(2) For the purposes of clause (3) (b), a retirement pension that is available to a person prior to the month in which the person attains sixty-five years of age under the *Canada Pension Plan* or the *Quebec Pension Plan* (Quebec) shall not be considered to be compensation or a financial resource to which that person is entitled. O. Reg. 743/86, s. 2.

(3) Where the welfare administrator is not satisfied that,

- (a) an applicant or recipient or any dependant of the applicant or recipient who is a dependent adult meets or is complying with any provision of clause (1) (b), (c) or (d) that is applicable to that person; or
- (b) an applicant or recipient or his or her dependant is making reasonable efforts to obtain compensation or realize any financial resource that the applicant, recipient or dependant may be entitled to or eligible for, including when the applicant or recipient is a sponsored dependant or nominated relative within the meaning of the regulations under the *Immigration Act* (Canada), any compensation or contribution to the support and maintenance of the applicant or recipient or his or her dependant, as the case may be, that may result from any undertaking or engagement made on his or her behalf under the said regulations between the Government of Canada and any person nominating or sponsoring him or her,

the welfare administrator may determine that the applicant or recipient is not eligible for assistance or the welfare administrator may reduce the amount of assistance granted, by the amount of the compensation contribution, financial resource or income that in his or her opinion is available or would have been available to the applicant or recipient or his or her dependant, if all or any of them had satisfied the welfare administrator under clause (a) or (b), as the case may be. R.R.O. 1980, Reg. 441, s. 3 (3).

5.—(1) Where money is due and owing or may become due and owing to an applicant, recipient or dependant which if received would be included in income for the purpose of section 15, the welfare administrator may require as a condition of eligibility for assistance that the applicant, recipient or dependant agrees in writing to reimburse the municipality, band or Ontario, as the case may be, for all or any part of the assistance advanced or to be advanced when the money becomes payable. O. Reg. 625/90, s. 1 (1).

(2) Subsection (1) applies whether the money is in the nature of income or capital.

(3) The written agreement referred to in subsection (1) may include,

- (a) an authorization and direction to the person or agency by whom the money is payable to deduct and pay the money directly to the municipality, band or Ontario, as the case may be; and
- (b) an assignment by the applicant, recipient or dependant to the municipality, band or Ontario, as the case may be, of the right to be paid the money by the person or agency by whom the money is payable.

(4) Where the subject of the agreement under subsection (1) is periodic payments of money, the agreement will only be for the reimbursement of that assistance which is payable for the same

period in relation to which the applicant, recipient or dependant is owed or will receive a payment of money. O. Reg. 625/90, s. 1 (2).

(5) The amount of the assistance for which a municipality, band or Ontario is entitled to be reimbursed under the agreement in subsection (1) shall not exceed,

- (a) the total amount of the assistance paid to the recipient during the period in respect of which the money is payable; or
- (b) the proportion of the assistance payable to the applicant or recipient on behalf of the dependant who receives or will receive the payment of money, except where the dependant is the spouse of the applicant or recipient.

(6) An applicant or recipient is not ineligible for assistance solely by reason of the failure of any other person or authority to deduct and remit money to a municipality, band or Ontario under an authorization and direction or an assignment under subsection (3). O. Reg. 625/90, s. 1 (3).

6.—(1) Where, at any time within the three years preceding the date of application for assistance or any time subsequent thereto, an applicant or recipient or a dependant of the applicant or recipient has made an assignment or transfer of liquid assets and, in the opinion of the welfare administrator, the consideration for the assignment or transfer was inadequate or the assignment or transfer was made for the purpose of qualifying the applicant or recipient for assistance, the welfare administrator may determine that the applicant or recipient is not eligible for assistance or the welfare administrator may reduce the amount of the assistance granted to compensate for the inadequate consideration.

(2) Where an applicant or recipient is a foster parent and where, at any time within the three years preceding the date of application for assistance or at any time subsequent thereto, the person who has control over the transfer or assignment of the liquid assets of the foster child has made a transfer or assignment of the liquid assets and, in the opinion of the welfare administrator, the consideration for the transfer or assignment was inadequate or the transfer or assignment was made for the purpose of qualifying the applicant or recipient for assistance, the welfare administrator may determine that the applicant or recipient is not eligible for assistance or the welfare administrator may reduce the amount of assistance granted to compensate for the inadequate consideration. O. Reg. 786/82, s. 2.

7.—(1) An applicant or a recipient or a dependent adult of an applicant or recipient shall continue to be eligible for assistance under the Act and this Regulation where the applicant, recipient or dependent adult is, with the approval of the welfare administrator, in attendance as a full-time student,

- (a) at an elementary school, a secondary school or a private school under the *Education Act*, that is approved by the welfare administrator;
- (b) subject to subsection (2), at a college of applied arts and technology established under the *Ministry of Colleges and Universities Act* in a program that is equivalent to a program given at an institution referred to in clause (a), that is approved by the welfare administrator and the Director; or
- (c) subject to subsection (2), in a course of education or program of training that is approved by the welfare administrator and the Director,

provided that the applicant, recipient or dependent adult otherwise remains eligible for assistance under the Act and this Regulation. O. Reg. 402/84, s. 3, part.

(2) Clauses (1) (b) and (c) do not apply to a person who is eligible to receive a grant under Regulation 775 of Revised Regulations of Ontario, 1990. O. Reg. 395/86, s. 2, part.

(3) An applicant or a recipient who is a head of a family with no

spouse included for the purpose of computing the amount of assistance and who has one or more dependent children shall continue to be eligible for assistance under the Act and this Regulation where the applicant or recipient is, with the approval of the welfare administrator, in attendance as a full-time student in an educational program that is approved by the welfare administrator provided that the applicant or recipient otherwise remains eligible for assistance under the Act and this Regulation. O. Reg. 402/84, s. 3, *part*.

(4) An employable person under the age of eighteen years is not eligible for assistance unless,

- (a) the person is a head of a family whose spouse is absent; or
- (b) there are special circumstances that justify the assistance. O. Reg. 395/86, s. 2, *part*.

(5) A dependant is not eligible for assistance as the head of a family. O. Reg. 402/84, s. 3, *part*.

(6) An applicant or recipient who is a person in need referred to in clause 1 (4) (b) of this Regulation is not eligible for assistance where the applicant or recipient is living with another person who,

- (a) is the spouse of the applicant or recipient; or
- (b) provides an economic contribution to the applicant or recipient or his or her dependants that exceeds the amount of the assistance to which the applicant or recipient would otherwise have been entitled. O. Reg. 590/87, s. 2.

CLASSES OF ASSISTANCE

8. The classes of assistance are general assistance, special assistance, supplementary aid and incentive allowances. R.R.O. 1980, Reg. 441, s. 7.

APPLICATION FOR ASSISTANCE

9.—(1) An application for general assistance, other than by a foster parent on behalf of a foster child or for general assistance in a hostel or nursing home, shall be in Form 1 of this Regulation or Form 1 of Regulation 366 of Revised Regulations of Ontario, 1990 (General).

(2) An application by a foster parent for general assistance on behalf of a foster child shall be in Form 2 of this Regulation or Form 2 of Regulation 366 of Revised Regulations of Ontario, 1990 (General).

(3) An application under subsection (1) or (2) shall be accompanied by a consent to disclose and verify information in Form 3 of this Regulation or Form 3 of Regulation 366 of Revised Regulations of Ontario, 1990 (General).

(4) An application for any class of assistance that is made by an unemployable person or a resident of a nursing home shall, where required by a welfare administrator, be accompanied by a report of a legally qualified medical practitioner in Form 4 of this Regulation, Form 4 of Regulation 366 of Revised Regulations of Ontario, 1990 (General) or Form 2 of Regulation 1095 of Revised Regulations of Ontario, 1990 (General). O. Reg. 137/85, s. 1, *part*.

(5) Ontario shall pay, on behalf of an applicant or recipient, the cost of completion of a medical report in the amount of \$15,

- (a) if it is a report prepared under subsection (4);
 - (b) if it is a report supplementary to a report prepared under subsection (4) and it is submitted by a physician at the request of the welfare administrator. O. Reg. 554/89, s. 1.
- (6) An application for,
- (a) general assistance,

(i) in a hostel, or

(ii) in a nursing home;

(b) special assistance, where the applicant is not in receipt of general assistance;

(c) supplementary aid; or

(d) an incentive allowance,

shall be in Form 5.

(7) Where an applicant for special assistance or supplementary aid is a recipient of general assistance or a recipient of an allowance under the *Family Benefits Act*, an application by the applicant in Form 1 of this Regulation or Form 1 of Regulation 366 of Revised Regulations of Ontario, 1990 (General), as the case may be, shall be deemed to be an application required under subsection (6).

(8) Where an application is made under subsection (6), a consent in Form 3 of this Regulation or Form 3 of Regulation 366 of Revised Regulations of Ontario, 1990 (General) shall accompany the application where required by a welfare administrator.

(9) In determining the eligibility of an applicant who applies for assistance under subsection (2) or (6), a welfare administrator shall make or cause to be made an enquiry into the living conditions and financial and other circumstances of the applicant, his or her spouse and dependants, except where an emergency exists as referred to in subsection (11). O. Reg. 137/85, s. 1, *part*.

(10) In determining the eligibility of an applicant who applies for assistance under subsection (1), the welfare administrator shall,

(a) make or cause to be made a visit to the home of the applicant for the purpose of enquiring into the living conditions and financial and other circumstances of the applicant and any dependants within one month of the issuance of assistance unless the visit is dispensed with by the Director; and

(b) at such times as the Director directs, make or cause to be made a visit to the home of the recipient for the purpose of preparing a report on any circumstances of the recipient that might affect the eligibility of the recipient for the amount or continuance of assistance or any other matter relating thereto. O. Reg. 137/85, s. 1, *part*; O. Reg. 445/90, s. 1 (1).

(11) Where an applicant requires assistance because of an emergency, assistance may be paid without an application being made under subsection (1), (2) or (6) for a period of not more than one-half of a month and thereafter assistance shall only be paid after an application is made under subsection (1), (2) or (6). O. Reg. 137/85, s. 1, *part*.

(12) Despite subsections (1) and (2), an application for assistance may be made to the welfare administrator in a form provided by the Director if, within one year before the date of application, an applicant applied for assistance in Form 1 or 2 or received assistance. O. Reg. 445/90, s. 1 (2).

RETURNS BY WELFARE ADMINISTRATOR

10.—(1) A welfare administrator who grants assistance, in a month shall,

(a) complete an application for monthly payment of subsidy by the Province,

(i) in Form 6 for each class of assistance, other than an incentive allowance, paid in that month,

(ii) where applicable, in Form 7 for the cost of administration of welfare services as defined in section 24

paid in that month other than in respect of the operation or maintenance of work activity projects as defined in section 20,

- (iii) where applicable, in Form 8 for the cost of staff training as defined in section 24 paid in that month, and
- (iv) where applicable, in Form 9 for incentive allowances and administration costs for work activity projects, paid in that month,

and shall forward it to the Minister before the 20th day of the month next following; and

- (b) complete a separate statement of account for each recipient to whom or on whose behalf assistance has been paid during that month and retain the statement in the welfare administrator's files. R.R.O. 1980, Reg. 441, s. 9 (1); O. Reg. 137/85, s. 2 (1).

(2) The Minister may require,

- (a) the welfare administrator to provide the Minister with such information as to the contents of Forms 6, 7, 8 and 9 as the Minister considers necessary; and
- (b) an inspection and audit of books, accounts and vouchers of the municipality or approved band relating to the statement of account in Forms 6, 7, 8 and 9. R.R.O. 1980, Reg. 441, s. 9 (2); O. Reg. 137/85, s. 2 (2).

(3) The welfare administrator shall provide the Director or a regional welfare administrator with such information and evidence as the Director or the regional welfare administrator, as the case may be, may require with respect to an applicant or recipient to determine whether or not an applicant or recipient is eligible for assistance in accordance with the Act and this Regulation. O. Reg. 137/85, s. 2 (3).

(4) The welfare administrator shall review at regular intervals the eligibility of a recipient for general assistance and the amount thereof. R.R.O. 1980, Reg. 441, s. 9 (4).

(5) For the purpose of subsection (6), "persons" means recipients and any dependants of recipients included for the purpose of calculating the amount of general assistance paid but does not include recipients or their dependants for whom a municipality is entitled to be reimbursed by the Province of Ontario under subsection 23 (1).

(6) Where, in any period of four consecutive months, the monthly average of the number of persons to or on behalf of whom a municipality has paid general assistance equals or exceeds 4 per cent of the population of the municipality, as determined by the most recent census made under the *Assessment Act*, the amount of any subsidy payable by the Province of Ontario in respect of the number of persons in excess of 4 per cent of the population for any month included in the four-month period shall be 90 per cent instead of 80 per cent otherwise prescribed in this Regulation. O. Reg. 657/83, s. 1.

PUBLICATION

11.—(1) No municipality or approved band shall print for public distribution, broadcast or post up in a public place, or cause to be so printed, broadcast or posted up or otherwise cause to be made public, the identity of any person who is eligible for or receives assistance. R.R.O. 1980, Reg. 441, s. 10.

(2) Despite subsection (1), a municipality or an approved band may exchange information with the Ministry of Community and Social Services, the Government of Canada, the government of any other province, any agency thereof, or any of them in order to verify information for the sole purposes of determining or verifying the eli-

gibility of any person for assistance and for no other purpose. O. Reg. 137/85, s. 3.

12.—(1) Subject to subsection (5) and sections 4, 6 and 7, general assistance shall be paid to or on behalf of every single person or head of a family if that person is in need and is not a resident in an institution other than a nursing home or hostel,

- (a) by a municipality, where the person resides within the municipality;
- (b) by the council of an approved band, where the person,
 - (i) is a member of the band, and
 - (ii) resides on the reserve of the band; or
- (c) by the Province of Ontario, where the person resides in territory without municipal organization,

in an amount by which the budgetary requirements of the applicant or recipient determined in accordance with sections 13 and 31 exceed the income of the applicant or recipient as determined in accordance with section 15. O. Reg. 824/84, s. 1 (1); O. Reg. 395/86, s. 3; O. Reg. 590/87, s. 3.

(2) Despite subsection (1), the amount of general assistance for an applicant or recipient shall be \$2.50 per month for any month in which,

- (a) the person is not entitled to general assistance under subsection (1) because his or her income exceeds his or her budgetary requirements but the person is otherwise entitled to it; and
- (b) the person's income determined under section 15 does not exceed his or her budgetary requirements determined under section 13 or 31, as the case may be, by,
 - (i) more than \$50 per month for a single person,
 - (ii) more than \$100 per month for a person with one or more dependants.

(3) Despite subsection (1), the amount of general assistance for an applicant or recipient shall be \$2.50 per month for any month in which,

- (a) the person is not entitled to general assistance under subsection (1) because his or her income exceeds his or her budgetary requirements but the person is otherwise entitled to it; and
- (b) the person's income determined in accordance with section 15 is less than the sum of,
 - (i) the person's budgetary requirements determined in accordance with section 13 or 31, as the case may be, and
 - (ii) the value of any benefits the person would have received under sections 21 and 22 if the person were entitled to general assistance under subsection (1).

(4) Despite subsection (1), if the amount of any payment is determined under subsection (1) to be more than zero and less than \$2.50 in any month, the amount shall be increased to \$2.50. O. Reg. 525/89, s. 1.

(5) Where an applicant or recipient or the spouse or a dependant of the applicant or recipient is a patient in a hospital, the welfare administrator may, having regard to the budgetary requirements and income of the applicant or recipient, determine the amount of general assistance that may be paid to or on behalf of the applicant or recipient. O. Reg. 786/82, s. 4 (1).

(6) Subject to sections 4, 6 and 7, general assistance shall be paid to or on behalf of any person in need who is a resident in a nursing home and who is receiving extended care services,

- (a) by a municipality when the person resides within the municipality;
- (b) by the council of an approved band where the person,
 - (i) is a member of the band, and
 - (ii) resides on the reserve of the band; and
- (c) by the Province of Ontario where the person resides in territory without municipal organization,

in an amount that does not exceed the amount set out in Column 3 of Schedule E, being the cost of the person's care in a home, less an amount that does not exceed the amount set out opposite thereto in Column 2 of Schedule E, being the person's income, if any, set out opposite the date the service was provided in Column 1 of Schedule E. R.R.O. 1980, Reg. 441, s. 11 (5); O. Reg. 824/84, s. 1 (3).

(7) Subject to subsection (8), subsection 10 (5) and section 23, Ontario shall pay by way of reimbursement to the municipality or to the council of the approved band,

- (a) 80 per cent of the amount of general assistance paid to or on behalf of the person eligible therefor under subsection (1); and
- (b) in respect of a person eligible for general assistance under subsection (6), the aggregate of,
 - (i) 80 per cent of the part of general assistance paid for any part of the basic rate in Column 2 set out opposite the date the service was provided in Column 1 of Schedule C,
 - (ii) 100 per cent of the part of general assistance paid for that part of the cost of his or her care that exceeds the basic rate in Column 2 but that does not exceed the ceiling for extended care services in Column 3, both set out opposite the date the service was provided in Column 1 of Schedule C. R.R.O. 1980, Reg. 441, s. 11 (6).

(8) Any amounts of general assistance paid by the council of an approved band to or on behalf of a person not a member of the band but who would otherwise be eligible for general assistance under subsection (1) or (6) shall be included for the purpose of determining the amount of the subsidy payable under subsection (7). O. Reg. 361/83, s. 1.

(9) For the purposes of determining a monthly amount under subsections (6) and (7), the Director may determine the number of days in the month in such manner as he or she decides. R.R.O. 1980, Reg. 441, s. 11 (8).

13.—(1) In this section,

“room” means a room other than a bathroom, hall or closet;

“shelter” means the cost for a dwelling place in respect of,

- (a) rent,
- (b) principal and interest on a mortgage,
- (c) an agreement for sale,
- (d) municipal taxes,
- (e) premiums for a policy of fire insurance covering the dwelling place or the contents thereof, and

(f) payments approved by the welfare administrator for the preservation, maintenance and use of the property where such payments are reasonable and necessary,

(g) the amount of common expenses required to be contributed for a condominium unit except that portion of the common expenses allocated to the cost of energy for heat, and

(h) any of the following utilities, if their cost is not included in rent or condominium fees:

1. Any energy source used for household purposes other than heating a dwelling.
2. Water and sewage,

but does not include, with respect to the dwelling place, any refund or payment under section 8 of the *Income Tax Act* or grant under section 2 or section 7 of the *Ontario Pensioners Property Tax Assistance Act* to any applicant, recipient or dependant of any applicant or recipient; and

“tenant in subsidized housing” means an applicant or recipient who is a tenant paying rent that is geared to income in housing accommodation that is owned, operated or provided by or on behalf of the Crown in right of Canada, the Crown in right of Ontario, a municipality or any agency of one of them. R.R.O. 1980, Reg. 441, s. 12 (1); O. Reg. 361/83, s. 2 (1); O. Reg. 549/88, s. 2 (1, 2).

(2) If the cost of any of the utilities described in clause (h) of the definition of “shelter” in subsection (1) is not included in rent or condominium fees and the actual monthly cost of all of those utilities is less than the amount shown in the following Table, their monthly cost for the purpose of clause (h) of the definition of “shelter” in subsection (1) shall be deemed to be the amount shown in the following Table:

TABLE

Number of Beneficiaries	Amount
1	\$ 35
2	50
3	55
4	60
5	65
6 or more	70

(3) For the purpose of calculating shelter under the definition of “shelter” in subsection (1) in respect of a tenant in subsidized housing, the rent shall be adjusted so that the sum of that adjusted rent and the cost of utilities is not less than the fully serviced rent scale as established by the Ontario Housing Corporation for the applicable year and is not more than that rent scale for 1989. O. Reg. 687/89, s. 1 (1).

(4) Subject to subsection (5), for the purpose of determining a person in need of general assistance, the budgetary requirements of an applicant or recipient shall be determined as follows:

1. Where the applicant or recipient receives board and lodging from the same source and the source is supplying the board and lodging for profit or is an agency approved by the welfare administrator and operated by a corporation incorporated under Part III of the *Corporations Act*, an amount for basic needs that is,
 - i. the amount actually paid for board and lodging if that amount is not less than the minimum amount determined under Schedule A and not more than the maximum amount determined under Schedule A,

- ii. the minimum amount determined under Schedule A if the amount actually paid for board and lodging is less than that amount,
 - iii. the maximum amount determined under Schedule A if the amount actually paid for board and lodging is greater than that amount.
2. Where the basic needs of an applicant or recipient are not determined under paragraph 1 and the applicant or recipient receives board and lodging from the same source, an amount for basic needs that is,
- i. the amount actually paid for board and lodging if that amount is not less than the minimum amount determined under Schedule B and not more than the maximum amount determined under Schedule B,
 - ii. the minimum amount determined under Schedule B if the amount actually paid for board and lodging is less than that amount,
 - iii. the maximum amount determined under Schedule B if the amount actually paid for board and lodging is greater than that amount.
3. The welfare administrator may increase the amount for basic needs under paragraph 1 or 2 after taking into account any special needs of the applicant or recipient or any dependant of the applicant or recipient, but in no case shall that amount for basic needs exceed the maximum amount determined under Schedule A or B, as the case may be.
4. Where the basic needs of an applicant or recipient are not determined under paragraph 1 or 2, an amount for basic needs that is the sum of the amount for basic allowance determined in accordance with Schedule C and the amount for basic shelter determined in accordance with Schedule D.
5. Where a recipient,
- i. was in receipt of assistance in the month of October, 1987,
 - ii. had the amount determined for basic needs reduced in October, 1987 under paragraph 5 of subsection 12 (2) of Regulation 441 of Revised Regulations of Ontario, 1980 as it existed on the 31st day of October, 1987,
 - iii. continues to be eligible for assistance, and
 - iv. continues to share accommodation with another adult person other than a dependant of the recipient,
- the welfare administrator may reduce the amount determined for basic needs by an amount not exceeding 15 per cent.
6. Where a physician certifies that an applicant or recipient or a dependant of an applicant or recipient is pregnant or where the applicant or recipient or a dependant of an applicant or recipient has given birth to a child or has care, custody and control of a new born child for additional needs due to the pregnancy or birth, an amount not exceeding \$8.10 weekly or \$35 monthly for a period not exceeding six months, commencing in any month after the third month of pregnancy and ending not later than the sixth month after the birth of the child.
7. Where a physician certifies that an applicant or recipient or a dependant of the applicant or recipient requires a special diet and signs a statement setting out in detail the special diet required, the monthly amount determined for basic

needs may be increased by an amount not in excess of the additional cost required to provide the special diet.

8. Subject to paragraph 9, where the cost of shelter plus the cost of energy for heat exceeds the appropriate amount for basic shelter allowance set out in Schedule D, the welfare administrator shall increase the monthly budgetary requirements by a variable shelter allowance in an amount which is the lesser of,
- i. the sum of the actual cost of shelter and the cost of energy for heat less the appropriate amount for basic shelter allowance determined under Schedule D, and
 - ii. the appropriate amount set out in the following Table:

TABLE

Family Size	Maximum Monthly Variable Shelter Allowance
1	\$265
2	420
3	450
4	495
5	540
6 or more	560

9. The monthly budgetary requirements of an applicant or recipient whose basic needs are determined under Schedules C and D shall be increased by the cost of energy for heat, as determined by the welfare administrator, and not by the amount of the variable shelter allowance under paragraph 8 if the cost of energy for heat exceeds the amount of variable shelter allowance.
10. A monthly amount for personal needs due to advanced age equal to,
- i. \$30, where the applicant or recipient is,
 - A. a single person who has attained the age of sixty-five years, or
 - B. the head of a family and either the applicant or recipient or the spouse of the applicant or recipient but not both of them has attained the age of sixty-five years, or
 - ii. \$60, where the applicant or recipient and the spouse of the applicant or recipient have both attained the age of sixty-five years.
11. Despite paragraph 10, where on the 31st day of January, 1980, the budgetary requirements of a recipient included a monthly amount for personal needs due to advanced age equal to,
- i. \$226.18, where the recipient was the head of a family and the recipient and the spouse of the recipient had both attained the age of sixty-five years but only one of them was receiving a pension under the *Old Age Security Act* (Canada), or
 - ii. \$196.18, where the recipient was the head of a family and either the recipient or one of the dependants of the recipient but not both of them had attained the age of sixty-five years and was receiving a pension under the *Old Age Security Act* (Canada),

the budgetary requirements of the recipient shall continue to include a monthly amount for personal needs due to advanced age equal to the amount included on the 31st day

of January, 1980. O. Reg. 824/84, s. 2 (1); O. Reg. 677/85, s. 1 (1, 2); O. Reg. 503/86, s. 1; O. Reg. 741/86, s. 1 (1, 2); O. Reg. 590/87, s. 4; O. Reg. 713/87, s. 1 (1, 2); O. Reg. 549/88, s. 2 (4, 5); O. Reg. 747/88, s. 1 (1, 2); O. Reg. 687/89, s. 1 (2-10); O. Reg. 681/90, s. 1 (1, 2).

(5) For the purpose of determining a person in need of general assistance and for the purpose of subsection 12 (1), the monthly budgetary requirement of an applicant or recipient,

- (a) who is a resident in a nursing home, is,
 - (i) the cost of the applicants' or recipients' care in the home in an amount that does not exceed the amount set out in Column 3 of Schedule E set out opposite the date the service was provided in Column 1 of Schedule E multiplied by the number of days in the month that the applicant or recipient is entitled to receive extended care services, and
 - (ii) the cost of the applicants' or recipients' care in the home in an amount that does not exceed the amount set out in Column 5 of Schedule E set out opposite the date the service was provided in Column 1 of Schedule E multiplied by the number of days in the month that the applicant or recipient is not entitled to receive extended care services;
- (b) who is a resident in a hostel, is the cost approved by the Director of providing the applicant or recipient with board or lodging in the hostel and with personal needs; and
- (c) who is a foster parent with a foster child other than a child in the care of a children's aid society within the meaning of the *Child and Family Services Act*, is a monthly amount equal to \$206 for the first foster child and \$168 for each additional foster child. O. Reg. 824/84, s. 2 (3); O. Reg. 677/85, s. 1 (3); O. Reg. 741/86, s. 1 (3); O. Reg. 713/87, s. 1 (3); O. Reg. 747/88, s. 1 (3); O. Reg. 527/89, s. 1; O. Reg. 687/89, s. 1 (11); O. Reg. 681/90, s. 1 (3).

14. Where,

- (a) a person was a recipient of general assistance in the month of December, 1983;
- (b) the person's budgetary requirements determined for the month of December, 1983, included a shelter subsidy calculated in accordance with paragraph 9 of subsection 12 (2) of Regulation 441 of Revised Regulations of Ontario, 1980;
- (c) the person's cost of shelter as determined by the welfare administrator, was the same for the month of January, 1984, as for the month of December, 1983; and
- (d) as a result of the application of paragraph 9 of subsection 12 (2) of Regulation 441 of Revised Regulations of Ontario, 1980 the amount of shelter subsidy for which the person was eligible in January, 1984, is less than the amount of shelter subsidy for which the person was eligible in December, 1983,

the welfare administrator may continue to calculate the shelter subsidy for which the person may be eligible according to paragraph 9 of subsection 12 (2) of Regulation 441 of Revised Regulations of Ontario, 1980 as it existed on the 31st day of December, 1983, until the person ceases to be a recipient of general assistance. O. Reg. 785/83, s. 3, *part*.

15.—(1) For the purposes of determining a person in need and for the purposes of subsection 12 (1) and subsection 18 (1), the income of an applicant or recipient shall include all payments of any nature or kind whatsoever received by or on behalf of,

- (a) the applicant or recipient;

- (b) the spouse of the applicant or recipient where the spouse is living with the applicant or recipient, as the case may be;
- (c) any dependant of the applicant or recipient other than,
 - (i) the earnings of a dependent child or the amount paid to a dependent child under a training program, and
 - (ii) the earnings of a dependent adult, other than a spouse, if the adult is attending school full time or the amount paid to such a dependent adult under a training program; and
- (d) where the applicant or recipient is a foster parent, the foster child, other than the earnings of the foster child. R.R.O. 1980, Reg. 441, s. 13 (1); O. Reg. 786/82, s. 6 (1); O. Reg. 708/84, s. 5 (1, 2); O. Reg. 525/89, s. 2 (1, 2).

(2) For the purposes of subsection (1) and without restricting the generality of subsection (1), income shall include,

1. the total amount payable in respect of gross monthly income from wages, salaries and casual earnings and, in the case of an applicant, recipient or spouse who is an unemployable person or a head of a family with no spouse included for the purpose of computing the amount of assistance, the net monthly income as determined by the welfare administrator from that person's interest in or operation of a business less,
 - i. the total amount of deductions from wages, salaries and casual earnings made in respect of income tax, *Canada Pension Plan* and unemployment insurance,
 - ii. subject to subsection (8), an amount equal to \$75 monthly for a single person, \$175 for the head of a family with no spouse and \$150 monthly in any other case,
 - iii. subject to subsection (9), child care expenses actually incurred for each dependent child and not otherwise reimbursed or subject to reimbursement up to the maximum amount provided in subsection (10) if the child care expenses are necessary to permit a recipient or spouse to be employed or to participate in a training program and if,
 - A. the recipient is the head of a family with no spouse and is employed or in a training program,
 - B. the recipient is the head of a family with a spouse and both of them are either employed or in a training program, or
 - C. the recipient is the head of a family with a spouse and the recipient or his or her spouse is employed or in a training program and, in the opinion of the welfare administrator, the other is unable to provide the child care, and
 - iv. 20 per cent of the amount by which the monthly income determined under this paragraph exceeds the total amount of exemptions to which the person is entitled under subparagraphs i, ii and iii;
2. subject to subsection (7), all regular and periodic payments received under any annuity, pension plan, superannuation scheme or insurance benefit;
3. subject to subsection (7), all payments received under a mortgage, agreement for sale or loan agreement;
4. subject to subsection (7), all payments received under the *Old Age Security Act* (Canada);

5. subject to subsection (7), all increments received under the *Ontario Guaranteed Annual Income Act*;
 6. subject to subsection (7), all pensions or payments received under the legislation of any other country;
 7. subject to subsection (7), all payments for support or maintenance received under an order made by a court of competent jurisdiction or under a domestic contract or an agreement with the putative father of a child born out of wedlock;
 8. amounts paid under training programs after deducting from them,
 - i. \$50 monthly for a single person or \$100 monthly if there are one or more dependants,
 - ii. child care expenses as determined under subparagraph iii of paragraph 1, and
 - iii. any other expenses determined by the welfare administrator to be necessary for taking the training program;
 9. subject to subsection (7), where the applicant or recipient is a sponsored dependent or nominated relative within the meaning of the regulations under the *Immigration Act* (Canada), payments available to the applicant or recipient as determined by the welfare administrator, under any undertaking or engagement made on his or her behalf under the said regulations, between the Government of Canada and any person nominating or sponsoring him or her;
 10. subject to subsection (7), all payments received under the *Compensation for Victims of Crime Act*, except a payment under clause 7 (1) (a) or (d) of that Act;
 11. where a recipient was in receipt of assistance or any allowance under the *Family Benefits Act* in the month of October, 1987, had advised a welfare administrator or the Director in or prior to that month that he or she was providing lodging to a person, had income as defined in paragraph 11 of subsection 13 (2) of Regulation 441 of Revised Regulations of Ontario, 1980 as it existed on the 31st day of October, 1987 or paragraph 12 of subsection 13 (2) of Regulation 318 of Revised Regulations of Ontario, 1980 (General) as it existed on the 31st day of October, 1987 and is providing lodging to a person, a monthly amount that shall be deemed to be paid by the person to the recipient, which amount shall be,
 - i. \$40 where the person is 18 years of age or more and is being provided with meals in addition to lodging, or
 - ii. \$20 where the person is under 18 years of age or is not being provided with meals;
 12. any payment received from the sale or other disposition of an asset, except that portion of the payment that is applied, or where the welfare administrator approves will be applied towards,
 - i. the purchase by the applicant or recipient or the spouse of the applicant or recipient of a principal residence used by the applicant or recipient, or
 - ii. the purchase of any other asset that in the opinion of the welfare administrator is necessary for the health or welfare of the applicant or recipient or a dependent of the applicant or recipient;
 13. where an applicant or recipient is providing lodging and meals to a person and paragraph 11 does not apply, an amount for each such person that is equal to the greater of,
 - i. 40 per cent of the amount received from such person, or
 - ii. \$40;
 14. where an applicant or recipient is providing lodging without meals to a person and paragraph 11 does not apply, an amount for each such person that is equal to the greater of,
 - i. 60 per cent of the amount received from such person, or
 - ii. \$40;
 15. subject to subsection (7), all payments received by or on behalf of an applicant, recipient or beneficiary under the *Pension Act* (Canada), the *Unemployment Insurance Act* (Canada), the *War Veterans Allowance Act* (Canada), the *Civilian War Pensions and Allowances Act* (Canada), the *Quebec Pension Plan* (Quebec), the *Canada Pension Plan* and the *Workers' Compensation Act*;
- but shall not include,
16. any benefits received under this Act and the Regulations;
 17. 40 per cent of the gross income as determined by the welfare administrator received from rented self-contained quarters;
 18. family allowances paid under the *Family Allowances Act* (Canada);
 19. any payment received under section 32 or 38 of Regulation 366 of Revised Regulations of Ontario, 1990, made under the *Family Benefits Act*;
 20. any payment under an Order-in-Council made under subsection 8 (1) of the *Family Benefits Act* in respect of a severely handicapped child, where the applicant is not eligible for a benefit under section 32 of Regulation 366 of Revised Regulations of Ontario, 1990, made under that Act;
 21. any payment received as a child tax credit by reason of section 122.2 of the *Income Tax Act* (Canada);
 22. any payment received as a sales tax credit by reason of the application of section 122.4 of the *Income Tax Act* (Canada);
 23. payments made by children's aid societies on behalf of a child in care under the *Child and Family Services Act*;
 24. donations received from a religious, charitable or benevolent organization;
 25. casual gifts of small value;
 26. casual payments of small value;
 27. any payment or refund under section 8 of the *Income Tax Act*;
 28. any grant received under section 2 or 7 of the *Ontario Pensioners Property Tax Assistance Act*;
 29. where the recipient is a resident in a nursing home and is not in receipt of a personal needs allowance by way of special assistance, an amount determined by the welfare administrator that does not exceed \$100, and where the

- recipient is sixty-five years of age or older an additional amount that does not exceed \$12;
30. payments by relatives or friends of the applicant or recipient residing in a nursing home in respect of special services provided by the operator of the nursing home;
 31. any payments received by way of an incentive allowance under section 20;
 32. any payment received under Orders-in-Council numbered OC-3410/70 and OC-2403/71, or either of them, made under section 5 of the *Department of Agriculture and Food Act* being chapter 109 of the Revised Statutes of Ontario, 1970;
 33. any grant received by a student under Regulation 775 of Revised Regulations of Ontario, 1990 made under the *Ministry of Colleges and Universities Act*;
 34. any bursary received by a student under Regulation 773 of Revised Regulations of Ontario, 1990 made under the *Ministry of Colleges and Universities Act*;
 35. any grant received by a part-time student enrolled in a post-secondary institution, under clause 7 (a) of the *Ministry of Colleges and Universities Act*;
 36. any bursary received by a full-time student enrolled in a secondary school under paragraph 8 (1) 18. of the *Education Act*;
 37. interest and dividends earned on liquid assets;
 38. any payment received pursuant to the *Indian Act* (Canada) under a treaty between Her Majesty and an Indian band.
 39. where the applicant or recipient or dependant of an applicant or recipient is in receipt of a grant under section 34.5 of the *National Housing Act* (Canada), 1980-81-82-83, c. 93, s. 25, an amount that is the lesser of,
 - i. the average monthly amount of the grant, or
 - ii. the amount by which the cost of shelter of the applicant or recipient as determined by the welfare administrator exceeds the applicable amount set out in Column 1 of the following Table:

TABLE

Number of Beneficiaries	COLUMN 1
1	\$200
2	283
3	307
4	330
5	353
6 or more	377

40. any payment received under clause 175 (f) of the *Child and Family Services Act*;
41. any payment received under subsection 2 (2) of the *Developmental Services Act*;
42. any payment made by an Indian Band as an incentive bonus for school attendance to any dependant of an applicant or a recipient who is attending school;
43. any death benefit payment under the *Canada Pension Plan*;
44. an amount received as damages or compensation for,

- i. pain and suffering, or
- ii. expenses actually and reasonably incurred or to be incurred as a result of injury to or the death of an applicant, recipient, dependent adult or dependent child,

up to a maximum amount of \$25,000;

45. any payment received under the *Ministry of Community and Social Services Act*.

R.R.O. 1980, Reg. 441, s. 13 (2); O. Reg. 655/82, s. 2; O. Reg. 786/82, s. 6 (2); O. Reg. 361/83, s. 3; O. Reg. 657/83, s. 2 (1); O. Reg. 691/83, s. 5; O. Reg. 785/83, s. 4; O. Reg. 214/84, s. 4 (1-5); O. Reg. 708/84, s. 5 (3, 4); O. Reg. 824/84, s. 3; O. Reg. 395/86, s. 4 (1); O. Reg. 170/87, s. 1; O. Reg. 381/87, s. 1; O. Reg. 590/87, s. 5 (1, 2); O. Reg. 164/89, s. 2; O. Reg. 339/89, s. 1; O. Reg. 525/89, s. 2 (3-5); O. Reg. 47/90, s. 1 (1), *revised*.

(3) Paragraph 11 of subsection (2) does not apply to a recipient who,

- (a) ceases to be eligible for assistance under this Act and an allowance under the *Family Benefits Act* and subsequently becomes eligible for such assistance or allowance; or
- (b) has no income as set out in the said paragraph 11 or in paragraph 11 of subsection 13 (2) of Regulation 366 of Revised Regulations of Ontario, 1990 (General) for a period of two consecutive months. O. Reg. 590/87, s. 5 (3).

(4) Despite subsection (1), the income determined for the purpose of that subsection of a foster parent who is an applicant for or recipient of general assistance for a foster child shall include only those payments to or on behalf of the foster child, other than the casual earnings of the foster child. O. Reg. 786/82, s. 6 (3).

(5) Despite subsection (1), in determining the amount of income under this section, the welfare administrator may average the gross income for wages, salaries and casual earnings over a period,

- (a) not exceeding six months, where the applicant or recipient is a person referred to in clause 1 (4) (d) or (e); or
- (b) not exceeding four months in all cases other than those referred to in clause (a). O. Reg. 395/86, s. 4 (2), *part*.

(6) When the welfare administrator averages income for a period under subsection (5), he or she shall also average any deductions for income tax, *Canada Pension Plan* and unemployment insurance for the same period. O. Reg. 525/89, s. 2 (6), *part*.

(7) Where any payment of income referred to in paragraph 2, 3, 4, 5, 6, 7, 9, 10 or 15 of subsection (2) applies to a number of months, the welfare administrator may average the income over that number of months. O. Reg. 395/86, s. 4 (2), *part*; O. Reg. 47/90, s. 1 (2).

(8) The amount determined under subparagraph ii of paragraph 1 of subsection (2) shall be decreased by any amount that is deducted from a training allowance under subparagraph i of paragraph 8 of subsection (2).

(9) The amount determined under subparagraph iii of paragraph 1 of subsection (2) shall be decreased by any amount that is deducted from a training allowance under subparagraph ii of paragraph 8 of subsection (2).

(10) The maximum amount of child care expenses permitted for each child is the actual amount paid if those expenses are paid to a child care provider licensed under the *Day Nurseries Act* and otherwise is,

- (a) \$390 per month if the child is less than six years of age;

- (b) subject to clause (c), \$346 per month if the child is six years of age or older and less than thirteen years of age;
- (c) \$390 per month if the child is six years of age or older and less than thirteen years of age and, in the opinion of the welfare administrator, increased child care costs are required for the child because of special circumstances;
- (d) \$390 per month if the child is thirteen years of age or older and, in the opinion of the welfare administrator, the child requires child care because of special circumstances.

(11) Subparagraph iii of paragraph 1 of subsection (2) does not apply to child care expenses paid to a dependant in respect of whom the recipient receives general assistance.

(12) An amount paid under a training program is deemed to be income under paragraph 1 of subsection (2) and not a payment from a training program under paragraph 8 of that subsection if it is subject to deductions in respect of income tax, *Canada Pension Plan* and unemployment insurance. O. Reg. 525/89, s. 2 (6), *part*.

16.—(1) Where a recipient who has been resident in an institution approved by the Director is discharged or about to be discharged from the institution in order to establish a permanent residence in the community and, in the opinion of the welfare administrator, needs financial assistance in establishing the residence, there shall be paid to the recipient, in addition to the amount of general assistance computed in accordance with subsection 12 (1), an amount determined by the welfare administrator up to a maximum of \$600. O. Reg. 741/86, s. 2; O. Reg. 713/87, s. 2; O. Reg. 747/88, s. 2; O. Reg. 687/89, s. 3; O. Reg. 681/90, s. 2.

(2) The welfare administrator shall not make a payment to a recipient under subsection (1) more than once in any twelve month period without the approval of the Director. O. Reg. 785/83, s. 3, *part*.

(3) If a dependent adult who is not attending school full time or a recipient or spouse begins employment other than in a training program or changes employment, there shall be paid to the recipient, in addition to the amount of general assistance computed under subsection 12 (1), an amount determined by the welfare administrator for expenses reasonably necessary for the person to begin or change employment, up to a maximum in any twelve-month period in respect of any one person of \$250.

(4) If a recipient or a spouse begins or changes employment and, in the opinion of the welfare administrator, the person is required to pay in advance for child care that is reasonably necessary to permit the person to begin or change employment, there shall be paid to the recipient, in addition to the amount of general assistance computed under subsection 12 (1), an amount determined by the welfare administrator.

(5) The maximum amount payable under subsection (4) in any twelve-month period is the amount that the person would be entitled to as a deduction for child care under section 15.

(6) The benefit under subsection (4) is not a reimbursement for child care expenses for the purposes of determining income under subsection 15 (2).

(7) Subsections (1), (3) and (4) do not apply to persons who are entitled to general assistance under subsection 12 (2) or (3). O. Reg. 525/89, s. 3.

TIME AND MANNER OF PAYMENT OF ASSISTANCE

17.—(1) General assistance shall not be paid for a period of more than one month at any one time.

(2) The Director may prescribe the manner in which general assistance shall be paid.

(3) Where in the opinion of the welfare administrator, or, where the applicant or recipient resides in territory without municipal organization in the opinion of the regional welfare administrator, the applicant or recipient is using or is likely to use his or her assistance otherwise than for his or her own benefit or is incapacitated or is incapable of handling his or her own affairs, or is deceased, the welfare administrator or regional welfare administrator, as the case may be, may appoint a person to act for the applicant or recipient and the allowance may be paid for the benefit of the applicant or recipient to the person so appointed.

(4) A person acting for an applicant or recipient under subsection (3) is not entitled to any fee or other compensation or reward or to any reimbursement for any costs or expenses. R.R.O. 1980, Reg. 441, s. 14.

SPECIAL ASSISTANCE

18.—(1) Subject to sections 4 and 6, items, services or payments of special assistance approved by the municipality, council of an approved band or the Province, as the case may be, may be paid or provided to or on behalf of a person,

- (a) by a municipality, where the person resides in a municipality;
- (b) by the council of an approved band where the person resides on the reserve of the band; and
- (c) by the Province where the person resides in territory without municipal organization,

in such amounts as determined by the welfare administrator but not exceeding the amount by which the budgetary requirements of the person as determined in accordance with subsection (4) exceeds his or her income determined in accordance with section 15. R.R.O. 1980, Reg. 441, s. 15 (1); O. Reg. 691/83, s. 6 (1); O. Reg. 708/84, s. 6 (1).

(2) Despite subsection (1) and clauses 4 (1) (b), (c) and (d), special assistance may be paid or provided under this section to or on behalf of a person who is enrolled as a full-time student at an educational institution. O. Reg. 708/84, s. 6 (2).

(3) Special assistance may be provided under this section to pay the cost of a funeral and burial for a deceased person who would have been eligible for special assistance at the date of death if an application for special assistance had been made on that date. O. Reg. 691/83, s. 6 (2), *part*.

(4) For the purpose of subsection (1), budgetary requirements shall be determined as follows:

1. For basic needs, an amount determined in accordance with paragraph 1, 2 or 4 of subsection 13 (4).
2. The cost of food for a special diet.
3. The costs due to pregnancy.
4. The cost of energy for heat.
5. An amount for contingencies equal to 20 per cent of the aggregate of the amounts in paragraphs 1 to 4, both inclusive.
6. The cost of shelter as determined by the welfare administrator in excess of the applicable amount in the Table to paragraph 8 of subsection 13 (4).
7. The cost of care and maintenance in a nursing home.
8. The cost of drugs prescribed by a physician or dental surgeon.

9. The cost of surgical supplies and dressings.
10. The cost of dental services.
11. The cost of one or more prosthetic appliances including eye-glasses.
12. The cost of vocational training and retraining.
13. The cost of travel and transportation.
14. The cost of moving.
15. A personal needs allowance in an amount determined by the welfare administrator that does not exceed the amount shown as personal needs allowance in Column 4 of Schedule E set out opposite the date the resident was in the institution in Column 1 of Schedule E.
16. The cost of a funeral and burial.
17. Any other special service, item or payment in addition to those set out in paragraphs 1 to 16 authorized by the Director. R.R.O. 1980, Reg. 441, s. 15 (4); O. Reg. 361/83, s. 4; O. Reg. 691/83, s. 6 (3); O. Reg. 824/84, s. 4; O. Reg. 549/88, s. 3; O. Reg. 164/89, s. 3.

(5) Where a person is sixty-five years of age or older, the amount of \$12 shall be considered to be part of the person's budgetary requirements referred to in subsection (1). O. Reg. 381/87, s. 2.

(6) Subject to section 23, the Province of Ontario shall pay by way of reimbursement to the municipality or to the council of the approved band, as the case may be, 50 per cent of the amounts paid for special assistance. O. Reg. 691/83, s. 6 (4).

(7) Despite subsection (6) and subject to section 23, the Province of Ontario shall pay by way of reimbursement to the municipality or to the council of the approved band, as the case may be, 80 per cent of any amount approved by the Director and paid as special assistance for the cost of a funeral and burial paid in accordance with subsection (3). O. Reg. 637/89, s. 1.

(8) The Province of Ontario, a municipality or the council of an approved band is entitled to recover any amounts paid for a funeral or burial under subsection (3) from any person or organization liable for the payment of the funeral expenses or any portion thereof. O. Reg. 708/84, s. 6 (3).

SUPPLEMENTARY AID

19. Subject to section 23, where a municipality or an approved band pays supplementary aid for the purpose of assisting a person to meet the cost of energy for heat or shelter, or to provide for any other special service, item or payment authorized by the Director, Ontario shall pay by way of reimbursement to the municipality or to the council of the approved band, as the case may be, 80 per cent or the monthly amounts so paid. O. Reg. 786/82, s. 7; O. Reg. 549/88, s. 4.

20.—(1) An incentive allowance may be paid to or on behalf of a person taking part in a work activity project who is a recipient of general assistance or an allowance under the *Family Benefits Act*,

- (a) by a municipality, where the person resides in the municipality;
- (b) by the council of an approved band, where the person resides on the reserve of the band; or
- (c) by the Province of Ontario, where the person resides in territory without municipal organization. R.R.O. 1980, Reg. 441, s. 17 (1).

(2) Subject to section 23, Ontario shall pay by way of reimburse-

ment to a municipality or to the council of an approved band 80 per cent of the amount approved by the Director of an incentive allowance paid in accordance with subsection (1) to a participant in a work activity project. O. Reg. 708/84, s. 7.

MEDICAL AND HOSPITAL SERVICES

21. Any recipient and any of his or her dependants are entitled to receive insured service in accordance with the *Health Insurance Act*. R.R.O. 1980, Reg. 441, s. 18.

22. A municipality, council of the band or the Province of Ontario, as the case may be, providing general assistance to any person eligible for prescribed drugs under section 25 of Regulation 366 of Revised Regulations of Ontario, 1990 shall provide that person and any of his or her dependants with an identification card in a form and manner prescribed by the Director. R.R.O. 1980, Reg. 441, s. 19.

RESIDENCE

23.—(1) For the purposes of the Act and this Regulation, where an applicant or recipient during any part of the period of twelve consecutive months immediately preceding his or her application for assistance,

- (a) has not resided in Ontario; or
- (b) has resided in Ontario in territory without municipal organization,

the municipality or the council of the approved band that provides assistance in accordance with this Regulation shall be entitled to reimbursement by the Province of Ontario for the full amount expended for such assistance until such time as the applicant or recipient has resided for a period of twelve consecutive months, in Ontario, in territory with municipal organization or on a reserve of an approved band.

(2) Where the municipality or the council of an approved band is entitled to reimbursement under subsection (1), the municipality or council, as the case may be, shall notify the Director, within sixty days of the date on which it makes the first payment to the recipient, of the particulars. R.R.O. 1980, Reg. 441, s. 20.

ADMINISTRATION AND OTHER COSTS

24.—(1) In this section,

“cost of staff training” means payments approved by the Director for courses of training or instruction approved by the Director for persons employed by a municipality, district welfare administration board or by an approved band in the administration of welfare services, in respect of,

- (a) tuition fees,
- (b) transportation costs, and
- (c) living allowances that are paid to the employees who are required to live away from home while receiving the training or instruction;

“welfare services” means,

- (a) any class of assistance and supplementary aid administered under the Act,
- (b) hospitalization of indigent persons,
- (c) services in respect of children's aid societies,
- (d) social services that are furnished for the purpose of,
 - (i) rehabilitation, including vocational assessment and

counselling, the facilitation of vocational training and placement in employment,

- (ii) counselling in respect of family or marital relationships,
 - (iii) counselling in respect of child care and training and parent-child relationships,
 - (iv) counselling in respect of debts, financial or household management and homemaking,
 - (v) counselling in respect of nutritional needs and requirements,
 - (vi) counselling in respect of the maintenance of adequate standards of health and personal hygiene,
- (c) such other social services that may be required by a recipient and are approved by the Director,
- (f) administrative, secretarial and clerical services including staff training relating to the provision of any of the foregoing welfare services,
- (g) consulting, research and evaluation services with respect to the provision of any of the foregoing welfare services, and
- (h) such other services as are approved by the Director. R.R.O. 1980, Reg. 441, s. 21 (1); O. Reg. 713/88, s. 1 (1).
- (2) The subsidy payable by the Province of Ontario to,
- (a) a city or a separated town;
 - (b) a municipality approved by the Lieutenant Governor in Council other than a city or a separated town;
 - (c) a county that has appointed a welfare administrator under subsection 4 (3) of the Act;
 - (d) an approved band; or
 - (e) subject to subsection (9), a district welfare administration board established under the *District Welfare Administration Boards Act*,

shall, except as provided in subsection (5), be equal to 50 per cent of the cost of the administration of welfare services incurred by the city, separated town, municipality, board or district welfare administration board, as the case may be. O. Reg. 823/84, s. 1 (1).

(3) The cost of administration of welfare services under subsection (2) shall be calculated in the following manner:

1. Determine the payments approved by the Director to or on behalf of persons described in subsection (4) in respect of,
 - i. salaries, wages and honoraria,
 - ii. employer's contributions in respect of a pension, unemployment insurance or workers' compensation plan or scheme or other employee's benefit plan or scheme, and
 - iii. travelling expenses where such expenses are directly related to the administration of welfare services.
2. Subtract from the amount determined under paragraph 1 grants, revenues and recoveries other than payments under this Act received by the district welfare administration board, municipality or band, as the case may be, from all sources in connection with those payments.
3. Add to the amount determined under paragraph 2, pay-

ments approved by the Director for research or consultation carried out on a contract or fee-for-service basis relating to welfare services.

4. Add to the amount determined under paragraph 3, payments approved by the Director for operating costs of computer services including rental of equipment if, as a result of such services, a welfare administrator is able to provide to the Director such information on the administration and operation of welfare services as the Director requires.

(4) Paragraph 1 of subsection (3) applies in respect of payments to or on behalf of,

- (a) a welfare administrator who is employed full time in the administration of welfare services;
- (b) members of a district welfare administration board; and
- (c) any other employee of a district welfare administration board, municipality or an approved band who is engaged in the administration of welfare services. O. Reg. 713/88, s. 1 (2).

(5) The subsidy payable by the Province of Ontario to,

- (a) a municipality; and
- (b) an approved band,

in respect of the cost incurred and approved by the Director of,

- (c) salaries, wages or other remuneration;
- (d) travelling and living expenses for services performed away from their ordinary places of residence;
- (e) employer's contribution in respect of a pension, unemployment insurance or workers' compensation plan or scheme or other employee's benefit plan or scheme;
- (f) rental of equipment including vehicles;
- (g) the purchase of or the depreciation on any equipment mentioned in clause (f) where the purchase thereof is more economical than its rental and the cost thereof would normally be amortized during the life of the project;
- (h) materials that will be used and consumed in carrying out the project other than materials to be used in the construction of any new building;
- (i) rental of land and premises; and
- (j) any other service or item in addition to those set out in clauses (a) to (i), approved by the Director,

paid to or on behalf of persons by a municipality or band, as the case may be, for the administration of welfare services relating to the operation or maintenance of work activity projects, shall be equal to 80 per cent of such costs.

(6) The subsidy payable by the Province of Ontario to,

- (a) a municipality; and
- (b) an approved band,

in respect of the cost of staff training shall be equal to 80 per cent of such cost. R.R.O. 1980, Reg. 441, s. 21 (4, 5).

(7) The subsidy payable by the Province of Ontario to,

- (a) a municipality;

- (b) an approved band; or
- (c) a district welfare administration board established under the *District Welfare Administration Boards Act*,

in respect of the cost approved by the Director of counselling services approved by the Director, purchased on a contract of fee-for-service basis from an agency or person approved by the Director, shall be equal to 80 per cent of such cost. O. Reg. 361/83, s. 5 (1).

(8) Despite subclause 10 (1) (a) (ii), an application for monthly payment of a subsidy payable under subsection (7) shall be in a form provided by the Director. R.R.O. 1980, Reg. 441, s. 21 (7).

(9) No subsidy shall be payable under subsection (2) to a district welfare administration board until the board has been established and in operation for a period of one year. O. Reg. 786/82, s. 8 (3).

- (10) The subsidy payable by the Province of Ontario to,
 - (a) a municipality;
 - (b) an approved band; or
 - (c) a district welfare administration board established under the *District Welfare Administration Boards Act*,

in respect of the cost of maintenance ordered by the board of review under subsection 11 (4) of the Act shall be equal to 80 per cent of such cost. O. Reg. 361/83, s. 5 (2).

25. Where the municipalities participating in a district welfare administration board established under the *District Welfare Administration Boards Act*, are unduly burdened in any year, as a result of costs of carrying out the purposes of this Act, by reason of the transfer by amalgamation or annexation of one or more municipalities or any part of one or more municipalities participating in the board, to one or more municipalities not participating in the board, the Province of Ontario shall, in respect of such year, pay an amount prescribed by the Minister to the municipalities participating in the board. R.R.O. 1980, Reg. 441, s. 22.

RECOVERY ON REDUCTION OF ASSISTANCE

26. A municipality or the council of an approved band that makes a recovery under section 5 or subsection 18 (8) of this Regulation, or section 12 of the Act, shall refund to the Province of Ontario the percentage of the amount recovered that is equal to the percentage on which contribution by Ontario to the municipality or to the council of the band in respect of the amount recovered was based. R.R.O. 1980, Reg. 441, s. 24.

27. Despite subsection 12 (7), subsection 18 (6), section 19 and subsection 24 (6), where payment has been made by a municipality or the council of an approved band of any sum by way of assistance to a recipient, who is not eligible therefor under the Act and this Regulation, Ontario may, where the Director approves such payment, pay by way of reimbursement to the municipality or the council of the approved band an amount equal to the contribution that would have been payable by Ontario to the municipality or to the council of the approved band if the recipient had been eligible for the assistance under the Act and this Regulation. R.R.O. 1980, Reg. 441, s. 25.

28. The Province of Ontario may pay general assistance to any person who is eligible therefor and, where the person has residence in a municipality or on the reserve of an approved band, the proportion of the amounts expended by Ontario for such assistance as is prescribed in this Regulation as being the proportion that shall be paid by the municipality or the council of the band, as the case may be, is recoverable from the municipality or the council of the band as a debt due to the Crown in right of Ontario and may be deducted out of any money payable by Ontario to the municipality or the council of the band under the authority of any Act, or may be sued for in a court of competent jurisdiction. R.R.O. 1980, Reg. 441, s. 26.

29.—(1) Where a determination is made under this Regulation by a welfare administrator, the determination is prescribed to be a power of the welfare administrator.

(2) Where an approval is made under this Regulation by the Director, the approval is prescribed to be a power of the Director. O. Reg. 361/83, s. 6.

30.—(1) In this section, “eligible dependant” means,

- (a) a dependent child;
- (b) a foster child referred to in clause 13 (5) (c); and
- (c) a dependent adult who is not a spouse and has not attained twenty-one years of age on the 1st day of November. O. Reg. 713/87, s. 3, *part*.

(2) An applicant or recipient who is eligible for general assistance, other than emergency assistance paid under subsection 9 (11) or general assistance under subsection 12 (4), in the month of November and who has one or more eligible dependants in that month shall be paid in that month, in addition to the amount of general assistance, an amount equal to \$102 for each of his or her eligible dependants. O. Reg. 713/87, s. 3, *part*; O. Reg. 747/88, s. 3; O. Reg. 525/89, s. 4; O. Reg. 687/89, s. 4; O. Reg. 681/90, s. 3 (1).

(3) An applicant or recipient who is eligible for an allowance, other than emergency assistance paid under subsection 9 (11) or general assistance under subsection 12 (4), in the month of August in any year and who has one or more eligible dependants shall be paid once in that year, in addition to the allowance,

- (a) \$66 for each eligible dependant who attains the age of four years or more but who has not attained the age of thirteen years in that year; and
- (b) \$123 for each eligible dependant who attains the age of thirteen years or more in that year and who is attending school. O. Reg. 445/90, s. 3; O. Reg. 681/90, s. 3 (2).

(4) For the purposes of subsection 12 (7), a payment made in accordance with this section shall be deemed to be general assistance paid in accordance with subsection 12 (1) or (6). O. Reg. 713/87, s. 3, *part*.

31.—(1) The budgetary requirements of an applicant or recipient who shares accommodation with one or more persons who are not dependants of the applicant or recipient shall, despite section 13, be reduced by an amount that, subject to subsection (2), is equal to the greater of,

- (a) the difference between the budgetary requirements of the applicant or recipient calculated as if the applicant or recipient was responsible for the entire cost of shelter and energy for heat, and those requirements calculated by allocating one equal share of such cost to each of the one or more persons and to the applicant or recipient and any spouse included as a dependant; or
- (b) \$40. O. Reg. 590/87, s. 6, *part*; O. Reg. 549/88, s. 5.

(2) Where an applicant or recipient whose budgetary requirements are calculated under paragraph 1 or 2 of subsection 13 (4) would, by the application of subsection (1), have his or her budgetary requirements reduced below the appropriate amount shown as minimum in Schedule A or B, as the case may be, the budgetary requirements of the applicant or recipient shall be equal to the appropriate minimum amount shown in Schedule A or B, as the case may be.

(3) This section does not apply to an applicant or recipient who,

- (a) has his or her budgetary requirements determined or com-

puted under subsection 12 (6), 13 (5), 18 (4) or section 19; or

(b) has been eligible for assistance or an allowance under the *Family Benefits Act* continuously since the 31st day of October, 1987 and who, prior to the 1st day of November, 1987, had advised a welfare administrator or the Director that he or she was sharing accommodation with one or more persons who were not dependants of the recipient.

(4) Where subsection (1) applies, a share of the costs referred to in clause (a) of that subsection shall not be allocated to,

(a) a person who lives with and provides daily physical assistance on an ongoing basis to an applicant, recipient or spouse where the assistance is necessary to allow the applicant, recipient or spouse to function in a community setting and where the applicant, recipient or spouse is an unemployed person;

(b) a person to whom the applicant or recipient provides lodging, where the person provides income that is included under section 15; or

(c) a person who provides lodging, with or without meals, to the applicant or recipient. O. Reg. 590/87, s. 6, part.

Schedule A

AMOUNTS FOR BASIC NEEDS (BOARD AND LODGING—PROFIT *)

No. of Dependants Other than a spouse	One Adult Person				Two Adult Persons			
	Minimum		Maximum		Minimum		Maximum	
	Weekly \$	Monthly \$	Weekly \$	Monthly \$	Weekly \$	Monthly \$	Weekly \$	Monthly \$
0	Employable: 54.50 237		99.40	432	95.50	415	155.60	676
	Unemployable: 58.90 256		101.50	441				
1	96.90	421	142.90	621	121.30	527	178.60	776
2	123.10	535	165.70	720	143.80	625	200.00	869
3	145.50	632	187.10	813	163.60	711	221.40	962

For each additional dependant in the family in excess of three, add an amount up to \$21.90 weekly or up to \$95 monthly.

* Refer to paragraph 1 of subsection 13 (4)

O. Reg. 681/90, s. 4, part.

Schedule B

AMOUNTS FOR BASIC NEEDS (BOARD AND LODGING—NON-PROFIT *)

No. of Dependants Other than a spouse	One Adult Person				Two Adult Persons			
	Minimum		Maximum		Minimum		Maximum	
	Weekly \$	Monthly \$	Weekly \$	Monthly \$	Weekly \$	Monthly \$	Weekly \$	Monthly \$
0	Employable: 54.50 237		76.90	334	95.50	415	142.90	621
	Unemployable: 58.90 256		78.90	343				
1	96.90	421	130.30	566	121.30	527	164.10	713
2	123.10	535	151.20	657	143.80	625	183.90	799
3	145.50	632	171.50	745	163.60	711	203.90	886

For each additional dependant in the family in excess of three, add an amount up to \$21.60 weekly or up to \$94 monthly.

* Refer to paragraph 2 of subsection 13 (4)

O. Reg. 681/90, s. 4, part.

Schedule C

**AMOUNTS FOR BASIC ALLOWANCE
(FOR RENTERS AND OWNERS *)**

Number of Dependants	Dependants 13 Years and Over	Dependants 0 - 12 Years	One Adult Person		Two Adult Persons	
			Weekly \$	Monthly \$	Weekly \$	Monthly \$
0	0	0	Employable: 53.60 233		116.90	508
			Unemployable: 55.50 241			
1	0	1	112.50	489	141.10	613
	1	0	124.10	539	151.70	659
2	0	2	136.70	594	169.20	735
	1	1	148.20	644	179.70	781
	2	0	158.80	690	190.30	827

For each additional dependant in the family in excess of two, add to the appropriate amount set out in the Schedule for a family of two dependants as follows:

	Weekly	Monthly
Dependant 13 years and over	\$38.70	\$168
Dependant 0-12 years	28.10	122

* Refer to paragraph 4 of subsection 13 (4)

O. Reg. 681/90, s. 4, part.

Schedule D

**AMOUNTS FOR BASIC SHELTER ALLOWANCE
(RENTERS AND OWNERS *)**

Number of Persons (Recipient and Dependants)	Basic Shelter Allowance	
	weekly \$	monthly \$
1	27.60	120
2	42.60	185
3	48.30	210
4	50.60	220
5	52.90	230
6 or more	55.20	240

* Refer to paragraph 4 of subsection 13 (4)

O. Reg. 687/89, s. 6, part.

Schedule E

ITEM	COLUMN 1	COLUMN 2	COLUMN 3	COLUMN 4	COLUMN 5
	Effective Date	Basic Daily	Extended Care Ceiling Daily	Personal Needs Allowance	Intermediate Care Ceiling Daily
1.	From and including the 1st day of November, 1990	\$24.33	67.13	100.00	58.33

O. Reg. 824/84, s. 7, part; O. Reg. 26/85, s. 1; O. Reg. 210/85, s. 1; O. Reg. 399/85, s. 1; O. Reg. 552/85, s. 1; O. Reg. 46/86, s. 1; O. Reg. 139/86, s. 1; O. Reg. 244/86, s. 1; O. Reg. 441/86, s. 1; O. Reg. 640/86, s. 1; O. Reg. 37/87, s. 1; O. Reg. 226/87, s. 1; O. Reg. 381/87, s. 3; O. Reg. 450/87, s. 1; O. Reg. 489/87, s. 1; O. Reg. 593/87, s. 1; O. Reg. 50/88, s. 1; O. Reg. 269/88, s. 1; O. Reg. 484/88, s. 1; O. Reg. 650/88, s. 1; O. Reg. 45/89, s. 1; O. Reg. 164/89, s. 4; O. Reg. 169/89, s. 1; O. Reg. 228/89, s. 1; O. Reg. 431/89, s. 1; O. Reg. 607/89, s. 1; O. Reg. 54/90, s. 1; O. Reg. 214/90, s. 1; O. Reg. 257/90, s. 1; O. Reg. 430/90, s. 1; O. Reg. 573/90, s. 1, revised.

Form 1



Application for Assistance under the General Welfare Assistance Act An Allowance under the Family Benefits Act

Has the applicant previously applied for assistance under the General Welfare Assistance Act or an allowance under the Family Benefits Act?
no yes, provide details:

Date and location of most recent application
Least payment received Amount \$ Date
GWA FBA

1. Qualifying Categories indicate categories under which application is being made
Family Benefits Act
age 65 or more
60-64 year old
disabled, blind, permanently unemployable
sole support parent
Vocational Rehabilitation Services
General Welfare Assistance Act
inability to obtain regular employment
head of family whose spouse is absent
disability
old age
student

2. Personal Data
Applicant Surname First name Second name
Mr. Mrs. Ms. Miss
Alternate or previous name (including maiden name)
What is your present marital status
single separated
married (legally) divorced
deserted widowed
spousal

Address Postal code Telephone number

Birth Date Date of birth verified Type of proof seen Social insurance number

Health number (applicant) Education (highest level achieved) Health good fair poor

Next of kin - name Relationship Address

Surname of Spouse First name Second name Maiden name (if applicable)

Birth Date Date of birth verified Type of proof seen Social insurance number Health number

Education (highest level achieved) Health good fair poor

Previous Spousal Relationships Applicant Spouse yes, provide details Section 8 no

Dependants First name(s) and surname(s) under which birth was registered for each dependant living with you.

Table with columns: Birthdate (D, M, Y), Verified (Y, N), Type of proof seen, School name, Grade

Do you have any dependants not living with you? no yes, provide details in Section 8

Is any other person living in the home? (eg. roomer, boarder, renter, sharer, landlord) no yes, provide the following: Name M/F Relationship Effective date

Is any other person using this address for any other reason? no yes, provide the following: Name Reason Relationship

3. Residence

If born outside Canada, provide the following:

Table with columns: Applicant, Spouse, Dependant(s), Arrival date, Verified (yes, no), Current status, Lending date, Verified (yes, no)

List all places of applicant's residence within the last 12 months (GWA only)

Table with columns: From (month/year), To (month/year), Address, Municipality, Province

4. Employment History <small>List all employment of applicant/spouse/dependants within the past year</small>							
A	S	D	Employer	Employer's Address	Employment Period		Reason for Leaving Employment
					From	To	

5. Assets									
Personal Property	Y	N	Details	Value	\$	Verified			
						Y	N		
Cash on hand									
Chequing / Savings Accounts <small>(Banks, Trust Corporations, Credit Unions)</small>									
Investments <small>(Bonds, Shares, RRSP Term Deposits)</small>									
Receivables <small>(Mortgages, Loans, Accounts Receivable)</small>									
Vehicles									
Safety Deposit Box									
Valuables <small>(coins, stamps, jewellery)</small>									
Prepaid Funeral <small>(Amount in excess of allowable exempt)</small>									
Beneficial Interest in Assets held in trust <small>(Official Guardian, Public Trustee, Privately Administered Trust)</small>									
Financial Interest in Business									
Other									

Real Property - other than Principal Residence no yes, provide the following:

Lot and Plan/Concession	Address	A	S	D	Owned or Life Tenancy	Rented	Vacant	Occupied	Year Purchased	Current Market Value	\$	Equity	\$	Verified	
														Y	N

Have you, your spouse or any dependent disposed of any assets (personal or real property) within three years prior to the application?
 no yes, provide details:

Are any assets expected in the future by you, your spouse, or any dependants? no yes, provide details:

6. Income/Revenue/Earnings									
Income	Y	N	Details reference number	Amount		Verified			
				Weekly	Monthly	Y	N		
O.A.S./G.I.S./S.A./W.S.A.									
GAINS for the aged									
Annuities, Superannuation, Insurance Benefits									
Canada Pension Plan/Quebec Pension Plan									
Pension Act (Canada)									
War Veterans' Allowance/Civilian War Pension									
Unemployment Insurance									
Training Allowance									
Foreign Pensions/Social Securities U.S.A.									
Workers' Compensation									
Compensation for Victims of Crime									
Support Payments									
Official Guardian/Public Trustee/ Privately Administered Trust									
Other (eg. sponsorship payments)									

Revenue

	Y		N		Reference no.	Monthly Amounts			A		S		D		Verified		
															Y	N	
Mortgage Receivable/Loan Agreement																	
Farm or Business																	
Rental (gross) <input type="checkbox"/> self contained quarters																	
<input type="checkbox"/> land <input type="checkbox"/> garage <input type="checkbox"/> other																	

Roomer (R) or Boarder (B) no yes, provide details:

Name	Effective Date	M	F	R	B	Monthly Amount \$	Birth Date	Relationship

Is any Roomer or Boarder your child, grandchild, foster child of you or your spouse? no yes, are they a beneficiary of Family Benefits, in receipt of General Welfare Assistance, attending an educational institution without financial assistance? no yes, provide details:

Earnings

	Monthly Earnings		Employer's Name and Address	No. of hours	Hourly rate	Verified	
	Gross \$	Net \$				Y	N
Applicant							
Spouse							
Dependant (GWA Only)							

Other Financial Resources

Are there any other financial resources to which the applicant/spouse or dependant child(ren) may be entitled? no yes, provide the following:

<input type="checkbox"/> sponsorship - name	Address	for (name)	Amount \$
<input type="checkbox"/> support - name	Address	for (name)	Amount \$
<input type="checkbox"/> other - specify	Address	for (name)	Amount \$

Has an application been made for any types of income for which the applicant/spouse or dependant child(ren) may be eligible? yes no, provide details:

7. Budgetary Requirements

A. Living Conditions

1. Are you, your spouse or dependant in a hospital, nursing home or other institution? no yes, provide the following:

<input type="checkbox"/> applicant	Name and address of institution	Date of admission	Expected date of discharge
<input type="checkbox"/> spouse			
<input type="checkbox"/> dependant			

Accommodation Costs (Complete 2, 3 or 4)

2. Boarding (Room and meals provided)

Total amount \$	<input type="checkbox"/> monthly <input type="checkbox"/> weekly	Verified <input type="checkbox"/> yes <input type="checkbox"/> no	With whom	M/F	Relationship	Effective date
-----------------	--	---	-----------	-----	--------------	----------------

3. Rent

Total amount \$	<input type="checkbox"/> monthly <input type="checkbox"/> weekly	Verified <input type="checkbox"/> yes <input type="checkbox"/> no	Accommodation Type: <input type="checkbox"/> apartment <input type="checkbox"/> house <input type="checkbox"/> room	Number of Rooms	<input type="checkbox"/> subsidized <input type="checkbox"/> unsubsidized
-----------------	--	---	---	-----------------	---

Heating Costs (annual)

Total amount \$	<input type="checkbox"/> oil <input type="checkbox"/> wood <input type="checkbox"/> gas <input type="checkbox"/> electric	Equal billing <input type="checkbox"/> yes <input type="checkbox"/> no	Verified <input type="checkbox"/> yes <input type="checkbox"/> no	Fire Insurance (annual) \$	Verified <input type="checkbox"/> yes <input type="checkbox"/> no	Utilities (monthly) \$
-----------------	---	--	---	----------------------------	---	------------------------

Landlord's name _____ Address _____ Telephone number _____

4. Own Home or Condominium

Mortgage paid (monthly) (Principle + Interest) \$	Verified <input type="checkbox"/> yes <input type="checkbox"/> no	No. of rooms	Heating costs (annual) Total amount \$ <input type="checkbox"/> oil <input type="checkbox"/> wood <input type="checkbox"/> gas <input type="checkbox"/> electric	Equal Billing <input type="checkbox"/> yes <input type="checkbox"/> no	Verified <input type="checkbox"/> yes <input type="checkbox"/> no	Fire Insurance (annual) \$	Verified <input type="checkbox"/> yes <input type="checkbox"/> no
Utilities (monthly) \$	Condominium Common Expenses (monthly) \$	Verified <input type="checkbox"/> yes <input type="checkbox"/> no	Taxes (annual) \$	Verified <input type="checkbox"/> yes <input type="checkbox"/> no	Mortgage held by		

5. Do you pay the total accommodation costs? yes no, provide the following:

Amount paid by you: \$ _____

Amount paid by co-resident: \$ _____

B. Special Items

Are any of the following items required by you, your spouse or any other beneficiary? no yes

special diet pregnancy item travel/transportation discharge allowance guide dog allowance life insurance premium (see below)

Life Insurance

A/S/D	Name of Insurance Company	Policy Number	Beneficiary Name	Monthly Premium	Face Value
				\$	\$

8. Additional information from Section 1 to 7 (a.g. Health numbers for dependent children)

9. Statutory Declaration of Applicant and Spouse (complete spousal information if applicable)

1. _____ do solemnly declare that I am the Applicant (or the person
(full name)
applying on behalf of the Applicant) named in the foregoing application.
2. _____ do solemnly declare that I am the spouse of the above
(full name)
mentioned applicant.
3. I/We have been interviewed by the Welfare Administrator or his/her representative or by the Director of Income Maintenance of the Ministry of Community and Social Services or his/her representative. I/We understand the eligibility criteria. I/We have supplied the information in this application to the best of my/our knowledge and belief. All statements in this application are true and no information required to be given has been withheld or omitted.
4. Should an allowance be granted on the basis of the foregoing information, I/we will notify the Welfare Administrator, the Director or his/her representative as the case may be, of any change of relevant circumstances of any beneficiary of the allowance/assistance to be provided, including any change in circumstances pertaining to assets, income or living arrangements.
5. I/We acknowledge that this is an application for assistance pursuant to the _____ Act
as indicated in Section 1 of this application. I/We further acknowledge that should there be eligibility for Social Assistance under the _____ Act, this application and the information contained therein may be used for the purpose of verifying eligibility and I/we undertake to provide any additional information which may be required at that time.
6. I/We make this solemn Declaration conscientiously believing it to be true and knowing that it has the same force and effect as if made under oath by virtue of the *Canada Evidence Act*.

Declared before me at the _____
of _____ Signature/mark of applicant or person applying on behalf of applicant
in the _____ of _____
this _____ day of _____, 19 _____ Signature/mark of spouse where applicable

A Commissioner etc.

O. Reg. 626/90, s. 1, revised.

Form 2

General Welfare Assistance Act

APPLICATION FOR GENERAL ASSISTANCE
BY A FOSTER PARENT

Has a previous application been made on behalf of foster child(ren)? yes no. If yes, provide details:

Application made by _____ Date _____

1. Applicant's surname _____ First name _____ Second name _____

Address _____ Telephone number _____
Postal code _____

Birthdate

D	M	Y
---	---	---

 Social Insurance number _____ Health number _____

2. Date Pertaining to Foster Child(ren)

First name(s) and surname under which Birth registered	Birthdate			Verified		M F	School	Grade
	day	moth.	year	yes	no			

Health number under which foster child(ren) covered _____

If foster child(ren) born outside Canada provide the following:
Arrival date _____
Current status _____
Landing date _____

For GWA only- Residence of foster child(ren) for the past 12 months
*Provide address(es) in section 7

	From	To
<input type="checkbox"/> this municipality		
<input type="checkbox"/> another municipality		
* <input type="checkbox"/> outside Ontario		
* <input type="checkbox"/> Unorganized Territories		
* <input type="checkbox"/> Indian Reserve		

3. Particulars of Natural Parents of Foster Child(ren)

	Surname	First name	Address	Date of Death (if applicable)
Mother				
Father				

4. Assets

A. List each item held by or on behalf of Foster child(ren) at time of application

Type	Description	Amount	Veri- fied	Type	Description	Amount	Veri- fied
1. cash				3. investments			
2. bank accounts				4. others			

B. Does the foster child(ren) have a beneficial interest in assets held in trust (Official Guardian, privately administered trust)? yes no
If yes, provide details:

C. Are any assets expected in the future (such as unadjusted claims, insurance, inheritances or lawsuits pending)? yes no
If yes, provide details:

D. Does foster child(ren) have any interest in real property? yes no. If yes, give details:

5. Income

A. List each item received by or on behalf of foster child(ren) at time of application

Type	Date commenced	Monthly amount	Type	Date commenced	Monthly amount
Canada/Quebec Pension Plan			Official Guardian		
War Veterans' Allowance			Family Allowance (if not, explain)		
Support			Other (specify)		

B. Is any income expected in the future from any source for the foster child(ren)? yes no. If yes, provide details:

6. Additional Information

Date child(ren) taken into care of foster parent _____ Relationship (if any) of foster parent to foster child(ren) _____

Form 3

General Welfare Assistance Act

CONSENT TO DISCLOSE AND VERIFY INFORMATION

1. I, _____, consent to the release of information
full name
 to an authorized representative of _____
Municipality

Indian Band
 Ministry of Community and Social Services

for the sole purpose of determining or verifying my eligibility for social assistance.

2. Without restricting the generality of the above-noted consent, I specifically consent to the release of information to

- _____
Municipality

Indian Band
 Ministry of Community and Social Services

relating to any bank account, safety deposit box, assets of any nature or kind whatsoever held by me or on my behalf or by or on behalf of my spouse, any of my dependants or my foster child(ren) (if applicable); alone or jointly with any other person, in any financial institution.

3. I further consent to the exchange of information between the municipality or Indian band (if applicable), the Ministry of Community and Social Services of Ontario, the Government of Canada, the government of any other province, any agency thereof, or any of them in order to verify information for the sole purposes of determining or verifying my eligibility for social assistance.

4. I acknowledge that I am providing the above-noted consents in connection with my application for social assistance under the _____ Act. Should I become eligible for social assistance under the _____ Act, I agree that the consents set out above shall apply

for the sole purposes of determining or verifying my eligibility for social assistance.

Dated at _____
Signature/mark of applicant/recipient

This _____ day of _____, 19____.
Witness

I, _____, am the spouse of the above-named
(full name of spouse, if applicable)
 _____ name of applicant/recipient. I have read the consents set out above and I join
 in those consents.

Dated at _____
Signature/mark of spouse of applicant/recipient

This _____ day of _____, 19____.
Witness

Form 4

General Welfare Assistance Act

MEDICAL REPORT

Name	Social Insurance number	
	Sex <input type="checkbox"/> male <input type="checkbox"/> female	Date of birth D M Y
	Health number	
	Postal code	Caseload number

1. Is this person a regular patient of yours? yes no
If yes, how frequently have you seen this patient in the past 2 years?
2. When did you last see this patient? give date:
for what reasons?
3. List other significant/relevant conditions and diagnoses for which this patient has been treated.
4. Briefly describe nature of treatment rendered or proposed (include place and date of relevant hospitalization).
5. What is your prognosis for your patient's condition?
6. Does your patient require the use of any medical prosthetic device (i.e.; wheelchair, artificial limb, etc.) yes no
If yes, please describe:
7. In your opinion do any of these conditions limit this patient's activities pertaining to normal living, such as: self care, communication or motor activities? yes no
if yes, please describe:

8. Do you expect sufficient improvement to take place in the mental or physical condition of this patient to allow him/her to:

a) return to his/her previous work or occupation yes no

if yes, when? _____

full or part-time (hours/day) _____

b) return to any other type of work or occupation yes no

if yes, when? _____

full or part-time (hours/day) _____

Nature of work _____

9. In your opinion, what specific factors or conditions might adversely affect training, employment or academic progress? (Please specify any activities or working conditions that are to be avoided.)

10. If an appropriate training program is developed for your patient, is he/she medically able to participate? yes no

if yes, when? _____

full or part-time (hours/day) _____

11. Any additional information, including hospital reports, consultant's reports, other tests and comments you could provide with respect to your patient's physical, mental or emotional impairment will be of considerable assistance in determining program eligibility:

Certificate of Attending Physician

(Please print)

I, _____ am a legally qualified medical practitioner and this report contains my findings and considered opinion at this time.

Signature _____ date _____

Address _____

Note: In some instances it may be necessary to release to the applicant a summary of the contents of this form.

O. Reg. 137/85, s. 5, part, revised.

Form 5

General Welfare Assistance Act

APPLICATION FOR ASSISTANCE

To the Welfare Administrator, I apply for assistance under the General Welfare Assistance Act and in support of my application I make the following statements:

1. Personal Data		
<input type="checkbox"/> Mr. <input type="checkbox"/> Mrs.	Surname	First name
<input type="checkbox"/> Miss <input type="checkbox"/> Ms.		Date of birth
		D M Y
Address		Telephone number
		Social Insurance number
		Health number
		Postal code
		Marital status

2. Residence for the past 12 months.		
a) If applicant born outside Canada, provide the following: Arrival date _____ Current status _____ Landing date _____	b) For GWA - Residence for the past 12 months, *provide address(es) in section	
		from to
	<input type="checkbox"/> This Municipality	
	<input type="checkbox"/> Another Municipality	
	<input type="checkbox"/> Outside Ontario	
	<input type="checkbox"/> Unorganized Territories	
	<input type="checkbox"/> Indian Reserve	

3. Last/Present Employment		
Date last employed	Employed by	Address
From _____ to _____		
Normal occupation		

4. Dependants and other persons living with applicant (use reverse side if necessary)								
Given Names and Surname	Date of Birth/			Contribution		Other persons living in the household (relatives, boarders)	Amount \$	Relationship to Applicant
	Day	Month	Year	Yes	No			
Spouse								
Children and other dependants								

5. Monthly Living Expenses		
Rent	Room and board	Mortgage (principal & interest)
\$ _____	\$ _____	\$ _____
Taxes	Fire insurance	Fuel
\$ _____	\$ _____	\$ _____

6. Income and Assets
(List all income and assets of applicant and all dependants living in the household, such as public assistance of any kind, wages, full or part-time earnings, rentals, contribution or payments from any source, pensions, annuities, chequing accounts, savings accounts, bonds, stocks, money in trust, insurance policies, real estate, etc.)

Name of Person having Income or Assets	Type of Income or Asset	Amount of Income per week, month, year	Value of Asset

7. Reasons why assistance is required, state in detail

All the statements in the foregoing application are true to the best of my knowledge and belief and no information required to be given has been concealed or omitted

Date	Signature of Applicant
------	------------------------

Part II
To be completed by Welfare Administrator where applicant is resident of a Nursing Home.

Name of Nursing Home

Address

(Address continued)	Number of Licence	Date issued
Date of Admission of Applicant	Daily Rate	Monthly
	\$	\$

I certify that the above Nursing Home is licenced under The Nursing Homes Act and I recommend payment of an allowance for the Nursing Home care of the applicant in the amount of \$ _____ per month

Date	Signature of Welfare Administrator
------	------------------------------------

For Office Use Only

- Class of assistance
- | | |
|--|---------------------------------------|
| <input type="checkbox"/> General Assistance | <input type="checkbox"/> Hostel |
| <input type="checkbox"/> Special | <input type="checkbox"/> Nursing Home |
| <input type="checkbox"/> Supplementary | |
| <input type="checkbox"/> Incentive Allowance | |

O. Reg. 137/85, s. 5, part, revised.

Form 6

General Welfare Assistance Act

APPLICATION FOR MONTHLY PAYMENT OF PROVINCIAL SUBSIDY FOR ASSISTANCE (see note)

Corporation, District Board or Approved Band of (specify city, town, village, etc.)

County or District of

Account for the month of

PART I

ASSISTANCE FOR WHICH SUBSIDY IS CLAIMED

1. GENERAL ASSISTANCE

A. BUDGETARY REQUIREMENTS

Basic needs \$.....
Board and lodging
Special diet
Pregnancy items
Hostels and transients \$.....
Fuel
Foster Children
Advanced Age
Other
Sub-total \$.....
Less: Income \$.....

B. NURSING HOMES

Residents not receiving extended care services \$.....
Residents receiving extended care services
\$ x number of days care \$.....
Less amounts paid by residents \$.....
Balance \$.....
\$ x number of days care
Total of General Assistance \$.....

2. SUPPLEMENTARY AID

Prescribed Drugs \$.....
Optical Services
Dental Services
Shelter
Other
\$.....

3. SPECIAL ASSISTANCE

	Regularly Employed Males	Others
Prescribed Drugs	\$.....	\$.....
Surgical Supplies and Dressings
Travel and Transportation
Moving
Funerals and Burials
Dental Services
Optical Services
Prosthetic Appliances including Eyeglasses
Vocational Training or Retraining
Comfort Allowances
Other (as authorized by the Director)
Sub-totals	\$.....	\$.....
Total of Special Assistance		\$.....

PART II

(This section *not* to be completed by the Municipality)

		Total Assistance	Provincial Subsidy	Municipal Share
1. General Assistance		\$	\$	\$
A. Budgetary Requirements	80%			
B. Nursing Homes				
No extended care	80%			
Extended care:				
—daily basis	80%			
—Balance daily rate	100%			
2. Supplementary Aid—	80%			
3. Special Assistance—	50%			
		\$	\$	\$

PART III

STATISTICS

1. General Assistance Recipients	Employable		Unemployable		Total		Total Persons Male & Female
	Male	Female	Male	Female	Male	Female	
Heads of Families							
Dependants							
Single Persons							
Sub-Total							
Transients and Hostels Heads of Families Dependants Single Persons Dependent Foster Children Family Benefits Recipients Receiving Prescribed Drugs Heads of Families Dependants Single Persons Recipients in Nursing Homes Not on Extended Care On Extended Care							

2. Supplementary Aid Recipients	Total
Old Age Security Recipients	
Family Benefit Recipients	
Others	
Total Recipients	

3. Special Assistance Cases	Regularly Employed Males	Others
Heads of Families		
Single Persons		
Recipients in Nursing Homes		
Sub-Total		
Total Cases		

PART IV

CERTIFICATE

We certify that,

- (1) this application for Provincial Subsidy is correct;
- (2) the amounts shown have been disbursed in accordance with the regulations; and
- (3) this application is in agreement with the records of the municipality.

.....
(signature of municipal welfare administrator)

.....
(address)

.....
(signature of treasurer)

.....
(address)

Date, 19.....

NOTE: Do not include payments of incentive allowances. Such costs are to be included in Form 9.

R.R.O. 1980, Reg. 441, Form 6.

Form 7

General Welfare Assistance Act

APPLICATION FOR MONTHLY PAYMENT OF PROVINCIAL SUBSIDY FOR COST OF ADMINISTRATION

(Complete whichever is applicable)

The Corporation or approved band of the (see note 1)

or

The District, Welfare Administration Board for the (district) (see note 2)

Account for the month of, 19.....

1. Payments for administration of welfare services (see notes 3 and 4) to or on behalf of a full-time welfare administrator and other employees:

i. Salaries, wages and honoraria

A. Welfare administrator \$.....

B. Other staff \$.....

ii. Employer's contributions to pension, unemployment insurance or worker's compensation plan or scheme or other employee's benefit plan or scheme approved by the Minister

A. Welfare administrator \$.....

B. Other Staff \$.....

iii. Travelling expenses of staff in i and ii \$.....

iv. Operating costs of computer services \$.....

2. Payments for research or consultation on a contract or

fee-for-service basis \$.....

TOTAL (Items 1 and 2) \$.....

3. Computation of monthly Provincial subsidy

i. County (that has appointed a welfare administrator under subsection 4 (3) of the Act) and District Welfare Administration Board

A. Total monthly expenditures for items 1 and 2 \$.....

B. Provincial subsidy 50% \$.....

ii. Municipalities, cities, separated towns and other approved municipalities not part of a county (that has appointed a welfare administrator under subsection 4 (3) of the Act) and not part of a District Welfare Administration Board and approved bands

A. Total monthly expenditures for items 1 and 2 recorded

above \$.....

less

B. One-twelfth of total expenditures for items 1 and 2 (above)

for fiscal year ending December 31 \$.....

Balance A-B \$.....

Provincial subsidy 50% of A-B \$.....

TOTAL PROVINCIAL SUBSIDY \$.....

4. Certificate

I certify that the information and the statements made in this Form are true and correct and in accordance with the requirements of the Act and the regulations.

.....
 (signature of municipal treasurer, chair of district welfare administration board or head of an approved band)

Dated at, this day of, 19.....

.....
 (signature of welfare administrator)

NOTES

1. All municipalities (including counties that have appointed welfare administrators under subsection 4 (3) of the Act) and approved bands complete this category.
2. This Form shall not apply, and no subsidy is payable to a district welfare administration board until such time as the board has been established and in operation for a period of at least one year.
3. Welfare services means,
 - (a) any class of assistance administered under the Act;
 - (b) hospitalization of indigent persons;
 - (c) services in respect of children's aid societies;
 - (d) social services that are furnished for the purpose of,
 - (i) rehabilitation, including vocational assessment and counselling, the facilitation of vocational training and placement in employment,
 - (ii) counselling in respect of family or marital relationships,
 - (iii) counselling in respect of child care and training, and parent-child relationships,
 - (iv) counselling in respect of debts, financial or household management and homemaking,
 - (v) counselling in respect of nutritional needs and requirements, and
 - (vi) counselling in respect of maintenance and adequate standards of health and personal hygiene;
 - (e) such other social services that may be required by a recipient and are approved by the Director;
 - (f) administrative, secretarial and clerical services including staff training relating to the provision of any of the foregoing welfare services;
 - (g) consulting, research and evaluation services with respect to the provision of any of the foregoing welfare services; and
 - (h) such other services as are approved by the Director.
4. Do not include administration costs in respect of work activity projects. Such costs are to be included in Form 9.

R.R.O. 1980, Reg. 441, Form 8.

Form 8

General Welfare Assistance Act

APPLICATION FOR MONTHLY PAYMENT OF PROVINCIAL SUBSIDY FOR COST OF STAFF TRAINING

(Complete whichever is applicable)

The Corporation or approved band of the
 (specify, city, town, village etc.) (see note I)

OR

The District Welfare Administration Board for the
 (district)

STAFF TRAINING

Account for the month of, 19.....

1. Name(s) of Course(s)

2. Date(s) of Directors' Approval(s) of Course(s)

3. Cost of Staff Training (see note)

- i. tuition fees \$
ii. transportation costs
iii. living allowances that are paid to employees who are required to live away from home while receiving training and instruction
Total \$

4. Provincial Subsidy: 80% of total of item 3 \$

5. APPROVED FOR PAYMENT BY
Director, General Welfare Assistance Branch

6. CERTIFICATE

I hereby certify that the information given and the statements made in this Form are true and correct and in accordance with the requirements of the Act and the regulations.

Dated at, this day of, 19.....

(signature of municipal treasurer, chair of district welfare administration board or head of an approved band)

NOTES:

- 1. All municipalities including counties that have appointed welfare administrators under subsection 4 (3) of the Act complete this category.
2. "cost of staff training" means payments approved by the Director for courses of training or instruction for persons employed by a municipality, district welfare administration board or by an approved band in the administration of welfare services in respect of,
i. tuition fees,
ii. transportation costs, and
iii. living allowances that are paid to employees who are required to live away from home while receiving training or instruction.

R.R.O. 1980, Reg. 44I, Form 9.

Form 9

General Welfare Assistance Act

APPLICATION FOR MONTHLY PAYMENT OF PROVINCIAL SUBSIDY FOR INCENTIVE ALLOWANCES AND WORK ACTIVITY PROJECTS

Account for the month of, 19.....

1. Project Number Date of Provincial Authorization
day/month/year

2. Computation of Provincial Subsidies:

Nature of Expenditure	Gross Expenditure	Deduct Revenue	Net Expenditure	Municipal Share @ 20%	Provincial Subsidy @ 80%
i. Operation & Maintenance	\$	\$	\$	\$	\$
A. Salaries and Wages					
B. Employer's Contributions					
C. Travel and living expenses					
D. Equipment costs—rentals purchase/depreciation					
E. Materials and supplies					
F. Rental of land and premises					
G. Other (specify)					
.....					
.....					
.....					
.....					
ii. Participants Incentive Allowance					
	\$	\$	\$	\$	\$

3. Participants Incentive Allowance for which the Province is fully responsible:

Gross Expenditure \$.....
 Deduct: Revenue \$.....
 Provincial Subsidy @ 100% \$.....

4. APPROVED FOR PAYMENT

.....
 Director, *General Welfare Assistance Act*

5. CERTIFICATE

We certify that,

- i. this application for Provincial subsidy is correct,
- ii. the amounts shown have been disbursed in accordance with the regulations, and
- iii. this application is in agreement with the records of the municipality (or band)

Dated at, this (signature of welfare administrator)

day of, 19..... (address)

.....
 (signature of municipal treasurer,
 chair of district welfare administration
 board or head of an approved band)

.....
 (address)

REGULATION 538**INDIAN BANDS**

1. The bands listed in the Schedule are approved for the purposes of the Act. R.R.O. 1980, Reg. 442, s. 1.

Schedule

1. Chippewas of the Rama Indian Reserve
2. Walpole Island
3. Ojibways of the Parry Island Indian Reserve
4. Six Nations of the Grand River Indian Reserve
5. Saugeen
6. Chippewas of Nawash
7. Mississaugas of the New Credit Indian Reserve
8. Moravians of the Thames Indian Reserve
9. Chippewas of the Georgina Island Indian Band
10. Mohawks of the Bay of Quinte Indian Band
11. Alderville
12. Curve Lake
13. Scugog
14. Hiawatha
15. Chippewas of the Sarnia Indian Band
16. Chippewas of the Kettle & Stoney Point Indian Band
17. Beausoleil
18. Ojibways of the Mississagua Indian Band
19. Ojibways of the Spanish River Band
20. Ojibways of the Whitefish Lake Indian Band
21. Ojibways of the Nipissing Indian Band
22. Ojibways of the Dokis Indian Band
23. Mohawks of the Gibson Indian Band
24. Ojibways of the Batchawana Indian Band
25. Ojibways of the Garden River Indian Band
26. Ojibways of the Sheguiandah Indian Band
27. Ojibways of the Sheshegwaning Indian Band
28. Ojibways of the Sucker Creek Indian Band
29. Ojibways of the West Bay Indian Band
30. Ojibways of the Whitefish River Indian Band
31. Ojibways of the Fort William Indian Band
32. Ojibways of the Shoal Lake Indian Band No. 39
33. Ojibways of the Shoal Lake Indian Band No. 40
34. Ojibways of the Whitefish Bay (Sioux Narrows) Indian Band
35. Ojibways of the Couchiching (Fort Frances) Indian Band
36. Ojibways of the Shawanaga Indian Band
37. Ojibways of the Serpent River Indian Band
38. Ojibways of the Henvey Inlet Indian Band
39. Ojibways of the Manitou Rapids Rainy River Band
40. Golden Bake Band
41. Oneidas of the Thames
42. Wikwemikong Band
43. Munceys of the Thames
44. Chippewas of the Thames
45. Moose Deer Point
46. Moose Factory Band
47. Wabigoon Band
48. Constance Lake Band
49. Islington Band
50. Eagle Lake Band
51. Ojibways of Onegaming
52. Fort Hope Band
53. Grassy Narrows Band
54. Rocky Bay Band
55. Nicickousemenecaning Band
56. Naicatchewenin Band
57. Lac La Croix Band
58. Osnaburgh Band
59. Martin Falls Band
60. Big Island Band
61. Northwest Angle #33 Band
62. Long Lake #77 Band
63. Long Lake #58 Band
64. Northwest Angle #37 Band
65. Cat Lake Band
66. Brunswick House Band
67. Pic Heron Bay Band
68. Mattagami Band
69. Seine River Band
70. Caribou Lake Band
71. Pikangikum Band

- | | |
|---------------------------|----------------------------|
| 72. Big Grassy Band | 89. Lac Seul Band |
| 73. Matachewan Band | 90. Fort Albany Band |
| 74. Chapleau Ojibway Band | 91. Fort Severn |
| 75. Attawapiskat Band | 92. Stangecoming |
| 76. Sandy Lake Band | 93. Dalles |
| 77. Kingfisher Lake Band | 94. Wabauskang |
| 78. Wunnumin Lake Band | 95. Pic Mobert Band |
| 79. Temagami Lake Band | 96. Sachigo Lake Band |
| 80. Kasabonika Lake Band | 97. Deer Lake Band |
| 81. Bearskin Lake Band | 98. North Spirit Lake Band |
| 82. Magnetawan | 99. Gull Bay Band |
| 83. Muskrat Dam Band | 100. Wahgoshig Band |
| 84. Thessalon Band | 101. Pays Plat Band |
| 85. Wapekeka Band | 102. Kashechewan Band |
| 86. Michipicoten Band | 103. Poplar Hill Band |
| 87. Rat Portage Band | |
| 88. Washagamis Bay Band | |

R.R.O. 1980, Reg 442, Sched.; O. Reg. 122/82, s. 1; O. Reg 572/82, s. 1; O. Reg. 822/84, s. 1; O. Reg. 352/85, s. 1; O. Reg. 564/86, s. 1; O. Reg. 642/87, s. 1; O. Reg. 318/88, s. 1; O. Reg. 166/89, s. 1, *revised*.

Grain Corn Marketing Act *Loi sur la commercialisation du maïs-grain*

REGULATION 539

LICENCE FEES

1.—(1) Where the moisture content of grain corn sold by a producer of grain corn is 15.5 per cent or less, the licence fees payable for a licence to sell grain corn are 38 cents per tonne of grain corn sold. O. Reg. 379/88, s. 1, *part*; O. Reg. 547/89, s. 2 (1).

(2) Where the moisture content of grain corn sold by a producer of grain corn is greater than 15.5 per cent,

- (a) the equivalent number of tonnes of grain corn with a moisture content of 15.5 per cent is calculated as follows:

$$\frac{100 - \text{moisture content of grain corn sold}}{84.5} \times \text{gross weight of grain corn sold}$$

and

- (b) the licence fees payable for a licence to sell grain corn are 38 cents per tonne of the equivalent number of tonnes calculated under clause (a). O. Reg. 379/88, s. 1, *part*; O. Reg. 547/89, s. 2 (2).

2. Subject to section 3, the holder of a licence shall pay the licence fees referred to in section 1 to the Association. O. Reg. 559/84, s. 3; O. Reg. 547/89, s. 3.

3.—(1) Every buyer who receives grain corn from a seller thereof shall deduct from the money payable to the seller the licence fees payable by the seller to the Association respecting the grain corn.

(2) On the fifteenth day of each month, a buyer of grain corn shall forward to the Association all licence fees deducted by the buyer respecting grain corn received during the preceding calendar month together with a statement showing,

- (a) the name and address of each seller in respect of whom the fees were deducted;
- (b) the seller's Association membership number where it has been provided by the seller;
- (c) the amount and purchase price of grain corn received from each seller; and

- (d) the amount of the licence fees payable to the Association by each seller from whom the buyer has received grain corn. O. Reg. 559/84, s. 4.

4. The Association may recover licence fees owing to the Association by suit in a court of competent jurisdiction. O. Reg. 559/84, s. 5.

5.—(1) An application for a refund of licence fees shall,

- (a) be in writing;
- (b) be addressed to the Association at its usual place of business;
- (c) be made within ninety days of the date of the sale of grain corn respecting which the licence fees were paid; and
- (d) include a statement in writing issued by the person who deducted the licence fees indicating the amount of licence fees deducted by the person and forwarded to the Association on behalf of the applicant.

(2) Where an applicant has complied with subsection (1), the Association shall, within ninety days of receipt of the application, refund the licence fees paid by or on behalf of the applicant and for which application for refund was made.

(3) Despite subsection (1), an application for a refund may be submitted to the Association by or on behalf of the same applicant only once in each quarter of the calendar year. O. Reg. 559/84, s. 6.

EXEMPTIONS

6. The following persons are exempt from paying the licence fees referred to in section 1:

1. Producers of grain corn where the producer is selling to a producer who is not engaged in the business of selling grain corn or products derived therefrom.
 2. Producers of grain corn where the producer is selling grain corn in respect of which licence fees have previously been paid. O. Reg. 559/84, s. 7.
-

Grain Elevator Storage Act *Loi sur l'entreposage du grain*

REGULATION 540

GENERAL

1.—(1) An application for a grain elevator operator's licence shall be accompanied by a licence fee of,

- (a) \$50 if the grain elevator has a capacity of less than 250,000 bushels;
- (b) \$100 if the grain elevator has a capacity of 250,000 bushels or more but less than 1,000,000 bushels; and
- (c) \$150 if the grain elevator has a capacity of 1,000,000 bushels or more.

(2) A grain elevator operator's licence expires with the 30th day of June next following the day it is issued. O. Reg. 548/89, s. 1.

(3) An application for the renewal of a grain elevator operator's licence shall be made on or before the 31st day of March next following the day the licence is issued. O. Reg. 184/90, s. 1.

2.—(1) The fee for a temporary grain elevator operator's licence is \$50.

(2) A temporary licence expires on the day stated on the licence. O. Reg. 548/89, s. 2.

3. Where a grain elevator operator or the operator's employee issues a weigh ticket under subsection 17 (1) of the Act, the operator or his employee, as the case may be, shall record on the weigh ticket,

- (a) the name and business address of the grain elevator operator;
- (b) the name and address of the owner of the farm produce;
- (c) the date of delivery of the farm produce;
- (d) the kind, grade and dockage of the farm produce;
- (e) the net weight of the farm produce;
- (f) where applicable, the gross weight or the tare weight of the farm produce;
- (g) the moisture content of the farm produce;
- (h) the serial number of the weigh ticket;
- (i) whether the farm produce is delivered for storage, sale or any other specified use; and
- (j) the signature of the person issuing the weigh ticket. O. Reg. 420/84, s. 3.

4.—(1) Where a grain elevator operator or the operator's authorized representative issues a grain storage receipt under subsection 17 (2) of the Act, the grain elevator operator or authorized representative, as the case may be, shall record on the grain storage receipt,

- (a) the name, business address and licence number of the grain elevator operator;
- (b) the name and address of the owner of the farm produce;

- (c) the date or dates of delivery of the farm produce;
- (d) details of the grade and net weight of each kind of farm produce in respect of which the receipt is issued;
- (e) the serial numbers of the weigh tickets in respect of which the receipt is issued; and
- (f) the signature of the person issuing the grain storage receipt.

(2) A grain storage receipt shall include a statement to the effect that,

- (a) the receipt is issued under the Act; and
- (b) the farm produce is accepted for storage as fungible goods, unless otherwise arranged for. O. Reg. 420/84, s. 4.

5.—(1) Where farm produce is delivered for storage to a grain elevator operator and the farm produce or a portion thereof is subsequently released from storage by the grain elevator operator, the grain elevator operator or the operator's authorized representative shall immediately record the details of such release on the grain storage receipt.

(2) Where farm produce or any portion thereof is released from storage, the grain elevator operator or the operator's authorized representative shall record the details of such release on the owner's copy of the grain storage receipt upon presentation thereof by the owner. O. Reg. 420/84, s. 5.

6.—(1) Where a sale of farm produce in storage is made as provided in subsection 18 (3) of the Act, the grain elevator operator shall ensure that the owner receives full payment in respect thereof not later than the hour of 2 p.m. on the next trading day following the day of sale.

(2) Where payment is to be made as provided in subsection (1), it shall be made at the option of the owner,

- (a) by mailing by prepaid first-class mail;
- (b) personally at the grain elevator operator's place of business; or
- (c) otherwise as may be agreed upon by the owner and the grain elevator operator.

(3) Where the owner has not received payment in accordance with this section, the owner shall forthwith notify the chief inspector of the default in payment. O. Reg. 420/84, s. 6.

7. The percentage amount prescribed for the purposes of subsection 18 (4) of the Act is 75 per cent. O. Reg. 420/84, s. 7.

8. In addition to such terms and conditions as may be prescribed in the licence, every licence issued under subsection 5 (1) of the Act is subject to the condition that the grain elevator operator shall direct the insurer mentioned in section 20 of the Act to notify the chief inspector forthwith in a manner suitable to the chief inspector of any lapse, termination or other alteration in a contract of insurance required by section 20 of the Act. O. Reg. 420/84, s. 8.

9. An agreement to sell farm produce shall provide that the grain elevator operator offers to purchase the farm produce at the opera-

tor's bid price on the date of acceptance of the offer. O. Reg. 420/84, s. 9.

10.—(1) The term for a shortfall permit shall be thirty days or such lesser period as is set out in the permit.

(2) Despite subsection (1), if a shortfall permit is issued for a period beginning between the 15th day of September and the 5th day of December, the permitted period of shortfall may run until the 5th day of January of the following year. O. Reg. 548/89, s. 3, *part*.

11.—(1) A shortfall permit shall be issued to an applicant who has deposited with the chief inspector for the term of the shortfall permit, plus a further period of not more than ninety days to permit the chief inspector to determine whether the shortfall has been replaced, security in the amount of the market value of the farm produce permitted to be in shortfall.

(2) If, during the term of the shortfall permit, the market value of the farm produce increases, the chief inspector may require the applicant to deposit additional security equal to the amount of the increase. O. Reg. 548/89, s. 3, *part*.

Guarantee Companies Securities Act
Loi sur les compagnies de cautionnement

REGULATION 541

APPROVED GUARANTEE COMPANIES

1. The incorporated companies listed in the Schedule are approved as guarantee companies. R.R.O. 1980, Reg. 444, s. 1.

Schedule

The Aetna Casualty and Surety Company	Economical Mutual Insurance Company
Aetna Casualty Company of Canada	Elite Insurance Company
Aetna Insurance Company	Federal Insurance Company
Allstate Insurance Company of Canada	Federated Mutual Insurance Company
Alta Surety Company	Federation Insurance Company of Canada
Anglo Canada General Insurance Company	Fireman's Fund Insurance Company
The Canada Accident and Fire Assurance Company	The General Accident Assurance Company of Canada
Canada Security Assurance Company	General Insurance Company of America
Canadian General Insurance Company	General Security Insurance Company of Canada
Canadian Great Lakes Casualty and Surety Company Ltd.	Gerling Global General Insurance Company
The Canadian Indemnity Company	Gibraltar General Insurance Company
The Canadian Surety Company	Gore Mutual Insurance Company
The Casualty Company of Canada	Great American Insurance Company
Central Mutual Insurance Company	The Guarantee Company of North America
Chateau Insurance Company	Guardian Insurance Company of Canada
Chubb Insurance Company of Canada	The Halifax Insurance Company
The Citadel General Assurance Company of Canada	The Hartford Fire Insurance Company
Coachman Insurance Company	The Home Insurance Company
Commerce and Industry Insurance Company of Canada	INA Insurance Company of Canada
The Commerce Group Insurance Company	Insurance Company of North America
Commercial Union Assurance Company of Canada	The Insurance Corporation of Ireland Limited
Constitution Insurance Company of Canada	Laurentienne Generale, Compagnie d'Assurances inc.
The Continental Insurance Company	London and Midland General Insurance Company
Co-operators General Insurance Company	Lumbermens Mutual Casualty Company
Coronation Insurance Company, Limited	Marked Insurance Company of Canada
Cumis General Insurance Company	Maryland Casualty Company
The Dominion of Canada General Insurance Company	The Mortgage Insurance Company of Canada
The Dominion Insurance Corporation	New Rotterdam Insurance Company
Eaton Bay Insurance Company	The New Zealand Insurance Company Limited
	Niagara Fire Insurance Company
	Norwich Union Fire Insurance Society, Limited
	Pearl Assurance Public Limited Company
	Perth Insurance Company

Phoenix Assurance Company of Canada	Symons General Insurance Company
The Phoenix Insurance Company (Hartford, Conn.)	Toronto General Insurance Company
Pilot Insurance Company	Traders General Insurance Company
The Prudential Assurance Company, Limited	The Travelers Indemnity Company
Reliance Insurance Company (of Philadelphia)	Travelers Indemnity Company of Canada
Royal Insurance Company of Canada	United States Fidelity and Guaranty Company
Safeco Insurance Company of America	United States Fire Insurance Company
St. Paul Fire and Marine Insurance	USF & G Insurance Company of Canada
Scottish & York Insurance Co. Limited	Waterloo Insurance Company
Seaboard Surety Company	The Wawanesa Mutual Insurance Company
Simcoe & Erie General Insurance Company	Wellington Insurance Company
The Sovereign General Insurance Company	Western Surety Company
The Stanstead & Sherbrooke Insurance Company	Zurich Insurance Company
State Farm Fire and Casualty Company	
Sun Alliance Insurance Company	

O. Reg. 536/85, s. 1; O. Reg. 46/88, s. 1; O. Reg. 699/88, s. 1.

Healing Arts Radiation Protection Act *Loi sur la protection contre les rayons X*

REGULATION 542

HOSPITALS PRESCRIBED FOR THE INSTALLATION AND OPERATION OF COMPUTERIZED AXIAL TOMOGRAPHY SCANNERS

1. Each hospital listed in Column 1 of the following Table is prescribed as a hospital that may install, operate or cause or permit the installation or operation of the number of computerized axial tomography scanners set out opposite thereto in Column 2 of the following Table:

TABLE

ITEM	COLUMN 1	COLUMN 2
1.	Chedoke McMaster	1
2.	Children's Hospital of Eastern Ontario	1
3.	Etobicoke General	1
4.	Hamilton Civic	1
5.	Hamilton Henderson	1
6.	Kingston General	1
7.	Kitchener-Waterloo	1
8.	London University	1
9.	London Victoria	2
10.	Mississauga General	1
11.	Mt. Sinai-Toronto	1
12.	North York General	1
13.	Oshawa General	1
14.	Ottawa Civic	1
15.	Ottawa General	1
16.	St. Catharines General	1
17.	St. Joseph's Hamilton	1
18.	St. Joseph's Health Centre-Toronto	1
19.	St. Joseph's London	1
20.	Scarborough General	1
21.	Sudbury General	1
22.	Thunder Bay McKellar	1
23.	The Toronto Hospital	2
24.	Toronto Humber Memorial	1
25.	Toronto Princess Margaret	1
26.	Toronto St. Michael's	1
27.	Hospital for Sick Children	2
28.	Toronto Sunnybrook	2
29.	Toronto Wellesley	1
30.	Windsor Hotel Dieu	1
31.	Toronto East General	1

ITEM	COLUMN 1	COLUMN 2
32.	Toronto York Finch	1
33.	Peterborough Civic	1
34.	Oakville Trafalgar	1
35.	Scarborough Centenary	1
36.	Sarnia General	1
37.	Joseph Brant Memorial Burlington	1
38.	Grey Bruce Regional Health Centre	1
39.	General Hospital, Sault Ste. Marie	1
40.	York County Hospital, Newmarket	1
41.	Peel Memorial Hospital	1
42.	Brantford General Hospital	1
43.	Credit Valley Hospital Mississauga	1
44.	Metropolitan General Hospital Windsor	1

O. Reg. 344/84, s. 1; O. Reg. 237/86, s. 1; O. Reg. 557/86, s. 1;
O. Reg. 24/87, s. 1; O. Reg. 241/87, s. 1; O. Reg. 461/88, s. 1.

REGULATION 543

X-RAY SAFETY CODE

1. In this Regulation,

"aluminum equivalent" of a material means the thickness of aluminum (Aluminum Association Type 1100) that affords the same attenuation as the material where the aluminum and the material are irradiated under the same conditions;

"attenuation" means the decrease in radiation intensity caused by absorption and scattering of x-rays in a medium;

"automatic exposure control" means a device that delivers a predetermined quantity of radiation to the image receptor by automatically controlling one or more technique factors;

"average peak kilovoltage" means the maximum kilovoltage developed in a single pulse of voltage applied to the anode of an x-ray tube averaged over at least twelve successive pulses;

"backscatter" means radiation reaching a point from material located more distant from the x-ray source than the point;

"beam limiting device" means a device that restricts the dimensions of the useful beam;

"cephalometric x-ray machine" means a dental x-ray machine that is used for the examination of the maxillofacial skeleton;

"chiroptic x-ray machine" means an x-ray machine that is used for the examination of the foot;

"coefficient of variation" means the ratio of the estimated standard deviation to the mean value of a series of measurements calculated using the following equation:

$$C = \frac{S}{\bar{X}} = \frac{1}{\bar{X}} \sqrt{\frac{\sum_{i=1}^n (X_i - \bar{X})^2}{n-1}} \quad \frac{1}{2}$$

where X_i = i^{th} measurement

\bar{X} = mean value of the measurements

S = estimated standard deviation

n = number of measurements

C = the coefficient of variation;

“control booth” means a defined area in which an x-ray worker operates an x-ray machine;

“control panel” means that part of an x-ray machine that contains the switches, knobs, keys, buttons or other controls accessible to the x-ray operator that are used to set technique factors manually or automatically;

“darkroom” means an enclosed space that is constructed to process light sensitive materials;

“density unit” means the relative amount of light transmitted through a processed film expressed on a common logarithmic scale;

“dental x-ray machine” means an x-ray machine that is used outside the mouth to examine teeth, jaws and related structures;

“diagnostic x-ray machine” means an x-ray machine that is used for the examination of a human being but does not include a radiation therapy simulator or a computerized transaxial tomographic x-ray machine;

“dose equivalent” means a quantity that expresses on a common scale the energy absorbed by a small mass of a body irradiated by a beam of radiation weighted by a factor describing the biological effectiveness of the radiation concerned;

“filter” means material that is placed in the useful beam to attenuate preferentially the lower energy or a specific energy range of x-rays;

“fluoroscopic x-ray machine” means an x-ray machine, an image receptor and the equipment associated with the x-ray machine and the image receptor that is used in fluoroscopy;

“fluoroscopy” means a mode of x-ray exposure in which the image receptor and associated equipment produce and display a visible image that is viewed by the operator during or subsequent to the exposure;

“general-purpose radiographic x-ray machine” means a radiographic x-ray machine that is not limited by design or adaptation to radiographic examination of a specific anatomical region;

“half-value layer” means the thickness of a specified material that attenuates the x-ray beam under conditions that minimize scattered radiation such that the exposure is reduced to one-half of its original value;

“image receptor” means a device that converts incident x-radiation into a visible image or into a form that can be made into a visible image by further transformation;

“lead equivalent” of material means the thickness of lead that affords the same attenuation as the material where the lead and the material are irradiated under the same conditions;

“leakage radiation” means all the radiation except the useful beam that comes from within the housing of an energized x-ray tube or

the radiation that is produced when the exposure switch or timer of an x-ray machine is not activated;

“light field” means the area of light at a specified plane that is directly outlined by a beam limiting device;

“mammographic x-ray machine” means an x-ray machine that is used for the examination of the breast;

“manual exposure control” means a device that is used by an x-ray operator to set technique factors in order to deliver a predetermined quantity of radiation to the image receptor;

“mobile x-ray machine” means an x-ray machine that can be moved from one location to another;

“occupancy” means the nature and extent of use of space adjacent to an x-ray machine;

“optical density” means the degree of opacity to visible light of a processed film expressed in density units;

“panoramic x-ray machine” means a tomographic unit used for the production of radiographs of the teeth, jaws and related structures on a single film or radiograph;

“patient entrance exposure” means the x-ray exposure, excluding exposure arising from back-scattered radiation, in the centre of an x-ray beam at the position of the surface of the patient that is closest to the x-ray source;

“phantom” means an object that simulates a patient when placed in an x-ray beam for the purpose of testing an x-ray machine or image receptor;

“photofluorographic x-ray machine” means an x-ray machine that records photographically in reduced size the image produced on a fluorescent screen;

“primary protective barrier” means a barrier that is sufficient to attenuate the useful beam to a specified degree;

“protective accessory” means a device that is used to protect a person in an x-ray facility from receiving unnecessary radiation;

“secondary protective barrier” means a barrier that is sufficient to attenuate stray radiation to a specified degree;

“stationary x-ray machine” means an x-ray machine that is installed permanently in one location and includes a machine that is permanently installed in a truck, bus, train or other movable facility;

“technique factors” means the following conditions of operation of a diagnostic x-ray machine that can be selected by the operator:

1. The peak tube potential.
2. The tube current.
3. The exposure time.
4. The added filtration.
5. A combination of the variables set out in paragraphs 1 to 4.
6. The distance between the radiation source and the image receptor;

“tube housing assembly” means an x-ray tube housing that has an x-ray tube installed in it;

“useful beam” means the delineated beam of x-rays that passes through the tube housing and the beam-limiting aperture;

“whole-body-dose-equivalent” means the weighted average of the

dose-equivalents received by all tissues in the body of an irradiated person;

“work-load” means the degree of use of an x-ray machine expressed in milliamperere minutes;

“x-ray exposure” means a quantity of x-rays delivered at a defined point in space or in a medium that is expressed in terms of the amount of electric charge produced by the radiation in a small mass of air located at the point;

“x-ray field” means the area of the intersection of a useful beam and one of the set of planes parallel to the plane of the image receptor;

“x-ray room” means a defined area where one or more permanently fixed x-ray machines and equipment are located;

“x-ray tube” means an evacuated envelope that is designed to produce x-rays by the bombardment of a metal target by accelerated electrons;

“x-ray worker” means a person who is qualified under the Act or the regulations to operate an x-ray machine. O. Reg. 511/85, s. 1.

2.—(1) The following information is prescribed for the purpose of clause 3 (2) (a) of the Act:

1. The name of the owner of the x-ray machine.
2. The number or identifying name of the x-ray room for which approval of installation is sought.
3. The name of the manufacturer and the model number of the x-ray machine, the anticipated maximum workload, the maximum tube voltage, and the maximum tube current.
4. The thickness and nature of materials that form the boundaries of the x-ray room.
5. The occupancy of the adjacent spaces, including spaces above and below the x-ray room.
6. The percentage of the working day each adjacent space is occupied.
7. The percentage of the exposure time the useful beam is projected toward each adjacent space.

(2) The following plan, to be submitted in duplicate, is prescribed for the purpose of clause 3 (2) (a) of the Act:

A floor plan drawn to a scale of not less than one to fifty that indicates:

1. The compass point North.
2. The name of the owner and address of the installation.
3. The limits of travel of the x-ray tube within the room.
4. The location of the control booth or the exposure switch.
5. The position of each horizontal or erect x-ray film cassette holder.
6. The location of the darkroom and storage of unprocessed film.

(3) In addition to the requirements prescribed in subsection (2) where the application for approval is for the installation of an x-ray machine in a dental facility, the floor plans shall indicate,

- (a) the position and limits of rotation of the chair; and

- (b) the position of the head of the person being irradiated. O. Reg. 45/84, s. 2.

3.—(1) Every installation of an x-ray machine shall be shielded with a primary protective barrier and a secondary protective barrier so that,

- (a) no x-ray worker receives a whole-body-dose-equivalent of more than 1 millisievert (100 millirem) per week; and
- (b) no person, other than the patient undergoing an application of therapeutic or diagnostic x-rays, who is not an x-ray worker, receives a whole-body-dose-equivalent of more than 0.1 millisievert (10 millirem) per week.

(2) The barriers referred to in subsection (1) shall comply with the standards contained in Appendix 2 of Safety Code-20A—X-Ray Equipment in Medical Diagnosis Part A: Recommended Safety Procedures for Installation and Use, published by the Department of National Health and Welfare.

(3) Where lead shielding is used as a barrier, it shall be mounted in such a manner as to avoid sagging or damage to the lead shielding.

(4) Joints between different kinds of barrier material shall be constructed so that the overall attenuation of the barrier is not impaired.

(5) Windows, doors or other openings in a barrier shall be so constructed that they meet the same protection design standards referred to in subsection (2) that apply to barriers.

(6) All doors leading directly into an x-ray room shall be fitted with self-closing devices and, where the doors are accessible to the public, shall have prominently displayed on them warning signs sufficient to alert persons to the presence of the x-ray equipment.

(7) Unprocessed film shall be protected from x-rays being generated by x-ray machines in the facility so that during its storage the increase in optical density caused by unintentional irradiation is less than 0.02 density units. O. Reg. 45/84, s. 3.

4.—(1) The following subject-matters for courses of study in the operation of x-ray machines and x-ray equipment are prescribed:

1. Properties of radiation.
2. Interactions of radiation.
3. Biological effects of radiation.
4. Background radiation.
5. Measurement of radiation.
6. Production and characteristics of x-rays.
7. Relationship between technical factors that affect image quality and dose.
8. Radiation protection legislation.
9. Control of radiation hazards.
10. Quality control.

(2) The Commission shall not approve any courses of study in the operation of x-ray machines and x-ray equipment unless the courses include the subject-matters set out in subsection (1). O. Reg. 511/85, s. 2, *part*.

(3) Successful completion of one of the following requirements is prescribed for the purposes of sections 5 and 7 of the Act in respect of any person who operates an x-ray machine in a dental diagnostic x-ray facility:

1. A course in dental radiation safety approved by the Commission.
2. A program or course in dental assisting that is approved by the Commission at a College of Applied Arts and Technology.
3. On and after the 1st day of January, 1981, a dental assisting program that is approved by the Commission at,
 - i. Career Canada Limited,
 - ii. Career Canada (Hamilton) Limited,
 - iii. Lorne Park Secondary School,
 - iv. Etobicoke Collegiate Institute,
 - v. Sir Allan MacNab Secondary School,
 - vi. Toronto School of Business Inc., 5631 Yonge Street, Willowdale, Ontario, or
 - vii. Barnett—Christie Corporation carrying on business as the College of Business Training, 2820 Danforth Avenue, Toronto, Ontario.
4. A program or course in dental assisting offered by the Canadian Armed Forces. O. Reg. 511/85, s. 2, *part*; O. Reg. 722/87, s. 1.

5.—(1) A person who is a member of a class of persons set out in Column 1 of Table 1 is exempt from the provision of subsection 5 (1) of the Act provided that the person only operates an x-ray machine under the supervision of a person set out opposite thereto in Column 2 of Table 1.

(2) The owner of an x-ray machine that is installed in a public hospital approved under the *Public Hospitals Act* or in a private radiological clinic that has no legally qualified medical radiologist on staff is exempt from the requirement of subsection 9 (1) of the Act provided that the owner designates a registered radiological technician who, in the opinion of the Director of x-ray Safety, is competent to act as radiation protection officer for the facility in which the x-ray machine is installed. O. Reg. 511/85, s. 2, *part*.

6. Persons who are registered under the *Radiological Technicians Act* and who are employed or engaged by the Ontario Cancer Treatment and Research Foundation are exempt from section 6 of the Act in the operation of an x-ray machine for the irradiation of a human being if the irradiation is part of a breast cancer screening program administered by the Ontario Cancer Treatment and Research Foundation. O. Reg. 352/90, s. 1.

7. The classes of radiation protection officers set out in Column 1 of Table 2 are prescribed and may only act as radiation protection officers for the class of facility set out opposite thereto in Column 2 of Table 2. O. Reg. 511/85, s. 2, *part*.

8.—(1) Every radiation protection officer shall ensure that every person who operates an x-ray machine in the facility for which he or she is a radiation protection officer is qualified in accordance with this Regulation to operate an x-ray machine.

(2) Every radiation protection officer shall establish and maintain procedures and tests for the x-ray machines and x-ray equipment in the facility for which he or she is a radiation protection officer to ensure compliance with this Regulation.

(3) Every radiation protection officer shall ensure that protective accessories of at least 0.5 millimetres lead equivalent at 150 kilovolts peak are available for use by persons who may receive exposure to x-rays in the facility.

(4) Every radiation protection officer shall provide to the Direc-

tor of x-ray Safety, within sixty days of the installation of a new x-ray machine in a facility where he or she is the radiation protection officer, written results of the tests conducted to verify whether or not the x-ray machine complies with the provisions of the *Radiation Emitting Devices Act* (Canada) and the regulations made thereunder.

(5) Every radiation protection officer shall provide to the Director of x-ray Safety, within sixty days of the installation of a used x-ray machine in a facility where he or she is the radiation protection officer, written results of the tests conducted to verify whether or not the x-ray machine complies with the provisions of the Act and this Regulation.

(6) Every radiation protection officer shall ensure that records are maintained of each test required to be carried out under this section that set out,

- (a) the type and result of the test;
- (b) the frequency of testing where applicable; and
- (c) the action taken to correct each deficiency identified by the test.

(7) Every radiation protection officer shall ensure that the records referred to in subsection (6) are maintained for at least six years from the time of their making in the facility in which the x-ray machine to which the records referred to is operated.

(8) Every dental radiation protection officer shall ensure that at the facility where the officer acts, the procedures and tests set out in Column 1 of Table 3 are conducted at the frequencies set out opposite thereto in Column 2 of Table 3.

(9) Every chiropodic radiation protection officer shall ensure that at the facility where the officer acts, the procedures and tests set out in Column 1 of Table 4 are conducted at the frequencies set out opposite thereto in Column 2 of Table 4.

(10) Every medical radiation protection officer and every chiropractic radiation protection officer shall ensure that at the facility where the officer acts, the procedures and tests set out in Column 1 of Table 5 are conducted at the frequencies set out opposite thereto in Column 2 of Table 5.

(11) Every medical radiation protection officer, every chiropractic radiation protection officer and every chiropodic radiation protection officer shall ensure that at the facility where the officer acts, the entrance exposure of that part of a patient set out in Column 1 of Table 6 of a thickness set out opposite thereto in Column 2 of Table 6 that is a distance from the x-ray source set out opposite thereto in Column 3 of Table 6 does not exceed the exposure set out opposite thereto in Column 4 of Table 6.

(12) Every dental radiation protection officer shall ensure that at the facility where the officer acts, the entrance exposure of that part of a patient set out in Column 1 of Table 7 at the measured potential set out opposite thereto in Column 2 of Table 7 does not exceed the exposure set out opposite thereto in Column 3 of Table 7. O. Reg. 511/85, s. 2, *part*.

(13) Every radiation protection officer shall notify the Director of x-ray Safety forthwith of the occurrence, in a facility where he or she is a radiation protection officer, of,

- (a) an accident involving an x-ray machine; or
- (b) an overexposure to radiation involving a patient or patients. O. Reg. 511/85, s. 2, *part, revised*.

(14) In addition to the notice required under subsection (13), the radiation protection officer shall ensure that a written report of the accident or overexposure is received by the Director of x-ray Safety not later than five days after the occurrence of the accident or overexposure. O. Reg. 511/85, s. 2, *part*.

9.—(1) Every diagnostic x-ray machine shall bear either on the external surface of the main x-ray control panel or at the exposure switch location a warning sign that indicates that,

- (a) unauthorized use is prohibited; and
- (b) hazardous radiation is emitted when the x-ray machine is activated.

(2) Every diagnostic x-ray machine shall be so constructed that,

- (a) all controls, meters, lights or other indicators on the machine are readily recognizable and clearly identifiable as to function;
- (b) the x-ray tube is securely fixed and correctly aligned with the tube housing;
- (c) the x-ray tube housing maintains its required exposure position without significant drifting, tipping or vibration so as to affect the quality of the image;
- (d) there are recognizable warning lights or other indicators that indicate,
 - (i) when the machine is energized and is ready to produce x-rays, and
 - (ii) when the x-rays are produced;
- (e) where the machine has individual technique factors that are either fixed or can be selected manually by the operator, there are electrical meters, controls or other indicators to enable the x-ray operator to determine those selected technique factors before the patient is irradiated;
- (f) where the x-ray machine is used in the radiographic mode and has automatically controlled exposure or anatomically related exposure selection or falling load, there is an electrical meter, control or other indicator that enables the x-ray operator to determine the kilovoltage before the patient is irradiated;
- (g) where the x-ray machine is battery powered, there is a visual indicator that shows whether the battery is charged for proper operation;
- (h) it is not possible to energize more than one x-ray tube at the same time; and
- (i) where there are two x-ray tubes, there is a visible indication of which x-ray tube is selected and ready to be activated at the control panel.

(3) Every diagnostic x-ray machine shall be provided with,

- (a) an exposure switch, timer or other device that is controlled by the operator to initiate and terminate the irradiations; and
- (b) filters that,
 - (i) are located in the exit port of the x-ray tube housing or beam limiting device or both,
 - (ii) intercept the entire useful beam, and
 - (iii) at a measured potential set out in Column 1 of Table 8 with a thickness of aluminum set out opposite thereto in Column 2 of Table 8, reduce the exposure at least by half. O. Reg. 511/85, s. 2, *part*.

10.—(1) Every exposure switch on an x-ray machine shall,

- (a) be so located that it cannot be conveniently operated outside a shielded area; and
- (b) where it is part of a mobile machine, be equipped with a cable at least three metres in length.

(2) Clause (1) (a) does not apply to an exposure switch that is used in conjunction with mobile x-ray machines, spot-film devices or fluoroscopy.

(3) Every exposure switch on an x-ray machine shall be so constructed that it requires continuous pressure by the x-ray operator to produce x-rays, except where the x-ray machine is equipped with a serial changer.

(4) Where an exposure switch on an x-ray machine is used in conjunction with a serial changer, the switch shall be so constructed that it permits the x-ray operator to terminate an irradiation at any time.

(5) Every exposure switch on an x-ray machine that is a foot switch shall be so constructed as to prevent an unintended exposure if the switch is overturned. O. Reg. 511/85, s. 2, *part*.

11.—(1) Every diagnostic x-ray machine and every fluoroscopic x-ray machine shall, except where the x-ray machine is equipped with an automatic exposure control device, be so constructed that the timing device on the machine terminates an irradiation on completion of,

- (a) a preset time interval;
- (b) a preset product of current and time; or
- (c) a preset number of pulses. O. Reg. 511/85, s. 2, *part, revised*.

(2) Where an x-ray machine is equipped with an automatic exposure control device, the device shall terminate the exposure to the patient when a predetermined amount of radiation is detected.

(3) Every timing device on a diagnostic x-ray machine and fluoroscopic x-ray machine shall be so constructed that it,

- (a) resets automatically to its original position or to ZERO on termination of an irradiation; and
- (b) prevents an irradiation from occurring at the ZERO or OFF position. O. Reg. 511/85, s. 2, *part*.

12. Every beam limiting device on an x-ray machine shall be so constructed that it affords the same attenuation of leakage radiation as that required of the tube housing assembly. O. Reg. 511/85, s. 2, *part*.

13.—(1) Every diagnostic x-ray machine that is equipped with an automatic exposure control shall be equipped with,

- (a) an indicator that shows when the automatic exposure control mode of operation has been selected;
- (b) a means of terminating the exposure,
 - (i) of an x-ray tube with a potential of less than fifty kilovolts peak, when the product of the x-ray tube current and the exposure time is 2,000 milliamperes-seconds per exposure, or
 - (ii) of an x-ray tube with a potential of fifty kilovolts peak or more, when,
 - (A) the product of the x-ray tube current and the exposure time is 600 milliamperes-seconds, or
 - (B) the product of the peak x-ray tube potential,

current and exposure time is sixty kilowatt-seconds per exposure; and

- (c) an indicator that warns the operator that a condition set out in subclause (b) (i) or (ii) has been reached.
- (2) Every diagnostic x-ray machine shall be so constructed that,
- (a) over the normal range of use of the machine for any given combination of x-ray tube potential (in kilovolts peak), tube current (in milliamperes), exposure time (in seconds) or for selected radiation exposure to the image receptor (in milliroentgens),
- (i) the estimated coefficient of variation of any ten consecutive radiation exposure measurements taken at the same source-to-detector distance within a time period of one hour is no greater than 0.08, and
- (ii) each of the ten radiation exposures referred to in subclause (i) is within 20 per cent of the mean value of the ten measurements;
- (b) for any selected setting of the peak x-ray tube potential over the normal range of use of the machine, the average peak kilovoltage corresponds to the selected value to within ± 8 per cent;
- (c) the timer on the x-ray machine may be set to control irradiations as short as 1/30 second or five milliamperes-seconds, whichever is greater;
- (d) at each setting over the normal range of use, the timer on the x-ray machine is accurate to within ± 10 per cent; and
- (e) at each setting over the normal range of use, the timer on the x-ray machine will comply with the reproducibility standards set out in clause (a).
- (3) Subsection (2) does not apply to dental x-ray machines, chiropractic x-ray machines or to mammographic x-ray machines.

(4) Where a diagnostic x-ray machine is constructed so that the tube current (in milliamperes) has a range of preset values and both it and the exposure time (in seconds) can be selected individually, the average ratios of exposure (in milliroentgens) to the product of tube current and exposure time, obtained at any two adjacent tube current settings for any fixed indicated value of x-ray tube potential (in kilovolts) over the normal range of use of the machine, shall not differ by more than 0.10 times their sum or

$$\left| \bar{x}_1 - \bar{x}_2 \right| \leq 0.10 (\bar{x}_1 + \bar{x}_2)$$

where x_1 and x_2 are the average mR/mAs (milliroentgens divided by milliamperes-seconds) values obtained at the two selected settings of mA (milliamperes).

(5) Where a diagnostic x-ray machine is constructed so that the exposure selection can be made only as the tube current exposure time product (in milliamperes-seconds) or where the milliamperes value is continuously variable, the average ratios of exposure (in milliroentgens) to the product of tube current and exposure time, obtained at any two selections of milliamperes-second differing by at least a factor of two, for any fixed indicated value of x-ray tube potential (in kilovolts) within the range of normal operation of the machine, shall not differ by more than 0.10 times their sum, or

$$\left| \bar{x}_1 - \bar{x}_2 \right| \leq 0.10 (\bar{x}_1 + \bar{x}_2)$$

where x_1 and x_2 are the average mR/mAs (milliroentgens divided by milliamperes-seconds) values obtained at the two selected settings of mA (milliamperes). O. Reg. 511/85, s. 2, *part*.

14.—(1) The leakage radiation measured at a distance of one metre in any direction from an x-ray source shall not exceed 100 milliroentgens in one hour under any conditions.

(2) The leakage radiation measurements referred to in subsection (1) shall be averaged over an area of 100 square centimetres with no linear dimension greater than twenty centimetres. O. Reg. 511/85, s. 2, *part*.

15.—(1) Every general-purpose radiographic x-ray machine and every mobile radiographic x-ray machine shall be equipped with an x-ray beam limiting device that,

- (a) provides for stepless adjustment of the size of the x-ray field;
- (b) provides for a minimum field size that does not exceed five centimetres by five centimetres at a target-to-image-receptor distance of 100 centimetres; and
- (c) ensures that at each position, the x-ray field is aligned with the image receptor in such a manner that the x-ray field is always confined within the boundaries of the image receptor.
- (2) An x-ray beam limiting device referred to in subsection (1) shall,
- (a) be equipped with an adjustable light beam diaphragm or other device that defines visually the outline of the x-ray field when the axis of the x-ray beam is perpendicular to the plane of the image; or
- (b) allow the operator to adjust the dimensions of the x-ray field at the image receptor to a size smaller than the dimensions of the image receptor.
- (3) An adjustable light beam diaphragm or other device that defines visually the outline of the x-ray field shall be so constructed that,
- (a) misalignment of the visually defined field with respect to the x-ray field along either the length or width of the x-ray field does not exceed 2 per cent of the target-to-image-receptor distance; and
- (b) the size of the x-ray field in the plane of the image receptor is indicated at selected distances that are accurate to within 3 per cent of the target-to-image-receptor distance. O. Reg. 511/85, s. 2, *part*.

16. Every general-purpose radiographic x-ray machine that is used with only one size of image receptor at a fixed target-to-image-receptor distance shall be equipped with devices to ensure that,

- (a) the centre of the x-ray field is aligned with the centre of the image receptor to within 2 per cent of the target-to-image-receptor distance; and
- (b) the x-ray field in the plane of the image receptor does not extend beyond any edge of the image receptor. O. Reg. 511/85, s. 2, *part*.

17.—(1) Every fluoroscopic x-ray machine shall be equipped with,

- (a) an image intensification system that,
- (i) includes a shielded protective barrier and shielding such that,
- (A) the entire cross-section of the useful beam is intercepted within the protective barrier for any target-to-image distance, and
- (B) the fluoroscopic x-ray tube is not capable of

- producing x-rays unless the shielding is in place to intercept the useful beam,
- (ii) in the case of a mobile fluoroscopic x-ray machine, is an integral part of the machine or is interlocked in such a manner that its removal prevents x-rays from being produced;
- (b) where it is a stationary machine, a means to prevent the x-ray tube from producing x-rays unless there is an image receptor in place to intercept the x-ray beam;
- (c) an audible signal that,
- (i) indicates completion of any preset time of use up to a maximum of five minutes, and
- (ii) continues to sound until the timer is reset whenever x-rays are produced after the preset time of use has expired, or,
- a timer circuit that will,
- (iii) cut off the high tension voltage to the x-ray tube after a preset time of use up to a maximum of five minutes, and
- (iv) continue to prevent fluoroscopy until the timer has been reset manually;
- (d) electrical meters or other visual indicators on the control panel that will provide a continuous indication of current in milliamperes;
- (e) a means to limit the target-to-skin distance to not less than,
- (i) twenty-five centimetres for a mobile fluoroscopic machine,
- (ii) thirty-eight centimetres for a stationary fluoroscopic machine, or
- (iii) twenty centimetres for an image-intensified fluoroscopic machine used for special procedures that would not be possible at the minimum target-to-skin distance set out in subclause (ii);
- (f) an x-ray beam limiting device that,
- (i) allows the operator to adjust the dimensions of the x-ray field at the image receptor to a size smaller than the dimensions of the image receptor, and
- (ii) aligns the x-ray field with the image receptor in such a manner that the x-ray field is always confined within the boundaries of the image receptor;
- (g) a shield of at least 0.25 millimetres lead equivalent at 100 kilovolts peak that intercepts scattered radiation originating in the patient that would otherwise reach the x-ray operator or other persons in the facility.
- (2) Clause (1) (b) does not apply to special purpose x-ray tubes or image intensifiers that are constructed to have free and independent movement within an x-ray room.
- (3) Clause (1) (g) does not apply to a mobile fluoroscopic x-ray machine.
- (4) The exposure rate limits of a fluoroscopic x-ray machine that uses a zinc cadmium sulphide input phosphor or a phosphor of similar efficiency calculated where the centre of the useful beam enters the patient at the shortest target-to-skin distance specified for the machine shall not exceed,
- (a) a maximum exposure rate of 12.5 roentgens per minute; and
- (b) an entrance exposure rate of five roentgens per minute for an average patient represented for test purposes by a twenty centimetre water phantom.
- (5) The exposure rate limit of a fluoroscopic x-ray machine that uses a cesium iodide input phosphor or a phosphor of similar efficiency calculated where the centre of the useful beam enters the patient at the shortest target-to-skin distance specified for the machine shall not exceed,
- (a) a maximum exposure rate of ten roentgens per minute; and
- (b) an entrance exposure rate of 2.5 roentgens per minute for an average patient represented for test purposes by a twenty centimetre water phantom.
- (6) Clauses (4) (a) and (5) (a) do not apply when the high-level control of the x-ray machine is activated.
- (7) A fluoroscopic x-ray machine that is equipped with an optional high-level control that allows higher exposure rates at the image receptor than the rates set out in subsections (4) and (5) shall be so constructed that,
- (a) the high-level control is activated by its own control separate from any other control; and
- (b) there is a continuous signal to the x-ray operator to indicate that the high-level control is being activated.
- (8) A photofluorographic x-ray machine shall only be used when the primary image is enhanced by electronic image intensification. O. Reg. 511/85, s. 2, *part*.
- 18.—(1) Every x-ray machine that is used to conduct mammographic x-ray examinations shall be equipped with,
- (a) an x-ray beam limiting device that limits the useful beam so that at any target-to-image-receptor distance specified for the machine the x-ray field in the plane of the image receptor,
- (i) does not exceed the edge of the image receptor next to the chest wall by more than 2 per cent of the target-to-image-receptor distance, and
- (ii) except for the edge of an image receptor referred to in subclause (i), does not extend beyond any other edge of the image receptor;
- (b) an image receptor supporting device that is shielded sufficiently to ensure that for each activation of the x-ray tube the radiation exposure does not exceed 0.1 milliroentgens where,
- (i) the machine is operated,
- (A) in the mammographic mode,
- (B) at the maximum rated x-ray tube potential,
- (C) the maximum rated tube current-exposure product for that tube potential, and
- (D) at the minimum target-to-receptor distance attainable, and
- (ii) the radiation exposure is averaged over a detection area of 100 square centimetres, with no linear dimension greater than twenty centimetres and centred at five centimetres from an accessible surface beyond the plane of the support device; and

(c) a device that will compress the breast of the patient being x-rayed.

(2) A removable fixed-operative beam limiting device that is installed on an x-ray machine that is constructed or adapted to perform mammographic examinations shall bear on its external surface clearly visible permanent markings that state,

(a) the image receptor size; and

(b) the target-to-image-receptor distance for which the beam limiting device is designed.

(3) Every mammographic x-ray machine shall be so constructed that the accuracy of kilovoltage calibration for the machine is ± 1 kilovolts for kilovoltage up to thirty-five and ± 4 per cent for kilovoltage above thirty-five.

(4) Every x-ray machine that is constructed or adapted to perform mammographic examinations shall be so constructed or adapted that,

(a) for any selected combination of kilovoltage, current and time, the coefficient of variation of any ten consecutive radiation measurements taken at the same distance within a time period of one hour is not greater than 0.08;

(b) where the timer is non-mechanical, it is accurate to within 1/30 second (two cycles) or 10 per cent of the set value, whichever is greater; and

(c) where the timer is mechanical, it is accurate to within 1/20 second or 15 per cent, whichever is greater. O. Reg. 511/85, s. 2, *part*.

19. Only tungsten target x-ray tubes shall be used for xeroradiography. O. Reg. 511/85, s. 2, *part, revised*.

20.—(1) Every dental x-ray machine and every chiropodic x-ray machine shall be so constructed that,

(a) for any selected combination of kilovoltage, current and time, the estimated coefficient of variation of any ten consecutive radiation measurements taken at the same distance within a time period of one hour is not greater than 0.08;

(b) when the x-ray machine is operating in the fixed milliamperage mode, the timer is, at each setting, accurate to within 1/30 second (two cycles) or 10 per cent of the set value; and

(c) for any selected setting of the peak x-ray tube potential, the actual peak kilovoltage corresponds to the selected value to within ± 8 per cent.

(2) Clause (1) (b) does not apply to equipment used for panoramic dental examinations. O. Reg. 511/85, s. 2, *part*.

21.—(1) Every dental x-ray machine shall be equipped with a beam limiting device that limits the size of the useful beam to a maximum linear dimension of seven centimetres at the end of the localizing cone or device.

(2) Subsection (1) does not apply to a panoramic x-ray machine or a cephalometric x-ray machine. O. Reg. 511/85, s. 2, *part*.

22. Every panoramic x-ray machine shall be equipped with a beam limiting device that limits the useful beam at the image receptor to a size not more than 2 per cent of the source-to-image-receptor distance at each dimension of the scanning slit. O. Reg. 511/85, s. 2, *part*.

23. Every cephalometric x-ray machine shall be equipped with a beam limiting device that limits the size of the useful beam to maximum linear dimensions of thirty-one centimetres by thirty-eight centimetres at the plane of the image receptor. O. Reg. 511/85, s. 2, *part*.

TABLE 1

ITEM	COLUMN 1	COLUMN 2
	Class of Student	Supervisor
1.	Medical student	Radiologist
2.	Dental student	Dentist
3.	Dental Hygiene student	Dentist
4.	Dental Assisting student	Dentist
5.	Chiropractic student	Chiropractor
6.	Radiological Technology student	Radiologist or Radiological Technician registered under the <i>Radiological Technicians Act</i>

O. Reg. 511/85, s. 3, *part*.

TABLE 2

ITEM	COLUMN 1	COLUMN 2
	Class of Radiation Protection Officer	Class of Facility
1.	Medical radiation protection officer	Medical facility
2.	Dental radiation protection officer	Dental facility
3.	Chiropractic radiation protection officer	Chiropractic facility
4.	Chiropodic radiation protection officer	Chiropody facility

O. Reg. 511/85, s. 3, *part*.

TABLE 3
Dental Facility

ITEM	COLUMN 1	COLUMN 2
	Test or Procedure	Frequency
1.	Photographic quality control	Every operational day
2.	Patient entrance exposure measurements	Every twelve months and upon alteration or servicing of the machine
3.	Collimation	Every twelve months and upon alteration or servicing of the machine
4.	Half-value layer	Every twelve months and upon alteration or servicing of the machine

O. Reg. 511/85, s. 3, *part.*

TABLE 4
Chiropractic Facility

ITEM	COLUMN 1	COLUMN 2
	Test or Procedure	Frequency
1.	Photographic quality control	Every operational day
2.	Patient entrance exposure measurements	Every twenty-four months and upon alteration or servicing of the machine
3.	Collimation	Every twelve months and upon alteration or servicing of the machine
4.	Half-value layer	Every twelve months and upon alteration or servicing of the machine

O. Reg. 511/85, s. 3, *part.*

TABLE 5
Medical and Chiropractic Facilities

ITEM	COLUMN 1	COLUMN 2
	Test or Procedure	Frequency
1.	Photographic quality control	Every operational day
2.	Patient entrance exposure measurements	Every six months and upon alteration or servicing of the machine
3.	Collimation	Every six months and upon alteration or servicing of the machine
4.	Half-value layer	Every six months and upon alteration or servicing of the machine
5.	Phototiming parameters including operation of back-up timer	Every six months
6.	Fluoroscopic parameters, including,	
	(a) maximum patient entrance exposure rate	Every six months and upon servicing of the machine
	(b) resolution	Every six months and upon servicing of the machine
	(c) limit timer	Every six months and upon servicing of the machine
	(d) automatic brightness control	Every six months and upon servicing of the machine
7.	Tomographic parameters, including fulcrum accuracy, thickness of cut and mechanical stability	Every six months

O. Reg. 511/85, s. 3, *part.*

TABLE 6

ITEM	COLUMN 1	COLUMN 2	COLUMN 3	COLUMN 4
	Projection	Patient thickness*	Source-to-image distance	Maximum entrance exposure** expressed in milliroentgens
1.	Abdomen AP	23 cm	100 cm	450
2.	Cervical Spine AP	13 cm	100 cm	120
3.	Chest PA	23 cm	180 cm	20
4.	Foot (Dorso-Plantar) Direct Film	8 cm	100 cm	200
5.	Full Spine	23 cm	180 cm	250
6.	Intravenous Pyelogram	23 cm	100 cm	500
7.	Lumbar Spine AP	23 cm	100 cm	500
8.	Lumbar Spine Lateral	32 cm	100 cm	2,000
9.	Mammogram (a) Film (b) Xerox	4 cm (compressed) 4 cm (compressed)	As used As used	900 1,600
10.	Skull Lateral	15 cm	100 cm	170
11.	Thoracic Spine AP	23 cm	100 cm	400

* standard for test purposes
** exposures expressed as exposure in air without backscatter

O. Reg. 511/85, s. 3, part.

TABLE 7

ITEM	COLUMN 1	COLUMN 2	COLUMN 3
	Projection	Peak Kilovoltage	Maximum entrance exposure expressed in milliroentgens
1.	Posterior Bitewings	50	550
		60	475
		70	360
		80	280
		90	220

O. Reg. 511/85, s. 3, part.

TABLE 8

ITEM	COLUMN 1	COLUMN 2
	Measured Potential (kilovolts peak)	Minimum Half-value Layer (millimetres of aluminum)
1.	30	0.3
2.	40	0.4
3.	49	0.5
4.	50	1.2
5.	60	1.3
6.	70	1.5
7.	71	2.1

TABLE 8—Continued

ITEM	COLUMN 1	COLUMN 2
	Measured Potential (kilovolts peak)	Minimum Half-value Layer (millimetres of aluminum)
8.	80	2.3
9.	90	2.5
10.	100	2.7
11.	110	3.0
12.	120	3.2
13.	130	3.5
14.	140	3.8
15.	150	4.1

O. Reg. 511/85, s. 3, *part.*

Health Care Accessibility Act
Loi sur l'accessibilité aux services de santé

REGULATION 544

ADMINISTRATIVE CHARGE

1. The administrative charge for the purpose of subsection 4 (2) of the Act is \$50. O. Reg. 703/86, s. 1.

Health Disciplines Act *Loi sur les sciences de la santé*

REGULATION 545

CHILD RESISTANT PACKAGES

1. In this Regulation, "child resistant package" means a container or a package that meets the standards for child resistant packages approved by the Minister. R.R.O. 1980, Reg. 445, s. 1.
2. The Canadian Standards Association is designated as an organization to test, certify and designate containers that meet standards for child resistant packages. R.R.O. 1980, Reg. 445, s. 2.
3. Every person who fills a prescription shall dispense the drug in a child resistant package that is certified and designated by the Canadian Standards Association. R.R.O. 1980, Reg. 445, s. 3.
4. Section 3 does not apply where,
 - (a) the prescriber or the person who presents the prescription to be filled directs otherwise;
 - (b) in the professional judgement of the pharmaceutical chemist in the particular circumstances or the particular situation it is advisable not to use a child resistant package;
 - (c) a child resistant package is not suitable because of the physical form of the drug; or
 - (d) the person who fills the prescription is unable to obtain a child resistant package because supplies of such packages are unavailable on the market. R.R.O. 1980, Reg. 445, s. 4.

REGULATION 546

DENTAL HYGIENISTS

1. The ancillary body known as "dental hygienists" is continued consisting of those persons who are registered under this Regulation as dental hygienists. R.R.O. 1980, Reg. 446, s. 1.
2. No person shall act as a dental hygienist unless he or she is registered under this Regulation. R.R.O. 1980, Reg. 446, s. 2.
- 3.—(1) There shall be a register of dental hygienists containing the names of persons who are entitled to registration under this Regulation.
 - (2) The register shall be maintained by the Registrar. R.R.O. 1980, Reg. 446, s. 3.
4. An application for registration as a dental hygienist shall be in Form 1. R.R.O. 1980, Reg. 446, s. 4.
5. The Registrar shall register an applicant who,
 - (a) completes an application for registration in Form 1;
 - (b) holds the standing required for admission to an Ontario University or College of Applied Arts and Technology offering a course in dental hygiene;
 - (c) has completed the course of study referred to in section 6;

- (d) has passed the examinations referred to in section 7; and
- (e) pays an initial registration fee of \$25. R.R.O. 1980, Reg. 446, s. 5.
6. The course of study for dental hygienists shall consist of a course in dental hygiene conducted by the Faculty of Dentistry of an Ontario University, a course in dental hygiene conducted by an Ontario College of Applied Arts and Technology, or such other course or courses in dental hygiene as may be approved by the Council as being equivalent. R.R.O. 1980, Reg. 446, s. 6.
- 7.—(1) The Council may conduct examinations for candidates seeking registration as dental hygienists.
 - (2) The Registrar shall conduct or cause to be conducted the examinations referred to in subsection (1).
 - (3) The Council may accept the examinations given at the conclusion of a course of study referred to in section 6 as the registration examinations for dental hygienists. R.R.O. 1980, Reg. 446, s. 7.
8. The annual fee for a dental hygienist is \$163 and is due and payable on or before the 1st day of January in each year for the year. O. Reg. 587/90, s. 1.
- 9.—(1) The Registrar shall issue to every person whose name appears on the register,
 - (a) a certificate of registration as a dental hygienist in Form 2; and
 - (b) an annual licence certificate in Form 3. R.R.O. 1980, Reg. 446, s. 9 (1), *revised*.
- (2) The certificate referred to in clause (1) (a) shall be signed by the president of the Council and the Registrar and the licence referred to in clause (1) (b) shall be signed by the Registrar.
- (3) Every dental hygienist employed by a member of the College shall display his or her certificate of registration and licence certificate in a conspicuous place in the office of the member. R.R.O. 1980, Reg. 446, s. 9 (2, 3).
10. All fees are payable to the treasurer of the College. R.R.O. 1980, Reg. 446, s. 10.
- 11.—(1) Where the name of a dental hygienist has been removed from the register for the non-payment of the annual fee and the dental hygienist pays a registration fee of \$15, the Registrar shall reregister the dental hygienist and thereupon issue a certificate of registration and an annual licence certificate. R.R.O. 1980, Reg. 446, s. 11 (1), *revised*.
 - (2) On or before the first day of December in each year, the Registrar shall notify each dental hygienist that the annual fee is due at the end of the year.
 - (3) The notice shall be sent by prepaid post addressed to the dental hygienist at the address appearing on the register. R.R.O. 1980, Reg. 446, s. 11 (2, 3).
- 12.—(1) Except as provided by subsection 9 (3) and except to a member of the College, a dental hygienist shall not represent that he or she is engaged or about to become engaged in the practice of dental hygiene,

- (a) by exhibiting, displaying or permitting to be displayed any sign or notice; or
- (b) by otherwise advertising. R.R.O. 1980, Reg. 446, s. 12 (1), *revised*.

(2) Despite subsection (1), any dental hygienist registered as such under this Regulation is entitled to use the designation Diploma Dental Hygiene, (Dip. Dent. Hygiene). R.R.O. 1980, Reg. 446, s. 12 (2).

13.—(1) When so directed by the Council, the Discipline Committee shall hold a hearing to determine whether or not a dental hygienist has been guilty of any matter set forth in clause (2) (a) or (b) and shall report its findings to the Council. R.R.O. 1980, Reg. 446, s. 13 (1).

(2) The Council may revoke or suspend the annual licence and the certificate of registration of a dental hygienist and remove his or her name from the register where the Council, after a hearing by the Discipline Committee, finds that the dental hygienist,

- (a) has been guilty of,
 - (i) incompetence,
 - (ii) improper or dishonourable conduct in respect of the dental practice of his or her employer, or
 - (iii) failure to comply with the Act or this Regulation; or
- (b) has been convicted of a crime that affects his or her fitness to practise. R.R.O. 1980, Reg. 446, s. 13 (2), *revised*.

Form 1

Health Disciplines Act

APPLICATION FOR REGISTRATION AS A DENTAL HYGIENIST

I apply for registration as a dental hygienist. I have passed the examinations prescribed for admission to registration as a dental hygienist in Ontario. I enclose \$25 registration fee, payable to the treasurer of The Royal College of Dental Surgeons of Ontario, and submit the following information:

1. Name in full
2. Permanent address
3. Temporary address
4. Date and place of birth
5. Citizenship
6. Preliminary education
7. Secondary school education:
 - i. Name of school attended
 - ii. Location
 - iii. Time in attendance
 - iv. Graduation diploma or certificate obtained
.....
8. Education as a dental hygienist:
 - i. Name of school attended

- ii. Location
- iii. Time in attendance
- iv. Date of completion of course
- v. Graduation diploma or certificate obtained
.....

9. References:

- i.
- ii.

(signature of applicant)

Dated at, this day of, 19.....

R.R.O. 1980, Reg. 446, Form 1.

Form 2

Health Disciplines Act

CERTIFICATE OF REGISTRATION AS A DENTAL HYGIENIST

This certifies that
(name of person)

of
(address)

is registered as a dental hygienist.

Date

.....
(signature of President)

.....
(signature of Registrar)

R.R.O. 1980, Reg. 446, Form 2.

Form 3

Health Disciplines Act

ANNUAL LICENCE CERTIFICATE AS A DENTAL HYGIENIST

This is to certify that
(name of person)

of
(address of person)

a registered dental hygienist, is licensed to practise as a dental hygienist for the year 19.....

This licence expires on the day of, 19.....

(signature of Registrar)

R.R.O. 1980, Reg. 446, Form 3.

REGULATION 547

DENTISTRY

1. For the purpose of the election of members to the Council, the following electoral districts are established:

1. Number 1, composed of the counties of Dundas, Frontenac, Glengarry, Grenville, Lanark, Leeds, Lennox and Addington, Prescott, Renfrew, Russell and Stormont and The Regional Municipality of Ottawa-Carleton.
2. Number 2, composed of the counties of Haliburton, Hastings, Northumberland, Peterborough, Prince Edward and Victoria and The Regional Municipality of Durham.
3. Number 3, composed of the territorial districts of Algoma, Cochrane, Kenora, Manitoulin, Nipissing, Rainy River, Sudbury, Thunder Bay and Timiskaming.
4. Number 4, composed of The Municipality of Metropolitan Toronto and The Regional Municipality of York.
5. Number 5, composed of the counties of Bruce, Dufferin, Grey, Huron and Simcoe and the territorial districts of Muskoka and Parry Sound.
6. Number 6, composed of the counties of Elgin, Essex, Kent, Lambton and Middlesex.
7. Number 7, composed of the counties of Brant, Oxford, Perth and Wellington and the regional municipalities of Haldimand-Norfolk and Waterloo.
8. Number 8, composed of the regional municipalities of Halton, Hamilton-Wentworth, Niagara and Peel. R.R.O. 1980, Reg. 447, s. 1.

2.—(1) Except from electoral district Number 4, one member shall be elected to the Council from each electoral district.

(2) Two members shall be elected to the Council from electoral district Number 4. R.R.O. 1980, Reg. 447, s. 2.

3.—(1) A member is eligible for election to the Council who,

- (a) is the holder of a General licence;
- (b) is,
 - (i) principally engaged in the practice of dentistry, or
 - (ii) where the member is not engaged in the private practice of dentistry, principally resident,

in the electoral district for which he or she is nominated, and so appears on the registers of the College on the 30th day of September in a year in which an election of members to the Council is to be held;

- (c) has no financial interest, directly or indirectly, in a business or undertaking that provides dental supplies or dental services of any kind to persons engaged in the practice of dentistry; and
- (d) is in good standing in the College. R.R.O. 1980, Reg. 447, s. 3 (1); O. Reg. 504/81, s. 1 (1).

(2) A member is in good standing in the College for the purpose of subsection (1) where,

- (a) he or she is not in default of payment of any fees prescribed by the regulations;

(b) his or her professional conduct is not the subject of disciplinary proceedings;

(c) his or her licence is not under suspension; and

(d) his or her licence is not subject to a term, condition or limitation other than one prescribed by the regulations. R.R.O. 1980, Reg. 447, s. 3 (2).

4.—(1) There shall be an election of members to the Council on the second Wednesday of December of every even numbered year. R.R.O. 1980, Reg. 447, s. 4 (1), *revised*.

(2) The term of office of an elected member of the Council is two years commencing with the first meeting of the Council immediately following an election. R.R.O. 1980, Reg. 447, s. 4 (2).

5. The Registrar shall, on or before the 30th day of October in every year in which an election of members to the Council is to be held, mail to every member appearing on the registers of the College on the 30th day of September and who is qualified to vote a notice of the time and place of the election together with a list of eligible members for election from the electoral district in which the member is qualified to vote. R.R.O. 1980, Reg. 447, s. 5.

6.—(1) The nomination of candidates for election as members of the Council shall be,

- (a) in writing;
- (b) in the nomination form that shall be provided by the Registrar;
- (c) signed by at least five members each of whom shall be a member appearing on the registers of the College on the 30th day of September in a year in which an election of members to the Council is to be held, and each of whom is,
 - (i) principally engaged in the practice of dentistry, or
 - (ii) where not engaged in the private practice of dentistry, principally resident,

in the electoral district from which the nominated member is eligible for election; and

(d) delivered to or received by the Registrar on or before the 10th day of November in the election year. R.R.O. 1980, Reg. 447, s. 6 (1); O. Reg. 504/81, s. 2.

(2) A nomination form shall have the candidate's consent signed thereon. R.R.O. 1980, Reg. 447, s. 6 (2).

7.—(1) The Registrar shall, on or before the 14th day of November in the year in which an election takes place, notify all nominated candidates and a candidate may withdraw his or her candidacy by notice of withdrawal delivered to or received by the Registrar not later than the 20th day of November.

(2) Where only two candidates for election to Council are nominated in electoral district Number 4 or where only one candidate for election to Council is nominated in any other electoral district, the candidates or candidate, as the case requires, shall be declared elected by acclamation. R.R.O. 1980, Reg. 447, s. 7.

8. Except in electoral districts in which candidates have been declared elected by acclamation, the Registrar shall, at least ten days before the date of an election, mail to every member qualified to vote in the election of members to the Council, a list of the candidates in the electoral district where the member is qualified to vote, a ballot and return envelope. R.R.O. 1980, Reg. 447, s. 8.

9.—(1) A member who is qualified to vote in an election of members to the Council shall vote only in the electoral district where the member is,

- (a) principally engaged in the practice of dentistry; or
- (b) where the member is not engaged in the private practice of dentistry, principally resident,

and so appears on the registers of the College on the 30th day of September in a year in which an election of members to the Council is to be held. R.R.O. 1980, Reg. 447, s. 9 (1); O. Reg. 504/81, s. 3.

(2) A member who is eligible to vote in electoral district Number 4 is entitled to vote for two candidates as members to Council from that electoral district.

(3) A member who is eligible to vote in any other electoral district is entitled to vote for one candidate as a member to Council in such other electoral district. R.R.O. 1980, Reg. 447, s. 9 (2, 3).

10. The counting of ballots for the election of members to the Council shall be carried out under the direction of the Registrar on the second Wednesday in December in every election year. R.R.O. 1980, Reg. 447, s. 10.

11. Each ballot shall be in the form that shall be provided by the Registrar, shall be duly marked by the voting member and shall be returned in the envelope that shall be provided by the Registrar with the validation slip that shall be provided by the Registrar attached thereto duly completed. R.R.O. 1980, Reg. 447, s. 11.

12. Before each election of members to Council, the Registrar shall appoint two returning officers. R.R.O. 1980, Reg. 447, s. 12.

13. The persons entitled to be present at the counting of the ballots are the President, the Treasurer, the Secretary, the Registrar, the returning officers and each candidate or a representative appointed in writing of each candidate. R.R.O. 1980, Reg. 447, s. 13.

14. An election shall be under the supervision and direction of the Registrar who shall decide upon the eligibility of any member to vote and shall also decide any dispute that may arise between the returning officers. R.R.O. 1980, Reg. 447, s. 14.

15.—(1) At the time and place fixed for the counting of the ballots, the Registrar shall deliver to the returning officers unopened, all envelopes containing ballots with the validation slips attached thereto.

(2) The Registrar and the returning officers shall check the names on all validation slips with the list of qualified members and, if correct, a returning officer shall remove the validation slips from the envelopes and place the envelopes in the ballot box.

(3) A returning officer shall then proceed to open and count the ballots properly marked for each candidate in each electoral district in which an election is being held. R.R.O. 1980, Reg. 447, s. 15.

16. Where, in the election of a candidate to the Council, a tie vote exists, the returning officers together with the Registrar shall by lot decide which candidate shall be declared elected. R.R.O. 1980, Reg. 447, s. 16.

17.—(1) The returning officers shall make a certified return in duplicate of the total number of votes cast in each electoral district after the votes have been counted and the return shall show the number of votes cast for each candidate in each electoral district and the number of ballots rejected and shall state the reason for each rejection.

(2) One of the duplicate returns shall be handed to the Registrar and the other shall be sealed with the ballots as hereafter required. R.R.O. 1980, Reg. 447, s. 17.

18.—(1) The returning officers after the counting of the ballots has been completed, shall separately seal all the ballots cast in each electoral district in an envelope, distinguishing those that were

rejected and shall otherwise identify on the outside the number of the electoral district to which the ballots relate.

(2) The returning officers shall then place the envelopes in a large envelope together with one copy of the certified return, and shall securely seal the envelope and deliver it to the Registrar who shall deliver it to the newly elected Council at its first meeting. R.R.O. 1980, Reg. 447, s. 18.

19. On receiving the certified return from the returning officers, the Registrar shall forthwith, by registered mail, notify all candidates of the results of the election. R.R.O. 1980, Reg. 447, s. 19.

20. A candidate who wishes to challenge any aspect of the election shall, within one month after the election, lodge his or her complaint with the Registrar who shall refer the matter to the Council and the matter shall be determined at the first meeting of the Council thereafter and the determination of the Council is final and conclusive. R.R.O. 1980, Reg. 447, s. 20.

21. Where the Registrar does not act in any capacity in which his or her services are required in respect of an election, the President shall appoint another person to act in place of the Registrar and the person shall have all the authority of and shall discharge all the duties of the Registrar with respect to the election of members to the Council. R.R.O. 1980, Reg. 447, s. 21.

22.—(1) When an election of members to the Council is not held within the prescribed period, the members of the Council then in office shall continue in office until their successors are elected or appointed.

(2) Where there is an interruption of mail service during an election, the Council shall extend the holding of the election for such minimum period of time as the Council considers necessary to compensate for the interruption. R.R.O. 1980, Reg. 447, s. 22.

23. After an election of members to the Council, the Registrar shall forthwith call the first meeting of the newly elected Council and the retiring members of the Council shall continue to hold office until the first meeting of the newly elected Council. R.R.O. 1980, Reg. 447, s. 23.

24.—(1) An elected member of the Council is disqualified from sitting on the Council and the seat of the member on the Council shall be deemed to be vacant if the member,

- (a) is found to be an incapacitated member;
- (b) is found guilty of professional misconduct or incompetence;
- (c) fails to attend three consecutive regular meetings of the Council;
- (d) ceases to meet the requirements of section 3 for election to the Council; or
- (e) acquires a direct or indirect financial interest in a business or undertaking that provides dental supplies or dental services of any kind to persons engaged in the practice of dentistry. R.R.O. 1980, Reg. 447, s. 24 (1), *revised*.

(2) Where an elected member of the Council dies or resigns or the member's seat otherwise becomes vacant before the expiry of his or her term of office, the Council shall,

- (a) where the unexpired term of the member whose seat became vacant does not exceed six months, appoint a successor from among the members of the College in the electoral district represented by the member whose seat on the Council became vacant; or
- (b) where the unexpired term of office of the member whose seat became vacant exceeds six months, direct the Registrar to hold a by-election in accordance with the provisions of

this Regulation for the electoral district which the member represented,

and the appointed or elected successor shall serve until the expiry of the term of office of the member whose seat became vacant.

(3) A by-election to fill a vacancy on council shall be held on the first Wednesday following sixty calendar days from the declaration of the vacancy, with nominations therefor to be received by the Registrar on or before the twenty-first day preceding the date of such election. R.R.O. 1980, Reg. 447, s. 24 (2, 3).

25.—(1) The following classes of licences are prescribed:

1. General.
2. Academic.
3. Education.

(2) A General licence shall be in Form 1.

(3) An Academic licence shall be in Form 2.

(4) An Education licence shall be in Form 3. R.R.O. 1980, Reg. 447, s. 25.

26. The requirements and qualifications for the issuing or reissuing of a General licence to an applicant are,

(a) after obtaining the applicable qualifications required under clause (b), completion of an application for a General licence on a form that shall be supplied by the Registrar, and, except in the case of an applicant who is the holder of an Academic licence, compliance with the following as may be applicable,

- (i) with respect to an application for a General licence by an applicant holding the qualifications required under subclause (b) (i), the application shall be made within three years after obtaining such qualifications, or
- (ii) with respect to an application for a General licence by an applicant holding the qualifications required under subclause (b) (ii) the applicant shall, with the application, submit satisfactory evidence that the applicant obtained his or her original licence in the foreign jurisdiction within a period of three years following graduation in dentistry in such foreign jurisdiction and that after first obtaining such original licence, no period of three years or more has elapsed during which the applicant has not engaged on a regular and continuous basis in the practice of dentistry in such foreign jurisdiction;

(b) one of the following,

- (i) a degree in dentistry from a university in Ontario,
- (ii) graduation in dentistry from a school, college or university outside Ontario listed by the World Health Organization that is equivalent to graduation with a degree in dentistry from a university in Ontario and a current or past unrestricted licence to engage in the practice of dentistry in the jurisdiction in which the school, college or university is located, with the professional conduct of the applicant not the subject of disciplinary proceedings in such jurisdiction,
- (iii) the holding of an Academic licence for a period of five consecutive years and clinical experience composed of the period of five years immediately before the application for a General licence;

(c) reasonable fluency in the English or French language;

(d) with respect to an original application, that the applicant is a holder of a certificate of the National Dental Examining Board of Canada that evidences that the applicant has successfully completed,

- (i) the examination of the Board, or
- (ii) a program of studies leading to a degree in dentistry at a dental faculty of a university in Canada;

(e) with respect to an original application, that the applicant has successfully completed such examinations as have been set or approved by the Council, if any, at the time of the application;

(f) payment of the examination and licence fees prescribed by this Regulation;

(g) evidence that the applicant is not subject to an outstanding penalty respecting a finding of professional misconduct and there are no current proceedings against the applicant for professional misconduct; and

(h) Canadian citizenship or an immigrant visa or employment visa under the *Immigration Act* (Canada). R.R.O. 1980, Reg. 447, s. 26; O. Reg. 379/86, s. 1.

27. It is a condition of every General licence that where the holder of the licence has not engaged on a regular basis in the practice of dentistry for a continuous period of three years, the holder shall not engage in the practice of dentistry until the Registration Committee has reviewed his or her qualifications. R.R.O. 1980, Reg. 447, s. 27.

28. The requirements and qualifications for the issuing of an Academic licence to an applicant are,

(a) completion of an application for an Academic licence in a form that shall be supplied by the Registrar;

(b) graduation in dentistry from a school, college or university outside Ontario listed with the World Health Organization that is equivalent to graduation with a degree in dentistry from a university in Ontario and a current unrestricted licence to engage in the practice of dentistry in the jurisdiction in which the school, college or university is located with the professional conduct of the applicant not the subject of any past or current disciplinary proceedings in such jurisdiction;

(c) reasonable fluency in the English or French language;

(d) a full-time appointment of professorial rank to the faculty of dentistry of a university in Ontario;

(e) payment of the licence fee prescribed by this Regulation; and

(f) Canadian citizenship or an immigrant visa or employment visa under the *Immigration Act* (Canada). R.R.O. 1980, Reg. 447, s. 28.

29. It is a condition of every Academic licence that the licensee complies with clause 28 (d). R.R.O. 1980, Reg. 447, s. 29.

30. The requirements and qualifications for the issuing of an Education licence to an applicant are,

(a) completion of an application for an Interim licence in a form that shall be supplied by the Registrar;

(b) one of the following:

- (i) graduation in dentistry from a school, college or university in Australia, Denmark, Eire, New Zealand, Norway, South Africa, Sweden, the United Kingdom or the United States of America approved by the governing dental body in the jurisdiction in which the school, college or university is located,
 - (ii) a licence for the practice of dentistry in a province of Canada other than Ontario,
 - (iii) successful completion of Parts I and II of the examinations of the National Dental Examining Board of Canada,
 - (iv) enrolment in a graduate program in oral pathology or oral and maxillofacial surgery at a faculty of dentistry in Ontario;
- (c) a written agreement of hospital internship or residency approved by the College; and
- (d) payment of the fee prescribed by this Regulation. R.R.O. 1980, Reg. 447, s. 30; O. Reg. 720/83, s. 1.

31. It is a condition of every Education licence that,

- (a) the holder of the licence shall not engage in the practice of dentistry except in the hospital where he or she is an intern or a resident and except under the supervision of a person designated by the head of the dental staff or medical staff or by the governing body or authority of the hospital;
- (b) the holder of the licence shall not charge or receive fees for the performance of acts within the practice of dentistry. R.R.O. 1980, Reg. 447, s. 31.

32.—(1) Subject to subsection (2), where a member's name is entered in a register, the name in the register shall be the same as the name of the member in the documentary evidence of his or her degree in dentistry or equivalent qualification.

(2) An applicant for a licence or a member may request entry in a register in a name other than the name required by subsection (1), and the Registrar may cause such other name to be entered in a register if the applicant or member, as the case may be, presents to the Registrar,

- (a) a certified copy of an order of a court of competent jurisdiction in Ontario changing the applicant's or member's name;
- (b) a certified copy of a valid certificate of marriage or a decree absolute of divorce, obtained in any province of Canada; or
- (c) such further or other documentary material that, in the opinion of the Registrar, sufficiently identifies the person named in the documentary evidence of his or her degree in dentistry or equivalent qualification as the applicant or member, and that satisfies the Registrar that the use of the other name is not for any improper purpose. R.R.O. 1980, Reg. 447, s. 32.

33.—(1) The Registrar shall mail to each member a notice and a fees payment form at least thirty days before the due date for payment of annual fees.

(2) The Registrar shall issue a receipt to a member upon receipt of the member's completed annual fees payment form and annual fee. R.R.O. 1980, Reg. 447, s. 33.

34. A person whose licence has been cancelled by the Registrar for non-payment of the annual fee may make application to have his or her licence reissued by the Registrar upon payment of all outstanding fees together with a penalty fee of \$200. O. Reg. 579/89, s. 1.

35. The class of specialists set out in Column 1 of the following Table opposite the name of a branch of dentistry set out in Column 2 of the Table is the class of specialists in that branch of dentistry:

TABLE

ITEM	COLUMN 1	COLUMN 2
	Class of Specialists	Branch of Dentistry
1.	oral and maxillofacial surgeons	oral and maxillofacial surgery
2.	orthodontists	orthodontics
3.	paedodontists	paedodontics
4.	periodontists	periodontics
5.	public health dentists	dental public health
6.	endodontists	endodontics
7.	oral pathologists	oral pathology
8.	oral radiologists	oral radiology
9.	prosthodontists	prosthodontics

R.R.O. 1980, Reg. 447, s. 35; O. Reg. 194/81, s. 1.

36.—(1) The qualifications for specialists in a branch of dentistry are,

- (a) completion of an application for a specialist certificate in the branch of dentistry in a form that shall be supplied by the Registrar;
- (b) completion of at least twelve consecutive months experience in the general practice of dentistry before the commencement of specialist training in the branch of dentistry;
- (c) successful completion of the examinations set or approved by the Council at the time of the application;
- (d) good standing in the College;
- (e) in the case of,
 - (i) oral and maxillofacial surgery, successful completion of thirty-six consecutive months of full-time instruction in an oral and maxillofacial surgery program, approved by the College,
 - (ii) orthodontics, successful completion of a diploma or degree program in orthodontics consisting of a minimum of twenty-two consecutive months of full-time instruction,
 - (iii) paedodontics, successful completion of a diploma or degree program in paedodontics consisting of a minimum of twenty-two consecutive months of full-time instruction,
 - (iv) periodontics, successful completion of a diploma or degree program in periodontics consisting of a minimum of twenty-two consecutive months of full-time instruction,
 - (v) dental public health, successful completion of a diploma or degree program in public health consisting of a minimum of eight consecutive months of instruction by a school of public health followed by completion of two years public health experience acceptable to the Registration Committee of The Royal College of Dental Surgeons of Ontario,

- (vi) endodontics, successful completion of a diploma or degree program in endodontics consisting of a minimum of twenty-two consecutive months of full-time instruction,
- (vii) oral pathology, successful completion of a diploma or degree program in oral pathology consisting of a minimum of twenty-two consecutive months of full-time instruction and successful completion of,
- (A) the Fellowship examination in oral pathology of the Royal College of Dentists of Canada,
- (B) the Diplomate examination of the American Board of Oral Pathology, or
- (C) the examination leading to membership in the College of Pathologists of the United Kingdom,
- (viii) oral radiology, successful completion of a diploma or degree program in oral radiology, consisting of a minimum of twenty-two consecutive months of full-time instruction,
- (ix) prosthodontics, successful completion of a diploma or degree program in prosthodontics consisting of a minimum of twenty-two consecutive months of full-time instruction;
- (f) payment of the examination fee prescribed by this Regulation; and
- (g) payment of the fee prescribed by this Regulation for the issuance of the specialist certificate by the Registrar. R.R.O. 1980, Reg. 447, s. 36 (1); O. Reg. 194/81, s. 2; O. Reg. 504/81, s. 4.
- (2) A member is in good standing in the College for the purpose of subsection (1) where,
- (a) he or she is not in default of payment of any fees prescribed by the regulations;
- (b) his or her professional conduct is not the subject of disciplinary proceedings;
- (c) his or her licence has not been suspended; and
- (d) his or her licence is not subject to a term, condition or limitation other than one prescribed by the regulations.
- (3) An applicant who is the holder of a Fellowship in the Royal College of Dentists of Canada in any branch of dentistry referred to in subclause (1) (e) (i), (ii), (iii), (iv), (v), (vi), (vii) and (ix), is exempt from the qualifications referred to in those subclauses and from the requirements of clauses (1) (b) and (f). R.R.O. 1980, Reg. 447, s. 36 (2, 3).
- 37.—(1) For the purposes of Part II of the Act, “professional misconduct” means:
1. the contravention of any provision of Part II of the Act or of the regulations or of the *Health Insurance Act*;
 2. failure by a member to abide by the terms, conditions or limitations of his or her licence;
 3. engaging or holding oneself out as engaging in the practice of dentistry using any name other than the name of the member that is permitted to be entered in a register under subsection 32 (1);
 4. failure to maintain the standards of practice of the profession;
 5. charging fees that are excessive or unreasonable in relation to the services performed;
 6. charging fees for services not performed;
 7. failure to fulfil the terms of an agreement with a patient respecting professional charges;
 8. failure to itemize accounts in cases where a commercial laboratory fee is involved;
 9. failure to itemize an account at the request of a patient or of an agency making payments for professional services;
 10. directly or indirectly receiving, making or conferring a rebate, credit or other benefit by reason of the referral of a patient from or to any other person;
 11. directly or indirectly receiving, making or conferring a rebate, credit or other benefit in respect of drugs, dental appliances, dental material or dental equipment, including those intended to be dispensed to patients;
 12. the entering into any agreement, including a lease of premises pursuant to which the amount payable by or to a member directly or indirectly is related to the amount of fees charged by the member or by a person licensed or registered under any Act regulating a health discipline;
 13. the selling or supplying of a drug, medical product or biological preparation by a member to a patient at a profit, except where the drug is necessary,
 - i. for the immediate treatment of the patient,
 - ii. in an emergency, or
 - iii. where the services of a pharmacist are not reasonably readily available;
 14. failure to maintain the records that are required by this Regulation to be kept in respect of a member’s patients or practice;
 15. falsifying a record regarding the examination or treatment of a patient;
 16. knowingly submitting a false or misleading account or false or misleading charges for services rendered to a patient;
 17. selling a professional account to a third party;
 18. performing a dental procedure, for fee or otherwise, in any public place or in any vehicle or other moveable contrivance, without the approval of the Council or of the Minister;
 19. using in any way with respect to a member’s practice, the name of another member whose practice the member has acquired after a period of one year from the date of the acquisition;
 20. announcing or holding out to the public that the member is a specialist or is specially qualified in a branch of dentistry or that the member limits his or her practice to any branch of dentistry where the member is not qualified as a specialist and does not hold a specialist certificate in the branch of dentistry;
 21. engage in the practice of dentistry under employment by or in partnership with any person or corporation other than,
 - i. with a member who is engaged in the practice of dentistry,

- ii. as an employee or agent of a municipal or other government, agency of a municipal or other government, a university or hospital;
- 22. using terms, titles or designations other than those authorized, or using terms, titles or designations that are prohibited by this Regulation;
- 23. signing or issuing a certificate, report or similar document that contains a statement that a member knows or ought to know is false, misleading or otherwise improper;
- 24. conviction of an offence that affects the fitness of a member to engage in the practice of dentistry;
- 25. improper use of the authority to prescribe, sell or dispense a drug, or falsifying a record in respect of a prescription or the sale of a drug;
- 26. engaging in the practice of dentistry while the ability to perform any professional service usually performed by a dentist or dental surgeon is impaired by alcohol or a drug;
- 27. permitting, counselling or assisting any person who is not licensed under Part II of the Act to engage in the practice of dentistry except as provided for in the Act or this Regulation;
- 28. making a misrepresentation respecting a remedy treatment or device;
- 29. refusal to allow an authorized representative of the Council to enter at a reasonable time the office in which the member is engaged in the practice of dentistry for the purpose of an inspection and examination of the office records and equipment of the member in connection with his or her practice;
- 30. giving information concerning a patient's dental condition or any professional services performed for a patient to any person other than the patient without the consent of the patient unless required to do so by law;
- 31. failure to provide within a reasonable time and without cause any report or certificate requested by a patient or his or her authorized agent in respect of an examination or treatment performed by the member;
- 32. failing to continue to provide professional services to a patient until the services are no longer required or until the patient had a reasonable opportunity to arrange for the services of another member;
- 33. using in respect of the practice of dentistry by a member the designation "clinic" or "dental centre" or any other designation indicative of the practice of dentistry by a group except where,
 - i. not less than three members are engaged as a group in the full-time practice of dentistry,
 - ii. none of them is engaged in the practice of dentistry in any other group or in any other private practice, and
 - iii. the Council or the Executive Committee thereof has given its prior written approval to the name of such "clinic" or "dental centre";
- 34. using in respect of the practice of dentistry, the designation "dental emergency service", "dental emergency clinic", or any other designation indicative of the rendering of dental emergency care by a member or group of members, except where it is a service that is,
 - i. operated under the sponsorship of a component society of the Ontario Dental Association, or
 - ii. performed in an office established and maintained exclusively for the purpose of rendering dental emergency care, which office has received prior approval of the Council and which has a member or members present therein for not less than sixteen hours each and every day and an emergency telephone number available for the remaining time;
- 35. accepting a credit card to obtain payment for a dental service,
 - i. that is prescribed as an insured service under Regulation 552 of Revised Regulations of Ontario, 1990, or
 - ii. prior to rendering the dental service;
- 36. accepting a credit card other than one defined in subsection (3) to obtain payment for a dental service;
- 37. sexual impropriety with a patient;
- 38. abusing a patient verbally or physically;
- 39. contravening while engaged in the practice of dentistry any federal, provincial or municipal law, regulation or rule or a by-law of a hospital passed for the purpose of regulating the provision of dental care to the public;
- 40. publishing, displaying, distributing or using or permitting, directly or indirectly, the publishing, display, distribution or use of any advertisement related to the practice of dentistry by a member, or a member associating with or being employed by any person, other than,
 - i. professional cards that contain only the name of the member, a vocational designation, the member's address, academic degrees, telephone number and office hours,
 - ii. an announcement upon commencing practice or changing the geographical location of a member's practice that,
 - A. does not exceed two standard newspaper columns in width and five centimetres in depth including the margins,
 - B. does not contain references to qualifications, procedures or equipment, and
 - C. does not appear more than three times in a newspaper or periodical in respect of the commencement of the practice or of a change in the geographical location of the practice,
 - iii. appointment cards that do not contain more than the information contained in a professional card and the time and date of the appointment or appointments,
 - iv. reminder notices to patients;
 - v. announcement cards that do not state more than the information contained in a professional card and an announcement of the commencement of the practice of the member, a change of location or a new association in practice,
 - vi. not more than two exterior signs stating a member's name and the vocational designation, on the premises where the member practises but,

- A. only one sign may be a suspended sign,
- B. only one sign may be illuminated and shall not be of an intermittent or neon type,
- C. the letters used in a sign shall not exceed ten centimetres in height,
- D. words designating office hours may be added to an entrance sign in unilluminated letters not more than five centimetres in height,
- E. where an entrance is difficult to find, the words "Entrance on" may be added to the sign,
- vii. door plates and listings on building directories on the premises where the member is engaged in the practice of dentistry in letters not exceeding 2.5 centimetres in height,
- viii. a telephone directory listing,
- A. in the white pages that,
1. is of dark or light type,
 2. where a member is a certified specialist, may indicate the specialty designation,
 3. does not list office hours, and
 4. is only an alphabetical listing according to the member's surname, and
- B. in the yellow pages that,
1. is only of light type,
 2. where the member is a certified specialist, may indicate the specialty designation,
 3. does not list office hours, and
 4. is listed only in the telephone listing for the geographical area in which the member is engaged in the practice of dentistry; and
41. conduct or an act relevant to the practice of dentistry that, having regard to all the circumstances, would reasonably be regarded by members as disgraceful, dishonourable or unprofessional. R.R.O. 1980, Reg. 447, s. 37; O. Reg. 245/88, s. 1 (1).
- (2) Subparagraph ii of paragraph 35 of subsection (1) does not apply with respect to payment for a laboratory fee to be incurred by a member in connection with a dental service or services to be rendered.
- (3) For the purposes of subsection (1), "credit card" means a credit card that is accepted by a member pursuant to a standard form of agreement that requires the provider of the credit card to rely solely upon the provider's contract with the credit card holder or credit card sales slip to enforce payment of money owed and not upon a member's patient records. O. Reg. 245/88, s. 1 (2).
38. A member in the practice of dentistry shall exercise generally accepted standards of practice and procedures in the performance of professional services, and shall,
- (a) maintain the office in which and the equipment with which the member engages in the practice of dentistry in a sanitary and hygienic condition;
- (b) make and keep clinical and financial records respecting his or her patients and the record for each patient shall contain not less than,
- (i) the patient's history,
 - (ii) the examination procedures used,
 - (iii) the clinical findings obtained,
 - (iv) the treatment prescribed and provided, and
 - (v) the member's fees and charges;
- (c) keep the records required under clause (b) in a systematic manner and such records shall be retained for a period of at least ten years after the date of the last entry in the record or until two years following the death of the member, whichever first occurs;
- (d) where any person other than a member performs acts in the practice of dentistry on behalf or while employed by the member, ensure that the person performs only the specified acts in the practice of dentistry that are authorized by the regulations and that the specified acts are performed under the supervision of a member;
- (e) where giving directions for the making, producing, reproducing, constructing, furnishing, supplying, altering or repairing of any prosthetic denture, bridge, appliance or similar thing,
- (i) give the direction in writing,
 - (ii) sign the direction, and
 - (iii) where a member would reasonably consider it advisable or the person who is directed by the direction requests it, give a design impression or cast with the direction. R.R.O. 1980, Reg. 447, s. 38.
- 39.—(1) In this section, and in sections 40 to 48,
- "drug" means drug as defined in Part VI of the Act;
- "pharmacist" means pharmacist as defined in Part VI of the Act;
- "prescriber" means prescriber as defined in Part VI of the Act;
- "prescription" means prescription as defined in Part VI of the Act;
- "Schedule G preparation" means a drug that contains one drug referred to in Schedule G and one or more active medicinal ingredients which are not referred to in Schedule G in a recognized therapeutic dose, or a drug that contains as the only medicinal ingredient phenobarbital or any of its salts in an amount not exceeding 32.4 milligrams (1/2 grain) per unit dosage;
- "Schedule N preparation" means a drug that,
- (i) contains one drug referred to in Schedule N and two or more active medicinal ingredients that are not referred to in Schedule N or a recognized therapeutic dose, and
 - (ii) is not intended for parenteral administration;
- "sell" includes offer to sell, dispense, distribute, give away and supply.
- (2) A reference to Schedule A, B, C, D, E, F, G or N is a reference to such Schedule established by the regulations for the purposes of Part VI of the Act. R.R.O. 1980, Reg. 447, s. 39.
- 40.—(1) Where a member decides to treat a patient with a drug,

the member shall give a written prescription to the patient or offer to give a verbal prescription to a pharmacist acceptable to the patient.

(2) A member who has given a written prescription for a drug to a patient may sell the drug to the patient subject to the provisions of this Regulation governing the sale, recording, labelling and packaging of drugs. R.R.O. 1980, Reg. 447, s. 40.

41. A member who sells a drug referred to in Schedule G or N, in an amount,

- (a) that exceeds three times the maximum daily dosage recommended by the manufacturer of the drug for the drug; or
- (b) if the manufacturer has not recommended a maximum daily dosage for the drug, that exceeds three times the generally recognized maximum daily therapeutic dosage for the drug,

shall keep a record showing,

- (c) the date of the sale;
- (d) the name and address of the person for whom the drug was prescribed;
- (e) the name, strength where applicable, and quantity of the drug; and
- (f) the price, if any, charged. R.R.O. 1980, Reg. 447, s. 41.

42. A member shall keep or cause to be kept a record of every purchase or acquisition of a drug referred to in the Schedules to Part VI of the Act by entering or causing to be entered in a register or other record that shall be maintained for that purpose forthwith upon such purchase,

- (a) the date of the purchase;
- (b) the name, strength where applicable, and quantity of the drug;
- (c) the name and address of the person from whom the drug was purchased or received; and
- (d) the purchase price, if any. R.R.O. 1980, Reg. 447, s. 42.

43. Every member who sells a drug shall,

- (a) retain the written prescription for the drug for a period of not less than two years or until he or she ceases to engage in the practice of dentistry, whichever first occurs;
- (b) record on the prescription,
 - (i) the name and address of the person for whom the drug is prescribed,
 - (ii) the name, strength where applicable, and quantity of the prescribed drug,
 - (iii) the identity of the manufacturer of the drug,
 - (iv) the directions for use,
 - (v) an identification number or other designation,
 - (vi) the date on which the drug is dispensed, and
 - (vii) the price charged, if any; and
- (c) mark the container in which the drug is dispensed with,
 - (i) the identification number that is on the record of sale,

- (ii) the name of the drug, if the member considers it advisable,
- (iii) the quantity, where the drug dispensed is in solid oral dosage form,
- (iv) the date the drug is dispensed,
- (v) the name and address of the prescriber,
- (vi) the name of the person for whom it is prescribed, and
- (vii) the prescribed directions for use. R.R.O. 1980, Reg. 447, s. 43.

44. Every container in which any article or substance referred to in Part II of Schedule B is sold by a member shall include on the label, legibly and conspicuously displayed on the outer surface of the container in which the article or substance is contained, a caution or warning to the effect that the article or substance should be kept out of the reach of children, but if the article or substance is an article or substance referred to in the *Hazardous Products Act* (Canada) the provisions of this section do not apply. R.R.O. 1980, Reg. 447, s. 44.

45. Every container in which any article or substance referred to in Part III of Schedule B is sold by a member, shall include on the label, legibly and conspicuously displayed on the outer surface of the container in which the article or substance is contained, a caution or warning to the effect that the article or substance should be used only with adequate ventilation, but if the article or substance is an article or substance referred to in the *Hazardous Products Act* (Canada) the provisions of this section do not apply. R.R.O. 1980, Reg. 447, s. 45.

46.—(1) Every container in which any drug specified in subsection (2) is sold in a form for internal use, shall bear the following words legibly and conspicuously displayed on the outer surface of the container in which the drug is dispensed:

“WARNING: Do not exceed the dose prescribed. If difficulty in breathing persists, contact a physician immediately.”

(2) The following drugs are specified for the purpose of subsection (1):

1. Epinephrine and its salts.
2. Isoproterenol (Isoprenaline) and its salts.
3. Metaproterenol (Orciprenaline) and its salts. R.R.O. 1980, Reg. 447, s. 46.

47. Every member who sells drugs shall maintain a system for filing his or her records of the purchases and sales of the drugs. R.R.O. 1980, Reg. 447, s. 47.

48.—(1) In this section, “child resistant package” means a container or package that meets the standards for child resistant packages approved by the Minister.

(2) A member shall only dispense a drug in a child resistant package except where,

- (a) in the opinion of the member it is advisable not to use a child resistant package;
- (b) a child resistant package is not suitable because of the physical form of the drug; or
- (c) the member is unable to obtain a child resistant package because supplies of such packages are unavailable on the market. R.R.O. 1980, Reg. 447, s. 48.

49. The following specified acts in the practice of dentistry may be performed under the supervision or direction of a member by a preventive dental assistant who has successfully completed the preventive dental assistants' program of a College of Applied Arts and Technology, or other courses approved by the Council, and who provides to the College, his or her name and current address, together with the name and business address of the member by whom he or she is employed:

1. Mechanical polishing of the coronal portion of the teeth and not including any instrumentation.
2. Taking impressions of teeth for study models.
3. Topical application of anti-cariogenic agents.
4. Placement and removal of rubber dams.
5. Maintenance of a patient's oral hygiene. R.R.O. 1980, Reg. 447, s. 49.

50.—(1) Dental hygienists may perform the following specified acts in the practice of dentistry under the supervision or direction of a member:

1. Preliminary examination of the oral cavity and surrounding structures including the taking of a case history, periodontal examination and recording of clinical findings.
2. Complete prophylaxis, including scaling, root planing, subgingival curettage and polishing of fillings.
3. Topical application of anticariogenic agents, and other materials designed to assist in the prevention of caries.
4. Taking impressions for study models.
5. Maintenance of patient's oral hygiene.
6. Placement and removal of rubber dam.
7. Application and removal of periodontal dressings.
8. Removal of sutures.
9. Placement and removal of arch wires previously fitted by a dentist.
10. Separating of teeth prior to banding by a dentist.
11. Cementation and removal of bands or brackets or both for orthodontic purposes that have been previously fitted by a dentist.
12. Application of topical anaesthetics.
13. Topical application of desensitizing agents. O. Reg. 71/81, s. 1, *part*; O. Reg. 11/88, s. 1.

(2) In addition to the acts specified in subsection (1), dental hygienists who have been approved in writing by the College may perform the following acts in the practice of dentistry under the supervision or direction of a member:

1. Placement, finishing and polishing of amalgam, silicate and resin restorations.
2. Placement and removal of matrix bands.
3. Placement of cavity liners in a tooth where the pulp has not been exposed.
4. Gingival retraction for impression taking.

5. Cementation of temporary crowns previously fitted by a dentist.

6. Placing of temporary fillings. O. Reg. 71/81, s. 1, *part*.

51. Every member shall provide the Registrar with the complete address of his or her principal residence as well as the address or addresses of the principal place or places at which the member engages in the practice of dentistry and shall inform the Registrar of any change of address within ten days of the change. R.R.O. 1980, Reg. 447, s. 51.

52.—(1) No member shall engage in the practice of dentistry where there is a conflict of interest.

(2) It is a conflict of interest for a member to have a proprietary interest in a commercial dental laboratory. R.R.O. 1980, Reg. 447, s. 52.

53.—(1) A member, in the practice of dentistry, shall only use the titles "Doctor", "Dentist", or "Dental Surgeon", or accepted abbreviations thereof or the accepted abbreviations of recognized degrees and diplomas held by the member.

(2) A member who holds a specialist certificate may use the name of the class of the specialty in respect of the member's practice. R.R.O. 1980, Reg. 447, s. 53.

54. The decisions of the Discipline Committee shall be published by the College in its annual report and may be published by the College in any other publication of the College, and where a member has been found guilty of professional misconduct or incompetence, the full name and address of the member may be stated and a summary of the charge, the decision and the penalty imposed may be stated and the text or substance of any restriction on the licence of the member or of any reprimand may be added, but where a member has been found not guilty of professional misconduct or incompetence, the identity of the member shall not be published but the substance of the proceedings may be published without identification of the parties for the purpose of publishing advice to the member or to the profession. R.R.O. 1980, Reg. 447, s. 54.

55.—(1) The annual fee for a member is \$1,065.

(2) The annual fee for a member other than a member holding an education licence is for a calendar year and is due and payable,

(a) for a member making an original application for a licence, at the time the application is made; or

(b) in any other case, on or before the 15th day of December of the preceding year.

(3) The annual fee for a member holding an education licence issued on or after the 1st day of January, 1991 is for the twelve months following the first day of the month in which the hospital internship or residency commences under the written agreement referred to in clause 30 (c) and the fee is due and payable on or before that day. O. Reg. 596/90, s. 1.

56. The fee for a licence is \$100. R.R.O. 1980, Reg. 447, s. 56.

57. The examination fee for a general licence is \$1,500. O. Reg. 504/81, s. 5, *part*.

58. The examination fee for a specialist certificate is \$1,500. O. Reg. 504/81, s. 5, *part*.

59. The fee for the issuance of a specialist certificate by the Registrar is \$50. R.R.O. 1980, Reg. 447, s. 59.

60. The penalty for late payment of an annual fee is \$100. O. Reg. 579/89, s. 3.

Form 1

Health Disciplines Act

GENERAL LICENCE

Royal College of Dental Surgeons of Ontario

This is to certify that

.....
(name)

is duly licensed as a member of the College and is entitled to engage in the general practice of dentistry.

In witness whereof, we have hereunto subscribed our names and affixed the seal of the College.

.....
President

.....
Registrar

Number:

Dated at Toronto, Ontario, Canada, this
day of, 19.....

R.R.O. 1980, Reg. 447, Form 1.

Form 2

Health Disciplines Act

ACADEMIC LICENCE

Royal College of Dental Surgeons of Ontario

This is to certify that

.....
(name)

is duly licensed as a member of the College and is entitled to engage in the practice of dentistry subject to the conditions prescribed for Academic licences by the regulations.

In witness whereof, we have hereunto subscribed our names and affixed the seal of the College.

.....
President

.....
Registrar

Number:

Dated at Toronto, Ontario, Canada, this
day of, 19.....

R.R.O. 1980, Reg. 447, Form 2.

Form 3

Health Disciplines Act

EDUCATION LICENCE

Royal College of Dental Surgeons of Ontario

This is to certify that

.....
(name)

is duly licensed as a member of the College and is entitled to engage in the practice of dentistry subject to the conditions prescribed for Education licences by the regulations.

In witness whereof, we have hereunto subscribed our names and affixed the seal of the College.

.....
President

.....
Registrar

Number:

Dated at Toronto, Ontario, Canada, this
day of, 19.....

R.R.O. 1980, Reg. 447, Form 3.

REGULATION 548

MEDICINE

1. For the purpose of the election of members of the Council, the following electoral districts are established:

1. District 1, composed of the counties of Essex, Kent and Lambton.
2. District 2, composed of the counties of Elgin, Huron, Middlesex, Oxford and Perth.
3. District 3, composed of the counties of Bruce, Dufferin, Grey, Wellington and The Regional Municipality of Waterloo.
4. District 4, composed of the County of Brant and the regional municipalities of Haldimand-Norfolk, Halton, Hamilton-Wentworth and Niagara.
5. District 5, composed of the County of Simcoe, the District Municipality of Muskoka and the regional municipalities of Durham, Peel and York.
6. District 6, composed of the counties of Frontenac, Haliburton, Hastings, Leeds and Grenville, Lennox and Addington, Northumberland, Peterborough, Prince Edward and Victoria.
7. District 7, composed of the counties of Dundas, Glengarry, Lanark, Prescott, Renfrew, Russell and Stormont and The Regional Municipality of Ottawa-Carleton.
8. District 8, composed of the territorial districts of Algoma, Cochrane, Manitoulin, Nipissing, Parry Sound, Sudbury and Timiskaming.

9. District 9, composed of the territorial districts of Kenora, Rainy River and Thunder Bay.
10. District 10, composed of The Municipality of Metropolitan Toronto. O. Reg. 192/84, s. 1.
- 2.—(1) Except in electoral district numbers 4, 5, 7 and 10, one member shall be elected to the Council from each electoral district established by section 1.
- (2) Two members shall be elected to the Council from each of electoral district numbers 4, 5 and 7.
- (3) Four members shall be elected to the Council from electoral district number 10. R.R.O. 1980, Reg. 448, s. 2.
- 3.—(1) A member is eligible for election to the Council who,
- is not a full-time member of the faculty of medicine of a university referred to in clause 48 (2) (a) of the Act;
 - is the holder of a General licence;
 - is resident in the electoral district for which he or she is nominated;
 - is nominated by at least fifteen members entitled to vote and residing in the electoral district for which the candidate is nominated; and
 - is in good standing in the College.
- (2) A member is in good standing in the College for the purposes of subsection (1) where,
- he or she is not in default of payment of any fees prescribed by the regulations;
 - his or her professional conduct is not the subject of disciplinary proceedings;
 - his or her licence is not under suspension; and
 - his or her licence is not subject to a term, condition or limitation other than one prescribed by the regulations.
- (3) For the purpose of subsection (1), the residence of a member is his or her last address recorded on a register. R.R.O. 1980, Reg. 448, s. 3.
- 4.—(1) There shall be an election of members to the Council on the fourth Tuesday of October in 1992 and in every fourth year thereafter.
- (2) The term of office of a member of the Council elected at a general election is four years commencing with the first regular meeting of the Council immediately following the election.
- (3) Where there is an interruption of mail service during a nomination or election, the Registrar shall extend the holding of nominations and the election for such minimum period of time as the Registrar considers necessary to compensate for the interruption.
- (4) When an election of members to the Council is not held, the elected members of the Council then in office continue in office until their successors are elected or appointed. R.R.O. 1980, Reg. 448, s. 4.
- 5.—(1) An elected member of the Council is disqualified from sitting on the Council and the seat of the member on the Council shall be deemed to be vacant if the member,
- is found to be an incapacitated member;
 - is found guilty of professional misconduct or incompetence;
 - fails to attend three consecutive regular meetings of the Council without cause; or
 - ceases to reside in the electoral district for which he or she was elected. R.R.O. 1980, Reg. 448, s. 5 (1), *revised*.
- (2) Where an elected member of the Council dies or resigns or the member's seat otherwise becomes vacant before the expiry of his or her term of office, the Council shall,
- where the unexpired term of the member whose seat became vacant does not exceed one year, appoint a successor from among the members of the College who are eligible for election to the Council in the electoral district represented by the member who are members in good standing in the College; or
 - where the unexpired term of office of the member whose seat became vacant exceeds one year, direct the Registrar to hold a by-election in accordance with the provisions of this Regulation for the electoral district represented by the member,
- and the appointed or elected successor shall serve until the expiry of the term of office of the member whose seat became vacant.
- (3) A by-election to fill a vacancy on Council shall be held on the first Tuesday following seventy calendar days from the declaration of the vacancy. R.R.O. 1980, Reg. 448, s. 5 (2, 3).
- 6.—(1) The nomination of candidates for election as members of the Council shall be in writing addressed to the Registrar and shall be delivered to or received by the Registrar not later than 4 p.m. on the Tuesday of the fifth week immediately preceding the date of the election.
- (2) Where only,
- four candidates for election to the Council are nominated for electoral district number 10;
 - two candidates for election to the Council are nominated for each of electoral district numbers 4, 5 or 7; and
 - one candidate for election to the Council is nominated in any other electoral district,
- the candidate or candidates, as the case requires, shall be declared elected by acclamation.
- (3) The Registrar shall, at least twenty-eight days before the last day for receiving nominations, forward to every member entitled to vote a written notice stating,
- that an election will be held for the purpose of electing a Council or a by-election will be held to fill a vacancy on the Council and the date of the election or by-election;
 - the date fixed by this Regulation for receiving nominations for the election or by-election;
 - that to be eligible for election a candidate must be nominated by at least fifteen members entitled to vote and residing in the electoral district in which the election or by-election is to be held; and
 - that nominations shall be submitted in writing to the Registrar and received by the Registrar not later than 4 p.m. on the date fixed for receiving nominations. R.R.O. 1980, Reg. 448, s. 6.
7. Except in electoral districts in which candidates have been declared elected by acclamation, the Registrar shall within twenty-one days after the date fixed for receiving nominations send to every member, entitled to vote and residing in the electoral district in

which there have been received nominations for more candidates than the number to be elected, an envelope containing,

- (a) a voting paper;
- (b) instructions for voting;
- (c) an envelope addressed to the proper Returning Officer to be used by the member in sending the voting paper to the Returning Officer; and
- (d) biographical information in respect of each candidate. R.R.O. 1980, Reg. 448, s. 7.

8.—(1) The Registrar shall appoint a Returning Officer for each electoral district in which an election is to be held who shall be a member of the College residing in the electoral district for which he or she is appointed and qualified to vote in the election.

(2) Where a Returning Officer either refuses to act or is incapacitated, the Registrar shall appoint some other member residing in the electoral district as Returning Officer. R.R.O. 1980, Reg. 448, s. 8.

9.—(1) A Returning Officer shall receive voting papers up to 2 p.m. on the election day and thereafter shall open the envelopes containing the voting papers and shall,

- (a) examine and count the voting papers;
- (b) record the number of votes cast, and the number received by each candidate; and
- (c) subject to subsection (3), declare the name and address of the candidate receiving the largest number of votes who shall then be declared elected by the Registrar as the representative of the electoral district.

(2) Where two or more candidates receive an equal number of votes, the Returning Officer shall cast the deciding vote for one of the candidates.

(3) The Returning Officer in electoral district Number 10 shall declare the name of each candidate, to the number to be elected, who receives the largest number of votes and who shall then be declared elected by the Registrar for the electoral district and where there is a tie vote the Returning Officer shall cast the deciding vote for one of the candidates.

(4) Voting shall be secret and so conducted that no person shall know for whom any member has voted.

(5) A candidate or his or her agent authorized in writing to act on the candidate's behalf is entitled,

- (a) to be present and see the counting of the voting papers;
 - (b) to examine all the voting papers to be satisfied that the voting papers have been properly completed; and
 - (c) to assure that the persons signing voting papers are members qualified to vote in the election in the electoral district.
- (6) A Returning Officer,
- (a) shall not open envelopes bearing the words "Voting Paper" until 2 p.m. on the day of the election;
 - (b) shall reject all voting papers that are not filled in in accordance with the instructions for voting;
 - (c) shall send unopened to the Registrar all envelopes addressed to the Returning Officer and received by the Returning Officer after 2 p.m. on the election day, which

shall be counter signed by the Returning Officer and marked "Late"; and

- (d) shall return to the Registrar all voting papers in respect of the election within six days from the election day. R.R.O. 1980, Reg. 448, s. 9.

10.—(1) The Registrar on receiving a declaration from a Returning Officer that a candidate has been elected shall forthwith inform,

- (a) each member so elected of the time and place of the first regular meeting of the Council following the said election;
- (b) each candidate of the results of the election and the number of votes cast for each candidate in the electoral district; and
- (c) each defeated candidate that he or she may request a recount.

(2) The Registrar shall destroy all voting papers thirty-one days after the announcement of the results of an election unless a candidate challenges the election or its results. R.R.O. 1980, Reg. 448, s. 10.

11.—(1) Upon written request to the Registrar within fourteen days after the date of an election and payment of \$200 a candidate may require a recount and the recount shall be held within thirty days from the date of the request.

(2) The recount shall be presided over by the Registrar who shall,

- (a) set the date for the recount;
- (b) give notice in writing at least fifteen days before the date set for the recount to all candidates in the electoral district for which a recount has been requested that a recount is to be held;
- (c) notify the candidates that they or their agents are entitled to be present to examine all voting papers and to satisfy themselves that all voting papers have been properly filled out and taken into account;
- (d) make the decision to accept or reject a voting paper;
- (e) declare the name and address of the candidate who has received the greatest number of votes and in case of a recount following an election in electoral district Number 10, declare the names of the candidates to the number who are to be elected who received the greatest number of votes; and
- (f) where two or more candidates receive on recount an equal number of votes the Registrar shall cast the deciding vote for one of the candidates. R.R.O. 1980, Reg. 448, s. 11.

12. Where the Council is of the opinion that there is doubt or dispute as to the validity of the election of any member of the Council, the Council shall hold an inquiry and shall decide whether the election of the member is valid and if an election is found by the Council to be invalid the Council shall order a new election. R.R.O. 1980, Reg. 448, s. 12.

13.—(1) The following classes of licences are prescribed:

1. General.
2. Educational.
3. Academic.
4. Hospital Practice.
5. Public Service.

6. Short Duration. R.R.O. 1980, Reg. 448, s. 13 (1); O. Reg. 72/87, s. 1.

(2) Every applicant for a licence who is a graduate of a medical school outside Canada shall submit in person his or her original medical diploma for inspection by the Registrar. R.R.O. 1980, Reg. 448, s. 13 (2).

14.—(1) In this Regulation,

“acceptable residency” means,

- (a) a year of a residency program that is taken in Canada and that at the time of the applicant's commencement thereof,
 - (i) constituted a year of a residency program in family medicine accredited by the College of Family Physicians of Canada,
 - (ii) constituted a year of a residency program accredited by the Royal College of Physicians and Surgeons of Canada, or
- (b) a year of a residency program that is taken in the United States of America and that at the time of the applicant's commencement thereof is,
 - (i) - accredited, and
 - (ii) provided by a hospital that has a major affiliation with a medical school,

according to the Directory of Residency Training Programs Accredited by the Accreditation Council for Graduate Medical Education published by the American Medical Association;

“acceptable unaccredited medical school” means a medical school, other than an accredited medical school, that at the time of an applicant's graduation,

- (a) provides a course in medical studies of at least four years duration,
- (b) has provided the course referred to in clause (a) continuously for a period of at least ten years, and
- (c) is listed in the World Directory of Medical Schools published by the World Health Organization;

“acceptable undergraduate clerkship” means a clerkship of at least forty weeks training that is taken as part of the second half of an undergraduate medical course at an accredited medical school and that includes a minimum of,

- (a) eight weeks of internal medicine,
- (b) four weeks of obstetrics,
- (c) four weeks of paediatrics,
- (d) four weeks of psychiatry, and
- (e) eight weeks of surgery;

“accredited medical school” means a medical school that is at the time of an applicant's graduation accredited by the Liaison Committee on Medical Education or by the Committee on Accreditation of Canadian Medical Schools;

“applicant” means a person who applies for a licence under Part III of the Act and this Regulation;

“approved internship” means a comprehensive internship or a rotating internship that is,

- (a) taken in Canada and that is at the time of the applicant's commencement thereof accredited by the Committee on Accreditation of Preregistration Physician Training Programs, or
- (b) taken in the United States of America and that is at the time of the applicant's commencement thereof provided by a hospital that according to the Directory of Residency Training Programs accredited by the Accreditation Council for Graduate Medical Education published by the American Medical Association has a major affiliation with a medical school;

“comprehensive internship” means a postgraduate program of medical education of one continuous year that includes training in ambulatory care and intensive care and that is comprised of,

- (a) at least twenty-four weeks and not more than thirty-six weeks in family medicine, surgery, internal medicine or paediatrics, and
- (b) at least twelve weeks in at least two of emergency medicine, family medicine, surgery, internal medicine, obstetrics and gynaecology, paediatrics or psychiatry that are different from the subject-matter of the program taken under clause (a);

“medical school” means a school or faculty of medicine but does not include,

- (a) a school, college or faculty of stomatology, homeopathy, osteopathy, or podiatry, or
- (b) the California College of Medicine in respect of a degree or qualifications issued by it before the 1st day of January, 1967;

“pre-internship program” means a program of assessing and upgrading the clinical and language skills of a graduate of an acceptable unaccredited medical school that,

- (a) is taken at an accredited medical school in Ontario,
- (b) is at least thirty-six weeks in duration and does not exceed forty-eight weeks in duration, and
- (c) includes assessment and training in internal medicine, obstetrics and gynaecology, paediatrics, psychiatry and surgery;

“pre-residency program” means a program of assessing and upgrading the clinical and language skills of a graduate of an acceptable unaccredited medical school that,

- (a) is taken at an accredited medical school in Ontario,
- (b) is at least four weeks in duration and does not exceed twelve weeks in duration, and
- (c) includes assessment and training in the specialty area in which the applicant is seeking postgraduate medical education;

“residency” means a postgraduate program of medical education of one continuous year in one of family medicine, surgery, internal medicine, obstetrics and gynaecology or paediatrics;

“rotating internship” means a postgraduate program of medical education of one continuous year that is comprised of at least six weeks in each of surgery, internal medicine, obstetrics and gynaecology, paediatrics and psychiatry and that includes training in ambulatory care and intensive care. O. Reg. 344/85, s. 1, *part*; O. Reg. 72/87, s. 2 (1-3).

- (2) For the purposes of this Regulation, an applicant who suc-

successfully completes the qualifying examination of the Medical Council of Canada shall be deemed to have completed the evaluating examination of the Medical Council of Canada. O. Reg. 72/87, s. 2 (4).

15.—(1) The requirements for the issuing of a licence of any class to an applicant are that the applicant,

- (a) completes an application for the class of licence for which application is made in a form provided by the Registrar;
- (b) for a licence other than an Educational licence or a Short Duration licence, is a Canadian citizen or has permanent resident status under the *Immigration Act* (Canada);
- (c) for an Educational licence,
 - (i) is a Canadian citizen or has permanent resident status under the *Immigration Act* (Canada), or
 - (ii) has a special authorization under clause 10 (b) of the *Immigration Act* (Canada) to take a professional postgraduate medical training course at a specified university in Ontario;
- (d) for a Short Duration licence,
 - (i) is a Canadian citizen or has permanent resident status under the *Immigration Act* (Canada), or
 - (ii) has a special authorization under clause 10 (c) of the *Immigration Act* (Canada) to engage in employment in the practice of medicine in Ontario;
- (e) where the applicant's native language is not English or French or where the applicant's medical education was not conducted in English or French, has successfully completed the Test of English as a Foreign Language (TOEFL) with a minimum score of 580 and the Test of Spoken English (TSE) with a minimum score of 200 or tests acceptable to the College of the applicant's ability to speak and write in the French language with scores that reflect a competency that is at least equivalent to the scores required for English;
- (f) where the applicant has previously practised medicine, provides evidence that there has been no finding of, and that there is no current proceeding involving an allegation of, professional misconduct, incompetence or incapacitation or any like finding or proceeding against the applicant;
- (g) pays the licence fee prescribed by subsection 48 (1) for the class of licence for which application is made;
- (h) pays the annual membership fee prescribed by subsection 48 (2) for the class of licence for which application is made;
- (i) fulfils the qualifications and any other requirements for the class of licence for which application is made; and
- (j) presents his or her original degree in medicine and documentation identifying the applicant in person to the Registrar. O. Reg. 344/85, s. 1, *part*; O. Reg. 72/87, s. 3 (1).

(2) Clause (1) (j) does not apply to a person who is a graduate of an accredited medical school in Canada. O. Reg. 344/85, s. 1, *part*.

(3) It is a term and condition of a licence that the licence terminates when the licensee,

- (a) is no longer a Canadian citizen;
- (b) no longer has permanent resident status; or

(c) no longer has special authorization under subclause (1) (c) (ii) or (1) (d) (ii).

(4) Clauses (1) (e), (h) and (j) do not apply to an applicant for a Short Duration licence. O. Reg. 72/87, s. 3 (2).

16.—(1) The qualifications for the issuing of a General licence to an applicant who is a graduate of an accredited medical school are that the applicant,

- (a) has a degree in medicine from an accredited medical school;
- (b) has completed, with performance satisfactory to the College, an approved internship that is,
 - (i) a rotating internship, or
 - (ii) a comprehensive or rotating internship where the applicant has previously successfully completed an acceptable undergraduate clerkship; and
- (c) has a licentiate certificate of the Medical Council of Canada or a diploma of the National Board of Medical Examiners of the United States of America.

(2) The qualifications for the issuing of a General licence to an applicant who is not a graduate of an accredited medical school are that the applicant,

- (a) has a degree in medicine from an acceptable unaccredited medical school;
- (b) has successfully completed the evaluating examination of the Medical Council of Canada and has then completed, with performance satisfactory to the College, two approved internships or an approved internship and an acceptable residency such that,
 - (i) one of the internships is a rotating internship, and
 - (ii) one of the internships or the residency is taken in Canada; and
- (c) has a licentiate certificate of the Medical Council of Canada. O. Reg. 344/85, s. 1, *part*.

(3) An applicant is exempted from clauses (1) (b) and (c) or (2) (b) and (c) if the applicant,

- (a) is the holder of a specialist certificate issued by the Royal College of Physicians and Surgeons of Canada based on the applicant having passed an examination of the Royal College of Physicians and Surgeons of Canada ten years prior to the application; and
- (b) has held an Academic or Hospital Practice licence continuously for the ten years immediately preceding the application.

(4) It is a term and condition of a General licence issued under subsection (3) that the licensee may engage in the practice of medicine only in the specialty in which the licensee is certified by the Royal College of Physicians and Surgeons of Canada. O. Reg. 72/87, s. 4.

17.—(1) The qualifications for the issuing of an Educational licence to an applicant are that the applicant,

- (a) has a degree in medicine from an accredited medical school; or
- (b) has,
 - (i) a degree in medicine from an acceptable unaccredited medical school,

- (ii) successfully completed the evaluating examination of the Medical Council of Canada, and
- (iii) after successfully completing the requirements in clause 15 (1) (e) and subclause (ii), successfully completed,
 - (A) where the applicant is seeking admission to an internship or to a residency in family medicine, a pre-internship program, or
 - (B) where the applicant is seeking admission to a program of postgraduate medical education other than an internship or a residency in family medicine, a pre-residency program; and
- (c) is enrolled in a program of postgraduate medical education provided by an accredited medical school in Ontario. O. Reg. 344/85, s. 1, *part*; O. Reg. 72/87, s. 5 (1).

(2) It is a term and condition of an Educational licence that,

- (a) the licensee may,
 - (i) engage in the practice of medicine only as required by the program in which the licensee is enrolled,
 - (ii) prescribe drugs only for in-patients or out-patients of the hospital or university department where the licensee is engaged in the practice of medicine, and
 - (iii) not charge a fee for medical services and may receive remuneration for medical services only in the form of a fixed salary; and

(b) the licence terminates when the licensee is no longer enrolled in a program of postgraduate medical education provided by an accredited medical school in Ontario. O. Reg. 344/85, s. 1, *part*; O. Reg. 72/87, s. 5 (2).

18.—(1) The qualifications for the issuing of an Academic licence to an applicant are that the applicant,

- (a) has a degree in medicine from an accredited medical school or from an acceptable unaccredited medical school;
- (b) is certified by the Royal College of Physicians and Surgeons of Canada; and
- (c) has a full-time teaching or research appointment of professorial rank in a faculty of medicine of a university in Ontario, with full payment at salary of rank by the university.

(2) It is a term and condition of an Academic licence that,

- (a) the licensee may engage in the practice of medicine only in the department in which he or she holds his or her professorial appointment and to the extent required by the appointment; and
- (b) the licence terminates when the licensee is no longer certified in accordance with clause (1) (b) or no longer holds an appointment in accordance with clause (1) (c). O. Reg. 344/85, s. 1, *part*.

19.—(1) The qualifications for the issuing of a Hospital Practice licence to an applicant are that the applicant,

- (a) has,
 - (i) a degree in medicine from an accredited medical school, or

- (ii) a degree in medicine from an acceptable unaccredited medical school and has successfully completed the evaluating examination of the Medical Council of Canada;
- (b) is certified by the Royal College of Physicians and Surgeons of Canada on the basis of having had at least two years training in university-affiliated training programs in Canada; and
- (c) has an appointment to the medical staff of an institution,
 - (i) approved as a public hospital under the *Public Hospitals Act*, or
 - (ii) designated as a psychiatric facility by the regulations made under the *Mental Health Act*.

(2) It is a term and condition of a Hospital Practice licence that,

- (a) the licensee may engage in the practice of medicine only,
 - (i) in the specialty in which he or she is certified by the Royal College of Physicians and Surgeons of Canada, and
 - (ii) in the institution in connection with which the licence was issued and to the extent required by the appointment; and
- (b) the licence terminates when the licensee is no longer certified under clause (1) (b) or no longer holds an appointment in accordance with clause (1) (c). O. Reg. 344/85, s. 1, *part*.

20.—(1) The qualifications for the issuing of a Public Service licence to an applicant are that the applicant,

- (a) where the applicant is a graduate of an accredited medical school,
 - (i) has a degree in medicine from the accredited medical school,
 - (ii) has completed, with performance satisfactory to the College, an approved internship that is,
 - (A) a rotating internship, or
 - (B) a comprehensive or rotating internship where the applicant has previously successfully completed an acceptable undergraduate clerkship, and
 - (iii) is employed by the Crown in right of Canada or an agency of the Crown; or
- (b) where the applicant is not a graduate of an accredited medical school,
 - (i) has a degree in medicine from an acceptable unaccredited medical school,
 - (ii) has successfully completed the evaluating examination of the Medical Council of Canada and has then completed, with performance satisfactory to the College, two approved internships or an approved internship and an acceptable residency such that,
 - (A) one of the internships is a rotating internship, and
 - (B) one of the internships or the residency is taken in Canada, and

- (iii) is employed by the Crown in right of Canada or an agency of the Crown.
- (2) It is a term and condition of a Public Service licence that,
- (a) the licensee may,
- (i) engage in the practice of medicine only in the course of his or her employment by the Crown in right of Canada or an agency of the Crown,
- (ii) sign certificates under the *Vital Statistics Act* or the *Mental Health Act* and prescribe drugs only in the course of the performance of the employment referred to in subclause (i), and
- (iii) not charge a fee for medical services and may receive remuneration for medical services only in the form of a fixed salary from the licensee's employer; and
- (b) the licence terminates upon the termination of the employment referred to in subclause (a) (i). O. Reg. 344/85, s. 1, *part*; O. Reg. 72/87, s. 6.

21.—(1) Despite subsections 20 (1) and (2), a person who holds a Public Service licence on the 31st day of December, 1985 and who is employed by a board of health within the meaning of the *Health Protection and Promotion Act*, the Crown in right of Ontario or an agency of the Crown on that date shall be deemed to be the holder of a Public Service licence under this Regulation and the person may,

- (a) engage in the practice of medicine;
- (b) prescribe drugs; and
- (c) sign certificates under the *Vital Statistics Act* or the *Mental Health Act*,

provided that the person continues to be employed by the board of health, Crown or agency that employed the person on the 31st day of December, 1985.

(2) A Public Service licence referred to in subsection (1) expires when the board of health, Crown or agency terminates the employment of the licensee.

(3) A person who holds an Underserved Area licence on the 31st day of December, 1985 shall be deemed to be the holder of an Underserved Area licence under this Regulation and the person may engage in the practice of medicine only in the underserved area where he or she is practising medicine on that date.

(4) An Underserved Area licence referred to in subsection (3) expires when the licensee ceases to practise medicine in the underserved area where the licensee is practising medicine on the 31st day of December, 1985. O. Reg. 344/85, s. 1, *part*.

22.—(1) The qualifications for the issuing of a Short Duration licence to an applicant are that the applicant,

- (a) has a degree in medicine from an accredited or acceptable unaccredited medical school;
- (b) has an appointment, solely for the purpose of a short-term, special problem that requires immediate remedy, by,
- (i) an accredited medical school in Ontario,
- (ii) a hospital that is approved under the *Public Hospitals Act* or an institution designated as a psychiatric facility by the regulations made under the *Mental Health Act*, or
- (iii) the Crown in right of Canada or of Ontario or an agency of the Crown; and

- (c) provides a document from a member holding a General licence with no terms, conditions or limitation that evidences the member's undertaking to supervise the applicant and to be responsible for continuing after the licensee leaves Ontario any medical care started by the licensee in Ontario. O. Reg. 72/87, s. 7, *part, revised*.

(2) It is a term and condition of a Short Duration licence that,

- (a) the licensee may,
- (i) engage in the practice of medicine only under the supervision of the member whose undertaking has been given under clause (1) (c) and to the extent required by the appointment mentioned in clause (1) (b), and
- (ii) may charge a fee for a medical service performed in Ontario; and
- (b) the licence terminates,
- (i) when the licensee no longer holds an appointment in accordance with clause (1) (b),
- (ii) when the licensee leaves Ontario, or
- (iii) ten days after the licence is issued to the licensee, whichever occurs first. O. Reg. 72/87, s. 7, *part*.

23.—(1) The information entered in the register respecting each member shall be,

- (a) publicly available;
- (b) capable of being printed promptly; and
- (c) available in printed form to any person during the normal hours of operation of the offices of the College.

(2) The Registrar may give information from the register in printed or oral form to any person.

(3) The Registrar shall issue a certificate of standing in respect of any member to any person who requests such a certificate and pays the fees prescribed by section (5).

(4) A certificate of standing shall state, as of the date of the request,

- (a) the information regarding the member that is contained in the register; and
- (b) whether there is any outstanding referral to the Discipline Committee or the Fitness Practise Committee in respect of the member. O. Reg. 344/85, s. 2, *part, revised*.

(5) The fee for the issuing of a certificate of standing is \$10. O. Reg. 344/85, s. 2, *part*.

24.—(1) Subject to subsection (2), the name of a member entered in the register shall be the same as the name of the member in the documentary evidence of his or her degree in medicine.

(2) The Registrar may direct the entry of a name other than the name required by subsection (1) if the member applies and deposits in the College,

- (a) a certified copy of an order of a court of competent jurisdiction in Ontario changing the member's name;
- (b) a certified copy of a valid certificate of marriage or of a decree absolute of divorce from a court in Canada; or

- (c) documentary material that in the opinion of the Registrar sufficiently identifies the member as the person named in the documentary evidence of his or her degree in medicine,

or any combination of material referred to in clause (a), (b) and (c) and satisfies the Registrar that the use of the other name is not for any improper purpose.

(3) Subsection (2) applies with necessary modifications to an applicant for a licence.

(4) A member shall notify the Registrar in writing of the address to which the member wishes correspondence from the College to be sent and shall notify the Registrar in writing of every change in such address. O. Reg. 344/85, s. 2, *part*.

25.—(1) A member to whom a certificate in a specialty has been issued by The Royal College of Physicians and Surgeons of Canada may use a designation for the specialty approved by The Royal College of Physicians and Surgeons of Canada.

(2) A member who has been censured or suspended by The Royal College of Physicians and Surgeons of Canada and has had his or her name removed from the list of certificants or Fellows of that College shall not use a specialty qualification in any branch of medicine. R.R.O. 1980, Reg. 448, s. 23.

26.—(1) The Council shall determine the information required for the compilation of statistics with respect to the supply, distribution, qualifications and professional activities of members and may direct the Registrar to obtain the required information.

(2) Upon the written request of the Registrar, members shall provide to the Registrar the information requested for the compilation of statistics. R.R.O. 1980, Reg. 448, s. 24.

27. The Registrar is the chief administrative officer of the College and is subject to the direction of the Council. R.R.O. 1980, Reg. 448, s. 25.

28.—(1) The reasons for a decision of the discipline committee shall be published in the original or an edited form and,

- (a) the identity of the member shall be made known if the member's licence has been revoked, suspended or restricted, or if recognition of the member's specialist status has been withdrawn or suspended;
- (b) the identity of the member shall be made known if the committee has reprimanded the member and directed the fact of such reprimand to be recorded on the register or has imposed a fine, unless the council directs that the identity of the member shall not be made known;
- (c) the identity of the member shall not be made known if the committee has reprimanded the member but not directed the fact of such reprimand to be recorded on the register or has suspended or postponed the imposition of a penalty, unless the council directs that the identity of the member shall be made known; and
- (d) the identity of the member shall not be made known if the member has been found not guilty of professional misconduct or incompetence, unless the member requests in writing that he or she be identified.

(2) The Registrar may communicate the decisions of the discipline committee to any complainant and any witness who testified at the hearing if the complainant or witness so requests and the Registrar may also provide any other information he or she considers reasonably necessary to explain the proceedings and the decision to the complainant or witness, including a copy of any written reasons of the committee. O. Reg. 344/85, s. 3.

29. For the purpose of Part III of the Act, "professional misconduct" means,

1. failure by a member to abide by the terms, conditions or limitations of his or her licence;
2. contravention of any provision of Part III of the Act, the *Health Insurance Act*, or the regulations;
3. failure to maintain the records that are required to be kept respecting a member's patients;
4. having a conflict of interest;
5. using a term, title or designation other than one authorized or using a term, title or designation that is prohibited by this Regulation;
6. engaging or holding oneself out as engaging in the practice of medicine using any name other than the name of the member that is entered in the register under section 24;
7. permitting, counselling or assisting any person who is not licensed under Part III of the Act to engage in the practice of medicine except as provided for in the Act or this Regulation;
8. charging a fee that is in excess of the fee in the schedule of fees of the Ontario Medical Association without prior notification to the patient as to the excess amount of the fee;
9. charging for a service that is an insured service under the *Health Insurance Act*, a fee that is in excess of the amount payable for such service under the *Health Insurance Act*, without prior notification to the patient as to the excess amount of the fee;
10. charging a fee that is excessive in relation to the services performed;
11. failure to carry out the terms of an agreement with a patient;
12. selling a professional account to a third party;
13. refusing to render a medically necessary service unless payment of the whole or part of the fee is received in advance of the service being rendered;
14. requiring payment for a service that is insured under the *Health Insurance Act* as a condition to be met before completing a claim card for submission under that Act or, before providing an itemized account of the services where a request is made for an itemized account by the patient or a representative of the patient;
15. offering a reduction for prompt payment of an account;
16. charging a fee for services not performed;
17. falsifying a record in respect of the examination or treatment of a patient;
18. knowingly submitting a false or misleading account or false or misleading charges for services rendered to a patient;
19. announcing or holding out to the public that the member is a specialist or is specially qualified in a branch of medicine where the member is not qualified as a specialist;
20. engaging in the practice of medicine while the ability to perform any professional service is impaired by alcohol or a drug;
21. contravening while engaged in the practice of medicine any

- federal, provincial or municipal law, regulation or rule or a by-law of a hospital designed to protect the public health;
22. failure to maintain the standard of practice of the profession;
 23. giving information concerning a patient's condition or any professional services performed for a patient to any person other than the patient without the consent of the patient unless required to do so by law;
 24. failing to continue to provide professional services to a patient until the services are no longer required or until the patient has had a reasonable opportunity to arrange for the services of another member;
 25. making a misrepresentation respecting a remedy, treatment or device;
 26. failing to reveal the exact nature of a secret remedy following a proper request for such information;
 27. improper use of the authority to prescribe, sell or dispense a drug, including falsifying a record in respect of a prescription or the sale of a drug;
 28. failing to provide within a reasonable time and without cause any report or certificate requested by a patient or his or her authorized agent in respect of an examination or treatment performed by the member;
 29. failing to carry out the terms of an agreement or contract with a hospital;
 30. sexual impropriety with a patient;
 31. sharing fees with any person who has referred a patient or receiving fees from any person to whom a member has referred a patient or requesting or accepting a rebate or commission for the referral of a patient;
 32. publishing, displaying, distributing or using or permitting, directly or indirectly, the publishing, display, distribution or use of any advertisement related to the practice of medicine by a member other than,
 - i. professional cards that contain only the name of the member, a vocational designation, academic degrees, the member's address and telephone number,
 - ii. an announcement upon commencing practice or changing the location of a member's practice that,
 - A. does not exceed two standard newspaper columns in width and ten centimeters in depth,
 - B. does not contain references to qualifications, procedures or equipment but may contain academic degrees, and
 - C. does not appear more than three times in a newspaper in respect of the commencement of the practice or of a change in the location of the practice,
 - iii. appointment cards that do not contain more than the information contained in a professional card and the time and date of the appointment or appointments,
 - iv. a telephone directory listing in the white pages that,
 - A. is of dark or light type,
 - B. where a member is a certificated specialist, may indicate the specialty designation,
 - C. where a member who is not a certificated specialist restricts his or her practice to one branch of medicine may insert after the member's name "Practice limited to",
 - D. does not list office hours, and
 - E. where the practice of medicine is carried on as a partnership, clinic, medical centre or other form of medical group lists the name of the partnership, clinic, medical centre or other form of medical group and the names of the members with their designations thereunder;
 33. conduct or an act relevant to the practice of medicine that, having regard to all the circumstances, would reasonably be regarded by members as disgraceful, dishonourable or unprofessional. R.R.O. 1980, Reg. 448, s. 27; O. Reg. 112/83, s. 1; O. Reg. 344/85, s. 4.
- 30.—(1)** A member shall practise medicine in accordance with the usually and generally accepted standards of practice expected in the branches of medicine in which the member is practising.
- (2) The usually and generally accepted standards of practice do not include the administration, prescription, advising or otherwise being associated with the use of,
- (a) human or non-human chorionic gonadotrophin for obesity, its sequelae or complications or for any condition associated with obesity; or
 - (b) ethylene diamine tetra-acetic acid or its salts for atherosclerotic disease or any other disease or condition except poisoning by heavy metals.
- (3) The Council may exempt any member from the provisions of subsection (2) under such special circumstances in the public interest as the Council considers advisable. O. Reg. 445/87, s. 1.
- 31.—(1)** In this section,

“benefit” means any benefit, gift, advantage or emolument of any kind whatsoever, whether direct or indirect, and includes,

- (a) the receipt of any benefit from the services of any person or reimbursement of the cost thereof,
- (b) the benefit or receipt of the payment or reduction of any amount of any debt or financial obligation,
- (c) the receipt of any consultation fee or other fee for services rendered, except pursuant to a written contract for each such service where,
 - (i) a copy of the contract is available and produced to the College on demand,
 - (ii) each contracted service is within the normal scope of the member’s specialty, and
 - (iii) each service is supported by records adequate to satisfy the College that it was in fact performed,
- (d) the acceptance of any loan except pursuant to a written evidence of indebtedness,
 - (i) executed at the time of transfer of funds,
 - (ii) witnessed at the time of actual execution by an individual whose name is legibly recorded on the document,
 - (iii) available and produced to the College on demand, and
 - (iv) that provides for a fixed term of loan and fixes a set interest rate, both of which are reasonable having a view to prevailing market rates at the time of the loan,
- (e) the acceptance of a loan that is interest free or related in any way to any referral made by the member,
- (f) the acceptance of credit unless the credit is unrelated in any way to any referral of patients to the creditor and the credit is extended pursuant to an agreement in writing,
 - (i) executed at the time of the transaction,
 - (ii) witnessed at the time of actual execution by an individual whose name is legibly recorded on the agreement,
 - (iii) available and produced to the College on demand, and
 - (iv) which provides for a fixed term of credit and fixes a set interest rate, both of which are reasonable having a view to prevailing market rates at the time of the transaction;

“medical goods or services” includes medical goods, appliances, materials, services and equipment, and drugs and laboratory services;

“member of his or her family” means any person connected with a member by blood relationship, marriage or adoption, and

- (a) persons are connected by blood relationship if one is the child or other descendent of the other or one is the brother or sister of the other,
- (b) persons are connected by marriage if one is married to the other or to a person who is connected by blood relationship to the other, and

- (c) persons are connected by adoption if one has been adopted, either legally or in fact, as the child of the other or as the child or a person who is so connected by blood relationship (otherwise than as a brother or sister) to the other;

“supplier” means a person who,

- (a) sells or otherwise supplies medical goods or services, or
- (b) is registered or licensed under any Act regulating a health profession.

(2) It is a conflict of interest for a member where the member, or a member of his or her family, or a corporation wholly, substantially or actually owned or controlled by the member or a member of his or her family,

- (a) receives any benefit, directly or indirectly, from,
 - (i) a supplier to whom the member refers his or her patients or their specimens, or
 - (ii) a supplier who sells or otherwise supplies any medical goods or services to the patients of the member;

- (b) rents premises to,
 - (i) a supplier to whom the member refers his or her patients or their specimens, or
 - (ii) a supplier who sells or otherwise supplies any medical goods or services to the patients of the member,

except where,

- (iii) the rent is normal for the area in which the premises are located, and
- (iv) the amount of the rent is not related to the volume of business carried out in the premises by the tenant;

- (c) rents premises from,
 - (i) a supplier to whom the member refers his or her patients or their specimens, or
 - (ii) a supplier who sells or otherwise supplies any medical goods or services to the patients of the member,

except where,

- (iii) the rent is normal for the area in which the premises are located, and
- (iv) the amount of the rent is not related to the referral of patients to the landlord; or

- (d) sells or otherwise supplies any drug, medical appliance, medical product or biological preparation to a patient at a profit, except,

- (i) a drug sold or supplied by a member to his or her patient that is necessary,

(A) for an immediate treatment of the patient,

(B) in an emergency, or

(C) where the services of a pharmacist are not reasonably readily available, or

- (ii) despite subclause (i), an allergy preparation prepared by a member for his or her patient that is sold or supplied by the member for a price that does not exceed,

- (A) the true cost of production of the preparation, and
- (B) the fee for the professional component, for the member's review of the case, the prescription of the material and the general supervision of the member's laboratory in preparing the material.

(3) It is a conflict of interest for a member to order diagnostic tests other than medically necessary tests to be performed by a diagnostic facility in which the member or a member of his or her family has any proprietary interest. R.R.O. 1980, Reg. 448, s. 28.

32.—(1) A member shall,

- (a) keep a legibly written or typewritten record in respect of each patient of the member setting out,
 - (i) the name and address of the patient,
 - (ii) each date that the member sees the patient,
 - (iii) a history of the patient,
 - (iv) particulars of each physical examination of the patient by the member,
 - (v) investigations ordered by the member and the results of the investigations,
 - (vi) each diagnosis made by the member respecting the patient, and
 - (vii) each treatment prescribed by the member for the patient;
- (b) keep a day book, daily diary or appointment record setting out the name of each patient seen or treated or in respect of whom a professional service is rendered by the member.

(2) A member shall keep the records required under subsection (1) in a systematic manner and shall retain each record for a period of six years after the date of the last entry in the record or until the member ceases to engage in the practice of medicine, whichever first occurs.

(3) A member shall make records kept under subsection (1) and books, records, documents and things relevant thereto available at reasonable hours for inspection by a person appointed by the Registrar under section 65 of the Act, a member appointed by the Registrar for the purpose of peer review or a person appointed as an inspector under subsection 43 (1) of the *Health Insurance Act*. R.R.O. 1980, Reg. 448, s. 29.

33.—(1) In this section, and in sections 34 to 42,

“drug” means drug as defined in Part VI of the Act;

“pharmacist” means pharmacist as defined in Part VI of the Act;

“prescriber” means prescriber as defined in Part VI of the Act;

“prescription” means prescription as defined in Part VI of the Act;

“Schedule G preparation” means a drug that contains one drug referred to in Schedule G and one or more active medicinal ingredients that are not referred to in Schedule G in a recognized therapeutic dose, or a drug that contains as the only medicinal ingredient phenobarbital or any of its salts in an amount not exceeding 32.4 milligrams (1/2 grain) per unit dosage;

“Schedule N preparation” means a drug that,

- (i) contains one drug referred to in Schedule N and two

or more active medicinal ingredients which are not referred to in Schedule N or a recognized therapeutic dose, and

- (ii) is not intended for parenteral administration;

“sell” includes offer to sell, dispense, distribute, give away and supply.

(2) A reference to Schedule A, B, C, D, E, F, G or N is a reference to such Schedule established by the regulations for the purposes of Part VI of the Act. R.R.O. 1980, Reg. 448, s. 30.

34.—(1) Where a member decides to treat a patient with a drug, the member shall give a written prescription to the patient or offer to give a verbal prescription to a pharmacist acceptable to the patient.

(2) A member who has given a written prescription for a drug to a patient may sell the drug to the patient subject to the provisions of this Regulation governing the sale, recording, labelling and packaging of drugs. R.R.O. 1980, Reg. 448, s. 31.

35. A member who sells a drug referred to in Schedule G or N, and furnishes the drug in an amount,

- (a) that exceeds three times the maximum daily dosage recommended by the manufacturer of the drug for the drug; or
- (b) if the manufacturer has not recommended a maximum daily dosage for the drug, that exceeds three times the generally recognized maximum daily therapeutic dosage for the drug,

shall keep a record showing,

- (c) the date of the sale;
- (d) the name and address of the person for whom the drug was prescribed;
- (e) the name, strength where applicable, and quantity of the drug; and
- (f) the price, if any, charged. R.R.O. 1980, Reg. 448, s. 32.

36. A member shall keep or cause to be kept a record of every purchase of a drug referred to in the Schedules to Part VI of the Act by entering or causing to be entered in a register or other record that shall be maintained for that purpose forthwith upon such purchase,

- (a) the date of the purchase;
- (b) the name, strength where applicable, and quantity of the drug;
- (c) the name and address of the person from whom the drug was purchased or received; and
- (d) the purchase price, if any. R.R.O. 1980, Reg. 448, s. 33.

37. Every member who sells a drug shall,

- (a) retain the written prescription for the drug for a period of not less than two years or until he or she ceases to engage in the practice of medicine, whichever first occurs;
- (b) record on the prescription,
 - (i) the name and address of the person for whom the drug is prescribed,
 - (ii) the name, strength where applicable, and quantity of the prescribed drug,
 - (iii) the identity of the manufacturer of the drug,

- (iv) the directions for use,
 - (v) an identification number or other designation,
 - (vi) the date on which the drug is dispensed, and
 - (vii) the price charged, if any; and
- (c) mark the container in which the drug is dispensed with,
- (i) the identification number that is on the record of sale,
 - (ii) the name of the drug, if the member considers it advisable,
 - (iii) the quantity, where the drug dispensed is in solid oral dosage form,
 - (iv) the date the drug is dispensed,
 - (v) the name and address of the prescriber,
 - (vi) the name of the person for whom it is prescribed, and
 - (vii) the prescribed directions for use. R.R.O. 1980, Reg. 448, s. 34.

38. Every container in which any article or substance referred to in Part II of Schedule B is sold by a member shall include on the label, legibly and conspicuously displayed on the outer surface of the container in which the article or substance is contained, a caution or warning to the effect that the article or substance should be kept out of the reach of children, but if the article or substance is an article or substance referred to in the *Hazardous Products Act* (Canada) the provisions of this section do not apply. R.R.O. 1980, Reg. 448, s. 35.

39. Every container in which any article or substance referred to in Part III of Schedule B is sold by a member, shall include on the label, legibly and conspicuously displayed on the outer surface of the container in which the article or substance is contained, a caution or warning to the effect that the article or substance should be used only with adequate ventilation, but if the article or substance is an article or substance referred to in the *Hazardous Products Act* (Canada) the provisions of this section do not apply. R.R.O. 1980, Reg. 448, s. 36.

40.—(1) Every container in which any drug specified in subsection (2) is sold in a form for internal use, shall bear the following words legibly and conspicuously displayed on the outer surface of the container in which the drug is dispensed:

“WARNING; Do not exceed the dose prescribed. If difficulty in breathing persists, contact a physician immediately.”

(2) The following drugs are specified for the purpose of subsection (1):

1. Epinephrine and its salts.
2. Isoproterenol (Isoprenaline) and its salts.
3. Metaproterenol (Orciprenaline) and its salts. R.R.O. 1980, Reg. 448, s. 37.

41. Every member who sells drugs shall maintain a system for filing his or her records of the purchases and sales of the drugs. R.R.O. 1980, Reg. 448, s. 38.

42.—(1) In this section, “child resistant package” means a con-

tainer or package that meets the standards for child resistant packages approved by the Minister.

(2) A member shall only dispense a drug in a child resistant package except where,

- (a) in the opinion of the member it is advisable not to use a child resistant package;
- (b) a child resistant package is not suitable because of the physical form of the drug;
- (c) the member is unable to obtain a child resistant package because supplies of such packages are unavailable on the market. R.R.O. 1980, Reg. 448, s. 39.

43. The fee for entry of a member in the General register is,

- (a) in the case of a member who is a graduate of a medical school situated in Ontario, \$150; or
- (b) in the case of a member who is a graduate of a medical school outside Ontario, \$200. R.R.O. 1980, Reg. 448, s. 40 (1).

44.—(1) The fee for entry of a member in the Educational register is,

- (a) in the case of a member who is a graduate of a medical school situated in a part of Canada other than Ontario, \$50;
- (b) in the case of a member who is a graduate of a medical school situated outside Canada, \$100. R.R.O. 1980, Reg. 448, s. 41 (1).

(2) The annual fee for a member who holds an Educational licence is \$35.

(3) The fee on application for an Educational licence is \$35. O. Reg. 205/82, s. 2.

45. The fee for entry of a member in the Special register is,

- (a) in the case of a member who is a graduate of a medical school situated in Ontario, \$150;
- (b) in the case of a member who is a graduate of a medical school situated outside of Ontario, \$200. R.R.O. 1980, Reg. 448, s. 42 (1).

46. A member of the Canadian Forces who is the holder of a Public Service Licence is exempt from payment of the fee for entry in the Special Register. R.R.O. 1980, Reg. 448, s. 43.

47.—(1) The Registration Committee may grant emeritus status to a former member who applies therefor and,

- (a) at the time he or she was a member, held a General licence under Part III of the Act or the equivalent licence under a predecessor of that Act, continuously for twenty-five years;
- (b) at the time of application, is in good standing as set out in subsection 3 (2); and
- (c) is fully retired from the practice of medicine.

(2) A person holding emeritus status may not engage in the practice of medicine.

(3) Every person who was designated a member emeritus under a predecessor of this section shall be deemed to continue as a person with emeritus status.

(4) Every member who was designated as a life member under section 43 of Ontario Regulation 577/75 or a predecessor thereof and

continues to meet the requirements of that section shall be deemed to continue as a life member. O. Reg. 344/85, s. 5.

- 48.—(1) The fee payable on an application,
- (a) for a class of licence other than an Educational licence is \$200; and
 - (b) for an Educational licence is \$50. O. Reg. 344/85, s. 6, *part*.
- (2) The annual membership fee payable by a licensee who holds,
- (a) a licence of any class other than an Educational licence is \$450; and
 - (b) an Educational licence, is \$35. O. Reg. 344/85, s. 6, *part*; O. Reg. 206/89, s. 1; O. Reg. 154/90, s. 1.
- (3) The annual membership fee is due,
- (a) in the case of a person being licensed for the first time, before the issuing of the licence; and
 - (b) in the case of a licence holder not holding a licence for the first time, other than an Educational licence, on the 1st day of June in each year. O. Reg. 344/85, s. 6, *part*; O. Reg. 72/87, s. 8 (1).
- (4) The Registrar shall mail a notice to each member, other than a life member or a member holding an Educational licence, before the 30th day of April in each year, that informs the member that an annual membership fee is due on the 1st day of June and the amount of the fee.
- (5) A member holding an Educational licence shall be given notice of the membership fee that is due at the time of a confirmation of the continued appointment in a program of postgraduate medical education. O. Reg. 72/87, s. 8 (2).

49. No licence shall be dated earlier than the day that it is actually issued by the Registrar. O. Reg. 445/87, s. 2.

REGULATION 549
NURSING

1. For the purpose of the election of members to the Council, the following electoral districts are established:
- 1. The Southwestern Region electoral district composed of the counties of Elgin, Essex, Huron, Kent, Lambton, Middlesex, Oxford and Perth.
 - 2. The Central Western Region electoral district composed of the counties of Brant, Bruce, Grey, Wellington and Dufferin and the regional municipalities of Haldimand-Norfolk, Hamilton-Wentworth, Niagara and Waterloo.
 - 3. The Metropolitan Toronto electoral district composed of The Municipality of Metropolitan Toronto.
 - 4. The Central electoral district, composed of the County of Simcoe and the regional municipalities of Halton, Peel and York.
 - 5. The Central Eastern electoral district composed of the counties of Frontenac, Hastings, Lanark, Leeds, Grenville, Haliburton, Lennox and Addington, Northumberland, Peterborough, Prince Edward, Victoria and The Regional Municipality of Durham.
 - 6. The Eastern Region electoral district, composed of the

counties of Stormont, Dundas, Glengarry, Prescott, Russell and Renfrew, and The Regional Municipality of Ottawa-Carleton.

- 7. The Northeastern Region electoral district, composed of the territorial districts of Algoma, Cochrane, Manitoulin, Muskoka, Parry Sound, Nipissing, Sudbury and Timiskaming and that portion of the Territorial District of Kenora east of the 87th longitude.
 - 8. The Northwestern Region electoral district, composed of the territorial districts of Rainy River, Thunder Bay and that portion of the Territorial District of Kenora west of the 87th longitude. R.R.O. 1980, Reg. 449, s. 1; O. Reg. 11/87, s. 1; O. Reg. 134/88, s. 1; O. Reg. 63/89, s. 1.
- 2.—(1) The term of office of members of the Council shall be three years. R.R.O. 1980, Reg. 449, s. 2 (2), *revised*.
- (2) Despite subsection (1), the term of office of the member who gets the second largest number of votes and is elected to represent registered nursing assistants in the Central Western Region electoral district shall be for two years. O. Reg. 11/87, s. 2.
- (3) The term of office of a member elected to the Council commences with the first meeting of the Council immediately following the election.
- (4) For the purpose of the election of members of the Council, a member who is resident in Ontario shall be deemed to reside in the place shown on the general register as his or her place of residence, and a member who is employed in Ontario but who resides outside of Ontario shall be deemed to reside in the electoral district in which he or she is employed. R.R.O. 1980, Reg. 449, s. 2 (3, 4).

3. There shall be elected from each electoral district referred to in Column 1 of the following Table the number of registered nurses set out opposite thereto in Column 2 and the number of registered nursing assistants set out opposite thereto in Column 3 of the Table:

TABLE

ITEM	COLUMN 1	COLUMN 2	COLUMN 3
	Electoral Districts	Registered Nurses	Registered Nursing Assistants
1.	Southwestern Region	3	1
2.	Central Western Region ..	3	1
3.	Metropolitan Toronto Region	3	1
4.	Central Region	2	1
4a.	Central Eastern Region ...	2	1
5.	Eastern Region	2	1
6.	Northeastern Region	1	1
7.	Northwestern Region	1	1

R.R.O. 1980, Reg. 449, s. 3; O. Reg. 11/87, s. 3; O. Reg. 134/88, s. 2; O. Reg. 63/89, s. 2.

- 4.—(1) A member is eligible for election to the Council who,
- (a) resides in the electoral district for which he or she is nominated; and
 - (b) is in good standing in the College.
- (2) A member is in good standing in the College for the purpose of subsection (1) where,

- (a) he or she is not in default of payment of any fees prescribed by the regulations;
- (b) his or her professional conduct is not the subject of disciplinary proceedings;
- (c) his or her certificate is not under suspension; and
- (d) his or her certificate is not subject to a term, condition or limitation other than one prescribed by the regulations. R.R.O. 1980, Reg. 449, s. 4 (1, 2).

(3) Subject to subsection (4) a member of Council is eligible for re-election, except that no member shall serve for more than two consecutive terms, but on the expiration of one year after having served the second of two consecutive terms, such person may again be eligible for membership on the Council.

(4) The limit of two consecutive terms referred to in subsection (3) does not include, service on the Council for the balance of an unexpired term for a person who becomes a member of Council under subsection 10 (2). O. Reg. 355/82, s. 1, *revised*.

5.—(1) Ten members who are registered nurses residing in an electoral district may nominate a member who is a registered nurse residing in the electoral district as a candidate for election from that electoral district, and the nomination shall be in writing and shall be submitted to the Council at least ninety days before the date set for the election.

(2) Ten members who are registered nursing assistants residing in an electoral district may nominate a member who is a registered nursing assistant residing in the electoral district as a candidate for election from that electoral district, and the nomination shall be in writing and shall be submitted to the Council at least ninety days before the date set for the election. R.R.O. 1980, Reg. 449, s. 5.

6. A person nominated under section 5 is a candidate for election as a member of the Council if he or she submits to the Council a written consent to his or her candidacy at least sixty days before the date set for the election. R.R.O. 1980, Reg. 449, s. 6.

7.—(1) A member who is a registered nurse is entitled to cast as many votes in an election of members to the Council as there are members who are registered nurses to be elected to the Council from the electoral district in which the member is entitled to vote but a member is not entitled to cast more than one vote for any one candidate.

(2) A member who is a registered nursing assistant is entitled to cast as many votes in an election of members to the Council as there are members who are registered nursing assistants to be elected to the Council from the electoral district in which the member is entitled to vote but a member is not entitled to cast more than one vote for any one candidate. R.R.O. 1980, Reg. 449, s. 7.

8.—(1) Prior to the annual election of Council members from the respective electoral districts, an election committee composed of two registered nurses and two registered nursing assistants who are members of Council shall be appointed by Council to assume responsibility for the total election procedure. O. Reg. 506/81, s. 1.

(2) Where in the election of a candidate to the Council a tie vote exists, the election committee shall, by lot, decide which candidate shall be elected.

(3) If a member of the election committee is one of the tie vote candidates, he or she shall not be party to the decision.

(4) Voting for candidates for election to Council shall be by secret ballot using ballot forms that shall be supplied by the Director and that contain the names of the candidates in the electoral district.

(5) Where there is an interruption of mail service during an election, the Director shall extend the holding of the election for such

minimum period of time as the Director considers necessary to compensate for the interruption. R.R.O. 1980, Reg. 449, s. 8 (2-5).

9.—(1) The Director shall destroy all ballots thirty-one days after the announcement of the results of an election unless a candidate challenges the election or its results.

(2) Within thirty days from the date of the counting of ballots, a candidate may require a recount of the ballots of the electoral district in which he or she was nominated, on depositing with the Director the sum of \$400 and a written request for the recount.

(3) Where a recount has been requested, the Director shall appoint the time and place and arrange for the recount, which shall take place within fifteen days from the date of the request and shall be conducted, subject to subsection (4), in the same manner as the original counting of the ballots except that the candidate or a representative named by the candidate may be present at the recount.

(4) The recount shall be conducted by two scrutineers appointed by the President of the College.

(5) The portion of the deposit of \$400 remaining after payment of the actual cost to the College of conducting the recount shall be returned to the candidate but if the recount changes the result of the election the full amount of the deposit shall be returned to the candidate. R.R.O. 1980, Reg. 449, s. 9.

10.—(1) Where an elected member of the Council,

- (a) is found to be an incapacitated member;
- (b) is found guilty of professional misconduct or incompetence;
- (c) fails to attend two consecutive regular meetings of Council without cause;
- (d) fails to attend three consecutive meetings of a statutory or standing committee of which he or she is a member without cause; or
- (e) ceases to maintain actual residence in the electoral region for at least six months in each electoral year,

the member is disqualified from sitting on the Council and the seat of the member on the Council shall be deemed to be vacant. O. Reg. 506/81, s. 2.

(2) Where an elected member of the Council dies or resigns or his or her seat otherwise becomes vacant before the expiry of his or her term of office, the Council shall,

- (a) where the unexpired term of the member whose seat became vacant does not exceed two years, appoint a successor from among the registered nurses or registered nursing assistants, as the case requires, who are members of the College residing in or deemed to reside in the electoral district represented by the member whose seat on the Council became vacant; or
- (b) where the unexpired term of the member whose seat became vacant exceeds two years,
 - (i) appoint the registered nurse or registered nursing assistant, as the case requires, who of the unsuccessful candidates received the greatest number of votes cast in the last general election of members to the Council from the electoral district represented by the member whose seat became vacant, or
 - (ii) direct the Director to hold a by-election in accordance with the provisions of this Regulation for the electoral district which the member represented,

and the appointed or elected successor shall serve until the

expiry of the term of office of the member whose seat became vacant. R.R.O. 1980, Reg. 449, s. 10 (2).

11. The requirements and qualifications for the issuing to an applicant of a certificate of competency to practise as a registered nurse are,

- (a) completion of an application for a certificate in a form that shall be supplied by the Director;
- (b) one of the following,
 - (i) successful completion of a diploma nursing program in Ontario approved by the Ministry of Colleges and Universities,
 - (ii) successful completion of a diploma nursing program at the Ryerson Polytechnical Institute approved by the Academic Council of the Institute,
 - (iii) successful completion of a basic baccalaureate program in nursing in Ontario approved by the Committee on Accreditation of the Ontario Region of the Canadian Association of University Schools of Nursing,
 - (iv) successful completion of a program for the training of nurses outside of Ontario that is considered by the Council to be equivalent to the program referred to in subclause (i), (ii) or (iii), together with current registration or licensing as a nurse in a jurisdiction other than Ontario, eligibility for registration or licensing, as the case requires, in the jurisdiction in which the program was completed and employment as a nurse within the period of five years immediately preceding the application;

- (c) reasonable fluency in the English or French language;
- (d) successful completion of the examination set by the Canadian Nurses' Association Testing Service for registration as a nurse or its equivalent; and
- (e) payment of the fees prescribed by this Regulation. R.R.O. 1980, Reg. 449, s. 11; O. Reg. 259/90, s. 1.

12. The requirements and qualifications for the issuing to an applicant of a certificate of competency to practise as a nursing assistant are,

- (a) completion of an application in a form that shall be supplied by the Director;
- (b) one of the following,
 - (i) successful completion of a nursing assistant program approved by,
 - (A) the Ministry of Colleges and Universities,
 - (B) the Ministry of Health, or
 - (C) the Ministry of Education,
 - (ii) successful completion of a program for the training of nursing assistants outside of Ontario that is considered by the Council to be equivalent to a program referred to in subclause (i), together with current registration or licensing in a jurisdiction other than Ontario, eligibility for registration or licensing, as the case requires, in the jurisdiction in which the program was completed and employment as a nursing assistant within the period of five years immediately preceding the application;

- (c) reasonable fluency in the English or French language;
- (d) successful completion of the examination set by the Canadian Nurses' Association Testing Service for registration as a nursing assistant or its equivalent; and
- (e) payment of the fees prescribed by this Regulation. R.R.O. 1980, Reg. 449, s. 12; O. Reg. 259/90, s. 2.

13. Where the Director issues a certificate to an applicant, the Director shall also issue to the applicant a certificate of initial registration as a nurse or as a nursing assistant, as the case requires. R.R.O. 1980, Reg. 449, s. 13.

14. A certificate expires with the 31st day of December in the year in which it is issued. R.R.O. 1980, Reg. 449, s. 14.

15.—(1) For the purpose of compiling statistical information on the supply, distribution and professional activities of members, the Director shall mail to each member who holds a current certificate, at least thirty days before the expiration of the certificate, an application form for a renewal of the certificate that contains questions that relate to the activities of the member.

(2) Each member who wishes to renew a current certificate shall complete and return to the Director the application form supplied by the Director. O. Reg. 585/88, s. 1.

16. The Director shall issue a renewal of a current certificate to the holder of the certificate upon receipt of a completed annual renewal application form and the annual fee prescribed by this Regulation. R.R.O. 1980, Reg. 449, s. 16.

17. An applicant for a renewal of an expired certificate shall complete an application form that shall be provided by the Council and shall pay the annual fee prescribed by this Regulation for renewal of the expired certificate. R.R.O. 1980, Reg. 449, s. 17.

18.—(1) The Director shall establish an Education Register—Nurses in which shall be entered the names of persons who have been issued initial certificates of registration as registered nurses.

(2) The Director shall establish an Education Register—Nursing Assistants in which shall be entered the names of persons who have been issued initial certificates of registration as registered nursing assistants.

(3) The Director shall establish a General Register—Nurses in which shall be entered the names of persons who have been issued current certificates of competence to practise as registered nurses.

(4) The Director shall establish a General Register—Nursing Assistants in which shall be entered the names of persons who have been issued current certificates of competence to practise as registered nursing assistants. R.R.O. 1980, Reg. 449, s. 18.

19. The registers for members maintained by the Director may be inspected by any person during normal business hours. R.R.O. 1980, Reg. 449, s. 19.

20.—(1) Nursing services shall not be performed by a member where there is a conflict of interest.

(2) It is a conflict of interest for a member to solicit clients for a facility or agency which provides nursing care for profit,

- (a) where the member is a shareholder of the facility or agency; or
- (b) where the member obtains financial gain directly or indirectly from such solicitation. R.R.O. 1980, Reg. 449, s. 20.

21. For the purposes of Part IV of the Act, "professional misconduct" means,

- (a) the contravention of any provision of Part IV of the Act or of the regulations;
- (b) failure to maintain the standards of practice of the profession;
- (c) abusing a patient verbally or physically;
- (d) misappropriating a patient's personal property;
- (e) having a conflict of interest;
- (f) directly influencing a patient to change his or her will;
- (g) abandoning a patient;
- (h) misappropriating drugs or other property belonging to a member's employer;
- (i) participating in advertising or endorsing a product;
- (j) failure to inform the member's employer of the member's inability to accept specific responsibility in areas where special training is required or where the member does not feel competent to function without supervision;
- (k) failure to report the incompetence of colleagues whose actions endanger the safety of a patient;
- (l) failure to exercise discretion in respect of the disclosure of confidential information about a patient;
- (m) falsifying a record in respect of the observation or treatment of a patient; and
- (n) conduct or an act relevant to the performance of nursing services that, having regard to all the circumstances, would reasonably be regarded by members as disgraceful, dishonourable or unprofessional. R.R.O. 1980, Reg. 449, s. 21; O. Reg. 355/82, s. 2; O. Reg. 340/88, s. 1.

22.—(1) The decisions of the Discipline Committee shall be published by the College in its annual report and may be published by the College in any other publication of the College, and where a member has been found guilty of professional misconduct or incompetence, the full name and address and the registration number of the member may be stated and a summary of the charge, the decision and the penalty imposed may be stated and the text or substance of any restriction on the certificate of the member or of any reprimand may be added, but where a member has been found not guilty of professional misconduct or incompetence, the identity of the member shall not be published but the substance of the proceedings may be published without identification of the parties for the purpose of publishing advice to the member or to the profession.

(2) Where the Discipline Committee decides that a certificate should be issued to a person whose certificate was revoked or whose registration was cancelled or that the suspension of a certificate or a registration should be removed, the decision shall be published by the College in its annual report and may be published by the College in any other publication of the College and the full name and address and the registration number of the person and the date of the revocation, cancellation or suspension and the date of the issuance of the certificate or removal of the suspension may be stated. R.R.O. 1980, Reg. 449, s. 22.

23. Where the Registration Committee finds that a member is an incapacitated member, the finding, the full name and address and the registration number of the member and a summary or the text of

the order of the Committee consequent upon the finding may be published by the College in its annual report and in any other publication of the College. R.R.O. 1980, Reg. 449, s. 23.

24. A member in the performance of nursing services as a registered nurse or registered nursing assistant shall exercise generally accepted standards of practice for the performance of the nursing services and shall maintain nursing records for the persons for whom the member performs the nursing services. R.R.O. 1980, Reg. 449, s. 24.

25. Except where otherwise provided in any Act or Regulation, the nursing records for a person for whom nursing services are provided shall be retained,

- (a) where the patient is discharged, for a period of twenty years after the date of the discharge; or
- (b) where the patient dies, for a period of five years after the date of death. O. Reg. 665/81, s. 1.

26. The fee for writing an examination set by the Canadian Nurses' Association Testing Service for registration as a nurse is, for an examination written,

- (a) before the 1st day of July, 1991, \$148; and
- (b) on or after the 1st day of July, 1991, \$153. O. Reg. 259/90, s. 3, *revised*.

27. The fee for writing an examination set by the Canadian Nurses' Association Testing Service for registration as a nursing assistant is, for an examination written,

- (a) before the 1st day of June, 1991, \$128; and
- (b) on or after the 1st day of June, 1991, \$133. O. Reg. 259/90, s. 4, *revised*.

28. The fee for a certificate is \$76.63. O. Reg. 509/90, s. 1, *part*.

29. The fee for a certificate on reinstatement after suspension or cancellation is \$76.63. O. Reg. 509/90, s. 1, *part*.

30. The fee for evaluation of documents on an application for a certificate is,

- (a) \$30, for an applicant who received basic nursing education in Canada; or
- (b) \$50, for an applicant who received basic nursing education outside of Canada. R.R.O. 1980, Reg. 449, s. 29.

31. The annual fee for a member is \$56.07. O. Reg. 509/90, s. 1, *part*.

32. The annual fee for a member when the fee is paid after the expiry of a member's current certificate is \$76.63. O. Reg. 509/90, s. 1, *part*.

33. A certificate of competence as a registered nurse shall be in Form 1. R.R.O. 1980, Reg. 449, s. 32.

34. A certificate of initial registration as a nurse shall be in Form 2. R.R.O. 1980, Reg. 449, s. 33.

35. A certificate of competence as a registered nursing assistant shall be in Form 3. R.R.O. 1980, Reg. 449, s. 34.

36. A certificate of initial registration as a nursing assistant shall be in Form 4. R.R.O. 1980, Reg. 449, s. 35.

Form 1

Health Disciplines Act

CERTIFICATE OF COMPETENCE—REGISTERED NURSE

REGISTERED NURSE

CERTIFICATE OF COMPETENCE

19.....

Day Month Year

DATE OF ISSUE

Certificate No.

Registration
Number

ISSUED TO:

under authority of the *Health Disciplines Act*.

.....
signature of registrant

.....
Director, College of Nurses of Ontario

Expiry Date—31 December, 19.....

R.R.O. 1980, Reg. 449, Form 1.

Form 2

Health Disciplines Act

CERTIFICATE OF INITIAL REGISTRATION—NURSE

COLLEGE OF NURSES OF ONTARIO

INITIAL NURSE REGISTRATION CERTIFICATE

THIS IS TO CERTIFY THAT
qualifies for initial registration under the *Health Disciplines Act* and the regulations thereunder, and is authorized to use the title

REGISTERED NURSE

subject to annual renewal of Certificate of Competence

Dated at Toronto, the day of, 19.....

Registration No.
.....
Director

R.R.O. 1980, Reg. 449, Form 2.

Form 3

Health Disciplines Act

CERTIFICATE OF COMPETENCE—REGISTERED NURSING ASSISTANT

REGISTERED NURSING ASSISTANT

CERTIFICATE OF COMPETENCE

19.....

Day Month Year

DATE OF ISSUE

Certificate No.

Registration
Number

ISSUED TO:

under authority of the *Health Disciplines Act*.

.....
signature of registrant

.....
Director, College of Nurses of Ontario

Expiry Date—31 December, 19.....

R.R.O. 1980, Reg. 449, Form 3.

Form 4

Health Disciplines Act

CERTIFICATE OF INITIAL REGISTRATION—NURSING ASSISTANT

COLLEGE OF NURSES OF ONTARIO

INITIAL NURSING ASSISTANT REGISTRATION CERTIFICATE

THIS IS TO CERTIFY THAT
qualifies for initial registration under the *Health Disciplines Act* and the regulations thereunder, and is authorized to use the title

RÉGISTERED NURSING ASSISTANT

subject to annual renewal of Certificate of Competence

Dated at Toronto, the day of, 19.....

Registration No.
.....
Director

R.R.O. 1980, Reg. 449, Form 4.

REGULATION 550

OPTOMETRY

1. For the purpose of the election of members to the Council, the following electoral districts are established:

- 1. The Central electoral district, composed of the regional municipalities of Halton, Peel, Waterloo and York together with the County of Wellington and The Municipality of Metropolitan Toronto.
- 2. The Eastern electoral district composed of the regional municipalities of Durham and Ottawa-Carleton together

with the counties of Dundas, Frontenac, Glengarry, Grenville, Haliburton, Hastings, Lanark, Leeds, Lennox and Addington, Northumberland, Peterborough, Prescott, Prince Edward, Renfrew, Russell, Stormont, Victoria and The District Municipality of Muskoka.

- 3. The Northern electoral district composed of the counties of Bruce, Dufferin, Elgin, Grey, Huron, Middlesex and Simcoe together with the territorial districts of Algoma, Cochrane, Kenora, Manitoulin, Nipissing, Parry Sound, Rainy River, Sudbury, Thunder Bay and Timiskaming.
- 4. The Western electoral district composed of the regional municipalities of Haldimand-Norfolk, Hamilton-

Wentworth and Niagara, together with the counties of Brant, Essex, Kent, Lambton, Oxford and Perth.

5. The Provincial electoral district composed of the whole of the Province of Ontario. R.R.O. 1980, Reg. 450, s. 1.

2. One member shall be elected to the Council from each of the Eastern, Northern, Provincial and Western electoral districts and two members shall be elected to the Council from the Central electoral district. R.R.O. 1980, Reg. 450, s. 2.

3.—(1) A member is eligible for election to the Council who,

(a) is engaged in the practice of optometry in the electoral district for which he or she is nominated; and

(b) is in good standing in the College.

(2) A member is in good standing in the College for the purpose of subsection (1) where,

(a) he or she is not in default of payment of any fees prescribed by the regulations;

(b) his or her professional conduct is not the subject of disciplinary proceedings;

(c) his or her licence is not under suspension; and

(d) his or her licence is not subject to a term, condition or limitation. R.R.O. 1980, Reg. 450, s. 3.

4.—(1) The term of office of an elected member of the Council is three years.

(2) When an election of members of the Council is not held within the prescribed period, the members of the Council then in office shall continue in office until their successors are elected or appointed. R.R.O. 1980, Reg. 450, s. 4.

5.—(1) The election for an electoral district shall be held on or before the 1st day of April in the year in which the term of office of the member or members elected from the electoral district expires.

(2) The date of each election shall be set by the Council and elections shall be carried out under the supervision of the Registrar.

(3) Where there is an interruption of mail service during a nomination or election, the Registrar shall extend the holding of nominations and election for such minimum period of time as the Registrar considers necessary to compensate for the interruption. R.R.O. 1980, Reg. 450, s. 5.

6. Nomination forms shall be mailed by the Registrar to all members qualified to vote in the electoral district in which an election is to be held, at least forty-five days before the date of the election. R.R.O. 1980, Reg. 450, s. 6.

7.—(1) The nomination of candidates for election as members of the Council shall be,

(a) in writing;

(b) in the nomination form that shall be provided by the Registrar; and

(c) signed by a proposer and a seconder both of whom shall be members engaged in the practice of optometry in the electoral district for which the candidate has been nominated.

(2) The nomination form shall have the candidate's consent signed thereon and shall be filed with the Registrar at least thirty days before the date of the election.

(3) The Registrar shall notify without undue delay, after nomina-

tions have been closed, all nominated candidates of the members nominated and a candidate may withdraw his or her candidacy by notice of withdrawal delivered to or received by the Registrar not later than twenty-two days before the date of the election. R.R.O. 1980, Reg. 450, s. 7.

8. Voting for elections of members to the Council shall be by mail ballot. R.R.O. 1980, Reg. 450, s. 8.

9. Ballot forms, together with blank envelopes therefor, shall be mailed by the Registrar to all members qualified to vote in the electoral district in which an election is to be held at least ten days before the date of the election. R.R.O. 1980, Reg. 450, s. 9.

10.—(1) A ballot shall be marked in the appropriate space with an "X" for the candidate of the voting member's choice, shall be sealed in the blank envelope supplied and shall be inserted and sealed in the outer envelope supplied and the outer envelope shall bear the voting member's signature and address.

(2) A ballot that does not comply with subsection (1) shall be deemed to be null and void. R.R.O. 1980, Reg. 450, s. 10.

11. Only ballots received by the Registrar on or before 4 p.m. of the day before the date of the election shall be counted by the Registrar or his or her designated agent. R.R.O. 1980, Reg. 450, s. 11.

12. On the date of an election, the sealed blank envelopes containing the ballots for the election shall be opened and the ballots counted by the Registrar or his or her designated agent. R.R.O. 1980, Reg. 450, s. 12.

13. Representatives of the candidates in an election may be present when the sealed blank envelopes are opened and the ballots counted. R.R.O. 1980, Reg. 450, s. 13.

14. In the event that candidates in an election receive an equal number of votes, the President of the College shall cast the deciding vote but where the President is a candidate, the Vice-President shall cast the deciding vote. R.R.O. 1980, Reg. 450, s. 14.

15. Where only one candidate for election to the Council is nominated in an electoral district, the Registrar shall declare the candidate elected as the member of the Council for that electoral district. R.R.O. 1980, Reg. 450, s. 15.

16.—(1) The Registrar shall destroy all ballots thirty-one days after the announcement of the results of an election unless a candidate challenges the election or its results.

(2) Within thirty days from the date of the counting of ballots, a candidate may require a recount of the ballots of the electoral district in which he or she was nominated, on depositing with the Registrar the sum of \$150 and a written request for the recount.

(3) Where a recount has been requested, the Registrar shall appoint the time and place and arrange for the recount which shall take place within fifteen days from the date of the request and shall be conducted, subject to subsection (4), in the same manner as the original counting of the ballots and the candidate or a representative appointed by the candidate may be present at the recount.

(4) The recount shall be conducted by two scrutineers appointed by the President of the College.

(5) The portion of the deposit of \$150 remaining after payment of the actual cost to the College of conducting the recount shall be returned to the person who paid the deposit but if the recount changes the result of the election the full amount of the deposit shall be returned to the person who paid the deposit. R.R.O. 1980, Reg. 450, s. 16.

17.—(1) An elected member of the Council is disqualified from sitting on the Council and the seat of the member on the Council shall be deemed to be vacant if the member,

- (a) is found to be an incapacitated member;
- (b) is found guilty of professional misconduct or incompetence;
- (c) fails to attend without cause three consecutive meetings of a committee or the Council; or
- (d) ceases to practise in the electoral district for which he or she was elected. R.R.O. 1980, Reg. 450, s. 17 (1), *revised*.

(2) Where an elected member of the Council dies or resigns or his or her seat otherwise becomes vacant before the expiry of his or her term of office, the Council shall,

- (a) where the unexpired term of the member whose seat became vacant does not exceed two years, appoint a successor from among the members of the College in the electoral district represented by the member whose seat on the Council became vacant; or
- (b) where the unexpired term of office of the member whose seat became vacant exceeds two years, direct the Registrar to hold a by-election in accordance with the provisions of this Regulation for the electoral district which the member represented,

and the appointed or elected successor shall serve until the expiry of the term of office of the member whose seat became vacant. R.R.O. 1980, Reg. 450, s. 17 (2).

18.—(1) The requirements and qualifications for the issuing of a licence to an applicant are,

- (a) completion of an application for a licence in a form that shall be supplied by the Registrar;
- (b) one of the following,
 - (i) successful completion of the course in optometry at the School of Optometry of the University of Waterloo and the award of the degree of doctor of optometry by the University,
 - (ii) successful completion of a course considered by the Registration Committee to be comparable to the course at the School of Optometry of the University of Waterloo and the award of a degree comparable to the degree of doctor of optometry of the University of Waterloo,
 - (iii) engaging in the practice of optometry in good standing with the licencing body in the jurisdiction in which the applicant is practising and graduation from a course in Optometry deemed by the Registration Committee to be comparable to the course of the School of Optometry of the University of Waterloo;
- (c) reasonable fluency in the English or French language;
- (d) evidence, where the applicant has previously practised optometry, that there has been no finding of, and that there is no current proceeding involving an allegation of, professional misconduct, incompetence or incapacitation or any like finding or proceeding against the applicant;
- (e) evidence that the applicant has not been convicted of an offence that affects the fitness of the applicant to engage in the practice of optometry;
- (f) Canadian citizenship, permanent resident status under the *Immigration Act* (Canada) or a special authorization under clause 10 (c) of that Act;
- (g) successful completion of the examinations set or approved by the Council at the time of the application, except with

respect to an applicant who holds a full-time appointment as a professor, resident, supervising clinician or graduate student at the School of Optometry, University of Waterloo; and

- (h) payment of the examination and licence fees prescribed by this Regulation. R.R.O. 1980, Reg. 450, s. 18 (1); O. Reg. 586/88, s. 1.

(2) A licence shall be in Form 1. R.R.O. 1980, Reg. 450, s. 18 (2).

19.—(1) Subject to subsection (2), the name of the member entered in the register and used on the licence shall be the same as the name of the member in the documentary evidence of the member's degree in optometry or a degree that is equivalent to a degree in optometry.

(2) The Registrar shall issue a licence or direct the entry of a name in other than the name required by subsection (1) if the applicant or the member applies, and in the case of a member, returns the current licence of the member, and deposits with the Registrar,

- (a) a certified copy of an order of a court of competent jurisdiction changing the name of the applicant or member;
- (b) a certified copy of a valid certificate of marriage or of a decree absolute of divorce from a court with respect to the applicant or member; or
- (c) documentary evidence as to the use of the name requested,

or any combination of material referred to in clause (a), (b) or (c) and satisfies the Registrar that the use of the name requested is not for any improper purpose. O. Reg. 586/88, s. 2.

20.—(1) It is a condition of every licence, where the holder of the licence has not engaged on a regular basis in the practice of optometry for a period of three years, that the holder not engage in the practice of optometry until the competency of the holder is reviewed by the Registration Committee.

(2) It is a condition of every licence that is issued to an applicant who is exempted by the Registration Committee from clause 18 (1) (g) and who holds a full-time appointment as a professor, resident, supervising clinician or graduate student at the School of Optometry, University of Waterloo, that the licence is valid only while the applicant holds a full-time appointment as a professor, resident, supervising clinician or graduate student at the said School and performs acts in the practice of optometry as part of his or her duties or requirements as a full-time appointee. O. Reg. 536/88, s. 3.

21.—(1) The Registrar shall mail to each member an annual report form and a fees payment form at least thirty days before the due date for payment of annual fees.

(2) The Registrar shall issue a receipt to a member upon receipt of the member's completed annual fees payment form and annual fee. R.R.O. 1980, Reg. 450, s. 20.

22.—(1) A person whose licence has been cancelled by the Registrar for non-payment of the annual fee may make application to have the licence reissued by the Registrar upon payment of all outstanding fees, together with a penalty fee of \$25, provided a period of not more than two years has elapsed from the date of cancellation of the licence.

(2) A member whose licence has been suspended shall pay all outstanding fees before resuming the practice of optometry. R.R.O. 1980, Reg. 450, s. 21.

23. The registers for members maintained by the Registrar may be inspected by any person during normal business hours. R.R.O. 1980, Reg. 450, s. 22.

24. A member in the practice of optometry shall exercise generally accepted standards of practice and procedures in the determination of the physical, optical, sensory and oculomotor state of the eye and adnexa and in the assessment and care of a patient's vision and shall,

- (a) record the case history, all clinical procedures used and findings obtained and the counsel given and treatment provided in the assessment and management of the patient's vision performance; and
- (b) have in his or her office the usual and necessary instruments, equipment and physical facilities for the provision of the diagnostic and treatment services performed by the member. R.R.O. 1980, Reg. 450, s. 23.

25. The following drugs may be used in the practice of optometry for the purposes specified:

1. Topical anaesthetics: proparacaine not over 0.5 per cent and benoxinate not over 0.4 per cent for facilitating the measurement of intraocular pressure and for facilitating contact lens applications.
2. Mydriatic: tropicamide not over 0.5 per cent for facilitating the observation of the fundus of the eye when clinically required.
3. Cycloplegic: cyclopentolate hydrochloride not over 0.5 per cent for determining the refractive status of the eye when clinically required. O. Reg. 47/87, s. 1.

26.—(1) In this section, "member of his or her family" means any person connected with a member by blood relationship, marriage or adoption, and

- (a) persons are connected by blood relationship if one is the child or other descendant of the other or one is the brother or sister of the other;
- (b) persons are connected by marriage if one is married to the other or to a person who is connected by blood relationship to the other; and
- (c) persons are connected by adoption if one has been adopted, either legally or in fact, as the child of the other or as the child of a person who is so connected by blood relationship (otherwise than as a brother or sister) to the other.

(2) A member shall not engage in the practice of optometry where the member has a conflict of interest.

(3) It is a conflict of interest for a member where a member or a member of his or her family,

- (a) accepts rebates or gifts from a vendor of ophthalmic appliances, materials or equipment or from a person licensed or registered under any Act regulating a health discipline;
- (b) accepts credit from a vendor of ophthalmic appliances, materials or equipment, or from a person licensed or registered under any Act regulating a health discipline except where the terms of the credit provide a reasonable time for repayment, a reasonable rate of interest on the amount outstanding at any time during the period of credit, and the credit is not related to the referral of patients to the creditor;
- (c) rents or makes available premises to a tenant who is a person licensed or registered under any Act regulating a health discipline except at a rent normal for the area in which the premises are located and the amount of the rent is not related to the volume of business carried out in the premises by the tenant; or

(d) rents or uses any premises from a vendor of ophthalmic appliances, materials or equipment or from a person who has any association with such vendor, or from a person licensed or registered under any Act regulating a health discipline except at a rent normal for the area in which the premises are located and the amount of the rent is not related to the referral of patients to the landlord or to the referral of patients by the member or the amount of fees charged by the member. R.R.O. 1980, Reg. 450, s. 25 (1-3).

(4) It is a conflict of interest for a member to,

- (a) share fees with any person who has referred a patient or receive fees from any person to whom the member has referred a patient or to engage in any form of fee sharing, rebates or other indirect remuneration;
- (b) issue a statement or receipt to a patient or to a third party responsible for the payment of the account of a patient which does not itemize the service provided and the fees therefor or does not describe the ophthalmic appliances utilized by the member in the performance of the service or does not set out the laboratory costs incurred by the member in the provision of the service;
- (c) engage in the practice of optometry where any of the public entrances or exits of the member's premises are within the premises of a retail merchant, optical company or ophthalmic dispenser or interconnecting therewith;
- (d) charge or receive for an ophthalmic appliance payment in excess of the laboratory costs incurred by the member in the provision of the service provided by the member;
- (e) engage in the practice of optometry in association, partnership or otherwise with or while employing or under the employment of a vendor of ophthalmic appliances or an ophthalmic dispenser registered under the *Ophthalmic Dispensers Act* or with any other person or corporation other than,
 - (i) with a member who is engaged in the practice of optometry,
 - (ii) with a legally qualified medical practitioner who is engaged in the practice of medicine provided that such practice is not inconsistent with Part V of the Act or regulations or by-laws,
 - (iii) as an employee or agent of a municipal or other government, agency of a municipal or other government, a university, hospital,
 - (iv) with a community health centre if the employment or any arrangement has been approved by Council, or
 - (v) with a corporation for the sole purpose of providing optometrical counsel and service to the employees of the corporation; or
- (f) own or financially benefit from the operation of a company, firm or business that manufactures, fabricates, supplies or dispenses ophthalmic appliances. R.R.O. 1980, Reg. 450, s. 25 (4); O. Reg. 478/82, s. 1.

(5) Despite clauses (4) (c) and (e) a member may continue to engage in the practice of optometry in the employment of the retail merchant who operates an optical department where the member had been so employed for a continuous period of fifteen years on the 28th day of June, 1974 provided the member has filed with the Registrar a statutory declaration that the member has been so employed. R.R.O. 1980, Reg. 450, s. 25 (5).

27.—(1) For the purposes of Part V of the Act, “professional misconduct” means:

1. Failure by a member to abide by the terms, conditions or limitations of his or her licence.
2. Failure to maintain the standard of practice of the profession.
3. Failure to maintain the records that are required to be kept in respect of a member’s patients or practice.
4. Exceeding the lawful scope of practice.
5. Using or having in the member’s place of practice drugs other than those prescribed or using drugs for purposes other than those specified in this Regulation.
6. Having a conflict of interest.
7. Using terms, titles or designations other than those authorized, or using terms, titles or designations that are prohibited by this Regulation.
8. Treating or attempting to treat a vision problem which the member recognizes or should have recognized as being beyond his or her experience or competence.
9. Failure of a member to refer a patient to a legally qualified medical practitioner when the member recognizes or should have recognized a condition of the eye or adnexa that appears to require medical examination.
10. Permitting, counselling or assisting any person who is not licensed under Part V of the Act to engage in the practice of optometry except as provided for in the Act or this Regulation.
11. Using in any way with respect to the member’s office the name of another member whose practice the member has acquired after a period of three years from the date of the acquisition.
12. Practising or holding out that the member is engaged in the practice of optometry or is associated in the practice of optometry in more than three offices or locations unless the Council has approved so doing.
13. Changing fees that are in excess of the schedule of fees of the Ontario Association of Optometrists without prior notification to the patient as to the excess amount of the fee.
14. Charging fees that are excessive in relation to the services performed.
15. Charging a fee for a service that is not performed.
16. Accepting a credit card to obtain payment for an optometrical service,
 - i. that is prescribed as an insured service under Regulation 552 of Revised Regulations of Ontario, 1990 (General), or
 - ii. prior to rendering the optometrical service.
17. Accepting a credit card other than one defined in subsection (3) to obtain payment for an optometrical service.
18. Requesting payment for a service that is insured under the *Health Insurance Act* before providing a completed claim card for submission under that Act or before providing an itemized account of the service where a request is made for an itemized account by the patient or a representative of the patient.
19. Publishing, displaying, distributing or using or permitting, directly or indirectly, the publishing, display, distribution or use of any advertisement related to the practice of optometry by a member other than,
 - i. professional cards that contain only the name of the member, the vocational designation, the member’s address, academic degrees, telephone number and office hours,
 - ii. a professional card in a newspaper or a weekly or monthly periodical where the the professional card,
 - A. does not exceed one standard newspaper column in width and five centimetres in depth including the margins,
 - B. is not part of an advertisement containing a reference to ophthalmic appliances, and
 - C. does not appear more than twice in any one issue of the newspaper or periodical,
 - iii. appointment cards that do not contain more than the information contained in a professional card and the time and date of the appointment or appointments,
 - iv. reminder notices to patients,
 - v. announcement cards that do not state more than the information contained in a professional card and an announcement of the commencement of the practice of optometry, a change of location or a new association in practice,
 - vi. one sign on the premises where the member is engaged in the practice of optometry, stating the name of the member and his or her vocational designation with lettering on the sign that does not exceed twenty centimeters in diagonal measurement,
 - vii. door plates and listings on building directories on the premises where the member is engaged in the practice of optometry.
20. Associating with or being employed by any person who published, displays, distributes or uses any advertisement related to the practice of optometry by the member other than that which is provided for by paragraph 19.
21. Signing or issuing a certificate, report or similar document that contains a statement the member knows or ought to know is false, misleading or otherwise improper.
22. Signing or issuing a certificate, report or similar document that withholds statements or information the member knows or ought to know should be disclosed to the person to whom the member knows or ought to know the document will be delivered or to whom its contents will be made known.
23. Giving information concerning a patient’s vision to any person other than the patient without the consent of the patient unless required to do so by law.
24. Failing to provide within a reasonable time any report or certificate requested by a patient in respect of an examination or treatment provided by the member.
25. Knowingly submitting a false or misleading account or false or misleading charges for services tendered to a patient.
26. Falsifying a record in respect of observation or treatment of a patient.

27. Making a misrepresentation with respect to a remedy, treatment or device.
28. Failure to carry out the terms of an agreement with a patient.
29. Failure to continue to provide professional service to a patient until the services are no longer required or until the patient has had a reasonable opportunity to arrange for the services of another member.
30. Failure to make arrangements with a patient for access to or for transfer of the records of the patient when the member changes office location or retires from practice.
31. Refusal to allow an authorized representative of the Council to enter at a reasonable time the office in which the member is engaged in the practice of optometry for the purpose of inspecting the member's professional records and equipment.
32. Conviction of an offence that affects the fitness of a member to engage in the practice of optometry.
33. Engaging in the practice of optometry while the ability to perform any professional act is impaired by alcohol or a drug.
34. Sexual impropriety with a patient.
35. Failure to make available to a patient a written prescription for an ophthalmic appliance for the patient containing all necessary and relevant clinical and ophthalmic specifications.
36. Providing other than a new contact lens to a patient.
37. Displaying or permitting the display of ophthalmic appliances that can be seen from the exterior of the premises in which a member is engaged in the practice of optometry.
38. The contravention of any provision of Part V of the Act or of the regulations or the *Health Insurance Act*.
39. Conduct or an act relevant to the practice of optometry that, having regard to all the circumstances, would reasonably be regarded by members as disgraceful, dishonourable or unprofessional. R.R.O. 1980, Reg. 450, s. 26; O. Reg. 586/88, s. 4 (1-3).
- (2) Subparagraph ii of paragraph 16 of subsection (1) does not apply to the payment of a laboratory fee that is incurred by a member in connection with an optometrical service or services that may be rendered.
- (3) For the purposes of subsection (1), "credit card" means a credit card that is accepted by a member pursuant to a standard form of agreement that requires the provider of the credit card to rely upon the provider's contract with the card holder or card sales slip to enforce payment of money owed and not upon a member's patient records. O. Reg. 586/88, s. 4 (4).
- 28.—(1) A member shall participate in the program of continuing education that is provided related to the maintenance of the member's standard of competence at least once in each three years and shall report upon such participation on an annual basis upon the request of the Registrar.
- (2) A member who fails to participate in the program of continuing education referred to in subsection (1) shall be referred by the Registrar to the Registration Committee for review of the qualifications of the member. R.R.O. 1980, Reg. 450, s. 27.
- 29.—(1) The Council shall appoint annually an Appraisal Committee composed of,
- (a) two members of the Council; and
- (b) three members of the College, of whom two shall be members of the faculty of the School of Optometry of the University of Waterloo and one shall be a practising optometrist who is not a member of the Council.
- (2) The Council shall name one member of the Appraisal Committee as the chair.
- (3) A majority of the members of the Appraisal Committee constitutes a quorum.
- (4) The Appraisal Committee shall report not less than once a year to the Council and make recommendations concerning the standard of practice in the profession.
- (5) The Appraisal Committee, for the purpose of examining and assessing the standard of practice in the profession and the standards of practice of members,
- (a) may cause general inspections to be made by appointment and at reasonable hours of the records of members and the equipment used by them in the practice of optometry;
- (b) may make such recommendation to a member as the Committee considers necessary respecting the member's standards of practice, equipment and record keeping. R.R.O. 1980, Reg. 450, s. 28 (1-5).
- (6) Where a member fails within a reasonable time to comply with a recommendation of the Appraisal Committee, the Committee shall report its findings and may make recommendations to the Registration Committee or Registrar in respect thereof. O. Reg. 586/88, s. 5.
- 30.—(1) A member, in the practice of optometry, shall use his or her name and the vocational designation "optometrist" on all printed material and signs associated with his or her practice and office but may use academic degrees in association with the member's name.
- (2) A member may use the designation "Dr." or the title "Doctor" on printed office material, published material or office signs in respect of the member's practice provided the member has the academic right to the title by reason of a degree conferred by the University of Waterloo or by an academic institution that provided a course comparable to that given by the University of Waterloo and accredited by the College.
- (3) A member may list his or her name and office address or addresses once only in light face upper and lower case type under the heading "Optometrists" in the classified section of a telephone directory and may use a geographical street location in association with this listing but a member shall not list his or her name under a "By District" or similar heading in the classified section of a telephone directory. R.R.O. 1980, Reg. 450, s. 29.
- 31.—(1) The Discipline Committee shall publish or cause to be published its decisions and the reasons for its decisions in the original or a summary form and,
- (a) the identity of the member shall be made known if the member's licence has been revoked, suspended or restricted;
- (b) the identity of the member shall be made known if the committee has reprimanded the member and directed the fact of such reprimand to be recorded on the register;
- (c) the identity of the member shall not be made known if the Committee has reprimanded the member but not directed that the fact of such reprimand be recorded on the register or has suspended or postponed imposition of a penalty, unless the council directs that the identity of the member shall be known; and

(d) the identity of the member shall not be made known if the member has been found not guilty of professional misconduct or incompetence, unless the member requests in writing that he or she be identified.

(2) The Registrar may communicate the decision of the Discipline Committee to any complainant and any witness who testified at the hearing if the complainant or witness so requests and the Registrar may also provide any other information the Registrar considers reasonably necessary to explain the proceedings and the decision to the complainant or witness, including copy of any written reasons of the Committee. O. Reg. 586/88, s. 6.

32. The Council shall determine the information required for the compilation of statistics with respect to the supply, distribution and professional activities of members and may direct the Registrar to obtain the required information. R.R.O. 1980, Reg. 450, s. 31.

33. The information required for the compilation of statistics may include particulars of the age, sex and anomalies of vision of patients, and the patient case-load of and the referral of patients by members. R.R.O. 1980, Reg. 450, s. 32.

34. Upon the written request of the Registrar, members shall provide to the Registrar the information requested for the compilation of statistics. R.R.O. 1980, Reg. 450, s. 33.

35. The Registrar is the chief administrative officer of the College and is subject to the direction of the Council. R.R.O. 1980, Reg. 450, s. 34.

36. A member shall permit the inspection and examination of the member's office, records and equipment in connection with his or her practice of optometry by inspectors appointed for the purposes of Part V of the Act or by the Registrar or a person appointed as an inspector under subsection 37 (1) of the *Health Insurance Act*. R.R.O. 1980, Reg. 450, s. 35.

37.—(1) Every member shall make and keep legible clinical and financial records with respect to each patient of the member that shall contain at least,

- (a) the name and address of the patient;
- (b) the date of each visit of the patient;
- (c) the patient's medical history;
- (d) the examination procedures used on the patient;
- (e) the clinical findings obtained with respect to the patient;
- (f) the diagnosis with respect to the patient;
- (g) the treatment prescribed and provided for the patient;
- (h) the advice given to the patient; and
- (i) the members' fees and charges to the patient.

(2) Every member shall keep a day book, daily diary or appointment record that sets out the name of each patient examined or treated or in respect of whom any professional service is rendered by the member.

(3) Every member shall keep the records required under subsections (1) and (2) in a systematic manner and shall retain each record for a period of at least six years after the date of the last entry in the record or until the member ceases to engage in the practice of optometry, whichever first occurs. O. Reg. 586/88, s. 7.

38. The fee for a licence is \$100. R.R.O. 1980, Reg. 450, s. 37.

39. The fee for each examination subject is \$150. O. Reg. 353/90, s. 1.

40. The annual fee for a member is \$325 and is due and payable on or before the 15th day of December in each year for the following year. O. Reg. 586/88, s. 8.

41. Where a member fails to complete and deliver to the Registrar an annual fees payment form and the annual fee on or before the 31st day of December in any year, the member shall pay a penalty fee of \$25 in addition to the annual fee. R.R.O. 1980, Reg. 450, s. 40.

42.—(1) A member who,

- (a) has been registered for a period of twenty-five years under Part V of the Act or a predecessor thereof;
- (b) at the time of application by the member to the Registration Committee is in good standing; and
- (c) has retired from the practice of optometry,

may, upon written request to the Registrar, be designated a member emeritus by the Registration Committee. O. Reg. 586/88, s. 9 (1), *part, revised*.

(2) A member emeritus is entitled to remain on the register of the College, is not required to pay any fees and is not entitled to engage in the practise of optometry. O. Reg. 586/88, s. 9 (2), *part*.

Form 1

Health Disciplines Act

LICENCE FOR THE PRACTICE OF OPTOMETRY

College of Optometrists of Ontario

This is to certify that

.....
(name)

is duly licensed as a member of the College and is entitled to engage in the practice of optometry.

Given under the Corporate Seal of the College at
Toronto this day of, 19.....

(Seal) ·
President

Licence Number
Registrar

R.R.O. 1980, Reg. 450, Form 1.

REGULATION 551

PHARMACY

DEFINITIONS

1. In this Regulation,

“external application” means application to the outer surface of the body;

“internal use” means local or systemic absorption upon introduction into the body by the parenteral route or through a body orifice;

“preceptor” means,

- (a) a pharmacist who has acted as a pharmacist engaged in the

compounding and dispensing of pharmaceutical preparations and prescriptions in a pharmacy or hospital in Ontario for not less than six months, and is engaged full time in the practice of a pharmacist in a pharmacy or hospital in which not less than 3,000 prescriptions are dispensed annually and in the library of which there are, in addition to the texts and materials required by this Regulation, current editions of two journals related to the practice of pharmacists, or

- (b) a person who holds a degree in pharmacy and is designated as a preceptor by the Registration Committee of the Ontario College of Pharmacists;

“safe medication” for the purpose of the Schedules means medication in a dose or doses within the usual therapeutic limits of dosage for a drug named in the following publications:

1. Pharmacopoeia Internationalis, 2nd ed. 1967
2. The Canadian Formulary, 7th ed. 1949
3. The British Pharmacopoeia, 1973 and addendum 1975
4. The British Pharmaceutical Codex, 1973 and supplement 1976
5. The European Pharmacopoeia,
 - Volume I 1969
 - Volume II 1971
 - Volume III 1975 and Supplement 1977
6. The *Food and Drugs Act* (Canada) and the regulations thereunder
7. The Pharmacopoeia of the United States of America, XIX ed. and 3rd Supplement 1977
8. Martindale, The Extra Pharmacopoeia, 27th ed. 1977
9. The National Formulary, 14th ed. and 3rd Supplement 1977
10. AMA Drug Evaluations, 3rd ed.
11. Pharmacopée Française, VIII ed. 1965 and supplement 1968
12. Pediatric Dosage Handbook (American Pharmaceutical Association), 1973;

“Schedule G preparation” means a drug that contains one drug referred to in Schedule G and one or more active medicinal ingredients not referred to in Schedule G in a recognized therapeutic dose or a drug that contains as the only medicinal ingredient phenobarbital or any of its salts in an amount not exceeding 32.4 milligrams per unit dosage;

“Schedule N preparation” means a drug that,

- (a) contains one drug referred to in Schedule N and two or more active medicinal ingredients not referred to in Schedule N in a recognized therapeutic dose, and
- (b) is not intended for parenteral administration;

“sell” includes offer to sell, dispense, distribute, give away and supply. R.R.O. 1980, Reg. 451, s. 1.

2.—(1) For the purpose of the election of members to the Council, the following electoral districts are established:

1. Number 1, composed of the counties of Dundas, Glengarry, Grenville, Lanark, Leeds, Prescott, Renfrew, Rus-

sell, Stormont and The Regional Municipality of Ottawa-Carleton.

2. Number 2, composed of the counties of Frontenac, Hastings, Lennox and Addington, Northumberland, Peterborough, Prince Edward and Victoria, the County of Haliburton and The Regional Municipality of Durham.
3. Number 3, composed of that portion of The Municipality of Metropolitan Toronto east of Greenwood Avenue and Don Mills Road.
4. Number 4, composed of that portion of The Municipality of Metropolitan Toronto west of and including Greenwood Avenue and Don Mills Road to York Street, University Avenue north of Queen Street, Queen’s Park, Avenue Road as far north as Highway 401, and north of Highway 401 to Bathurst Street.
5. Number 5, composed of that portion of The Municipality of Metropolitan Toronto west of and including York Street, University Avenue north of Queen Street, Queen’s Park, Avenue Road as far north as Highway 401, and Bathurst Street north of Highway 401 to Parkside Drive and Keele Street.
6. Number 6, composed of that portion of The Municipality of Metropolitan Toronto west of and including Parkside Drive and Keele Street, and, in addition, that part of The Regional Municipality of Peel comprising the City of Mississauga.
7. Number 7, composed of the County of Simcoe, The Regional Municipality of York and the territorial districts of Muskoka and Parry Sound.
8. Number 8, composed of the regional municipalities of Halton and Hamilton-Wentworth and that part of The Regional Municipality of Haldimand-Norfolk formerly known as the County of Haldimand except that part comprising the Town of Dunnville.
9. Number 9, composed of The Regional Municipality of Niagara and that part of The Regional Municipality of Haldimand-Norfolk comprising the Town of Dunnville.
10. Number 10, composed of the counties of Elgin, Middlesex and Oxford.
11. Number 11, composed of the counties of Essex, Kent and Lambton.
12. Number 12, composed of the County of Brant, The Regional Municipality of Waterloo, that part of The Regional Municipality of Haldimand-Norfolk formerly known as the County of Norfolk and the County of Wellington except those parts comprising the townships of Arthur, Maryborough, Minto and West Luther.
13. Number 13, composed of the counties of Bruce, Dufferin, Grey, Huron and Perth and those parts of the County of Wellington comprising the townships of Arthur, Maryborough, Minto and West Luther and those parts of The Regional Municipality of Peel comprising the Town of Calderon and the City of Brampton.
14. Number 14, composed of the territorial districts of Cochrane, Manitoulin, Nipissing, Sudbury and Timiskaming.
15. Number 15, composed of the territorial districts of Algoma, Kenora, Rainy River and Thunder Bay.

(2) One member shall be elected from among the members of the College whose principal place of practice on the 1st day of June immediately preceding the election is in a hospital in Ontario

approved or licensed under an Act of Ontario or of Canada, and such members shall be deemed to constitute an electoral district that shall be known as electoral district number 16. R.R.O. 1980, Reg. 451, s. 2.

3. One member shall be elected to the Council from each electoral district. R.R.O. 1980, Reg. 451, s. 3.

4.—(1) An election of members to the Council shall be held on the first Wednesday in August, 1981 and thereafter on the first Wednesday in August in every second year following the last preceding election.

(2) Where there is an interruption of mail service during an election, the Council shall extend the holding of the election for such minimum period of time as the Council considers necessary to compensate for the interruption. R.R.O. 1980, Reg. 451, s. 4.

5.—(1) The term of office of a member elected to Council is two years commencing at the first regular meeting of the Council following the member's election to the Council.

(2) When an election of members to the Council is not held within the prescribed period, the members of the Council then in office shall continue in office until their successors are elected or appointed. R.R.O. 1980, Reg. 451, s. 5.

6. A member of the College may vote only for a candidate in the electoral district in which his or her place of practice is located on the first day of June immediately preceding the election. R.R.O. 1980, Reg. 451, s. 6.

7. A member whose place of practice is located in more than one electoral district on the first day of June immediately preceding an election shall name one of the electoral districts as his or her principal place of practice and the member may vote only for a candidate in that electoral district. R.R.O. 1980, Reg. 451, s. 7.

8. A member who has no fixed place of practice may vote for a candidate only in the electoral district in which he or she resides on the 1st day of June immediately preceding an election. R.R.O. 1980, Reg. 451, s. 8.

9. A member whose principal place of practice on the 1st day of June immediately preceding an election is in a hospital in Ontario approved or licensed under an Act of Ontario or of Canada may vote only for a candidate as a member from among members in that electoral district. R.R.O. 1980, Reg. 451, s. 9.

10.—(1) A member is eligible for election to the Council who,

- (a) has his or her principal place of practice as a pharmacist in the electoral district for which he or she is nominated; and
- (b) is in good standing in the College.

(2) A member is in good standing in the College for the purpose of subsection (1) where,

- (a) the member is not in default of payment of any fees prescribed by the regulations or any fine imposed under Part VI of the Act;
- (b) the member's professional conduct is not the subject of disciplinary proceedings;
- (c) the member's licence is not under suspension; and
- (d) the member's licence is not subject to a term, condition or limitation other than one prescribed by the regulations. R.R.O. 1980, Reg. 451, s. 10.

11. Where an elected member of the Council,

- (a) is found to be an incapacitated member;

- (b) is found guilty of professional misconduct or incompetence;
- (c) fails to attend three consecutive regular meetings of the Council;
- (d) who was elected by electoral district number 16 ceases to practise as a pharmacist in electoral district number 16;
- (e) ceases to meet the requirements of section 10 for election to the Council,

the member is disqualified from sitting on the Council and the seat of the member on the Council shall be deemed to be vacant. R.R.O. 1980, Reg. 451, s. 11.

12. Where an elected member of the Council dies or resigns or his or her seat otherwise becomes vacant before the expiry of his or her term of office,

- (a) where the unexpired term of the member whose seat becomes vacant does not exceed six months, the Council shall appoint a successor from among the members of the College in the electoral district represented by the member whose seat in the Council is vacated and who are members in good standing in the College; or
- (b) where the unexpired term of office of the member whose seat becomes vacant exceeds six months, a by-election shall be held in accordance with this Regulation for the electoral district which the member represented within two months after the seat becomes vacant,

and the appointed or elected successor shall serve until the expiry of the term of office of the member whose seat becomes vacant. R.R.O. 1980, Reg. 451, s. 12.

13.—(1) The Council shall, at its last regular meeting before an election, appoint two scrutineers for the election who shall be members of the College in different electoral districts and who shall receive for their services such remuneration as the Council determines.

(2) In the event that a scrutineer is unable or unwilling to act, the President shall appoint a member of the College to act as a scrutineer in the place of the member unable or unwilling to act. R.R.O. 1980, Reg. 451, s. 13.

14. Not later than the 1st day of June in the year in which the election is to be held, the Registrar shall notify each member of the College of the date of the election by first class mail addressed to each member at his or her last address set out in the register of the College. R.R.O. 1980, Reg. 451, s. 14.

15.—(1) A candidate for election as a member of Council shall be nominated in writing by not less than three members eligible to vote in the electoral district for which the candidate is nominated.

(2) The nomination shall be signed by the nominators and shall be accepted in writing by the candidate.

(3) Where it is not possible for the candidate to accept the nomination on the nominating paper which has been signed by the nominators, the candidate shall forward his or her written acceptance forthwith to the Registrar.

(4) All nominations shall be filed with the Registrar not later than 4 o'clock standard time in the afternoon on the third Wednesday of June in the year in which the election is to be held. R.R.O. 1980, Reg. 451, s. 15.

16.—(1) The Registrar shall without undue delay after nominations have been closed give notice to all those nominated of the names of the members nominated.

- (2) A candidate may withdraw his or her candidacy by notice of

withdrawal delivered to or received by the Registrar not later than the 1st day of July in the year in which the election is to be held. R.R.O. 1980, Reg. 451, s. 16.

17. The names of those persons nominated and whose acceptance has been received and whose candidacy has not been withdrawn shall be set out in the ballot. R.R.O. 1980, Reg. 451, s. 17.

18. Where only one candidate has been nominated, no vote shall be taken and the candidate shall be deemed to be elected and the Registrar shall notify the candidate of his or her election. R.R.O. 1980, Reg. 451, s. 18.

19. The Registrar shall prepare for each electoral district in which there is more than one candidate a list of the persons shown by the records of the College on the 1st day of June of that year to be qualified to vote in the electoral district. R.R.O. 1980, Reg. 451, s. 19.

20. The Registrar shall prepare a sufficient number of suitable ballots for the election in each electoral district and the ballots shall be capable of being overlapped and sealed to show only the name and address of the voter. R.R.O. 1980, Reg. 451, s. 20.

21.—(1) On or after the 12th day of July and not later than the 15th day of July in the year in which an election is to be held, the Registrar shall forward by first class mail to each member eligible to vote in the election the appropriate ballot for his or her electoral district.

(2) A member qualified to vote who has not received a ballot or who has lost a ballot may apply to the Registrar for a ballot and file with the Registrar a statement of the non-receipt or loss verified by affidavit and the Registrar shall supply the member with a ballot.

(3) A ballot shall be marked in the appropriate space with an "X" for the candidate of the voting member's choice and shall be returned to the Registrar so that it shall be received by the Registrar not later than 4 o'clock standard time in the afternoon of the day of the election.

(4) Every ballot received by the Registrar on or before the time and date set out in subsection (3) shall be retained by the Registrar in its envelope unopened until the counting of votes, and every ballot received by the Registrar subsequent to such time and date shall be retained by the Registrar unopened and in a separate parcel marked "late" and with the date and time of receipt marked on the envelope. R.R.O. 1980, Reg. 451, s. 21.

22. The votes at an election shall be counted by the scrutineers at the office of the Registrar commencing at 9 a.m. of the day following the election day and continuing until the count is completed and the result determined. R.R.O. 1980, Reg. 451, s. 22.

23. Each envelope shall be opened in the presence of the scrutineers who shall ascertain that the voter is properly qualified according to a list that shall be furnished by the Registrar and the scrutineers shall then remove that portion of the ballot containing the signature of the voter without disclosing the marked ballot. R.R.O. 1980, Reg. 451, s. 23.

24. The vote shall be secret and so conducted that no person shall know for whom any member has voted. R.R.O. 1980, Reg. 451, s. 24.

25.—(1) The only persons entitled to be present at the counting of the ballots shall be the scrutineers, the Registrar, such clerical staff as the Registrar authorizes, and the candidates.

(2) A candidate may appoint one member of the College to represent the candidate at the counting of the ballots. R.R.O. 1980, Reg. 451, s. 25.

26. Where a tie vote occurs in an election, the scrutineers shall determine by lot the member who shall be declared elected to the Council. R.R.O. 1980, Reg. 451, s. 26.

27. In the case of a dispute between the scrutineers, the Registrar shall decide the matter. R.R.O. 1980, Reg. 451, s. 27.

28. Upon completion of the count, the scrutineers shall complete a return in duplicate setting out the number of votes cast for each candidate and the number of spoiled ballots and file the returns with the Registrar together with the ballots parcelled separately for each electoral district. R.R.O. 1980, Reg. 451, s. 28.

29.—(1) All ballots, the signature slips, the list of voters and one copy of the scrutineers' return shall be placed in one parcel that shall be retained by the Registrar who shall, in the presence of the scrutineers, seal the parcel with the seal of the College and mark on it a statement of the contents.

(2) The Registrar shall retain the parcel referred to in subsection (1) for a period of thirty days from the date of the counting of the ballots and thereafter shall destroy the parcel unless a member qualified to vote in the election requests a recount. R.R.O. 1980, Reg. 451, s. 29.

30.—(1) Upon the completion of the count and receipt of the returns of the scrutineers, the Registrar shall declare the member who has received the largest number of votes in each electoral district to be elected as a member of the Council and shall notify each candidate of the election results.

(2) The Registrar shall give notice in writing to successful candidates of the date of the next meeting of the Council. R.R.O. 1980, Reg. 451, s. 30.

31.—(1) Within thirty days from the date of the counting of the ballots at an election of a member to the Council, a member of the College qualified to vote at the election may require a recount of the ballots from the electoral district in which the member is qualified to vote, on depositing with the Registrar the sum of \$300 and a written request for the recount.

(2) Where a recount is requested, the Registrar shall appoint the time and place and arrange for the recount which shall take place within fifteen days from the date of the request and shall be conducted in the same manner as the original counting of the ballots except that the member who has requested the recount or a representative appointed by the member may be present at the recount.

(3) The recount shall be conducted by two persons appointed by the President of the College who have not acted as scrutineers in the election.

(4) If the recount changes the result of the election, the full amount of the deposit shall be returned to the person who paid the deposit. R.R.O. 1980, Reg. 451, s. 31.

32. The requirements and qualifications for the issuing of a licence to an applicant are,

- (a) the completion and filing with the Registrar of an application in a form that shall be supplied by the Registrar within three years after receiving the degree referred to in clause (b) or within two years of last practising as a licensed pharmacist in any jurisdiction in a pharmacy or in a hospital for a continuous period of twelve months;
- (b) the degree of Bachelor of Science in Pharmacy from the University of Toronto or such other degree as the Council considers equivalent to that degree or a degree in pharmacy with such additional training as is required for the holder of the degree to become eligible to write the examinations of the Pharmacy Examining Board of Canada;
- (c) successful completion of an examination in pharmaceutical jurisprudence approved by the Council;
- (d) a certificate of qualification issued by the Pharmacy Examining Board of Canada;

- (e) completion of twelve months of in-service training approved by the Council, while registered as a registered pharmacy student or intern;
- (f) reasonable fluency in the English or French language;
- (g) a statement verified by affidavit that the name of the applicant has not been removed from a pharmacy register in any jurisdiction, that the applicant has not been convicted of an offence under any Act regulating the practice of pharmacists or relating to the sale of drugs and that there are no current proceedings against the applicant for professional misconduct or for an alleged breach of any Act regulating the practice of pharmacists or relating to the sale of drugs;
- (h) Canadian citizenship or an immigrant visa or an employment visa under the *Immigration Act* (Canada);
- (i) payment of the licence fee prescribed by this Regulation; and
- (j) payment of the annual fee for a pharmacist prescribed by this Regulation. R.R.O. 1980, Reg. 451, s. 32; O. Reg. 581/89, s. 1.

33. An applicant for registration as a registered pharmacy student who,

- (a) is reasonably fluent in the English or French language;
- (b) produces evidence that he or she,
 - (i) has been accepted as a student in the Faculty of Pharmacy of the University of Toronto,
 - (ii) has been accepted as a student in pharmacy at a university whose degree is considered by the Registration Committee to be equivalent to the degree of Bachelor of Science in Pharmacy of the University of Toronto, or
 - (iii) has obtained a degree in pharmacy in a jurisdiction other than Ontario and has been required or permitted by the Registration Committee to complete a period of in-service training;
- (c) produces evidence in a form satisfactory to the Registrar that he or she has been accepted for in-service training by a preceptor;
- (d) pays the registration fee prescribed by this Regulation; and
- (e) applies in writing in a form that shall be supplied by the Registrar,

shall be registered as a registered pharmacy student. R.R.O. 1980, Reg. 451, s. 33.

34. Every registered pharmacy student who,

- (a) has been granted the degree of Bachelor of Science in Pharmacy by the University of Toronto or such other degree as may be considered by the Registration Committee to be equivalent to the degree of Bachelor of Science in Pharmacy of the University of Toronto or a degree in pharmacy with such additional training as is required for the holder of the degree to become eligible to write the examinations of the Pharmacy Examining Board of Canada;
- (b) has served as a registered pharmacy student for eight months;
- (c) has paid the fee prescribed by this Regulation; and

- (d) applies in writing in a form that shall be supplied by the Registrar,

shall be registered as an intern. R.R.O. 1980, Reg. 451, s. 34.

35.—(1) The registration of a registered pharmacy student or intern is revoked,

- (a) where he or she fails within one year after registration as a registered pharmacy student to commence the courses of study leading to the degree of Bachelor of Science in Pharmacy of the University of Toronto or equivalent degree elsewhere;
- (b) where he or she fails to attend the courses of study referred to in clause (a) for two consecutive years after having commenced them;
- (c) where, for any reason, he or she is refused readmission to a course of study; or
- (d) where he or she fails, within two years after obtaining the degree of Bachelor of Science in Pharmacy of the University of Toronto to complete in-service training or, where not having such a degree, he or she fails to complete in-service training within three years after having commenced such training.

(2) Where the registration of a registered pharmacy student or intern is revoked in circumstances caused by reason of accident, illness or other cause beyond his or her control, the Registration Committee may, upon application, restore the registration. R.R.O. 1980, Reg. 451, s. 35.

36. A registered pharmacy student shall complete in-service training under a preceptor for a term of not less than twelve months of which,

- (a) not less than four months shall be served after having been granted the degree of Bachelor of Science in Pharmacy by the University of Toronto or such other degree as may be considered by the Registration Committee to be equivalent to the degree of Bachelor of Science in Pharmacy of the University of Toronto; and
- (b) four months may be served as an intern. R.R.O. 1980, Reg. 451, s. 36.

37. A preceptor shall not undertake the in-service training of more than one person at any one time unless authorized by the Registration Committee. R.R.O. 1980, Reg. 451, s. 37.

38. Every preceptor shall, upon completion of the term of in-service training of a pharmacy student or intern or upon termination of the training for any cause, furnish the College on behalf of the registered pharmacy student or intern within seven days with a declaration of training in a form that shall be supplied by the Registrar. R.R.O. 1980, Reg. 451, s. 38.

39. The Registrar shall issue to every registered pharmacy student and every intern a certificate of registration as a registered pharmacy student or intern and the certificate,

- (a) is evidence of registration as a registered pharmacy student or intern, as the case may be; and
- (b) shall be returned to the Registrar upon request if the registration is revoked. R.R.O. 1980, Reg. 451, s. 39.

40. The register or registers maintained by the Registrar shall be open for inspection by any person during normal business hours. R.R.O. 1980, Reg. 451, s. 40.

41. A member, in the practice of a pharmacist, shall use only a vocational designation set out in paragraph 1, 2, 3, 4 or 5 of subsec-

tion 125 (2) of the Act but may use academic degrees in association with the member's name. R.R.O. 1980, Reg. 451, s. 41.

42.—(1) A member or a person operating a pharmacy shall not, directly or indirectly, in respect of a pharmacy in which the member acts as a pharmacist or in respect of the pharmacy that the person operates,

(a) use or permit the use in or about the pharmacy of descriptive information in respect of prescription services of the pharmacy other than,

(i) the words:

1. Prescriptions.
2. Prescription services.
3. Prescription department.
4. Dispensary.
5. Professional services.
6. Professional department.
7. Medication record service available.
8. Delivery service, and

(ii) signs that,

- (A) indicate the hours when prescription services are available,
- (B) identify the pharmacist,
- (C) identify prescription programs in which the person operating the pharmacy participates, and
- (D) are required to be posted under the *Prescription Drug Cost Regulation Act*;

(b) advertise, or permit the advertising, by any means, of the prescription services of the pharmacy other than by means of one or more of,

(i) professional cards that contain not more than the name of the member, a vocational designation, the member's address, academic degrees, telephone number, business hours, the name of the pharmacy where the member acts as a pharmacist, the words "prescriptions", "prescription services" or "delivery service" and identification of prescription programs in which the person who operates the pharmacy participates,

(ii) announcement cards that contain not more than all or part of the information in a professional card and announce,

- (A) the commencement of the practice of a pharmacist,
- (B) a change of name or location of a pharmacy,
- (C) a new association in practice of pharmacists, or
- (D) a change of employment of a pharmacist,

(iii) door plates and directory listings on the premises where the member acts as a pharmacist or the person

operates the pharmacy that contain not more than the information in a professional card,

(iv) printed directory listings that,

- (A) contain not more than the information in a professional card,
- (B) do not exceed one standard directory alphabetical listing column in width and 7.5 centimetres in depth including the margins,
- (C) do not appear more than twice in any one issue of the publication, and
- (D) do not appear in an advertisement or on the same page as an advertisement that contains information other than that concerning prescription services of the pharmacy referred to in the listing,

(v) printed advertisements that,

- (A) contain not more than the information in a professional card or an announcement card,
- (B) do not exceed two standard newspaper columns in width and 7.5 centimetres in depth including the margins,
- (C) do not appear more than twice in any one issue of the publication, and
- (D) do not appear in an advertisement or on the same page as an advertisement that contains information other than that concerning prescription services of the pharmacy referred to in the advertisement,

(vi) advertisements other than printed advertisements that,

- (A) contain not more than the information in a professional card or an announcement card, and
- (B) do not immediately precede or follow and are not contained in advertisements for other than prescription services in the pharmacy,

(vii) advertisements that advertise the posting of prescription prices in accordance with subsection (3). R.R.O. 1980, Reg. 451, s. 42 (1); O. Reg. 719/86, s. 1.

(2) Despite subsection (1), descriptive information in respect of the names, strengths, quantities and current prices of drugs for which prescriptions are required may be posted in or adjacent to the dispensary area in a pharmacy but every such posting shall,

(a) include only drugs listed in the PARCOST CD1;

(b) include with respect to each drug listed,

- (i) the generic name of the drug,
- (ii) the strength of the drug,
- (iii) the brand name and the name of the manufacturer of the drug,
- (iv) a standard reference quantity of 100 for tablets or capsules and 100 millilitres for liquids and 30 grams for solid dosage forms,

- (v) the dosage form, and
 - (vi) the final retail price charged for the drug;
 - (c) include not less than twenty-five drugs of which there shall be at least one from each of at least fifteen of the following classifications set out in the PARCOST CDI:
 1. Antihistaminics
 2. Anti-infective agents
 3. Antineoplastic agents
 4. Autonomic agents
 5. Blood derivatives
 6. Blood formation and coagulation drugs
 7. Cardiovascular drugs
 8. Central nervous system drugs
 9. Diagnostic agents
 10. Electrolytic, caloric and water balance drugs
 11. Cough preparations
 12. Eye, ear, nose and throat preparations
 13. Gastrointestinal drugs
 14. Gold compounds
 15. Hormones and substitutes
 16. Oxytocics
 17. Skin and mucous membrane preparations
 18. Spasmolytics
 19. Vitamins and minerals
 20. Unclassified therapeutic agents;
 - (d) not include any representation as to the safety, effectiveness or indications for use of the drugs listed; and
 - (e) not be displayed so that it can be read from the exterior of the pharmacy.
- (3) Despite subsection (1), a member or person operating a pharmacy may advertise the posting of prices in the following manner:

“Prescription drug price posting is available at (name of pharmacy) for the information of the public”.

(4) In this section, “prescription services” means the compounding and dispensing or the sale by retail of drugs pursuant to prescriptions. R.R.O. 1980, Reg. 451, s. 42 (2-4).

43. The owner of a pharmacy shall at the request of the Council complete and file with the Registrar within thirty days after the request a return in Form 1. R.R.O. 1980, Reg. 451, s. 43.

44. The Council may at any time require an examination and audit to be made by a public accountant designated by it for the purpose of ascertaining and reporting to the Council whether the information furnished by the owner of a pharmacy in a return in Form 1 is correct and the owner shall provide to the public accountant all the evidence, vouchers, records, books and papers that may be required by the public accountant for the purpose of the examination and

audit and the public accountant shall report to the Council in the manner required by the Council. R.R.O. 1980, Reg. 451, s. 44.

45. The Council may designate, as honorary members of the College, persons who are considered by the Council to be suited the honour by virtue of their contribution to health care services but an honorary member does not have the rights and privileges of a pharmacist. R.R.O. 1980, Reg. 451, s. 45.

46.—(1) The practice of pharmacy shall not be carried on by a member where there is a conflict of interest.

(2) It is a conflict of interest for a member to,

- (a) knowingly operate or be associated as owner, manager, employee or corporate director, in the operation of a pharmacy that is supplying drugs to a nursing home owned or operated by the same person that owns or operates the pharmacy unless the drugs are supplied to not more than twenty persons who are not more than 40 per cent of the residents of the nursing home;
- (b) knowingly be involved in the operation of a pharmacy where the owner or a partner, shareholder or director of the owner of the pharmacy owns, controls or has a beneficial interest in 25 per cent or more of the ownership of an entity that manufactures drugs;
- (c) participate in an arrangement by reason of which the interest of the member or any person associated with the member in the operation of a pharmacy influences, or is likely to influence adversely, the discharge of the member's professional obligation as a pharmacist. R.R.O. 1980, Reg. 451, s. 46.

47. For the purposes of Part VI of the Act, “professional misconduct” means,

- (a) failure by a member to abide by the terms, conditions or limitations of his or her licence;
- (b) entering into an agreement with a prescriber for the withholding of the composition of coded prescriptions;
- (c) falsifying a record in respect of a prescription or the sale of a drug;
- (d) providing a prescriber with prescription blanks, a professional diary, an appointment book or other gift whether imprinted or not with the name of a pharmacist or the name of a pharmacy;
- (e) sharing fees with any person who has referred a person to a pharmacist or to a pharmacy or receiving fees from any person to whom a member has referred a person;
- (f) participating in a lease of premises for a pharmacy that permits any person other than a member or the owner of the pharmacy to participate in the revenue of the pharmacy except by way of a rent normal for the area in which the premises are located;
- (g) entering into an agreement that restricts a person's choice of a pharmacist;
- (h) knowingly submitting a false or misleading account or a false or misleading charge for a drug or the compounding or dispensing of a prescription;
- (i) signing or issuing a certificate or similar document that contains a statement the signing or issuing member knows or ought to know is false or misleading;
- (j) announcing or holding out by a member that the member

has special qualifications that are not in fact possessed by the member;

- (k) submitting an account or charging a fee for any service as a pharmacist that is excessive or unreasonable in relation to the service performed;
- (l) failure to fulfil the terms of an agreement with a person as to the charge for providing any service as a pharmacist to the person;
- (m) returning to stock or again selling or dispensing a drug previously sold or dispensed and delivered;
- (n) improper use of the authority to sell or dispense a drug or mixture of drugs;
- (o) acting as a pharmacist while the ability to perform any act as a pharmacist is impaired by alcohol or a drug;
- (p) knowingly permitting the premises in which his or her pharmacy is located to be used for unlawful purposes;
- (q) permitting, consenting to or approving either expressly or by implication the commission of an offence against any Act relating to the practice of a pharmacist or to the sale of drugs by a corporation of which the member is a director;
- (r) failure to maintain the records that are required to be kept respecting a member's customers;
- (s) having a conflict of interest;
- (t) failure to maintain the standards of practice of the profession;
- (u) refusal to allow a duly appointed inspector to enter at a reasonable time the pharmacy in which the member is engaged in the practice of a pharmacist for the purpose of an inspection;
- (v) contravening while engaged in the practice of a pharmacist any federal, provincial or municipal law, regulation or rule with respect to the distribution, sale or dispensing of any drug or mixture of drugs;
- (w) offering or distributing, directly or indirectly, a gift, rebate, bonus or other inducement with respect to a prescription or prescription services; or
- (x) conduct or an act relevant to the practice of a pharmacist that, having regard to all the circumstances, would reasonably be regarded by members as disgraceful, dishonourable or unprofessional. R.R.O. 1980, Reg. 451, s. 47.

48. The decisions of the Discipline Committee may be published by the College in any publication of the College and, where a member has been found guilty of professional misconduct or incompetence, the full name and address of the member may be stated and a summary of the charge, the decision and the penalty imposed may be stated and the text or substance of any restriction on the licence of the member or of any reprimand may be added, but no decision shall be published until after the time for appeal from the decision has expired without an appeal being taken or, if taken, the appeal has been disposed of or abandoned and, where a member has been found not guilty of professional misconduct or incompetence, the identity of the member shall not be published but the substance of the proceedings may be published without identification of the parties for the purpose of publishing advice to the member or to the profession. R.R.O. 1980, Reg. 451, s. 48.

49. The Registrar shall issue a certificate of payment to a member upon receipt of the annual fee from the member. R.R.O. 1980, Reg. 451, s. 49.

50. A licence shall be in Form 2. R.R.O. 1980, Reg. 451, s. 50.

51. Every pharmacist shall display his or her licence in his or her principal place of practice as a pharmacist. R.R.O. 1980, Reg. 451, s. 51.

52. An application for a certificate of accreditation of a pharmacy shall be in Form 3. R.R.O. 1980, Reg. 451, s. 52.

53. A certificate of accreditation of a pharmacy shall be in Form 4 and shall be displayed in the pharmacy. R.R.O. 1980, Reg. 451, s. 53.

54. Every certificate of accreditation expires with the 9th day of March in each year. R.R.O. 1980, Reg. 451, s. 54.

55. An application for renewal of a certificate of accreditation of a pharmacy shall be in Form 5. R.R.O. 1980, Reg. 451, s. 55.

56.—(1) An oral prescription in respect of a drug referred to in Schedule E, F or G or in respect of a Schedule N preparation may be given only to a person referred to in subsection 149 (1) of the Act.

(2) An oral prescription referred to in subsection (1) shall be reduced to writing forthwith by the person receiving the prescription from the prescriber.

(3) A prescription may be given only in writing in respect of a drug, other than a Schedule N preparation, referred to in Schedule N. R.R.O. 1980, Reg. 451, s. 56.

57. A prescription for a drug referred to in Schedule N shall not be refilled. R.R.O. 1980, Reg. 451, s. 57.

58. A person shall refill a prescription for a drug referred to in Schedule E or F only where a prescriber so directs and specifies the number of times it may be refilled. R.R.O. 1980, Reg. 451, s. 58.

59. Every person who receives an oral direction to refill a prescription for a drug referred to in Schedule E or F, subsequent to the time the prescription is issued, shall forthwith record on the original prescription,

- (a) the date the refill direction is received;
- (b) the number of times specified that it may be refilled; and
- (c) the name and address of the prescriber issuing the direction if the prescriber of the refill is not the prescriber of the original prescription,

or record in a record of prescriptions kept under the name of each patient,

- (d) the name and quantity of drug prescribed and where applicable the strength of the drug;
- (e) the date the refill direction is received;
- (f) the number of times specified that the prescription may be refilled; and
- (g) the name and address of the prescriber issuing the direction if the prescriber of the refill is not the prescriber of the original prescription,

and the person shall sign the prescription or the record of prescriptions, as the case may be. O. Reg. 356/82, s. 1.

60. A person shall only refill a prescription for a drug referred to in Schedule G where the prescriber, at the time the prescription is issued,

- (a) directs in writing that the prescription be refilled; and

- (b) specifies the number of times it may be refilled and the dates for or intervals between refilling it. R.R.O. 1980, Reg. 451, s. 60.

61. A prescription, except for a drug referred to in Schedule N, may only be refilled where the person refilling the prescription records,

- (a) on the original prescription therefor,
- (i) the date of the refill,
 - (ii) the quantity of the drug dispensed, and
 - (iii) his or her signature; or
- (b) in a record of prescriptions kept under the name of each patient,
- (i) the date of the refill,
 - (ii) the identification number that is on the prescription therefor,
 - (iii) the name, strength where applicable, and quantity of the drug dispensed,
 - (iv) the identity of the manufacturer of the drug dispensed,
 - (v) the name of the prescriber,
 - (vi) the price charged, and
 - (vii) the signature of the person refilling the prescription. R.R.O. 1980, Reg. 451, s. 61.

62.—(1) A pharmacist may transfer a prescription to another pharmacist for the purpose of refilling the prescription, except with respect to a prescription for a drug referred to in Schedule G or N, where,

- (a) the prescriber has authorized the prescription to be refilled a specific number of times and there are authorized refills remaining;
- (b) the pharmacist transferring the prescription gives a copy of the prescription either,
 - (i) in writing to the person named in the prescription, his or her agent or a pharmacist acting on behalf of such person or agent, or
 - (ii) orally to a pharmacist acting on behalf of the person named in the prescription;
- (c) the transferred prescription is marked "transferred copy";
- (d) the transferred copy contains,
 - (i) the name and address of the person for whom the drug is prescribed,
 - (ii) the name and quantity of the drug prescribed and where applicable the strength of the drug,
 - (iii) the quantity of the drug dispensed if different from the quantity prescribed,
 - (iv) the directions for use as prescribed,
 - (v) the name and address of the prescriber,
 - (vi) the identity of the manufacturer of the drug dispensed,

- (vii) the identification number of the prescription,
 - (viii) the name and address of the pharmacy transferring the prescription,
 - (ix) the date the prescription was issued by the prescriber,
 - (x) the number of refills authorized originally,
 - (xi) the number of authorized refills remaining,
 - (xii) the date of the last refill, and
 - (xiii) the name of the pharmacist transferring the prescription; and
- (e) the pharmacist transferring the prescription records on the original prescription or in a record of prescriptions kept under the name of each patient that the prescription has been transferred, the date of the transfer and his or her signature.

(2) A prescription that has been transferred from a pharmacist shall not be refilled in the transferring pharmacy and shall not be transferred further.

(3) A pharmacist to whom a prescription has been transferred shall not dispense a drug pursuant thereto until he or she has obtained from the pharmacist transferring the prescription the information set out in clause (1) (d) and, where the prescription has been transferred orally, reduced the prescription to writing indicating therein the information specified in clause (1) (d). O. Reg. 356/82, s. 2.

63. Every manager of a pharmacy shall keep or cause to be kept a record of every purchase of a drug referred to in Schedule G or N by entering or causing to be entered in a register or other record maintained for that purpose forthwith upon such purchase,

- (a) the date of the purchase;
- (b) the name, strength where applicable, and quantity of the drug; and
- (c) the name and address of the person from whom the drug was purchased or received. R.R.O. 1980, Reg. 451, s. 62.

64. Every manager of a pharmacy shall keep or cause to be kept a record of every sale of a drug referred to in Schedule G, other than a Schedule G preparation, or in Schedule N, other than a Schedule N preparation, by entering or causing to be entered in a register maintained for that purpose forthwith upon such sale,

- (a) the date of the sale;
 - (b) the name, strength where applicable, and quantity of the drug;
 - (c) the name and address of the purchaser or person named in the prescription,
- and, where applicable,
- (d) the name and address of the prescriber; and
 - (e) the identification number on the prescription. R.R.O. 1980, Reg. 451, s. 63.

65. Every manager of a pharmacy shall keep or cause to be kept a record of every sale of a Schedule G preparation or a Schedule N preparation other than by prescription, by entering or causing to be entered in a register or other record maintained for that purpose forthwith upon such sale,

- (a) the date of the sale;
- (b) the name, strength where applicable, and quantity of the drug; and
- (c) the name and address of the purchaser. R.R.O. 1980, Reg. 451, s. 64.

66. The prescriptions and other records required by this Regulation shall be retained for not less than six years and shall be open to inspection by an inspector appointed under a by-law of the Council and an inspector may make copies of or take extracts from the prescriptions and other records. R.R.O. 1980, Reg. 451, s. 65.

67.—(1) A record of every sale of a drug referred to in Part I of Schedule D shall be entered in a book kept by the seller for that purpose.

- (2) The record of a sale referred to in subsection (1) shall include,
 - (a) the date of the sale;
 - (b) the name and address of the purchaser;
 - (c) the name of the drug sold;
 - (d) the quantity of the drug sold; and
 - (e) the purpose for which it is required as stated by the purchaser.

(3) After the record referred to in subsection (1) has been completed, the seller shall cause the purchaser to sign the record and the seller shall sign it.

(4) The seller of a drug referred to in Part I of Schedule D shall not deliver it to the purchaser until a record of the sale has been completed in accordance with this section. R.R.O. 1980, Reg. 451, s. 66.

68.—(1) Every person who sells a drug,

- (a) referred to in Part I of Schedule D shall ensure that the name of the drug and the word "poison" is legibly and conspicuously displayed on the outer surface of the container of the drug;
- (b) referred to in Part II of Schedule D for internal use shall ensure that the name of the drug and the words "CAUTION: May be poisonous if used in large doses or for a long time. Do not exceed the recommended dose without consulting a physician." are legibly and conspicuously displayed on the outer surface of the container of the drug; or
- (c) referred to in Part II of Schedule D for external application shall ensure that the name of the drug and the words "CAUTION: FOR EXTERNAL APPLICATION ONLY: May be poisonous if taken internally." are legibly and conspicuously displayed on the outer surface of the container of the drug.

(2) Where a drug referred to in clause (1) (a), (b) or (c) is sold in a pharmacy, the person who sells the drug shall sell it only in a container marked with the name, address and telephone number of the pharmacy and the name of the owner of the pharmacy.

(3) Clauses (1) (b) and (c) do not apply to a drug sold by wholesale to a pharmacist or a corporation operating a pharmacy under Part VI of the Act. R.R.O. 1980, Reg. 451, s. 67.

69. A container in which a substance referred to in Part II of Schedule B is sold at retail shall include on the label, legibly and conspicuously displayed on the outer surface of the container, the name of the substance and a caution or warning that the substance should be kept out of the reach of children, but this section does not apply

where the substance is referred to in the *Hazardous Products Act* (Canada). R.R.O. 1980, Reg. 451, s. 68.

70. A container in which a substance referred to in Part III of Schedule B is sold at retail shall include on the label, legibly and conspicuously displayed on the outer surface of the container, the name of the substance and a caution or warning that the substance should be used only with adequate ventilation, but this section does not apply where the substance is referred to in the *Hazardous Products Act* (Canada). R.R.O. 1980, Reg. 451, s. 69.

71.—(1) A container in which a drug specified in this section is dispensed pursuant to a prescription and in a form intended for systemic or internal use shall bear the following words legibly and conspicuously displayed on the outer surface of the container:

"WARNING: Do not exceed the dose prescribed by your physician. If difficulty in breathing persists, contact your physician immediately."

R.R.O. 1980, Reg. 451, s. 70 (1).

(2) The following drugs are specified for the purposes of subsection (1):

1. Ephedrine and its salts.
2. Epinephrine and its salts.
3. Ethylnorepinephrine and its salts.
4. Fenoterol and its salts.
5. Ipratropium and its salts.
6. Isoetharine and its salts.
7. Isoproterenol (Isoprenaline) and its salts.
8. Metaproterenol (Orciprenaline) and its salts.
9. Salbutamol (Albuterol) and its salts.
10. Terbutaline and its salts. O. Reg. 116/89, s. 1.

72. Every pharmacy shall be so constructed that,

- (a) it contains a prescription laboratory in which drugs are stored and prescriptions compounded or dispensed, located in a well defined area having a floor area adequate for the efficient operation of the pharmacy but of not less than 9.3 square metres;
- (b) it is free from every condition that may,
 - (i) be dangerous to health,
 - (ii) injuriously affect its efficient operation, or
 - (iii) injuriously affect the drugs prepared, compounded, dispensed or stored therein;
- (c) a separate room, compartment, locker or cupboard is provided for keeping the wearing apparel of employees;
- (d) floors and floor coverings may be readily cleaned in rooms where,
 - (i) drugs are prepared, compounded, dispensed or stored,
 - (ii) equipment is washed, or
 - (iii) washing fixtures and toilet fixtures are located;

- (e) the walls and ceilings of rooms and passageways may be readily cleaned and the painting or decorating maintained in good condition;
- (f) all rooms and passageways are well lighted and ventilated; and
- (g) suitable areas are provided for the storage and controlled sale of drugs by the pharmacist. R.R.O. 1980, Reg. 451, s. 71.
- 73.—(1) Every pharmacy shall be provided with,
- (a) a supply of hot and cold water adequate for the efficient operation of the pharmacy;
- (b) facilities for washing utensils used in the preparation, service or storage of drugs;
- (c) separate hand-washing facilities available for employees and located in a convenient location in the pharmacy;
- (d) a system for filing prescriptions;
- (e) a typewriter in good working condition;
- (f) a prescription counter adequate for the efficient operation of the prescription laboratory with not less than 1.12 square metres of free working space;
- (g) a refrigerator for the exclusive storage of drugs requiring refrigeration;
- (h) sufficient containers for storing refuse in a sanitary manner; and
- (i) the compounding and dispensing equipment set out in the following Table:

TABLE

Item	Equipment	Minimum Number Required	Specifications
1.	Prescription Balance	1	Class "A" with sensibility reciprocal of 10 mg.; and with lid which allows draft-free weighing to be made when the lid is closed.
2.	Weights, Metric	1 set	From 10 mg. to 50 mg. where not an integral part of the prescription balance.
3.	Graduates, Metric	3	One each of 10 ml., 25 ml. and 100 ml.
4.	Mortars and Pestles	1 1 1	Glass or earthenware, 60 ml. or 120 ml. 240 ml. 480 ml.
5.	Spatulas	3 1	Stainless steel, one each of small, medium and large: Non-metal.
6.	Funnels	2	Glass or plastic, one each of small (approximately 7.62 cm. diameter) and large (approximately 15.24 cm. diameter).
7.	Stirring Rods	2	Glass or plastic.
8.	Ointment Slab, Pill Tile or Parchment Paper	1 1 book	
9.	Prescription Numbering Device	1	

- (j) a quantity of the following consumable material sufficient for the efficient operation of the pharmacy:
1. Bottles with caps.
 2. Tablet vials (glass or plastic with caps).
 3. Labels.
 4. Filter papers.
 5. Weighing papers.
 6. Ointment jars with caps.
 7. Distilled or de-ionized water.
 8. Dropper bottles.
 9. Child-resistant packages;
- (k) a library including as a minimum, the following texts, pharmacopoeias, periodicals and other books:
1. A current edition of,
 - i. A Compendium of Pharmaceutical Specialties.
 - ii. A Drug Interaction Publication.
 - iii. A Pharmacology or Therapeutics Text.
 - iv. Parts I and VI of the *Health Disciplines Act* and the regulations and amendments.
 - v. The *Narcotic Control Act* (Canada), the regulations thereunder and amendments.
 - vi. The *Food and Drugs Act* (Canada), the regulations thereunder and amendments, perti-

ment to the sale of drugs, devices and vitamins.

2. A current edition or edition immediately preceding the current edition of,

- i. A Pharmaceutics Text.
- ii. A Dispensatory.
- iii. A Medical Dictionary; and

(l) a telephone that is listed in the local telephone directory.

(2) Only a potable water supply shall be used in any room where drugs are prepared, compounded, dispensed or stored.

(3) All drugs stored in a pharmacy shall be stored on or in shelves, drawers or fixtures provided for that purpose.

(4) Every pharmacy shall maintain,

- (a) furniture, equipment and appliances used in the interior of the pharmacy so that thorough cleaning of all areas is possible;
- (b) in a clean and sanitary condition,
 - (i) all furniture, equipment and appliances; and
 - (ii) all rooms in the pharmacy, whether used for the storage, compounding or dispensing of drugs or not; and
- (c) the painting and decorating of the interior and exterior of the pharmacy in good condition.

(5) Every room where drugs are prepared, compounded, dispensed or stored in a pharmacy shall be kept free from materials and equipment not regularly used in the room.

(6) Refrigerators for the storage of drugs in a pharmacy shall,

- (a) be maintained at a temperature between 1.3° Celsius and 10° Celsius;
- (b) be kept clean and in a sanitary condition; and
- (c) be located in an area not accessible to the public.

(7) All refuse and waste materials in a pharmacy,

- (a) shall be removed from the premises at least twice weekly and more often if necessary to maintain a sanitary condition; and
- (b) contained in filled containers shall be removed from any room in which drugs are prepared, compounded, dispensed or stored. R.R.O. 1980, Reg. 451, s. 72.

74.—(1) Every pharmacist, at the time of payment of his or her annual fee and at any other time within seven days after a request by the Registrar, shall file with the Registrar a signed statement setting out,

- (a) the pharmacist's residential address; and
- (b) the location of the place of practice of the pharmacist.

(2) Every pharmacist shall notify the Registrar in writing of any change in the information required by subsection (1) within seven days of the change. R.R.O. 1980, Reg. 451, s. 73.

75.—(1) Every owner of a pharmacy at the time of payment of the fee for renewal of a certificate of accreditation of the pharmacy, or at

any other time within seven days after a request by the Registrar, shall file with the Registrar a signed statement setting out,

- (a) the full name of the owner of the pharmacy and, where the owner is a corporation, the full name and residential addresses of the directors of the corporation;
- (b) the address of the owner of the pharmacy;
- (c) the name by which the pharmacy is known to the public;
- (d) the location of the pharmacy;
- (e) the full name of the manager of the pharmacy;
- (f) the residential address of the manager of the pharmacy; and
- (g) the names of the pharmacists, interns and registered pharmacy students employed in the pharmacy.

(2) The owner of a pharmacy shall notify the Registrar in writing of any change in the information required by subsection (1) within seven days of the change. R.R.O. 1980, Reg. 451, s. 74.

76.—(1) Every person who proposes to open a new pharmacy, acquire an existing pharmacy or relocate an existing pharmacy, shall, within the time prescribed by subsection (2), file with the Registrar a signed statement setting out,

- (a) the full name of the owner of the pharmacy;
- (b) the address of the owner of the pharmacy;
- (c) the name by which the pharmacy will be known to the public;
- (d) the location of the pharmacy; and
- (e) the proposed date of opening, acquiring or relocating the pharmacy.

(2) A person who proposes to open a new pharmacy or relocate an existing pharmacy shall file the information required by subsection (1) at least thirty days before opening or relocating the pharmacy and, where the person proposes to operate an existing pharmacy, the person shall file the information before commencing to operate the pharmacy.

(3) Every person who proposes to open a new pharmacy, acquire an existing pharmacy or relocate an existing pharmacy shall, on or before the day the person commences to operate the pharmacy, notify the Registrar of the name of the manager of the pharmacy. R.R.O. 1980, Reg. 451, s. 75.

77. Every person who permanently closes a pharmacy shall, within seven days of closing the pharmacy, notify the Registrar of the closing and within thirty days of the closing shall file with the Registrar a signed statement setting out,

- (a) the full name of the owner of the pharmacy;
- (b) the name by which the pharmacy was known to the public;
- (c) the location of the pharmacy;
- (d) the name of the manager of the pharmacy;
- (e) the date of closing;
- (f) the disposition of the drugs in stock in the pharmacy at the time of closing;
- (g) the disposition of the prescription files, drug registers and other records required to be kept under this Regulation; and

(h) the date on which all signs and symbols relating to the practice of pharmacy either within or outside the premises were removed. R.R.O. 1980, Reg. 451, s. 76.

78. The parts of a pharmacy in which prescriptions are compounded and dispensed for the public or drugs are stored or sold by retail shall be so constructed that they may be locked and made not accessible to the public in the absence of a pharmacist. R.R.O. 1980, Reg. 451, s. 77.

79. Schedules A, B, C, D, E, F, G and N are established for the purposes of Part VI of the Act. R.R.O. 1980, Reg. 451, s. 78.

80.—(1) The annual fee is,

- (a) for a pharmacist under sixty-five years of age, \$300; or
- (b) for a pharmacist sixty-five years of age or over, \$150,

and is due on the 10th day of January in each year for the year. O. Reg. 817/84, s. 1, *part*; O. Reg. 671/86, s. 1 (1); O. Reg. 595/87, s. 1 (1); O. Reg. 657/88, s. 1(1); O. Reg. 581/89, s. 2 (1); O. Reg. 510/90, s. 1 (1).

(2) Despite clause (1) (a), a person under sixty-five years of age who is licensed as a pharmacist for the first time and who receives the licence on or after the 1st day of September in a year shall pay an annual fee of \$150. O. Reg. 510/90, s. 1 (2).

(3) The fee for a licence is,

- (a) for an applicant who is the holder of a degree of Bachelor of Science in Pharmacy from the University of Toronto, \$100;

(b) for a person whose licence has been revoked or canceled, and who is subsequently eligible for a licence, \$100; or

(c) for an applicant other than an applicant referred to in clause (a) or (b), \$400. O. Reg. 817/84, s. 1, *part*.

(4) The fee payable upon an application for a certificate of accreditation of a pharmacy is,

- (a) for the year 1990, \$300; and
- (b) for the year 1991, \$320. O. Reg. 817/84, s. 1, *part*; O. Reg. 657/88, s. 1 (3); O. Reg. 510/90, s. 1 (3).

(5) The annual fee for renewal of a certificate of accreditation of a pharmacy is,

- (a) for the year 1990, \$500; and
- (b) for the year 1991, \$550;

and is due on the 10th day of March in each year for the year. O. Reg. 817/84, s. 1, *part*; O. Reg. 671/86, s. 1 (2); O. Reg. 595/87, s. 1 (2); O. Reg. 510/90, s. 1 (4-6).

(6) The fee for registration as a registered pharmacy student is \$15.

(7) The fee for registration as an intern is \$25. O. Reg. 817/84, s. 1, *part*.

Form 1

Health Disciplines Act

RETURN BY OWNER OF A PHARMACY

1. Name of Pharmacy

Street Address

City, Town or Village

Township

County, District or Regional Municipality

2. Full name and address of owner

i. If an individual, state if owner is sole owner.

.....
(yes or no)

ii. If not sole owner, state particulars of any agreement with any other party or parties.

.....
.....

iii. If a corporation, state:

(a) Date of incorporation

Provincial or Dominion incorporation

Public or private company

(b) Directors:

Name Address

Name Address

Name Address

(c) Number of shares authorized

Common Special

Number of shares issued

Common Special

Par value of shares \$..... common

\$..... special

Names and addresses of pharmacists who are registered owners of shares and classes of shares:

	Number of Shares	Class of Shares
Name
Address
Name
Address

3. i. State whether owner of pharmacy occupies premises as owner or tenant

ii. If tenant, give date of lease, date of expiration, amount of annual rent and name and address of owners of premises

.....
.....

4. By whom is pharmacy managed?

Name in full Address

5. State name and address of persons authorized to purchase narcotics and controlled drug medication to be sold on owner's premises:

Name Address

Name Address

6. State amount of owner's investment in the premises, furnishings and equipment, and the present value thereof:

.....
.....

7. State particulars of any mortgages or charges to which the premises and chattels therein are subject if owned by owner of pharmacy:

.....
.....

8. State particulars of any indebtedness of owner (other than mortgages and charges referred to in paragraph 7) including name and address of creditor, amount of indebtedness and terms of repayment:

.....
.....

.....
.....

(owner)*

(address of owner)

*To be signed,

- (a) if a sole proprietor, by proprietor;
- (b) if a partnership, by all partners; or
- (c) if a corporation, by all directors who are pharmacists. R.R.O. 1980, Reg. 451, Form 1.

Form 2

Health Disciplines Act

LICENCE TO PRACTISE PHARMACY
 ONTARIO COLLEGE OF PHARMACISTS

This is to certify that

.....
(name)

has been duly licensed as a member of the College and is thereby entitled to practise as a pharmacist in the Province of Ontario.

.....
President

.....
Registrar

Dated at Toronto, this day of, 19.....

R.R.O. 1980, Reg. 451, Form 2.

Form 3

Health Disciplines Act

APPLICATION FOR CERTIFICATE OF ACCREDITATION OF A PHARMACY

Application is hereby made for a certificate of accreditation of a pharmacy, particulars of which are as follows:

Full name of owner

Address of owner

Name by which pharmacy will be known to the public:
.....

Location of pharmacy:
.....
(municipality, street and number, postal code)

The pharmacy is,
 (a) a new opening
 (b) being acquired
 (c) being relocated

Date of commencement of operation

Date pharmacy will be ready for inspection

Is applicant a corporation? Yes No

.....
(applicant)*

Dated at Toronto, this day of, 19.....

*If a partnership, all partners must sign; if a corporation, by an authorized officer.

R.R.O. 1980, Reg. 451, Form 3.

Form 4*Health Disciplines Act*

CERTIFICATE OF ACCREDITATION OF A PHARMACY ONTARIO COLLEGE OF PHARMACISTS

This is to certify that the pharmacy owned by

.....
(name of owner)

.....
(address of pharmacy)

has complied with the provisions of Part VI of the *Health Disciplines Act* and the regulations made thereunder as to the accreditation of pharmacies in the Province of Ontario.

.....
(Registrar)

Dated at Toronto, this day of, 19.....

R.R.O. 1980, Reg. 451, Form 4.

Form 5*Health Disciplines Act*

APPLICATION FOR RENEWAL OF CERTIFICATE OF ACCREDITATION OF A PHARMACY

Application is hereby made for renewal of a certificate of accreditation of a pharmacy, particulars of which are as follows:

1. Full name of owner
2. Address of owner
3. Name of pharmacy
4. Location of pharmacy:

.....
(municipality, street number, postal code)

.....
(applicant)*

Dated at Toronto, this day of, 19.....

*If a partnership, all partners must sign; if a corporation, by an authorized officer.

R.R.O. 1980, Reg. 451, Form 5.

Schedule A**SUBSTANCE**

Alum
Aromatic Cascara Sagrada Fluidextract
Arrowroot
Castor Oil
Cod Liver Oil
Glycerin
Linseed
Liquid Paraffin (Mineral Oil)
Magnesium Sulphate (Epsom Salts)
Oil of Turpentine
Olive Oil
Petrolatum

Saccharine and Sodium Saccharine

Sodium Bicarbonate

Sodium Carbonate

Sodium Chloride

R.R.O. 1980, Reg. 451, Sched. A.

Schedule B**PART I
SUBSTANCE**

Aluminum Chloride, when in an antiperspirant preparation, not more than 5%

Ammonium Chloride

Beef, Iron and Wine

Biotin

Chlorhydrol, when in an antiperspirant preparation

Choline

Cochineal
 Essence of Peppermint
 Hydrogen Peroxide Solution, not more than 3%
 Hydroquinone, when in skin bleaching preparations, not more than 2%
 Inositol
 Irgasan DP 300, when in an antiperspirant preparation, not more than 0.4%
 Magnesium Carbonate
 Magnesium Citrate
 Magnesium Hydroxide
 Merbromin (Mercurochrome) Solution, not more than 2%
 Methylbenzethonium Chloride, when in an antiperspirant preparation, not more than 0.25%
 Oil of Eucalyptus
 Potassium Acid Tartrate (Cream of Tartar)
 Potassium Chloride, as a salt substitute
 Potassium Iodide, not more than 0.01%, when in salt substitutes
 Potassium Nitrate (Saltpetre)
 Rhubarb Root
 Seidlitz Powders
 Selenium Sulfide, when in an anti-dandruff preparation, not more than 1%
 Selenium and its salts in a preparation for internal use, when sold as a nutritional supplement in solid unit doses of 50 micrograms or less
 Senna
 Sodium Fluoride when in dentifrices, not more than 0.25%
 Sodium Potassium Tartrate (Rochelle Salts)
 Sodium Phosphate
 Sodium Sulphate (Glauber Salt)
 Spirit of Aromatic Ammonia
 Spirit of Nitrous Ether
 Stannous Fluoride, when in dentifrices, not more than 0.4%
 Strontium Chloride, when in dentifrices, not more than 10%
 Sulphur
 Zinc Pyridinethione, when in anti-dandruff preparations, not more than 2%
 Zirconium Hydrochloride, when in an antiperspirant preparation, not more than 5%
 R.R.O. 1980, Reg. 451, Sched. B, Part 1; O. Reg. 422/84, s. 1 (1); O. Reg. 116/89, s. 2(1).

PART II SUBSTANCE

Acid Muriatic, commercial
 Acid Sulphuric, commercial
 Belladonna and its preparations, for external use, on the basis of belladonna alkaloids, not more than 0.375%
 Benzocaine, for topical use, not more than 10%
 Boric (Boracic) Acid

Borax
 Calamine Lotion
 Calcium Chloride
 Camphor Gum
 Camphorated Chalk
 Camphorated Oil
 Chlorinated Lime
 Copper Sulphate, when sold as Bluestone
 Creosote, not more than 0.25 ml. or its equivalent per stated dose
 Cresol (Cresylic Acid) or homologues or preparations thereof, when weaker than 5% Cresol
 Ethyl ether, for external use, in concentrations not exceeding 0.1%
 Ferrous Sulphate, when sold as Copperas
 Glycol salicylate, for external use, alone or in combinations with other salicylates, not exceeding a total salicylate concentration of 20%
 Hyoscyamine and its salts, for external use, in concentrations not exceeding 1%
 Iodine, solution or tincture, not more than 2 1/2%
 Isopropyl Alcohol when in strengths of 70% or less
 Lobelia and its preparations, on the basis of the crude drug, for internal use, in doses not exceeding 130 mg. for a single dose and 390 mg. for a daily dose
 Methyl salicylate, for external use alone or in combination with other salicylates, not exceeding a total salicylate concentration of 30%
 Nitrobenzol, when in commercial preparations
 Oil of cedar leaf, for inhalation use, in a concentration not exceeding 1%
 Phenol in preparations not intended for systemic absorption, in strengths not greater than 2%
 Salicylamide, not more than 500 mgm. per stated dose
 Solution of Ammonia
 Spirit of Camphor
 Tolnaftate, in preparations for external use, not more than 1%
 Triethanolamine salicylate
 Zinc undecylenate, in preparations for external use, not more than 20%
 R.R.O. 1980, Reg. 451, Sched. B, Part II; O. Reg. 422/84, s. 1 (2, 3); O. Reg. 116/89, s. 2 (2, 3).

PART III

Acetone
 Benzol or chlorinated derivatives
 Ether, commercial
 Formaldehyde
 Tetrachlorethylene
 Trichlorethylene

R.R.O. 1980, Reg. 451, Sched. B, Part III.

PART IV

VITAMINS for oral use, the following:

Vitamin A or provitamin A, 10,000 International Units or less per oral dosage form

Thiamine or vitamin B-1

Riboflavin or vitamin B-2

Niacin or niacinamide

Pyridoxine or vitamin B-6

D-pantothenic acid or vitamin B-3

Folic acid

Cyanocobalamin or vitamin B-12

Ascorbic acid or vitamin C

Vitamin D, 1,000 International Units or less per oral dosage form

Alpha tocopherol or vitamin E

Menadione or vitamin K

R.R.O. 1980, Reg. 451, Sched. B, Part IV.

Schedule C**SUBSTANCE**

Acetylsalicylic Acid products for children

Adiphenine and its salts for oral use

Allylthiocyanates in preparations for external use greater than 2%

Alverine and its salts for oral use

Ambenonium chloride

Aminopentamide and its salts for oral use

Aminopromazine and its salts for oral use

Anisotropine methylbromide for oral use

Antipyrine and its salts and derivations for internal use

Azapetine phosphate

Bacitracin and its salts for parenteral use

Benzyl benzoate

Bephenium and its salts for human use

Bethanechol chloride

Carbachol

Carbazochrome and its salts

Chlorphenoxamine hydrochloride

Cholestyramine resin

Clidinium bromide for oral use

Codeine phosphate in preparations that contain codeine phosphate not exceeding 8 mg. or its equivalent per tablet or per unit in other solid form or 20 mg. or its equivalent per 30 ml. in a liquid preparation if,

i. the preparation contains,

A. two additional medicinal ingredients other than a narcotic in a quantity of not less than the regular minimum single dose for one such ingredient or one-half the regular minimum single dose for each such ingredient, or

B. three additional medicinal ingredients other than a

narcotic in a quantity of not less than the regular minimum single dose for one such ingredient or one-third the regular minimum single dose for each such ingredient; and

ii. there is legibly and conspicuously printed on the main panel of the label and on any outer container the full formula or true list of all active ingredients and a caution to the following effect:

“This preparation contains codeine and should not be administered to children except on the advice of a physician”.

Cyclandelate

Cycrimine hydrochloride

Demecarium bromide

Dichlorphenamide

Dicyclomine and its salts for oral use

Dipyridamole

Ethoxazene hydrochloride

Erythrityl tetranitrate

Fluorides in preparations containing 1 mg. or less of fluoride ion per stated daily dose, except mouthwashes and dentifrices containing fluorides

Gamma benzene hexachloride

Glycopyrrolate and its salts for oral use

Hexocyclium methylsulphate for oral use

Hexylresorcinol, when used as an anthelmintic

Homatropine methylbromide for oral use in strengths greater than 2 mg. per unit dose

Hydrocortisone preparations containing as a single active ingredient, not more than 0.5 per cent hydrocortisone or hydrocortisone acetate in topical dosage form

Hyoscine (scopolamine) or its salts or derivatives in preparations intended for transdermal absorption

Ibuprofen and its salts when sold in strengths of 200 mg. or less per dosage form and not in combination with another medicinal ingredient

Insulin

Insulin, Globin with zinc

Insulin made from zinc-insulin crystals

Insulin, N.P.H. (Isophane)

Insulin, Protamine zinc

Insulin, sulphated

Insulin zinc suspension

Iron preparations containing more than 60 mg. elemental iron per tablet, capsule, or 5 ml. of liquid

Isobornyl thiocyanacetate

Isoflurophate

Isometheptene and its salts for oral use

Isopropamine or its salts or preparations thereof containing 2.5 mg. or less per stated dose for oral use

Isosorbide dinitrate

Isosuprine and its salts

Loperamide and its salts

Mepenzolate and its salts for oral use	Acid Chromic or its salts
Mephesisin and its salts for oral use	Acid Hydrochloric, except commercial
Methacholine	Acid Nitric
Methantheline and its salts for oral use	Acid Oxalic
Methenamine and its salts	Acid Phosphoric, 10% w/w or stronger
Methixene and its salts for oral use	Acid Picric (Trinitrophenol)
Methocarbamol for oral use	Acid Sulphuric, except commercial
Methoxyphenamine	Aconite or alkaloids or preparations thereof, except as provided in Part II of this Schedule
Methscopolamine and its salts for oral use	Alkaloids: all poisonous alkaloids, including vegetable alkaloids not specifically mentioned elsewhere in these Schedules, or their salts, or all poisonous derivatives thereof, when in doses exceeding those recognized as safe medication
Neostigmine and its salts	Amyl Nitric
Nicotinyl alcohol tartrate	Antimony or preparations thereof, except as provided in Part II of this Schedule
Nitroglycerin	Arsenic or its salts or organic compounds or preparations thereof, except as provided in Part II of this Schedule
Nylidrin and its salts	Atropine or its salts or preparations thereof, except as provided in Part II of this Schedule
Oxalic and Malonic acids compound	Barium salts, water soluble, including chloride and sulphide
Oxphencyclimine and its salts for oral use	Belladonna or compounds or preparations thereof, except as provided in Part II of this Schedule or Part II of Schedule B
Oxyphenonium and its salts for oral use	Cantharides or its derivatives or preparations thereof
Para-aminosalicylic acid and its salts	Carbon Disulphide
Pentaerythritol tetranitrate	Cedar Oil from leaf or wood, except as provided in Part II of this Schedule or Part II of Schedule B
Penthienate and its salts for oral use	Chenopodium, the oil, or preparations thereof
Phenacetin	Chloroform, except as a preservative, and except as provided in Part II of this Schedule
Phenazopyridine hydrochloride	Conium or preparations thereof
Pipenzolate and its salts for oral use	Cottonroot, the oil, or derivatives or preparations thereof
Piperazine and its salts for human use	Copper salts or compounds or preparations thereof, except as provided in Part II of this Schedule
Piperidolate and its salts for oral use	Cresol (Cresylic Acid) or homologues or preparations thereof, when 5% Cresol or stronger
Potassium salts containing as an active ingredient more than 5 mg. of potassium per tablet, capsule or 5 ml. of liquid dosage form	Croton Oil, except as provided in Part II of this Schedule
Propantheline and its salts for oral use	Cyanides, except as provided in Part II of this Schedule
Propylhexedrine	Ethyl ether, except commercial and except as provided in Part II of Schedule B
Pyrantel pamoate for human use	Ethyl Chloride
Pyrethrins in combination with piperonyl butoxide	Fluorides, in bulk or in preparations containing more than 1 mg. fluoride ion per stated total daily dose, except dentifrices containing fluorides
Pyridostigmine bromide	Glycosides: all poisonous glycosides, including vegetable glycosides not specifically mentioned elsewhere in these Schedules, or their salts, or all poisonous derivatives thereof, when in doses exceeding those recognized as safe medication
Pyrvinium pamoate for human use	Henna Berries
Quinacrine hydrochloride	Hydrocyanic (Prussic) Acid
Quinidine and its salts	Hyooscyamus or compounds or preparations thereof, except as provided in Part II of this Schedule or Part II of Schedule B
Quinine and its salts, except for topical use, in preparations greater than 1 mg. per stated dose	
Thiocyanate salts	
Tolazoline and its salts	
Tridihexethyl chloride for oral use	
Trimethobenzamide and its salts	
Xanthinol niacinate	

O. Reg. 422/84, s. 2; O. Reg. 512/87, s. 1; O. Reg. 62/89, s. 1; O. Reg. 116/89, s. 3; O. Reg. 428/89, s. 1.

Schedule D

PART I SUBSTANCE

Acid Acetic, 33% or stronger

Hyoscine (Scopolamine) or its salts, derivatives or preparations thereof, except as provided in Part II of this Schedule

Iodine or preparations thereof, except as provided in Part II of this Schedule

Lead salts or preparations thereof

Lithium or its salts, except as provided in Schedule F

Lobelia or alkaloids or preparations thereof, except as provided in Part II of this Schedule or Part II of Schedule B

Mercurial salts, except as provided in Part II of this Schedule

Mercury or oxides thereof, except as provided in Part II of this Schedule

Mercury Ammoniated

Nitrobenzene (when labelled as such or as NITROBENZOL or as OIL of MIRBANE, and when the label bears the name of the pharmacy in which the sale is made and the following wording: "POISON—This chemical is POISONOUS when taken internally, inhaled or in contact with the skin. HANDLE WITH CARE and avoid skin contact and inhalation of vapours."), except as provided in Schedule B

Nux Vomica or preparations thereof, except as provided in Part II of this Schedule

Oil of Bitter Almonds, unless deprived of Hydrocyanic (Prussic) Acid

Oil of Wintergreen or Methyl Salicylate, except when in internal preparations solely as a flavouring agent or in aerosol preparations as a fragrance or in external preparations as provided in Part II of Schedule B

Pennyroyal, the oil, or derivatives or preparations thereof

Phenol (carbolic acid), except as provided in Part II of this Schedule or Part II of Schedule B

Phosphorus, in the free state

Picrotoxin

Podophyllum Resin

Potassium Antimonytartrate (Tartar Emetic), except as provided in Part II of this Schedule

Potassium Bichromate

Potassium Chlorate, except as provided in Part II of this Schedule

Potassium Hydroxide, except in commercial preparations

Potassium Nitrite

Potassium Permanganate or preparations thereof

Rue, the oil, or derivatives or preparations thereof

Sabadilla or preparations thereof

Santonin, except as provided in Part II of this Schedule

Savin, the oil, or derivatives or preparations thereof

Selenium or its salts or preparations thereof, except as provided in Part II of this Schedule and Part I of Schedule B

Sodium Antimonytartrate, except as provided in Part II of this Schedule

Sodium Chlorate, except as provided in Part II of this Schedule

Sodium Hydroxide, except in commercial preparations

Sodium Nitrite

Strophanthus or preparations thereof

Strychnine or its salts or preparations thereof, except as provided in Part II of this Schedule

Tansy, the oil, or derivatives or preparations thereof

Yohimbine

R.R.O. 1980, Reg. 451, Sched. D, Part I; O. Reg. 422/84, s. 3 (1).

PART II SUBSTANCE

Acetanilide, except when not more than 65 mg. per stated dose

Acid Phosphoric, less than 10% w/w

Aconite or alkaloids or preparations thereof, in external preparations containing less than 0.2% aconitine

Antimony or its salts, when combined with other medicinal ingredients in recognized therapeutic dosage forms and when in doses not exceeding those recognized as safe medication

Arsenic or its salts or organic compounds, when combined with other medicinal ingredients in recognized therapeutic dosage forms and when in doses not exceeding those recognized as safe medication

Atropine or its salts, in internal preparations containing not more than 0.13 mg. per stated dose or in other preparations containing not more than 0.1% by weight

Belladonna or compounds or preparations thereof, when combined with other medicinal ingredients in recognized therapeutic dosage forms, including plasters, and when in doses not exceeding those recognized as safe medication, except as provided in Part II of Schedule B

Cedar Oil from leaf or wood, for external use, when combined with other medicinal ingredients and when in strengths not exceeding those recognized as safe medication, except as provided in Part II of Schedule B

Chloroform, when in internal preparations as a therapeutic ingredient and not as a preservative

Colchicum or Colchicine

Copper salts or compounds, when combined with other medicinal ingredients in recognized therapeutic dosage forms and when in doses not exceeding those recognized as safe medication or when combined in preparations used as diagnostic aids, except in trace amounts and as provided for in Schedule B

Creosote or preparations thereof, except as provided in Part II of Schedule B

Croton Oil, for external use when combined with other medicinal ingredients and when in strengths not exceeding those recognized as safe medication

Cyanides, the complex salts thereof, when combined with other medicinal ingredients in recognized therapeutic dosage forms and when in doses not exceeding those recognized as safe medication

Ephedrine or its salts, except when in inhalant form or in internal preparations containing not more than 11 mg. per stated dose

Guaiaicol, except when in internal preparations as a therapeutic ingredient

Homatropine or its salts or preparations thereof, except homatropine methylbromide for oral use in strengths of 1 mg. or less per unit dose

Hyoscyamus or compounds or preparations thereof, when combined with other medicinal ingredients in recognized therapeutic dosage forms and when in doses not exceeding those recognized as safe medication, except hyoscyamine and its salts as provided in Part II of Schedule B

Hyoscine (scopolamine) or its salts or derivatives in internal preparations containing not more than 0.325 mg. per stated dose, except

for preparations intended for transdermal absorption, or in inhalant preparations containing not more than 0.5% by weight	Benztropine mesylate
Iodides, their salts or compounds, except in trace amounts	Biperiden hydrochloride
Iodine, in strengths less than 10% when in solution or when combined with other medicinal ingredients in recognized therapeutic dosage forms, except as provided in Schedule B	Butacaine and its salts for ophthalmic or parenteral use
Iodoform	Carbimazole
Isopropyl Alcohol and rubbing compounds thereof	Cinchocaine (Dibucaine) and its salts for ophthalmic or parenteral use
Lobelia or alkaloids or preparations thereof when combined with other medicinal ingredients and when in strengths not exceeding those recognized as safe medication, except as provided in Part II of Schedule B	Clidinium bromide for parenteral use
Mercurous Chloride (Calomel)	Cyclomethycaine and its salts for ophthalmic or parenteral use
Mercury with Chalk	Deanol
Mercury (Blue) Ointment	Diaminodiphenylsulfone or its analogues or derivatives
Nux Vomica or preparations thereof, when combined with other medicinal ingredients in recognized therapeutic dosage forms and when in doses not exceeding those recognized as safe medication	Dicyclomine and its salts for parenteral use
Phenol (carbolic acid) in preparations containing less than 5% except as provided in Part II of Schedule B	Digitalis, its glycosodes or derivatives of preparations thereof
Potassium Antimonytartrate (Tartar Emetic), when in internal preparations as a therapeutic ingredient containing not more than 3.3 mg. per stated dose	Dimethisoquin and its salts for ophthalmic or parenteral use
Potassium Chlorate in tablet or lozenge form, not exceeding 325 mg. per stated dose or in liquid form not exceeding 2.5%, except for topical use	Diperodon and its salts for ophthalmic or parenteral use
Santonin, when in internal preparations as a therapeutic ingredient containing not more than 65 mg. per stated dose	Dipivefrin and its salts
Selenium or its salts, when in external preparations containing not more than 2.5% of selenium	Ephedrine and its salts for parenteral use
Silver salts or preparations thereof, except preparations containing not more than 1% when used as a mouthwash	Epinephrine and its salts
Sodium Antimonytartrate, when in internal preparations as a therapeutic ingredient containing not more than 3.3 mg. per stated dose	Ethopropazine hydrochloride
Sodium Chlorate, in tablet or lozenge form not exceeding 325 mg. per stated dose or in liquid form not exceeding 2.5%	Glycopyrrolate and its salts for parenteral use
Stavesacre	Gold and its salts, in preparations for use as a drug
Strychnine or its salts, when combined with other medicinal ingredients in recognized therapeutic dosage forms and when in doses not exceeding those recognized as safe medication	Hexocyclium methylsulphate for parenteral use
Zinc salts containing more than 25 mg. per unit dose or elemental zinc, except as provided in Part II of Schedule B	Homatropine methylbromide for parenteral use
R.R.O. 1980, Reg. 451, Sched. D, Part II; O. Reg. 835/82, s. 2; O. Reg. 422/84, s. 3 (2); O. Reg. 116/89, s. 4.	Isometheptene and its salts for parenteral use

Schedule E

SUBSTANCE

Adiphenine and its salts for parenteral use	Isopropamide or its salts or preparations thereof for parenteral use
Adrenocorticotrophic hormone (ACTH) and its derivatives	Isopropamide or its salts or preparations thereof, containing more than 2.5 mg. per stated dose
Angiotensinamide for parenteral use	Lidocaine (Lignocaine) and its salts for ophthalmic or parenteral use
Alverine and its salts for parenteral use	Mepenzolate and its salts for parenteral use
Aminopentamide and its salts for parenteral use	Mephesisin and its salts for parenteral use
Aminopromazine and its salts for parenteral use	Metaramional bitartrate for parenteral use
Anisotropine methylbromide for parenteral use	Metaxalone
Benzocaine and its salts for ophthalmic or parenteral use	Methantheline and its salts for parenteral use
	Methimazole
	Methixene and its salts for parenteral use
	Methocarbamol for parenteral use
	Methoxsalen
	Methscopolamine and its salts for parenteral use
	Narcotine (Noscapine) or preparations thereof, containing more than 30 mg. per stated dose
	Orphenadrine and its salts
	Oxyphencyclimine and its salts for parenteral use
	Oxyphenonium and its salts for parenteral use
	Papavarine
	Paromomycin
	Penthienate and its salts for parenteral use
	Phenylephrine and its salts for parenteral use
	Phenylephrine ophthalmic preparations greater than 2.5%

Phenylpropanolamine and its salts for parenteral use

Pipamazine

Pipenzolate and its salts for parenteral use

Piperidolate and its salts for parenteral use

Piperocaine and its salts

Posterior pituitary extracts

Pramoxine and its salts for ophthalmic or parenteral use

Procaine and its salts for ophthalmic or parenteral use

Procyclidine hydrochloride

Propantheline and its salts for parenteral use

Proparacaine and its salts for ophthalmic or parenteral use

Pseudoephedrine and its salts for parenteral use

Ristocetin

Sparteine sulphate

Stramonium

Succinylcholine and its salts

Tetracaine and its salts for ophthalmic or parenteral use

Theophylline and its salts and derivatives

Tropicamide and its salts for ophthalmic or parenteral use

Tridihexethyl chloride for parenteral use

Trihexyphenidyl hydrochloride

Tubocurarine and its salts

O. Reg. 422/84, s. 4; O. Reg. 116/89, s. 5.

Schedule F**PART I**

Aconiazide and its salts

Alfacalcidol

Allopurinol

Alphadolone and its salts

Alphaxalone

Amantadine and its salts

Aminocaproic acid

Aminoglutethimide

Aminopterin and its salts

4-amino-pteroyl aspartic acid and its salts

Amitriptyline and its salts

Antibiotics, the following and their salts a derivatives

Amikacin

Amoxicillin

Amphotericin B

Ampicillin

Benzathine penicillin

Candicidin

Capreomycin

Carbenicillin

Carbomycin

Cephalosporin C

Chloramphenicol

Cloxacillin

Dicloxacillin

Gentamicin

Hetacillin

Methicillin

Nafcillin

Netilmicin

Oxacillin

Rifampin

Ticarcillin

Tobramycin

Vancomycin

Viomycin

Anticoagulants, the following

Bishydroxycoumarin and its salts a derivatives

4-Hydroxycoumarin and its derivatives when sold or recommended as anticoagulants

Phenylindanedione and its derivatives

Apiol, oil of

l-Asparaginase

Azaribine

Azatadine and its salts

Baclofen and its salts

Bemegride

Bendazac and its salts

Benzidamine and its salts

Benzoyl peroxide in concentrations greater than 5% or when sold in combination with another medicinal ingredient

Betahistine and its salts

Bethanidine and its salts

Bleomycin

Boldenone undecylenate

Bretylum tosylate

Bromal and the following derivatives:

Bromal hydrate

Brometone

Bromoform

Bromazepam and its salts

Bromides, the following:

Ammonium bromide

Calcium bromide

Calcium bromolactobionate

Potassium bromide

Sodium bromide	Cromoglycic acid and its salts
Strontium bromide	Cyclobenzaprine and its salts
Bromocriptine and its salts	Cyclophosphamide
Busulfan	Cycloserine
Calcitonin	Cytarabine and its salts
Calcitriol	Dacarbazine
Calcium carbimide	Dactinomycin
Carbamazepine	Danazol
Carbenoxolone and its salts	Dantrolene and its salts
Carbimazole	Daunorubicin and its salts
Carbromal and the following derivatives:	Debrisoquin and its salts
Acetylcarbromal	Deferoxamine and its salts
Aliylisopropylacetylurea	Desipramine and its salts
Bromisoval	Desmopressin and its salts
Diethylbromacetamide	Diazepam and its salts
Carisoprodol	Diazoxide and its salts
Carmustine	Dichloroacetic acid
Centella asiatica extract and active principles thereof	Diclofenac and its salts
Chloral and the following derivatives:	Diethylcarbamazine and its salts
Alpha-chloralose	Diethylstilbestrol and its salts & derivatives
Butyl chloral hydrate	Diiodohydroxyquin (except in preparations for topical use on the skin)
Chloralformamide	Dimethylsulfoxide
Chloral hydrate	2,4-Dinitrophenol and its salts & derivatives
Chloralimide	Dinoprostone and its salts & derivatives
Chlorambucil and its salts & derivatives	Diphenidol and its salts
Chlorcyclizine and its salts (except in preparations for external use only)	Diphenylmethane derivatives, the following & their salts:
Chlordiazepoxide and its salts	Azacyclonol
Chlorisondamine and its salts	Benactyzine
Chlormezanone	Captodiamine
Chloroquine and its salts	Hydroxyzine
Chlorprothixene and its salts	Piperilate
Choline salicylate, when sold in combination with magnesium salicylate	Disopyramide and its salts
Cimetidine and its salts	Disulfiram
Cinchophen and its salts	Dobutamine and its salts
Cisplatin	Dopamine and its salts
Clofibrate	Doxapram
Clomiphene and its salts	Doxepin and its salts
Clomipramine and its salts	Doxorubicin and its salts
Clonazepam and its salts	Doxylamine and its salts, when sold or recommended for use in the nausea or vomiting of pregnancy
Clonidine and its salts	Droperidol and its salts
Cloprostenol and its salts & derivatives	Econazole and its salts
Clorazepic acid and its salts	Echothiophate and its salts
Clotrimazole and its salts	Ectylurea and its salts
Colestipol and its salts	Embutramide

Emylcamate	Isoflurane
Estramustine and its salts	Isoniazid
Ethacrynic acid and its salts	Isoproterenol (Isoprenaline) and its salts
Ethambutol and its salts	Ketamine and its salts
Ethchlorvynol	Ketazolam and its salts
Ethinamate	Ketoprofen and its salts
Ethionamide and its salts	Levodopa and its salts
Ethomoxane and its salts	Lithium carbonate
Ethyl trichloramate	Lomustine
Etidronic acid and its salts
Etryptamine and its salts	Lorazepam and its salts
Fenfluramine and its salts	Loxapine and its salts
Fenopropfen and its salts	Magnesium glutamate hydrobromide
Fenoterol and its salts	Maprotiline and its salts
Floctafenine	Mazindol and its salts
Flucytosine	Mecamylamine and its salts
Flunixin and its salts and derivatives	Mechlorethamine and its salts
Fluorouracil and its derivatives	Meclofenamic acid and its salts
Fluprostenol and its salts & derivatives	Mefenamic acid and its salts
Flurazepam and its salts	Megestrol and its salts
Fluspirilene	Melphalan
Fusidic acid and its salts	Menotropins (Human post-menopausal urinary gonadotrophins)
Glutethimide	Mephenoaloxone
Glyburide and its salts & derivatives	Mephentermine and its salts
Gonadorelin and its salts	Meprobamate
Guanethidine and its salts	6-Mercaptopurine
Haloperidol	Mescaline and its salts
Hexachlorophene and its salts	Metaldehyde
Hexacyclonate sodium	Metformin and its salts & derivatives
Hexamethonium and its salts	Methimazole
Hydantoin derivatives, the following & their salts:	Methisazone
Diphenylhydantoin (phenytoin)	Methotrexate and its salts
Ethotoin	Methoxsalen
Methoin (mephenytoin)	Methyldopa and its salts
Hydralazine and its salts	Methylparafynol
Hydroxychloroquine and its salts	Methyprylon
Hydroxyurea	Methysergide and its salts & derivatives
Ibuprofen and its salts when sold in strengths greater than 200 mg. per dosage form or when sold in combination with another medicinal ingredient	Metoclopramide
Idoxuridine	Metolazone and its salts
Imipramine and its salts	Metoprolol and its salts
Indomethacin	Metronidazole
Iodochlorohydroxyquin (except in preparations for topical use on the skin)	Metyrapone and its salts
Iproniazid and its salts	Mibolerone
Isocarboxazid and its salts	Miconazole and its salts
	Minoxidil

Mitomycin and its salts	Thiopropazine
Mitotane (o, p'-DDD)	Thioridazine
Nadolol and its salts	Trifluoperazine
Nalidixic acid	Triflupromazine
Naloxone and its salts	Phenylbutazone and its salts
Naproxen and its salts	Pimozide
Neocinchophen and its salts	Pindolol and its salts
Nialamide and its salts	Pipobroman
Nitrazepam and its salts	Pipradrol and its salts
Nortriptyline and its salts	Pizotyline and its salts
Orciprenaline (Metaproterenol) and its salts	Pralidoxime and its salts
Oxanamide	Prazepam and its salts
Oxazepam and its salts	Prazosin and its salts
Oxprenolol and its salts	Probucol
Oxyphenbutazone and its salts	Procainamide and its salts
Pancuronium and its salts	Procarbazine and its salts
Paraldehyde	Prodilidine and its salts
Paramethadione	Propranolol and its salts
Pargyline and its salts	Propoxyphene and its salts
Pemoline and its salts	Prostaglandins and their salts & derivatives
Penicillamine	Prothipendyl hydrochloride
Pentolinium tartrate	Protirelin
Phacetoperane and its salts	Protriptyline and its salts
Phenacemide	Pyrazinamide
Phenaglycodol	Rauwolfia and the following Rauwolfia alkaloids & their salts:
Phenelzine and its salts	Deserpidine
Phenformin and its salts	Raubasine
Pheniprazine and its salts	Rescinnamine
Phenothiazine derivatives, the following and their salts:	Salbutamol and its salts
Butaperazine	Sodium nitroprusside and its salts
Carphenazine	Sotalol and its salts
Etymemazine	Stanozolol
Fluphenazine	Succinimide and its salts & derivatives (except those compounds used for decontaminating water)
Mepazine	Sucralfate
Mesoridazine	Sulfinpyrazone and its salts
Methotrimeprazine	Sulphonal and alkyl sulphonals
Metopimazine	Tamoxifen and its salts
Pericyazine	Temazepam and its salts
Perphenazine	Terbutaline and its salts
Phenthoxate	Thiocarlide
Piperacetazine	Thioguanine
Pipotiazine	Thiotepa
Prochlorperazine	Thiothixene and its salts
Thiethylperazine	Thiouracil and its derivatives
Thiopropazate	Thyroxin and its salts

Timolol and its salts	Polymyxin B (except for topical use or for local action in the oral cavity or nasal passages)
Tinidazole	Spectinomycin
Tolbutamide and its salts & derivatives	Spiramycin
Tolmetin and its salts	Streptomycin
Tranlycypromine	Tetracycline
Treosulfan	Chlorothiazide and its salts & derivatives
Tretamine	Cyclizine
Tretinoin (Vitamin A acid)	Ergot alkaloids and their salts
Triamterene and its salts	Furosemide
Triazolam and its salts	Liothyronine and its salts
Triiodothyropropionic acid	Mebendazole
Trimethadione	Meclizine and its salts
Trimethoprim and its salts	Nicotine and its salts (except in natural substances)
Trimipramine and its salts	Nitrofurans derivatives, the following & their salts:
Trioxsalen	Furaltadone
Tybamate	Furazolidone
Uracil Mustard and its salts	Nitrofurantoin
Valproic acid and its salts	Phenothiazine derivatives, the following & their salts:
Verapamil and its salts	Acepromazine
Vidarabine	Chlorpromazine
Vinblastine and its salts	Promazine
Vincristine and its salts	Trimeprazine
Vitamin B ₁₂ with Intrinsic Factor Concentrate	Physostigmine salicylate (except preparations for oral or topical use only)
Xylazine and its salts	Primidone
Zomepirac and its salts	Reserpine and its salts
(Sched. F, Part I): O. Reg. 835/82, s. 4; O. Reg. 512/87, s. 2 (1); O. Reg. 428/89, s. 2.	Sex hormones, except:

PART II

Adrenocortical hormones and their salts and derivatives except for hydrocortisone preparations containing as a single active ingredient, not more than 0.5 per cent hydrocortisone or hydrocortisone acetate in topical dosage form	Boldenone undecylenate
Aninopyrine and its derivatives	Diethylstilbestrol and its salts & derivatives
Antibiotics, the following and their salts & derivatives:	Megestrol and its salts
Dihydrostreptomycin	Mibolerone
Erythromycin	Stanozolol
Framycetin	Sodium fluoride (in solid oral dosage forms containing more than one milligram of fluoride ion)
Griseofulvin	Sulphonamides and their salts & derivatives
Kanamycin	Thiabendazole
Lincomycin	Thyroid
Neomycin	Veratrum album and its alkaloids & salts of alkaloids
Novobiocin	Veratrum viride and its alkaloids & salts of alkaloids
Nystatin (except preparations for topical use on the skin)	Vitamin A, any preparation for internal or parenteral use in humans containing or represented as containing more than 10,000 International Units in each oral dosage form, or if the largest recommended daily dosage shown on the label thereof, if consumed, would furnish more than 10,000 International Units.
Oleandomycin	Vitamin D, any preparation for internal or parenteral use in humans containing or represented as containing more than 1,000 International Units in each oral dosage form, or if the largest recom-
Penicillin (except amoxicillin, ampicillin, benzathine penicillin, carbenicillin, cloxacillin, dicloxacillin, hetacillin, methicillin, nafcillin, oxacillin and ticarcillin and their salts and derivatives)	

mended daily dosage shown on the label thereof, if consumed, would furnish more than 1,000 International Units.

(Sched. F, Part II): O. Reg. 835/82, s. 4; O. Reg. 512/87, s. 2 (2).

Schedule G

SUBSTANCE

Amphetamine and its salts

Barbituric acid and its salts and derivatives

Benzphetamine and its salts

Methamphetamine and its salts

Methaqualone and its salts

Pentazocine and its salts

Phendimetrazine and its salts

Phenmetrazine and its salts

R.R.O. 1980, Reg. 451, Sched. G.

Schedule N

SUBSTANCE

ITEM

1. Opium Poppy (*Papaver somniferum*) its preparations, derivatives, alkaloids and salts, including:

- (1) Opium
- (2) Codeine (Methylmorphine), except when in preparations listed in Schedule C
- (3) Morphine
- (4) Thebaine

and their preparations, derivatives and salts, including:

- (5) Acetorphine
- (6) Acetyldihydrocodeine
- (7) Benzylmorphine
- (8) Codoxime
- (9) Desomorphine (dihydrodeoxymorphine)
- (10) Diacetylmorphine (heroin)
- (11) Dihydrocodeine
- (12) Dihydromorphine
- (13) Ethylmorphine
- (14) Etorphine
- (15) Hydrocodone (dihydrocodeinone)
- (16) Hydromorphone (dihydromorphinone)
- (17) Hydromorphinal (dihydro-14-hydroxymorphine)
- (18) Methyldesorphine (Δ' -deoxy-6-methylmorphine)
- (19) Methyl dihydromorphine (dihydro-6-methylmorphine)
- (20) Metopon (dihydromethylmorphinone)
- (21) Morphine-N-oxide (morphine-N-oxide)
- (22) Myrophine (benzylmorphine myristate)
- (23) Nalorphine (N-allylnormorphine)
- (24) Nicocodine (6-nicotinylcodeine)
- (25) Nicomorphine (dinicotinylmorphine)
- (26) Norcodeine

(27) Normorphine

(28) Oxycodone (dihydrohydroxycodone)

(29) Oxymorphone (dihydrohydroxymorphinone)

(30) Pholcodine (β -4-morpholinoethylmorphine), and

(31) Thebacon (acetyldihydrocodeinone)

but not including:

(32) Apomorphine

(33) Cyprenorphine

(34) Narcotine

(35) Papaverine, and

(36) Poppy seed

2. Coca (*Erythroxylon*), its preparations, derivatives, alkaloids and salts, including:

(1) Coca leaves

(2) Cocaine, and

(3) Ecgonine (3-hydroxy-2-tropane carboxylic acid)

3. *Cannabis sativa*, its preparations, derivatives and similar synthetic preparations, including:

- (1) Cannabis resin
- (2) Cannabis (marihuana)
- (3) Cannabidiol
- (4) Cannabinol (3-n-myl-6,6,9-trimethyl-6-dibenzopyran-1-ol),
- (5) Pyrahexyl (3-n-hexyl-6,6,9-trimethyl 7-, 8, 9, 10-tetrahydro-6-dibenzopyran-1-ol), and
- (6) Tetrahydrocannabinol

4. Phenylpiperidines, their preparations, intermediates, derivatives and salts, including:

- (1) Allyprodine (3-allyl-1-methyl-4-phenyl-4-piperidylpropionate)
- (2) Alphameprodine (α -3-ethyl-1-methyl-4-phenyl-4-piperidylpropionate),
- (3) Alphaprodine (α -1,3-dimethyl-4-phenyl-4-piperidylpropionate),
- (4) Anileridine (ethyl 1-[2-(paminophenyl) ethyl]-4-phenylpiperidine-4-carboxylate),
- (5) Beta, meprodine (β -3-ethyl-1-methyl-4-phenyl-4-piperidylpropionate),
- (6) Betaprodine (β -1, 3-dimethyl-4-phenyl-4-piperidyl propionate),
- (7) Benzethidine (ethyl 1-(2-benzyloxyethyl)-4-phenylpiperidine-4-carboxylate),
- (8) Diphenoxylate (ethyl 1-(3-cyano-3,3-diphenylpropyl)-4-phenylpiperidine-4-carboxylate),
- (9) Etoxidine (ethyl 1-[2-(2-hydroxyethoxy) ethyl]-4-phenylpiperidine-4-carboxylate),
- (10) Fentanyl (1-phenylethyl-4-(phenylpropionyl-amino) piperidine),
- (11) Furethidine (ethyl 1-(2-tetrahydrofurfuryloxyethyl)-4-phenylpiperidine-4-carboxylate)
- (12) Hydroxypethidine (ethyl 4-(m-hydroxyphenyl)-1-methyl-4-phenylpiperidine-4-carboxylate),
- (13) Ketobemidone

- (1-[4-(*m*-hydroxyphenyl)-1-methyl-4-piperidyl]-1-propanone),
- (14) Methylphenylisonipecotonitrile (4-cyano-1-methyl-4-phenylpiperidine),
- (15) Morpheridine (ethyl 1-(2-morpholinoethyl)-4-phenylpiperidine-4-carboxylate),
- (16) Norpethidine (ethyl 4-phenylpiperidine-4-carboxylate),
- (17) Pethidine (ethyl 1-methyl-4-phenylpiperidine-4-carboxylate),
- (18) Phencyclidine (1-(1-Phenylcyclohexyl) piperidine)
- (19) Phenoperidine (ethyl 1-(3-hydroxy-3-phenylpropyl)-4-phenylpiperidine-4-carboxylate),
- (20) Pimindone (ethyl 1-[3-phenylamino) propyl]-4-phenylpiperidine-4-carboxylate),
- (21) Properidine (isopropyl 1-methyl-4-phenylpiperidine-4-carboxylate), and
- (22) Propiram (N-(1-methyl-2-piperidinoethyl)-N-2-pyridylpropionamide)
- (23) Trimeperidine (1,2-5-trimethyl-4-phenyl-4-piperidyl propionate),
- but not including:
- (24) Carbamethidine (ethyl 1-(2-carbamylethyl)-4-phenylpiperidine-4-carboxylate),
- (25) Oxpheneridine (ethyl 1-(2-hydroxy-2-phenylethyl)-4-phenylpiperidine-4-carboxylate).
5. Phenazepines, their preparations, derivatives and salts, including:
- (1) Proheptazine (hexahydro-1,3-dimethyl-4-phenyl-4-azepinyl propionate),
- but not including:
- (2) Ethoheptazine (ethyl hexahydro-1 methyl-4-phenyl-azepine-4-carboxylate),
- (3) Metethoheptazine (ethyl hexahydro-1,3-dimethyl-4-phenylazepine-4-carboxylate), and
- (4) Methheptazine (ethyl hexahydro-1,2-dimethyl-4-phenylazepine-4-carboxylate).
6. Amidones, their preparations, intermediates, derivatives and salts, including:
- (1) Dimethylaminodiphenylbutanonitrile (4-cyano-2-dimethylamino-4,4-diphenyl butane),
- (2) Dipipanone (4,4-diphenyl-6-piperidino-3-heptanone),
- (3) Isomethadone (6-dimethylamino-5-methyl-4,4-diphenyl-3-hexanone),
- (4) Methadone (6-dimethylamino-4,4-diphenyl-3-heptanone),
- (5) Normethadone (6-dimethylamino-4,4-diphenyl-3-hexanone), and
- (6) Phenadoxone (6-morpholino-4,4-diphenyl-3-heptanone).
7. Methadols, their preparations, derivatives and salts, including:
- (1) Acetylmethadol (6-dimethylamino-4, 4-diphenyl-3-heptanyl acetate),
- (2) Alphacetylmethadol (α -6-dimethylamino-4, 4-diphenyl-3-heptanyl acetate),
- (3) Alphamethadol (α -6-dimethylamino-4, 4-diphenyl-3-heptanol),
- (4) Betacetylmethadol (-6-dimethylamino-4, 4-diphenyl-3-heptanyl acetate),
- (5) Betamethadol (-6-dimethylamino-4,4-diphenyl-3-heptanol), and
- (6) Dimepheptanol (6-dimethylamino-4,4-diphenyl-3-heptanol), and
- (7) Noracymethadol (α -6-methylamino-4,4-diphenyl-3-heptanyl-acetate).
8. Phenalkoxams, their preparations, derivatives and salts, including:
- (1) Dimenoxadol (dimethylaminoethyl 1-ethoxy-1,1-diphenylacetate),
- (2) Dioxaphetylbutyrate (ethyl 2,2-diphenyl-4-morpholino butyrate),
- but not including:
- (3) Propoxyphene (4-dimethylamino-3-methyl-1,2-diphenyl-2-butyl propionate).
9. Thiambutenes, their preparations, derivatives and salts, including:
- (1) Diethylthiambutene (N,N-diethyl-1-methyl-3,3-di-2-thienylallylamine),
- (2) Dimethylthiambutene (N,N,1-trimethyl-3,3-di-2-thienylallylamine), and
- (3) Ethylmethylthiambutene (N-ethyl-N,1-dimethyl-3, 3-di-2-thienylallylamine)
10. Moramides, their preparations, intermediates, derivatives and salts, including:
- (1) Dextromoramide (*d*-1-(3-methyl-4-morpholino-2,2- diphenylbutyryl) pyrrolidine),
- (2) Diphenylmorpholinoisovaleric acid (2-methyl-3-morpholino-1,1-diphenylpropionic acid),
- (3) Levomoramide (*l*-1-(3-methyl-4-morpholino-2,2-di-phenylbutyryl) pyrrolidine), and
- (4) Racemoramide (*d,l*-1 (3-methyl-4-morpholino-2,2- diphenylbutyryl) pyrrolidine).
11. Morphinans, their preparations, derivatives and salts, including:
- (1) Levomethorphan (*l*-1,2,3,9,10,10a-hexahydro-6-methoxyl-11-methyl-4H-10,4a-iminoethanophenanthrene),
- (2) Levorphanol (*l*-1,2,3,9,10,10a-hexahydro-11-methyl-4H-10,4a-iminoethanophenanthren-6-ol),
- (3) Levophenacymorphan (*l*-1,2,3,9,10,10a-hexahydro-11-phenacyl-4H-10,4a-iminoethanophenanthren-6-ol),
- (4) Norlevorphanol (*l*-1,2,3,9,10,10a-hexahydro-4H-10,4a-iminoethanophenanthren-6-ol),
- (5) Phenomorphan (*d,l*-1,2,3,9,10,10a-hexahydro-11-phenethyl-4H-10,4a-iminoethanophenanthren-6-ol),
- (6) Racemethorphan (*d,l*-1,2,3,9,10,10a-hexahydro-6-methoxy-11-methyl-4H-10,4a-iminoethanophenanthrene), and
- (7) Racemorphan (*d,l*-1,2,3,9,10,10a-hexahydro-11-methyl-4H-10,4a-iminoethanophenanthren-6-ol)
- but not including:

- (8) Dextromethorphan (*d*-1,2,3,9,10,10a-hexahydro-6-methoxy-11-methyl-4H-10,4a-iminoethanophenanthrene),
- (9) Dextrorphan (*d*,1,2,3,9,10,10a-hexahydro-11-methyl-4H-10,4-iminoethanophenanthren-6-ol),
- (10) Levallorphan (*l*-11-allyl-1,2,3,9,10,10a-hexahydro-4H-10,4a-iminoethanophenanthren-6-ol), and
- (11) Levargorphan (*l*-11-propargyl-1,2,3,9,10,10a-hexahydro-4H-10,4a-iminoethanophenanthren-6-ol).
12. Benzazocines, their preparations, derivatives and salts, including:
- (1) Phenazocine (1,2,3,4,5,6-hexahydro-6,11-dimethyl-3-phenethyl-2,6-methano-3-benzazocin-8-ol), and
- (2) Metazocine (1,2,3,4,5,6-hexahydro-3,6,11-trimethyl-2,6-methano-3-benzazocin-8-ol),
- but not including:
- (3) Pentazocine (1,2,3,4,5,6-hexahydro-6,11-dimethyl-3-(3-methyl-2-butenyl) 2,6-methano-3-benzazocin-8-ol), and
- (4) Cyclazocine (1,2,3,4,5,6-hexahydro-6,11-dimethyl-3-(cyclopropylmethyl)-2,6-methano-3-benzazocin-8-ol).
13. Ampromides, their preparations, derivatives and salts, including:
- (1) Diampromide (N-[2-(methylphenethyl-amino)-propyl]-propionanilide),
- (2) Phenompromide (N-[2-(1-methyl-2-piperidyl)-ethyl]-propionanilide).
14. Benzimidazoles, their preparations, derivatives and salts, including:
- (1) Clonitazene (2-(*p*-chlorobenzyl)-1-diethylaminoethyl-5-nitrobenzimidazole),
- (2) Etonitazene (2-(*p*-ethoxybenzyl)-1-diethylaminoethyl-5-nitrobenzimidazole).

R.R.O. 1980, Reg. 451, Sched. N.

Health Insurance Act *Loi sur l'assurance-santé*

REGULATION 552

GENERAL

DEFINITIONS

1. In this Regulation,

“benefit period” means the period of time during which an insured person is entitled to insured services;

“hospital” means any hospital that is designated under this Regulation to participate in the Plan;

“in-patient” means a person admitted to and assigned a bed in a hospital in-patient area by the order of a legally qualified medical practitioner;

“nursing home” means a nursing home operated or maintained under the authority of a licence issued under the *Nursing Homes Act*;

“out-patient” means a person who receives out-patient services and is not admitted to an in-patient area;

“prescribed form” means the form prescribed by the General Manager for the purpose;

“recipient of public assistance” means,

- (a) a person who receives benefits under,
 - (i) the *General Welfare Assistance Act*,
 - (ii) the *Vocational Rehabilitation Services Act*,
 - (iii) the *Family Benefits Act*, or
- (b) a child who is made a ward of a children’s aid society or of the Crown under the *Child and Family Services Act*, or a child who is in the care and custody of a children’s aid society but is not a ward of the society;

“standard ward accommodation” means,

- (a) a bed in a hospital area designated by the hospital in accordance with Regulation 794 of Revised Regulations of Ontario, 1990 under the *Ministry of Health Act* as a standard ward, or
- (b) accommodation within the area classed and maintained as a standard ward accommodation in a nursing home as prescribed in section 5 of Regulation 832 of Revised Regulations of Ontario, 1990 under the *Nursing Homes Act*;

“schedule of benefits” means the schedule set out in the publication published by the Ministry of Health titled “Schedule of Benefits” and subtitled “Physician Services under the Health Insurance Act” and “April 1, 1988 Schedule of Benefits revised for the coming into force of the Independent Health Facilities Act, 1989” other than the part of the schedule from and including item L700 on page 177 to and including page 188 and includes the parts of the schedule that deal with what a service encompasses and what fees are payable. R.R.O. 1980, Reg. 452, s. 1; O. Reg. 717/89, s. 1; O. Reg. 156/90, s. 1; O. Reg. 283/90, s. 1.

HEALTH INSURANCE IDENTIFICATION CARD

2.—(1) The General Manager shall issue a health insurance identification card to each insured person. O. Reg. 283/90, s. 2.

(2) A health insurance identification card is nontransferable.

(3) An insured person shall present his or her health insurance identification card upon the request of the hospital, physician or practitioner from whom the person receives insured services. R.R.O. 1980, Reg. 452, s. 18 (3, 4).

PAY-DIRECT PARTICIPATION

3.—(1) A resident who is not otherwise an insured person may become an insured person by submitting an application in the prescribed form to the General Manager. O. Reg. 717/89, s. 11 (1).

(2) A resident making an application under subsection (1), shall be present in Ontario at the time of submitting the application. R.R.O. 1980, Reg. 452, s. 23 (2).

(3) A person taking up residence in Ontario directly from elsewhere in Canada where the person was insured under a government health plan or a hospital insurance plan, and his or her dependants, are entitled to a benefit period commencing on the first day of the third month following that in which he or she takes up residence in Ontario where the person has complied with subsection (1) at any time prior to the date on which such benefit period would commence. R.R.O. 1980, Reg. 452, s. 23 (4).

MISCELLANEOUS

4. Where one or more claims are submitted to the Plan by a practitioner, physician or health facility and it is found that the recipient of the insured service is not an insured person, only the claim or claims which lead to the discovery that the recipient is not an insured person shall be paid. R.R.O. 1980, Reg. 452, s. 26 (3).

5.—(1) Subject to subsection (2), the benefit period of an insured person who ceases to be a resident extends for three months after the date the person ceases to be a resident. O. Reg. 717/89, s. 18.

(2) The benefit period of an insured person who has ceased to be a resident shall not extend so as to overlap any health plan or hospitalization insurance plan coverage. R.R.O. 1980, Reg. 452, s. 35 (2).

6.—(1) In this section,

“active treatment hospital” means a hospital listed in Part 1 of Schedule 1 or Part 1 of Schedule 2 or under the heading “Group A Hospitals”, “Group B Hospitals” or “Group C Hospitals” in the Schedule to Regulation 964 of Revised Regulations of Ontario, 1990;

“chronic care services” means,

- (a) the services designated in section 7, except those designated in paragraph 4, and
- (b) catheter, colostomy and ileostomy sets,

that are provided in a chronic care unit;

“chronic care unit” means an area in a nursing home listed in Schedule 3 that is approved by the Ministry of Health for the provision of chronic care services;

“dependant” means,

- (a) a spouse who was cohabiting with the insured person,
 - (i) immediately prior to the insured person being admitted to a chronic care unit, or
 - (ii) where the insured person was transferred to a chronic care unit from an active treatment hospital, immediately prior to the insured person being admitted to the active treatment hospital, or
- (b) a child who is under eighteen years of age;

“estimated income” means the average income of any nature or kind whatsoever of an insured or of a dependant of an insured person including,

- (a) payments made under any Act of the Parliament of Canada or by Ontario,
- (b) income from salaries and wages,
- (c) income from an interest in or operation of a business, less expenses incurred in earning such gross income, and
- (d) income from investments, less expenses incurred in earning such income,

as estimated by the insured person or the insured person’s representative;

“licensee” means the licensee of a nursing home;

“payment day” means a day on which a person receives chronic care services that is not part of a payment month;

“payment month” means a calendar month, in which a person receives chronic care services on every day of that month;

“spouse” means,

- (a) either of a man and a woman being married to each other, and
- (b) either of a man and a woman not being married to each other who have been cohabiting in a relationship of some permanence for not less than one year,

but does not include a person who is receiving benefits under the *Old Age Security Act* (Canada) or the *Ontario Guaranteed Annual Income Act*. R.R.O. 1980, Reg. 452, s. 37 (1); O. Reg. 829/84, s. 1.

(2) A reference in section 7 to a hospital shall, for the purpose of this section, be deemed a reference to a chronic care unit.

(3) The chronic care units of the nursing homes listed in Schedule 3 are prescribed as health facilities under the Act, and are designated as health facilities for the purpose of section 34.

(4) Chronic care services provided to an insured person, are prescribed as insured services.

(5) It is a condition of payment for insured services pursuant to this section that,

- (a) the General Manager has approved the provision of chronic care services to the insured person in the nursing home which is providing such services;
- (b) chronic care services are medically necessary;
- (c) the insured person was admitted to the chronic care unit on the order of a physician;
- (d) where standard ward accommodation is provided to the insured person, the licensee of the nursing home in which

the chronic care services are provided accepts the payments and co-payments prescribed by this section as payment in full for chronic care services provided; and

- (e) where accommodation other than standard ward accommodation is provided to an insured person, the licensee of the nursing home charges for the provision of private or semi-private accommodation not more than the charges prescribed by section 5 of Regulation 832 of Revised Regulations of Ontario, 1990 under the *Nursing Homes Act*, for private or semi-private accommodation respectively.

(6) Subject to subsection (8), chronic care services require a co-payment by or on behalf of an insured person.

(7) The co-payment referred to in subsection (6) shall be paid to the licensee of the nursing home in which the chronic care unit is located.

(8) The amount of the co-payment referred to in subsection (6) is,

- (a) for each payment month that the chronic care services are received by a person in a category set out in Column 2 of Table 2, the amount prescribed opposite thereto in Column 3 of Table 2 for the period the chronic care services are received in Column 1 of Table 2; and
- (b) for each payment day that the chronic care services are received by a person in a category set out in Column 2 of Table 2, the amount prescribed opposite thereto in Column 4 of Table 2 for the period the chronic care services are received in Column 1 of Table 2. R.R.O. 1980, Reg. 452, s. 37 (2-8).

(9) Subsection (6) does not apply in respect of chronic care services received,

- (a) by a child who is under eighteen years of age;
- (b) during the first sixty days after the person is admitted to a chronic care unit including the date of admission, less the number of days that,
 - (i) chronic care services, or
 - (ii) in-patient services in a hospital listed under the heading “Group F Hospitals” or “Group G Hospitals” in the Schedule to Regulation 964 of Revised Regulations of Ontario, 1990, Part II of Schedule 4 or Part II of Schedule 5,

were received by such person during the 365 days immediately prior to the date of admission;

- (c) during the first 180 days after the person is admitted to a chronic care unit including the date of admission, where the admitting physician certifies, within sixty days after the date of admission, that the person is in a process of rehabilitation or convalescence, but where the admitting physician revokes such certificate prior to the expiry of the 180 days this clause shall not apply in respect of any chronic care services received after such revocation;
- (d) during the next 180 days where the admitting physician, not having revoked the certificate mentioned in clause (c), renews the said certificate prior to the expiry of the first 180 days, but where the admitting physician revokes the renewal at any time during the said next 180 days this clause shall not apply in respect of any chronic care services received after such revocation;
- (e) on the day that the person is discharged from the chronic care unit, except where the person is discharged on the last day of a payment month;
- (f) by a person who, on the day before the date of admission to

the chronic care unit, is receiving benefits under the *General Welfare Assistance Act* or the *Family Benefits Act*;

- (g) by a person who has no dependants, where the estimated income of such person does not exceed \$100;
 - (h) by a person who has one dependant, where the aggregate estimated incomes of the person and the person's dependant do not exceed \$2,480;
 - (i) by a person who has two dependants, where the aggregate estimated incomes of the person and the person's dependants do not exceed \$2,835;
 - (j) by a person who has three dependants, where the aggregate estimated incomes of the person and the person's dependants do not exceed \$3,157;
 - (k) by a person who has four or more dependants, where the aggregate estimated incomes of the person and the person's dependants do not exceed \$3,446. R.R.O. 1980, Reg. 452, s. 37 (9); O. Reg. 479/84, s. 1; O. Reg. 480/84, s. 1; O. Reg. 752/84, s. 1; O. Reg. 206/85, s. 1; O. Reg. 408/85, s. 1; O. Reg. 438/86, s. 1; O. Reg. 457/87, s. 1; O. Reg. 491/88, s. 1; O. Reg. 447/89, s. 1; O. Reg. 414/90, s. 1.
- (10) Despite subsection (8), where a person is provided with a certificate of exemption issued under section 39 of Regulation 366 of Revised Regulations of Ontario, 1990 made under the *Family Benefits Act* the amount of the co-payment is the amount prescribed by subsection (8) less the amount set out in the certificate.
- (11) The General Manager shall make payment to the licensee, where the chronic care services were provided to an insured person during the period set out in Column 1 of Table 3, in the amount set out opposite thereto in,
- (a) Column 2 of Table 3, less the amount of any co-payment that may be prescribed to be made by the person under this section, for each payment month that the chronic care services are received by the insured person; and
 - (b) Column 3 of Table 3, less the amount of any co-payment that may be prescribed to be made by the person under this section, for each payment day that the chronic care services are received by the insured person except the day that the person is discharged from the chronic care unit.
- (12) In addition to the payments under subsection (11), the General Manager shall pay on behalf of a person who is receiving insured services under this section, an amount determined by the General Manager for the cost of drugs provided to an insured person on the prescription or order of a physician or dentist.
- (13) In addition to the insured services prescribed under this section, physiotherapy services rendered in or by a chronic care unit are prescribed as insured services.
- (14) The amount payable by the Plan to the licensee, on behalf of insured persons who are receiving insured services under this section for the insured services prescribed under subsection (13), is \$8.00 for each hour of physiotherapy services provided to insured persons.
- (15) It is a condition for the performance and for payment for insured services prescribed under subsection (13) that the physiotherapy services,

- (a) have been ordered by a physician; and
- (b) are provided for an insured person in a chronic care unit by a physiotherapist. R.R.O. 1980, Reg. 452, s. 37 (10-15).

INSURED HOSPITAL SERVICES IN ONTARIO

7. Subject to section 10, the in-patient services to which an insured person is entitled without charge are all of the following services:

1. Accommodation and meals at the standard or public ward level.
 2. Except for the services of a private duty nurse who is not engaged and paid by the hospital, necessary nursing service that is provided and paid for by the hospital with the approval of the Director of Nursing to meet the medical needs of a patient as determined by the attending physician.
 3. Laboratory, radiological and other diagnostic procedures, together with the necessary interpretations for the purpose of maintaining health, preventing disease and assisting in the diagnosis and treatment of any injury, illness or disability.
 4. Drugs, biologicals and related preparations that are prescribed by an attending physician in accordance with accepted practice and sound teaching and administered in a hospital, but not including any proprietary medicine as defined from time to time by the regulations made under the *Food and Drugs Act* (Canada).
 5. Use of operating room, obstetrical delivery room, and anaesthetic facilities, including necessary equipment and supplies. R.R.O. 1980, Reg. 452, s. 38; O. Reg. 717/89, s. 20, revised.
8. The out-patient services to which an insured person is entitled without charge are all of the following services:
1. Laboratory, radiological, and other diagnostic procedures, together with the necessary interpretations.
 2. The use of radiotherapy, occupational therapy and physiotherapy facilities where available in a hospital in Canada when prescribed by a physician.
 3. The use of speech therapy facilities where available in a hospital in Canada when prescribed by a physician.
 4. The use of diet counselling services when prescribed by a physician.
 5. The hospital component of all other out-patient services, including the use of an operating room and anaesthetic facilities, surgical supplies, necessary nursing service, meals required during a treatment program and the supplying of drugs, biologicals and related preparations that are prescribed by a physician on the medical staff of the hospital in accordance with accepted practice and sound teaching and administered in the hospital, but not including,
 - i. the provision of any proprietary medicine as defined from time to time by the regulations made under the *Food and Drugs Act* (Canada),
 - ii. the provisions of medications for the patient to take home,
 - iii. diagnostic services performed to satisfy the requirements of third parties such as employers and insurance companies, and
 - iv. visits solely for the administration of drugs, vaccines, sera or biological products.
 6. Use of home renal dialysis equipment, supplies and medications where available in a hospital in Canada and prescribed by a physician on the medical staff of that hospital.
 7. Use of home hyperalimentation equipment, supplies and medications where available in a hospital in Ontario and prescribed by a physician on the medical staff of that hospital.
 8. Despite subparagraph ii of paragraph 5, where available in a hospital in Ontario and prescribed by a physician on the

medical staff of that hospital, the provision to haemophilic patients, for use in the home, of equipment, supplies and medications for the emergency treatment of or the prevention of haemorrhage.

9. Despite subparagraph ii of paragraph 5, where prescribed by a physician on the medical staff of a hospital listed under the heading "Group N Hospitals" in the Schedule to Regulation 964 of Revised Regulations of Ontario, 1990 the provision to transplant patients, for use in the home, of the drug Cyclosporine.
10. Despite subparagraph iv of paragraph 5, visits solely for the administration of rabies vaccine.
11. Despite subparagraph ii of paragraph 5, where prescribed by a physician on the medical staff of a hospital listed under the heading "Group R Hospitals" in the Schedule to Regulation 964 of Revised Regulations of Ontario, 1990 (Classification of Hospitals), the provision to patients, for use in the home, of the drug Azidothymidine, commonly called "AZT".
12. Despite subparagraph iv of paragraph 5, visits to a hospital listed under the heading "Group R Hospitals" in the Schedule to Regulation 964 of Revised Regulations of Ontario, 1990 solely for the administration of Azidothymidine, commonly called "AZT".
13. Despite subparagraph ii of paragraph 5, where prescribed by a physician on the medical staff of a hospital listed under the heading "Group S Hospitals" in the Schedule to Regulation 964 of Revised Regulations of Ontario, 1990 (Classification of Hospitals), the provision to patients, for use in the home, of biosynthetic human growth hormone.
14. Despite subparagraph iv of paragraph 5, visits to a hospital listed under the heading "Group S Hospitals" in the Schedule to Regulation 964 of Revised Regulations of Ontario, 1990 solely for the administration of biosynthetic human growth hormone.
15. Despite subparagraph ii of paragraph 5, where prescribed by a physician on the medical staff of a hospital listed under the heading "Group T Hospitals" in the Schedule to Regulation 964 of Revised Regulations of Ontario, 1990 (Classification of Hospitals), the provision to patients, for use in the home, of drugs for cystic fibrosis treatment.
16. Despite subparagraph ii of paragraph 5, where prescribed by a physician on the medical staff of a hospital listed under the heading "Group U Hospitals" in the Schedule to Regulation 964 of Revised Regulations of Ontario, 1990 (Classification of Hospitals), the provision to patients, for use in the home, of drugs for thalassemia treatment. R.R.O. 1980, Reg. 452, s. 39; O. Reg. 662/84, s. 1; O. Reg. 751/84, s. 1; O. Reg. 283/87, s. 1; O. Reg. 427/87, s. 1; O. Reg. 653/89, s. 1; O. Reg. 717/89, s. 21, *revised*.

9.—(1) Subject to section 10 and subsection 11 (1), an insured person is entitled to in-patient services and out-patient services in a hospital listed in Schedule 2 or under the heading "Group A Hospitals", "Group B Hospitals", "Group C Hospitals", "Group E Hospitals", "Group F Hospitals", "Group G Hospitals" or "Group J Hospitals" in the Schedule to Regulation 964 of Revised Regulations of Ontario, 1990 without paying any charge to the hospital for such services. O. Reg. 829/84, s. 2.

(2) Subject to section 10 and subsection 11 (1), an insured person is entitled to receive, in a hospital listed in Schedule 1, such in-patient and out-patient services as are available in the hospital without paying any charge to the hospital for the services. O. Reg. 232/81, s. 1.

(3) Where the attending physician certifies in writing that an insured person's condition is such that the person requires immediate

admission as an in-patient, and standard ward accommodation in an approved hospital is not available because all such accommodation is occupied or where the attending physician certifies in writing that an insured person's condition is such that for the person's own good or for the good of other patients it is necessary that the person be supplied with private or semi-private accommodation, the person shall be provided by the hospital with private or semi-private accommodation without paying any charge to the hospital for such services.

(4) Subject to subsection 11 (1), an insured person is entitled to receive, in a hospital listed in Schedule 4, those insured services that are in accordance with the type of care and treatment designated in the Schedule for that hospital without paying any charge for such services.

(5) Subject to subsection 11 (2), an insured person is entitled to receive, as an out-patient in a rehabilitation centre or crippled children's centre listed in Schedule 6, the insured services indicated in the Schedule without paying any charge to the centre for such services.

(6) Subject to subsection 11 (1), an insured person is entitled to receive computerized axial tomography scanning services with a head scanner in a hospital listed in Part I of Schedule 9 and, when available, with a head scanner in a hospital listed in Part I of Schedule 10, without paying any charge to the hospital for such services.

(7) Subject to subsection 11 (1), an insured person is entitled to receive computerized axial tomography scanning services with a whole body scanner in a hospital listed in Part II of Schedule 9 and, when available, with a whole body scanner in a hospital listed in Part II of Schedule 10, without paying any charge to the hospital for such services.

(8) It is a condition of payment by the Plan to a hospital for the performance of a computerized axial tomography scan that the scan be performed by and on the premises of a hospital listed in Schedule 9. R.R.O. 1980, Reg. 452, s. 40 (3-8).

10. Subsections 6 (6) to (10) with respect to chronic care services apply with necessary modifications to in-patient services in a hospital listed under the heading "Group F Hospitals" or "Group G Hospitals" in the Schedule to Regulation 964 of Revised Regulations of Ontario, 1990, Part II of Schedule 4 or Part II of Schedule 2. O. Reg. 752/84, s. 3.

11.—(1) An insured person is not entitled to insured services in a hospital unless the person has been,

- (a) admitted as an in-patient on the order of a legally qualified medical practitioner;
- (b) received in the hospital and examined as an out-patient by a legally qualified medical practitioner and treated as an out-patient, if necessary; or
- (c) referred to the hospital as an out-patient by,
 - (i) a physician, for any of the services designated in section 8, or
 - (ii) an osteopath or chiropractor, for X-rays.

(2) An insured person is not entitled to receive insured services in a centre listed in Schedule 6 unless he or she has been,

- (a) received in the centre, and examined as an out-patient by a physician; or
- (b) referred to the centre as an out-patient by a physician. R.R.O. 1980, Reg. 452, s. 42.

EXTENDED CARE SERVICES

12.—(1) In this section,

"device" means a catheter, colostomy or ileostomy set;

“extended care services” means,

- (a) standard ward accommodation, meals including special and therapeutic diets, and laundry, including machine washing and drying of personal clothing,
- (b) skilled nursing and personal care given by or under the supervision of a registered nurse or registered nursing assistant under the direction of a physician,
- (c) the provision of routine medical supplies, including wheelchairs and geriatric chairs,
- (d) the provision of personal hygiene supplies,
- (e) the provision of personal grooming supplies and services,

in an extended care unit, or

- (f) accommodation that is being held for a person in an extended care unit where the person is on a casual leave of absence, extended medical leave of absence, medical leave of absence or a vacation leave of absence within the meaning of Regulation 832 of Revised Regulations of Ontario, 1990;

“extended care unit” means an extended care unit in a nursing home that is operated or maintained under the authority of a licence issued under the *Nursing Homes Act*. R.R.O. 1980, Reg. 452, s. 43 (1); O. Reg. 209/84, s. 1 (1).

(2) Except in the case of extended care services that are received by a person who receives benefits under the *General Welfare Assistance Act* or the *Family Benefits Act*, extended care services are prescribed as insured services.

(3) Devices ordered by a physician and provided to a person who is receiving extended care services are prescribed as insured services. R.R.O. 1980, Reg. 452, s. 43 (2, 3).

(4) It is a condition of payment for insured services prescribed under this section that,

- (a) a duly completed application in Form 1 on behalf of the recipient of the insured services has been delivered to the General Manager;
- (b) the extended care services received by the person are medically necessary;
- (c) where the insured services are received by a person after the end of the month in which the person attained the age of eighteen years, the person has paid or has paid on his or her behalf the co-payment prescribed by this section. R.R.O. 1980, Reg. 452, s. 43 (4); O. Reg. 794/81, s. 1 (1); O. Reg. 209/84, s. 1 (2); O. Reg. 646/86, s. 1.

(5) The co-payment that shall be made to the licensee of a nursing home in which an extended care unit is located in order to qualify a person to receive extended care services therein as insured services is the monthly co-payment set out in Column 2 of Table 1 opposite the period the extended care services were received in Column 1 of Table 1, for each full month that the person receives the extended care services.

(6) Except where extended care services are provided to a person on the day the person is discharged from an extended care unit, the co-payment that shall be made to the licensee of a nursing home in which an extended care unit is located in order to qualify a person to receive extended care services therein as insured services is the daily co-payment set out in Column 3 of Table 1 opposite the period the extended care services were received in Column 1 of Table 1, where the extended care services were received by the person for less than a month, or for a day or number of days in excess of a full month, for each day that the person receives the extended care services. O. Reg. 438/86, s. 2 (1).

(7) The General Manager shall make payment to the licensee of a nursing home for the provision therein of extended care services that are insured services, where the extended care services were provided to an insured person during a period set out in Column 1 of Table 1,

- (a) on or before the end of the month in which the insured person attained the age of eighteen years, in the amount set out opposite thereto in Column 6 of Table 1; or
- (b) after the end of the month in which the insured person attained the age of eighteen years, in the amount set out opposite thereto in Column 4 of Table 1,

for each full month that the extended care services were received by the insured person.

(8) The General Manager shall make payment to the licensee of a nursing home for the provision of extended care services that are insured services other than extended care services that are provided to a person on the day that the person is discharged from an extended care unit, where the extended care services were provided to an insured person during a period set out in Column 1 of Table 1 and where the extended care services were provided for less than a month, or for a day or number of days in excess of a full month,

- (a) on or before the end of the month in which the insured person attained the age of eighteen years, in the amount set out opposite thereto in Column 7 of Table 1; or
- (b) after the end of the month in which the insured person attained the age of eighteen years, in the amount set out opposite thereto in Column 5 of Table 1,

for each day that the extended care services were received by the insured person. O. Reg. 438/86, s. 2 (2).

13.—(1) In this section,

“home care facility” means,

- (a) a local board of health of a municipality or a health unit, or
- (b) an agency,

approved by the Minister to provide home care services;

“home care services” means,

- (a) the services that are provided, on a visitation basis, by a nurse or a nursing assistant,
- (b) the services provided, on a visiting basis, by a physiotherapist, occupational therapist, speech therapist, social worker or nutritionist,
- (c) the provision of dressings and medical supplies,
- (d) the provision of diagnostic and laboratory services,
- (e) the provision of hospital and sickroom equipment,
- (f) the provision of transportation services to and from the home to a hospital, health facility or the attending physician's office, as the case may be;

“nurse” means a nurse who holds a certificate of registration under Part IV of the *Health Disciplines Act*;

“nursing assistant” means a nursing assistant who holds a certificate of registration under Part IV of the *Health Disciplines Act*;

“professional service” means nursing, physiotherapy, occupational therapy and speech therapy services. R.R.O. 1980, Reg. 452, s. 44 (1); O. Reg. 126/90, s. 1.

(2) Each home care facility is prescribed as a health facility under the Act, and is designated as a health facility for the purpose of section 34.

(3) Home care services provided by a home care facility to an insured person in his or her home are prescribed as insured services.

(4) It is a condition of payment for insured services under subsection (3) that,

- (a) an application in a form satisfactory to the Minister has been duly completed by a physician on behalf of the insured person;
- (b) the insured person is under the medical supervision of an attending physician who has certified that such services are necessary to enable the insured person to remain in his or her own home or to make possible the person's return to his or her home from a hospital or other institution;
- (c) the needs of the insured person cannot be met on an out-patient basis;
- (d) the insured person is in need of at least one professional service;
- (e) the services are provided in the insured person's home where such has been approved by the Minister as being suitable to enable the required care to be given;
- (f) the services are available in the area where the insured person resides; and
- (g) the services are reasonably expected to result in progress towards rehabilitation.

(5) Physiotherapy, occupational therapy and speech therapy provided by a home care facility to an insured person who,

- (a) is a resident in a nursing home, other than an insured person who is receiving chronic care services that are insured services under section 6;
- (b) is a resident in a home for the aged, established and maintained under the *Homes for the Aged and Rest Homes Act*; or
- (c) is a resident in a charitable institution approved under the *Charitable Institutions Act*,

are prescribed as insured services.

(6) It is a condition of payment for insured services under subsection (5) that,

- (a) an application in a form satisfactory to the Minister has been duly completed by a physician on behalf of the insured person;
- (b) the insured person is under the medical supervision of an attending physician who has certified that such services are medically necessary for the insured person;
- (c) the needs of the insured person cannot be met on an out-patient basis;
- (d) the services are available in the area of the facility in which the insured person is a resident; and
- (e) the services are reasonably expected to result in progress toward rehabilitation. R.R.O. 1980, Reg. 452, s. 44 (2-6).

14.—(1) In this section,

“home care facility” means a home care facility as defined in subsection 13 (1);

“school” means a school as defined in subsection 1 (1) of the *Education Act*;

“school health support services” means,

- (a) the services that are provided, on a visitation basis, by a nurse, physiotherapist, occupational therapist, speech therapist or nutritionist,
- (b) the training, supervision or consultation services of a nurse, physiotherapist, occupational therapist, speech therapist or nutritionist to support personnel referred to in the definition of “special education services” in subsection 1 (1) of the *Education Act*, and
- (c) the provision of dressings and medical supplies necessary for the services referred to in clause (a),

but does not include an item referred to in clause (a), (b) or (c) where the item is being provided by Hotel Dieu Hospital, Kingston, Chedoke-McMaster Hospitals or Laurentian Hospital or a rehabilitation centre or crippled children's centre listed in Schedule 6;

“special education program” means a special education program as defined in subsection 1 (1) of the *Education Act*;

“special education services” means special education services as defined in subsection 1 (1) of the *Education Act*.

(2) School health support services provided by a home care facility to an insured person who is placed in a special education program in a school are prescribed as insured services.

(3) It is a condition of payment for insured services under subsection (2) that,

- (a) an application in a form satisfactory to the Minister is completed by a physician on behalf of the insured person;
- (b) the insured person is under the medical supervision of an attending physician who certifies that the services are necessary to enable the insured person to be placed in a special education program and receive special education services; and
- (c) the services are available in the area where the insured person attends school. O. Reg. 638/84, s. 1.

INSURED AMBULANCE SERVICES

15.—(1) Ambulance services provided by,

- (a) an ambulance service operator listed in Schedule 7; or
- (b) an ambulance service operated by the Province of Ontario,

are insured services, where the insured person pays to the hospital listed in Schedule 1 or 4 or under the heading “Group A Hospitals”, “Group B Hospitals”, “Group C Hospitals”, “Group E Hospitals”, “Group F Hospitals”, “Group G Hospitals” or “Group J Hospitals” in the Schedule to Regulation 964 of Revised Regulations of Ontario, 1990, to or from which the ambulance services are required, a co-payment of \$25. O. Reg. 829/84, s. 3; O. Reg. 595/90, s. 1 (1).

(2) Where ambulance services are provided by air or by rail, including where applicable any ambulance service required to connect with the air or rail facilities, an insured person shall pay as his or her share of the ambulance charges an amount of \$25 a trip by way of co-payment. O. Reg. 53/84, s. 1, *part*; O. Reg. 595/90, s. 1 (2).

(3) An insured person who utilizes a land ambulance service for a purpose that is not medically necessary shall pay an amount of \$185 by way of a co-payment and \$4.50 for each kilometre travelled in excess of forty kilometres. O. Reg. 53/84, s. 1, *part*; O. Reg. 595/90, s. 1 (3).

(4) An insured person who utilizes an air ambulance service that is under charter to the Ministry of Health for a period in excess of twenty-nine days for a purpose that is not medically necessary shall pay an amount of \$600 by way of a co-payment and \$60 for each six

minutes or part thereof flown in excess of one hour. O. Reg. 53/84, s. 1, *part*; O. Reg. 595/90, s. 1 (4).

(5) An insured person who utilizes an ambulance service, other than an ambulance service referred to in subsection (3) or (4), for a purpose that is not medically necessary shall pay the total cost of such ambulance service by way of co-payment. O. Reg. 53/84, s. 1, *part*.

(6) The co-payment prescribed in subsections (1) and (2) does not apply to a person,

- (a) who receives benefits under the *General Welfare Assistance Act* or the *Family Benefits Act*;
- (b) who is transferred from a hospital to another hospital;
- (c) who is transferred from a hospital to a facility listed in Schedule 6;
- (d) who is transferred from a hospital to a facility listed in Schedule 8;
- (e) who is transferred from a hospital to a medical laboratory licensed under the *Laboratory and Specimen Collection Centre Licensing Act*;
- (f) who is transferred from a hospital to a facility registered under the *Healing Arts Radiation Protection Act* for the purpose of radiological examination or treatment;
- (g) who is transferred from one part of a hospital to any other part of the same hospital;
- (h) who is receiving home care services under section 13;
- (i) who is residing in an approved home under section 12 of the *Mental Hospitals Act*;
- (j) who is a resident of a home for special care licensed under the *Homes for Special Care Act*;
- (k) who is a resident of a nursing home operated or maintained under the authority of a licence issued under the *Nursing Homes Act*;
- (l) who is a resident of a home for the aged, or a rest home, under the *Homes for the Aged and Rest Homes Act*; or
- (m) who is a resident of a home for the aged approved under the *Charitable Institutions Act*. R.R.O. 1980, Reg. 452, s. 45 (4); O. Reg. 833/82, s. 1 (2).

SPECIFIED HEALTH CARE SERVICES

16.—(1) The services rendered by dentists that are prescribed as insured services are the services set out in Column 1 of Schedule 13, Schedule 14 and Schedule 15, respectively.

(2) It is a condition for the performance and for payment of the insured services set out in Schedule 13, Schedule 14 and Schedule 15, that they be performed in a hospital by a dentist who has been appointed to the dental staff by the respective hospital on the recommendation of the chief of the surgical staff and the agreement of the Medical Advisory Committee of the respective hospital. R.R.O. 1980, Reg. 452, s. 46 (1, 2).

(3) It is a condition for the performance and for payment of the insured services set out in Schedule 14 that they be performed in conjunction with one or more of the insured services set out in Schedule 13 or Schedule 15. O. Reg. 455/86, s. 1.

(4) It is a condition for the performance and for payment of the insured services set out in Schedule 15 that,

- (a) hospitalization is medically necessary; and

(b) there is prior approval by the General Manager of the provision of such service.

(5) The amount payable by the Plan for a service set out in Column 1 of Schedule 13, Schedule 14 and Schedule 15, as the case may be, is the amount set out opposite the service in Column 2 where the service is performed by a dental surgeon or the amount set out opposite the service in Column 3 where the service is performed by an oral surgeon.

(6) The following services are prescribed as insured services under the Plan:

1. All services rendered by a hospital in connection with dental surgical procedures not specified in subsection (1), (3) or (5).

(7) It is a condition for the performance and for payment of the insured services prescribed under subsection (6) that hospitalization is medically necessary. R.R.O. 1980, Reg. 452, s. 46 (4-7).

17.—(1) A first oculo-visual assessment visit for an eye examination or evaluation and all follow-up oculo-visual visits on the same day rendered by an optometrist, including the determination of the refractive status of the eye, the presence of any observed abnormality in the visual system and all necessary procedures connected thereto and, if required, the provision of a written prescription, is prescribed as an insured service under the Plan.

(2) A follow-up oculo-visual assessment visit for an eye examination or evaluation on a subsequent day and all oculo-visual visits on the same day rendered by an optometrist for a specific optometrical procedure required for a particular condition is prescribed as an insured service under the Plan. O. Reg. 233/89, s. 1 (1).

(3) The amount payable by the Plan for the service prescribed in subsection (1) is \$39.15. O. Reg. 511/90, s. 1 (1).

(4) The amount payable by the Plan for the service prescribed in subsection (2) is \$19.25. O. Reg. 511/90, s. 1 (2).

(5) It is a condition for the performance of an insured service prescribed under subsection (1) that the service is rendered more than one year after the date of rendering of a first oculo-visual assessment visit, if the service is rendered by the same optometrist who rendered the first oculo-visual assessment visit. O. Reg. 233/89, s. 1 (4).

(6) Subsection (5) does not apply in respect of the initial first oculo-visual assessment visit rendered to an insured person by an optometrist on or after the 1st day of April, 1989. O. Reg. 233/89, s. 1 (5).

(7) The amount payable by the Plan for the services prescribed in subsection (1) is, where the services are provided to an insured person on or after the 1st day of January, 1987, the fee listed for such services in the following fee Schedule:

1. Oculo-Visual Assessment	\$34.70
2. Oculo-Visual Re-Assessment	20.70
3. Partial Oculo-Visual Assessment	13.65

O. Reg. 746/86, s. 1, *part*.

(8) Optometry is designated as a discipline for the purpose of section 16 of the Act.

(9) An optometrist who does not submit accounts directly to the Plan may commence to bill the Plan by giving written notice to the General Manager that he or she intends to bill the Plan directly and the notification becomes effective the first day of the third month following the month in which the General Manager receives the notification but may become effective on an earlier date as ordered by the General Manager. R.R.O. 1980, Reg. 452, s. 47 (4, 5).

18.—(1) The following services rendered by chiropractors are prescribed as insured services under the Plan:

1. Initial service (office or institutional).
2. Subsequent service.
3. Home service.
4. Radiographic examination of the cervical spine — minimum of antero-posterior and lateral views.
5. Radiographic examination of the thoracic spine — minimum of antero-posterior and lateral views.
6. Radiographic examination of the lumbar spine — minimum of antero-posterior and lateral views.
7. Radiographic examination of the pelvis and sacrum — minimum of antero-posterior and lateral views.
8. Radiographic examination of the antero-posterior full spine — one view.
9. Radiographic examination of the antero-posterior full spine plus one additional view.
10. Radiographic examination of the antero-posterior full spine plus two additional views.
11. Radiographic examination of the ribs — minimum of antero-posterior and lateral views.
12. Radiographic examination of any extremity — minimum of two views.
13. Special added view of any of the above. R.R.O. 1980, Reg. 452, s. 48 (1).

(2) Subject to subsections (3) and (4), the amount payable by the Plan for the services prescribed under subsection (1) is, where the services are provided to an insured person on or after the 1st day of July 1989, as follows:

1. Initial service (office or institutional)	\$11.75
2. Subsequent service	9.65
3. Home service	12.00
4. Radiographic examination of the cervical spine — minimum of antero-posterior and lateral views	16.00
5. Radiographic examination of the thoracic spine — minimum of antero-posterior and lateral views	16.00
6. Radiographic examination of the lumbar spine — minimum of antero-posterior and lateral views	16.00
7. Radiographic examination of the pelvis and sacrum — minimum of antero-posterior and lateral views ..	16.00
8. Radiographic examination of the antero-posterior full spine — one view	16.00
9. Radiographic examination of the antero-posterior full spine plus one additional view	28.00
10. Radiographic examination of the antero-posterior full spine plus two additional views	35.00
11. Radiographic examination of the ribs — minimum of antero-posterior and lateral views	16.00
12. Radiographic examination of any extremity — minimum of two views	16.00

13. Special added view of any of the above — per view \$ 8.00

O. Reg. 480/89, s. 1 (1), *part.*

(3) The maximum amount payable by the Plan for the radiographic services prescribed in subsection (1) is, where the services are provided to an insured person on or after the 1st day of July, 1985, in respect of each insured person, \$40 per twelve-month period. O. Reg. 330/85, s. 1 (2), *part.*

(4) The maximum amount payable by the Plan for the services prescribed in subsection (1) is, where the services are provided to an insured person on or after the 1st day of July, 1989, in respect of each insured person, \$220 per twelve-month period. O. Reg. 480/89, s. 1 (2), *part.*

19.—(1) The following services rendered by osteopaths are prescribed as insured services under the Plan:

1. Initial service (office or institutional).
2. Subsequent service.
3. Home service.
4. Radiographic examination.

R.R.O. 1980, Reg. 452, s. 49 (1).

(2) The amount payable by the Plan for the services prescribed in subsection (1) is, where the services are provided to an insured person on or after the 1st day of July, 1989, as follows:

1. Initial service (office or institutional)	\$12.00
2. Subsequent service	9.00
3. Home service	15.00
4. Radiographic examination	10.00

O. Reg. 481/89, s. 1 (1), *part.*

(3) The maximum amount payable by the Plan for the radiographic services prescribed in subsection (1) is, in respect of each insured person, \$25 per twelve-month period. O. Reg. 139/81, s. 1 (2), *part.*

(4) The maximum amount payable by the Plan for the services prescribed in subsection (1) is, where the insured services are provided to an insured person on or after the 1st day of July, 1989, in respect of each insured person, \$155 per twelve-month period.

(5) For the purposes of subsections (3) and (4), “twelve-month period” means the period from and including the 1st day of July in any year to and including the 30th day of June in the following year. O. Reg. 481/89, s. 1 (3).

20.—(1) Chiropodist services rendered by a chiropodist in Ontario, other than a chiropodist registered under subsection 3 (3) or (4) of Regulation 73 of Revised Regulations of Ontario, 1990 (General) made under the *Chiropody Act*, and podiatrist services rendered by a podiatrist outside Ontario are prescribed as insured services. O. Reg. 315/90, s. 1, *part.*

(2) The amounts payable by the Plan for services prescribed as insured services in subsection (1) and rendered on or after the 1st day of February, 1990 are as follows:

1. Initial office visit	\$16.40
2. Subsequent office visit	11.45
3. Home visit	14.00
4. Institution visit.....	7.00
5. X-ray of foot — antero-posterior and lateral views	11.00

6. X-ray of feet, including one view of each foot..... \$ 11.00
7. Oblique or special view of foot 5.50

O. Reg. 315/90, s. 1, *part*; O. Reg. 515/90, s. 1.

(3) The maximum amount payable by the Plan for the services set out in subsection (2), excluding radiographic examinations, in respect of an insured person is \$130 for services rendered on or after the 1st day of July, 1989 and before the 1st day of July, 1990 and \$135 for services rendered on or after the 1st day of July, 1990 and before the 1st day of July, 1991.

(4) The maximum amount payable by the Plan for radiographic examinations set out in subsection (2) in respect of an insured person is \$30 for services rendered on or after the 1st day of July in any year and before the 1st day of July in the following year. O. Reg. 315/90, s. 1, *part*.

21.—(1) Physiotherapy services are insured services where ordered by a physician and provided by a physiotherapist in a physiotherapy facility listed in Part I of Schedule 5. O. Reg. 390/86, s. 1 (1), *part*.

(2) The amount payable by the Plan for an insured service referred to in subsection (1) is, for service provided to the insured person on or after the 1st day of October, 1987, \$11.50. O. Reg. 390/86, s. 1 (1), *part*; O. Reg. 689/88, s. 1 (1); O. Reg. 584/89, s. 1 (1), *revised*.

(3) Physiotherapy services are insured services where the services are ordered by a physician and are provided to an insured person in his or her home by a physiotherapist who works in a physiotherapy facility listed in Part I or II of Schedule 5. O. Reg. 179/86, s. 1, *part*.

(4) The amount payable by the Plan for an insured service referred to in subsection (3) is, for service provided to the insured person on or after the 1st day of October, 1987, \$23. O. Reg. 390/86, s. 1 (2); O. Reg. 689/88, s. 1 (2); O. Reg. 584/89, s. 1 (2), *revised*.

(5) Payment for an insured physiotherapy service may only be made,

- (a) to the physiotherapy facility which performed the service;
- (b) upon the physiotherapy facility submitting an account therefor to the Plan; and
- (c) if the physiotherapy facility accepts the payment as constituting payment in full for the service. R.R.O. 1980, Reg. 452, s. 51 (3).

22.—(1) A laboratory service is an insured service where the laboratory service is a test within the meaning of section 5 of the *Laboratory and Specimen Collection Centre Licensing Act* and,

- (a) the test is specifically authorized on Form 2 by a physician who has clinically assessed the patient to whom the test relates; and
- (b) the test is performed in a laboratory, other than a hospital laboratory, licensed under the *Laboratory and Specimen Collection Centre Licensing Act* to perform the test for which payment is claimed.

(2) Laboratory services are insured services,

- (a) if the services are authorized by a medical director of a laboratory;
- (b) if the results of the tests authorized by a physician who has clinically assessed a patient yield abnormal findings or information that, without the laboratory services, would be

incomplete or insufficient or meaningless to the physician; and

- (c) if the services are performed in a laboratory, other than a hospital laboratory, licensed under the *Laboratory and Specimen Collection Centre Licensing Act* to perform the laboratory services for which payment is claimed. O. Reg. 192/89, s. 1, *part*.

(3) The amount payable by the Plan for an insured service rendered by a laboratory on or after the 1st day of July, 1988 and before the 1st day of October, 1989 is 49.9 cents multiplied by the applicable individual unit value for such service set out opposite the service in Schedule 11.

(4) The amount payable by the Plan for an insured service rendered by a laboratory on or after the 1st day of October, 1989 is 51.7 cents multiplied by the applicable individual unit value for such service set out opposite the service in Schedule 11.

(5) Despite subsection (4), if the tests T-3 Uptake and T-4, Total (Thyroxine) are specifically authorized on Form 2 by a physician who has clinically assessed the patient to whom the tests relate and the tests are insured services rendered by a laboratory on or after the 1st day of October, 1989, the amount payable by the Plan for the tests is \$15.51. O. Reg. 583/89, s. 1 (1), *part*.

(6) Despite subsection (3), the amount payable by the Plan for an insured service rendered by a laboratory in a time period set out in Column 1 of Table 4 is,

- (a) where the service is authorized by a physician who has clinically assessed the patient;
- (b) where the physician does not hold a certificate from the Royal College of Physicians and Surgeons of Canada in a specialty; and
- (c) where the total individual unit values for the services authorized by the physician during the period set out opposite thereto in Column 2 of Table 4 are greater than 150,000 but less than 200,001,

the amount arrived at by multiplying the applicable individual unit value for such service set out opposite the service in Schedule 11 by the amount calculated by,

- (d) multiplying the first 150,000 individual unit values by the amount set out opposite thereto in Column 3 of Table 4;
- (e) multiplying the excess by the amount set out opposite thereto in Column 4 of Table 4;
- (f) adding the amounts arrived at under clauses (d) and (e); and
- (g) dividing the amount arrived at under clause (f) by the total individual unit values. O. Reg. 192/89, s. 1, *part*; O. Reg. 40/90, s. 1 (1).

(7) Despite subsection (3), the amount payable by the Plan for an insured service rendered by a laboratory in a time period set out in Column 1 of Table 5 is,

- (a) where the service is authorized by a physician who has clinically assessed the patient;
- (b) where the physician does not hold a certificate from the Royal College of Physicians and Surgeons of Canada in a specialty; and
- (c) where the total individual unit values for the services authorized by the physician during the period set out opposite thereto in Column 2 of Table 5 are greater than 200,000,

the amount arrived at by multiplying the applicable individual unit

value for such service set out opposite the service in Schedule 11 by the amount calculated by,

- (d) multiplying the first 150,000 individual unit values by the amount set out opposite thereto in Column 3 of Table 5;
- (e) multiplying the next 50,000 individual unit values by the amount set out opposite thereto in Column 4 of Table 5;
- (f) multiplying the excess by the amount set out opposite thereto in Column 5 of Table 5;
- (g) adding the amounts arrived at under clauses (d), (e) and (f); and
- (h) dividing the amount arrived at under clause (g) by the total individual unit values. O. Reg. 192/89, s. 1, *part*; O. Reg. 40/90, s. 1 (2).

(8) Despite subsections (3) and (4), if the amount paid by the Plan for insured services rendered by a laboratory during the period set out in Column 1 of Table 6 is less than the sum of the product obtained by multiplying the amount set out opposite thereto in Column 5 by the total individual unit values for insured services rendered by the laboratory during the period set out opposite thereto in Column 3 and the product obtained by multiplying the amount set out opposite thereto in Column 6 by the total individual unit values for insured services rendered by the laboratory during the period set out opposite thereto in Column 4, the amount payable by the Plan for an insured service rendered by the laboratory in a time period set out opposite thereto in Column 2, is the amount arrived at according to the following formula:

$$a = (b/(c+d))e$$

where a = the amount payable by the Plan

- b = the amount paid by the Plan for insured services rendered by the laboratory during the period set out in Column 1 of Table 6
- c = the product obtained by multiplying the amount set out opposite thereto in Column 5 by the total individual unit values for insured services rendered by the laboratory during the period set out opposite thereto in Column 3
- d = the product obtained by multiplying the amount set out opposite thereto in Column 6 by the total individual unit values for insured services rendered by the laboratory during the period set out opposite thereto in Column 4
- e = the product obtained by multiplying the amount set out opposite thereto in Column 7 by the applicable individual unit value for the insured service set out opposite the service in Schedule 11. O. Reg. 40/90, s. 1 (3).

(9) Despite subsections (5) and (8), if the amount paid by the Plan for insured services rendered by a laboratory during the period set out in Column 1 of Table 6 is less than the sum of the product obtained by multiplying the amount set out opposite thereto in Column 5 by the total individual unit values for insured services rendered by the laboratory during the period set out opposite thereto in Column 3 and the product obtained by multiplying the amount set out opposite thereto in Column 6 by the total individual unit values for insured services rendered by the laboratory during the period set out opposite thereto in Column 4, the amount payable by the Plan for the tests T-3 Uptake and T-4, Total (Thyroxine) that are specifically authorized on Form 2 by a physician who has clinically assessed the patient to whom the tests relate, and that are insured services rendered by the laboratory on or after the 1st day of October, 1989 is the amount arrived at according to the following formula:

$$a = (b/(c + d))e$$

where a = the amount payable by the Plan

- b = the amount paid by the Plan for insured services rendered by the laboratory during the period set out in Column 1 of Table 6
- c = the product obtained by multiplying the amount set out opposite thereto in Column 5 by the total individual unit values for insured services rendered by the laboratory during the period set out opposite thereto in Column 3
- d = the product obtained by multiplying the amount set out opposite thereto in Column 6 by the total individual unit values for insured services rendered by the laboratory during the period set out opposite thereto in Column 4
- e = \$15.51. O. Reg. 583/89, s. 1 (2).

(10) Payment for an insured laboratory service may only be made,

- (a) to the licensee of the laboratory that performed the service;
- (b) upon the licensee submitting an account therefor to the Plan; and
- (c) if the licensee accepts the payment as constituting payment in full for the service. O. Reg. 192/89, s. 1, *part*.

23. It is a condition for payment for insured services rendered in Ontario in or by a health facility that an account for the insured services is submitted to the General Manager by the health facility not later than six months after the insured services are performed. O. Reg. 557/89, s. 1.

EXCLUSIONS

24.—(1) The following are deemed not to be insured services and not to be part of insured services rendered by physicians or practitioners:

1. Travelling to visit an insured person outside the usual geographical area of practice of the person making the visit.
2. Toll charges for long distance telephone calls.
3. Preparing or providing a device that is not implanted by means of an incision and that is used for therapeutic purposes unless,
 - i. the device is used to permit or facilitate a procedure or examination, or
 - ii. the device is a cast for which there is a fee listed in the schedule of benefits.
4. Preparing or providing,
 - i. a drug, antigen, antiserum or other substance used for treatment that is not used to facilitate a procedure or examination, or
 - ii. a drug to promote ovulation.
5. Advice given by telephone to an insured person at the request of the person or the person's representative unless advice by telephone is specifically listed as an insured service or part of an insured service in the schedule of benefits.
6. An interview or case conference in respect of an insured person that,
 - i. lasts more than twenty minutes, and
 - ii. includes a professional, none of whose services are insured services.

7. The preparation and transfer of an insured person's health records when this is done because the care of the person is being transferred at the request of the person or the person's representative.
 8. A service that is required by a statute or regulation or that is for a person other than the patient, except,
 - i. preparing or submitting documents or records or providing information for use in programs administered by the Ministry of Health,
 - ii. keeping and maintaining appropriate physician's or practitioner's records,
 - iii. obtaining consents or delivering written consents,
 - iv. preparing or submitting documents or records required by or for a health facility as defined in the *Independent Health Facilities Act*,
 - v. conferring with or providing advice, direction, information or records to physicians and other professionals associated with the health and development of the patient except as set out in paragraphs 6 and 7,
 - vi. an examination rendered by a psychiatrist who is not a member of the medical staff of a psychiatric facility in which a patient is detained, for the purpose of clause 49 (4) (b) of the *Mental Health Act*, or
 - vii. an examination rendered and documentation prepared by a physician for the purpose of an investigation or confirmation of an alleged sexual assault.
 9. The providing of a prescription to an insured person if the person or the person's personal representative requests the prescription and no concomitant insured service is provided.
 10. A service that is solely for the purpose of altering the appearance of an insured person except for otoplasty for the correction of outstanding ears of a person under the age of eighteen years.
 11. An anaesthetic service rendered by a physician in connection with,
 - i. a service rendered by a practitioner that is provided outside a hospital, or
 - ii. a dental service that is not insured, is provided in a hospital and involves only the removal of impacted teeth.
 12. The fitting of contact lenses other than for,
 - i. aphakia,
 - ii. myopia greater than 9 dioptres,
 - iii. irregular astigmatism resulting from post corneal grafting or corneal scarring from disease, or
 - iv. keratoconus.
 13. An acupuncture procedure.
 14. Psychological testing.
 15. A service that is part of a group screening program.
 16. An examination or procedure for the purpose of a research or survey program other than an assessment that is necessary to determine if an insured person is suitable for the program.
 17. Treatment for a medical condition that is generally accepted within Ontario as experimental.
 18. Psychotherapy that is a requirement for the patient to obtain a diploma or degree or to fulfil a course of study.
 19. A missed appointment or procedure.
- (2) The following are deemed not to be insured services:
1. A laboratory service except a laboratory service,
 - i. that is an insured service under section 22, or
 - ii. that is carried out by a physician only for the purpose of diagnosing or treating one of his or her patients.
 2. A service provided by a laboratory, physician or hospital that supports a service that is deemed to be not insured under paragraph 8, 10, 13, 15, 16 or 17 of subsection (1) or paragraph 1.
 3. A service provided by a laboratory and ordered by a dentist, osteopath, chiropractor or chiropodist. O. Reg. 156/90, s. 2.
- 25.—(1) The following services rendered outside of Ontario by physicians shall be deemed not to be insured services in respect of insured persons who are under the age of sixteen years:
1. Ligation, cauterization or removal of vas deferens — uni or bilateral (vasectomy).
 2. Hysterectomy or Ligation, cauterization or removal of fallopian tubes — uni or bilateral by abdominal or vaginal approach, including laparoscopy, culdoscopy, or hysteroscopy — for sterilization (any method).
- (2) All services rendered outside of Ontario by hospitals in connection with the services specified in subsection (1) shall be deemed not to be insured services in respect of insured persons who are under the age of sixteen years.
- (3) Subsections (1) and (2) do not apply where the surgeon or the attending physician believes that the surgical operation is medically necessary for the protection of the physical health of the insured person. R.R.O. 1980, Reg. 452, s. 55.
- 26.—(1) In this section,
- “patient” means a patient as defined in section 1 of the *Mental Health Act*;
- “psychiatric facility” means a psychiatric facility as defined in section 1 of the *Mental Health Act*;
- “psychiatrist” means a psychiatrist as defined in section 1 of the *Mental Health Act*.
- (2) The following services are not insured services under the Plan:
1. Any service or examination for the purpose of legal requirements or proceedings, other than an examination rendered,
 - i. by a psychiatrist, who is not a member of the medical staff of a psychiatric facility in which a patient is detained, for the purpose of clause 49 (4) (b) of the *Mental Health Act*,
 - ii. and documentation prepared by a physician for the purpose of an investigation or confirmation of an alleged sexual assault. O. Reg. 298/81, s. 2; O. Reg. 332/81, s. 3.
- INSURED SERVICES OUTSIDE ONTARIO AMBULANCE SERVICES
27. Where an insured person receives ambulance services outside

Ontario, the General Manager may cause to be paid to or on behalf of such insured person 75 per cent of the charges for such services if the insured person presents to the General Manager,

- (a) a detailed receipt for the ambulance services, showing the number of miles that the person was transported; and
- (b) a certificate signed by a medical practitioner stating that the ambulance services were justified on medical grounds,

but the General Manager shall not cause to be paid an amount greater than the Plan would be required to pay for the same or similar ambulance services over the same traversed distance in Ontario. R.R.O. 1980, Reg. 452, s. 56.

HOSPITAL SERVICES

28.—(1) An insured person who receives treatment in a hospital outside Ontario as an in-patient or an out-patient may be reimbursed by the Plan for all or part of the cost of insured services received, on presentation to the General Manager of a detailed receipt from the hospital for payment made to the hospital by the person, or the General Manager may cause payment to be made directly to the hospital for insured services received by the insured person, where,

- (a) the hospital that supplied the care and treatment is approved by the General Manager for the purpose of the Plan;
- (b) the hospital that supplied the care and treatment is licensed or approved as a hospital by the governmental hospital licensing authority in whose jurisdiction the hospital is situated;
- (c) in the case of services to an in-patient, the hospital certifies to the General Manager,
 - (i) that the insured person was admitted with, the date of admission,
 - (ii) the diagnosis of the condition for which the insured person was admitted,
 - (iii) the date of discharge or death of the insured person,
 - (iv) the nature of any complication, complications, or sequelae, if any, that warrant a longer than average stay in hospital of a person with the disease or condition from which the insured person was suffering,
 - (v) the kind and number of any laboratory, radiological or other special diagnostic tests performed on or for the insured person,
 - (vi) the nature of any special treatment procedures or surgery that were performed on the insured person,
 - (vii) the discharge diagnosis or cause of death, as the case may be, and
 - (viii) such other information as is required or requested by the General Manager; and
- (d) the accommodation and services received do not constitute, in the opinion of the General Manager, an extended care facility or the domiciliary type of care provided in a home for the aged, an infirmary or other institution of a similar character.

(2) Where a person receives treatment in a hospital outside Canada as an in-patient or out-patient, the cost of the insured services paid by the Plan shall be the amount determined by the General Manager for that hospital.

(3) Where an insured person receives treatment in a hospital outside Ontario for an acute attack of tuberculosis, the Plan may reimburse the insured person for the cost thereof for a period not exceed-

ing sixty days and subsections (1) and (2) apply. R.R.O. 1980, Reg. 452, s. 57.

HEALTH SERVICES

29.—(1) The amount payable by the Plan for an insured service rendered by a physician outside Ontario to an insured person on or after the 22nd day of April, 1990 is the lesser of,

- (a) the amount actually billed by the physician; or
- (b) the amount set out opposite the service in the schedule of benefits or 51.7 cents multiplied by the applicable individual unit value for such service set out opposite the service in Schedule I1, as the case may be.

(2) Despite subsection (1), the amount payable by the Plan for an insured service rendered by a physician outside Ontario to an insured person on or after the 22nd day of April, 1990 is, for the services Vital capacity, FEV₁, FEV₁/FVC with or without MMEFR (FEF 25-75) calculation, Repeat J301 after bronchodilator, Flow volume loop (FVC, FEV₁, FEV₁/FVC, V₅₀, V₂₅), and Repeat J304 after bronchodilator listed under the heading of "Pulmonary Function Studies" of the schedule of benefits, is the lesser of,

- (a) the amount actually billed by the physician; or
- (b) the amount calculated by adding the amount set out opposite the service in Column P and the amount set out opposite the service in Column T.

(3) Despite subsections (1) and (2), if the services Vital capacity, FEV₁, FEV₁/FVC with or without MMEFR (FEF 25-75) calculation and Flow volume loop (FVC, FEV₁, FEV₁/FVC, V₅₀, V₂₅) are rendered together by a physician outside Ontario to an insured person on or after the 22nd day of April, 1990, the amount payable by the Plan for the services is the lesser of,

- (a) the amount actually billed by the physician; or
- (b) \$31.50.

(4) Despite subsection (1), the amount payable by the Plan for an insured service rendered by a physician outside Ontario to an insured person on or after the 22nd day of April, 1990 and listed under the heading "Nuclear Medicine — In Vivo", "Diagnostic Radiology", "Diagnostic Ultrasound" or "Pulmonary Function Studies" of Schedule 16 is the lesser of,

- (a) the amount actually billed by the physician; or
- (b) the amount calculated by adding the amount set out opposite the service and, for a service listed under the heading,
 - (i) "Nuclear Medicine — In Vivo",
 - (A) for visual inspection of imaging studies, the amount, or
 - (B) for visual inspection of imaging studies and quantification or data manipulation, 130 per cent of the amount,

set out opposite the service in Column P₁ or P₂ of the schedule of benefits, as the case may be, except for Tomography (SPECT), Myocardial wall motion studies, and Myocardial wall motion studies with ejection fraction, in which case, the amount set out opposite the service in Column P₁ or P₂, as the case may be, or

- (ii) "Diagnostic Radiology", "Diagnostic Ultrasound" or "Pulmonary Function Studies", the amount set out opposite the service in Column P of the schedule of benefits.

(5) Despite subsection (4), if the services Bone scintigraphy —

general survey and Bone scintigraphy — single site are rendered together by a physician outside Ontario to an insured person on or after the 22nd day of April, 1990, the amount payable by the Plan for the services is the lesser of,

- (a) the amount actually billed by the physician; or
- (b) the amount calculated by adding \$98.80 and,
 - (i) for visual inspection of imaging studies, the amount, or
 - (ii) for visual inspection of imaging studies and quantification or data manipulation, 130 per cent of the amount,

set out opposite Bone scintigraphy — general survey in Column P₁ or P₂ of the schedule of benefits, as the case may be.

(6) Despite subsection (4), if the services Bone scintigraphy — general survey or Bone scintigraphy — single site and First transit with blood pool images are rendered together by a physician outside Ontario to an insured person on or after the 22nd day of April, 1990, the amount payable by the Plan for the services is the lesser of,

- (a) the amount actually billed by the physician; or
- (b) the amount calculated by adding \$15.30, the amount set out opposite Bone scintigraphy — general survey or Bone scintigraphy — single site, as the case may be, in Schedule 16 and,
 - (i) for visual inspection of imaging studies, the amounts, or
 - (ii) for visual inspection of imaging studies and quantification or data manipulation, 130 per cent of the amounts,

set out opposite First transit without blood pool images and Bone scintigraphy — general survey or Bone scintigraphy — single site, as the case may be, in Column P₁ or P₂ of the schedule of benefits, as the case may be.

(7) Despite subsection (4), the amount payable by the Plan for an insured service rendered by a physician outside Ontario to an insured person on or after the 22nd day of April, 1990 is for the services Brain scintigraphy, Perfusion lung scintigraphy, Ventilation lung scintigraphy, Perfusion and ventilation scintigraphy — same day, and Liver/spleen scintigraphy listed under the heading “Nuclear Medicine — In Vivo” of Schedule 16, if the service is limited to one view, the lesser of,

- (a) the amount actually billed by the physician; or
- (b) 50 per cent of the amount calculated by adding the amount set out opposite the service in Schedule 16 and the amount set out opposite the service in the Column P₁ or P₂ of the schedule of benefits, as the case may be.

(8) Despite subsection (4), the amount payable by the Plan for an insured service rendered by a physician outside Ontario to an insured person on or after the 22nd day of April, 1990 and listed under the heading “Diagnostic Radiology” of Schedule 16 is, if less than the minimum number of views set out opposite the service is rendered, the lesser of,

- (a) the amount actually billed by the physician; or
- (b) 75 per cent of the amount calculated by adding the amount set out opposite the service in Schedule 16 and the amount set out opposite the service in Column P of the schedule of benefits.

(9) Despite subsection (4), if the services Carbon monoxide diffusing capacity by steady state at rest and Carbon monoxide diffusing capacity by single breath method are rendered together by a physi-

cian outside Ontario to an insured person on or after the 22nd day of April, 1990, the amount payable by the Plan for the services is the lesser of,

- (a) the amount actually billed by the physician; or
- (b) \$35.80. O. Reg. 156/90, s. 4, *part.*

(10) Subject to section 30, payment for insured services specified in sections 16 to 19 and section 21 rendered by a practitioner outside Ontario shall be in the amounts actually billed or in the amounts prescribed under sections 16 to 19 and section 21, whichever is the lesser. O. Reg. 36/81, s. 2, *part.*

30.—(1) Where physiotherapy services are performed in Canada but outside Ontario they are an insured service only when performed on an in-patient or out-patient basis in a hospital.

(2) Where physiotherapy, radiotherapy, occupational therapy or speech therapy services are performed outside Canada they are an insured service only when performed on an in-patient basis in a hospital or on an out-patient basis in a hospital upon discharge as an in-patient where the services performed on an out-patient basis are for the treatment of the same condition as was treated on an in-patient basis. O. Reg. 363/81, s. 1.

31. If an insured person, while outside Ontario, received an insured service rendered by a laboratory on or after the 1st day of October, 1989 that was authorized by a physician practising outside Ontario, the General Manager may cause to be paid to or on behalf of the insured person 51.7 cents multiplied by the applicable individual unit value for such service set out opposite the service in Schedule 11. O. Reg. 583/89, s. 3, *part.*

32.—(1) A private clinic outside Canada that renders renal dialysis services is prescribed as a health facility for the purposes of the Act.

(2) Renal dialysis services rendered by private clinics outside Canada are prescribed as insured services. O. Reg. 743/81, s. 1.

(3) The amount payable by the Plan for the insured services prescribed in subsection (2) is the cost of the insured services to an insured person. R.R.O. 1980, Reg. 452, s. 62 (3).

33.—(1) A facility outside Ontario, other than a hospital, recommended in writing to the Plan by an attending physician in a hospital referred to in subsection 28 (1) from which an insured person is being transferred, is prescribed as a health facility for the purposes of the Act.

(2) During,

- (a) the first sixty days after an insured person is admitted to a facility referred to in subsection (1), including the date of admission; or
- (b) the first one hundred and twenty days after an insured person is admitted to a facility referred to in subsection (1), including the date of admission, where the attending physician certifies within sixty days after the date of admission that further services are necessary and that the insured person is unable to travel to Ontario,

accommodation at the standard or public ward level and all services ordered by a physician, are prescribed as insured services.

(3) It is a condition of payment for insured services prescribed under this section that,

- (a) a physician certifies that the insured person is unable to travel to Ontario; and
- (b) the insured person is transferred to a facility referred to in subsection (1) from a hospital referred to in subsection 28 (1).

(4) The amount payable by the Plan for insured services prescribed in subsection (2) is,

- (a) where the surgical procedures rendered in the hospital were not available in Ontario and there was prior approval by the Plan; or
- (b) where the insured services rendered in the hospital were received because of an emergency,

the cost of the insured services to an insured person, and in all other cases the amount payable by the Plan for insured services prescribed in subsection (2), is 75 per cent of the cost of the insured services to the insured person. O. Reg. 497/83, s. 1.

DESIGNATED HOSPITALS AND HEALTH FACILITIES

34. No hospital or health facility in Ontario providing for the care and treatment of the sick, injured or disabled, other than a hospital or health facility designated under the Act and this Regulation, is entitled to payment by the Plan in respect of insured services provided to an insured person in or by such hospital or health facility. R.R.O. 1980, Reg. 452, s. 63.

35.—(1) The hospitals listed in Schedule 2 and under the heading "Group A Hospitals", "Group B Hospitals", "Group C Hospitals", "Group E Hospitals", "Group F Hospitals", "Group G Hospitals" or "Group J Hospitals" in the Schedule to Regulation 964 of Revised Regulations of Ontario, 1990 are designated for the purpose of the Plan. O. Reg. 829/84, s. 4.

(2) Each hospital listed in Schedule 1 is designated for the purpose of providing such in-patient and out-patient services to insured persons as are available in the hospital. O. Reg. 232/81, s. 3.

(3) Each hospital listed in Part I of Schedule 9 is designated for the purpose of performing computerized axial tomography head scans.

(4) Each hospital listed in Part II of Schedule 9 is designated for the purpose of performing computerized axial tomography whole body scans.

(5) Each hospital listed in Part I of Schedule 10 is designated for the purpose of performing computerized axial tomography head scans, when the necessary equipment is available in the hospital.

(6) Each hospital listed in Part II of Schedule 10 is designated for the purpose of performing computerized axial tomography whole body scans, when the necessary equipment is available in the hospital.

(7) No hospital listed in Schedule 10 may charge or accept payment from the Plan for the cost of the technical component of operating a computerized axial tomography scanner.

(8) Where a hospital pays for a computerized axial tomography scan performed on a scanner that is not installed and operated on the premises of a hospital listed in either Schedule 9 or Schedule 10, no claim to recover the cost of the scan is an allowable expense that may be made against the Plan.

(9) Each hospital listed in Schedule 4 is designated for the purpose of providing the type of care and treatment designated in the Schedule for that hospital.

(10) Each physiotherapy facility listed in Part I of Schedule 5 is designated as a health facility for the purpose of providing office and home physiotherapy treatment to insured persons and each physiotherapy facility listed in Part II of Schedule 5 is designated as a health facility for the purpose of providing home physiotherapy treatment only to insured persons.

(11) Each rehabilitation centre or crippled children's centre listed in Schedule 6 is designated as a hospital for the purpose of providing the insured services indicated in Schedule 6.

(12) Each ambulance service operator listed in Schedule 7 is designated as a health facility for the purpose of providing insured ambulance services.

(13) Each Public Health Laboratory listed in Schedule 8 is designated as a health facility for the purpose of providing laboratory services.

(14) Each extended care unit in every nursing home operated or maintained under the authority of a licence issued under the *Nursing Homes Act* is designated as a health facility for the purpose of section 34. R.R.O. 1980, Reg. 452, s. 64 (3-14).

INFORMATION TO BE FURNISHED BY DESIGNATED HOSPITALS

36. Every hospital in Ontario designated for the purpose of the Plan shall forward to the General Manager,

- (a) within twenty-four hours after an in-patient is admitted, a notification of admission in the prescribed form and if ambulance service has been required, a notification of the name of the ambulance operator listed in Schedule 7 who provided such service, together with the amount of the ambulance service charges;
- (b) within ninety-six hours after an in-patient is discharged from or dies in the hospital, a notification of the discharge or death in the prescribed form and if ambulance service was required when the patient was discharged, a notification of the name of the ambulance operator listed in Schedule 7 who provided such service, together with the amount of the ambulance service charges;
- (c) as required by the General Manager, a longstay report in the prescribed form;
- (d) a list of out-patients in the prescribed form, in duplicate, when the form is filled in, or not later than the twenty-fifth day of each month, whichever is the sooner;
- (e) monthly operating statements and financial and statistical returns in the prescribed forms as required by the General Manager; and
- (f) within thirty days after an in-patient is admitted as the result of an accident or at the time of discharge, whichever is earlier, and for each subsequent admission, an accident report in the prescribed form. R.R.O. 1980, Reg. 452, s. 65.

37.—(1) The General Manager may at any time and from time to time require a hospital to obtain from the insured person's attending physician and forward to the General Manager a written statement that the attending physician shall prepare regarding the condition of the insured person and stating the reasons showing the necessity for the insured services or other treatment provided during all or any part of his or her stay in hospital.

(2) Where a patient receives out-patient services, the attending physician shall prepare a medical record for the patient in the prescribed form within twenty-four hours after the services are provided.

(3) The General Manager may require a hospital to obtain from the insured person's attending physician and forward to the General Manager a written statement that the attending physician shall prepare regarding the condition of the insured person and stating the reason showing the necessity for any ambulance services authorized for such insured person. R.R.O. 1980, Reg. 452, s. 66.

BILLING AND PAYMENT FOR INSURED SERVICES

38.—(1) The amount payable by the Plan for an insured service rendered by a physician in Ontario to an insured person on or after the 22nd day of April, 1990 is the amount set out for the service in the schedule of benefits or 51.7 cents multiplied by the individual

applicable unit value for the service set out opposite the service in Schedule 11, as the case may be. O. Reg. 156/90, s. 5, *part*.

(2) A physician who does not submit his or her accounts directly to the Plan may commence to bill the Plan by giving written notice to the General Manager that he or she intends to bill the Plan directly and the notification becomes effective the first day of the third month following the month in which the General Manager receives such notification but may become effective on an earlier date as ordered by the General Manager.

(3) A physician who does not submit his or her accounts directly to the Plan and who becomes a full-time member of a clinic that is registered with the Plan may give written notice to the General Manager that he or she intends to bill the Plan directly and the notification becomes effective the first day of the month following the month in which the General Manager receives such notification. R.R.O. 1980, Reg. 452, s. 67 (3, 4).

(4) Subject to subsection (5), the following classes of accounts are exempt from the application of section 15 of the Act:

1. Accounts for the performance of insured services rendered to an insured person who is a recipient of a war veteran's allowance under the *War Veterans Allowance Act* (Canada).
2. Accounts for the performance of insured services rendered to an insured Indian who is a member of a band as defined in the *Indian Act* (Canada).
3. Accounts for the performance of insured services rendered to an insured person in an out-patient, or any other clinical department of a public hospital.
4. Accounts for the performance of insured services rendered to an insured person in,
 - i. a nursing home,
 - ii. a home for the aged, established and maintained under the *Homes for the Aged and Rest Homes Act*,
 - iii. a children's mental health centre under the *Children's Mental Health Services Act*, being chapter 69 of the Revised Statutes of Ontario, 1980,
 - iv. a hospital established or approved under the *Community Psychiatric Hospitals Act*,
 - v. a psychiatric facility under the *Mental Health Act*,
 - vi. an institution designated as an approved home under the *Mental Hospitals Act*,
 - vii. a designated facility to which the *Developmental Services Act* applies, or
 - viii. a home for special care, established, approved or licensed under the *Homes for Special Care Act*.
5. Accounts for the performance of insured services rendered to an insured person in a mobile vision or hearing van operated by a non-profit organization to provide eye or ear care in under serviced areas in Ontario.
6. Accounts for the performance of an examination rendered to an insured person and for documentation prepared for the purpose of an investigation or confirmation of an alleged sexual assault. R.R.O. 1980, Reg. 452, s. 67 (5); O. Reg. 332/81, s. 6 (2).

(5) Payment for the classes of accounts exempted by paragraphs 3 and 4 of subsection (4) may only be made where,

- (a) the physician performing the services is a member of an associate medical group that is registered with the Plan;

- (b) the accounts for such services are submitted by the association referred to in clause (a) directly to the Plan; and

- (c) the associate medical group referred to in clause (a) and physician accept the payment as constituting payment in full for the services.

(6) Claims for consultations shall bear the Ontario health insurance plan identification number of the referring physician.

(7) Despite paragraph 3 of section 7 and paragraph 1 of section 8, it is a condition of payment for the performance of a physician's services regarding a computerized axial tomography scan and its interpretation, that the services be rendered in respect of a computerized axial tomography scan that was performed by and on the premises of a public hospital.

(8) Where any services are provided in a hospital or a health facility, the claim or claims shall bear the Ontario health insurance plan identification number of such hospital or facility.

(9) Claims for laboratory, X-ray and other diagnostic procedures shall bear the Plan identification number of the referring physician.

(10) All claims shall bear the signature of the provider of the insured services or of the person's authorized agent.

(11) The Plan shall pay a designated hospital for insured services provided to an insured person on the day of the person's admission to the hospital but not on the day of the person's discharge from the hospital.

(12) The Plan shall not make and a hospital shall not accept duplicate payments for any insured services provided by the hospital. R.R.O. 1980, Reg. 452, s. 67 (6-13).

SUBROGATION (PROCEDURAL)

39.—(1) In this section, "notice" means notice in writing by personal delivery or mailed by registered mail addressed to the latest post office address of the person to whom the notice is sent as shown on the records of the Plan or, where no address is shown for the person on the records of the Plan, addressed to the person at the person's post office address as shown on the records of the hospital or other provider of the insured services.

(2) Where an insured person commences an action referred to in section 31 of the Act, his or her solicitor shall so inform the General Manager forthwith after issuing the writ and shall act as solicitor for the Plan for the purpose of this section unless notified by the General Manager in writing that he or she is no longer acting for the Plan and in such case the General Manager may appoint another solicitor to represent the Plan.

(3) Where the insured person and the General Manager cannot agree as to any offer of settlement or where the solicitor receives conflicting instructions from the General Manager and the insured person, the solicitor may so inform the General Manager in writing and thereupon shall cease to act for the Plan and the General Manager may appoint another solicitor for the purpose of this section.

(4) Where the General Manager appoints a solicitor under subsection (2) or (3), the solicitor may participate in the action as fully as if acting for a plaintiff and shall be at liberty to appear at the trial of the action and take part therein in such manner and to such extent as the trial judge may direct but, if, upon the application of the defendant or the insured, it appears that such participation may embarrass or delay the trial of the action, the court may order separate trials, or make such other order as may be expedient.

(5) Where the insured person and the General Manager cannot agree as to any offer of settlement in the action the insured person may make a settlement of his or her claims and thereafter the General Manager shall have the conduct of the action.

(6) Subject to subsection (8), where an insured person obtains a final judgment in an action in which he or she includes a claim on

behalf of the Plan, the Plan shall bear the same proportion of the taxable costs otherwise payable by the insured person, whether on a party and party basis or on a solicitor and client basis, as the recovery made on behalf of the Plan bears to the total recovery of the insured person in the action or, where no recovery is made, as the assessed claim of the Plan bears to the total damages of the insured person assessed by the court.

(7) Where a claim is settled, the Plan shall bear the same proportion of the taxable costs otherwise payable by the insured person as is set out in subsection (6) in respect of a recovery made.

(8) The costs for which the Plan may be liable to bear a portion under subsection (6) are the costs of bringing the action to the conclusion of the trial only and do not include the costs of any other proceeding without the written consent of the General Manager.

(9) If no action has been commenced by an insured person for the recovery of damages arising out of injury or disability within eleven months of the last act or omission that caused or contributed to the injury or disability, or thirty days before the expiration of the limitation period for the action, whichever occurs first, the General Manager,

- (a) after notice thereof to the insured person, may commence an action in the name of the Plan or in the name of the insured for damages in the amount of the costs of insured services; and
- (b) may effect settlement of the claim without prejudice to the right of the insured person to commence an action to recover for his or her injuries or other damages.

(10) The insured person, at any time prior to the trial of an action commenced under clause (9) (a), may, subject to the rules of court, join in such action any additional claims arising out of the same occurrence and thereafter the insured person shall have the conduct of the action as if he or she had commenced it under section 31 of the Act.

(11) Where the insured person is a minor or under other disability or has died, the General Manager may commence an action in the name of the Plan for the recovery of the cost of insured services rendered to the person and, in that event, shall forthwith give notice of the institution of such action to the parent or guardian of the minor, or to the committee or guardian of the person under disability, or to the personal representative, if any, of the deceased person, and subsections (9) and (10) apply with necessary modifications to such action.

(12) This section does not apply to any action arising out of negligence or other wrongful act or omission in the use or operation of a motor vehicle, where,

- (a) the accident resulting in the injuries occurred after the 30th day of November, 1978;
- (b) at the time of the accident, the owner of the motor vehicle was insured against liability under a motor vehicle liability policy issued by an insurer set out in Schedule 12; and
- (c) at the time of the accident, the motor vehicle was the subject of a permit issued under subsection 7 (7) of the *Highway Traffic Act*. R.R.O. 1980, Reg. 452, s. 68.

TABLE 1

ITEM	COLUMN 1	COLUMN 2	COLUMN 3	COLUMN 4	COLUMN 5	COLUMN 6	COLUMN 7
	Effective Period	Monthly Co-payment	Daily Co-payment	Monthly Payment	Daily Payment	Monthly Total	Daily Total
1.	On or after the 1st day of November, 1990	\$740.02	\$24.33	\$1,099.20	\$36.14	\$1,839.22	\$60.47

O. Reg. 438/86, s. 4; O. Reg. 645/86, s. 1; O. Reg. 25/87, s. 1; O. Reg. 213/87, s. 1; O. Reg. 405/87, s. 1; O. Reg. 457/87, s. 2; O. Reg. 596/87, s. 1; O. Reg. 43/88, s. 1; O. Reg. 265/88, s. 1; O. Reg. 491/88, s. 2; O. Reg. 574/88, s. 1; O. Reg. 652/88, s. 1; O. Reg. 39/89, s. 1; O. Reg. 130/89, s. 1; O. Reg. 231/89, s. 1; O. Reg. 447/89, s. 2; O. Reg. 610/89, s. 1; O. Reg. 36/90, s. 1; O. Reg. 209/90, s. 1; O. Reg. 255/90, s. 1; O. Reg. 414/90, s. 2; O. Reg. 569/90, s. 1, *part, revised*.

TABLE 2

ITEM	COLUMN 1	COLUMN 2	COLUMN 3	COLUMN 4
	Effective Period	Person Receiving Chronic Care Services	Monthly Co-Payment	Daily Co-Payment
1.	On or after the 1st day of November, 1990	Person with no dependants — maximum estimated income \$840.02 Person with one dependant — maximum aggregate estimated incomes \$4,700.00 Person with two dependants — maximum aggregate estimated incomes \$5,055.00 Person with three dependants — maximum aggregate estimated incomes \$5,377.00 Person with four or more dependants — maximum aggregate estimated incomes \$5,666.00	Estimated income less \$100.00 Aggregate estimated incomes less \$2,480.00, divided by 3 Aggregate estimated incomes less \$2,835.00, divided by 3 Aggregate estimated incomes less \$3,157.00, divided by 3 Aggregate estimated incomes less \$3,446.00, divided by 3	Estimated income less \$100.00, divided by 30.4 Aggregate estimated incomes less \$2,480.00, divided by 91.2 Aggregate estimated incomes less \$2,835.00, divided by 91.2 Aggregate estimated incomes less \$3,157.00, divided by 91.2 Aggregate estimated incomes less \$3,466.00, divided by 91.2

TABLE 2—Continued

ITEM	COLUMN 1	COLUMN 2	COLUMN 3	COLUMN 4
	Effective Period	Person Receiving Chronic Care Services	Monthly Co-Payment	Daily Co-Payment
		Person not referred to elsewhere in this item	\$740.02	\$24.33

R.R.O. 1980, Reg. 452, Table 2; O. Reg. 38/81, s. 2; O. Reg. 254/81, s. 2; O. Reg. 479/81, s. 2; O. Reg. 685/81, s. 2; O. Reg. 53/82, s. 2; O. Reg. 295/82, s. 2; O. Reg. 529/82, s. 2; O. Reg. 733/82, s. 2; O. Reg. 77/83, s. 2; O. Reg. 259/83, s. 2; O. Reg. 460/83, s. 2; O. Reg. 704/83, s. 2; O. Reg. 56/84, s. 2; O. Reg. 288/84, s. 2; O. Reg. 480/84, s. 3; O. Reg. 717/84, s. 2; O. Reg. 20/85, s. 2; O. Reg. 206/85, s. 3; O. Reg. 408/85, s. 4; O. Reg. 565/85, s. 2; O. Reg. 42/86, s. 2; O. Reg. 241/86, s. 2; O. Reg. 438/86, s. 5; O. Reg. 645/86, s. 2; O. Reg. 25/87, s. 2; O. Reg. 213/87, s. 2; O. Reg. 457/87, s. 3; O. Reg. 596/87, s. 2; O. Reg. 43/88, s. 2; O. Reg. 265/88, s. 2; O. Reg. 491/88, s. 3; O. Reg. 652/88, s. 2; O. Reg. 39/89, s. 2; O. Reg. 231/89, s. 2; O. Reg. 447/89, s. 3; O. Reg. 610/89, s. 2; O. Reg. 36/90, s. 2; O. Reg. 209/90, s. 2; O. Reg. 414/90, s. 3; O. Reg. 569/90, s. 2, *part, revised*.

TABLE 3

ITEM	COLUMN 1	COLUMN 2	COLUMN 3
	Effective Period	Monthly Period	Daily Payment
1.	On or after the 1st day of April, 1985	\$1,368.72	\$45.00

R.R.O. 1980, Reg. 452, Table 3; O. Reg. 168/81, s. 2; O. Reg. 235/82, s. 2; O. Reg. 233/83, s. 2; O. Reg. 663/84, s. 2; O. Reg. 274/85, s. 4, *part, revised*.

TABLE 4

ITEM	COLUMN 1	COLUMN 2	COLUMN 3	COLUMN 4
1.	On or after the 1st day of July, 1988 to and including the 31st day of March, 1989	On or after the 1st day of April, 1988 to and including the 31st day of March, 1989	49.9	37.4

O. Reg. 192/89, s. 2, *part*; O. Reg. 40/90, s. 2, *part, revised*.

TABLE 5

ITEM	COLUMN 1	COLUMN 2	COLUMN 3	COLUMN 4	COLUMN 5
1.	On or after the 1st day of July, 1988 to and including the 31st day of March, 1989	On or after the 1st day of April, 1988 to and including the 31st day of March, 1989	49.9	37.4	25

O. Reg. 192/89, s. 2, *part*; O. Reg. 40/90, s. 3, *part, revised*.

TABLE 6

ITEM	COLUMN 1	COLUMN 2	COLUMN 3	COLUMN 4	COLUMN 5	COLUMN 6	COLUMN 7
1.	On or after the 1st day of April, 1988 to and including the 31st day of March, 1989	On or after the 1st day of October, 1989	On or after the 1st day of April, 1988 to and including the 30th day of June, 1988	On or after the 1st day of July, 1988 to and including the 31st day of March, 1989	49	49.9	51.7

O. Reg. 40/90, s. 4, *part, revised*.

Schedule 1

6. Toronto

Institute of Traumatic, Plastic and Restorative Surgery

PRIVATE HOSPITALS

PART II

PART I

Chronic Care Hospitals:

Active Treatment Hospitals:

ITEM LOCATION

NAME OF HOSPITAL

ITEM	LOCATION	NAME OF HOSPITAL
1.	Don Mills	One Medical Place
2.	Hawkesbury	The Smith Hospital
3.	Kingston	Institute of Psychotherapy Limited
4.	Scarborough	Bellwood Health Services Inc.
5.	Thornhill	Shouldice Hospital Limited

ITEM	LOCATION	NAME OF HOSPITAL
1.	Burford	Bellview Private Hospital
2.	Cobourg	Sidbrook Private Hospital
3.	Lakefield	Lakefield Private Hospital
4.	London	Mason Villa Private Hospital
5.	Penetanguishene	Beechwood Private Hospital
6.	Perth	Four Winds Private Hospital

7. Perth	Wiseman's Private Hospital
8. Thornhill	The Villa
9. Thorold	Maple Hurst Hospital
10. Toronto	Beverley Private Hospital
11. Toronto	Dewson Private Hospital
12. Willowdale	St. Joseph's Infirmary
13. Woodstock	Woodstock Private Hospital

R.R.O. 1980, Reg. 452, Sched. 4; O. Reg. 156/86, s. 1.

Schedule 2

FEDERAL HOSPITALS

PART I

Active Treatment Hospitals:

ITEM	LOCATION	NAME OF HOSPITAL
1.	Attawapiskat	Nursing Station
2.	Big Trout Lake	Nursing Station
3.	Fort Albany (on the Island of St. Clair)	Nursing Station
4.	Fort Hope	Nursing Station
5.	Kashechewan	Nursing Station
6.	Lac Seul	Nursing Station
7.	Lansdowne House	Nursing Station
8.	Manitowaning	Manitowaning Hospital
9.	Moose Factory	Moose Factory General Hospital
10.	Moosonee	R.C.A.F. Hospital
11.	Ohsweken	Lady Willingdon Hospital
12.	Osnaburgh	Nursing Station
13.	Ottawa	National Defence Medical Centre
14.	Pikangikum	Nursing Station
15.	Round Lake	Nursing Station
16.	Sandy Lake	Nursing Station
17.	Sioux Lookout	Sioux Lookout Indian Hospital
18.	Winisk	Nursing Station

PART II

Chronic Care Hospitals:

ITEM	LOCATION	NAME OF HOSPITAL
1.	Ottawa	National Defence Medical Centre (Chronic Unit)

R.R.O. 1980, Reg. 452, Sched. 5.

Schedule 3

NURSING HOMES FOR CHRONIC CARE

ITEM	LOCATION	Name
1.	Aurora	Aurora Resthaven Extended Care & Convalescent Centre

R.R.O. 1980, Reg. 452, Sched. 7; O. Reg. 390/84, s. 1.

Schedule 4

HOSPITALS FOR PSYCHIATRIC ILLNESSES, AND ALCOHOLISM AND DRUG ADDICTION

PART I

Public Hospital for Psychiatric Illnesses:

ITEM	LOCATION	NAME OF HOSPITAL
1.	Toronto	Clarke Institute of Psychiatry

PART II

Public Hospitals for Alcoholism and Drug Addiction:

ITEM	LOCATION	NAME OF HOSPITAL
1.	Toronto	The Donwood Institute
2.	Toronto	The Alcoholism and Drug Addiction Research Foundation (The Clinical Institute)

R.R.O. 1980, Reg. 452, Sched. 8.

Schedule 5

APPROVED PHYSIOTHERAPY FACILITIES

PART I

Physiotherapy Facilities approved to provide Office and Home Treatment:

ITEM	LOCATION	Name
1.	Aurora	Coxwell Physiotherapy Centre
2.	Barrie	Barrie Physiotherapy Clinic
3.	Belleville	Quinte Physiotherapy Clinic
4.	Bramalea	Evans Physiotherapy Clinic
5.	Brampton	The Baynes Physiotherapy Centre
6.	Brantford	Greystone Physiotherapy Clinic
7.	Brantford	Scott Physiotherapy Clinic
8.	Brechin	Mr. B. MacIntyre
9.	Burlington	Brant 730 Physiotherapy
10.	Cambridge	The Harrington Physiotherapy Clinic
11.	Cornwall	Cornwall Physiotherapy Clinic
12.	Durham	Mrs. D. J. MacGillivray
13.	Etobicoke	Four Seasons Physiotherapy
14.	Etobicoke	Kingsway Physiotherapy
15.	Etobicoke	Queensway Physiotherapy Centre
16.	Etobicoke	Six Points Physiotherapy
17.	Guelph	Evarest House
18.	Hamilton	First Place Physiotherapy
19.	Hamilton	Mountain Physiotherapy
20.	Hamilton	Park Physical Therapy
21.	Hamilton	Physiotherapy Services
22.	Hamilton	King East Physio
23.	Hamilton	68 Charlton Avenue West Ltd.
24.	Hamilton	Steel City Physiotherapy
25.	Hamilton	The Hamilton Physiotherapy Clinic
26.	Hamilton	Upper Ottawa Physiotherapy
27.	Hamilton	West End Physiotherapy Clinic
28.	Kingston	Blaser's Physiotherapy Clinic

O. Reg. 559/86, s. 1; O. Reg. 647/86, s. 1; O. Reg. 744/86, s. 1;
 O. Reg. 51/87, s. 1; O. Reg. 76/87, s. 1; O. Reg. 105/87, s. 1;
 O. Reg. 616/87, s. 1; O. Reg. 137/88, s. 1; O. Reg. 214/88, s. 1;
 O. Reg. 704/88, s. 1; O. Reg. 33/89, s. 1; O. Reg. 196/89, s. 1;
 O. Reg. 531/89, s. 1; O. Reg. 599/90, s. 1.

Schedule 6

REHABILITATION AND CRIPPLED CHILDREN'S CENTRES

PART I

Centres providing Occupational Therapy:

ITEM	LOCATION	NAME OF CENTRE
1.	Brantford	Lansdowne Children's Centre
2.	Hamilton	Hamilton District Society for Crippled Children
3.	Kitchener	Kitchener-Waterloo Rotary Children's Centre
4.	London	Thames Valley Children's Centre
5.	Mississauga	Credit Valley Treatment Centre for Children
6.	Oshawa	Simcoe Hall Children's Centre
7.	Ottawa	The Ottawa Crippled Children's Treatment Centre
8.	Peterborough	Five Counties Children's Centre
9.	St. Catharines	Niagara Peninsula Crippled Children's Treatment Centre
10.	St. Catharines	Niagara Peninsula Rehabilitation Centre
11.	Sarnia	Sarnia and District Children's Treatment Centre
12.	Sudbury	Laurentian Hospital Children's Treatment Centre
13.	Thunder Bay	George Jeffrey Children's Treatment Centre
14.	Toronto	Ontario Crippled Children's Centre
15.	Toronto	Toronto Rehabilitation Centre
16.	Windsor	The Children's Rehabilitation Centre of Essex County

PART II

Centres providing Physiotherapy:

ITEM	LOCATION	NAME OF CENTRE
1.	Brantford	Lansdowne Children's Centre
2.	Chatham	Kent County Children's Treatment Centre
3.	Hamilton	Hamilton District Society for Crippled Children
4.	Kitchener	Kitchener-Waterloo Rotary Children's Centre
5.	London	Thames Valley Children's Centre
6.	Mississauga	Credit Valley Treatment Centre for Children
7.	Oshawa	Simcoe Hall Children's Centre
8.	Ottawa	The Ottawa Crippled Children's Treatment Centre
9.	Peterborough	Five Counties Children's Centre
10.	St. Catharines	Niagara Peninsula Crippled Children's Treatment Centre

11.	St. Catharines	Niagara Peninsula Rehabilitation Centre
12.	Sarnia	Sarnia and District Children's Treatment Centre
13.	Sault Ste. Marie	Sault Ste. Marie Children's Rehabilitation Centre
14.	Sudbury	Laurentian Hospital Children's Treatment Centre
15.	Thunder Bay	George Jeffrey Children's Treatment Centre
16.	Toronto	The Canadian Arthritis and Rheumatism Society
17.	Toronto	Ontario Crippled Children's Centre
18.	Toronto	Toronto Rehabilitation Centre
19.	Windsor	The Children's Rehabilitation Centre of Essex County

PART III

Centres providing Speech Therapy:

ITEM	LOCATION	NAME OF CENTRE
1.	Brantford	Lansdowne Children's Centre
2.	Chatham	Kent County Children's Treatment Centre
3.	Hamilton	Hamilton District Society for Crippled Children
4.	Kitchener	Kitchener-Waterloo Rotary Children's Centre
5.	London	Thames Valley Children's Centre
6.	Mississauga	Credit Valley Treatment Centre for Children
7.	Oshawa	Simcoe Hall Children's Centre
8.	Ottawa	The Ottawa Crippled Children's Treatment Centre
9.	Peterborough	Five Counties Children's Centre
10.	St. Catharines	Niagara Peninsula Crippled Children's Treatment Centre
11.	St. Catharines	Niagara Peninsula Rehabilitation Centre
12.	Sarnia	Sarnia and District Children's Treatment Centre
13.	Sault Ste. Marie	Sault Ste. Marie Children's Rehabilitation Centre
14.	Sudbury	Laurentian Hospital Children's Treatment Centre
15.	Thunder Bay	George Jeffrey Children's Treatment Centre
16.	Toronto	Ontario Crippled Children's Centre
17.	Toronto	Toronto Rehabilitation Centre
18.	Windsor	The Children's Rehabilitation Centre of Essex County
19.	Windsor	Remedial Speech Association of Essex

Schedule 7

AMBULANCE SERVICE OPERATORS

PART I

Hospital Ambulance Services:

ITEM	LOCATION	NAME OF OPERATOR
1.	Ajax	Ajax and Pickering General Hospital
2.	Alexandria	Glengarry Memorial Hospital
3.	Alliston	The Stevenson Memorial Hospital
4.	Almonte	Almonte General Hospital
5.	Arnprior	Arnprior and District Memorial Hospital
6.	Atikokan	Atikokan General Hospital
7.	Barrie	Royal Victoria Hospital of Barrie
8.	Barry's Bay	St. Francis Memorial Hospital
9.	Blind River	St. Joseph's General Hospital
10.	Bowmanville	Memorial Hospital
11.	Brockville	Brockville General Hospital
12.	Burk's Falls	Red Cross Outpost Hospital
13.	Cambridge	Cambridge Memorial Hospital
14.	Campbellford	Campbellford Memorial Hospital
15.	Chapleau	Lady Minto Hospital
16.	Cochenour	Margaret Cochenour Hospital
17.	Cochrane	Lady Minto Hospital at Cochrane
18.	Dryden	Dryden District General Hospital
19.	Dunnville	Haldimand War Memorial Hospital
20.	Durham	Durham Memorial Hospital
21.	Elliot Lake	St. Joseph's General Hospital
22.	Englehart	Englehart and District Hospital
23.	Espanola	Espanola General Hospital
24.	Fergus	Groves Memorial Community Hospital
25.	Forest	Forest District Ambulance Service
26.	Fort Frances	La Verendrye Hospital
27.	Goderich	Alexandra Marine and General Hospital
28.	Hagersville	West Haldimand General Hospital
29.	Hanover	Hanover Memorial Hospital
30.	Hearst	Notre-Dame Hospital
31.	Hornepayne	Hornepayne Community Hospital
32.	Huntsville	Huntsville District Memorial Hospital
33.	Iroquois Falls	Anson General Hospital
34.	Kapuskasung	Sensenbrenner Hospital
35.	Kemptville	Kemptville District Hospital
36.	Kenora	Lake of the Woods District Hospital
37.	Kincardine	Kincardine General Hospital
38.	Kingston	Hotel Dieu Hospital
39.	Kirkland Lake	Kirkland and District Hospital
40.	Kitchener	Kitchener-Waterloo Hospital
41.	Listowel	The Listowel Memorial Hospital
42.	Little Current	Manitoulin Health Centre
43.	Manitouwadge	Manitouwadge General Hospital
44.	Marathon	Wilson Memorial General Hospital

45.	Markdale	Centre Grey General Hospital
46.	Matheson	Bingham Memorial Hospital
47.	Mattawa	Mattawa General Hospital
48.	Meaford	Meaford General Hospital
49.	Newmarket	York County Hospital
50.	Nipigon	Nipigon District Memorial Hospital
51.	North Bay	North Bay Civic Hospital
52.	Orangeville	Dufferin Area Hospital
53.	Owen Sound	The Owen Sound General and Marine Hospital
54.	Paris	The Willett Hospital
55.	Parry Sound	The Parry Sound General Hospital
56.	Pembroke	General Hospital
57.	Perth	The Great War Memorial Hospital of Perth District
58.	Peterborough	The Peterborough Civic Hospital
59.	Rainy River	Red Cross Outpost Hospital
60.	Richard's Landing	Red Cross Outpost Hospital
61.	St. Catharines	Hotel Dieu Hospital
62.	St. Marys	St. Marys Memorial Hospital
63.	St. Thomas	St. Thomas-Elgin General Hospital
64.	Sarnia	Sarnia General Hospital
65.	Sault Ste. Marie	Plummer Memorial Public Hospital
66.	Shelburne	Shelburne District Hospital
67.	Sioux Lookout	Sioux Lookout General Hospital
68.	Smooth Rock Falls	Smooth Rock Falls Hospital
69.	Stratford	Stratford General Hospital
70.	Sturgeon Falls	St. Jean de Brebeuf Hospital
71.	Sudbury	Sudbury General Hospital
72.	Thessalon	Red Cross Outpost Hospital
73.	Thunder Bay	McKellar General Hospital
74.	Thunder Bay	St. Joseph's General Hospital
75.	Tillsonburg	Tillsonburg District Memorial Hospital
76.	Uxbridge	The Cottage Hospital (Uxbridge)
77.	Walkerton	County of Bruce General Hospital
78.	Wawa	The Lady Dunn General Hospital
79.	Warton	Bruce Peninsula and District Memorial Hospital
80.	Wingham	Wingham and District Hospital

PART II

Municipal Ambulance Services:

ITEM	LOCATION	NAME OF OPERATOR
1.	Ancaster	Township of Ancaster Volunteer Ambulance Service
2.	Beardmore	Improvement District of Beardmore
3.	Brantford	City of Brantford Fire Department
4.	Ear Falls	Ear Falls Ambulance Service
5.	Haliburton	Municipality of Dysart et al
6.	Ignace	Township of Ignace
7.	Lindsay	Lindsay Fire Department and Ambulance Service
8.	Minden	Minden Ambulance Service

9. Noelville	Noelville Ambulance Service	37. London	Thames Valley Ambulance Limited
10. Sioux Narrows	Sioux Narrows Ambulance Service	38. Lucan	Lucan Ambulance Service
11. Temagami	Improvement District of Temagami	39. MacTier	Jordan's Ambulance Service
12. Timmins	Timmins Dispatch Centre	40. Madoc	City Ambulance Service (of Quinte) Limited
13. Toronto	Municipality of Metropolitan Toronto, Department of Emergency Services	41. Midland	Midland District Ambulance Service
14. Virginiatown	Township of McGarry Ambulance Service	42. Mississauga	Fleuty Ambulance Service
15. Wasaga Beach	Wasaga Beach Ambulance Service	43. Morrisburg	Seaway Valley Ambulance Service Limited
16. White River	Improvement District of White River	44. Mount Forest	Hiller Ambulance Service

PART III

Private Ambulance Operators:

ITEM	LOCATION	NAME OF OPERATOR	
1.	Agincourt	Ogden Ambulance Service	46. Palmerston
2.	Alfred	Lamarre & Son Ambulance Service	47. Parham
3.	Bancroft	Hattin's Ambulance Service	48. Parkhill
4.	Beaverton	Beaverton Ambulance Service	49. Petawawa
5.	Belleville	City Ambulance (of Quinte) Ltd.	50. Petrolia
6.	Belleville	LaSalle Ambulance Service	51. Picton
7.	Bobcaygeon	Bobcaygeon Ambulance Service	52. Port Colborne
8.	Bracebridge	Muskoka Ambulance Service	53. Port Elgin
9.	Bradford	Lewis Ambulance Service	54. Port Perry
10.	Brigden	Steadman's Ambulance Service	55. Port Rowan
11.	Burlington	District of Halton and Mississauga Ambulance Service	56. Rodney
12.	Carleton Place	Allan R. Barker Ambulance Service	57. Schreiber
13.	Casselman	Casselman Ambulance Service	58. Seaforth
14.	Chatham	Arbour's Chatham Ambulance Service Limited	59. Simcoe
15.	Cobourg	Cobourg Ambulance Service	60. Smithville
16.	Colborne	Rutherford's Ambulance Service	61. Stratford
17.	Collingwood	McKechnie Ambulance Service	62. Strathroy
18.	Dashwood	Hoffman's Ambulance Service	63. Streetsville
19.	Delhi	D.L. Murphy Ambulance Service	64. Sutton
20.	Drayton	N. Wellington Ambulance Service	65. Tecumseh
21.	Fenelon Falls	Fenelon Ambulance Service	66. Thedford
22.	Finch	Brownlee Ambulance Service	67. Tilbury
23.	Fisherville	Yeates Ambulance Service	68. Timmins
24.	Gananoque	Gananoque Ambulance Service	69. Toronto
25.	Geraldton	Fawcett Ambulance Service	70. Toronto
26.	Glencoe	J.B. Gough & Son Ambulance Service	71. Toronto
27.	Grimsby	West Lincoln Ambulance Service	72. Toronto
28.	Guelph	Royal City Ambulance Service	73. Trenton
29.	Haileybury	Buffam Ambulance Service	74. Wallaceburg
30.	Hamilton	Fleetview Services Limited	75. Waterdown
31.	Hamilton	Superior Ambulance Limited	76. Welland
32.	Harrow	Gerald A. Smith & Sons Ambulance Service	77. Whitby
33.	Hawkesbury	Noel Ambulance Service Limited	78. Woodstock
34.	Hawkesbury	Quenneville Ambulance Service	79. Zurich
35.	Langton	Verhoeve Ambulance Service	
36.	Leamington	Sunparlour Ambulance Service	

PART IV

Volunteer Ambulance Operators:

ITEM	LOCATION	NAME OF OPERATOR
1.	Amherstburg	Amherstburg, Anderdon & Malden District First Aid Squad
2.	Bolton	Bolton & District Ambulance Association (Volunteer)
3.	Dubreuilville	Dubreuilville Volunteer Ambulance Service
4.	Georgetown	Georgetown Volunteer Ambulance Service
5.	Gore Bay	Gore Bay Volunteer Ambulance Group
6.	Hastings	Hastings Ambulance Service
7.	Nestor Falls	Nestor Falls Volunteer Ambulance Service
8.	Niagara-on-the-Lake	Niagara Volunteer Ambulance Service
9.	Nobleton	Nobleton Firefighters & Ambulance Association
10.	Powassan	Powassan & District Ambulance Service
11.	Rockland	Rockland Ambulance Service
12.	Seeley's Bay	Seeley's Bay Emergency Ambulance

R.R.O. 1980, Reg. 452, Sched. 11.

Schedule 8

PUBLIC HEALTH LABORATORIES APPROVED AS RELATED HEALTH FACILITIES

ONTARIO MINISTRY OF HEALTH
PUBLIC HEALTH LABORATORIES

ITEM	LOCATION	NAME OF OPERATOR
1.	Hamilton	Hamilton Psychiatric Hospital Fennell Avenue West Mailing Address: P.O. Box 2100 L8N 3R5
2.	Kingston	Government Building 181 Barrie Street Mailing Address: Box 240 K7L 4V8
3.	London	Fifth Floor London Psychiatric Hospital Off Highbury Avenue Mailing Address: Box 5704, Postal Terminal 'A' N6A 4L6
4.	Orillia	Highway 11B Mailing Address: Box 600 L3V 6K5
5.	Ottawa	346 Moodie Drive R.R. 2 Bells Corners Mailing Address: Box 6301 K2A 1S8
6.	Palmerston	Midwestern Reg. Children's Centre Mailing Address: P.O. Box 700 N0G 2P0
7.	Peterborough	1341 Dobbin Avenue Mailing Address: P.O. Box 265 K9J 6Y8

8.	Sault Ste. Marie	Albert and Brock Streets Mailing Address: P.O. Box 220 P6A 5L6
9.	Sudbury	1300 Paris Crescent Mailing Address: 1300 Paris Crescent, P3E 3A3
10.	Thunder Bay	336 South Syndicate Avenue Mailing Address: P.O. Box 1100, Station 'F', P7C 4X9
11.	Timmins	67 Wilson Avenue Mailing Address: 67 Wilson Avenue P4N 2S5
12.	Toronto	Central Laboratories Resources Road Islington and Highway 401 Etobicoke Mailing Address: Box 9000, Terminal 'A', M5W 1R5
13.	Windsor	3400 Huron Church Rd. Mailing Address: P.O. Box 1616 N9A 6S2

R.R.O. 1980, Reg. 452, Sched. 12.

Schedule 9

COMPUTERIZED AXIAL TOMOGRAPHY

PART I

Hospitals designated to perform Head C.A.T. Scans:

ITEM	LOCATION	NAME OF HOSPITAL
1.	Hamilton	Hamilton Civic Hospitals
2.	London	Victoria Hospital
3.	Ottawa	Ottawa General Hospital
4.	Toronto	Toronto General Hospital

PART II

Hospitals designated to perform Whole Body C.A.T. Scans:

ITEM	LOCATION	NAME OF HOSPITAL
1.	Kingston	Kingston General Hospital
2.	Thunder Bay	McKellar General Hospital
3.	Toronto	The Princess Margaret Hospital
4.	Toronto	St. Michael's Hospital

R.R.O. 1980, Reg. 452, Sched. 13.

Schedule 10COMPUTERIZED AXIAL TOMOGRAPHY
(when equipment available)

PART I

Hospitals designated to perform Head C.A.T. Scans:

ITEM	LOCATION	NAME OF HOSPITAL
1.	Toronto	Sunnybrook Hospital

PART II

Hospitals designated to perform Whole Body C.A.T. Scans:

ITEM	LOCATION	NAME OF HOSPITAL
1.	Hamilton	McMaster University Medical Centre
2.	London	University Hospital
3.	Ottawa	Ottawa Civic Hospital

4. Toronto Toronto General Hospital
 5. Toronto The Hospital for Sick Children
 6. Toronto The Toronto Western Hospital
 R.R.O. 1980, Reg. 452, Sched. 14.

Schedule 11

LABORATORY MEDICINE

1. The patient documentation and specimen handling benefit is applicable to all patients, except for those items listed under anatomical pathology, histology and cytology sections. The items in this section have been left at a sufficient level to cover any administrative costs. This benefit is not applicable to referred in samples, since the collecting laboratory will already have claimed the patient documentation and specimen collection benefit.
2. The biochemistry section has been condensed so that one listing refers to a procedure for any of amniotic fluid (A), blood (B), C.S.F. (C), faeces (F), gastrointestinal fluid (G), urine (U). Exceptions are indicated by B, U, etc., following the test name. Other specimens will be considered on an I.C. basis.
3. A number of tests are listed in different sections of the schedule; i.e., where more than one method of performing the test is available e.g., Hepatitis B antigen is listed under both Radioassays and Immunology. Assays of ligand type other than isotopic are listed under Biochemistry.
4. Blood glucose by the dipstick method may be claimed only when assessed by an appropriate instrument such as a reflectance meter. It should not be claimed when used only as a check on the fasting blood sample of a glucose tolerance test. The blood glucose of the fasting sample in a glucose tolerance test is allowable only once even if assessed by two methods.

Note: A standard glucose tolerance test for the diagnosis of diabetes mellitus is performed over 2 hours and includes 5 blood glucose (L104) and one urine glucose determination (L254).

If the patient is pregnant, only 4 blood glucose specimens (L103) should be taken at hourly intervals. (See CMAJ 126, 473 (1982)). When 5 hour glucose tolerance test is specifically ordered the blood glucose measurements are to be claimed individually (L111). Only one L254 may be claimed with a glucose tolerance test.

5. Code L418 or L417 may not be claimed by a physician in addition to claim(s) for any treatment or assessment. However, Code G481 in the schedule of benefits may be claimed by a physician if a hemoglobin screen (any method or instrument) is carried out in the course of an office or home visit. Urinalysis may be claimed with or without an associated visit to a physician's office (except for screening and urinalyses which are not medically necessary).
6. When a screening culture method (e.g. Agar spoon) is used on a urine sample, L641 refers to a culture technique and does not apply to those kits using the nitrite test only. Where a significant growth is obtained and followed up by definitive identification methods, L633 or L634 only should be claimed. The benefits for L633 or L634 include any necessary microscopic examination of the urine. However urine examination by microscopy may be claimed in addition to L633 or L634 if the referring physician has specifically ordered the former and receives a report from the laboratory.
7. Only those tests which are requested are to be claimed for with the following exceptions. It is intended that if the test

results yield abnormal findings or information which would be incomplete, insufficient or meaningless to the referring physician, the medical director of a laboratory may add further appropriate tests and claim for them with the knowledge he or she may have to substantiate their justification.

8. A test must be completed in accordance with the pertinent schedule listing in order to claim for it. The verbatim listing is intended as the definitive benefit for that test alone, unless otherwise specified e.g. isoenzymes do not include total enzyme estimation; creatine does include creatinine (as specified). Despite the foregoing and recognizing that it is impossible to list all variations in techniques of all listed tests, when there is a modification of the usual technique, the listing most closely approximating it should be used.
9. This schedule, with the exception of L036, lists actual procedures performed. No claim shall be made for calculated values made and reported, or for control tests or repeat tests on same patient sample.
10. Creatinine is a justifiable addition in the case of tests on 24-hour urine samples, where it is necessary to assess the sample as a complete 24-hour collection. However, if several tests (e.g. steroids) are done on a single such sample, only one creatinine would be claimed for that sample. In those estimations where the test result is expressed in terms of creatinine excretion the performance of a creatinine is mandatory and should be claimed.
11. It is recognized that in requests for a serologic titre, if a screening test is used and would suffice, the lesser benefit for the screening test should be claimed. If positive and followed by serial titration, both the screening and titre fees should be claimed. If the titration is a micro technique using plates, it is the equivalent of a tube titre, the wells being miniature tubes.
12. When a test for trichomonas identification (any method) is carried out in association with L625 or L627, wet preparation (L653) may be claimed in addition. L653 may be claimed when a Wet Preparation is used for direct examination of a fresh specimen for vegetative amoebae or similar parasites. However, the wet preparation used in the faeces concentration technique for parasites and ova is included in L650.

The conditions set down in paragraph 7 of this preamble must be adhered to.

13. It is recognized that in all laboratory tests there is a professional component.
14. The maximum number of units which can be claimed for any combination of L418 (Hemoglobin), L417 (Hematocrit), L399 (WBC[LKS] Count) and L397 (RBC[ERC] Count) is 11 units per patient per day, whether automated, semi-automated or manual methods are used. L700 is not included in this total and should be claimed separately, if appropriate. Laboratories using multichannel equipment should use individual codes as described above.
15. The maximum number of units which can be claimed for any combination of the tests represented by the following codes will be 40 LMS units per patient per day:

L005	L045	L061	L111	L194	L208	L223
L226	L252					
L030	L053	L067	L191	L204	L222	L225
L251						

The maximum of 40 units applies on a per patient basis, regardless of the number of specimens submitted and

regardless of the number of laboratories involved in performing the individual tests. Code L700 is not included in this maximum and should be claimed separately if appropriate.

- 16. The maximum number of units which may be claimed for any combination of chemical analyses performed on a single sample by means of an automated chemical analyzer with simultaneously functioning channels is 18 LMS units (L225).
- 17. The following preamble applies to the blood bank section:
 - (a.) L471 Antibody Identification — incomplete antibodies. A panel of any number of cells regardless of suspending media or technique used. Preparation of eluate and/or antibody absorption is included.
 - (b.) L472 Antibody Identification — complete antibodies. A panel of any number of cells for the identification of complete antibodies by direct agglutination.
 - (c.) L473 Parallel Titration — New code to be used when two sequential patient serum specimens are tested to detect a change in antibody titre. Includes a repeat antibody identification on the current sample.
 - (d.) L490 Blood Group — ABO and Rh₀(D). The subgroups of A and RhD^u are included where indicated. A direct AHGT is also included in L490 therefore, L495 may not be charged on the same patient when this code is claimed.
 - (e.) L492 Crossmatch. When an initial crossmatch is requested the appropriate claim is for L490 × 1, L482 × 1 plus L492 for each unit ordered. L490 and L482 may not be claimed more than once on the same day of service. L490 and L493 may not be claimed when these procedures are carried out as a confirmatory test on the units of blood to be transfused.
 - (f.) L493. This code includes L490 (see preamble d.) and Rh genotype to include the antigens C, D, E, c, e, and D^u when indicated. Any other antigen is to be claimed under L494.
 - (g.) L494 Blood Group per antigen. Antigens stated in L493 and L490 are excluded from this code.
 - (h.) L495 Direct AHGT — can be used when ordered as a single procedure, or in addition to L482 when the latter is requested as a single procedure. L495 may not be claimed when L490 or L493 is claimed with L482 on the same patient on the same visit.
- 18. Antibiotic sensitivities should not be done routinely, but only when, by reason of its identification and/or its concentration, the isolated organism has a high probability of being pathogenic. L621 applies to all routine antibiotic sensitivity testing regardless of the method used and including MIC determination by manual kit or automated methodologies.
- 19. The use of Nickersons Medium as a screening test for yeast is not a benefit.
- 20. The carcinoembryonic antigen test (CEA) L690 is not to be used as a general cancer screen. It is to be used only for following established malignancies.
- 21. This preamble is intended to apply to everyone using codes L700, L001 to L731 and L900 to L944.
- 22. Fees for laboratory medicine testing are not refundable (in

whole or in part) to the referring physician or referring laboratory by the laboratory performing the tests.

- 23. The benefits for patient documentation and specimen collection and each test are calculated by multiplying the individual L.M.S. Unit values by 48.3 cents.
- 24. Laboratory tests on specimens sent outside Ontario are not a benefit of the Plan.
- 25. Secondary Laboratories receiving specimens for additional (secondary) tests from another Laboratory that normally would be claimed as L303, L319, L500 or L544 should be claimed as L903, L919, L900 or L944 respectively.
- 26. When a pregnancy test is requested, L655 should be performed. L318 should only be performed when H.C.G. or Beta sub-units are specifically requested by the referring physician.

Code		LMS Units
L700	PATIENT DOCUMENTATION AND SPECIMEN COLLECTION FEE	9
	1. Limited to 1 per patient, per day.	
	2. Not allowed to the recipient of a referred sample from another laboratory.	
	3. Not allowed to the attending physician.	
	4. Not applicable to a patient visit solely to receive instructions or collection containers.	
	5. When multiple tests are ordered for the same patient for the same day, only one L700 may be claimed even though all specimens may not be available on any one day.	
	6. Not applicable to items under anatomical pathology, histology and cytology sections. (Fee codes L701 to L731 inclusive, L800 to L848 or L900 to L944 inclusive.)	
	BIOCHEMISTRY	
	(Applicable to all specimens except as denoted by B-blood, U-urine, F-faeces, C-CSF., A-amniotic fluid).	
L059	Acetaminophen	25
L001	Acetone, Qualitative	3
L002	Acetone, Quantitative	35
L003	Addis count-U	32
L004	Albumin, Qualitative	3
L005	Albumin, Quantitative (excluded if globulin and/or protein electrophoresis done)	10
L006	Alcohol, Ethyl-Quantitative	43
L007	Alcohols, Qualitative	25
L008	Alcohols, Fractionation and Quantification	45
L009	Aldolase	30
L010	Aldosterone	120
L011	Amino Acids — one way chromatography — B, U	15
L012	Amino Acids — two way chromatography — U	30
L013	Amino Acids, Fractionation and Quantitation	200
L014	Amino Acid Nitrogen	33
L071	Aminoglycosides (Gentamicin, Tobramycin) ..	40
L020	Aminophylline, Quantitative (theophylline) ...	40
L015	Ammonia	39
L016	Amniotic Fluid Scan	20
L017	Amniotic Fluid L/S Ratio	50
L018	Amylase	22
L021	Androstenedione	75
L019	Ascorbic Acid	25
L025	Barbiturates, Qualitative	25
L026	Barbiturates, Quantitative	35

Code	LMS Units	Code	LMS Units
L027	Barbiturates, Fractionation and Quantification	L105	Galactose (per sample)
	L106	Galactose-1-phosphate uridyl transferase
L028	Bile microscopy		(quantitative)
L029	Bilirubin, Qualitative — F	L113	Galactose-1-phosphate uridyl transferase
L030	Bilirubin, total		(screening)
L031	Bilirubin, conjugated	L107	Gamma glutamyl transpeptidase
	Blood gases (see fee codes L032 to L036	L109	Gastric analysis titration (per sample)
	inclusive, in this Schedule)	L110	Globulin (excluded if albumin and/or protein
L037	Blood Volume — excluding injection of dye ...		electrophoresis done)
L038	Bromides	L111	Glucose, quantitative (not by dipstick)
L039	Bromosulphthalein (BSP) excluding injection	L112	Glucose, semi-quantitative (dipstick if read
	of dye		with reflectance meter)
L045	Calcium	L104	Glucose tolerance test
L046	Calcium Ionized	L103	Glucose tolerance test in pregnancy
L047	Calculus analysis — chemical, Qualitative	L114	Glutathione
L048	Calculus analysis, Qualitative and Quantitative	L115	Glycoproteins
	L093	Glycosylated hemoglobin — HgbA ₁
L073	Cannabinoid	L116	Gold
L040	Carbamazepine, Quantitative (Tegretol)	L119	Hexosaminidase A
L049	Carotene	L120	Haptoglobin
L050	Catecholamines, total	L132	Hemoglobin A ₂ by column chromatography ...
L051	Catecholamines, fractionated	L121	5HIAA Screening — U
L052	Ceruloplasmin	L122	5HIAA Quantitation — U
L041	Chlordiazepoxide, Quantitative (Librium)	L117	High Density Lipoprotein Cholesterol
L053	Chloride	L118	Histamine
L054	Chloride (sweat)	L123	Homogentisic Acid (Qualitative)
L055	Cholesterol, total — not to be charged with	L101	Homovanillic Acid, HVA
	L156	L124	Hydroxy Butyrate Dehydrogenase
L056	Cholesterol, ester — not to be charged with	L125	17-Hydroxycorticosteroids — U
	L156	L126	17-Ketogenic steroids — U
L057	Cholinesterase — pseudo or true	L127	17-Ketosteroids, total — U
L058	Cholinesterase Genotyping (includes pseudo,	L128	17-Ketosteroids, fractionated — U
	Dibucaine and Fluoride)	L129	Hydroxyproline — B
L060	Carboxyhemoglobin	L130	Hydroxyproline, Total — U
L061	CO ₂ Content, CO ₂ Combining Power,	L131	Hydroxyproline, Total and Free — U
	Bicarbonate (measured, not calculated)	L135	Inulin Clearance Test
L062	Chymotrypsin	L136	Insulin
L063	Copper	L142	Intestinal enzymes — qualitative
L064	Cortisol		— quantitative
L065	Creatine (includes creatinine)	L143	— quantitative
L066	Creatine Phosphokinase	L137	Iodine Protein Bound
L070	Creatine Phosphokinase, fractionation	L139	Iron, Total — with iron binding capacity
L067	Creatinine (not with L068)	L141	Iso-Citric Dehydrogenase
L068	Creatinine Clearance	L145	Lactic Acid (lactate)
L075	Crystal Identification (x-ray powder diffraction	L146	Lactic Dehydrogenase (L.D.H.), total
	analysis)	L147	Lactic Dehydrogenase Fractionation
L069	Cystine Screening — U	L148	Lead
L074	Diazepam, Quantitative (Valium, Vivol)	L149	Leucine Aminopeptidase
L072	Digoxin	L159	Lidocaine
L077	Diphenylhydantoin, Quantitative (phenytoin,	L150	Lipase
	Dilantin)	L151	Lipid (total)
L076	Disopyramide	L152	Lipids (Thin Layer Chromatography)
L078	Drug Screen	L153	Lipoprotein, Electrophoresis — not to be
L079	Drug Screening with chromatographic		charged with L156
	confirmation	L154	Lipoprotein, Ultracentrifugation
L085	Electrophoresis, serum — including total	L155	Lipoprotein Lipase (Frederickson)
	protein	L156	Lipoprotein phenotyping (includes sample
L086	Electrophoresis, other than serum — including		appearance, cholesterol, triglycerides,
	total protein		lipoprotein, electrophoresis and
L080	Electrophoresis, serum — alone		interpretation) — not to be charged with
L087	Estradiol		L055, L153 or L243
L088	Estriol — B	L157	Lithium
L089	Estriol, Pregnancy — U	L158	Luteinizing Hormone (LH), chemical (not
L090	Estrogens, total — U		immunologic)
L091	Estrone	L165	Magnesium
L092	Ethosuximide, Quantitative (Zarontin)	L166	Malic Dehydrogenase
L095	Fat, total — F	L167	Melanin — U
L096	Fat, Differential — F	L168	Mercury
L097	Fat and/or meat fibres (microscopic) — F	L169	Metanephrines, total — U
L098	Fat (microscopic) — U	L170	Metanephrines, fractionated — U
L099	Fatty Acids, free	L163	Methadone
L094	Flurazepam, Quantitative (Dalmane)	L171	Methemalbumin
L100	F.S.H. (Pituitary Gonadotrophins)	L172	Methemoglobin
		L160	Methotrexate (Amethopterin)

Code		LMS Units	Code		LMS Units
L175	Methylphenidate, quantitative (Ritalin)	40	L252	Uric Acid	6
L164	Morphine	15	L253	Urinalysis, routine (includes microscopic examination of centrifuged specimen plus any of S.G., pH, protein, sugar, hemoglobin, ketones, urobilinogen, bilirubin)	8
L173	Mucopolysaccharides — U	25	L254	Urinalysis, one or more parts of above without microscopy	3
L174	Myoglobin, Qualitative — U	30	L267	Urobilin, Qualitative — U	7
L161	N-acetylprocainamide	35	L255	Urobilinogen, Qualitative — U	7
L180	5'-Nucleotidase	25	L256	Urobilinogen, Quantitative — U	15
L181	Occult blood	3	L257	Valproic Acid	35
L044	Organic acid profile (by GC-MS)	200	L260	Vitamin A	30
L182	Ornithine Carbonyl Transferase	15	L261	VMA (Vanilmandelic Acid)	60
L183	Osmolality (osmolarity)	10	L265	Xylose Absorption Test (per specimen)	6
L184	Oxalic Acid — U	40	L266	Zinc	25
L185	P.A.H. Clearance	40	L299	Biochemical assays not included above	1.C.
L081	Phenobarbitone (Luminal)	35	Note: Biochemical assays other than specifically listed are not a benefit as such until approved by OHIP.		
L032	pCO ₂	8	RADIOASSAYS and LIGAND ASSAYS — The following listings are to be used if the assay involves the use of a radioisotope, enzyme or fluorescent label.		
L033	pO ₂ (arterial)	8	L307	ACTH (Adrenocorticotrophic Hormone)	120
L034	pH	7	L300	Aldosterone	120
L035	pCO ₂ , pO ₂ and pH in combination	17	L691	Alphafetoprotein	45
L036	pCO ₂ , pO ₂ , pH — calculation of one or more of standard bicarbonate, base excess, etc.	3	L304	Aminoglycosides	40
L187	Phenothiazines, Qualitative — U	6	L321	Aminophylline (Theophylline)	40
L188	Phenothiazines, Quantitative — U	30	L305	Androstenedione	75
L189	Phenylalanine	15	L322	Anti-DNA	45
L190	Phosphatase, Acid	15	L323	Anti-RNA	45
L191	Phosphatase, Alkaline	10	L301	Calcitonin	120
L192	Phosphatase, Alkaline fractionation	29	L302	C — AMP (Cyclic Adenosine Monophosphate)	60
L193	Phospholipids	30	L346	C-peptide Immunoreactivity	60
L194	Phosphorus (inorganic phosphate)	10	L690	Carcinoembryonic antigen (CEA)	1.C.
L195	Plasma Clearing Factor (Baker)	35	L303	Cortisol	35
L196	Plasma Hemoglobin	15	L903	Cortisol, secondary Laboratory	35
L197	Porphobilinogen (PBG), screen — U	10	L347	Dehydroepiandrosterone	75
L198	Porphobilinogen (PBG), Quantitative — U	25	L605	1,25 Dihydroxy Vitamine D	150
L199	Delta-aminolevulinic Acid (ALA), Quantitative — U	25	L306	Digoxin	45
L200	Porphyryns, screen	10	L324	Diphenylhydantoin (Phenytoin), Quantitative (Dilantin)	35
L201	Porphyryns, Quantitation (copro, proto, uro) — U	60	L310	Estradiol	75
L202	Porphyryns, Quantitation (copro, proto, uro) — B	75	L311	Estriol	75
L203	Porphyryns, Quantitation (copro, proto, uro) — F	90	L312	Estrogens — total — U	50
L204	Potassium	6	L313	Estrone	75
L205	Pregnanediol — U	70	L329	Ferritin	45
L206	Pregnanetriol — U	80	L308	Folate, serum — not to be billed in addition to L309	45
L211	Primidone, Quantitative (Mysoline)	35	L309	Folate, in red cells, to include serum folate and hematocrit	98
L212	Procainamide	35	L315	FSH (Pituitary Gonadotrophins)	60
L207	Progesterone	50	L316	Gastrin	75
L214	Propoxyphene	35	L317	Growth Hormone	40
L213	Propranolol	35	L318	HCG (Human Chorionic Gonadotrophins) ...	40
L208	Protein, total — not to be charged with L085 or L086	10	L319	Hepatitis associated antigen or antibody immunoassay — per assay, e.g. Hepatitis B surface antigen or antibody, hepatitis B anticore antibody, hepatitis A antibody	35
L209	PSP (Phenolsulphonphthalein)	15	L919	Hepatitis associated antigen or antibody radio- immunoassay by secondary Laboratory per assay	35
L210	Pyruvic Acid (pyruvate)	27	L693	Hormone receptors for carcinoma (to include estrogen and/or progesterone assays)	1.C.
L215	Quinidine	18	L320	HPL (Human Placental Lactogen)	50
L216	Reducing substances, identified by chromatography	30	L606	25 Hydroxy Vitamin D	100
L220	Salicylate, Qualitative	5	L334	IgE	45
L221	Salicylate, Quantitative	12	L688	Immune Complexes by Clq binding	60
L222	SGOT (AST)	10	L689	Immune Complexes by Raji cell assay	100
L223	SGTP (ALT)	10	L325	Insulin	40
L225	Automated chemical analyzers with simultaneously functioning channels (single sample)	18			
L226	Sodium	6			
L227	Spectroscopic examination (any)	20			
L228	Sulphemoglobin	21			
L229	Sulphonamides	27			
L230	T-4, Total (Thyroxine)	24			
L240	Thiocyanates	15			
L242	Thyroxine — Binding Globulin	50			
L243	Triglycerides — not to be charged with L156 ...	15			
L244	Trypsin	22			
L250	Urea Clearance	15			
L251	Urea Nitrogen (B.U.N.)	6			

Code	LMS Units	Code	LMS Units
Immunoelectrophoresis			
L575	40	L535	50
			antimitochondrial
			antithyroid
			antiadrenal
			antismooth muscle
			antiparietal
			antiskin
			antisperm
L576	30	L545	75
			Protein deposition in tissues (per tissue examined, any number of antisera, e.g. immunoglobulin, complement component, fibrinogen and pathogens, etc.)
Double gel diffusion, qualitative (Ouchterlony) per antigen			
L568	5		
			Histocompatibility Testing
		L580	200
			Tissue typing
L567	5	L581	50
			Crossmatch
L565	5	L582	150
			Antibody screening (per panel of 15 antigens) .
L566	5	L583	50
			HLA 27 typing
Miscellaneous Agglutination Reactions			
eg.			
Rheumatoid factor			
Antithyroid (thyroglobulin or microsomal)			
Streptolysin screen			
L500	6	L659	25
			Antistreptolysin O, or anti D Nase B, titer or micro technique
L900	6	L662	20
			Complement fixation, screen
L502	30	L663	30
			titre, single antigen
L501	15	L664	50
			multiple antigens
L660	6	L667	12
			Non-cultural direct bacterial antibody or antigen assays by fluorescence, agglutination or ELISA techniques. Not to be claimed with any of the codes listed under cultures and not to include streptococcus Type A, Chlamydia or HTLV-III/LAV antibody
L661	15	L669	12
			Non-cultural direct Chlamydia assays by fluorescence or ELISA techniques
L595	15	L682	4
			For each additional antibody add
L596	20	L683	15
			For Indirect fluorescent antibody
L597	40	L684	5
			For each additional antibody add
L665	6	L668	5
			Heterophile antibodies — screen (slide or single tube) with or without absorption
L655	6	L670	30
			Heterophile antibodies — with absorption by guinea pig kidney and ox cells, multiple tube titres (Paul Bunnell)
L598	15	L658	6
			Trichinella antibody
Cellular Assays			
L520	30	L679	30
			Virus antibodies — haemagglutination inhibition or ELISA technique
L522	150		Note: Not to be used for AIDS testing.
		L680	40
L521	100		Virus antibodies — neutralization test
		L681	90
			Virus antibodies sucrose gradient separation of IgM plus inhibition test
L523	40	N.C.	5
			VDRL (Patient Out of the Province — L999) .
L524	200	L503	25
			Febrile agglutinins, slide or tube agglutination
L525	200	L319	45
			Hepatitis associated antigen or antibody radioimmunoassay — per assay e.g. hepatitis B surface antigen or antibody hepatitis B anticore antibody hepatitis A antibody
L526	200		
			Miscellaneous
L527	300	L599	5
			Cryofibrinogen — Qualitative
L528	200	L600	5
			Cryoglobulin — Qualitative
L529	200	L601	30
			Cryoglobulin — Quantitative
L532	300	L602	5
			Pyroglobulin — Qualitative
L533	275	L604	10
			Serum viscosity — relative
Complement — kinetic (activity) assays			
L530	50	L603	20
			— quantitative
L531	60		
			Radioimmunoassay — see listings under Radioassays
Fluorescent Antibody Tests (Immunofluorescent Studies)			
Tests for serum antibodies to tissue and cell components (codes L535 and L544) should be claimed per type of tissue section examined and per serum dilution used, irrespective of number of antibodies identified, maximum four slides.			
L544	35	L610	2
			antinnuclear
			Concentration of sample before testing (any method)

Code	LMS Units	Code	LMS Units
L611		L653	
Radio-modification of standard technique utilizing isotope labelled reagents, e.g. anti-insulin, anti-diphtheria, anti-tetanus	50	Wet preparation (for fungus, trichomonas, parasites)	3
— immunoelectrophoresis			
— double diffusion			
— radial diffusion			
Preparation of special antigens or antisera	I.C.		
Special investigations	I.C.		
MICROBIOLOGY		ANATOMICAL PATHOLOGY, HISTOLOGY AND CYTOLOGY	
L620	40	Note: Do not claim L700 in addition to codes L701 to L731 or L800 to L837.	
L621	12	The items listed in this section include only the technical component of the various items listed. The professional component for each item where applicable is listed in the following section.	
Antibiotic level, serum		Autopsy, gross and microscopic (including CNS as required)	N.A.B.
L621	25	Referred — in organs, gross and microscopic ..	N.A.B.
Antibiotic sensitivity — per organism, max. of 2 per specimen		Removal of brain and/or spinal cord	N.A.B.
L623	55		
— M.I.C. — one antibiotic, tube or agar dilution		Chromosome Analysis	
L622	30	L701	70
L624	25	L702	300
Cultures — blood (including aerobic, anaerobic, subcultures, smears) per bottle		L703	475
L625	25		
— cervical, vaginal, including GC culture, Gram smear, yeast identification (e.g. Germ tube) — not to be charged with L627		Cytology and Histology	
L639	28	L704	8
— fluids (CSF, joint, pleural etc. not exudates)		L705	32
L626	20	L706	14
— fungus, including KOH preparation and smear — not to be charged with L625		L707	8
L627	20	L708	14
— GC culture and smear — not to be charged with L625		L709	33
L628	25	L710	13
— other swabs or pus — culture and smear		L711	13
L629	22	L712	8
— sputum — culture and smear		L713	14
L630	34	L714	8
— stool culture including the necessary agglutinations and culture for campylobacter		L715	3
L640	6	L716	14
— throat swab, for streptococcus, screen only		L717	225
L631	55	L726	40
— tuberculosis, including ZN or fluorescent smear	100	L723	250
L632	7	L724	30
— animal inoculation		L725	30
L641	20	L718	22
— urine, screening, actual culture without identification — see Preamble		L719	7
L633	13	L720	32
— urine, pour plate or Miles-Misra quantitation		L721	15
L634	20	L722	8
urine calibrated volume to include plate, turbidimetric or photometric techniques		L727	50
L642	5	L728	40
Lysozyme inhibition test		L729	13
L635	8	L730	75
Pathogenic E coli (as sole procedure in infants only, such as fluorescent staining, not with L630)		L731	75
L656	18		
Penicillinase production		Immunoperoxidase technique — per label (maximum of 3 per specimen)	75
L636	18		
Streptococcus grouping, Lancefield or equivalent with extractions			
L638	18		
Streptococcus grouping, coagglutination method			
L637	50		
Virus isolation			
Microscopy			
L645	10		
Darkfield (spirochetes)			
L646	40		
Electron — direct, for viruses			
L647	60		
— immunoelectron microscopy			
L648	65		
— after ultracentrifugation			
L649	130		
— thin section, for virus			
L650	25		
Parasites and ova (faeces concentration)			
L654	25		
Parasites and ova, smear only, special stain			
L651	5		
Pinworm (Scotch tape prep)			
L643	5		
Smear only, Gram or Papanicolaou stain, as sole procedure (not with L624-L634)			
L652	14		
Smear only, special stain, e.g. ZN, inclusions, spores, diphtheria			

Code		LMS Units
	ANATOMICAL PATHOLOGY, HISTOLOGY AND CYTOLOGY (Professional components only)	
N.C.	Autopsy, gross and micro (including CNS as required)	N.A.B.
N.C.	Referred — in organs, gross and microscopic — each	N.A.B.
N.C.	Removal of brain and/or spinal cord	N.A.B.
O. Reg. 290/84, s. 6; O. Reg. 827/84, s. 1; O. Reg. 347/85, s. 1; O. Reg. 32/86, s. 5; O. Reg. 158/86, s. 1; O. Reg. 288/86, s. 1; O. Reg. 704/86, s. 1; O. Reg. 471/87, s. 1; O. Reg. 94/89, s. 4; O. Reg. 583/89, s. 5.		

Schedule 12

1. Abstainers Insurance Company	30. Centennial Insurance Company
2. Advocate General Insurance Company of Canada	31. The Century Insurance Company of Canada
3. Aetna Casualty Company of Canada	32. Chateau Insurance Company
4. The Aetna Casualty and Surety Company	33. The Citadel General Assurance Company
5. Aetna Insurance Company	34. Coachman Insurance Company
6. Algoma Mutual Fire Insurance Company	35. Commercial Union Assurance Company of Canada
7. Allianz Insurance Company	36. Constitution Insurance Company of Canada
8. Allstate Insurance Company of Canada	37. The Continental Insurance Company
9. Alpina Insurance Company Limited	38. The Continental Insurance Company of Canada
10. The American Insurance Company	39. The Contingency Insurance Company Limited
11. American Mutual Liability Insurance Company	40. Co-Operative Fire and Casualty Company
12. Anglo Canada General Insurance Company	41. Co-Operators Insurance Association
13. The Ayr Farmers' Mutual Fire Insurance Company	42. Cornhill Insurance Company Limited
14. Baltica-Skandinavia Insurance Company of Canada	43. Coronation Insurance Company Limited
15. The Bay City General Insurance Company	44. Culross Mutual Fire Insurance Company
16. Bay of Quinte Agricultural Mutual Fire Insurance Company	45. Cumis General Insurance Company
17. Bertie and Clinton Mutual Fire Insurance Company	46. Cumis Insurance Society, Inc.
18. Blanchard Mutual Fire Insurance Company	47. Dominion Insurance Corporation
19. Brant Mutual Fire Insurance Company	48. The Dominion of Canada General Insurance Company
20. The Canada Accident and Fire Assurance Company	49. Dufferin Mutual Fire Insurance Company
21. The Canadian Commerce Insurance Company	50. Dumfries Mutual Fire Insurance Company
22. Canadian General Insurance Company	51. Dunwich Farmers' Mutual Fire Insurance Company
23. Canadian Home Assurance Company	52. East Williams Mutual Fire Insurance Company
24. The Canadian Indemnity Company	53. Eaton Bay Insurance Company
25. The Canadian Provincial Insurance Company	54. Economical Mutual Insurance Company
26. The Canadian Surety Company	55. Elma Mutual Fire Insurance Company
27. Canadian Universal Insurance Company Limited	56. Employers Insurance of Wasau a Mutual Company
28. The Casualty Company of Canada	57. Erie Mutual Fire Insurance Company
29. Cayuga Mutual Fire Insurance Company	58. Farmers' Mutual Fire Insurance Company (Lindsay)
	59. Federal Insurance Company
	60. Federated Mutual Insurance Company
	61. Federation Insurance Company of Canada
	62. Fidelity Insurance Company of Canada
	63. Fireman's Fund Insurance Company
	64. Fireman's Fund Insurance Company of Canada
	65. First National Insurance Company of America
	66. Formosa Mutual Fire Insurance Company
	67. The General Accident Assurance Company of Canada

- | | |
|--|--|
| 68. General Insurance Company of America | 105. The Mississquoi and Rouville Insurance Company |
| 69. General Security Insurance Company of Canada | 106. National Employers Mutual General Insurance Association Limited |
| 70. Gerling Global General Insurance Company | 107. Niagara Fire Insurance Company |
| 71. Germania Farmers' Mutual Fire Insurance Company | 108. Non-Marine Underwriters, Members of (Lloyd's) London, England |
| 72. Gibraltar General Insurance Company | 109. Norfolk Mutual Fire Insurance Company |
| 73. Gold Circle Insurance Company | 110. North Blenheim Farmers' Mutual Fire Insurance Company |
| 74. Gore Mutual Insurance Company | 111. North Kent Mutual Fire Insurance Company |
| 75. The Grenville Patron Mutual Fire Insurance Company | 112. Northern Frontier General Insurance Company |
| 76. Grey & Bruce Mutual Fire Insurance Company | 113. The Nova Scotia General Insurance Company |
| 77. Guarantee Company of North America | 114. The Omaha Indemnity Company |
| 78. Guardian Insurance Company of Canada | 115. Ontario Motorist Insurance Company |
| 79. The Halifax Insurance Company | 116. Ontario Mutual General Insurance Company |
| 80. Halwell Mutual Fire Insurance Company | 117. Otter Dorchester Mutual Insurance Company |
| 81. The Hartford Fire Insurance Company | 118. Oxford Mutual Fire Insurance Company |
| 82. Hay Township Farmers' Mutual Fire Insurance Company | 119. Pafco Insurance Company, Limited |
| 83. Herald Insurance Company | 120. The Peel and Maryborough Mutual Fire Insurance Company |
| 84. Highlands Insurance Company | 121. The Personal Insurance Company of Canada |
| 85. The Home Insurance Company | 122. Perth Insurance Company |
| 86. Howard Mutual Fire Insurance Company | 123. Phoenix Assurance Company of Canada |
| 87. Howick Farmers' Mutual Fire Insurance Company | 124. Pilot Insurance Company |
| 88. INA Insurance Company of Canada | 125. Pitts Insurance Company |
| 89. Insurance Company of North America | 126. The Portage la Prairie Mutual Insurance Company |
| 90. The Insurance Corporation of Ireland Limited | 127. Premier Insurance Company |
| 91. Jevco Insurance Company | 128. Prescott Mutual Fire Insurance Company |
| 92. Lambton Mutual Fire Insurance Company | 129. La Prevoyance Compagnie D'Assurances |
| 93. The Lanark County Farmers' Mutual Fire Insurance Company | 130. The Provident Assurance Company |
| 94. La Paix General Insurance Company of Canada | 131. The Prudential Assurance Company Limited (of England) |
| 95. La Paix Compagnie D'Assurances Generales Du Canada | 132. Quebec Assurance Company |
| 96. Liberty Mutual Fire Insurance Company | 133. Reliance Insurance Company |
| 97. The London Assurance | 134. Royal General Insurance Company of Canada |
| 98. London-Canada Insurance Company | 135. Royal Insurance Company of Canada |
| 99. London Township Mutual Fire Insurance Company | 136. Safeco Insurance Company of America |
| 100. Lumbermen's Mutual Casualty Company | 137. Scottish & York Insurance Company Limited |
| 101. Maplex General Insurance Company | 138. St. Paul Fire and Marine Insurance Company |
| 102. Markel Insurance Company of Canada | 139. Security Casualty Company |
| 103. McGillivray Mutual Fire Insurance Company | 140. Security Mutual Casualty Company |
| 104. McKillop Mutual Fire Insurance Company | 141. Sentry Insurance A Mutual Company |

- | | |
|---|---|
| <p>142. Simcoe & Erie General Insurance Company</p> <p>143. South Easthope Farmers' Mutual Fire Insurance Company</p> <p>144. The Sovereign General Insurance Company</p> <p>145. The Stanstead & Sherbrooke Insurance Company</p> <p>146. State Farm Mutual Automobile Insurance Company</p> <p>147. Sun Alliance Insurance Company</p> <p>148. The Tokio Marine and Fire Insurance Company Limited</p> <p>149. Toronto General Insurance Company</p> <p>150. Townsend Farmers' Mutual Fire Insurance Company</p> <p>151. Traders General Insurance Company</p> <p>152. Trafalgar Insurance Company Limited</p> <p>153. Transit Insurance Company</p> <p>154. Transport Insurance Company</p> <p>155. Travelers Indemnity Company</p> <p>156. Travelers Indemnity Company of Canada</p> <p>157. The United Provinces Insurance Company</p> <p>158. United States Fidelity and Guaranty Company</p> <p>159. United States Fire Insurance Company</p> <p>160. The Unity Fire and General Insurance Company</p> <p>161. Victoria Insurance Company of Canada</p> <p>162. Wabisa Mutual Fire Insurance Company</p> <p>163. Waterloo Mutual Insurance Company</p> <p>164. The Wawanesa Mutual Insurance Company</p> <p>165. West Elgin Mutual Fire Insurance Company</p> <p>166. West Wawanosh Mutual Fire Insurance Company</p> <p>167. The Western Assurance Company</p> <p>168. Westminster Mutual Fire Insurance Company</p> <p>169. The Yarmouth Mutual Fire Insurance Company</p> <p>170. York Fire & Casualty Insurance Company</p> <p>171. Zurich Insurance Company</p> | <p>When such procedures commence after 5:00 p.m. and before midnight or on Saturdays, Sundays and holidays the procedural fee is increased by 30% (T809).</p> <p>When such procedures commence after midnight but before 7:00 a.m. on any night the procedural fee is increased by 50% (T810).</p> <p>3. Multiple Operative Procedures: when more than one procedure is performed, the major procedure will be paid at the full fee and subsequent procedures performed at the same time will be paid at 85% of the listed fee, unless multiple procedures are identified by a specific code or specific add on services.</p> <p>4. APPLICATION OF FIXATION DEVICES AND SPLINTS. The procedures and fees involving fractures and dislocations listed in the schedule of benefits include all intra-operative surgical aspects of that procedure and include the placement of arch bars, intermaxillary fixation and the wiring of dentures or splints.</p> <p>5. CONSULTATIONS</p> <p>A. Dental consultations are benefits of the Plan when such consultations are requested by a physician or dental/oral surgeon in light of his or her professional knowledge of the patient.</p> <p>B. A hospital consultation fee is payable in addition to the listed dental procedure(s).</p> <p>C. A consultation report must be entered on the patient's chart.</p> <p>D. Consultation fees are payable for admitted bed patients and for patients in the Emergency or Out-patient Department when the dental/oral surgeon is requested to see the patient in consultation. Consultations are not insured services for patients seen in a private dental office, even if the office is located in a hospital.</p> <p>6. SURGICAL ASSISTANT</p> <p>Assistant's fees should only be claimed when the complexity of the procedure requires the assistance of a second qualified surgeon. Assistant's fees are not payable for procedures where an assistant is not normally required.</p> |
|---|---|

R.R.O. 1980, Reg. 452, Sched. 17; O. Reg. 525/81, s. 1; O. Reg. 576/81, s. 1; O. Reg. 642/81, s. 1.

Schedule 13

PREAMBLE

1. The surgical benefits include hospital visits rendered by the dental surgeon/oral surgeon, the in-hospital operative procedure, usual post-operative care rendered by the surgeon in hospital and one follow-up visit in the office.

2. **PREMIUMS:**

Non-elective Dental Surgical Procedures

	Column 1	Col. 2	Col. 3
	GINGIVOPLASTY AND VESTIBULOPLASTY		
T330 73119	Gingivoplasty, independent of tooth extraction, per quadrant	34.60	41.60
T331 73121	Excision of vestibular hyperplastic tissue, per quadrant	—	97.30
T332 73123	Surgical shaving of papillary hyperplasia of the palate	—	179.00
T333 73130	Remodelling of the mylohyoid ridge	—	126.40
T334 73131	Remodelling of the genial tubercles	—	126.40
T335 73132	Excision of nasal spine	—	126.40
T336 73133	Excision of torus palatinus	117.00	140.40
		-234.90	-281.90
T337 73134	Excision of torus mandibularis, unilateral	117.00	140.40
		-234.90	-281.90
T338 73135	Excision of torus mandibularis, bilateral	117.00	140.40
		-234.90	-281.90
T339 73140	Removal of multiple exostosis, per quadrant	117.00	140.40

	Column 1	Col. 2	Col. 3		Column 1	Col. 2	Col. 3
T340 73141	Removal of multiple exostosis, per arch	117.00	140.40	T380 74300	BONE GRAFTS — RECONSTRUCTION Bone graft to maxilla or mandible, unilateral	—	677.00
		-234.90	-281.90	T381 74301	Bone graft to maxilla or mandible, bilateral	—	924.60
T341 73150	Reduction tubero-plasty, unilateral	—	131.70		CYSTS		
T342 73151	Reduction tubero-plasty, bilateral	—	263.30	T390 74408	Excision of cyst, not in conjunction with tooth removal (enucleation including biopsy) 1 cm. or under	103.00	123.55
T343 73160	Augmentation pterygo-maxillary tubero-plasty, unilateral	—	131.70	T391 74401	Excision of cyst, not in conjunction with tooth removal (enucleation including biopsy) 1 cm. to 3 cm.	—	131.70
T344 73161	Augmentation pterygo-maxillary tubero-plasty, bilateral	—	263.30	T392 74411	Excision of cyst, not in conjunction with tooth removal (enucleation including biopsy) over 3 cm.	—	224.20
T345 73200	Total lowering of floor of mouth	—	395.20	T394 74410	Marsupialization of cyst (includes 12 post surgical visits)	—	278.30
T346 73201	Partial lowering of floor of mouth	—	234.00		SURGICAL INCISION		
T347 73300	Submucous vestibuloplasty, maxilla	—	234.00	T397 75208	Surgical exploration — soft tissue intraoral	—	81.10
T348 73301	Submucous vestibuloplasty, mandible	—	234.00	T398 75209	Surgical exploration — soft tissue extraoral	—	197.70
T349 73310	Vestibuloplasty with secondary epithelization, maxilla	—	309.20	T399 75212	Surgical exploration — hard tissue intraoral	—	164.10
T350 73311	Vestibuloplasty with secondary epithelization, mandible	—	309.20	T400 75214	Surgical exploration — hard tissue extraoral	—	314.30
T351 73330	Vestibuloplasty with skin graft, maxilla	—	552.80	T401 75100	Incision and drainage — soft tissue, intraoral	29.00	34.80
T352 73331	Vestibuloplasty with skin graft, mandible	—	552.80	T402 75110	Trephination and drainage — hard tissue, intraoral	68.30	81.95
T353 73340	Vestibuloplasty with mucosal graft, maxilla	—	618.70	T403 75200	Incision and drainage of abscess, extraoral	—	145.60
T354 73341	Vestibuloplasty with mucosal graft, mandible	—	618.70	T404 75500	Sequestrectomy for osteomyelitis, intraoral	—	124.80
T355 73350	Alveolar ridge reconstruction with autogenous bone, maxilla	—	618.70	T405 75501	Sequestrectomy for osteomyelitis, extraoral	—	281.20
T356 73351	Alveolar ridge reconstruction with autogenous bone, mandible	—	618.70	T406 75510	Sequestrectomy and saucerization	—	301.75
T357 73360	Alveolar ridge reconstruction with alloplastic material, maxilla	—	618.70		MAXILLECTOMY/ MANDIBULECTOMY		
T358 73361	Alveolar ridge reconstruction with alloplastic material, mandible	—	618.70	T407 75531	Partial mandibulectomy — up to 3 cm.	—	307.80
	TUMOURS			T408 75532	Partial mandibulectomy — greater than 3 cm.	—	461.80
T370 74108	Resection of benign soft tissue lesion, 1 cm. or under (incl. biopsy)	103.00	123.55	T409 75540	Total mandibulectomy	—	692.60
T371 74109	Resection of benign tumor of soft tissue, over 1 cm. in diameter	1.C.	150.80	T427 75551	Partial maxillectomy — up to 3 cm.	—	307.80
T372 74110	Excision of benign tumor of bone of maxilla or mandible, 1 to 3 cm.	—	131.70	T428 75552	Partial maxillectomy — greater than 3 cm.	461.80	692.60
T373 74118	Excision of benign tumor of bone of maxilla or mandible, greater than 3 cm.	—	224.20	T429 75560	Total maxillectomy	—	692.60
T374 74200	Excision of malignant tumour of soft tissue of the oral cavity or lip, under 3 cm.	—	131.70		FIXATION		
T375	Excision of malignant tumour of soft tissue of the oral cavity, greater than 3 cm.	—	224.20	T410 76100	Intermaxillary fixation	—	109.20
T376 74210	Excision of malignant tumour of bone of maxilla or mandible, under 3 cm.	—	131.70	T411 76110	Wiring of dentures of splint or arch bar	—	109.20
T377 74218	Excision of malignant tumour of bone of maxilla or mandible, greater than 3 cm.	—	224.20	T412 76120	Circumzygomatic wiring, unilateral	—	38.20
T378 74220	Cheiloplasty (lip shave)	—	315.95	T413 76130	Peralveolar or transpalatal wiring	—	38.20
				T414 76140	Nasal spine wiring	—	38.20
				T415 76150	Piriforme apertures suspension, each	—	38.20
				T416 76160	Circummandibular wiring, one ..	—	38.20
				T417 76170	Circummandibular wiring, two ..	—	76.40
				T418 76180	Circummandibular wiring, three and over	—	114.70

	Column 1	Col. 2	Col. 3		Column 1	Col. 2	Col. 3
T419 76191	Orbital suspension, bilateral	—	159.20		Repair of Complicated Laceration		
T420 76192	Extra skeletal suspension (e.g. Head Frame)	—	215.10		(local tissue shifts — scar revision) intraoral and extraoral		
T421 76195	Removal of wire (by different surgeon)	—	37.10	T520 76970	— up to 2.5 cm	—	54.60
T422 76196	Removal of arch splint (by a different surgeon)	—	73.20	T521 76971	— 2.6 cm to 5 cm	—	87.40
T423 76197	Removal of Interosseous or bone plate	—	124.50	T522 76972	— 5.1 cm to 10 cm	—	174.70
	FRACTURES				ORTHOGNATHIC SURGERY		
T424 76820	Open reduction LeFort III craniofacial dysfunction	—	665.00	T540 77100	Subcondylar closed osteotomy ...	—	773.40
	Mandible			T541 77120	Subcondylar open osteotomy	—	1,119.00
T430 76210	Closed reduction	208.90	261.10	T542 77130	Oblique osteotomy of ramus, extraoral	—	1,119.00
		-233.00	-291.10	T543 77140	Oblique osteotomy of ramus, intraoral	—	1,119.00
T431 76220	Open reduction, single	—	386.70	T544 77150	Body osteotomy or ostectomy ...	—	1,119.00
T432 76230	Open reduction, double	—	527.70	T545 77160	Coronoidectomy	—	478.40
T433 76240	Open reduction, multiple	—	809.80	T546 77170	Ostectomy of the condylar neck .	—	478.40
	Maxilla, horizontal			T547 77180	Sagittal split osteotomy, intraoral	—	1,119.40
T440 76310	Closed reduction	233.00	291.10	T548 77190	Sagittal split osteotomy, extraoral	—	1,119.00
T441 76320	Open reduction, single	—	386.70	T550 77210	Inverted L osteotomy	—	1,119.00
T442 76330	Open reduction, double	—	527.70	T551 77220	C osteotomy	—	1,119.00
T443 76340	Open reduction, multiple	—	809.80	T532 77300	LeFort I advancement — in one segment	—	1,119.00
	Maxillo-Malar pyramidal LeFort II			T022	— in two segments,add	—	254.00
T450 76410	Closed reduction	—	291.10	T023	— in three segments,add	—	508.80
T451 76420	Open reduction, unilateral	—	386.70	T534	LeFort I intrusion — in one segment	—	1,119.00
T452 76430	Open reduction, bilateral	—	809.80	T024	— in two segments,	—	254.00
	Naso-orbital			T025	— in three segments,add	—	508.80
T460 76510	Open reduction, external approach	—	432.20	T536	LeFort I extrusion — in one segment	—	1,185.60
T461 76520	Open reduction, sinus approach	—	327.60	T026	— in two segments,add	—	254.00
T462 76530	Open reduction, orbital approach, with insertion of subperiosteal implant	—	482.20	T027	— in three segments,add	—	508.80
	Malar bone			T538	LeFort I in cleft patient — in one segment	—	1,305.80
T470 76620	Open reduction	—	327.60	T028	— in two segmentsadd	—	219.10
	Zygomatic arch			T029	— in three segments,add	—	438.25
T480 76710	Intraoral approach	—	163.70	T030	— with SMR,add	—	175.30
T481 76720	Temporal approach	—	327.60	T031	— with pharyngoplasty, add	—	263.00
	Alveolus			T032	— with closure alveolar fistula with or without bone graft,	—	328.50
T490 76910	Fracture of alveolus including debridement and necessary extraction — stabilization of teeth	36.65	164.00	T033	— with closure hard palate fistula with or without bone graft,	—	438.25
		-274.20	-329.05	T554 77320	LeFort II osteotomy	—	1,264.60
T491 76940	Reimplantation of avulsed tooth (incl. root canal therapy and surgery)	136.65	164.00	T200 77330	LeFort III osteotomy	—	1,744.10
	LACERATIONS			T201	Pericranial flap to orbit or face — unilateral	—	263.00
T501 76950	Repair of uncomplicated laceration, intraoral or extraoral, 2 cm or less.	34.60	41.60	T202	— bilateral	—	350.60
T502 76951	2 - 12 cm	34.60	41.60		— when in conjunction with coronal approach for main operation		
T503 76955	Over 12 cm	—	105.45	T011	— unilateral	—	153.20
				T012	— bilateral	—	254.00
T504 76960	Repair of through and through laceration, 2 cm or less	—	79.70	T555 77400	Anterior segmental osteotomy of the maxilla, up to	—	998.40
T505 76961	Greater than 2 cm	—	177.10	T556 77410	Posterior segmental osteotomy of the maxilla, up to	—	1,119.00
				T557 77430	Midpalatal split, complete	—	585.90
				T558 77440	Anterior segmental osteotomy of the mandible, up to	—	998.40
				T559 77450	Anterior segmental osteotomy of mandible with transfer of mental eminence	—	1,119.00
				T560 77451	Anterior segmental osteotomy of mandible without transfer of mental eminence	—	1,119.00
				T561 77460	Posterior segmental osteotomy of the mandible	—	1,119.00
				T562 77461	Total dento-alveolar osteotomy of the mandible	—	1,119.00
				T563 77500	Sliding genioplasty	—	468.00

	Column 1	Col. 2	Col. 3		Column 1	Col. 2	Col. 3
T564 77520	Reduction genioplasty	—	468.00	T225 78600	Injection of joint with anti-inflammatory drug	—	74.25
T565 77530	Augmentation genioplasty with alloplastic material	—	468.00	T590 78100	Open reduction of dislocation ...	—	377.60
T566 77531	Augmentation genioplasty with bone graft	—	468.00	T591 78110	Closed reduction of dislocation, uncomplicated	34.30	41.20
T567 77550	Lower border osteotomy	—	558.50	T592 78120	Manipulation under anaesthesia .	—	81.90
T523 77630	Unilateral cleft lip repair	—	311.30	T593 78200	Meniscectomy	—	377.60
T524 77640	Reconstruction of cleft lip with a lip switch flap	—	380.95	T527 78230	Plication of the posterior attachment of the disc of the T.M.J.	—	776.80
T525 77645	Complex reconstruction or revision of a cleft lip	—	I.C.	T528 78410	Reconstruction of the glenoid fossa, zygomatic arch and temporal bone (Obwegesser technique)	—	1,201.00
T568 77700	Palatorrhaphy, anterior	—	I.C.	T594 78210	Capsulorrhaphy-sole procedure	—	377.60
T569 77710	Palatorrhaphy, posterior	—	I.C.	T595 78220	Myotomy of lateral pterygoid muscle	—	377.60
T570 77720	Palatorrhaphy, total	—	I.C.	T596 78300	Condylectomy	—	377.60
T571 77730	Palatorrhaphy, with bone graft ..	—	I.C.	T597 78310	Condylotomy	up to	377.60
T572 77740	Bone graft to anterior alveolar ridge	—	I.C.	T598 78320	Oblique osteotomy with alloplastic interposition for ankylosis	—	552.00
	FRENECTOMY/ GLOSSECTOMY/MYOTOMY			T599 78400	Arthroplasty of articular eminence	—	432.20
T580 77840	Lingual frenectomy or Z plasty ..	55.10	66.35		SALIVARY GLANDS		
T581 77850	Lingual frenectomy or Z plasty with myotomy of genioglossus ..	—	91.00	T760 79101	Dilation of Salivary Duct	—	74.25
T582 77860	Partial glossectomy, anterior wedge	—	163.70	T761 79102	Insertion of polyethylene tube in duct	—	74.25
T583 77870	Partial glossectomy, full postero anterior wedge	—	268.30	T601 79103	Sialodochoplasty	—	236.80
T204 77540	Suprahyoid myotomy	—	218.40	T602 79104	Sialolithotomy, anterior 1/3 of canal	73.70	88.50
	METAL IMPLANTS & ALLOPLASTIC RECONSTRUCTION			T603 79105	Sialolithotomy, posterior 2/3 of canal	—	143.70
T585 58217	Silastic chin implant	—	I.C.	T604 79106	Excision of submaxillary gland or sublingual gland	—	245.75
T586 58218	Chrome-cobalt mandibular mesh prosthesis	—	I.C.	T606 79109	Marsupialization of ranula	—	118.45
T587 58400	Temporo mandibular joint prosthesis	—	I.C.	T230 79113	Reconstruction of Salivary Duct	—	I.C.
T588 74302	Implantation of intraosseous prosthesis (not to incl. dental implants)	—	764.60		NEUROLOGICAL DISTURBANCES		
T589 74303	Removal of intraosseous prosthesis (not to incl. dental implants)	—	516.60	T610 79201	Injection of trigeminal nerve for destruction	—	76.20
T210	Bone graft to standard facial osteotomy unless otherwise included in the description of the surgery	—	208.00	T611 79202	Avulsion of trigeminal nerve at periphery	—	163.70
	Onlay bone grafts to face when not part of standard osteotomy for reconstruction*			T612 79203	Total avulsion of a branch of trigeminal nerve	—	336.60
T101	— mandible — unilateral	—	307.20	T613 79204	Transposition of mental nerve	up to	222.00
T102	— — bilateral	—	394.90	T614 79205	Decompression of inferior dental nerve in the canal	—	164.60
T105	— maxilla — unilateral	—	307.20	T615 79206	Microsuturing of injured nerve ..	—	159.00
T106	— — bilateral	—	394.90	T616 79220	Suturing of a major peripheral nerve — epineural	—	246.30
T109	— zygome — unilateral	—	263.00	T617 79230	Suturing of a major peripheral nerve — fascicular	—	369.40
T110	— — bilateral	—	350.60	T618 79240	Use of an operating microscope in suturing peripheral nerves ..	—	I.C.
T113	— temporal — unilateral	—	350.60		MAXILLARY SINUS		
T114	— — bilateral	—	438.25	T620 79301	Immediate recovery of a dental root or foreign body from antrum	—	113.80
T117	— frontal — unilateral	—	350.60	T621 79302	Immediate closure of opening of the antrum by another surgeon	—	91.00
T118	— — bilateral	—	438.25	T622 79303	Delayed recovery of root in antrum with oral antrostomy ..	—	168.40
	Application of dental arch bars, or splint, for facial osteotomy			T623 79304	Antrum lavage, oral approach ...	—	68.20
T121	— one arch bar	—	114.30	T624 79305	Antrum lavage, nasal approach .	—	68.20
T122	— two arch bars	—	175.30	T625 79306	Closure of oro-antral fistula sliding buccal flap	—	192.80
T215	Removal intermaxillary fixation devices under general anaesthesia — as sole procedure	—	87.25	T626 79307	Closure of oro-antral fistula, gold plate	—	192.80
	*Includes harvesting of bone or cartilage grafts.						
	TEMPORO MANDIBULAR JOINT DYSFUNCTION						
T220 78500	Arthrocentesis	—	74.25				

	Column 1	Col. 2	Col. 3
T627 79308	Closure of oro-antral fistula sliding palatal flap	—	192.80
T628 79309	Nasal antrostomy	—	80.10
BIOPSY, CYTOLOGY			
T660 04300	Biopsy of oral tissue — soft	59.00	70.70
T661 04310	Biopsy of oral tissue — hard, per 15 minutes	34.60	41.60
T662 04330	Cytological or bacteriological smear	19.65	21.50
T665 04315	Aspiration of oral tissue — soft ..	—	25.30
T667 04316	Aspiration of oral tissue — hard .	—	37.85
EMERGENCY PROCEDURES			
T630 79401	Control of dental secondary hemorrhage	20.00 -59.00	34.80 -70.70
T631 79603	Post-surgical care, minor, by other than treating dentist	13.00	15.70
T632 79604	Post-surgical care, major, by other than treating dentist	29.00	34.80
SURGICAL ASSISTANT			
T640 76198	Assisting at reduction of fractures for listed procedures	30% of	30% of
T641 77650	Assistant at orthognatic surgery for listed procedures		
T642 79999	Assisting at other listed procedures		
		the amount payable to the surgeon by the Plan for the procedure performed by surgeon	the amount payable to the surgeon by the Plan for the procedure performed by surgeon

sure is performed, the major procedure will be paid at the full fee and subsequent procedures performed at the same time will be paid at 85% of the listed fee, unless multiple procedures are identified by a specific code or specific add on services.

4. APPLICATION OF FIXATION DEVICES AND SPLINTS. The procedures and fees involving fractures and dislocations listed in the schedule of benefits include all intra-operative surgical aspects of that procedure and include the placement of arch bars, intermaxillary fixation and the wiring of dentures or splints.

5. CONSULTATIONS

- A. Dental consultations are benefits of the Plan when such consultations are requested by a physician or dental/oral surgeon in light of his or her professional knowledge of the patient.
- B. A hospital consultation fee is payable in addition to the listed dental procedure(s).
- C. A consultation report must be entered on the patient's chart.
- D. Consultation fees are payable for admitted bed patients and for patients in the Emergency or Out-patient Department when the dental/oral surgeon is requested to see the patient in consultation. Consultations are not insured services for patients seen in a private dental office, even if the office is located in a hospital.

6. SURGICAL ASSISTANT

Assistant's fees should only be claimed when the complexity of the procedure requires the assistance of a second qualified surgeon. Assistant's fees are not payable for procedures where an assistant is not normally required.

CONSULTATION IN HOSPITAL

Note: The consultation fee may be claimed as described in para. 5 of the Preamble to this Schedule.

T650 93100	Consultation in hospital	24.30 -48.70	29.20 -58.40
------------	--------------------------------	-----------------	-----------------

O. Reg. 212/87, s. 1, part.

Schedule 14

PREAMBLE

1. The surgical benefits include hospital visits rendered by the dental surgeon/oral surgeon, the in-hospital operative procedure, usual post-operative care rendered by the surgeon in hospital and one follow-up visit in the office.
2. **PREMIUMS:**

Non-elective Dental Surgical Procedures

When such procedures commence after 5:00 p.m. and before midnight or on Saturdays, Sundays and holidays the procedural fee is increased by 30% (T809).

When such procedures commence after midnight but before 7:00 a.m. on any night the procedural fee is increased by 50% (T810).

3. Multiple Operative Procedures: when more than one proce-

	Column 1	Col. 2	Col. 3
ROOT RESECTION AND APICAL CURETTAGE			
T701 34101	Apical curettage and/or root resection, one root, uncomplicated as a separate procedure	171.30	205.50
T702 34102	Apical curettage and/or root resection, one roots, complicated by anatomic and/or pathologic conditions as a separate procedure	205.00	246.00
T703 34103	Apical curettage and/or root resection, two roots, uncomplicated as a separate procedure	239.60	287.60
T704 34104	Apical curettage and/or root resection, three or more roots, uncomplicated as a separate procedure	274.20	329.05
T705 34111	Apical curettage and/or root resection, performed in conjunction with endodontic treatment, one root, uncomplicated	111.40	133.60
T706 34112	Apical curettage and/or root resection, performed in conjunction with endodontic treatment, one root, complicated by anatomic position	136.65	164.00

	Column 1	Col. 2	Col. 3
T707 34114	Apical curettage and/or root resection, performed in conjunction with endodontic treatment, two roots	171.30	205.50
T708 34115	Apical curettage and/or root resection, performed in conjunction with endodontic treatment, three or more roots	222.80	267.30
T709 34201	Amalgam and non-metallic compounds or silver points, one root, uncomplicated	205.00	246.00
T710 34202	Amalgam and non-metallic compounds or silver points, one root, complicated by anatomic and/or pathological conditions	274.20	329.05
T711 34212	Amalgam and non-metallic compounds or silver points, two roots	274.20	329.05
T712 34213	Amalgam and non-metallic compounds or silver points, three roots	325.70	390.80

Note: Services listed under codes T709, T710, T711, T712, include root-end filling, apical curettage and root resection.

O. Reg. 212/87, s. 1, part.

Schedule 15

PREAMBLE

1. The surgical benefits include hospital visits rendered by the dental surgeon/oral surgeon, the in-hospital operative procedure, usual post-operative care rendered by the surgeon in hospital and one follow-up visit in the office.

2. **PREMIUMS:**

Non-elective Dental Surgical Procedures

When such procedures commence after 5:00 p.m. and before midnight or on Saturdays, Sundays and holidays the procedural fee is increased by 30% (T809).

When such procedures commence after midnight but before 7:00 a.m. on any night the procedural fee is increased by 50% (T810).

3. Multiple Operative Procedures: when more than one procedure is performed, the major procedure will be paid at the full fee and subsequent procedures performed at the same time will be paid at 85% of the listed fee, unless multiple procedures are identified by a specific code or specific add on services.

4. **APPLICATION OF FIXATION DEVICES AND SPLINTS.** The procedures and fees involving fractures and dislocations listed in the schedule of benefits include all intra-operative surgical aspects of that procedure and include the placement of arch bars, intermaxillary fixation and the wiring of dentures or splints.

5. **CONSULTATIONS**

A. Dental consultations are benefits of the Plan when such consultations are requested by a physician or dental/oral surgeon in light of his or her professional knowledge of the patient.

B. A hospital consultation fee is payable in addition to the listed dental procedure(s).

C. A consultation report must be entered on the patient's chart.

D. Consultation fees are payable for admitted bed patients and for patients in the Emergency or Out-patient Department when the dental/oral surgeon is requested to see the patient in consultation. Consultations are not insured services for patients seen in a private dental office, even if the office is located in a hospital.

6. **SURGICAL ASSISTANT**

Assistant's fees should only be claimed when the complexity of the procedure requires the assistance of a second qualified surgeon. Assistant's fees are not payable for procedures where an assistant is not normally required.

	Column 1	Col. 2	Col. 3
ODONTECTOMIES			
T901 71101	Removal of single erupted tooth (bone contouring included)	29.00	34.80
T902 71111	Removal of each additional erupted tooth in the same quadrant, add	15.00	18.00
T903 72100	Removal of each erupted tooth, complicated	68.30	81.95
T904 72210	Removal of each tooth covered by soft tissue	68.30	81.95
T905 72220	Removal of each impacted tooth, partial bony impaction	103.00	123.55
T906 72230	Removal of each impacted tooth, complete bony impaction	136.65	164.00
T907 72240	Removal of each impacted tooth, unusual position, age factor (incl. super-numerary)	156.40	187.60
T908 72310	Removal of residual roots, soft tissue coverage	59.00	70.70
T909 72320	Removal of residual roots, bony tissue coverage	68.30	81.95

Note:

1. The above listed surgical services include necessary suturing.
2. An impacted tooth is one which is prevented from its normal path or eruption by hard tissue (tooth or bone).

T910 72410	Surgical exposure of each unerupted tooth, uncomplicated, soft tissue coverage	29.00	34.80
T911 72411	Surgical exposure of each unerupted tooth, complex, hard tissue coverage.	103.00	123.55
T912 72412	Surgical exposure of each unerupted tooth, including orthodontic attachment	103.00	123.55
		-205.00	-246.00

FRENECTOMY

T925 77800	Maxillary labial frenectomy	55.30	66.35
T926 77810	Mandibular labial frenectomy	55.30	66.35
T927 77820	Maxillary Z frenoplasty	55.30	66.35
T928 77830	Mandibular Z frenoplasty	55.30	66.35

ADVEOLOPLASTY

T936 73110	Alveoloplasty, independent of tooth extraction, per quadrant	34.60	41.60
------------	--	-------	-------

Note: service involves incising and reflecting a flap, bone contouring and suturing.

Column 1	Col. 2	Col. 3	Code		
CYSTS					
T950 74412	Excision of cyst, in conjunction with tooth removal	— bill at 75% of T390, T391 or T392 unless complicated (excision of tooth is billed at 100% of usual fee).	J834/J634 J835/J635 J880/J680 J836/J636 J837/J637 J838/J638 J839/J639 J840/J640	Genitourinary System Dynamic renal imaging Computer assessed renal function (includes first transit) — repeat after pharmacological intervention Static renal scintigraphy ERPF by blood sample method GFR by blood sample method Cystography for vesicoureteric reflux Testicular and scrotal scintigraphy (includes first transit)	91.65 125.50 43.00 30.50 38.20 38.20 114.80 78.50
Schedule 16					
Schedule of Benefits for out of province services					
NUCLEAR MEDICINE — IN VIVO					
Cardiovascular System					
J802/J602	Venography — peripheral and superior vena cava	91.70	J841/J641 J843/J643 J847/J647 J848/J648 J849/J649	Plasma volume Red cell volume Ferrokinetics — clearance, turnover, and utilization Red cell, white cell or platelet survival	41.45 45.80 381.90 98.20
J804/J604	First transit without blood pool images	15.30	J881/J681	Red cell survival with serial surface counts ..	141.90
J867/J667	First transit with blood pool images	54.60	J882/J682	Bone marrow scintigraphy — whole body ..	109.10
J806/J606	Cardioangiography — first pass for shunt detection, cardiac output and transit studies	90.60	J883/J683	— single site	80.80
J807/J607	Myocardial perfusion scintigraphy — immediate post stress, resting	207.30	J884/J684	In-111 leukocyte scintigraphy — whole body	347.00
J808/J608	— delayed	76.40	J850/J650	— single site	305.60
J810/J610	Myocardial scintigraphy — acute infarction, injury	84.00	J851/J651	Musculoskeletal System Bone scintigraphy — general survey	98.80
J811/J611	Myocardial wall motion studies	90.60	J852/J652	— single site	80.80
J812/J612	— repeat same day (maximum of three repeats)	45.80	J853/J653	Gallium scintigraphy — general survey	169.20
J813/J613	Myocardial wall motion studies with ejection fraction	128.80	J854/J654	— single site	117.85
J814/J614	— repeat same day (maximum of three repeats)	45.80	J855/J655	Bone mineral density by single photon method	29.50
J815/J615	Detection of venous thrombosis using radioiodinated fibrinogen up to ten days ..	125.50	J856/J656	Total body calcium — neutron activation ...	185.50
Endocrine System					
J816/J616	Adrenal scintigraphy with idiocholesterol ...	367.75	J857/J657	Bone mineral content by dual photon absorptiometry — single site	111.90
J868/J668	— with idiocholesterol and dexamethasone suppression	431.05	J885/J685	— two or more sites	146.40
J869/J669	— with MIBG	529.05	J886/J686	Nervous System CSF circulation — with Tc99m or I-131	
J817/J617	Thyroid uptake	27.30	J858/J658	HSA	114.60
J870/J670	— repeat	14.20	J887/J687	— with In-111	294.60
J818/J618	Thyroid scintigraphy with Tc99m or I-131 ..	61.10	J860/J660	— via shunt puncture	85.05
J871/J671	— with I-123	98.20		Brain scintigraphy	86.20
J820/J620	Parathyroid scintigraphy — dual isotope technique with Tl201 and Tc99m Iodine ..	224.80		Respiratory System Perfusion long scintigraphy	81.80
J872/J672	Metastatic survey with I-131	229.10		Ventilation lung scintigraphy	102.60
Gastrointestinal System					
J821/J621	Schilling test — single isotope	42.60		Perfusion and ventilation scintigraphy — same day	163.70
J823/J623	— dual isotope	45.80	J861/J661	Miscellaneous Radionuclide lymphangiogram	106.90
J824/J624	Malabsorption test with C14 substrate	54.60	J862/J662	Ocular tumour localization	72.00
J873/J673	— with whole body counting	131.00	J864/J664	Tear duct scintigraphy	92.80
J825/J625	Gastrointestinal protein loss	78.50	J865/J665	Total body counting	179.00
J874/J674	Gastrointestinal blood loss — Cr51	58.90	J866/J666	Tomography (SPECT)	41.45
J826/J626	Calcium absorption — Ca45	58.90		DIAGNOSTIC RADIOLOGY	
J875/J675	Calcium47 absorption/excretion	241.15		Head and Neck	
J827/J627	Esophageal motility studies — one or more ..	114.60	X001	Skull — four views	30.65
J829/J629	Gastrointestinal transit	98.20	X009	— five or more views	38.20
J876/J676	Gastrointestinal reflux	54.60	X003	Sella turcica (when skull not examined)	15.30
J877/J677	Gastroesophageal aspiration	38.20	X004	Facial bones — minimum of three views	22.20
J830/J630	Abdominal scintigraphy for gastrointestinal bleed — Tc99m sulphur colloid or Tc04 ..	82.90	X005	Nose — minimum of two views	15.30
J878/J678	— labelled RBCs	136.40	X006	Mandible — minimum of three views (uni or bilateral)	22.20
J879/J679	— Le Veen shunt patency	63.25	X012	— four or more views	30.65
J831/J631	Biliary scintigraphy	109.10	X007	Temporomandibular joints — minimum of four views including open and closed mouth views	22.20
J832/J632	Liver/spleen scintigraphy	76.30	X008	Sinuses — minimum of three views	22.20
J833/J633	Salivary gland scintigraphy	91.65			

Code		Code	
X010	Mastoids — bilateral — minimum of six views 29.40	X066	Tibia and fibula (including one joint) — two views 15.30
X011	Internal auditory meati (when skull not examined) 22.20	X226	— three or more views 23.50
X016	Eye, for foreign body 15.20	X067	Ankle — two or three views 15.30
X017	Eye, for localization, additional 15.60	X227	— four or more views 23.50
X018	Optic foramina 17.20	X068	Calcaneus — two views 15.30
X019	Salivary gland region 14.10	X228	— three or more views 23.50
X020	Neck for soft tissues — minimum of two views 14.10	X069	Foot — two or three views 15.30
		X229	— four or more views 23.50
		X072	Toe — two views 11.80
		X230	— three or more views 15.30
		X064	Leg length studies (orthoroentgenogram) 22.20
	Spine and Pelvis		
X025	Cervical spine — two or three views 26.50		
X202	— four or five views 34.20		
X203	— six or more views 41.40	X057	Skeletal survey for bone age — single film ... 15.30
X027	Thoracic spine — two views 24.30	X058	— two or more films or views 22.40
X204	— three or more views 31.90	X080	Other survey studies — e.g., rheumatoid, metabolic or metastatic — basic 7.60
X028	Lumbar or lumbrosacral spine — two or three views 26.50	X081	— plus per film or view 7.60
X205	— four or five views 34.20		
X206	— six or more views 41.50		
X032	Entire spine — (scoliosis series) minimum of four views 54.95	X090	Chest
X033	— Orthoroentgenogram (3 foot film) — single view 22.20	X091	Single film 15.30
X031	— two or more views 30.60	X092	Two views 22.50
X034	Sacrum and/or coccyx — two views 25.60	X039	Three or more views 28.90
X207	— three or more views 31.90	X040	Ribs — two or more views 18.30
X035	Sacro-iliac joints — two or three views 22.20	X096	Sternum — two or more views 18.30
X208	— four or more views 29.70		
X036	Pelvis and/or hip(s) — one view 15.30	X100	Thoracic inlet — two or more views 15.30
X037	— two views (e.g. A.P. and frog view, both hips; or A.P. both hips plus lateral one hip) 28.50	X101	
X038	— three or more views (e.g. pelvis and sacro-iliac joints, or A.P. both hips plus lateral each hip) 32.70		
	Upper Extremities		
X045	Clavicle — two views 15.30	X105	G.I. Tract
X209	— three or more views 23.50	X106	Palatopharyngeal analysis (cine or videotape) 30.20
X046	Acromioclavicular joints (bilateral) with or without weighted distraction — two views 22.20	X107	Pharynx and oesophagus (cine or videotape) 30.20
X210	— three or more views 30.40	X107	Oesophagus — when X103, X104, X108 or X109 not billed 27.40
X047	Sternoclavicular joints — (bilateral) — two or three views 18.30	X108	Oesophagus, stomach and duodenum — including survey film if taken 47.50
X211	— four or more views 26.40	X104	Oesophagus, stomach and duodenum — double contrast, including survey film, if taken 49.40
X048	Shoulder — two views 18.30	X103	Oesophagus, stomach and duodenum — double contrast, including survey film, if taken, and small bowel 62.50
X212	— three or more views 26.40	X109	Oesophagus, stomach and small bowel 60.55
X049	Scapula — two views 18.30	X110	Hypotonic duodenogram 40.40
X213	— three or more views 26.40	X111	Small bowel only — when only examination performed during patient's visit 27.40
X050	Humerus — including one joint — two views 15.30	X112	Colon — barium enema (including survey film, if taken) 49.50
X214	— three or more views 23.50	X113	Colon — air contrast, primary or secondary, including survey films, if taken 62.60
X051	Elbow — two views 15.30	X114	Gallbladder (one or multiple day examinations) 30.65
X215	— three or four views 23.50	X120	Gallbladder (one or multiple day examinations with preliminary plain film) . 40.80
X216	— five or more views 31.60	X116	T-tube cholangiogram 22.20
X052	Forearm — including one joint — two views 15.30	X117	Operative cholangiogram 22.20
X217	— three or more views 23.50	X118	Intravenous cholangiogram 50.70
X053	Wrist — two or three views 15.30	X123	Operative pancreatogram or E.R.C.P. 22.20
X218	— four or more views 23.50		
X054	Hand — two or three views 15.30		
X219	— four or more views 23.50		
X055	Wrist and hand — two or three views 22.20		
X220	— four or more views 28.35		
X056	Finger or thumb — two views 11.80	X129	G.U. Tract
X221	— three or more views 15.30	X129	Retrograde pyelogram, unilateral or bilateral 22.20
	Lower Extremities	X130	Intravenous pyelogram including preliminary film 50.80
X060	Hip — (unilateral) — two or more views 24.30	X137	Cystogram (catheter) 24.40
X063	Femur, including one joint — two views 15.30	X135	Cystourethrogram, stress or voiding (catheter) 28.30
X223	— three or more views 23.50	X131	Cystourethrogram (non-catheter) 5.95
X065	Knee (including patella) — two views 15.30	X191	Intestinal conduit examination or nephrostogram 22.20
X224	— three or four views 23.50		
X225	— five or more views 31.60		

Code			Code		
J196	Ankle pressure measurements with exercise and/or quantitative measurements added to the above	7.80	E450	J315 plus J301 or J304 before and/or after exercise, add	13.10
J197	Penile pressure recordings — two or more pressures	6.75	E451	J315 plus 12 lead E.C.G. done at rest, used for monitoring during the exercise and followed for at least 5 minutes post exercise, add	17.90
J203	Transcutaneous tissue oxygen tension measurements	23.50	J316	Stage II: Repeated steady state graded exercise (must include heart rate, ventilation, VO ₂ , VCO ₂ , BP, ECG, end tidal and mixed venous CO ₂ at rest, 3 levels of exercise and recovery)	88.95
J204	— when done in addition to Doppler studies	12.90	J317	Stage III: J316 plus arterial blood gases, pH and bicarbonate or lactate	171.50
Miscellaneous					
J180	Echography for placement of radiation therapy fields, scan B-mode	34.30	J330	Assessment of exercise induced asthma (workload sufficient to achieve heart rate 85% of predicted maximum; performance of J301 or J304 before exercise and 5-10 minutes post exercise)	32.90
J182	Extremities — per limb (excluding vascular study)	23.10	J319	Blood gas analysis: pH, PO ₂ , PCO ₂ , bicarbonate and base excess	11.10
J127	Breast — scan B-mode (per breast)	23.10	J318	Arterialized venous blood sample collection (e.g. ear lobe)	3.70
J183	Scrotal — scan	46.20	J320	A-a oxygen gradient requiring measurement of RQ by sampling mixed expired gas and using alveolar air equation	27.20
J149	Ultrasonic guidance of biopsy, aspiration, amniocentesis or drainage procedures (one physician only)	46.20	J331	Estimate of shunt (Qs/Qt) breathing pure oxygen	27.20
PULMONARY FUNCTION STUDIES					
Code			J313	Mixed venous PCO ₂ , by the rebreathing method	11.10
J311	Functional residual capacity by gas dilution method	16.00	J323	O ₂ saturation by oximetry at rest, with or without O ₂	4.20
J307	Functional residual capacity by body plethysmography	17.30	J332	Oxygen saturation by oximetry at rest and exercise, or during sleep with or without O ₂	17.40
J305	Lung compliance (pressure volume curve of the lung from TLC to FRC)	51.30	J334	J332 with at least two levels of supplemental O ₂	30.25
J306	Airways resistance by plethysmography or estimated using esophageal catheter	15.90	J322	Standard O ₂ consumption and CO ₂ production	5.20
J340	Maximum inspiratory and expiratory pressures	2.70	J333	Non-specific bronchial provocative test (histamine, methylcholine, thermal challenge)	47.65
J309	Carbon monoxide diffusing capacity by steady state at rest	10.60	J335	Antigen challenge test	51.20
J310	Carbon monoxide diffusing capacity by single breath method	21.20	J341	Trans diaphragmatic pressure measurement	51.30
J308	Carbon dioxide ventilatory response	19.70			
J328	Oxygen ventilatory response (physician must be present)	19.70			
J315	Stage I: Graded exercise to maximum tolerance (exercise must include continuous heart rate, oximetry and ventilation at rest and at each workload) ...	61.70			

O. Reg. 156/90, s. 7.

Form 1

Health Insurance Act



Ministry of Health Ontario

Application for Type 1, 2 or 3 Care (EXTENDED CARE INSURED SERVICE)

Please print or type

SECTION A

Form section A containing personal information, health number, present location, permanent address, and telephone number.

SECTION B

Form section B containing a grid for staff assistance in daily activities (Eating, Dressing, Grooming, Bathing, Skin Care, Bladder Control, Bowel Control, Transfer/Positioning, Locomotion/Ambulation, Orientation, Communication, Socio-emotional Support, Medication) and physician information.

Applicant's Surname	Given Name
---------------------	------------

SECTION E

Medical Assessment *(This section to be completed by physician. Please attach additional information if necessary)*
Medical Assessment

1. Brief Medical/Surgical History:

2. Describe Patient's Present Clinical Condition:

3. Note any Drug Sensitivities or Allergies:

Diagnoses List the diagnoses below in order of severity. For each diagnosis check the appropriate boxes under the headings to the right.	Duration			Present Status of Disease			Three Month Prognosis			Purpose of Care			Rehabilitation Potential					
	Weeks	Months	Years	Stable	Under Clinical Control	Progressive	Unstable	No Change	Improvement	Deterioration	Probably Fatal	Rehabilitation	Clinical Control	Maintenance	Palliative	Good	Moderate	Limited

Accommodation

Type of Care Required: Type 1 (Residential) Type 2 (Extended) Type 3 (Chronic)

Proposed Placement: Home for the Aged Nursing Home Chronic Unit or Chronic Hospital

Accommodation Requested: Ward Semi-Private Private

Estimated Duration of Stay Weeks Months Indeterminate

Family Physician (please print)

Name	Address
------	---------

Attending Physician (please print)

Name	Address
------	---------

I certify that the medical assessment is correct to the best of my professional knowledge.

Signature of Physician
Date

Form 2

Health Insurance Act

LABORATORY SERVICES REQUISITION AND HEALTH INSURANCE CLAIM

LABORATORY REQUISITION Requisitioning Physician			Laboratory Number			Laboratory Name and Address							
			Total Fee										
			Physician's Number			Physician's Accounting Number			Laboratory Accounting Number				
Additional Clinical Information			Health Number			Version	YY	MM	DD	Ref. Lab.	Payment Program		
			Provincia		Other Registration Number					Patient's Phone Number			
			Patient's Last Name						Patient's First Name			Sex	
			Address										
<input checked="" type="checkbox"/>	Biochemistry		LAB CODE	FEE CODE	<input checked="" type="checkbox"/>	Hematology		LAB CODE	FEE CODE	Other test, one per line (please type or print and use terminology of the Schedule of Benefits)			
	Glucose					Blood Film Exam							LAB CODE
	Urea					Hemoglobin							
	Creatinine					W.B.C. count							
	Uric Acid					Prothromb. time							
	Sodium					Sediment rate							
	Potassium					Hematocrit							
	Chloride					Immunology							
	Cholesterol					Heterophile antibodies screen							
	Triglyceride					Rubella titre							
	SGOT					Pregnancy test							
	Alk. Phosphatase					Prenatal ABO, RhD, antibody screen (titre and ident. if positive)							
	Bilirubin					Repeat Prenatal antibodies							
	T.3 Uptake					VDRL							
	T.4 Total												
	Urinalysis RM					Microbiology							
	"I certify the tests ordered are not for registered in or out patients of a hospital". X _____ PHYSICIAN'S SIGNATURE DATE		Sensitivities if warranted										
			Cervical, vaginal										
			Sputum										
			Throat										
			Urine										
			Stool culture										
			other swabs										

1. Laboratory Copy

CONFIDENTIAL WHEN COMPLETED

2. Physician's Copy

300-84 (03-91) 7530-458 1

Health Protection and Promotion Act
Loi sur la protection et la promotion de la santé

REGULATION 553

AREAS COMPRISING HEALTH UNITS

1. Each of the areas in the following Schedules is designated as a health unit and the name at the heading of the Schedule is prescribed to be the name of the health unit:

Schedule 1

THE DISTRICT OF ALGOMA HEALTH UNIT

1. All municipalities, geographic townships and other lands in the Territorial District of Algoma, except the Township of Hornepayne and the following geographic townships:

- | | |
|--------------|----------------|
| 1. Abbott | 20. Haig |
| 2. Alderson | 21. Hiawatha |
| 3. Arnott | 22. Larkin |
| 4. Bourinot | 23. Lascelles |
| 5. Chelsea | 24. Lessard |
| 6. Cholette | 25. McEwing |
| 7. Cross | 26. McFarlan |
| 8. Doherty | 27. Mercer |
| 9. Downer | 28. Nagagami |
| 10. Dowsley | 29. Newlands |
| 11. Drew | 30. Opasatika |
| 12. Ebbs | 31. Pelletier |
| 13. Elgie | 32. Roche |
| 14. Farquhar | 33. Shanly |
| 15. Flanders | 34. Scholfield |
| 16. Foch | 35. Talbott |
| 17. Frances | 36. Templeton |
| 18. Franz | 37. Woolrich |
| 19. Frost | |

O. Reg. 236/84, s. 1, *part, revised.*

Schedule 2

BRANT COUNTY HEALTH UNIT

1. The County of Brant. O. Reg. 236/84, s. 1, *part.*

Schedule 3

BRUCE-GREY-OWEN SOUND HEALTH UNIT

1. The counties of Bruce and Grey. O. Reg. 327/89, s. 1 (1).

Schedule 4

DURHAM REGIONAL HEALTH UNIT

1. The Regional Municipality of Durham. O. Reg. 236/84, s. 1, *part.*

Schedule 5

THE EASTERN ONTARIO HEALTH UNIT

1. The counties of Dundas, Glengarry, Prescott, Russell and Stormont. O. Reg. 236/84, s. 1, *part.*

Schedule 6

BOROUGH OF EAST YORK HEALTH UNIT

1. The Borough of East York. O. Reg. 236/84, s. 1, *part.*

Schedule 7

ELGIN—ST. THOMAS HEALTH UNIT

1. The County of Elgin. O. Reg. 236/84, s. 1, *part.*

Schedule 8

CITY OF ETOBICOKE HEALTH UNIT

1. The City of Etobicoke. O. Reg. 236/84, s. 1, *part.*

Schedule 9

HALDIMAND-NORFOLK REGIONAL HEALTH UNIT

1. The Regional Municipality of Haldimand-Norfolk. O. Reg. 236/84, s. 1, *part.*

Schedule 10

HALIBURTON, KAWARTHA, PINE RIDGE DISTRICT HEALTH UNIT

1. All the municipalities in the County of Haliburton, the County of Northumberland and the County of Victoria. O. Reg. 236/84, s. 1, *part.*

Schedule 11

HALTON REGIONAL HEALTH UNIT

1. The Regional Municipality of Halton. O. Reg. 236/84, s. 1, *part.*

Schedule 12

HAMILTON-WENTWORTH REGIONAL HEALTH UNIT

1. The Regional Municipality of Hamilton-Wentworth. O. Reg. 236/84, s. 1, *part.*

Schedule 13

HASTINGS AND PRINCE EDWARD COUNTIES HEALTH UNIT

1. The counties of Hastings and Prince Edward. O. Reg. 236/84, s. 1, *part.*

Schedule 14

HURON COUNTY HEALTH UNIT

1. The County of Huron. O. Reg. 236/84, s. 1, *part.*

Schedule 15

KENT—CHATHAM HEALTH UNIT

1. The County of Kent. O. Reg. 236/84, s. 1, *part.*

Schedule 16**WATERLOO HEALTH UNIT**

1. The Regional Municipality of Waterloo. O. Reg. 236/84, s. 1, *part*.

Schedule 17**KINGSTON, FRONTENAC AND LENNOX AND
ADDINGTON HEALTH UNIT**

1. The counties of Frontenac and Lennox and Addington. O. Reg. 236/84, s. 1, *part*.

Schedule 18**SARNIA—LAMBTON HEALTH UNIT**

1. The County of Lambton. O. Reg. 236/84, s. 1,

Schedule 19**LEEDS, GRENVILLE AND LANARK DISTRICT
HEALTH UNIT**

1. The counties of Lanark, Leeds and Grenville. O. Reg. 236/84, s. 1, *part*.

Schedule 20**MIDDLESEX—LONDON HEALTH UNIT**

1. The County of Middlesex. O. Reg. 236/84, s. 1, *part*; O. Reg. 239/87, s. 1.

Schedule 21**MUSKOKA—PARRY SOUND HEALTH UNIT**

1. All the municipalities in the District Municipality of Muskoka.
2. All municipalities, geographic townships and other lands in the Territorial District of Parry Sound except the Village of South River, the towns of Powassan and Trout Creek, and the townships of North Himsforth, South Himsforth, Machar and Nipissing, and the following geographic townships:

- | | |
|-------------|---------------|
| 1. Gurd | 6. East Mills |
| 2. Hardy | 7. Patterson |
| 3. Laurier | 8. Pringle |
| 4. Lount | 9. Wilson |
| 5. McConkey | |

O. Reg. 236/84, s. 1, *part*.

Schedule 22**NIAGARA REGIONAL AREA HEALTH UNIT**

1. The Regional Municipality of Niagara. O. Reg. 236/84, s. 1, *part*.

Schedule 23**NORTH BAY AND DISTRICT HEALTH UNIT**

1. All municipalities, geographic townships and other lands in the Territorial District of Nipissing except:

1. The townships of Airy and Temagami.
2. The following geographic townships:

- | | |
|---------------|--------------------|
| i. Askin | xvi. Latchford |
| ii. Aston | xvii. Law |
| iii. Banting | xviii. Le Roche |
| iv. Belfast | xix. Lyell |
| v. Bertram | xx. Milne |
| vi. Best | xxi. Murchison |
| vii. Briggs | xxii. Olive |
| viii. Canton | xxiii. Paxton |
| ix. Cassels | xxiv. Phyllis |
| x. Chambers | xxv. Riddell |
| xi. Clement | xxvi. Sabine |
| xii. Cynthia | xxvii. Scholes |
| xiii. Dickens | xxviii. Torrington |
| xiv. Falconer | xxix. Vogt |
| xv. Joan | xxx. Yates |

3. The geographic townships or parts thereof in Algonquin Park except the geographic township of Pentland.

2. The following municipalities in the Territorial District of Parry Sound:

1. The Village of South River.
2. The towns of Powassan and Trout Creek.
3. The townships of North Himsforth, South Himsforth, Machar and Nipissing.

3. The following geographic townships in the Territorial District of Parry Sound:

- | | |
|-------------|---------------|
| 1. Gurd | 6. East Mills |
| 2. Hardy | 7. Patterson |
| 3. Laurier | 8. Pringle |
| 4. Lount | 9. Wilson |
| 5. McConkey | |

O. Reg. 236/84, s. 1, *part*.

Schedule 24**NORTHWESTERN HEALTH UNIT**

1. All municipalities, geographic townships and other lands in the Territorial District of Rainy River and those parts of the territorial districts of Kenora and Thunder Bay described as follows:

Beginning at the southeast corner of the Territorial District of Kenora; thence northerly along the boundary between the territorial districts of Kenora and Thunder Bay to the intersection with the parallel of latitude 50° 00'; thence easterly along that parallel of latitude to the intersection with a meridian line surveyed by K. G. Ross, Ontario Land Surveyor, in 1921; thence northerly along that meridian line to the southeast corner of the geographic Township of Bertrand; thence continuing northerly along the east boundary of the geographic townships of Bertrand, McLaurin, Furlonge, Fletcher and Bulmer to the northeast corner of the said Township of Bulmer; thence continuing northerly along a meridian line surveyed by Phillips and Benner, Ontario Land Surveyors, in 1923, to the northerly boundary of the Territorial District of Thunder Bay; thence northeasterly along that boundary to the intersection with line of longitude 89° 30'; thence north astronomically along that line of longitude to the intersection with the parallel of latitude 52° 30'; thence westerly along that parallel of latitude to the intersection with a meridian line surveyed by A. Tarvydas, Ontario Land Surveyor, in 1957; thence northerly along that meridian line to the 215 + 78.207 Mile Post planted thereon; thence north astronomically to the Interprovincial Boundary between Ontario and Manitoba; thence southwesterly and southerly along that Interprovincial Boundary to the International Boundary between Canada and the United States of America; thence southeasterly along that International Boundary to the southerly boundary of the Territorial District of Kenora; thence easterly along that boundary to the place of beginning. O. Reg. 236/84, s. 1, *part*.

Schedule 25**NORTH YORK HEALTH UNIT**

1. The City of North York. O. Reg. 236/84, s. 1, *part.*

Schedule 26**OTTAWA-CARLETON REGIONAL HEALTH UNIT**

1. The Regional Municipality of Ottawa-Carleton. O. Reg. 236/84, s. 1, *part.*

Schedule 27**OXFORD COUNTY HEALTH UNIT**

1. The County of Oxford. O. Reg. 236/84, s. 1, *part.*

Schedule 28**PEEL REGIONAL HEALTH UNIT**

1. The Regional Municipality of Peel. O. Reg. 236/84, s. 1, *part.*

Schedule 29**PERTH DISTRICT HEALTH UNIT**

1. The County of Perth. O. Reg. 236/84, s. 1, *part.*

Schedule 30**PETERBOROUGH COUNTY—CITY HEALTH UNIT**

1. The County of Peterborough. O. Reg. 236/84, s. 1, *part.*

Schedule 31**PORCUPINE HEALTH UNIT**

1. Those parts of the territorial districts of Cochrane and Kenora, described as follows, except the geographic townships of Ben Nevis, Bisley, Clifford and Pontiac:

Beginning at the southeast corner of the geographic Township of Pontiac being also a point on the Interprovincial Boundary between Ontario and Quebec; thence westerly along the boundary between the territorial districts of Cochrane and Timiskaming to the southwest corner of the geographic Township of Keefer; thence northerly and westerly along the boundary between the territorial districts of Cochrane and Sudbury to the southwest corner of the geographic Township of Ossin; thence northerly, westerly, northerly, westerly, northerly and westerly along the boundary between the territorial districts of Cochrane and Algoma to the southwest corner of the geographic Township of Clavet; thence northerly, westerly and northerly along the boundary between the territorial districts of Cochrane and Thunder Bay to the southerly boundary of the Territorial District of Kenora; thence continuing northerly along a meridian line to the 212 Mile Post planted thereon by A. Tarvydas, Ontario Land Surveyor, in 1958; thence north astronomically to the intersection with the parallel of latitude 55° 00'; thence westerly along the 55th parallel of latitude to the intersection with the line of longitude 87° 00'; thence north astronomically along that line of longitude to the shore of Hudson Bay; thence southeasterly, southerly, southeasterly and northeasterly along the shore of Hudson Bay and James Bay to the Interprovincial Boundary between Ontario and Quebec; thence southerly along that Interprovincial Boundary to the place of beginning.

2. The Township of Hornepayne and the following geographic townships in the Territorial District of Algoma:

- | | |
|--------------|----------------|
| 1. Abbott | 20. Haig |
| 2. Alderson | 21. Hiawatha |
| 3. Arnott | 22. Larkin |
| 4. Bourinot | 23. Lascelles |
| 5. Chelsea | 24. Lessard |
| 6. Cholette | 25. McEwing |
| 7. Cross | 26. McFarlan |
| 8. Doherty | 27. Mercer |
| 9. Downer | 28. Nagagami |
| 10. Dowsley | 29. Newlands |
| 11. Drew | 30. Opatatika |
| 12. Ebbs | 31. Pelletier |
| 13. Elgie | 32. Roche |
| 14. Farquhar | 33. Shanly |
| 15. Flanders | 34. Scholfield |
| 16. Foch | 35. Talbott |
| 17. Frances | 36. Templeton |
| 18. Franz | 37. Woolrich |
| 19. Frost | |

3. The following geographic townships in the Territorial District of Timiskaming:

- | | |
|----------------|--------------|
| 1. Bartlett | 7. Hillary |
| 2. Childerhose | 8. McArthur |
| 3. Douglas | 9. McKeown |
| 4. Doyle | 10. Musgrove |
| 5. Fripp | 11. Pharand |
| 6. Geikie | 12. Reynolds |

O. Reg. 236/84, s. 1, *part, revised.*

Schedule 32**RENFREW COUNTY AND DISTRICT HEALTH UNIT**

1. All the municipalities in the County of Renfrew.
2. The Township of Airy in the Territorial District of Nipissing.
3. The following geographic townships in the Territorial District of Nipissing:

- | | |
|---------|-----------|
| Dickens | Murchison |
| Lyell | Paxton |
| | Sabine |

4. All the geographic townships or parts thereof in Algonquin Park except the geographic township of Pentland. O. Reg. 236/84, s. 1, *part.*

Schedule 33**CITY OF SCARBOROUGH HEALTH UNIT**

1. The City of Scarborough. O. Reg. 236/84, s. 1, *part.*

Schedule 34**SIMCOE COUNTY DISTRICT HEALTH UNIT**

1. The County of Simcoe. O. Reg. 236/84, s. 1, *part.*

Schedule 35**SUDBURY AND DISTRICT HEALTH UNIT**

1. All the municipalities and geographic townships in the Territorial District of Sudbury.
2. All municipalities, geographic townships and other lands in the Territorial District of Manitoulin.
3. The geographic townships of Bertram, Falconer and Latchford, in the Territorial District of Nipissing. O. Reg. 236/84, s. 1, *part.*

Schedule 36**CITY OF TORONTO HEALTH UNIT**

1. The City of Toronto. O. Reg. 236/84, s. 1, *part.*

Schedule 37**THUNDER BAY DISTRICT HEALTH UNIT**

1. Those parts of the territorial districts of Thunder Bay and Kenora described as follows:

Beginning at the intersection of the line of longitude of 87° 00' with the parallel of latitude of 55° 00'; thence easterly along that parallel of latitude to the intersection with a line drawn on a course of north astronomically from the 212 Mile Post planted by A. Tarvydas, Ontario Land Surveyor, in 1958, on a meridian in the Territorial District of Kenora; thence south astronomically along that line to the 212 Mile Post on said meridian line; thence southerly along that meridian to the northerly extremity of the boundary between the territorial districts of Cochrane and Thunder Bay; thence southerly, easterly and southerly along the boundary between the territorial districts of Cochrane and Thunder Bay to the southwest corner of the geographic Township of Clavet; thence southerly along the boundary between the territorial districts of Algoma and Thunder Bay to the International Boundary between Canada and the United States of America; thence northwesterly, southwesterly and westerly along that International Boundary to the boundary between the territorial districts of Rainy River and Thunder Bay; thence northerly along that boundary and the boundary between the territorial districts of Kenora and Thunder Bay to the intersection with the parallel of latitude 50° 00'; thence easterly along that parallel of latitude to the intersection with the meridian line surveyed by K. G. Ross, Ontario Land Surveyor, in 1921; thence northerly along that meridian line to the southeast corner of the geographic Township of Bertrand; thence continuing northerly along the east boundary of the geographic townships of Bertrand, McLaurin, Furlonge, Fletcher and Bulmer to the northeast corner of the said Township of Bulmer; thence continuing northerly along a meridian line surveyed by Phillips and Benner, Ontario Land Surveyors, in 1923, to the northerly boundary of the Territorial District of Thunder Bay; thence northeasterly along that boundary to the intersection with the line of longitude 89° 30'; thence north astronomically along that line of longitude to the intersection with the parallel of latitude 52° 30'; thence westerly along that parallel of latitude to the intersection with a meridian line surveyed by A. Tarvydas, Ontario Land Surveyor, in 1957; thence northerly along that meridian line to the 215 + 78.207 Mile Post planted thereon; thence north astronomically to the Interprovincial Boundary between Ontario and Manitoba; thence northeasterly along that Interprovincial Boundary to the shore of Hudson Bay; thence southeasterly along that shore to the intersection with a line drawn on a course of north astronomically from the place of beginning; thence south astronomically along that line to the place of beginning. O. Reg. 236/84, s. 1, *part.*

Schedule 38**TIMISKAMING HEALTH UNIT**

1. All the municipalities and geographic townships in the Territorial District of Timiskaming, except the following geographic townships:

- | | |
|----------------|--------------|
| 1. Barlett | 7. Hillary |
| 2. Childerhose | 8. McArthur |
| 3. Douglas | 9. McKeown |
| 4. Doyle | 10. Musgrove |
| 5. Fripp | 11. Pharand |
| 6. Geikie | 12. Reynolds |

2. The following geographic townships in the Territorial District of Cochrane:

- | | |
|--------------|-------------|
| 1. Ben Nevis | 3. Clifford |
| 2. Bisley | 4. Pontiac |

3. The Township of Temagami in the Territorial District of Nipissing.

4. The following geographic townships in the Territorial District of Nipissing:

- | | |
|-------------|----------------|
| 1. Askin | 12. Joan |
| 2. Aston | 13. Law |
| 3. Banting | 14. Le Roche |
| 4. Belfast | 15. Milne |
| 5. Best | 16. Olive |
| 6. Briggs | 17. Phyllis |
| 7. Canton | 18. Riddell |
| 8. Cassels | 19. Scholes |
| 9. Chambers | 20. Torrington |
| 10. Clement | 21. Vogt |
| 11. Cynthia | 22. Yates |

O. Reg. 236/84, s. 1, *part.*

Schedule 39**WELLINGTON—DUFFERIN—GUELPH HEALTH UNIT**

1. The counties of Wellington and Dufferin. O. Reg. 236/84, s. 1, *part.*

Schedule 40**WINDSOR-ESSEX COUNTY HEALTH UNIT**

1. The County of Essex. O. Reg. 236/84, s. 1, *part.*; O. Reg. 447/87, s. 1.

Schedule 41**CITY OF YORK HEALTH UNIT**

1. The City of York. O. Reg. 236/84, s. 1, *part.*

Schedule 42**YORK REGIONAL HEALTH UNIT**

1. The Regional Municipality of York. O. Reg. 236/84, s. 1, *part.*

REGULATION 554**CAMPS IN UNORGANIZED TERRITORY**

1. In this Regulation,

“building” means any building, vehicle or other structure or premises used or intended to be used for accommodation for employees or for the storage, preparation or serving of food;

“camp” means a camp in which buildings are used to accommodate five or more employees who are employed in mining work, lumbering work or any other labour work in territory without municipal organization;

“hazardous food” means any food that is capable of supporting the growth of pathogenic organisms or the production of the toxins of such organisms;

“operator” means a person who, owns or operates personally or by agents a camp;

“sanitizing” means antimicrobial treatment and “sanitize” has a corresponding meaning;

“single-service article” means any container or eating utensil that is to be used only once in the service or sale of food;

“toilet” includes a privy;

“utensil” means any article or equipment used in the manufacture, processing, preparation, storage, handling, display or distribution of food, except a single-service article;

“washbasin” includes a pail or other portable container of sound construction. O. Reg. 193/84, s. 1.

NOTICE OF OPENING A CAMP

2.—(1) Every person who intends to operate a camp shall, before the camp is opened, send in writing to the medical officer of health or public health inspector,

- (a) the name and address of the person who employs the employees in the camp;
- (b) the location of the camp;
- (c) the number of employees that the camp is designed to accommodate;
- (d) the means of access to the camp; and
- (e) the nature and expected duration of the work in which the employees to be accommodated will be employed.

(2) Where a camp is to accommodate fifteen or more employees, the report submitted under subsection (1) shall include,

- (a) a sketch plan of the location of the buildings on the site;
- (b) sketch plans of the buildings showing the facilities for sleeping, washing, bathing, laundering clothes and storing, preparing and serving of food; and
- (c) the source and means of distribution of the camp water supply.

(3) The operator shall ensure that, where a camp has been used for living accommodation of employees and the camp is abandoned or closed, the camp is not used again for living accommodation of employees until a report in writing showing the information required in subsections (1) and (2) is submitted to the medical officer of health or public health inspector. O. Reg. 193/84, s. 2.

3. Where any change is made in respect of any of the matters referred to in subsections 2 (1) and (2), the operator shall notify the medical officer of health or public health inspector in writing, giving particulars thereof within fourteen days after the change is made. O. Reg. 193/84, s. 3.

GENERAL REQUIREMENTS

4. Every operator shall forthwith notify the medical officer of health or public health inspector of an outbreak or suspected outbreak of any communicable disease in a camp operated by the operator. O. Reg. 193/84, s. 4.

5. When a camp is closed or abandoned, the operator shall ensure that the camp is left in a sanitary condition and the operator shall notify the medical officer of health or public health inspector forthwith that the camp is closed or abandoned. O. Reg. 193/84, s. 5.

6. The operator shall ensure that the camp is so located, constructed, equipped and maintained as to be free from any condition that may endanger the health or safety of the staff or employees of the camp. O. Reg. 193/84, s. 6.

7. The operator shall ensure that every building in the camp is maintained in a sanitary condition. O. Reg. 193/84, s. 7.

8. The operator shall ensure that the openings to the outside of all buildings in the camp used for sleeping, washing, bathing, laundering clothes, eating and cooking are screened so as to prevent entry of insects, rodents or vermin. O. Reg. 193/84, s. 8.

WATER SUPPLY

9. The operator shall ensure that the camp water is,

- (a) obtained from a source approved by the medical officer of health or public health inspector;
- (b) readily available for camp use; and
- (c) of sufficient quantity to meet the requirements of the persons in the camp. O. Reg. 193/84, s. 9.

10.—(1) The operator shall ensure that water provided for human consumption is potable.

(2) Where potable water is not available from a pressure system, the operator shall ensure that potable water is provided in sanitary containers equipped with a pouring faucet. O. Reg. 193/84, s. 10.

11.—(1) Where water intended for human consumption is obtained from surface sources the water shall be treated by the operator in a manner approved by the medical officer of health or public health inspector before it is delivered or distributed for camp use.

(2) Where water is treated as required under subsection (1), the operator shall keep an accurate daily record of the kind, manner or method of treatment of the water and the record shall be kept for a period of one year.

(3) Where water is treated as required under subsection (2), the operator shall provide and maintain equipment at the camp for the testing of the water. O. Reg. 193/84, s. 11.

12.—(1) The operator shall ensure that where drinking fountains are provided the drinking fountains comply with the Plumbing Code made under the *Ontario Water Resources Act*.

(2) The operator shall ensure that common drinking cups are not used in the camp. O. Reg. 193/84, s. 12.

SANITARY FACILITIES

13.—(1) The operator shall ensure that the camp is provided with sanitary facilities in accordance with this section and sections 14, 15 and 16.

(2) Where the persons in a camp are both male and female, separate sanitary facilities shall be provided for each sex as follows:

1. At least one toilet shall be provided for every ten employees of each sex.
2. At least one washbasin shall be provided for every five employees of each sex.

(3) Where water-flush toilets are provided in a camp, urinals may be counted as toilets for male use but the number of urinals shall not exceed 50 per cent of the number of toilets. O. Reg. 193/84, s. 13.

14.—(1) Every sanitary facility in a camp shall,

- (a) be equipped with windows and self-closing, tight-fitting doors;
- (b) have all doors and windows screened against insects, rodents and vermin;
- (c) be ventilated so as to eliminate offensive odours; and
- (d) be kept sanitary and in good repair at all times.

(2) Where a camp is in operation, all toilet seats shall be thoroughly scrubbed daily with a sanitizing solution. O. Reg. 193/84, s. 14.

15. Every sanitary facility in a camp shall be equipped with,

- (a) a supply of toilet paper;
- (b) a cleanable receptacle of sound construction for depositing used towels and other refuse;
- (c) a supply of soap or detergent; and
- (d) a supply of single-service towels or a hot air dryer. O. Reg. 193/84, s. 15.

16.—(1) Where one or more water-flush toilets are used in a camp, a supply of hot and cold water shall be provided.

(2) Where one or more privies are used in a camp, commercially packaged single-use moist hand towellettes or a supply of cold water containing a disinfectant shall be provided. O. Reg. 193/84, s. 16.

LAUNDRY OPERATIONS

17. The operator shall ensure that laundry operations in the camp are not carried out in a river, lake, stream or other natural body of water in or adjacent to the camp. O. Reg. 193/84, s. 17.

DISPOSAL OF GARBAGE AND REFUSE

18. The operator shall ensure that garbage and refuse in the camp is,

- (a) deposited in leakproof durable containers equipped with tight-fitting tops;
- (b) removed after each meal from any room in which food is prepared, served or stored; and
- (c) collected daily and stored in a sanitary manner until final disposal. O. Reg. 193/84, s. 18.

FOOD PREPARATION AND STORAGE

19.—(1) The operator shall ensure that food in the camp is protected from contamination and adulteration and that foods not requiring refrigeration are kept in closed containers and stored in areas designated by the operator as areas for food storage only.

(2) The operator shall ensure that the camp is provided with refrigerated space adequate for the safe storage of perishable and hazardous food. O. Reg. 193/84, s. 19.

20.—(1) The operator shall ensure that, hazardous food in the camp, other than hermetically sealed food that has been subjected to a process sufficient to prevent the production of bacterial toxins or the survival of spore-forming pathogenic bacteria, is distributed, maintained, stored, transported or displayed such that the internal temperature of the food is,

- (a) 5° Celsius or lower; or
- (b) 60° Celsius or higher,

except for such periods of time as may be necessary for the preparation, processing and manufacturing of the food.

(2) The operator shall ensure that, frozen food in the camp is stored and maintained at a temperature of minus 18° Celsius or lower. O. Reg. 193/84, s. 20.

21. The operator shall ensure that in the camp temperature controlled rooms and compartments used for the storage of hazardous

food are provided with accurate indicating thermometers that can be easily read. O. Reg. 193/84, s. 21.

22. The operator shall ensure that racks, shelves or pallets are provided for the storage of food in the camp and that no rack or shelf is placed less than fifteen centimetres above the floor. O. Reg. 193/84, s. 22.

23. The operator shall ensure that the food in the camp is stored on the racks, shelves or pallets referred to in section 22. O. Reg. 193/84, s. 23.

24. The operator shall ensure that, tongs, spoons and scoops of corrosion-resistant and non-toxic material are used in the camp wherever possible where food is being prepared or served to avoid direct hand contact with food. O. Reg. 193/84, s. 24.

25. The operator shall ensure that cloths and towels used for washing, drying or polishing utensils or cleaning tables in the camp are,

- (a) in good repair;
- (b) clean; and
- (c) used for no other purpose. O. Reg. 193/84, s. 25.

26. The operator shall ensure that toxic and poisonous substances required for maintenance of sanitary conditions in the camp are,

- (a) kept in a compartment separate from food so as to preclude contamination of any food, working surface or utensil;
- (b) kept in a container that bears a label on which the contents of the container are clearly identified; and
- (c) used only in such manner and under such conditions that the substances do not contaminate food or cause a health hazard. O. Reg. 193/84, s. 26.

27. The operator shall ensure that each person who handles or comes in contact with food or with any utensil used in the preparation, processing, service or storage of food in the camp,

- (a) does not use tobacco while so engaged;
- (b) is clean;
- (c) wears clean outer garments;
- (d) wears headgear that confines the hair;
- (e) washes his or her hands before commencing or resuming work and after each use of a toilet or urinal;
- (f) is free from any infectious agent of a disease that may be spread through the medium of food; and
- (g) submits to such medical examinations and tests as are required by the medical officer of health to confirm the absence of an infectious agent mentioned in clause (f). O. Reg. 193/84, s. 27.

28. The operator shall ensure that a person who has a skin disease does not perform any work that brings the person into contact with food in the camp unless the person has obtained the approval of the medical officer of health in writing before handling food. O. Reg. 193/84, s. 28.

29.—(1) The operator shall ensure that each food preparation area in the camp is provided with a supply of hot and cold potable water.

- (2) The operator shall ensure that a separate washbasin for hand

washing is provided for employees in each food preparation area in the camp, together with soap or detergent in a dispenser and,

- (a) clean single-service towels;
- (b) a continuous cloth roller towel in a mechanical device together with a supply of paper towels; or
- (c) a hot air dryer. O. Reg. 193/84, s. 29.

VENTILATION

30.—(1) The operator shall ensure that each sleeping area, dining room or other building used by employees in the camp is provided with,

- (a) natural ventilation adequate to ensure the elimination of all offensive odours; or
- (b) mechanical ventilation capable of providing at least one air change per hour.

(2) The operator shall ensure that at least ten air changes per hour is provided in each food preparation area of the camp. O. Reg. 193/84, s. 30.

ACCOMMODATION AND FACILITIES

31. The operator shall ensure that where the persons in the camp are both male and female, separate sleeping, washing and bathing facilities are provided for each sex. O. Reg. 193/84, s. 31.

32. Every camp accommodating fewer than fifteen employees or that operates for less than twenty-eight days in a year is exempt from the provisions of sections 33 to 39, sections 41 and 46, sections 50 to 53 and section 56. O. Reg. 193/84, s. 32.

33. The operator shall ensure that each building used for the storage, preparation and serving of food or intended to be used for sleeping in the camp is weatherproof and so constructed that,

- (a) the floors are tight-fitting and smooth;
- (b) the walls extend at least 2.3 metres above floor level; and
- (c) the walls and ceilings can be maintained in a sanitary condition. O. Reg. 193/84, s. 33.

34. The operator shall ensure that each building used for sleeping in the camp is so constructed that,

- (a) a minimum of 3.72 square metres of floor area per occupant is provided in every room used for sleeping purposes;
- (b) the beds are,
 - (i) separate,
 - (ii) at least thirty centimetres above the floor,
 - (iii) single-tiered,
 - (iv) at least one metre apart when not separated by a partition extending at least the length of the bed and one-half the height of the wall, and
 - (v) provided with one locker or one shelf for each bed;
- (c) a shelf is located at each bed for the storage of employees' personal belongings; and
- (d) a separate room, compartment, locker or cupboard is provided for the storage of employees' clothing. O. Reg. 193/84, s. 34.

35. The operator shall ensure that,

- (a) the temperature in sleeping areas and in washrooms when occupied by employees is maintained at not less than 20° Celsius;
- (b) mattresses, blankets, sheets, pillows and pillow cases are kept in a sanitary condition and are in sufficient supply to meet the needs of the persons in the camp; and
- (c) permanent buildings used for sleeping are equipped with smoke alarms. O. Reg. 193/84, s. 35.

36.—(1) Except as provided in section 37, the operator shall ensure that the area for washing, bathing and laundering clothes in the camp comprises a separate heated room or heated building that is annexed to and that has direct access to the sleeping area.

(2) The operator shall ensure that, the facilities,

- (a) for washing include,
 - (i) a constant supply of hot and cold water, and
 - (ii) at least one sink or washbasin for every five beds;
- (b) for bathing include,
 - (i) a constant supply of hot and cold water, and
 - (ii) showers in a ratio of one shower for every fifteen beds or less or other means of bathing satisfactory to the medical officer of health or public health inspector; and
- (c) for laundering, where a laundry service is not provided, include,
 - (i) a constant supply of hot and cold water,
 - (ii) at least one washing machine or laundry tub for every fifteen beds or less, and
 - (iii) facilities for drying laundry. O. Reg. 193/84, s. 36.

37. Where a camp is occupied only during the period from the 1st day of May to the 1st day of November, an area for washing, bathing or laundering may comprise a separate building provided that it is located in a position convenient to the sleeping area. O. Reg. 193/84, s. 37.

38. The operator shall provide at least one dining-room and one kitchen in the camp and the dining-room and kitchen shall be separated or partitioned from any area used for sleeping. O. Reg. 193/84, s. 38.

LIGHTING

39. The operator shall ensure that the camp is provided with,

- (a) a minimum intensity of illumination of 100 lux in all hallways, corridors, stairways and sleeping areas;
- (b) a minimum intensity of illumination of 500 lux in the kitchen; and
- (c) a minimum intensity of illumination of 250 lux in all rooms other than those referred to in clauses (a) and (b). O. Reg. 193/84, s. 39.

FOOD PREPARATION AREAS

40.—(1) The operator shall ensure that, furniture, equipment and appliances in any room or area in the camp where food is stored, prepared, served or consumed is so constructed and arranged as to per-

mit thorough cleaning and maintaining of the room or area in a clean and sanitary condition.

(2) The operator shall ensure that each room in the camp where food is prepared, served, eaten or stored is,

- (a) free from materials and equipment not regularly used in the room;
- (b) free from live birds and animals unless the medical officer of health gives his approval for the keeping of the birds or animals; and
- (c) not used for sleeping purposes and that no area used for sleeping opens directly into the room.

(3) The operator shall provide a separate room, compartment, locker or cupboard in the camp for the storage of clothes of employees who handle or come into contact with food. O. Reg. 193/84, s. 40.

41. The operator shall ensure that each room in the camp where food is prepared is provided with ventilation adequate to remove smoke, gases and odours to the outside and that cooking equipment is,

- (a) provided with a shield, canopy or other device of corrosion-resistant non-absorbent and readily cleanable material; or
- (b) placed so as to protect walls, ceilings and equipment from grease and food particles. O. Reg. 193/84, s. 41.

42. The operator shall ensure that each article or piece of equipment that is used for preparation, service display, storage or transportation of food in a camp is,

- (a) of sound and tight construction;
- (b) kept in good repair; and
- (c) of such form and material that it can be readily cleaned and sanitized. O. Reg. 193/84, s. 42.

43.—(1) The operator shall ensure that equipment and utensils with which food comes in direct contact are,

- (a) corrosion-resistant and non-toxic; and
- (b) free from cracks, crevices and open seams.

(2) Despite subsection (1), cutting boards, blocks, tables, bowls, platters and churns of hardwood or other materials may be used in a camp where,

- (a) such equipment is maintained in a clean and sanitary condition; and
- (b) the manner and conditions of their use are not a health hazard. O. Reg. 193/84, s. 43.

44. The operator shall ensure that utensils that are used in the camp are cleaned and sanitized in accordance with sections 45, 47, 48 and 49. O. Reg. 193/84, s. 44.

45. The operator shall ensure that,

- (a) multi-service articles that are used in the preparation, processing or service of food are cleaned and sanitized after each use; and
- (b) utensils other than multi-service articles are cleaned and sanitized as often as is necessary to maintain them in a clean and sanitary condition. O. Reg. 193/84, s. 45.

46.—(1) The operator shall ensure that equipment and facilities

for the cleaning and sanitizing of utensils in the camp are used for no other purpose and consist of,

- (a) mechanical equipment; or
- (b) equipment for washing by hand consisting of,
 - (i) a three-compartment sink or three sinks of corrosion-resistant material of sufficient size to ensure thorough cleaning and sanitizing of utensils, or
 - (ii) a two-compartment sink or two sinks of corrosion-resistant material for the cleaning and sanitizing of utensils where washing and rinsing can be done effectively in the first sink and the second sink is used for sanitizing as described in subsection 49 (1), and
 - (iii) drainage racks of corrosion-resistant material.

(2) Where the sinks referred to in subclause (1) (b) (i) or (ii) are not sufficient to effectively clean and sanitize the utensils, such additional sinks as will effectively clean and sanitize the utensils are required.

(3) Subclause (1) (b) (ii) does not apply to the cleaning and sanitizing of multi-service articles or utensils that directly contact ready to eat foods. O. Reg. 193/84, s. 46.

47. Utensils shall be,

- (a) scraped or rinsed;
- (b) cleaned;
- (c) rinsed; and
- (d) sanitized. O. Reg. 193/84, s. 47.

48. Where equipment for washing by hand is used in a camp, utensils shall be,

- (a) cleaned in a sink in a detergent solution capable of removing soil;
- (b) rinsed in the second sink in clean water at a temperature not lower than 43° Celsius; and
- (c) sanitized in the third sink. O. Reg. 193/84, s. 48.

49.—(1) Utensils shall be sanitized by,

- (a) immersion in water at a temperature of at least 77° Celsius or more for at least forty-five seconds;
- (b) immersion in a chlorine solution of not less than 100 parts per million of available chlorine at a temperature not lower than 24° Celsius for at least forty-five seconds;
- (c) immersion in a clean quarternary ammonium compound solution of not less than 200 parts per million at a temperature not lower than 24° Celsius for at least forty-five seconds;
- (d) immersion in a clean solution containing not less than twenty-five parts per million of available iodine at a temperature not lower than 24° Celsius for at least forty-five seconds; or
- (e) immersion in any solution containing a sanitizing agent that is non-toxic and that provides a bactericidal result not less than the result provided by clause (a), (b), (c) or (d) and for which a convenient test reagent is available.

(2) A test reagent for determining the concentration of sanitizer

and an accurate thermometer to determine the temperature of the sanitizing solution shall be readily available where the sanitizing takes place in a camp. O. Reg. 193/84, s. 49.

50. Despite sections 48 and 49, utensils other than utensils that come into direct contact with a milk product or ready to eat food, may be cleaned and sanitized in one operation provided that,

- (a) the chemical product used is designed for that purpose;
- (b) the product container bears directions for use indicating optimum temperature and exposure times;
- (c) the product is used in accordance with the directions for use;
- (d) a test reagent is readily available on the premises to determine the concentration of the sanitizing agent; and
- (e) the utensils so treated are completely rinsed with clean water. O. Reg. 193/84, s. 50.

51.—(1) The operator shall ensure that mechanical equipment for the cleaning and sanitizing of utensils in the camp is,

- (a) so constructed, designed and maintained that,
 - (i) the wash water is sufficiently clean at all times to clean the dishes and is maintained at a temperature not lower than 60° Celsius or higher than 71° Celsius, and
 - (ii) the sanitizing rinse is,
 - (A) water that is maintained at a temperature not lower than 82° Celsius and is applied for a minimum of ten seconds in each sanitizing cycle, or
 - (B) a chemical solution described in clause 49 (1) (b), (c), (d) or (e); and
- (b) provided with thermometers that show wash and rinse temperatures and that are so located as to be easily read.

(2) An operator may use another machine or device other than the mechanical equipment referred to in subsection (1) where the machine or device will in the opinion of the medical officer of health effectively clean and sanitize the utensils and will result in a bacterial count on the utensils within the limits set out in section 53. O. Reg. 193/84, s. 51.

52. Where food processing equipment in a camp is cleaned and sanitized in-place without disassembling the equipment, the operator shall ensure that instructions respecting,

- (a) the chemicals used for cleaning and sanitizing;
- (b) the strength of the chemical solutions used;
- (c) the length of time the equipment was exposed to the chemicals; and
- (d) the procedures used for cleaning and sanitizing the equipment,

are posted in a place accessible to the person carrying out the cleaning and sanitizing. O. Reg. 193/84, s. 52.

53. The operator shall ensure that the standard plate count from a multi-service article in the camp does not exceed 100 bacterial colonies after cleaning and sanitizing and prior to re-use when tested by the official method in accordance with the standard plate test, utilizing the swab technique. O. Reg. 193/84, s. 53.

54. The operator shall ensure that utensils in the camp that have been cleaned and sanitized are transported and stored in such manner as to prevent contamination. O. Reg. 193/84, s. 54.

55. The operator shall ensure that, where a utensil is so large as to preclude washing and sanitizing by means of sinks or other machines, it is washed and scrubbed with a detergent solution rinsed with clean water and,

- (a) sprayed or rinsed with hot water or steam in a manner that provides a temperature of not less than 82° Celsius on the treated surface; or
- (b) sprayed or rinsed with a chemical solution designated in subsection 49 (1) at double the strength therein prescribed. O. Reg. 193/84, s. 55.

56. A reference in this Regulation to the medical officer of health or the public health inspector means the medical officer of health or the public health inspector, as the case may be, of the board of health in the health unit in which the camp referred to is situated. O. Reg. 193/84, s. 56.

REGULATION 555

CAPITAL ASSISTANCE GRANTS FOR BOARDS OF HEALTH

1. In this Regulation,

“approved cost” means that portion of the actual cost of a building project approved by the Minister, and includes,

- (a) fees that are approved by the Minister and paid to an architect for his or her services and the services of his or her consulting engineers,
- (b) fees that are approved by the Minister for consultants, other than those paid through an architect,
- (c) necessary basic equipment and furnishings, and the installation thereof,
- (d) land surveys and soil tests, and
- (e) necessary paving and sodding,

but does not include,

- (f) operating supplies,
- (g) working capital and pre-opening expenses,
- (h) financing charges,
- (i) contingency allowances,
- (j) landscaping, gardens, works of art, murals, busts, statues and similar decorations,
- (k) facilities for ancillary revenue-producing operations, or
- (l) land costs;

“balance of the approved cost” means the remainder after deducting the amount of the grant from the actual cost of the building project;

“building project” means,

- (a) the acquisition of an existing building or buildings and alterations or additions thereto,

- (b) the construction of a new building or buildings, but does not include the demolition of existing buildings or the clearing of a site, or
- (c) the renovation or alteration of an existing building or buildings,

for the use and purposes of a board of health. O. Reg. 234/84, s. 1.

2.—(1) The Minister may pay a grant to a board of health that makes application therefor in a form provided by the Minister for a building project that is for the use and purposes of a board of health in performing its duties and functions under the Act.

(2) The amount of a grant shall be two-thirds of the approved cost of the building project. O. Reg. 234/84, s. 2.

3. It is a condition of a grant that,

- (a) the Minister has received all such information, material and documents as the Minister requires in respect of the building project;
- (b) the municipalities within the health unit of the board of health that has made application for the grant have undertaken to pay the balance of the approved cost of the building project in such proportions as are agreed upon by the municipalities;
- (c) the building project has been approved by the Minister;
- (d) tenders are not called for any proposed new construction, additions or alterations until the Minister advises in writing that the grant has been approved; and
- (e) the board of health undertakes it will not,
 - (i) sell, mortgage or otherwise dispose of a building or any part thereof that is the subject of the grant,
 - (ii) use a building for any other purpose than that for which the grant with respect to the building is made, or
 - (iii) make any alterations or additions to a building that is the subject of the grant,

without the consent of the Minister. O. Reg. 234/84, s. 3.

4.—(1) A grant shall be paid as follows:

1. One-fifth when the contract for the building project is signed.
2. One-tenth when one-eighth of the work is completed.
3. One-tenth when one-quarter of the work is completed.
4. One-tenth when three-eighths of the work is completed.
5. One-tenth when one-half of the work is completed.
6. One-tenth when five-eighths of the work is completed.
7. One-tenth when three-quarters of the work is completed.
8. One-tenth when seven-eighths of the work is completed.
9. The balance when the work is completed to the satisfaction of the Minister.

(2) It is a condition of payment of a portion of a grant under subsection (1) that a member of the Ontario Association of Architects

certifies or the Minister is otherwise satisfied that the proper proportion of the work has been completed. O. Reg. 234/84, s. 4.

REGULATION 556

CLINICS FOR SEXUALLY TRANSMITTED DISEASES

1. In this Regulation,

“clinic” means a clinic established, equipped, operated and maintained by a board of health or a hospital in accordance with this Regulation for the treatment of persons who have or who are suspected of having syphilis, gonorrhoea, chancroid, granuloma inguinale, genital C. trachomatis infections or lymphogranuloma venereum;

“clinic attendance” means a visit by a person to a clinic for an examination, or for treatment, supervision or follow-up for a sexually transmitted disease;

“Director” means the Director of the Public Health Branch of the Ministry or his or her successor or any person designated by the Minister to exercise the duties of the Director of the Public Health Branch;

“hospital” means a hospital under the *Public Hospitals Act*. O. Reg. 237/84, s. 1.

2. It is a condition of a grant made under this Regulation that the board of health or hospital that establishes a clinic for which a grant is applied for,

- (a) appoint a physician, who is approved by the Director, to have charge of the examination, treatment, supervision and follow-up of patients in the clinic;
- (b) appoint a staff of physicians and registered nurses adequate to examine, treat, supervise and give follow-up to all persons who apply for examination, treatment, supervision or follow-up at the clinic;
- (c) permit the Director to inspect,
 - (i) patient records, provided that the identity of the patient is not disclosed,
 - (ii) clinic records, and
 - (iii) equipment in the clinic;
- (d) provide the necessary examination, treatment, supervision and follow-up to any person who applies at the clinic and who has or is suspected of having a disease referred to in the definition of “clinic” in section 1; and
- (e) not charge for any service rendered during a clinic attendance. O. Reg. 237/84, s. 2.

3. Where a clinic is operated and maintained by a board of health, the board shall be paid a maintenance grant by the Minister of \$11 in respect of each clinic attendance. O. Reg. 237/84, s. 3.

4.—(1) The Minister shall pay a grant for medical services rendered in a clinic by a physician for diagnosis and treatment of a person who has or who is suspected of having a disease referred to in the definition of “clinic” in section 1 and the amount of the grant shall be equal to the amount that would be payable for medical services under the *Health Insurance Act*.

(2) In addition to the amount payable for medical services, a grant referred to in subsection (1) shall also include the cost of drugs

used in the care and treatment of the person referred to in subsection (1). O. Reg. 237/84, s. 4.

5. Where the treasurer of a municipality receives an account for medical services rendered by a physician to a person not insured under the *Health Insurance Act*, who has or is suspected of having a disease referred to in the definition of "clinic" in section 1, within three months after the service was performed under the direction of the medical officer of health, the treasurer shall pay the account and forward the account to the Minister within three months after he or she receives the account and the Minister shall pay a grant to the municipality equal to the amount that would be payable for the medical services as insured health services under the *Health Insurance Act*, and, where an account has been similarly received and submitted for drugs used to treat and cure the disease, the grant shall include 100 per cent of the cost of the drugs. O. Reg. 237/84, s. 5.

REGULATION 557

COMMUNICABLE DISEASES—GENERAL

EYES OF NEW-BORN

1. The following are requirements that shall be complied with in respect of communicable diseases of the eyes of a new-born child for the purposes of section 33 of the Act:

1. Within one hour after delivery, or as soon thereafter as is practicable, there shall be instilled into each conjunctival sac of the new-born child such quantity of 1 per cent solution of silver nitrate or other effective ophthalmic agent as is necessary to destroy any infectious agent that might cause ophthalmia neonatorum without causing injury to the child.
2. Every physician, public health nurse or other health care professional person who attended at the birth of the child and who is aware that an eye of the new-born child has become reddened, inflamed or swollen, within two weeks after birth of the child shall report in writing to the medical officer of health,
 - i. the name, age and home address of the child,
 - ii. where the child is located, if not at home, and
 - iii. the conditions of the eye that have been observed.

O. Reg. 292/84, s. 1.

RABIES

2.—(1) A physician, veterinarian, police officer or any other person who has information concerning any animal bite or other animal contact that may result in rabies in persons shall as soon as possible notify the medical officer of health and provide the medical officer of health with the information.

(2) The owner or the person having the care and custody of an animal,

- (a) that has bitten or is suspected of having bitten a person; or
- (b) that is suspected by the medical officer of health of having rabies,

shall provide the medical officer of health with such information and assistance with respect to the animal as the medical officer of health requires. O. Reg. 292/84, s. 2.

3.—(1) A medical officer of health who receives information under section 2 and who finds any person has been exposed to a rabid or suspected rabid animal so as to require anti-rabies treatment shall provide information, including details of exposure and treat-

ment, to the Manager of the Disease Control and Epidemiology Service of the Ministry.

(2) A medical officer of health who is of the opinion that a dog or cat may be rabid shall cause the dog or cat to be confined and isolated for at least ten days from all animals and persons, except the person caring for the dog or cat,

- (a) at the place of residence of the person caring for the dog or cat, if the dog or cat is free from symptoms of any disease; or
- (b) in a pound or veterinary hospital at the expense of the municipality in which the person caring for the dog or cat resides if the dog or cat exhibits symptoms of any disease or if, in the opinion of the medical officer of health, the person is unlikely to confine and isolate the dog or cat.

(3) Despite subsection (2), the medical officer of health,

- (a) may require the detention of a dog or cat for the purpose of a veterinary examination for evidence of rabies and based on the results of the examination may cause the dog or cat to be confined and isolated for such period as is necessary to determine that the dog or cat is free from symptoms of rabies; or
- (b) may require the destruction of any animal at any time for the purpose of having a laboratory examination to determine if the animal is in the infective stage of rabies.

(4) In the case of a dog or cat, clause (3) (b) only applies where the dog or cat is unclaimed or where permission is given by the owner for the destruction of the dog or cat.

(5) The costs of a veterinary examination or destruction referred to in subsection (4) shall be borne by the municipality in which the animal is detained or the destruction is performed.

(6) A medical officer of health shall notify and furnish particulars to the nearest District Veterinarian of the Animal Health Division, Food Production and Inspection Branch, Agriculture Canada, as soon as possible, where the medical officer of health has reason to believe that an animal,

- (a) is rabid; or
- (b) has been in contact with another animal known or suspected of having rabies.

(7) Where, after a laboratory examination, an animal is found to have been rabid or when there is clinical evidence of rabies, the medical officer of health shall so inform,

- (a) the owner or person who had been caring for the animal; and
- (b) every person known to have been in contact with the animal during the infective stage of the disease and the person's attending physician.

(8) Where an animal has bitten a person or is suspected of being rabid and has had contact with a person and the animal dies or is killed, the owner of the animal or the person having custody of the animal shall notify the District Veterinarian of the Animal Health Division, Food Production and Inspection Branch, Agriculture Canada to arrange for the collection of the head or carcass of the animal. O. Reg. 292/84, s. 3.

PSITTACOSIS—ORNITHOSIS

4.—(1) A director of a laboratory or veterinarian who knows or suspects that a captive bird or birds or a poultry flock is infected with the agent of psittacosis or ornithosis shall notify the medical officer of health.

(2) A medical officer of health who knows or suspects that a captive bird or birds or a poultry flock is infected with the agent of psittacosis or ornithosis shall,

- (a) determine the extent of the infection;
- (b) act to prevent the spread of the infectious agent; and
- (c) notify the Manager of the Disease Control and Epidemiology Service of the Ministry of the extent of the infection and the action being taken.

(3) A medical officer of health who knows or suspects that a captive bird or birds or a poultry flock is infected with the agent of psittacosis or ornithosis shall require the owner, at the owner's expense, to,

- (a) isolate or isolate and treat the bird or birds or poultry flock; and
- (b) have a laboratory examination performed on fecal or tissue specimens of the bird or birds or poultry flock,

until the medical officer of health is of the opinion that the bird or birds or poultry flock is free of the infective agent.

(4) A medical officer of health shall require the owner, at the owner's expense, to destroy the bird or birds or poultry flock and disinfect the premises where,

- (a) isolation and treatment are not, or are unlikely to be, effective in preventing the spread of infection;
- (b) requested by the owner; or
- (c) the person having care and custody of the bird or birds or poultry flock has failed to isolate or treat the bird or birds or poultry flock. O. Reg. 292/84, s. 4.

5.—(1) An owner or person having the care and custody of a bird or birds or poultry flock who is informed by the medical officer of health that the bird or birds or poultry flock is infected or suspected of being infected with the agent of psittacosis or ornithosis shall provide the medical officer of health with information regarding the sources of the bird or birds or poultry flock and any recent distribution of the bird or birds or poultry flock from the premises and shall identify persons who may have become ill as a result of exposure to the bird or birds or poultry flock.

(2) Where a bird or birds or poultry flock is isolated under clause 4 (3) (a), the owner or person having the care and custody of the bird or birds or poultry flock shall notify the medical officer of health as soon as possible if a bird dies during the isolation period and the bird or birds or poultry flock shall be retained and disposed of as directed by the medical officer of health. O. Reg. 292/84, s. 5.

6. Poultry or other birds for human consumption originating from a flock in which ornithosis has been diagnosed shall only be slaughtered for food if the medical officer of health of the health unit in which the slaughterhouse is located is satisfied that the conditions of the proposed slaughter will provide protection to the employees of the slaughterhouse from the agent of psittacosis or ornithosis and the medical officer of health gives permission in writing for the slaughter. O. Reg. 292/84, s. 6.

DISPOSAL OF CORPSES

7. Sections 8, 9 and 10 apply to the corpse of a person who died of or while isolated for,

- (a) anthrax;
- (b) Ebola virus disease;
- (c) haemorrhagic fevers;

- (d) Lassa fever;
- (e) Marburg virus disease;
- (f) meningococcal meningitis or meningococemia;
- (g) plague; or
- (h) smallpox. O. Reg. 292/84, s. 7.

8.—(1) As soon as possible after death occurs, the person having custody of a corpse referred to in section 7 shall place it or cause it to be placed in a coffin of sound construction.

(2) Where a deceased person was infected with smallpox or anthrax, the coffin referred to in subsection (1) shall be hermetically sealed.

(3) A coffin referred to in subsection (1) shall,

- (a) be closed forthwith after the corpse is placed in it; and
- (b) not be opened except as directed by the medical officer of health.

(4) No person shall remove a corpse referred to in section 7 from an isolation room until there has been compliance with subsection (1) and, where applicable, subsection (2).

(5) The medical officer of health may direct that a corpse referred to in section 7 be removed directly to the place of burial, cremation or incineration. O. Reg. 292/84, s. 8.

9. The medical officer of health may restrict the attendance of persons at the funeral of a corpse referred to in section 7. O. Reg. 292/84, s. 9.

10. No person shall deliver a corpse referred to in section 7 to a carrier for transportation or carriage unless the corpse is enclosed in a coffin of sound construction satisfactory to the medical officer of health and the coffin is enclosed in an outer case sufficiently strong to ensure that the coffin and the hermetical sealing, if any, will not be broken throughout the transportation or carriage. O. Reg. 292/84, s. 10.

11. Except as provided in section 6, a reference in this Regulation to the medical officer of health means a reference to the medical officer of health of the board of health in the health unit in which the person, animal or thing, as the case may be, referred to, resides or is resident. O. Reg. 292/84, s. 11.

REGULATION 558

DESIGNATION OF COMMUNICABLE DISEASES

1. The following diseases are designated communicable diseases for the purposes of the Act:

1. Acquired Immune Deficiency Syndrome (A.I.D.S.)
2. Amebiasis
3. Anthrax
4. Arthropod-borne viral infections
5. Botulism
6. Brucellosis
7. Campylobacter enteritis
8. Chancroid

- | | |
|--|--|
| <ul style="list-style-type: none"> 9. Chickenpox (Varicella) 10. Chlamydia trachomatis 11. Cholera 12. Congenital Cytomegalovirus Infection 13. Diphtheria 14. Encephalitis, primary viral 15. Epidemic diarrhoea 16. Food poisoning, all causes 17. Giardiasis 18. Gonorrhoea 19. Granuloma inguinale 20. Hemorrhagic fevers, <ul style="list-style-type: none"> i. Ebola virus disease ii. Marburg virus disease iii. Other viral causes 21. Hepatitis, viral, <ul style="list-style-type: none"> i. Hepatitis A ii. Hepatitis B iii. Non-A, Non-B Hepatitis 22. Histoplasmosis 23. Influenza, Types A, B and C 24. Invasive Haemophilus influenzae b infections 25. Lassa Fever 26. Legionella infections, <ul style="list-style-type: none"> i. Legionnaires' Disease ii. Pontiac Fever 27. Leprosy 28. Leptospirosis 29. Listeriosis 30. Lymphogranuloma venereum 31. Malaria 32. Measles 33. Meningococcal meningitis and meningococemia 34. Meningitis, acute, <ul style="list-style-type: none"> i. bacterial ii. viral iii. other 35. Mumps | <ul style="list-style-type: none"> 36. Ophthalmia neonatorum 37. Pertussis (Whooping Cough) 38. Plague 39. Poliomyelitis, acute 40. Psittacosis/Ornithosis 41. Q Fever 42. Rabies 43. Relapsing Fever, louse-borne 44. Rocky Mountain Spotted Fever 45. Rubella 46. Congenital Rubella Syndrome 47. Salmonella infections, <ul style="list-style-type: none"> i. Typhoid Fever ii. Paratyphoid Fever A, B and C iii. Salmonellosis 48. Shigellosis 49. Smallpox 50. Syphilis 51. Taenia Solium infections 52. Tetanus 53. Toxoplasmosis 54. Trichinosis 55. Tuberculosis 56. Tularemia 57. Typhus, louse-borne and other 58. Vaccinia 59. Verotoxin-producing E. coli infections 60. Yellow Fever 61. Yersiniosis. O. Reg. 161/84, s. 1; O. Reg. 698/86, s. 1; O. Reg. 666/88, s. 1. |
|--|--|

REGULATION 559

DESIGNATION OF MUNICIPAL MEMBERS OF BOARDS OF HEALTH

ALGOMA HEALTH UNIT

1. The Board of Health of the Algoma Health Unit shall have eight municipal members as follows:

1. Three members to be appointed by the Municipal Council of the City of Sault Ste. Marie.
2. One member to be appointed by the Municipal Councils of

the Township of Michipicoten and Township of White River, who shall also represent the Michipicoten Indian Reserve Band.

3. One member to be appointed by the Municipal Councils of the Town of Blind River, the Township of Thompson and the Township of The North Shore.
4. One member to be appointed by the Municipal Councils of the Town of Thessalon, the Village of Iron Bridge, and the townships of Day and Bright Additional and Thessalon.
5. One member to be appointed by the Municipal Councils of the Town of Bruce Mines, the Village of Hilton Beach and the townships of Hilton, Jocelyn, Johnson, Laird, Macdonald, Meredith and Aberdeen Additional, Plummer Additional, Prince, St. Joseph and Tarbutt and Tarbutt Additional.
6. One member to be appointed by the Municipal Council of the Town of Elliot Lake. O. Reg. 235/84, s. 1.

BRANT COUNTY HEALTH UNIT

2. The Board of Health of the Brant County Health Unit shall have six municipal members as follows:

1. Three members to be appointed by the Municipal Council of the County of Brant.
2. Three members to be appointed by the Municipal Council of the City of Brantford. O. Reg. 235/84, s. 2.

BRUCE-GREY-OWEN SOUND HEALTH UNIT

3. The Board of Health of the Bruce-Grey-Owen Sound Health Unit shall have ten municipal members as follows:

1. Four members to be appointed by the Municipal Council of the County of Bruce.
2. Four members to be appointed by the Municipal Council of the County of Grey.
3. Two members to be appointed by the Municipal Council of the City of Owen Sound. O. Reg. 326/89, s. 1.

BOROUGH OF EAST YORK HEALTH UNIT

4. The Board of Health of the Borough of East York Health Unit shall have six municipal members to be appointed by the Municipal Council of the Borough of East York. O. Reg. 235/84, s. 4.

THE EASTERN ONTARIO HEALTH UNIT

5. The Board of Health of the Eastern Ontario Health Unit shall have six municipal members as follows:

1. Two members to be appointed by the Municipal Council of the United Counties of Prescott and Russell.
2. Two members to be appointed by the Municipal Council of the United Counties of Stormont, Dundas and Glengarry.
3. Two members to be appointed by the Municipal Council of the City of Cornwall. O. Reg. 235/84, s. 5.

ELGIN-ST. THOMAS HEALTH UNIT

6. The Board of Health of the Elgin-St. Thomas Health Unit shall have four municipal members as follows:

1. Two members to be appointed by the Municipal Council of the County of Elgin.

2. Two members to be appointed by the Municipal Council of the City of St. Thomas. O. Reg. 235/84, s. 6.

CITY OF ETOBICOKE HEALTH UNIT

7. The Board of Health of the City of Etobicoke Health Unit shall have nine municipal members to be appointed by the Council of the City of Etobicoke. O. Reg. 235/84, s. 7.

HALIBURTON, KAWARTHA, PINE RIDGE DISTRICT HEALTH UNIT

8. The Board of Health of the Haliburton, Kawartha, Pine Ridge District Health Unit shall have six municipal members as follows:

1. Three members to be appointed by the Municipal Council of the County of Northumberland.
2. Two members to be appointed by the Municipal Council of the County of Victoria.
3. One member to be appointed by the Municipal Council of the County of Haliburton. O. Reg. 235/84, s. 9.

HASTINGS AND PRINCE EDWARD COUNTIES HEALTH UNIT

9. The Board of Health of the Hastings and Prince Edward Counties Health Unit shall have eight municipal members as follows:

1. Two members to be appointed by the Municipal Council of the City of Belleville.
2. Three members to be appointed by the Municipal Council of the County of Hastings.
3. Two members to be appointed by the Municipal Council of the County of Prince Edward.
4. One member to be appointed by the Municipal Council of the City of Trenton. O. Reg. 235/84, s. 10.

HURON COUNTY HEALTH UNIT

10. The Board of Health of the Huron County Health Unit shall have four municipal members to be appointed by the Municipal Council of the County of Huron. O. Reg. 235/84, s. 11.

KENT-CHATHAM HEALTH UNIT

11. The Board of Health of the Kent-Chatham Health Unit shall have six municipal members as follows:

1. Four members to be appointed by the Municipal Council of the County of Kent.
2. Two members to be appointed by the Municipal Council of the City of Chatham. O. Reg. 235/84, s. 12.

KINGSTON, FRONTENAC AND LENNOX AND ADDINGTON HEALTH UNIT

12. The Board of Health of the Kingston, Frontenac and Lennox and Addington Health Unit shall have ten municipal members as follows:

1. Four members to be appointed by the Municipal Council of the City of Kingston.
2. Four members to be appointed by the Municipal Council of the County of Frontenac.
3. Two members to be appointed by the Municipal Council of the County of Lennox and Addington. O. Reg. 317/89, s. 1.

SARNIA-LAMBTON HEALTH UNIT

13. The Board of Health of the Sarnia-Lambton Health Unit shall have six municipal members as follows:

1. Three members to be appointed by the Municipal Council of the County of Lambton.
2. Three members to be appointed by the Municipal Council of the City of Sarnia. O. Reg. 235/84, s. 14; O. Reg. 79/88, s. 1.

LEEDS, GRENVILLE AND LANARK DISTRICT HEALTH UNIT

14. The Board of Health of the Leeds, Grenville and Lanark District Health Unit shall have ten municipal members as follows:

1. Three members to be appointed by the Municipal Council of the United Counties of Leeds and Grenville.
2. Two members to be appointed by the Municipal Council of the City of Brockville.
3. One member to be appointed by the Municipal Council of the Town of Gananoque.
4. One member to be appointed by the Municipal Council of the Town of Prescott.
5. One member to be appointed by the Municipal Council of the Town of Smiths Falls.
6. Two members to be appointed by the Municipal Council of the County of Lanark. O. Reg. 235/84, s. 15.

MIDDLESEX-LONDON HEALTH UNIT

15. The Board of Health of the Middlesex-London Health Unit shall have six municipal members as follows:

1. Three members to be appointed by the County Council of the County of Middlesex.
2. Three members to be appointed by the Municipal Council of the City of London. O. Reg. 235/84, s. 16; O. Reg. 240/87, s. 1.

MUSKOKA-PARRY SOUND HEALTH UNIT

16. The Board of Health of Muskoka-Parry Sound Health Unit shall have ten municipal members as follows:

1. Six members to be appointed by the District Council of the District of Muskoka as set out in section 56 of the *District Municipality of Muskoka Act*.
2. One member to be appointed jointly by the Municipal Council of the Village of Rosseau, the Municipal Councils of the townships of Humphrey and Christie and the Municipal Township of Foley and the Corporation of the Township of The Archipelago.
3. One member to be appointed jointly by the Municipal Council of the Town of Parry Sound, the Municipal Councils of the municipal townships of McDougall, Carling, Hagerman and McKellar.
4. One member to be appointed by the Municipal Councils of the townships of Armour, Ryerson, Perry, McMurrich, the Municipal Council of the Village of Burk's Falls and the Municipal Council of the Town of Kearney.
5. One member to be appointed by the Municipal Councils of the villages of Magnetewan and Sundridge, and the Muni-

pal Councils of the municipal townships of Chapman, Joly and Strong. O. Reg. 235/84, s. 17.

NORTH BAY AND DISTRICT HEALTH UNIT

17. The Board of Health for the North Bay and District Health Unit shall have ten municipal members as follows:

1. Seven members to be appointed by the Municipal Council of the City of North Bay.
2. One member to be appointed by the Municipal Councils of the towns of Bonfield and Mattawa, the Municipal Councils of the townships of Bonfield, Calvin, East Ferris, Mattawan and Papineau, and the trustees of the Improvement District of Cameron.
3. One member to be appointed by the Municipal Councils of the towns of Cache Bay and Sturgeon Falls and the Municipal Councils of the townships of Caldwell, Field and Springer.
4. One member to be appointed by the Municipal Councils of the towns of Powassan and Trout Creek, the Municipal Council of the Village of South River, and the Municipal Councils of the townships of Chisholm, Himsworth North, Himsworth South, Machar and Nipissing. O. Reg. 235/84, s. 18.

NORTHWESTERN HEALTH UNIT

18. The Board of Health of the Northwestern Health Unit shall have seven municipal members as follows:

1. One member to be appointed by the Municipal Council of the Town of Kenora who shall also represent the Township of Sioux Narrows.
2. One member to be appointed jointly by the Municipal Councils of the towns of Keewatin and Jaffray and Melick.
3. One member to be appointed jointly by the Municipal Councils of the towns of Dryden and Sioux Lookout and of the townships of Machin, Ignace and Barclay.
4. One member to be appointed jointly by the Municipal Councils of the townships of Golden, Red Lake and Ear Falls.
5. One member to be appointed by the Municipal Council of the Town of Fort Frances.
6. One member to be appointed by the Municipal Council of the Township of Atikokan.
7. One member to be appointed jointly by the Municipal Council of the Town of Rainy River, the Municipal Councils of the townships of Atwood, Alberton, Blue, Chapple, Dilke, Emo, La Vallee, Morley, Morson, Worthington, and McCrosson and Tovell, and the Board of Trustees of the Improvement District of Kingsford. O. Reg. 235/84, s. 19.

CITY OF NORTH YORK HEALTH UNIT

19. The Board of Health of the City of North York shall have eight municipal members to be appointed by the Municipal Council of the City of North York as follows:

1. Four members shall be members of the Municipal Council of the City of North York.
2. Four members shall be residents of the City of North York who are not members of the Municipal Council of the City of North York. O. Reg. 57/85, s. 1.

PERTH DISTRICT HEALTH UNIT

20. The Board of Health of the Perth District Health Unit shall have six municipal members as follows:

1. Three members to be appointed by the Municipal Council of the County of Perth.
2. Two members to be appointed by the Municipal Council of the City of Stratford.
3. One member to be appointed by the Municipal Council of the Town of St. Mary's. O. Reg. 235/84, s. 21.

PETERBOROUGH COUNTY—CITY HEALTH UNIT

21. The Board of Health of the Peterborough County—City Health Unit shall have six municipal members as follows:

1. Three members to be appointed by the Municipal Council of the County of Peterborough, one of whom shall represent the Curve Lake Indian Reserve and the Hiawatha Indian Reserve.
2. Three members to be appointed by the Municipal Council of the City of Peterborough. O. Reg. 235/84, s. 22.

PORCUPINE HEALTH UNIT

22. The Board of Health of the Porcupine Health Unit shall have twelve municipal members as follows:

1. Four members to be appointed by the Municipal Council of the City of Timmins.
2. One member to be appointed by the Municipal Council of the Town of Iroquois Falls.
3. One member to be appointed by the Municipal Council of the Municipal Township of Black River-Matheson.
4. One member to be appointed by the Municipal Council of the Town of Smooth Rock Falls.
5. One member to be appointed by the Municipal Council of the Town of Kapuskasing and the Municipal Councils of the townships of Moonbeam and Fauquier-Strickland.
6. One member to be appointed by the Municipal Council of the Town of Cochrane and the Municipal Council of the Municipal Township of Glackmeyer.
7. One member to be appointed by the Municipal Council of the Town of Hearst.
8. One member to be appointed by the Municipal Council of the Township of Hornepayne.
9. One member to be appointed by the Municipal Councils of the townships of Mattice-Val Coté, Opatatika and Val Rita-Harty. O. Reg. 235/84, s. 23; O. Reg. 524/89, s. 1.

RENFREW COUNTY AND DISTRICT HEALTH UNIT

23. The Board of Health of the Renfrew County and District Health Unit shall have six municipal members as follows:

1. Four members to be appointed by the Municipal Council of the County of Renfrew.
2. One member to be appointed by the Municipal Council of the Township of Airy.
3. One member to be appointed by the Municipal Council of the City of Pembroke. O. Reg. 235/84, s. 24.

CITY OF SCARBOROUGH HEALTH UNIT

24. The Board of Health of the City of Scarborough Health Unit shall have seven municipal members to be appointed by the Municipal Council of the City of Scarborough. O. Reg. 235/84, s. 25.

SIMCOE COUNTY DISTRICT HEALTH UNIT

25. The Board of Health of the Simcoe County District Health Unit shall have six municipal members as follows:

1. Four members to be appointed by the Municipal Council of the County of Simcoe, one of whom shall represent The Beausoleil Indian Band on Christian Island.
2. One member to be appointed by the Municipal Council of the City of Barrie.
3. One member to be appointed by the Municipal Council of the City of Orillia who shall also represent the Chippewas of Rama Indian Band Rama Reserve Number 32. O. Reg. 235/84, s. 26.

SUDBURY AND DISTRICT HEALTH UNIT

26. The Board of Health of the Sudbury and District Health Unit shall have eleven municipal members as follows:

1. Seven members appointed by the Council of The Regional Municipality of Sudbury who are also members of the Regional Council.
2. One member to be appointed by the Municipal Councils of the towns of Gore Bay and Little Current, and the Municipal Councils of the townships of Assinack, Barrie Island, Billings, Burpee, Carnarvon, Cockburn Island, Gordon, Howland, Rutherford and George Island, Sandfield and Tehkummah.
3. One member to be appointed by the Municipal Council of the Town of Espanola, the Municipal Council of the Town of Webbwood, the Municipal Council of the Town of Massey and the Municipal Council of the Township of The Spanish River and the Municipal Councils of the townships of Baldwin and Nairn.
4. One member to be appointed by the Municipal Council of the Township of Hagar and the Municipal Councils of the townships of Casimir, Jennings and Appleby, Ratter and Dunnet, and Cosby, Mason and Martland.
5. One member to be appointed by the Municipal Council of the Township of Chapleau. O. Reg. 235/84, s. 27.

THUNDER BAY DISTRICT HEALTH UNIT

27. The Board of Health of the Thunder Bay District Health Unit shall have twelve municipal members as follows:

1. Three members to be appointed by the Municipal Council of the City of Thunder Bay, one of whom will represent the Band of the Fort William Indian Reserve.
2. One member to be appointed by the Municipal Council of the Township of Neebing.
3. One member to be appointed by the Municipal Council of the Township of Shuniah.
4. One member to be appointed by the Municipal Council of the Township of Paipoonge.
5. One member to be appointed by the Municipal Councils of the townships of Oliver and Gillies.

6. One member to be appointed by the Municipal Councils of the townships of Conmee and O'Connor.
7. One member to be appointed by the Municipal Councils of the townships of Dorion, Nipigon and Red Rock.
8. One member to be appointed by the Municipal Councils of the Town of Longlac, the Town of Geraldton and the Township of Beardmore and the Township of Nakina, which member shall also represent the Rocky Bay Indian Band Number 1.
9. One member to be appointed by the Municipal Councils of the townships of Terrace Bay and Schreiber.
10. One member to be appointed by the Board of Trustees of the Township of Manitowadge and the Municipal Council of the Town of Marathon. O. Reg. 235/84, s. 28.

TIMISKAMING HEALTH UNIT

28. The Board of Health of the Timiskaming Health Unit shall have ten municipal members as follows:

1. One member to be appointed by the Municipal Council of the Town of Cobalt, the Municipal Council of the Township of Coleman, the Municipal Council of the Town of Latchford and the Municipal Council of the Township of Temagami.
2. One member to be appointed by the Municipal Council of the Town of Haileybury.
3. One member to be appointed by the Municipal Council of the Town of New Liskeard.
4. One member to be appointed by the Municipal Councils of the Municipal Township of Larder Lake and the Improvement District of Gauthier.
5. One member to be appointed by the Municipal Councils of the townships of Brethour, Casey, Dymond, Harley and Harris, and the Municipal Council of the Village of Thornloe.
6. One member to be appointed by the Municipal Councils of the townships of Armstrong, Hudson, James and Kearns.
7. Two members to be appointed by the Municipal Council of the Town of Kirkland Lake.
8. One member to be appointed by the Municipal Council of the Township of McGarry.
9. One member to be appointed by the Municipal Council of the Town of Charlton, the Municipal Council of the Town of Englehart, the Municipal Council of the Township of Chamberlain, the Municipal Council of the Township of Evanturel, the Municipal Council of the Township of Hilliard and the Municipal Council of the Township of Dack. O. Reg. 235/84, s. 29.

CITY OF TORONTO HEALTH UNIT

29. The Board of Health of the City of Toronto Health Unit shall have thirteen municipal members to be appointed by the Municipal Council of the City of Toronto. O. Reg. 235/84, s. 30.

WELLINGTON-DUFFERIN-GUELPH HEALTH UNIT

30. The Board of Health of the Wellington-Dufferin-Guelph Health Unit shall have eight municipal members as follows:

1. Three members to be appointed by the Municipal Council of the County of Wellington.

2. Two members to be appointed by the Municipal Council of the County of Dufferin.
3. Three members to be appointed by the Municipal Council of the City of Guelph. O. Reg. 235/84, s. 31.

WINDSOR-ESSEX COUNTY HEALTH UNIT

31. The Board of Health of the Windsor-Essex County Health Unit shall have eight municipal members as follows:

1. Four members to be appointed by the Municipal Council of the City of Windsor.
2. Four members to be appointed by the Municipal Council of the County of Essex, one of whom shall represent the separated Township of Pelee. O. Reg. 235/84, s. 32; O. Reg. 446/87, s. 1.

CITY OF YORK HEALTH UNIT

32. The Board of Health of the City of York shall have nine municipal members to be appointed by the Municipal Council of the City of York. O. Reg. 235/84, s. 33.

REGULATION 560

DESIGNATION OF REPORTABLE DISEASES

1. The following diseases are designated reportable diseases for the purposes of the Act:

1. Acquired Immune Deficiency Syndrome (A.I.D.S.)
2. Amebiasis
3. Anthrax
4. Arthropod-borne viral infections
5. Botulism
6. Brucellosis
7. Campylobacter enteritis
8. Chancroid
9. Chickenpox (Varicella)
10. Cholera
11. Congenital Cytomegalovirus Infection
12. Diphtheria
13. Encephalitis,
 - i. Primary, viral
 - ii. Post-infectious
 - iii. Vaccine-related
 - iv. Subacute sclerosing panencephalitis
 - v. Unspecified

14. Epidemic diarrhoea
15. Food poisoning, all causes
16. Fungal systemic diseases,

- | | |
|--|--|
| <ul style="list-style-type: none"> i. Blastomycosis ii. Histoplasmosis | <ul style="list-style-type: none"> 42. Plague 43. Poliomyelitis, acute 44. Polyneuritis, acute infective (Guillain-Barré syndrome) 45. Psittacosis/Ornithosis 46. Q Fever 47. Rabies 48. Relapsing Fever, louse-borne 49. Reye Syndrome 50. Rocky Mountain Spotted Fever 51. Rubella 52. Congenital Rubella Syndrome 53. Salmonella Infections, <ul style="list-style-type: none"> i. Typhoid Fever ii. Paratyphoid Fever A, B and C iii. Salmonellosis 54. Shigellosis 55. Smallpox 56. Syphilis 57. Taenia solium infections 58. Tetanus 59. Toxocariasis 60. Congenital Toxoplasmosis 61. Trichinosis 62. Tuberculosis 63. Tularemia 64. Typhus, louse-borne and other 65. Vaccinia 66. Verotoxin-producing E. coli infections 67. Yellow Fever 68. Yersiniosis. O. Reg. 162/84, s. 1; O. Reg. 699/86, s. 1; O. Reg. 667/88, s. 1. |
|--|--|
-
-
- REGULATION 561**

EXEMPTION—SUBSECTION 38 (2) OF THE ACT

1. A physician or other person authorized to administer an immunizing agent is, until the 31st day of December, 1991, exempt from the requirements of subsection 38 (2) of the Act where the patient to whom the immunizing agent is to be administered is not competent to consent and there is no committee of the person appointed under the *Mental Incompetency Act* to consent on the patient's behalf. O. Reg. 587/88, s. 1; O. Reg. 582/89, s. 1; O. Reg. 671/90, s. 1.
-
- | |
|---|
| <ul style="list-style-type: none"> 17. Genital Chlamydia trachomatis infections 18. Genital herpes 19. Giardiasis, except asymptomatic cases 20. Gonorrhoea 21. Granuloma inguinale 22. Hemorrhagic fevers, <ul style="list-style-type: none"> i. Ebola virus disease ii. Marburg virus disease iii. Other viral causes 23. Hepatitis, viral, <ul style="list-style-type: none"> i. Hepatitis A ii. Hepatitis B iii. Non-A, Non-B Hepatitis 24. Influenza, Types A, B and C 25. Invasive Haemophilus influenzae b infections 26. Kawasaki disease 27. Lassa Fever 28. Legionella infections, <ul style="list-style-type: none"> i. Legionnaires' Disease ii. Pontiac Fever 29. Leprosy 30. Leptospirosis 31. Listeriosis 32. Lyme Disease 33. Lymphogranuloma venereum 34. Malaria 35. Measles 36. Meningococcal meningitis and meningococemia 37. Meningitis, acute, <ul style="list-style-type: none"> i. bacterial ii. viral iii. other 38. Mumps 39. Neonatal herpes 40. Ophthalmia neonatorum 41. Pertussis (Whooping Cough) |
|---|

REGULATION 562**FOOD PREMISES****PART I
INTERPRETATION**

1.—(1) In this Regulation,

“catering vehicle” means an itinerant food service premise in which no food is prepared other than hot beverages and french fried potatoes;

“corrosion-resistant material” means any material that maintains its original surface characteristics after,

- (a) repeated exposure to food, soil, moisture or heat, or
- (b) exposure to any substance used in cleansing and sanitizing;

“egg grading station” means an egg grading station registered under the *Canada Agricultural Products Act*;

“egg processing station” means an egg product processing station registered under the *Canada Agricultural Products Act*;

“eggs” means raw eggs in the shell;

“employee” means any person who,

- (a) is employed in a food premise, and
- (b) handles or comes in contact with any utensil or with food during its preparation, processing, packaging, service, storage or transportation;

“food contact surface” means any surface that food comes in contact with in a food premise;

“food service premise” means any food premise where meals or meal portions are prepared for immediate consumption or sold or served in a form that will permit immediate consumption on the premises or elsewhere;

“Grade ‘C’ eggs” means eggs that are graded “Canada C” as defined in the regulation under the *Canada Agricultural Products Act*;

“hazardous food” means any food that is capable of supporting the growth of pathogenic organisms or the production of the toxins of such organisms;

“locker plant” means any food premise in which individual lockers are rented or offered for rent to the public for the storage of frozen foods;

“manufactured meat product” means food that is the product of a process and that contains meat as an ingredient and includes meat that is processed by salting, pickling, fermenting, canning, drying or smoking or otherwise applying heat or to which edible fats, cereals, seasonings or sugar have been added;

“mobile preparation premises” means a vehicle or other itinerant food premise from which food prepared therein is offered for sale to the public;

“multi-service article” means any container or eating utensil that is intended for repeated use in the service or sale of food;

“official method” means a method used by a laboratory established under section 79 of the Act for the laboratory examination of food;

“pre-packaged foods” means food that is packaged at a premise other than the premises at which it is offered for sale;

“sanitizing” means antimicrobial treatment, and “sanitize” has a corresponding meaning;

“selling” includes automatic vending;

“serving” includes self-service;

“single-service article” means any container or eating utensil that is to be used only once in the service or sale of food;

“single-service towel” means a towel that is to be used only once before being discarded or laundered for reuse;

“utensil” means any article or equipment used in the manufacture, processing, preparation, storage, handling, display, distribution, sale or offer for sale of food except a single-service article;

“vending machine” means any self-service device that upon insertion of a coin, coins or tokens, automatically dispenses unit servings of food either in bulk or in package form. O. Reg. 243/84, s. 1.

(2) A reference in this Regulation to the medical officer of health or the public health inspector means the medical officer of health or the public health inspector, as the case may be, of the board of health in the health unit in which the food premise referred to is situate. O. Reg. 243/84, s. 83.

**PART II
ESTABLISHMENT****EXEMPTIONS**

2.—(1) This Regulation applies to all food premises except,

- (a) boarding houses that provide meals for fewer than ten boarders;
- (b) a food premise to which Regulation 554 or 568 of Revised Regulations of Ontario, 1990 applies; and
- (c) churches, service clubs and fraternal organizations that,
 - (i) prepare and serve meals for special events for their members and personally invited guests, and
 - (ii) conduct bake sales.

(2) No person shall construct, operate or maintain a food premise to which this Regulation applies except in accordance with this Regulation. O. Reg. 243/84, s. 2.

3.—(1) The following retail food premises are exempt from the provisions of clauses 20 (1) (b) and (c) and sections 68 to 81 where they meet the requirements of subsection (2):

1. Premises where only cold drinks are sold in or from the original container.
2. Premises where only frozen confections are sold in the original package or wrapper.
3. Premises where only hot beverages are prepared and sold.
4. Farms selling only their own farm products in the form of honey, maple syrup, or unprocessed fruits, vegetables and grains.
5. Premises preparing and selling only popped corn, roasted nuts or french fried potatoes.
6. Premises selling only pre-packaged food that is not a hazardous food.
7. Catering trucks.

- (2) A food premise referred to in subsection (1) shall,
- (a) use only single-service articles;
 - (b) provide a supply of single-use commercially packaged moist hand towelettes for the personal hygiene of its employees; and
 - (c) where it has an eating or drinking area, have an eating or drinking area that does not exceed fifty-six square metres. O. Reg. 243/84, s. 3.

CATERING VEHICLES

4.—(1) All food offered for sale from a catering vehicle shall be pre-packaged except for hot beverages and french fried potatoes.

(2) Every catering vehicle shall be equipped with mechanically refrigerated storage and display facilities that shall be used for holding hazardous foods.

(3) Subsection (2) does not apply to vehicles from which only frozen confections in the original package or wrapper are sold. O. Reg. 243/84, s. 4.

MOBILE PREPARATION PREMISES

5.—(1) Mobile preparation premises are exempt from the provisions of sections 68 and 69, but where a mobile preparation premises provides sanitary facilities for its employees the sanitary facilities shall be in compliance with sections 68 and 69.

- (2) In every mobile preparation premises,
- (a) food shall be prepared within the premises and served to the public by persons working within the premises;
 - (b) only single-service articles shall be used;
 - (c) service doors and windows to the preparation area shall be screened and, when the premise is in motion, tightly closed with a solid material to prevent the entrance of dust and fumes into the food preparation area;
 - (d) the driver's compartment shall be completely partitioned from the food preparation area and, where the partition has an access door, the door shall be solid and self-closing;
 - (e) separate holding tanks shall be provided for toilet and sink wastes; and
 - (f) every waste tank and water supply tank shall be equipped with an easily readable gauge for determining the waste or water level in the tank.

(3) Mobile preparation premises where food preparation is limited to the reheating of pre-cooked meat products in the form of wieners or similar sausage products to be served on a bun are exempt from the provisions of clause (2) (a) with respect to the preparation and serving of food to the public by persons positioned within the premises. O. Reg. 243/84, s. 5.

VENDING MACHINES

6. Every vending machine shall be so constructed that,
- (a) it is sealed to the floor or is mounted on legs not less than 15 centimetres in height or on casters or rollers that permit ease of movement for cleaning purposes;
 - (b) service connections through the exterior of the machine are sealed and are such as to prevent or discourage unauthorized disconnection;
 - (c) door and panel access openings to product and container

storage spaces are tight-fitting to prevent the entrance of any contaminating substance or thing;

- (d) ventilation louvers and openings are screened against insects by means of screening material of not less than 16 mesh to each 2.54 square centimetres;
- (e) any condenser unit forming part of the machine is sealed from product and container storage spaces;
- (f) openings by which food is delivered are protected by means of self-closing and tight-fitting doors or covers;
- (g) food storage compartments in which spillage may occur are self-draining;
- (h) openings into all containers used for the storage of food are provided with covers suitable to prevent contamination from reaching the interior of the container; and
- (i) containers and fittings may be disassembled to permit cleaning and sanitizing or so arranged that cleaning and sanitizing solutions can be circulated throughout the fixed system. O. Reg. 243/84, s. 6.

7. Every vending machine shall be provided with,

- (a) a potable water supply piped into the machine under pressure where water is an automatically admixed ingredient;
- (b) a device that will protect against the entrance of carbon dioxide or carbonated liquid into the water supply system;
- (c) automatic controls that will prevent the vending of hazardous foods where,
 - (i) the temperature of a refrigerated compartment exceeds 7° Celsius, or
 - (ii) the temperature of a heated compartment falls below 60° Celsius; and
- (d) an automatic shut-off control that will prevent the overflow of liquid waste where such wastes are collected inside the vending machine. O. Reg. 243/84, s. 7.

8. The components of a vending machine that come into contact with food shall be cleaned and sanitized in the manner prescribed for utensils under section 71, 72, 73, 74, 75 or 76, as the case may be, and for this purpose mobile or remote cleaning and sanitizing facilities may be used. O. Reg. 243/84, s. 8.

9. The name and telephone number of the operator of the vending machine shall be prominently displayed at vending sites where an employee is not in full-time attendance. O. Reg. 243/84, s. 9.

LOCKER PLANTS

10.—(1) Every locker plant shall be equipped with,

- (a) a facility for the freezing of food prior to storage; and
- (b) a locker room for the storage of frozen foods.

(2) The following temperatures shall be maintained in each of the following rooms or compartments:

1. Room or compartment used only for freezing, minus 18° Celsius or lower with a tolerance up to minus 12° Celsius during the initial stage of freezing food.
 2. Locker room, not above minus 18° Celsius with a tolerance up to minus 15° Celsius during periods of public access.
- (3) The temperatures prescribed in subsection (2) shall not pro-

hibit such variations as are necessary during the time required for defrosting operations.

(4) Every locker room in a locker plant shall be provided with an accurate self-recording thermometer and temperature records shall,

- (a) not be used for a period that will exceed one complete rotation of the graph; and
 - (b) be properly dated and signed by the operator and preserved at the plant for a period of at least one year.
- (5) The locker room or freezing facility of a locker plant shall be used only for the processing or storage of food.
- (6) Every locker plant operator shall keep an accurate record of the name and address of each person renting a locker in a locker plant operated by the operator.

(7) Every locker room in a locker plant shall be equipped with a conveniently located properly functioning noise alarm for operation by patrons from within the locker room.

(8) The access door of every locker room shall be fitted with a properly functioning safety lock release so that it can be operated from inside the locker room.

(9) The records referred to in subsections (4) and (6) shall be made available upon request to the medical officer of health or a public health inspector. O. Reg. 243/84, s. 10.

PART III GENERAL

CONSTRUCTION

11. Every food premise shall be so constructed, located and maintained that,

- (a) the premises are free from every condition that may,
 - (i) be a health hazard,
 - (ii) adversely affect the sanitary operation of the premises, or
 - (iii) adversely affect the wholesomeness of food therein;
- (b) no room where food is manufactured, handled, displayed, distributed, sold or offered for sale, prepared, processed, served, transported or stored is used for sleeping purposes and no sleeping quarters open directly into such room;
- (c) a separate room, compartment, locker or cupboard is provided for keeping wearing apparel of employees;
- (d) the floor or floor coverings are tight, smooth and non-absorbent in rooms where,
 - (i) food is manufactured, handled, displayed, distributed, sold or offered for sale, prepared, processed, served, transported or stored,
 - (ii) utensils are washed, or
 - (iii) washing fixtures and toilet fixtures are located;
- (e) the walls and ceilings of rooms and passageways may be readily cleaned and may be maintained in a sanitary condition;
- (f) no room containing a toilet opens directly into any room used for the manufacture, handling, preparation, processing, displaying, distribution, selling or offering for sale or serving of food; and

(g) protection against the entrance of insects, rodents, vermin, dust and fumes is provided. O. Reg. 243/84, s. 11.

12. Despite clause 11 (d), carpeting may be used in areas where food is served where the carpeting is maintained in a clean and sanitary condition. O. Reg. 243/84, s. 12.

LIGHTING

13. Every food premise shall be provided with,

- (a) a minimum of 538 lux of illumination on every working surface where food is processed, prepared or manufactured and in every area where equipment or utensils are cleaned; and
- (b) a minimum of 322 lux of illumination in every storage room, dressing room, sanitary facility, service area and corridor. O. Reg. 243/84, s. 13.

14. Despite clause 13 (b), levels of less than 322 lux may be used in the service area of a food service premise, provided 322 lux of illumination are provided during cleaning operations. O. Reg. 243/84, s. 14.

VENTILATION

15. Every food premise shall be equipped with mechanical ventilation that is vented to the outside,

- (a) over cooking and dishwashing equipment that produces heat, steam, condensation, odour, smoke or fumes; and
- (b) in each sanitary facility. O. Reg. 243/84, s. 15.

16. The mechanical ventilation for a sanitary facility shall be capable of providing a minimum of ten changes of air per hour. O. Reg. 243/84, s. 16.

17. Every system of mechanical ventilation shall be,

- (a) equipped with exhaust fans, ducts, canopies, hoods and filters and access doors where necessary for effective, sanitary operation; and
- (b) constructed of corrosion-resistant and readily cleanable material. O. Reg. 243/84, s. 17.

EQUIPMENT

18. Any article or piece of equipment that is used for the manufacture, distributing, sale or offering for sale, preparation, processing, handling, transportation, storage or display of food shall be,

- (a) of sound and tight construction;
- (b) kept in good repair; and
- (c) of such form and material that it can be readily cleaned and sanitized. O. Reg. 243/84, s. 18.

19.—(1) Equipment and utensils with which food comes in direct contact shall be,

- (a) corrosion-resistant and non-toxic; and
- (b) free from cracks, crevices and open seams.

(2) Despite subsection (1), cutting boards, blocks, tables, bowls, platters and churns of hardwood or other materials may be used where,

- (a) such equipment is maintained in a clean and sanitary condition; and

- (b) the manner and conditions of their use are not a health hazard. O. Reg. 243/84, s. 19.

20.—(1) Every food premise shall be provided with,

- (a) a supply of potable water adequate for the operation of the premises;
- (b) hot and cold running water under pressure in areas where food is processed, prepared or manufactured or utensils are washed;
- (c) a separate handwashing basin in a location convenient for employees in each processing, preparation and manufacturing area, together with supplies of hot and cold water, soap or detergent in a dispenser, and,
- (i) clean single-service towels, or
- (ii) a continuous cloth roller towel in a mechanical device and a supply of paper towels;
- (d) refrigerated space adequate for the safe storage of perishable and hazardous food; and
- (e) containers of durable, leakproof and non-absorbent material with tight-fitting or self-closing lids sufficient for storing all garbage and waste in a sanitary manner.

(2) The basin referred to in clause (1) (c) shall be used only for the handwashing of employees. O. Reg. 243/84, s. 20.

21. Temperature controlled rooms and compartments used for the storage of hazardous foods shall be provided with accurate indicating thermometers that may be easily read. O. Reg. 243/84, s. 21.

22. Racks, shelves or pallets shall be provided for the storage of food and no rack or shelf shall be placed less than fifteen centimetres above the floor. O. Reg. 243/84, s. 22.

23. All food shall be stored on the racks, shelves or pallets referred to in section 22. O. Reg. 243/84, s. 23.

24. Tongs, spoons and scoops of corrosion-resistant and non-toxic material shall be used, wherever possible, to avoid direct hand contact with food. O. Reg. 243/84, s. 24.

25. Drinking fountains shall be of sanitary design and construction and shall not be located within a sanitary facility nor drain into a hand basin or equipment sink. O. Reg. 243/84, s. 25.

FOOD HANDLING

26. All food shall be protected from contamination and adulteration. O. Reg. 243/84, s. 26.

27. All hazardous food displayed for sale or service shall be protected against contamination by means of enclosed containers, cabinets, shields or shelves. O. Reg. 243/84, s. 27.

28. Food transported by an operator shall be enclosed in containers or in such other manner as to prevent contamination of the food and to maintain the food at the temperature prescribed in section 32, 33, 34 or 35, as the case may be. O. Reg. 243/84, s. 28.

29. Food containers that are multi-service articles shall,

- (a) be constructed of such materials and in such a manner as to be readily cleaned and sanitized; and
- (b) not be used for any purpose other than the packaging of food. O. Reg. 243/84, s. 29.

30.—(1) Milk served as a beverage shall be offered for sale or served in or from the original container as filled by the processor.

(2) Subject to subsection (3), milk, cream and edible oil substitutes that are to be used with beverages and cereals shall be added to the beverages and cereals from the original container as filled by the processor.

(3) A container other than the original may be used when milk, cream or an edible oil substitute accompanies a beverage or cereal in the service of a seated patron, provided that,

- (a) the container is filled from the original container immediately prior to serving;
- (b) portions remaining at the end of each service are discarded; and
- (c) the container is cleaned and sanitized in accordance with section 73, 74, 75, 76 or 77, as the case may be, after each service. O. Reg. 243/84, s. 30.

31.—(1) Ice used in the preparation and processing of food or drink shall be made from potable water and shall be stored and handled in a sanitary manner.

(2) Steam that contacts food during processing or preparation shall be from a potable supply and free of toxic substances. O. Reg. 243/84, s. 31.

32. Hazardous foods in hermetically sealed containers that have not been subjected to a process sufficient to prevent the production of bacterial toxins or the survival of spore-forming pathogenic bacteria shall,

- (a) have "Keep Refrigerated" prominently marked on the container; and
- (b) be maintained, transported, displayed, stored or offered for sale at an internal temperature not higher than 5° Celsius. O. Reg. 243/84, s. 32.

33. Hazardous foods other than those hermetically sealed foods that have been subjected to a process sufficient to prevent the production of bacterial toxins or the survival of spore-forming pathogenic bacteria shall be distributed, maintained, stored, transported, displayed or sold or offered for sale such that the internal temperature of the food is,

- (a) 5° Celsius, or lower; or
- (b) 60° Celsius, or higher,

except for such periods of time as may be necessary for the preparation, processing and manufacturing of the food. O. Reg. 243/84, s. 33.

34. Despite clause 33 (a), eggs may be transported at an internal temperature of 13° Celsius or lower where the eggs are being transported from an egg grading station to,

- (a) a wholesaler of eggs;
- (b) a retailer of eggs; or
- (c) an egg product processing station. O. Reg. 243/84, s. 34.

35. Food that is intended to be transported, displayed, stored, sold or offered for sale in a frozen state shall be frozen to a temperature of minus 18° Celsius or lower and maintained thereafter at a temperature of minus 18° Celsius or lower until sold or prepared for use. O. Reg. 243/84, s. 35.

36.—(1) Cans, containers or wrappings of hazardous food shall bear,

- (a) a permanent code marking of the manufacturer or processor designating the plant where the food was manufactured or processed; and
- (b) the date on which the food was manufactured or an expiry date.

(2) Subsection (1) does not apply where hazardous food is packaged and sold at retail on the same food premise. O. Reg. 243/84, s. 36.

MEAT AND MEAT PRODUCTS

37. Manufactured meat products that are customarily eaten without further cooking shall be subjected to a process sufficient to destroy pathogenic bacteria, parasites and the cystic forms of parasites. O. Reg. 243/84, s. 37.

38.—(1) Every operator of a premise in which meat products are manufactured shall maintain records of meats received for processing in the premise and the records shall include the kinds of meats, the names and addresses of suppliers, weights and the dates of receipt.

(2) A record referred to in subsection (1) shall be maintained at the premise for not less than one year from the date of entry of the record. O. Reg. 243/84, s. 38.

39.—(1) Except as provided in subsections (2) and (3), every manufactured meat product that is transported, handled, distributed, displayed, stored, sold or offered for sale at a food premise shall be identified as to the meat processing plant of origin by a tag, stamp or label affixed to the product.

(2) A bulk packed manufactured meat product that cannot be individually identified under subsection (1) because of its size, shape or consistency may be removed from its container for the purpose of display or sale where the container bears the plant identification referred to in subsection (1).

(3) Subsection (1) does not apply to a manufactured meat product stored, sold or offered for sale in a retail outlet at the plant of origin. O. Reg. 243/84, s. 39.

40.—(1) A food premise that sells meat shall only have meat on the premises that has been,

- (a) obtained from an animal that has been inspected; and
- (b) stamped or labelled,

under the *Meat Inspection Act* and the regulations thereunder.

(2) Despite subsection (1), a food premise that sells meat may have uninspected meat on the premises for the purposes of custom cutting, wrapping and freezing for the owner of the uninspected meat provided that,

- (a) each quarter or larger section of the carcass bears a tag with the name and address of the owner thereon;
- (b) each quarter or larger section of the carcass is legibly stamped "Consumer Owned, Not For Sale" on each of the primal cut areas in letters not less than 1.25 centimetres in height using ink made from non-toxic edible ingredients; and
- (c) the uninspected meat is stored so as not to come into contact with meat that is for sale. O. Reg. 243/84, s. 40.

41. Where a retail food premise has custom-cut consumer owned uninspected meat, the utensils, equipment and food contact surfaces used in connection therewith shall be washed and sanitized in accordance with section 73, 74, 75, 76, 77 or 81, as the case may be, prior to their re-use on meat that has been inspected. O. Reg. 243/84, s. 41.

MILK AND MILK PRODUCTS

42.—(1) Milk products shall be pasteurized or made from milk that has been pasteurized by heating the milk product to a temperature of at least,

- (a) 63° Celsius and holding it at that temperature for not less than thirty minutes;
- (b) 72° Celsius and holding it at that temperature for not less than sixteen seconds; or
- (c) such temperature other than a temperature referred to in clause (a) or (b) for such period of time that will result in the equivalent destruction of pathogenic organisms and phosphatase.

(2) A milk product shall be sterilized by heating the milk product to a temperature of 135° Celsius and holding it at that temperature for not less than two seconds, or to such other temperature for such period of time that will result in sterilization. O. Reg. 243/84, s. 42.

43.—(1) Milk products other than butter and goat milk shall be deemed to have been pasteurized if the product is negative when tested for the presence of alkaline phosphatase as determined by the official method.

(2) A milk product shall be deemed to have been sterilized if a sample of the product is free of living organisms as determined by an official method. O. Reg. 243/84, s. 43.

44. Despite subsection 43 (1),

- (a) butter shall be deemed to have been made from pasteurized milk or cream if it is negative when tested for the presence of peroxidase as determined by an official method; and
- (b) goat milk shall be deemed to have been pasteurized if the recording thermometer chart indicates the milk was heated as required in section 42. O. Reg. 243/84, s. 44.

45. Subsection 18 (2) of the Act does not apply to cheese made from unpasteurized milk if the cheese has been stored at a temperature not lower than 2° Celsius for a period of not less than sixty days following the time of manufacture. O. Reg. 243/84, s. 45.

46.—(1) Milk products shall be cooled immediately after pasteurization to a temperature of at least 5° Celsius or less.

(2) Subsection (1) does not apply to a milk product that,

- (a) is to be further processed prior to packaging, then cooled to 5° Celsius, or less;
- (b) has been sterilized and is to be or is aseptically packaged; or
- (c) is processed by drying. O. Reg. 243/84, s. 46.

47.—(1) Every pasteurizer used for milk products shall be equipped with indicating and recording thermometers that are accurate and may be easily read. O. Reg. 243/84, s. 47 (1), *part, revised*.

(2) Every high temperature short time pasteurizer used for milk products shall be equipped with a properly functioning flow diversion valve. O. Reg. 243/84, s. 47 (1), *part, revised*.

(3) Recording thermometers shall be moisture proof and easily read. O. Reg. 243/84, s. 47.

48. The temperature of a milk product in a pasteurizer at any time shall be taken as the temperature shown on the indicating thermometer and not the temperature shown by the recording thermometer. O. Reg. 243/84, s. 48.

49. The temperature shown by the recording thermometer shall

be checked daily by the operator against the temperature shown by the indicating thermometer and shall be adjusted to read no higher than the temperature shown by the indicating thermometer. O. Reg. 243/84, s. 49.

50.—(1) A recording thermometer chart shall not be used for a period that will exceed one complete rotation of the graph.

(2) A recording thermometer chart shall have the following information noted thereon:

1. The date of operation.
2. The number of the pasteurizer, if more than one is in use, to which the recorder was attached.
3. The temperature of the indicating thermometer at some time corresponding with a marked point in the holding period.
4. The name of product being pasteurized.
5. The signature of the operator.

(3) Where more than one recording thermometer is in use, each chart shall be numbered in such a manner as to indicate the recording thermometer that was used for the chart.

(4) A recording thermometer chart shall be kept by an operator for at least three months after it is used. O. Reg. 243/84, s. 50.

51. Sterilized fluid milk products shall be sold in or from containers that bear the words "STERILIZED" or "STERILE" and "REFRIGERATE AFTER OPENING". O. Reg. 243/84, s. 51.

52.—(1) A food premise that repackages milk products not produced in that food premise, shall identify the original processor, packing date and batch number on the containers of repackaged milk products.

(2) Despite subsection (1), the operator of the food premise may show on the containers of repackaged milk products,

- (a) the operator's name and address or code marking; and
- (b) the operator's "Best Before" or repackaging date,

provided that records are maintained by the operator that identify the original processor, packing date and batch number of the milk products.

(3) Subsections (1) and (2) do not authorize the repackaging of fluid milk products. O. Reg. 243/84, s. 52.

53. Despite section 23, cases of fluid milk products may be stored directly on the floor of refrigerated rooms provided that such cases are designed for re-use and do not permit direct contact between the floor and the fluid milk container. O. Reg. 243/84, s. 53.

EGGS

54.—(1) No operator of a food premise shall store, handle, serve, process, prepare, display, distribute, transport, offer for sale or sell ungraded or Grade "C" eggs.

(2) Despite subsection (1), the operator of an egg grading station may store and handle ungraded eggs for the purpose of grading and may sell and transport Grade "C" eggs,

- (a) directly to a consumer for the consumer's own consumption;
- (b) to a food premise that retails eggs to a consumer for the consumer's own consumption; or

(c) to an egg processing station.

(3) Subsection (1) does not apply in respect of Grade "C" eggs sold in a food premise that retails eggs to a consumer only for the consumer's own consumption. O. Reg. 243/84, s. 54.

55.—(1) Each carton of Grade "C" eggs that is sold retail in a food premise shall bear the following label on the cover in letters not less than 0.31 centimetres in height:

"NOTE: CRACKED EGGS IN THIS CARTON SHOULD BE THOROUGHLY COOKED BEFORE BEING EATEN."

(2) Displays of uncartoned Grade "C" eggs in a food premise that retails foods shall bear a sign with the following statement in letters not less than 2.54 centimetres in height:

"CRACKED EGGS IN THIS DISPLAY SHOULD BE THOROUGHLY COOKED BEFORE BEING EATEN."

O. Reg. 243/84, s. 55.

MAINTENANCE

56. Furniture, equipment and appliances in any room or place where food is manufactured, stored, handled, displayed, distributed, sold or offered for sale, prepared, processed or served shall be so constructed and arranged as to permit thorough cleaning and the maintaining of the room or place in a clean and sanitary condition. O. Reg. 243/84, s. 56.

57.—(1) Garbage and wastes shall be removed from a food premise at least twice weekly or as often as is necessary to maintain the premise in a sanitary condition.

(2) Garbage receptacles in a room or place where food is manufactured, prepared, handled, processed, displayed, sold or offered for sale, served or stored shall be,

- (a) cleaned and sanitized after each use;
- (b) removed from the room when full; and
- (c) except where a daily collection service is provided, placed in a separate room or place, compartment or bin so constructed and maintained as to exclude insects and vermin and prevent odours and health hazards on the premises.

(3) All liquid waste from the operation of a food premise shall be disposed of in a sanitary manner. O. Reg. 243/84, s. 57.

58. Cooking equipment shall be,

- (a) provided with a shield, canopy or other device of corrosion-resistant, non-absorbent and readily cleanable material; or
- (b) placed so as to protect walls, ceilings and equipment from grease and food particles. O. Reg. 243/84, s. 58.

59. Every operator of a food premise shall ensure that in respect of the food premise,

- (a) the food premise is swept and cleaned in such a manner as to prevent contamination of food;
- (b) no cup, glass, dish or utensil that is chipped or cracked is used in the preparation, service or storage of food;
- (c) containers, caps, covers and wrapping materials used in the packaging of food shall be made from materials that,
 - (i) are non-toxic, and

- (ii) will prevent contamination or adulteration of the food or milk;
- (d) single-service containers and single-service articles are kept in such a manner and place as to prevent contamination of the containers or articles;
- (e) every room where food is manufactured, prepared, processed, handled, served, displayed, stored, sold or offered for sale is kept free from,
 - (i) materials and equipment not regularly used in the room, and
 - (ii) subject to section 60, live birds and animals;
- (f) dispensing scoops and dippers for ice cream, frozen confections or desserts are kept in a dipper-well with running water between servings, or in any other manner that will prevent bacterial growth;
- (g) the surface of equipment and facilities other than utensils that come in contact with food are washed and sanitized as often as is necessary to maintain such surfaces in a sanitary condition; and
- (h) the floors, walls and ceilings of every room where food is manufactured, handled, displayed, prepared, processed, served or stored, sold or offered for sale are kept clean and in good repair. O. Reg. 243/84, s. 59.

60. Subclause 59 (e) (ii) does not apply to,

- (a) a dog serving as a guide for a blind person;
- (b) live birds or animals offered for sale on food premises other than food service premises where the medical officer of health has given approval in writing for the keeping of the birds or animals on the premises; or
- (c) live aquatic species displayed or stored in sanitary tanks on food premises. O. Reg. 243/84, s. 60.

61. Table covers, napkins or serviettes used in the service of food shall be clean and in good repair and multi-service napkins and serviettes shall be laundered before each use. O. Reg. 243/84, s. 61.

62. Cloths and towels used for washing, drying or polishing utensils or cleaning tables shall be,

- (a) in good repair;
- (b) clean; and
- (c) used for no other purpose. O. Reg. 243/84, s. 62.

63. Toxic and poisonous substances required for maintenance of sanitary conditions shall be,

- (a) kept in a compartment separate from food so as to preclude contamination of any food, working surface or utensil;
- (b) kept in a container that bears a label on which the contents of the container are clearly identified; and
- (c) used only in such manner and under such conditions that the substances do not contaminate food or cause a health hazard. O. Reg. 243/84, s. 63.

PERSONNEL

64.—(1) Every food premise where an employee is required to make a complete change of outer garments at the beginning and the end of the work period shall contain dressing rooms of sufficient size for all employees to change and store their clothing.

- (2) The dressing rooms referred to in subsection (1) shall be,
 - (a) separate for males and females; and
 - (b) equipped with a locker or other facility suitable for the storing of the clothing of each employee. O. Reg. 243/84, s. 64.

65.—(1) Every operator or employee who handles or comes in contact with food or with any utensil used in the manufacture, storage, display, sale or offering for sale, preparation, processing or service of food shall,

- (a) not use tobacco while so engaged;
- (b) be clean;
- (c) wear clean outer garments;
- (d) subject to subsection (2), wear headgear that confines the hair;
- (e) wash his or her hands before commencing or resuming work and after each use of a toilet, urinal or privy;
- (f) be free from any infectious agent of a disease that may be spread through the medium of food; and
- (g) submit to such medical examinations and tests as are required by the medical officer of health to confirm the absence of an infectious agent mentioned in clause (f).

(2) Clause (1) (d) does not apply to servers, hosts, server's assistants, bartenders or other employees whose activities are usually confined to the serving of food to customers. O. Reg. 243/84, s. 65.

66. A person who has a skin disease shall not perform any work that brings him or her into contact with food unless he or she has obtained the approval of the medical officer of health in writing before handling food. O. Reg. 243/84, s. 66.

67. Every operator of a food premise shall, in respect of the food premise, ensure the availability of the clean outer garments and headgear prescribed in subsection 65 (1) and shall ensure compliance with sections 65 and 66. O. Reg. 243/84, s. 67.

PART IV SANITARY FACILITIES

GENERAL

68.—(1) Every food premise shall provide one or more sanitary facilities in accordance with this section and sections 69 and 70.

- (2) Every sanitary facility shall,
 - (a) be conveniently located and accessible to employees or patrons, as the case may be;
 - (b) have floor-to-ceiling walls and a full-length, self-closing, tight-fitting door;
 - (c) have toilet compartment partitions and doors that afford privacy for toilet use;
 - (d) have a sign clearly indicating the sex for which it is intended; and
 - (e) be kept clean, sanitary and in good repair at all times.
- (3) Every sanitary facility shall be equipped with,
 - (a) a supply of toilet paper;
 - (b) a constant supply of hot and cold running water;

- (c) a supply of soap or detergent in a dispenser;
- (d) a receptacle of durable construction that is easily cleaned for used towels and other waste material; and
- (e) a continuous cloth roller towel in a mechanical device together with a supply of paper towels, a supply of clean single-service towels or a hot air dryer.
- (4) Toilets shall be of water-flush operation with open front toilet seats.
- (5) A food premise is exempt from the provisions of clauses (3) (b), (c) and (e) and subsection (4) where water-flush toilets cannot be installed and where non-flush toilets or privies are approved for use by the medical officer of health and are,
- (a) completely separate from the food premise;
- (b) so constructed so as to protect against the entrance of insects, rodents or vermin;
- (c) equipped with full-length, self-closing doors;
- (d) constructed and located so as to prevent contamination of surface or ground water;
- (e) lighted and ventilated;
- (f) provided with commercially packaged single-use moist hand towelettes; and
- (g) provided with open front toilet seats.
- (6) Washbasins, urinals and toilets shall be cleaned and sanitized at least once in every work day and as often as is necessary to maintain them in a sanitary condition.
- (7) Access doors to sanitary facilities and toilet cubicles shall not be locked or equipped with coin or token operated unlocking devices except as provided in subsection 70 (8).
- (8) Washbasins may be equipped with a tepid water supply from a single tap.
- (9) This section does not apply to a vehicle that is used for the transporting of food or a catering vehicle. O. Reg. 243/84, s. 68.

EMPLOYEES

69.—(1) Except as provided in subsection 70 (3), every food premise shall have separate sanitary facilities for patrons and employees.

(2) Subject to subsections (4), (5) and (6), every food premise shall provide for the use of employees and the operator separate sanitary facilities for each sex with the numbers of toilets and washbasins in accordance with the following Table:

TABLE

Number of male employees or number of female employees	Number of Fixtures for each sex	
	Toilets	Washbasins
1 to 9	1	1
10 to 24	2	2
25 to 49	3	3
50 to 74	4	4
75 to 100	5	5

Add one toilet and one washbasin for each additional thirty employees of each sex, or less.

(3) In calculating the toilets and washbasins required under subsec-

tion (2), the number of employees shall be the maximum number who are normally present on the premises at one time and shall include only those who are present for more than 25 per cent of the working day.

(4) Where the total number of employees does not exceed five, the same room may be used by both sexes provided that the door to the room is capable of being locked on the inside.

(5) Urinals may be substituted for up to two-thirds of the required number of toilets.

(6) For the purpose of this section, each sixty-one centimetres of circumference of a circular washfountain or length of straight trough washbasin may be counted as one washbasin.

(7) A continuous cloth roller towel in a mechanical device together with a supply of paper towels, a supply of clean single-service towels or a hot air dryer shall be provided at all times for hand drying.

(8) Except for a food premise that was in operation before the 1st day of June, 1978 the sanitary facilities for employees required by this section shall have a minimum floor area of 2.32 square metres. O. Reg. 243/84, s. 69.

PATRONS OF FOOD SERVICE PREMISES

70.—(1) Every food service premise where food is prepared and consumed thereon shall include for the use of patrons separate sanitary facilities for each sex.

(2) A food service premise where food is served for immediate consumption thereon and that was opened to the public for the first time after the 1st day of March, 1976 or any premises that increased the size of the service after the 1st day of March, 1976 shall for the purposes of subsection (1) provide sanitary facilities in accordance with the following standards:

1. Subject to paragraphs 4 and 6, a food service premise not used primarily for the consumption of alcoholic beverages shall be provided with fixtures for the use of patrons in accordance with the following Table:

TABLE

Number of Seats	Minimum Number of Toilets for Each Sex	Minimum Number of Washbasins for Each Sex
0 to 40	1	1
41 to 140	2	1
141 to 210	3	1
211 to 270	4	2
271 to 330	5	2
331 to 390	6	3
391 to 450	7	3
451 to 550	8	4
551 to 650	9	4
651 to 750	10	5
751 to 850	11	6

i. Add one toilet for each sex for each additional 100 seats or less and one washbasin for each sex for each additional 200 seats or less.

ii. Calculate the number of seats by allotting one seat for each 1.12 square metres of usable seating area.

2. Subject to paragraphs 4 and 6, a food service premise used primarily for the consumption of alcoholic beverages shall be provided with fixtures for the use of patrons in accordance with the following Table:

TABLE

Number of Seats	Minimum Number of Toilets for Each Sex	Minimum Number of Washbasins for Each Sex
0 to 100	2	1
101 to 140	3	1
141 to 180	4	2
181 to 220	5	2
221 to 280	6	3
281 to 360	7	3
361 to 440	8	4
441 to 520	9	4

i. Add one toilet for each sex for each additional eighty seats and one washbasin for each sex for each additional 160 seats or less.

ii. Calculate the number of seats by allotting one seat for each 1.12 square metres of usable seating area.

3. Where a parking lot is operated as part of the premises and patrons are permitted to eat in vehicles parked thereon, parking spaces shall be clearly marked and each parking space shall be deemed for the purposes of paragraph 1 to be equivalent to,
 - i. two seats where employees serve food on the parking lot, or
 - ii. one seat where food service by employees is not provided on the parking lot.
4. Urinals may be substituted for up to two-thirds of the required number of toilets.
5. At least one of the toilet fixtures required for each sex under paragraphs 1 and 2 shall be suitable for use by wheelchair occupants and access doors and passages that permit the entry of a standard wheelchair shall be provided where,
 - i. the food service premise is readily accessible to wheelchair occupants, and
 - ii. the seating capacity is 141 or more,
 but where the sanitary facilities referred to in subsection (1) cannot be made accessible to wheelchair occupants, a single accessible sanitary facility for use by both sexes may be installed for wheelchair occupants only.
6. Greater or lesser numbers, as the case may be, of fixtures for each sex than those required under paragraphs 1 and 2 may be installed where there is likely to be a greater percentage of patrons of a particular sex, provided that the total number of fixtures for both sexes remains unchanged.
7. Where a sanitary facility is equipped with only one toilet and one washbasin the sanitary facility shall have a minimum floor area of 2.32 square metres.
8. For the purpose of paragraph 1 each parking space within the viewing area of a drive-in theatre where food is served shall be considered the equivalent of one seat.

(3) Despite subsection (1), a food service premise is not required to have separate sanitary facilities for patrons if it has fewer than forty seats and,

- (a) patrons are permitted to use employee sanitary facilities;
- (b) two employee's sanitary facilities one for each sex, are available;

- (c) the number of fixtures for each sex is calculated in accordance with the Table to subsection 69 (2) where the number of employees is deemed to be the sum of,
 - (i) one-half the number of patron seats, and
 - (ii) the number of employees of each sex;
- (d) access to the sanitary facilities is from within the premises; and
- (e) patrons can gain access to the sanitary facilities without passing through food preparation or storage areas.

(4) An enclosed theatre located in a permanent structure is exempt from the requirements of subsection (2) where food service is provided only from a refreshment stand or a vending machine or both.

(5) Public sanitary facilities may be used as an alternative to facilities that are part of the food service premises provided that all such public facilities are,

- (a) conveniently located with respect to the food premises;
- (b) equipped with sufficient fixtures to assure availability under normal conditions of use;
- (c) where the food service premise is operated in connection with an exhibition, fair, carnival, sports meeting or amusement park, located in the same building or on the same grounds;
- (d) clearly identified by signs; and
- (e) open when the food service premises are open.

(6) Despite clause (5) (a), except for a food service premise that provides vending machine service only, the use of public sanitary facilities as an alternative shall not be permitted where the food service premise is located in a permanent structure, opened for the first time to the public after the 31st day of March, 1976, unless such public facilities are located within forty-six metres of the food service premise by the shortest pedestrian route.

(7) A continuous cloth roller towel in a mechanical device together with a supply of paper towels, a supply of clean single-service towels or at least one hot air dryer for every two washbasins shall be provided for hand drying at all times in each sanitary facility for patrons.

(8) Cubicles for toilets in excess of the minimum number of toilets required in the Tables to paragraphs 1 and 2 of subsection (2) may be equipped with coin or token operated unlocking devices. O. Reg. 243/84, s. 70.

CLEANING AND SANITIZING OF UTENSILS

71.—(1) Multi-service articles shall be cleaned and sanitized after each use.

(2) Utensils other than multi-service articles shall be cleaned and sanitized as often as is necessary to maintain them in a clean and sanitary condition.

(3) Equipment for pasteurization, sterilization and subsequent handling of milk and milk products shall be sanitized immediately prior to use. O. Reg. 243/84, s. 71.

72.—(1) Equipment and facilities for the cleaning and sanitizing of utensils shall be used for no other purpose and shall consist of,

- (a) mechanical equipment; or
- (b) equipment for washing by hand consisting of,

- (i) a three compartment sink or three sinks, of corrosion-resistant material of sufficient size to ensure thorough cleaning and sanitizing of utensils, or
- (ii) a two-compartment sink or two sinks, of corrosion-resistant material for the cleaning and sanitizing of utensils where washing and rinsing can be done effectively in the first sink and the second sink is used for sanitizing as described in subsection 75 (1), and
- (iii) drainage racks of corrosion-resistant material.

(2) Where the sinks referred to in subclause (1) (b) (i) or (ii) are not sufficient to effectively clean and sanitize the utensils, such additional sinks as will effectively clean and sanitize the utensils are required.

(3) Subclause (1) (b) (ii) does not apply to the cleaning and sanitizing of multi-service articles. O. Reg. 243/84, s. 72.

73. Utensils shall be,

- (a) scraped or rinsed;
- (b) cleaned;
- (c) rinsed; and
- (d) sanitized. O. Reg. 243/84, s. 73.

74. Where equipment for washing by hand is used, utensils shall be,

- (a) cleaned in a sink in a detergent solution capable of removing soil;
- (b) rinsed in a second sink in clean water at a temperature not lower than 43° Celsius; and
- (c) sanitized in a third sink. O. Reg. 243/84, s. 74.

75.—(1) Utensils shall be sanitized by,

- (a) immersion in clean water at a temperature of at least 77° Celsius, or more, for at least forty-five seconds;
- (b) immersion in a clean chlorine solution of not less than 100 parts per million of available chlorine at a temperature not lower than 24° Celsius for at least forty-five seconds;
- (c) immersion in a clean quaternary ammonium compound solution of not less than 200 parts per million at a temperature not lower than 24° Celsius for at least forty-five seconds;
- (d) immersion in a clean solution containing not less than twenty-five parts per million of available iodine at a temperature not lower than 24° Celsius for at least forty-five seconds; or
- (e) immersion in any solution containing a sanitizing agent that is non-toxic and that provides a bactericidal result not less than the result provided by clause (a), (b) or (c) and for which a convenient test reagent is available.

(2) A test reagent for determining the concentration of sanitizer and an accurate thermometer to determine the temperature of the sanitizing solution shall be readily available where the sanitizing takes place. O. Reg. 243/84, s. 75.

76. Despite sections 74 and 75, utensils, other than utensils that come into direct contact with a milk product or ready to eat food, may be cleaned and sanitized in one operation provided that,

- (a) the chemical product used is designed for that purpose;
- (b) the product container bears directions for use indicating optimum temperature and exposure times;
- (c) the product is used in accordance with the directions for use;
- (d) a test reagent is readily available on the premises to determine the concentration of the sanitizing agent; and
- (e) the utensils so treated are completely rinsed with clean water. O. Reg. 243/84, s. 76.

77. Mechanical equipment shall be,

- (a) so constructed, designed and maintained that,
 - (i) the wash water is sufficiently clean at all times to clean the dishes and is maintained at a temperature not lower than 60° Celsius or higher than 71° Celsius, and
 - (ii) the sanitizing rinse is,
 - (A) water that is maintained at a temperature not lower than 82° Celsius and is applied for a minimum of ten seconds in each sanitizing cycle, or
 - (B) a chemical solution described in clause 75 (1) (b), (c), (d) or (e); and
- (b) provided with thermometers that show wash and rinse temperatures and that are so located as to be easily read. O. Reg. 243/84, s. 77.

78. A food premise is exempt from the provisions of section 77 where the medical officer of health is satisfied that the use of any other machine or device will effectively clean and sanitize utensils and result in a bacterial count on the utensils within the limit prescribed by section 80. O. Reg. 243/84, s. 78.

79. Where food processing equipment is cleaned and sanitized in place without disassembling the equipment, the operator shall ensure that instructions respecting,

- (a) the chemicals used for cleaning and sanitizing;
- (b) the strength of the chemical solutions used;
- (c) the length of time the equipment was exposed to the chemicals; and
- (d) the procedures used for cleaning and sanitizing the equipment,

are posted in a place accessible to the person carrying out the cleaning and sanitizing. O. Reg. 243/84, s. 79.

80. The standard plate count from a multi-service article shall not exceed 100 bacterial colonies after cleaning and sanitizing and prior to re-use when tested by an official method in accordance with the standard plate test, utilizing the swab technique. O. Reg. 243/84, s. 80.

81. Utensils that have been cleaned and sanitized shall be transported and stored in such a manner as to prevent contamination. O. Reg. 243/84, s. 81.

82. Where a utensil is so large as to preclude washing and sanitizing by means of sinks or other machines, it shall be washed or scrubbed with a detergent solution, rinsed with clean water and,

- (a) sprayed or rinsed with hot water or steam in a manner that

creates a temperature of not less than 82° Celsius on the treated surface; or

- (b) sprayed or rinsed with a chemical solution of a type described in subsection 76 (1) at double the strength that is set out in the product directions. O. Reg. 243/84, s. 82.

REGULATION 563

GRANTS FOR HEALTH PROMOTION PROJECTS AND INITIATIVES

1. The Minister may pay grants under section 76 of the Act for the purpose of assisting applicants to undertake health promotion projects or initiatives designed to support and enhance the ability of individuals to increase control over and improve their health. O. Reg. 479/87, s. 1.

2. The Minister may pay a grant to an applicant who,

- (a) makes an application in writing to the Minister setting out the subject-matter of the health promotion project or initiative that an applicant proposes to undertake; and
- (b) submits an estimate of the costs involved for the proposed project or initiative and the procedures and manner for executing the proposed project or initiative. O. Reg. 479/87, s. 2.

3. Where an applicant is approved by the Minister for a grant, the grant may be paid in advance or on a reimbursement of expenditure basis. O. Reg. 479/87, s. 3.

REGULATION 564

GRANTS TO BOARDS OF HEALTH

1. Except as provided in section 2, the amount of a grant that may be paid to a board of health by the Minister under section 76 of the Act shall be an amount not exceeding 75 per cent of the expenses of the board of health that have been approved by the Minister. O. Reg. 382/84, s. 1.

2. The amount of a grant that may be paid by the Minister under section 76 of the Act to the board of health of the City of Toronto, the City of Scarborough, the City of York, the City of North York, the Borough of East York and the City of Etobicoke shall be an amount not exceeding 40 per cent of the expenses of each board of health that have been approved by the Minister. O. Reg. 382/84, s. 2.

3.—(1) Despite sections 1 and 2, the Minister may pay a grant to a board of health in an amount equal to 100 per cent of the expenses approved by the Minister of the board of health in respect of a family planning program. O. Reg. 382/84, s. 3.

(2) The Minister may pay a grant to a board of health in an amount up to 100 per cent of the expenses incurred by a board of health in providing human and physical resources and facilities for training undergraduate and graduate students enrolled in a university health science program if the university enters into a written agreement with the board of health in respect of such training and the agreement is approved by the Minister. O. Reg. 636/84, s. 1.

(3) Despite sections 1 and 2, the Minister may pay a grant to a board of health in an amount equal to 100 per cent of the expenses approved by the Minister that have been incurred by the board of health in respect of an AIDS prevention and control program. O. Reg. 604/87, s. 1.

4. Despite section 2, the Minister may pay a grant to the board of

health of the City of Toronto in an amount not exceeding 75 per cent of the cost of services of the Hassle Free Clinic. O. Reg. 382/84, s. 4.

5.—(1) Despite section 1, the Minister may pay a grant to the boards of health of the Timiskaming Health Unit and the Porcupine Health Unit in an amount equal to 100 per cent of the expenses approved by the Minister of the boards of health in respect of mental health programs. O. Reg. 382/84, s. 5.

(2) Despite section 1, the Minister may pay a grant to the board of health of the Haliburton, Kawartha, Pine Ridge District Health Unit in an amount equal to 100 per cent of the expenses, approved by the Minister, of the board of health in respect of its chiropody program. O. Reg. 257/85, s. 1.

(3) Despite section 1, the Minister may pay a grant to the boards of health of the District of Algoma Health Unit, the Northwestern Health Unit, the Porcupine Health Unit, the Sudbury and District Health Unit and the Timiskaming Health Unit in an amount equal to 100 per cent of the expenses, approved by the Minister, of the board of health in respect of dental services for prevention or treatment provided to children in remote and isolated areas within the health unit of the respective boards of health. O. Reg. 354/90, s. 1.

6. In addition to a grant that is payable under section 1, the Minister may pay an unorganized area grant to a board of health that has an unorganized area within its health unit and the amount of the grant shall be equal to 100 per cent of the expenses that have been approved by the Minister and incurred by the board of health in providing services in the unorganized area. O. Reg. 382/84, s. 6.

7. It is a condition of the payment of a grant under section 1 or 2 that the board of health provide the health services and programs required under the Act, regulations or guidelines and that the board of health perform the functions required of it under the Act. O. Reg. 382/84, s. 7.

8. A grant payable under this Regulation does not include expenses incurred in the acquisition of real estate. O. Reg. 382/84, s. 8.

9.—(1) Despite section 1, the Minister may pay grants to a board of health in an amount equal to 100 per cent of the expenses incurred in providing the dental treatment services set out in the Schedule to eligible children.

(2) For the purposes of subsection (1), a child is an eligible child if,

- (a) the child is in kindergarten or in any of grades 1 to 8, inclusive;
- (b) the parents or guardians of the child have no insurance or other form of coverage in respect of the services set out in the Schedule;
- (c) the parents or guardians of the child make a declaration that the cost for dental treatment services would constitute financial hardship;
- (d) the child has been assessed by a dentist or dental hygienist under a program established under Regulation 570 of Revised Regulations of Ontario, 1990 (School Health Services and Programs) as requiring immediate or urgent dental care for conditions causing pain, infection, haemorrhage, trauma or pathology or conditions that would imminently lead to pain or infection; and
- (e) in the case of the dental services set out in Part 2 of the Schedule, the dental director for the board of health determines that the services are necessary.

(3) Despite subsection (2), a child is not an eligible child if the child,

- (a) is a recipient as defined in section 1 of the *General Welfare Assistance Act* or is a dependant as defined in subsection 1 (1) of Regulation 537 of Revised Regulations of Ontario, 1990 (General);
- (b) is a beneficiary as defined in subsection 1 (1) of the *Family Benefits Act* and who is entitled to dental services under an agreement between the Crown in right of Ontario and the Ontario Dental Association under section 22 of Regulation 366 of Revised Regulations of Ontario, 1990 (General); or
- (c) is receiving residential services from a service provider under the *Child and Family Services Act* and the service provider makes dental care available for the child.
- (4) Nothing in this section prevents a board of health from providing the services set out in the Schedule to a child referred to in subsection (3) on behalf of the Ministry of Community and Social Services.
- (5) The payment of a grant is subject to the following conditions:
- I. The board of health shall ensure that the dental services set out in the Schedule are made available to an eligible child as described in subsection (2).
 2. The board of health shall issue a form authorizing work to be done, which form is valid for a six month period from the date of the issuance of the form.
 3. The dental work authorized by a board of health shall be carried out by a dentist who is the holder of a licence to practise dentistry under Part II of the *Health Disciplines Act* and who,
 - i. has agreed to charge not more than the amounts set out in the Schedule,
 - ii. has agreed to seek payment only from the board of health and not from the parents or guardian of the child,
 - iii. has agreed to follow the directives set out in the Schedule, and
 - iv. submits to the board of health a completed claim form for the payment of services performed.
- O. Reg. 515/87, s. 1.

Schedule

PART I

PROCEDURE CODE	SERVICE	FEE
	DIAGNOSTIC SERVICES	
	COMPLETE ORAL EXAMINATION	
	(a) History, medical and dental	
	(b) Clinical examination of hard and soft tissues including carious lesions, missing teeth, determination of pocket depth and location of periodontal pockets, gingival contours, mobility of teeth, interproximal tooth contact relationships, occlusion of teeth, pulp vitality tests where necessary and any other pertinent factors.	
	EXAMINATIONS	
	Please note that procedure code 01300 (Emer. Exam.) is the only one that will be covered for oral and maxillofacial surgeons.	
01110	Primary Dentition Clinical oral examination as above	28.05
01120	Mixed Dentition Clinical oral examination as above	42.08
01130	Permanent Dentition Clinical oral examination as above	56.10
01200	Recall Oral Examination Examination of hard and soft tissues including checking of occlusion and appliances. (Radiographs at a separate fee and code)	14.03
01300	Emergency Examination Examination for any of the following in a specific area; caries, periodontal disease, orthodontic status, or any other pertinent factor OR	14.03
01400	Specific Oral Area Examination of any of the following in a specific area; caries, periodontal disease, orthodontic status, or any other pertinent factor	14.03
	RADIOGRAPHS (Radiographic examination and interpretation)	
	INTRAORAL FILMS (only five periapical films or 02600 authorized in any twelve month period)	
02111	Single periapical film	9.85
02112	Two periapical films	12.53
02113	Three periapical films	14.32
02114	Four periapical films	16.11

PART I—Continued

PROCEDURE CODE	SERVICE	FEE
02115	Five periapical films (Only two posterior bitewing films are authorized every six months)	18.80
02141	X-ray Bitewing — single film	9.85
02142	Bitewings — two films	12.53
	EXTRAORAL FILMS	
02600	Panoramic film in place of 5 periapical films.	18.80
	PREVENTIVE SERVICES	
13600	Caries/trauma/pain control (removal of carious lesions or existing restorations and placement of sedative/protective dressings). <i>Include surface code.</i> (Note 13600 — 7 days must elapse before placement of final restoration)	23.38
13401	pit and fissure sealants — first tooth (first and second permanent molars only).	12.07
13404	each additional tooth in the same quadrant (first and second permanent molars only).	6.47
	RESTORATIVE SERVICES	
	Note 1 — Authorized once every six months. No surface can be paid more than once in a six month period.	
	Note 2 — Where, at the same sitting, in order to conserve tooth structure, two separate restorations are performed on the same tooth involving a common surface, this should be considered as one restoration when assessing the fee.	
	Note 3 — In order to be paid for restorations you must include the proper procedure code, international tooth code and the names of the surfaces restored.	
	Note 4 — For supernumerary tooth, please use tooth code “99”. Quadrants — there are four quadrants (i.e. maxillary and mandibular, right and left, midline to the most posterior tooth) and the maxillary and mandibular anterior segments (i.e. from maxillary cuspid to cuspid, mandibular cuspid to cuspid). Fee adjustments may be considered when certain repeated or multiple services reduce the time factor.	
	AMALGAM, PREFORMED STAINLESS STEEL AND POLYCARBONATE RESTORATIONS	
	(a) Crucial Primary teeth — excluding incisors after age 5 and molars after age 9 (see Part 2) (maximum allowance per tooth is the fee for four surfaces and 2.0 units of time).	
21101	Amalgam — one surface	18.70
21102	Amalgam — two surfaces	40.90
21103	Amalgam — three surfaces	46.75
21104	Amalgam — four surfaces	56.10
21105	Amalgam — five surfaces	56.10
	(b) Permanent anterior and bicuspid teeth (maximum allowance per tooth is the fee for 4 surfaces and 2.0 units of time).	
21211	Amalgam — one surface	18.70
21212	Amalgam — two surfaces	40.90
21213	Amalgam — three surfaces	46.75
21214	Amalgam — four surfaces	56.10
21215	Amalgam — five surfaces	56.10
	(c) Permanent molar teeth (maximum allowance per tooth is the fee for 4 surfaces and 2.0 units of time).	
21221	Amalgam — one surface	23.28
21222	Amalgam — two surfaces	46.75
21223	Amalgam — three surfaces	58.44
21224	Amalgam — four surfaces	67.85
21225	Amalgam — five surfaces	67.85
	FULL COVERAGE RESTORATIONS	
	The fee for crowns includes any necessary preparation.	
21403	Prefomed stainless steel — primary posterior tooth	70.13
21413	Prefomed stainless steel — permanent posterior tooth	70.13
21421	Prefomed polycarbonate crown — primary anterior tooth	70.13
	COMPOSITE RESTORATIONS	
	(maximum allowance per tooth is the fee for a Class IV).	
23101	*Class I and V *See note 1 under RESTORATIVE SERVICES	28.05

PART I—Continued

PROCEDURE CODE	SERVICE	FEE
23102	Class III	37.40
23103	Class IV	58.44
	Composite Restorations Acid Etch Technique (maximum allowance per tooth is the fee for double Class IV)	
23111	*composite, acid etch technique — Class I or V *See note 1 under RESTORATIVE SERVICES	37.40
23112	composite, acid etch technique — Class III	46.75
23113	composite, acid etch technique — Class IV	70.13
23114	composite, acid etch technique — double Class IV (involving mesial, incisal and distal)	93.50
	Composite Restorations (bicuspid teeth only) (maximum allowance per tooth is the fee for four surfaces)	
23201	Posteriors, one surface composite	28.05
23202	Posteriors, two surfaces, composite	40.90
23203	Posteriors, three surfaces, composite	46.75
23204	Posteriors, four surfaces, composite	56.10
	Composite Restorations Acid Etch Techniques (bicuspid teeth only) (maximum allowance per tooth is the fee for four surfaces)	
	OTHER RESTORATIVE SURFACES	
23221	Posteriors, one surface, composite, acid etch technique	37.40
23222	Posteriors, two surfaces, composite acid etch technique	52.60
23223	Posteriors, three surfaces, composite acid etch technique	58.44
23224	Posteriors, four surfaces, composite acid etch technique	93.50
29100	Recement inlays or crowns	23.38 + L
29300	Removal of crown or inlay	28.05
	ENDODONTIC SERVICES	
	PULPOTOMY	
32211	Vital pulpotomy — primary tooth	23.34
	ROOT CANAL THERAPY Includes treatment plan, clinical procedures with appropriate radiographs, follow-up care, but excluding final restoration.	
	Notes	
	1. Clinical procedures are shown following each coded service to facilitate determination of fee for treatment. They should not be itemized on the claim form.	
	2. Where clinical procedures must be REPEATED this should be noted.	
	3. Only one of 33100 to 33503 per tooth allowed.	
	4. Fee must be modified if one, or more, procedures are eliminated or modified.	
	5. Submit on claim form at <i>COMPLETION</i> of therapy.	
	6. If, because of extenuating circumstances, treatment is only partially completed, submit a partial billing and provide details in the "For Dentist's Use only" section of the claim form.	
33100	One canal, fully developed root Pulpectomy — one canal, fully developed root Biomechanical preparation, one canal, fully developed root Chemotherapeutic treatment or root canal Obturation, one canal, fully developed root	187.00
33120	One canal, partially developed root Pulpectomy, one canal, partially developed root Biomechanical preparation, one canal, partially developed root Chemotherapeutic treatment, one canal, partially developed root Obturation, one canal, partially developed root	252.45

PART I—Continued

PROCEDURE CODE	SERVICE	FEE
33200	Two canals, fully developed roots Pulpectomy, two canals Biomechanical preparation, two canals Chemotherapeutic treatment, two canals Obturation, two canals	233.75
33220	Two canals, partially developed roots Pulpectomy, two canals, partially developed roots, Biomechanical preparation, two canals, partially developed roots Chemotherapeutic treatment, two canals, partially developed roots Obturation, two canals, partially developed roots	336.60
33300	Three canals, fully developed roots Pulpectomy, three canals Biomechanical preparation, three canals Chemotherapeutic treatment, three canals Obturation, three canals	376.62
33501	Apexification — one canal Biomechanical preparation of partially developed root, one canal Chemotherapeutic treatment, one canal Obturation, one canal	168.30
33502	Apexification — two canals Biomechanical preparation of partially developed root/roots, two canals Chemotherapeutic treatment, one canal Obturation, two canals	224.40
33503	Apexification — three canals Biomechanical preparation of partially developed roots, three canals Chemotherapeutic treatment, three canals Obturation, three canals	289.71
	Note: Supernumerary tooth Please use tooth code "99"	
	TRANSITIONAL PARTIAL DENTURE (Maxillary or Mandibular)	
	Diagnostic Services	
	(a) Examination — Refer to Diagnostic Services 01000	
	(b) Radiographs — Refer to 02000 Series	
52120	*Maxillary transitional partial denture — acrylic base	93.50 + L
52121	*Mandibular transitional partial denture — acrylic base	93.50 + L
	*The terminology — temporary, provisional, thumb plate, flipper, spacer, is often used to describe a transitional partial denture. It is more commonly used to replace anterior teeth.	
	DENTURE REPAIRS	
	Diagnostic services examination — refer to Diagnostic Services 01400	
55101	Repair broken complete maxillary denture, no impression required	11.69 + L
55102	Repair broken complete mandibular denture, no impression required	11.69 + L
55103	Repair broken partial maxillary denture, no impression required	11.69 + L
55104	Repair broken partial mandibular denture, no impression required	11.69 + L
55201	Repair broken complete maxillary denture, impression required	23.38 + L
55202	Repair broken complete mandibular denture, impression required	23.38 + L
55203	Repair broken partial maxillary denture, impression required	23.38 + L
55204	Repair broken partial mandibular denture, impression required	23.38 + L
55520	Maxillary partial denture additions	46.75 + L
55530	Mandibular partial denture additions	46.75 + L
55700	Denture prophylaxis and polishing	9.35 + L
	SURGICAL SERVICES	
	NOTE: All surgical services are preceded by the appropriate diagnostic services.	
	Examination — Refer to Diagnostic Services 01000 Series	
	Radiographs — Refer to 02000 Series	

PART I—Continued

PROCEDURE CODE	SERVICE	FEE
	The following surgical services include necessary suturing and one post-operative treatment when required. A surgical site is considered to include a full quadrant, a segment, or a group of several teeth which can be practically and conveniently combined for a single surgical sitting. Note: Supernumerary Tooth Please Use Tooth Code "99"	
	REMOVAL OF ERUPTED TOOTH — UNCOMPLICATED	
71101	Single tooth (bone contouring included) (1st tooth in surgical site)	28.05
71111	Each additional tooth in the same surgical site	14.03
72100	Removal of each erupted tooth (complicated)	65.45
	REMOVAL OF RESIDUAL ROOTS (The fee allowance is the maximum for the multiple roots of any one tooth)	
72310	Roots with soft tissue coverage	56.10
	UNCLASSIFIED TREATMENT	
	Local Anaesthesia — not in conjunction with operative or surgical procedures — Refer to Diagnostic Services 01300, 01400	
92110	Regional block anaesthesia (not in conjunction with operative or surgical procedures)	7.16
92120	Trigeminal division block (not in conjunction with operative or surgical procedures)	8.05
	GENERAL ANAESTHESIA (Includes pre-anaesthetic evaluation and post-anaesthetic follow-up) The elimination of all sensations, accompanied by the loss of consciousness. Also included is "dissociative" anaesthesia (Ketamine)	
92201	General anaesthesia — first unit of time	56.11
92202	Each additional unit of time	18.80
92215	Provision for additional office support systems required when the anaesthetic service is administered by a separate anaesthetist — per unit of time	14.32
	NEUROLEPTANALGESIA AND RELATED TECHNIQUES Profound analgesia and/or sedation including marked physical and psychic detachment which may involve intermittent periods of unconsciousness. This state is produced by the continuous or intermittent administration of competent drugs in a balanced manner. These techniques must not be confused with a conscious sedation technique.	
92251	Neuroleptanalgesia — first unit of time	51.43
92252	Each additional unit of time	17.00
	CONSCIOUS SEDATION The use of systematic drugs to produce a calm, relaxed comfortable patient without the loss of consciousness.	
92310	Conscious sedation — inhalation (nitrous oxide and oxygen) First unit of time	12.53
92311	Each additional unit of time	8.05
	PARENTERAL ADMINISTRATION	
92330	Conscious sedation — intravenous	37.40 + Dg.
92340	Conscious sedation by intramuscular injection of sedative drug	37.40 + Dg.
	DRUGS	
96100	Therapeutic intramuscular drug injection	10.74 + Dg.
96101	Therapeutic intravenous drug injection	16.11 + Dg.
	IN-OFFICE LABORATORY SERVICES	
99350	In-office laboratory charges	I.C.

PART II

	RESTORATIVE SERVICES AMALGAM, PREFORMED STAINLESS STEEL AND POLYCARBONATE RESTORATIONS — Primary incisors after age 5 and molars after age 9 (maximum allowance per tooth is the fee for 4 surfaces and 2 units of time)	
--	---	--

PART II—Continued

PROCEDURE CODE	SERVICE	FEE
21101	Amalgam — one surface	18.70
21102	Amalgam — two surfaces	40.90
21103	Amalgam — three surfaces	46.75
21104	Amalgam — four surfaces	56.10
21105	Amalgam — five surfaces	56.10
21403	Preformed stainless steel — primary posterior tooth	70.13
21421	Preformed polycarbonate crown — primary anterior tooth	70.13
	COMPOSITE RESTORATIONS (maximum allowance per tooth is the fee for a Class IV).	28.05
23101	*Class I and V *See note I under RESTORATIVE SERVICES	
23102	Class III	37.40
23103	Class IV	58.44
	Composite Restorations Acid Etch Technique (maximum allowance per tooth is the fee for double Class IV)	
23111	*composite, acid etch technique — Class I or V *See note I under RESTORATIVE SERVICES	37.40
23112	composite, acid etch technique — Class III	46.75
23113	composite, acid etch technique — Class IV	70.13
23114	composite, acid etch technique, double Class IV (involving mesial, incisal and distal)	93.50

CROWNS—SINGLE RESTORATIONS ONLY
PREAMBLE

Guidelines for Procedural Requirements

The following shall be considered necessary to constitute acceptable treatment:

- a) Removal of diseased tooth structure.
- b) Assessment of the necessity for:
 - i) provision of substitute substructure to provide sufficient retention and protection of the remaining natural tooth,
 - ii) finishing and contouring of adjacent restorations,
 - iii) correction of periodontal abnormalities related to the unit,
 - iv) correction of occlusal abnormalities in the opposing arch related to the unit.

Assessment of the necessity for (i), (ii), (iii), (iv) is to be considered part of the prosthodontic treatment. Should any of the above be required then it would be done as a separate entity with the additional fee guided by the appropriate code numbers in the suggested Fee Guide.

- c) Design and execution of tooth reduction to accommodate the dictates of the chosen restorative material and the functional requirements (occlusal and retentive).
- d) Accurate impressions of the prepared tooth, its surroundings and opposing occlusion.

- e) Accurate centric registration as a minimum in occlusal registration.
- f) Adequate provisional coverage for the treated tooth for the interim of the treatment period. Adequate coverage shall mean:
 - i) protection of the cut dentinal tubules and underlying dental pulp,
 - ii) maintenance of contact to adjacent teeth,
 - iii) maintenance of an acceptably stable functional occlusion during the construction period,
 - iv) respect for periodontal structures; i.e. the provisional restoration should provide little or no significant insult to the surrounding tissues.
- g) Shade selection where necessary.
- h) A proper written prescription for the guidance of the dental technician.
- i) Proper insertion technique which includes:
 - i) pulp protection,
 - ii) occlusal and contact adjustments,
 - iii) marginal fitting and finishing,
 - iv) a cementation technique which reflects the proper choice of cement along with care to cement under the most hygienic and optimum conditions.

j) Occlusal adjustment of the finished restoration.

PROCEDURE CODE	SERVICE	FEE
27130	Acrylic (or composite) —transitional, direct (chairside)	93.50
27140	Acrylic (or composite) —transitional, indirect	70.13 + L
27200	Porcelain	327.25 + L
27210	Porcelain fused to metal base (porcelain veneer)	327.25 + L
27300	Metal (full cast)	252.45 + L
27310	Metal (3/4)	252.45 + L
27500	Metal transitional, direct (chairside)	35.07
27700	Cast metal post and core as a separate procedure	168.30 + L
27701	Cast metal post and core as a separate procedure — 2 sections	196.35 + L
27702	Cast metal post and core as a separate procedure — 3 sections	224.40 + L
27710	Cast metal post and core concurrent with impression for a crown (when possible)	84.15 + L
27711	Cast metal post and core concurrent with impression for a crown (when possible) 2 sections	112.20 + L
27712	Cast metal post and core concurrent with impression for a crown (when possible) 3 sections	140.25 + L
27800	Metal transfer coping (thimble) as a separate procedure	93.50 + L
27810	Metal transfer coping (thimble) concurrent with impression for crown (when possible)	23.38 + L
	PREFABRICATED — precious metal posts or plastic post patterns for castings for reinforcing devitalized teeth.	
	PREFORMED — manufactured standard or stock posts that are used to reinforce devitalized teeth.	
	CAST METAL POST AND CORE — custom made castings for reinforcing devitalized teeth.	
	OTHER RESTORATIVE SERVICES	
29501	One retentive preformed post (with or without preformed core)	56.10
29502	Two retentive preformed posts	84.15
29503	Three retentive preformed posts	112.20
29511	One prefabricated metal post and cast core	112.20 + L
29512	Two prefabricated metal posts and cast cores	140.25 + L
29513	Three prefabricated metal posts and cast cores	168.30 + L
29600	Pin-reinforced amalgam post and/or core for crown restoration (materials included)	84.15
29610	Pin-reinforced composite post and/or core for crown restoration (materials included)	84.15
29700	Crown made to an existing partial denture clasp	65.45
29800	Cement restoration	18.70

PROSTHODONTIC SERVICES
Prosthodontics — Removable

PREAMBLE

1. This service is the provision of an artificial substitute for living tissue.
2. Professional skill used to provide the method of substitution is the essence of this health service, rather than the artificial component (denture).

3. There are two distinct and identifiable integral components necessary for the provision of this health service:

- (a) Physiological component — requiring professional skill,
- (b) Technical component — requiring laboratory procedures.

4. The significance of this service is in the preservation of the oral tissues supporting the artificial denture.
5. The value of this service is in the replacing of tooth function to the maximum possible range.

The following parts A and B on Clinical Procedures for Complete and Removable Partial Dentures, and the outlines for prosthetic procedures as related to the Fee Guide are designed to fulfil the principles outlined above. It will be

noted, therefore, that diagnostic services are emphasized by reference to the appropriate diagnostic procedure for each denture service being rendered.

PROCEDURE CODE	SERVICE	FEE
	<p>CLINICAL PROCEDURES FOR COMPLETE AND REMOVABLE PARTIAL DENTURE THERAPY RELATED TO THE SUGGESTED FEE GUIDE</p> <p>A. COMPLETE DENTURES</p> <p>1. DIAGNOSTIC PROCEDURES</p> <p>(a) Examination: Complete oral examination including dental and medical history, psychological considerations, visual and digital clinical examination — refer to 01000 Series</p> <p>(b) Radiographic examination — refer to 02000 Series</p> <p>2. IMPRESSIONS</p> <p>(a) Preliminary impressions</p> <p>(b) Final impressions</p> <p>3. JAW RELATION RECORDS</p> <p>(a) Vertical relations — rest and occlusal vertical dimension</p> <p>(b) Horizontal relations — centric jaw relation record</p> <p>(c) Face-bow transfer</p> <p>(d) Tooth selection — mould and shade</p> <p>4. TRY-IN</p> <p>(a) Check records — verification of centric jaw relation record and/or articular mounting.</p> <p>(b) Remount from new records (if necessary)</p> <p>(c) Evaluation and modification to anterior tooth arrangement as influenced by aesthetic and phonetic checks</p> <p>5. INSERTION</p> <p>(a) Denture base check for pressure spots and base extension</p> <p>(b) Patient instruction and delivery</p> <p>6. ADJUSTMENTS</p> <p>Includes three months post delivery care</p> <p>7. OCCLUSAL EQUILIBRATION</p> <p>Remount of dentures for occlusal equilibration</p> <p>B. PARTIAL DENTURES</p> <p>1. DIAGNOSTIC PROCEDURES</p> <p>(a) Examination: Complete oral examination including dental and medical history, psychological considerations, visual and digital clinical examination — refer to 01000 Series</p> <p>(b) Radiographic examination — refer to 02000 Series</p> <p>2. TREATMENT PLAN</p> <p>(a) Preliminary impressions (diagnostic casts)</p> <p>(b) Survey and analysis of diagnostic cast(s)</p> <p>(c) Selection of design and outline of mouth preparation on diagnostic cast(s)</p> <p>(d) Preparation of laboratory prescription</p> <p>3. MOUTH PREPARATIONS</p> <p>(a) Execution of indicated preparation procedures</p> <p>(b) Final impressions</p> <p>4. FRAMEWORK TRY-IN</p> <p>(a) Fitting of framework</p> <p>(b) Altered cast impression (if free-end extension situation)</p> <p>5. JAW RELATION RECORDS</p> <p>(a) Vertical and horizontal relations</p> <p>(b) Face-bow transfer (if necessary)</p> <p>(c) Selection of teeth — mould and shade</p> <p>6. TRY-IN EVALUATION</p> <p>(a) Check records (remount if necessary)</p> <p>(b) Evaluation and modification to tooth arrangement</p>	

PROCEDURE CODE	SERVICE	FEE
	<p>7. INSERTION (a) Framework/denture base check for pressure spots and base extension (b) Patient instruction and delivery</p> <p>8. ADJUSTMENTS Includes three months post delivery care</p> <p>9. OCCLUSAL EQUILIBRATION Remount of denture for occlusal equilibration</p> <p>This outline lists the treatment procedures in the provision of removable prosthesis.</p> <p>OVERDENTURES Refer to appropriate codes for denture services plus such other services and codes as may be necessary for preservation of the alveolar ridge.</p>	
51100	<p>COMPLETE MAXILLARY DENTURE</p> <p>1. Diagnostic Services (a) Examination — Refer to Diagnostic Services 01000 Series (b) Radiographs — Refer to 02000 Series</p> <p>2. Impressions</p> <p>3. Jaw relation records</p> <p>4. Try-in evaluation and check records</p> <p>5. Insertion</p> <p>6. Adjustments (includes three months post insertion care)</p>	308.55 + L
51110	<p>COMPLETE MANDIBULAR DENTURE</p> <p>1. Diagnostic Services (a) Examination — Refer to Diagnostic Services 01000 Series (b) Radiographs — Refer to 02000 Series</p> <p>2. Impression — initial and final</p> <p>3. Jaw relation records</p> <p>4. Try-in evaluation and check records</p> <p>5. Insertion</p> <p>6. Adjustments (includes three months post insertion care)</p>	392.71 + L
51120	<p>COMPLETE MAXILLARY AND MANDIBULAR DENTURES</p> <p>1. Diagnostic Services (a) Examination — Refer to Diagnostic Services 01000 Series (b) Radiographs — Refer to 02000 Series</p> <p>2. Impressions — initial and final</p> <p>3. Jaw relation records</p> <p>4. Try-in evaluation and check records</p> <p>5. Insertion</p> <p>6. Adjustments (includes three months post insertion care)</p>	504.91 + L
51300	Immediate complete maxillary denture (including three months post insertion care, including tissue conditioners but does not include permanent relines)	364.65 + L
51310	Immediate complete mandibular denture (including three months post insertion care, including tissue conditioners but does not include permanent relines)	448.81 + L
51320	Immediate complete maxillary and mandibular dentures (including three months post insertion care, including tissue conditioner but does not include permanent relines)	561.01 + L
51600	Transitional (temporary) complete maxillary denture	140.25 + L
51610	Transitional (temporary) complete mandibular denture	187.00 + L
51620	Transitional (temporary) complete maxillary and mandibular dentures.	233.75 + L
	<p>REMOVABLE PARTIAL DENTURE (Maxillary or Mandibular)</p> <p>Diagnostic Services (a) Examination — Refer to Diagnostic Services 01000 Series (b) Radiographs — Refer to 02000 Series</p>	
52220	Maxillary, acrylic base — with or without wrought clasps	140.25 + L
52221	Mandibular, acrylic base — with or without wrought clasps	140.25 + L
52230	Maxillary, acrylic base — with gold or chrome clasps with rests	224.40 + L

PROCEDURE CODE	SERVICE	FEE
52231	Mandibular, acrylic base — with gold or chrome clasps with rests	224.40 + L
52320	Maxillary, wrought bar (palatal) with rests and clasps	224.40 + L
52321	Mandibular, wrought bar (lingual) with rests and clasps	224.40 + L
CAST CHROME COBALT (OR GOLD)		
52400	Maxillary with chrome cobalt palatal connector, rests, clasps and acrylic base (free-end RPD)	392.71 + L
52410	Mandibular with chrome cobalt lingual or labial connectors, rests, clasps and acrylic base (free-end RPD)	392.71 + L
52500	Maxillary with palatal connector, rests, clasps and cast chrome cobalt base (tooth-borne)	364.65 + L
52510	Mandibular with lingual connector, rests, clasps and cast chrome cobalt base (tooth-borne)	364.65 + L
52520	Maxillary and Mandibular RPD	532.96 + L
52525	For each altered cast impression technique when done in conjunction with Codes 52520, 52400, 52410, add	56.10 + L
52530	Maxillary complete denture with mandibular removable partial denture — case chrome cobalt lingual connector, rests clasps and acrylic base	532.96 + L
52531	Mandibular complete denture with maxillary removable partial denture — cast chrome cobalt palatal connector, rests, clasps and acrylic base	532.96 + L
52535	For altered cast impression technique when done in conjunction with Codes 52530, 52531, add	56.10 + L

**PROSTHODONTIC SERVICES
PROSTHODONTICS — FIXED**

PREAMBLE

A. AIMS OF FIXED PROSTHODONTIC SERVICES

- 1.) The restoration of diseased or missing teeth or parts of teeth.
- 2.) The maintenance of the restored teeth and their surrounding supporting structures in a normal healthy condition for as long a time as possible.
- 3.) The prevention of further injury to the restored teeth.
- 4.) The correction of abnormal oral conditions whether they be cosmetic, functional (occlusal) and/or periodontal (as in periodontal prosthetics).

B. EXTENSIVE OR COMPLICATED RESTORATIVE DENTISTRY

In order to qualify as "extensive or complicated restorative dentistry" a restorative treatment plan should include or encompass some or all of the following considerations:

- 1.) Multiple units in opposing quadrants.
- 2.) Major changes in the occlusal plane.
- 3.) The opening or closing of vertical dimension with fixed restorations.
- 4.) Repositioning of the mandible; i.e. a correction of the acquired occlusion to centric relation by means of fixed restorations.
- 5.) Bridgework of three abutments or more which begins in one posterior quadrant and ends in the anterior segment or in the opposite posterior quadrant.
- 6.) Development of major changes in incisal guidance.
- 7.) Development of major changes in occlusal morphology.

- 8.) Extensive splinting of mobile teeth.

- 9.) Major restorative dentistry for treatment of temporomandibular joint and myo-facial pain syndrome.

C. GUIDELINES FOR PROCEDURAL REQUIREMENTS FOR FIXED PROSTHODONTIC SERVICES

- 1.) Procedural requirements for three to four unit fixed prosthesis and multiple adjacent units.

The following requirements shall be considered necessary to constitute acceptable treatment:

- a) The same requirements as those for a single unit (refer to CROWNS — Preamble) with the addition of:
- b) Centric and eccentric occlusal records and the programming of a semi-adjustable articulator or the use of a functionally generated path technique.
- c) Abutment design, preparation and retainer construction in a manner compensating for the additional stress on the prosthesis.
- d) Paralleling of the abutments or the judicious use of broken stress principles when necessary. (Broken stress techniques may have to be at an additional fee).
- e) Assessment of the necessity for:
 - i) occlusal correction of a total quadrant or total mouth occlusal correction as opposed to correction of one or two opposing teeth as in the single unit,
 - ii) correction of tissue around all abutments and ridge area for proper pontic design,
 - iii) complete mouth periodontal treatment.
- f) Design of pontics and the total prosthesis to provide sufficient strength to resist moments of bending and to provide acceptable cosmetic appearance, function and protection of the surrounding tissues.

g) Provisional restoration in accordance with requirements for single restorations and in addition, the requirement to maintain abutment relationships through the provision of pontics and the restoration of proximal contact.

h) Diagnostic casts, refer to Codes 04510 or 04520.

i) Complete series periapical films — refer to Code 02100.

PROCEDURE CODE	SERVICE	FEE
	PONTICS	
62500	Porcelain fused to metal pontic	161.98 + L
	RETAINERS	
65500	Metal overlay acid etch bonded — per abutment tooth — (pontics extra) (Maryland, Rochette or others)	70.13 + L
	SURGICAL REMOVALS	
	NOTE: An impacted tooth is one which is prevented from its normal path of eruption by hard tissue (tooth or bone).	
	First tooth in surgical site — Full Fee. Each additional tooth will be paid at reduced fee (as 71111). If surgical service on a deciduous tooth is required please give an explanation on the claim form.	
72210	Impaction that requires incision of overlying soft tissue and the removal of the tooth.	65.45
72220	Impaction that requires incision of overlying soft tissue, elevation of a flap and EITHER removal of bone and tooth OR selecting and removal of tooth.	98.18
72230	Impaction that requires incision of overlying soft tissue, elevation of a flap, removal of bone AND sectioning of tooth for removal.	130.90
72240	Impaction that requires incision of overlying soft tissue, elevation of flap, removal of bone, sectioning of the tooth for removal AND/OR presents unusual difficulties and circumstances.	149.60
72320	Roots with bone tissue coverage.	65.45

O. Reg. 515/87, s. 2.

REGULATION 565

PUBLIC POOLS

DEFINITIONS

1. In this Regulation,

“apartment building” means a building that is divided into multiple dwelling units or suites whether leased or not but does not include a condominium, co-operative or commune property;

“assistant lifeguard” means a person designated by the owner or operator to assist a lifeguard to supervise bather safety;

“bather” means a person dressed for bathing;

“campground” means land or premises used as an overnight camping facility other than a recreational camp;

“clean water” means water added to a public pool after treatment in the pool recirculation system;

“club” means an organization that operates facilities for the use of its members and their guests;

“day camp” means a camp or resort that admits persons for temporary custody for a continuous period not exceeding twenty-four hours;

“day nursery” means a day nursery as defined in the *Day Nurseries Act*;

“deck” means the area immediately surrounding a public pool;

“diving board” means a flexible board and “board” has a corresponding meaning;

“diving platform” means a rigid platform and “platform” has a corresponding meaning;

“general area” means an area adjacent to the deck within a pool enclosure that is used for activities other than bathing;

“guest” means a person who contracts for sleeping accommodation in a hotel and includes each member of the person’s party;

“hotel” means a hotel, inn, motel, resort or other building or premises operated to provide sleeping accommodation for the public;

“lifeguard” means a person appointed by the owner or operator to maintain surveillance over the bathers while they are on the deck or in the pool and to supervise bather safety;

“make-up water” means water added to a public pool from an external source;

“mobile home park” means land or premises maintained to provide a temporary or permanent location for mobile homes;

“modified pool” means a public pool that has the form of a basin-shaped depression in the earth, the floor of which slopes downward and inward toward the centre from the rim;

“operator” means a person designated by the owner of a public pool as being responsible for the operation of the pool;

“owner” means a person who is the owner of a public pool;

“recirculation system” means a system that,

- (a) maintains circulation of water through a pool by pumps,
- (b) draws water from a pool for treatment and returns it to the pool as clean water, and
- (c) provides continuous treatment that includes filtration and chlorination or bromination and other processes that may be necessary for the treatment of the water;

“recreational camp” means a recreational camp within the meaning of Regulation 568 of Revised Regulations of Ontario, 1990;

“wave action pool” means a public pool that is provided with a means for inducing wave motion in the water. O. Reg. 381/84, s. 1.

CLASSIFICATION OF PUBLIC POOLS

2. The following classes of public pools are established:

1. “Class A pool” being,
 - i. a pool to which the general public is admitted,
 - ii. a pool operated in conjunction with or as a part of the program of a Young Men’s Christian Association or similar institution or an educational, instructional, physical fitness or athletic institution supported in whole or in part by public funds or public subscription, or
 - iii. a pool operated on the premises of a recreational camp, for use by campers and their visitors and camp personnel.
2. “Class B pool” being,
 - i. a pool operated on the premises of an apartment building that contains more than five dwelling units or suites, a mobile home park or a nurses’ residence, for the use of the occupants and their visitors,
 - ii. a pool operated as a facility to serve a community of more than five single-family private residences, for the use of the residents and their visitors,
 - iii. a pool operated on the premises of a hotel, for the use of its guests and their visitors,
 - iv. a pool operated on the premises of a campground, for the use of its tenants and their visitors,
 - v. a pool operated in conjunction with,
 - A. a club, for the use of its members and their visitors, or
 - B. a condominium, co-operative or commune property that contains more than five dwelling units or suites, for the use of the owners or members and their visitors,
 - vi. a pool operated in conjunction with a day nursery, a day camp or an establishment or institution for the care or treatment of persons who are ill, infirm or aged or for persons in custodial care, for the use of such persons and their visitors, or
 - vii. a pool other than a Class A pool, that is not exempt from the provisions of this Regulation. O. Reg. 381/84, s. 2.

3. The following public pools are exempt from this Regulation:

1. Pools used by the occupants and their visitors of an apartment building, condominium or co-operative or commune property that contains five or fewer dwelling units or suites.
 2. Pools used by members of a community of five or fewer single-family private residences.
 3. Pools having a water depth of 0.75 metre or less.
 4. Hydro-massage pools.
 5. Pools that serve solely as receiving basins for persons at the bottom of water slides. O. Reg. 381/84, s. 3.
4. This Regulation applies to public pools and all buildings, appurtenances and equipment used in the operation of public pools. O. Reg. 381/84, s. 4.

PART I

5.—(1) Before a public pool is put into use after construction or alteration, the owner or the owner’s agent shall notify, in writing, the medical officer of health in the health unit where the pool is situate,

- (a) of the building permit number issued for the construction or alteration of the pool;
- (b) whether or not all the preparations necessary to operate the pool in accordance with this Regulation have been completed;
- (c) of the date that the pool is to be opened for use;
- (d) whether the pool is intended to be operated as a Class A or a Class B pool; and
- (e) of the name and address of the operator. O. Reg. 381/84, s. 5 (1); O. Reg. 569/88, s. 1 (1).

(2) A person who proposes to open or reopen a pool for use as a public pool after construction or alteration shall not open or reopen the pool without first obtaining,

- (a) permission in writing from the medical officer of health; and
- (b) a supply of chemicals and testing devices that are sufficient to operate the pool. O. Reg. 381/84, s. 5 (2).

(3) Every owner and every operator shall, after any closure of the pool for more than four weeks duration and where the owner or operator intends to re-open the pool, notify in writing the medical officer of health in the health unit where the pool is situate,

- (a) of the date that the pool is to be re-opened;
- (b) of the name and address of the operator; and
- (c) whether the pool is intended to be operated as a Class A or a Class B pool. O. Reg. 569/88, s. 1 (2).

OPERATION

6.—(1) Every owner shall designate an operator. O. Reg. 381/84, s. 6 (1).

- (2) Every owner and every operator shall,
 - (a) maintain the public pool and its equipment in a safe and sanitary condition;
 - (b) ensure that during periods when the pool is not intended to be open for use it is rendered inaccessible to persons who are not involved with its operation or maintenance;

(c) except for stoppage for maintenance, repairs or backwashing of filters or for a closure for a continuous period of seven days or more, ensure that the recirculation system and the chemical feeders are in continuous operation throughout the entire twenty-four hours of each day without regard to the duration of actual use of the pool each day; and

(d) ensure that,

(i) in a Class A pool that was constructed after the 30th day of April, 1974, a volume of water not less than four times the total capacity of the pool is filtered, disinfected and passed through the pool each day,

(ii) in a Class A pool that was constructed before the 1st day of May, 1974 and in a Class B pool, a volume of water not less than three times the total capacity of the pool is filtered, disinfected and passed through the pool each day, and

(iii) in a wave action pool, a volume of water not less than six times the total capacity of the pool is filtered, disinfected and passed through the pool each day. O. Reg. 381/84, s. 6 (2); O. Reg. 569/88, s. 2 (1).

(3) Despite paragraph 1 of section 2, a Class A pool may be operated as a Class B pool during periods when the pool is open solely for the uses stated in subparagraphs i to vi of paragraph 2 of section 2. O. Reg. 381/84, s. 6 (3).

(4) Every owner and every operator shall ensure that,

(a) all components of the recirculation system of the pool are maintained in proper working order;

(b) all surfaces of the pool deck and walls are maintained in a sanitary condition and free from hazards;

(c) where changing rooms, toilets and shower facilities are provided for the pool, they are available for use of the bathers before entering the deck;

(d) the submerged surfaces of the pool are white or light in colour, except for markings for safety or competition purposes;

(e) the pool deck is clearly delineated by markings or other means from the general area where a general area is provided;

(f) the perimeter drain of the pool is kept free of debris;

(g) at least 15 per cent of the total pool water volume is capable of being withdrawn from the gutter or skimmer lines daily and discharged to waste drains;

(h) provisions are made for the safe storage and handling of all chemicals required in the pool operation;

(i) where footsprays are provided for the pool they are maintained in good working order and are kept sanitary;

(j) where the pool is equipped with a diving board or diving platform, the board or platform has a non-slip surface finish;

(k) where the pool is a wave action pool, bathers do not have access to the electrical and mechanical equipment, chemicals and chemical feeders required for the operation of the pool;

(l) a black disc 150 millimetres in diameter on a white back-

ground is affixed to the bottom of the pool at its deepest point;

(m) where the pool has one or more ramps that are not submerged and that are adjacent to the pool wall and that are used for access to the water, the pool is provided with a removable barrier that separates the deck from the ramp;

(n) where the pool has one or more ramps that are submerged, that are adjacent to the pool wall and that are used for access to the water, the pool is provided with a removable barrier that separates the walkway from the deck; and

(o) exposed piping within the pool enclosure, inside the structure of the pool and inside appurtenant structures to the pool are identified by,

(i) colour coding with coloured bands at least twenty-five millimetres wide spaced along the piping at intervals not greater than 1.20 metres, or

(ii) painting the entire outer surface of the piping,

in accordance with the following code:

chlorine —yellow

potable water —green

(5) Clause (4) (g) does not apply to a Class A pool that was constructed before the 7th day of June, 1965.

(6) Clause (4) (g) does not apply to a Class B pool that was constructed before the 1st day of May, 1974. O. Reg. 569/88, s. 2 (2).

7.—(1) Every owner and every operator shall ensure that the clean water and the make-up water are free from contamination that may be injurious to the health of the bathers. O. Reg. 381/84, s. 7 (1).

(2) Every owner and every operator shall ensure that the pool water and its recirculation system is separate from the make-up water supply and from the sewer or drainage system into which the make-up water drains. O. Reg. 569/88, s. 3 (1).

(3) Every owner and every operator shall ensure that the pool water is maintained free from visible matter that may be hazardous to the health or safety of the bathers.

(4) Every owner and every operator, other than an owner and operator of a modified pool or a wave action pool, shall ensure that the pool water is of a clarity to permit a black disc 150 millimetres in diameter on a white background located on the bottom of the pool at its deepest point to be clearly visible from any point on the deck nine metres away from the disc.

(5) Every owner and every operator of a modified pool shall ensure that the pool water is of a clarity to permit a lifeguard occupying the control station that is least affected by reflections from the water surface to see at a distance of thirty-five metres from the control station the continuous black marking referred to in subsection 18 (3) on the bottom of the pool where the water is 1.20 metres in depth.

(6) Every owner and every operator of a wave action pool shall ensure that the pool water is of a clarity to permit a black disc 150 millimetres in diameter on a white background located on the bottom of the pool in the area of its greatest depth to be clearly visible from a point on the deck nine metres away from the disc when no waves are being induced in the pool. O. Reg. 381/84, s. 7 (2-5).

(7) Every owner and every operator shall ensure that the pool water is treated with chlorine, a chlorine compound or a bromine compound by means of an adjustable dosing device and so maintained that,

- (a) the total alkalinity is not less than eighty milligrams per litre;
 - (b) the pH value is within the range of 7.2 to 7.8;
 - (c) there is a residual of free available chlorine in every part of the pool of not less than 0.5 milligram per litre;
 - (d) where cyanurate stabilization is maintained, there is a residual of free available chlorine of not less than one milligram per litre in association with a cyanuric acid concentration of not greater than sixty milligrams per litre;
 - (e) where the pool is not a wave action pool and a bromine compound is used, there is a total bromine residual of not less than two milligrams per litre;
 - (f) where the pool is a wave action pool and a bromine compound is used, there is a total bromine residual of not less than three milligrams per litre; or
 - (g) where the medical officer of health determines that the health of the bathers may be affected, there is such higher minimum chlorine or bromine residual than required under clause (c), (d) or (e) as the medical officer of health may require in writing. O. Reg. 381/84, s. 7 (6); O. Reg. 569/88, s. 3 (2).
- (8) The method used in determining the free available chlorine residual referred to in clauses (6) (c) and (d) shall be such that chloramines or other compounds that may be present in the pool do not affect the determination.

(9) Where the addition of chemicals required to maintain the pH value and the disinfectant residual of the pool water is controlled by automatic sensing devices and the pH value and the disinfectant residual are automatically determined and displayed or continuously recorded, the operator shall at least once every day determine, by means of manual test methods, the pH value and the free available and the total chlorine residuals or the bromine residual to ensure that the automatic sensing devices continue to maintain proper control of the pH value and the disinfectant residual.

(10) Every operator shall determine and record the chlorine or bromine residual and the pH value referred to in subsection (7) one-half hour before bathers are admitted to the pool and thereafter at time intervals not exceeding two hours so long as the pool is open for use.

(11) Where cyanurate stabilization is maintained, the operator shall determine the concentration of cyanuric acid not less than once every week. O. Reg. 381/84, s. 7 (7-10).

(12) Every operator shall add make-up water to the pool during each operating day in an amount not less than twenty litres per bather as determined by a water meter installed for the purpose.

(13) Every owner and every operator shall ensure that a water meter is provided that registers the volume of all make-up water that is added to the pool. O. Reg. 569/88, s. 3 (3).

8. Every operator shall keep and sign daily records that shall set out,

- (a) the free available chlorine and the total chlorine residuals in the pool water or where a bromine compound is used, the total bromine residual;
- (b) the pH value of the pool water;
- (c) the total number of bathers admitted to the pool each day;
- (d) the reading of the make-up water meter;

- (e) any emergencies, rescues or breakdowns of equipment that have occurred; and
- (f) the time of day that the actions required under subsection 16 (2) have been taken. O. Reg. 381/84, s. 8.

9. A record required to be kept under section 8 shall be retained for a period of one year from the date of making the record. O. Reg. 381/84, s. 9.

10.—(1) Every owner and every operator, other than an owner and operator of a wave action pool, shall ensure that the total number of bathers permitted at any instant on the deck and in the pool does not exceed the maximum bather load as determined by the following formula:

$$\text{maximum bather load} = \frac{D}{2.5} + \frac{S}{1.4}$$

where D = the area in square metres of the part of the pool that is deeper than 1.35 metres; and

S = the area in square metres of the part of the pool that is 1.35 metres in depth or shallower.

(2) Every owner and every operator of a wave action pool shall ensure that the total number of bathers permitted at any instant on the deck and in the pool does not exceed the maximum bather load as determined by the following formula:

$$\text{maximum bather load} = \frac{D}{2.5} + \frac{S}{1.1}$$

where D = the area in square metres of the part of the pool that is deeper than one metre when no waves are being induced; and

S = the area in square metres of the part of the pool that is one metre in depth or shallower when no waves are being induced.

(3) Benches or seats for temporary use during aquatic displays or competitive events attended by spectators may be placed on the deck to accommodate the spectators, provided that,

- (a) the spectator area and the access to it are separated from the remainder of the deck by a barrier placed not less than 0.60 metre from the edge of the pool; and
- (b) the benches or seats when not in use are stored outside the deck area.

(4) Where moveable equipment, including portable diving stands, starting platforms and swing ropes are provided for the use of the bathers, every owner and every operator shall ensure that the equipment is in place on the deck only during periods when its use is directly supervised by aquatic personnel.

(5) Every owner and every operator shall ensure that no food or beverage except water is supplied or consumed in the pool or on the deck. O. Reg. 381/84, s. 10.

11.—(1) Every owner and every operator shall ensure that the pool, the deck and, where provided, the dressing and locker rooms, toilets, showers and connecting corridors appurtenant to the pool are,

- (a) kept clean, free from slipperiness and disinfected;
- (b) free of hazardous obstructions; and
- (c) ventilated so as to remove odours.

(2) Every owner and every operator shall ensure that where toi-

lets are provided they are supplied with toilet paper. O. Reg. 381/84, s. 11.

12. Where the operator supplies bathing apparel or towels, the operator shall ensure that they are,

- (a) cleaned, disinfected and stored in a sanitary manner; and
- (b) stored separately from clean apparel and towels after each use pending removal for laundering. O. Reg. 381/84, s. 12.

13. Where a gas chlorinator is used in a public pool, the owner and the operator of the pool shall ensure that,

- (a) full-face, self-contained, air-supplied respiratory equipment is provided suitable for use in a chlorine atmosphere for a period of fifteen minutes and kept in a dust-tight cabinet located outside the area of probable contamination;
- (b) the chlorination equipment is operated by a person or persons trained in the operation of chlorination equipment;
- (c) the chlorination system automatically ceases to inject chlorine solution whenever the recirculation system ceases to supply clean water to the pool;
- (d) every chlorine cylinder on the pool premises is anchored at all times to prevent its accidental movement;
- (e) except when a chlorine cylinder is connected to the chlorinator, a chlorine cylinder valve protection hood is fitted in place on the cylinder;
- (f) a wrench for operating the chlorine cylinder valve is fitted to the valve stem of each chlorine cylinder that is connected to the chlorinator;
- (g) a platform weigh scale of not less than 135 kilograms capacity for each chlorine cylinder in use is provided; and
- (h) the operator takes all steps necessary to ensure the safety of the bathers before connecting or disconnecting a chlorine cylinder. O. Reg. 381/84, s. 13; O. Reg. 569/88, s. 4.

14. Where a diving platform greater than three metres in height above the water is provided in a public pool, the operator shall ensure that,

- (a) the gate giving access to the platform is locked except during periods when the platform is in use for diving; and
- (b) when the platform is in use, the pool is used solely for diving unless a rigid barrier or double safety lines 300 millimetres apart supported by buoys are in place, located from the wall under the platform,
 - (i) at 11.60 metres in the case of a 5-metre platform,
 - (ii) at 12.50 metres in the case of a 7.5-metre platform, and
 - (iii) at 15.25 metres, in the case of a 10-metre platform,

and activities other than diving are effectively confined to

the area of the pool outside the separated diving area. O. Reg. 381/84, s. 14.

15. Every bather shall take a cleansing shower or bath using soap and warm water before entering the deck. O. Reg. 381/84, s. 15.

SAFETY

16.—(1) Every owner and every operator shall ensure that,

- (a) where a pool is a Class A pool, an emergency telephone is provided that is easily accessible from the deck and that is directly connected to an emergency service or the local telephone utility; or
- (b) where a pool is a Class B pool, a telephone for emergency use is accessible no farther than thirty metres from the pool.

(2) Every operator shall ensure before the pool is opened for use each day that,

- (a) the test-buttons associated with the ground current leakage detecting and de-energizing devices are activated;
- (b) where a pool is a Class A pool, the emergency telephone required under clause (1) (a) is tested to confirm that the system is in operating condition; and
- (c) where a pool is a Class B pool, the telephone required under clause (1) (b) is tested to confirm that it is in operating condition. O. Reg. 381/84, s. 16 (1, 2).

(3) Every owner and every operator of a wave action pool shall ensure that,

- (a) the pool is equipped with a public address system that is in good working condition and that is clearly audible in all portions of the pool; and
- (b) the pool is equipped with a communications system that is in good working condition and that is connected to the public address system, each lifeguard station, the first-aid room and the admission control centre of the pool. O. Reg. 569/88, s. 5.

(4) Every operator of a wave action pool shall ensure the public address system is used to sound a warning sufficiently in advance of the commencement of wave activation to give bathers the option of leaving the pool. O. Reg. 381/84, s. 16 (3).

17.—(1) Every owner and every operator shall ensure that there are written emergency and operational procedures and instructions at the pool to be implemented in the event of an emergency, accident or injury in the pool and that all lifeguards and assistant lifeguards are trained in the emergency and operational procedures. O. Reg. 381/84, s. 17 (1).

(2) Subject to subsections (3), (13), (14), (15), (16), (18), (19) and (20), every owner and every operator shall ensure that where a public pool is open for use there are on duty on the deck lifeguards and assistant lifeguards trained in the emergency procedures for the pool and in such numbers that the total provided is in accordance with the following Table and the number of assistant lifeguards does not exceed the number of lifeguards:

TABLE
 MINIMUM NUMBERS OF LIFEGUARDS AND ASSISTANT LIFEGUARDS
 FOR A PUBLIC POOL WITH A WATER SURFACE AREA OF 500 SQUARE METRES OR LESS
 (OTHER THAN A WAVE ACTION POOL)

Basic Standard		Alternative Standards			
Number of bathers on the deck and in the Pool	Minimum number of lifeguards and assistant lifeguards on duty who are not certified by the National Lifeguard Service	Number of bathers on the deck and in the Pool	Minimum number of lifeguards and assistant lifeguards on duty where at least one lifeguard is certified by the National Lifeguard Service	Number of bathers on the deck and in the Pool	Minimum number of lifeguards and assistant lifeguards on duty where all are certified by the National Lifeguard Service
0 - 25	1	0 - 30	1	0 - 30	1
26 - 75	2	31 - 100	2	31 - 125	2
76 - 150	3	101 - 200	3	126 - 250	3
151 - 250	4	201 - 300	4	251 - 400	4
Greater than 250	One additional lifeguard or assistant lifeguard for each additional 100 bathers or fraction thereof	Greater than 300	One additional lifeguard or assistant lifeguard for each additional 100 bathers or fraction thereof	Greater than 400	One additional lifeguard or assistant lifeguard for each additional 150 bathers or fraction thereof

O. Reg. 146/85, s. 1 (1), *part*.

(3) Where a pool, other than a wave action pool, has a water surface area open for use that is greater than 500 square metres,

- (a) the minimum numbers of lifeguards and assistant lifeguards referred to in the Table in subsection (2) shall be increased by one; and
- (b) where there are two persons who hold the National Lifeguard Service's Lifeguard Certificate on duty, the number of bathers referred to in the Table in subsection (2) may exceed thirty but shall not exceed sixty. O. Reg. 146/85, s. 1 (1), *part*; O. Reg. 569/88, s. 6 (1).

(4) Where there is only one lifeguard on duty on the deck, every owner of a Class A pool and every operator shall ensure that there are on duty elsewhere on the premises and within call one or more additional persons sixteen years of age or over who are trained in the emergency procedures for the pool.

(5) Lifeguards and assistant lifeguards shall be so attired that they are readily identifiable. O. Reg. 381/84, s. 17 (5, 6).

(6) Every lifeguard shall,

- (a) be at least seventeen years of age;
- (b) be the holder of a current lifeguard certificate that is dated not more than two years prior to the date on which he or she is acting as a lifeguard; and
- (c) have available at the pool when on duty the certificate referred to in clause (b) or a copy thereof certified by the operator and permit the owner, the operator or a public health inspector to examine the certificate at any time. O. Reg. 381/84, s. 17 (7); O. Reg. 146/85, s. 1 (2).

(7) Every assistant lifeguard shall,

- (a) be at least sixteen years of age;
- (b) be the holder of a current assistant lifeguard certificate that is dated no more than two years prior to the date on which he or she is acting as an assistant lifeguard; and
- (c) have available at the pool when on duty the certificate referred to in clause (b) or a copy thereof certified by the operator and permit the owner, the operator or a public

health inspector to examine the certificate at any time. O. Reg. 381/84, s. 17 (8); O. Reg. 146/85, s. 1 (3).

(8) For the purpose of subsection (6), "lifeguard certificate" means,

- (a) the National Lifeguard Service's Lifeguard Certificate;
- (b) the Royal Life Saving Society Canada's Bronze Cross;
- (c) the Young Men's Christian Association's Basic Life Saver Award; or
- (d) a certificate that the Minister considers equivalent to a qualification referred to in clause (a), (b) or (c). O. Reg. 381/84, s. 17 (9); O. Reg. 146/85, s. 1 (4).

(9) For the purpose of subsection (7), "assistant lifeguard certificate" means,

- (a) the Royal Life Saving Society Canada's Bronze Medallion, Award of Merit or Award of Distinction;
- (b) the Young Men's Christian Association's Advanced Life Saver Award;
- (c) any of the awards listed under subsection (8);
- (d) a certificate that the Minister considers equivalent to a qualification referred to in clause (a), (b) or (c). O. Reg. 146/85, s. 1 (5), *part*.

(10) At least one person sixteen years of age or over on duty at every Class A pool or on the premises and within call shall be the holder of,

- (a) a National Lifeguard Service's Lifeguard Certificate that is dated not more than two years prior to the date of which he or she is on duty; or
- (b) a current first-aid certificate,

and have available on the premises when on duty the certificate or a copy thereof certified by the operator and permit the owner, the operator or a public health inspector to examine the certificate at any time. O. Reg. 146/85, s. 1 (5), *part*; O. Reg. 569/88, s. 6 (2).

(11) For the purpose of subsection (10), "current first-aid certificate" means,

- (a) the St. John Ambulance Emergency, Standard or Advanced First-aid Certificate that is dated not more than three years prior to the date on which the holder is on duty;
- (b) the Canadian Red Cross Society's Emergency, Standard or Advanced First-aid Certificate that is dated not more than three years prior to the date on which the holder is on duty;
- (c) the Royal Life Saving Society Canada's Aquatic Emergency Care Certificate that is dated not more than three years prior to the date on which the holder is on duty;
- (d) the Canadian Ski Patrol's Qualified Member or First-aid Certification prior to its date of expiry; or
- (e) a certificate that the Minister considers equivalent to a qualification referred to in clause (a), (b), (c) or (d). O. Reg. 146/85, s. 1 (5), *part*; O. Reg. 569/88, s. 6 (3).

(12) Every lifeguard on duty at a wave action pool shall be a holder of the National Lifeguard Service's Lifeguard Certificate that is dated not more than two years prior to the date on which he or she is acting as a lifeguard. O. Reg. 381/84, s. 17 (14).

(13) Every owner and every operator of a wave action pool shall ensure that where a wave action pool with a water surface area of 2,800 square metres or less is open for use, there are on duty on the deck lifeguards trained in the emergency procedures for the pool and in such numbers that the total is in accordance with the following Table:

Table

MINIMUM NUMBER OF LIFEGUARDS FOR A WAVE ACTION POOL WITH A WATER SURFACE AREA OF NOT LESS THAN 1,400 SQUARE METRES AND NOT GREATER THAN 2,800 SQUARE METRES

Number of bathers on the deck and in the pool	Minimum number of lifeguards
0 - 100	4
101 - 250	5
251 - 400	6
401 - 550	7
551 - 700	8
701 - 850	9
851 - 1000	10
Greater than 1000	11

O. Reg. 381/84, s. 17 (15); O. Reg. 146/85, s. 1 (6).

(14) Where a wave action pool has a water surface area greater than 2,800 square metres the minimum numbers of lifeguards referred to in subsection (13) shall be increased by one for every additional 280 square metres of water surface or less.

(15) Where a wave action pool has a water surface of 1,400 square metres or less, the minimum numbers of lifeguards referred to in subsection (13) may be reduced by one. O. Reg. 381/84, s. 17 (16, 17).

(16) A public pool is exempt from the safety supervision requirements of subsections (2) and (3) during a period when the pool is being used solely by one or more groups each not exceeding twenty-five in number for aquatic instruction, practice, competition or display under the direct supervision of a certified aquatic instructor or coach.

(17) For the purpose of subsection (16), every aquatic instructor and every coach shall,

- (a) be at least seventeen years of age;
- (b) be the holder of one of the following qualifications that has been issued to him or her and that is dated not more than two years prior to the date on which he or she is acting as an aquatic instructor or coach,
 1. The Canadian Red Cross Society's Leader Award or Water Safety Instructor Award.
 2. The Young Men's Christian Association's Instructor Certificate.
 3. The Royal Life Saving Society Canada's Instructor Certificate together with an assistant lifeguard certificate referred to in subsection (9).
 4. The Ontario Teachers' Aquatic Standard, where the holder is giving aquatic instruction under the auspices of a school board or board of education.
 5. Where the holder is giving underwater aquatic instruction, an instructor certificate issued by,
 - i. The National Association of Underwater Instructors,
 - ii. The Professional Association of Diving Instructors, or
 - iii. The Association of Canadian Underwater Councils.
 6. A lifeguard certificate referred to in subsection (8).
 7. A certificate that the Minister considers equivalent to a qualification referred to in paragraphs 1 to 6; and
- (c) have available at the pool when on duty the certificate referred to in clause (b) or a copy thereof that is certified by the operator and permit the owner, the operator or a public health inspector to examine the certificate at any time. O. Reg. 146/85, s. 1 (7), *part*.

(18) Where, prior to the 1st day of July, 1984, an exemption has been granted from the safety supervision requirements in respect of a pool operated on the premises of an apartment building where all the tenants and members of their families in the apartment are required to be at least sixteen years of age, the exemption shall continue provided that there is no change in the requirement regarding the minimum age of the tenants and members of their families in the apartment.

(19) A Class B pool other than a pool operated in conjunction with a day care facility or day camp that has,

- (a) a water surface area of ninety-three square metres or less is exempt from the safety supervision requirements of this section provided that the following notice that is printed in letters at least twenty-five millimetres high is displayed in a conspicuous location within the pool enclosure:

CAUTION

THIS POOL IS UNSUPERVISED. BATHERS UNDER TWELVE YEARS OF AGE ARE NOT ALLOWED WITHIN THE POOL ENCLOSURE UNLESS ACCOMPANIED BY A PARENT OR HIS OR HER AGENT WHO IS NOT LESS THAN SIXTEEN YEARS OF AGE.

or,

- (b) a water surface area greater than ninety-three square

metres and the number of bathers does not exceed ten, is exempt from the safety supervision requirements of this section provided that the following notice that is printed in letters at least twenty-five millimetres high is displayed in a conspicuous location within the pool enclosure:

CAUTION

THIS POOL IS UNSUPERVISED BATHERS UNDER TWELVE YEARS OF AGE ARE NOT ALLOWED WITHIN THE POOL ENCLOSURE UNLESS ACCOMPANIED BY A PARENT OR HIS OR HER AGENT WHO IS NOT LESS THAN SIXTEEN YEARS OF AGE. THE TOTAL NUMBER OF BATHERS ON THE DECK AND IN THE POOL SHALL NOT EXCEED TEN.

O. Reg. 381/84, s. 17 (21, 22)

(20) Where a pool is operated in conjunction with a day care facility or day camp and the water depth of the pool does not exceed 1.10 metres, a lifeguard or an assistant lifeguard may be replaced by one or more persons sixteen years of age or over where each person has satisfied the operator that he or she is a competent swimmer, is trained in the emergency procedures for the pool and is the holder of a current first-aid certificate referred to in subsection (11). O. Reg. 146/85, s. 1 (8).

18.—(1) Where a public pool is in use and a lifeguard or an assistant lifeguard determines that a safety hazard exists in the pool or on the deck, the lifeguard or assistant lifeguard shall direct all persons to leave the pool or any part thereof and shall advise the operator of the existence of the safety hazard.

(2) Every owner and every operator, other than an owner and operator of a modified pool, shall have a black disc 150 millimetres in diameter on a white background available for use in determining the clarity of the pool water.

(3) Every owner and every operator of a modified pool shall ensure that the pool is provided with continuous black markings on the bottom 150 millimetres wide where the water depth is 0.60 metre and 300 millimetres wide where the water depth is 1.20 metres.

(4) Where a public pool is open for use and the clarity of the water in the pool and the available illumination or either of them decreases to a level where the visibility standard described in subsection 7 (4), (5) or (6) is not met, the operator shall direct all bathers to leave the pool, ensure that no bather remains in the water and prevent bathers from having access to the pool until the water clarity and the available illumination or either of them has increased to a level where the conditions meet the required standard of visibility. O. Reg. 381/84, s. 18.

19. Every owner and every operator shall ensure that the following notices and markings are displayed in the places indicated herein:

1. In not fewer than two places at the pool, notices that set out,
 - i. that no person infected with a communicable disease or having open sores on his or her body shall enter the pool,
 - ii. that no person shall bring a glass container onto the deck or into the pool,
 - iii. that no person shall pollute the water in the pool in any manner and that spitting, spouting of water and blowing the nose in the pool or on the deck are prohibited,
 - iv. that no person shall engage in boisterous play in or about the pool,

- v. the maximum number of bathers permitted on the deck and in the pool at any time, and
 - vi. the location of a telephone that is available for emergency use.
2. At the entrance to each shower area and at every entrance to the deck used by bathers, notices that set out that each bather shall take a shower using warm water and soap and thoroughly rinse off all soap before entering or re-entering the deck.
 3. At the emergency telephone, a notice identifying it as the emergency telephone and listing the names, telephone numbers and addresses of persons who are available for resuscitation, medical aid and fire services or indicating the service to which it is directly connected.
 4. Where there is a permanent spectator gallery adjacent to the deck, a notice forbidding spectators from walking upon the deck within 1.80 metres of the edge of the pool.
 5. On the deck clearly marked in figures not less than 100 millimetres high, markings that set out the water depths indicating the deep points, the breaks between gentle and steep bottom slopes and the shallow points and the words DEEP AREA and SHALLOW AREA at appropriate locations.
 6. In a conspicuous location, where a pool has a maximum water depth of less than 2.50 metres, in letters not less than 150 millimetres high, the words CAUTION-AVOID DEEP DIVES or the words SHALLOW WATER—NO DIVING.
 7. At a wave action pool, on each deck adjacent to that portion of the pool where the still water depth is 2.30 metres or less, affixed to a wall or barrier supported by posts located one metre or less from the edge of the pool, notices at intervals not exceeding 7.50 metres signifying clearly that jumping or diving into the pool is not permitted in this area.
 8. At a Class B pool that is equipped with a diving board, where the end of the board is,
 - i. 600 millimetres or less in height above the water, and
 - ii. less than 9.00 metres but not less than 7.5 metres from any point having a water depth of at least 1.35 metres, in letters at least 150 millimetres high, the words DANGER—AVOID DEEP OR LONG DIVES in a location clearly visible to divers.
 9. Where a pool is provided with one or more ramps, a notice located conspicuously on each wall or fence enclosing the pool on which is printed at least 150 millimetres high the words CAUTION—NO DIVING.
 10. Where a pool is provided with one or more ramps that,
 - i. are not submerged, are adjacent to the pool wall and are used for access to the water and there is a removable barrier separating the deck from the ramp, the ramp shall bear a conspicuous notice on which is printed in letters at least twenty-five millimetres high the words UNSUPERVISED BATHERS ARE NOT ALLOWED BEYOND THIS POINT,
 - ii. are submerged, are adjacent to the pool wall and are used for access to the water and there is a removable barrier separating the walkway from the deck, the removable barrier shall bear a conspicuous notice on which is printed in letters at least twenty-five millimetres high the words BATHERS ARE NOT ALLOWED BEYOND THIS POINT. O. Reg. 381/84, s. 19; O. Reg. 569/88, s. 7.

20.—(1) Every owner and every operator, other than an owner and operator of a wave action pool, shall ensure that there are provided in places conveniently located for emergency use,

- (a) an electrically insulated or non-conducting reaching pole at least 3.65 metres long;
 - (b) two buoyant throwing aids, each of which has securely attached to it a six millimetre diameter rope of a length not less than one-half the width of the pool plus three metres;
 - (c) a spine board or device designed for transporting a person who has incurred a spinal injury; and
 - (d) a first-aid box containing at least,
 - (i) a current copy of the St. John Ambulance or the Canadian Red Cross Society First Aid Manual,
 - (ii) one dozen safety pins,
 - (iii) twenty-four adhesive dressings individually wrapped,
 - (iv) twelve sterile gauze pads, each seventy-five millimetres square,
 - (v) four rolls of fifty millimetre gauze bandage,
 - (vi) four rolls of 100 millimetre gauze bandage,
 - (vii) four sterile surgical pads suitable for pressure dressings individually wrapped,
 - (viii) six triangular bandages,
 - (ix) two rolls of splint padding, and
 - (x) one roll-up splint.
- (2) A Class A pool, other than a modified pool or a pool installed at a recreational camp, shall be equipped with,
- (a) where the pool area is greater than 150 square metres but not greater than 230 square metres, at least one control station; and
 - (b) where the pool area is greater than 230 square metres, at least two control stations.
- (3) A modified pool shall be equipped with control stations that are located along the edge of the water at intervals not exceeding sixty metres.
- (4) A wave action pool shall be equipped with two or more control stations positioned in appropriate locations on each side deck adjacent to the deep area.
- (5) A control station referred to in subsection (2), (3) or (4) shall be,
- (a) an elevated platform or chair not less than 1.80 metres above the water surface;
 - (b) securely positioned while in use and located at the side of the pool so as to permit an unobstructed view of the pool bottom in the area under surveillance; and
 - (c) restricted to the exclusive use of lifeguards and assistant lifeguards.
- (6) A wave action pool shall be provided with,
- (a) a buoyant rescue aid with a shoulder loop and a six-millime-

tre rope at least 1.60 metres in length securely attached thereto, located at each control station; and

- (b) equipment and supplies in accordance with aquatic first-aid requirements as approved jointly by the Royal Life Saving Society Canada, the Canadian Red Cross Society and St. John Ambulance. O. Reg. 381/84, s. 20.

REGULATION 566

QUALIFICATIONS OF BOARDS OF HEALTH STAFF

1.—(1) The requirements for employment as a medical officer of health or an associate medical officer of health in addition to those set out in section 64 of the Act are that the person be the holder of,

- (a) a fellowship in community medicine from The Royal College of Physicians and Surgeons of Canada;
- (b) a certificate, diploma or degree from a university in Canada that is granted after not less than one academic year of full time post graduate studies or its equivalent in public health comprising,
 - (i) epidemiology,
 - (ii) quantitative methods,
 - (iii) management and administration, and
 - (iv) disease prevention and health promotion; or
- (c) a qualification from a university outside Canada that is considered by the Minister to be equivalent to the qualifications set out in clause (b).

(2) Subsection (1) does not apply to a medical officer of health or associate medical officer of health who was employed by a board of health on the 1st day of July, 1984. O. Reg. 164/84, s. 1.

2.—(1) The requirements for engaging the services of a person in the classification of business administrator of a board of health are that the person,

- (a) be the holder of a bachelor's degree in business administration or commerce from a Canadian university and have a minimum of three years experience in business management and administration;
- (b) be the holder of a qualification issued by a university outside Canada and accepted as equivalent to the qualifications set out in clause (a) by a Canadian university; or
- (c) has knowledge and experience that the Minister considers equivalent to the requirements set out in clause (a).

(2) Subsection (1) does not apply to a person who was employed as a business administrator by a board of health on the 1st day of July, 1984. O. Reg. 164/84, s. 2.

3. The requirements for employment as a public health dentist of a board of health are that the person be the holder of a general licence to practise dentistry from the Royal College of Dental Surgeons of Ontario, and that the person,

- (a) has successfully completed a program leading to a diploma or degree in dental public health where the program consists of at least eight consecutive months of instruction from a Canadian Faculty of Dentistry or a program that the Minister considers equivalent;
- (b) be a specialist in dental public health in accordance with

subclause 36 (1) (e) (v) of Regulation 547 of Revised Regulations of Ontario, 1990; or

- (c) be a public health member or fellow of the Royal College of Dentists, Canada. O. Reg. 164/84, s. 3.

4. The requirements for employment as a dental hygienist of a board of health are that the person be registered as a dental hygienist with the Royal College of Dental Surgeons of Ontario under Regulation 546 of Revised Regulations of Ontario, 1990. O. Reg. 164/84, s. 4.

5. The requirements for employment as a public health inspector are that the person,

- (a) be the holder of a certificate granted by the Board of Certification of Public Health Inspectors of The Canadian Institute of Public Health Inspectors;
- (b) is registered as a veterinarian under the *Veterinarians Act* and is the holder of a certificate in veterinary public health or has experience that the Minister considers equivalent to such registration and certification; or
- (c) be the holder of a certificate issued prior to the 1st day of July, 1979 by The Canadian Public Health Association or by a certifying organization that is recognized by The Canadian Public Health Association. O. Reg. 164/84, s. 5

6. The "public health nursing education" prescribed for the purposes of clause 71 (3) (a) of the Act is,

- (a) a certificate or diploma obtained after not less than one academic year in public health nursing; or
- (b) a nursing degree that includes preparation in public health nursing. O. Reg. 164/84, s. 6.

7.—(1) The requirements for employment as a public health nutritionist by a board of health are that the person be the holder of a bachelor's degree from a Canadian university with a major course of study in food and nutrition or a course of study that the Minister considers equivalent and that the person,

- (a) be the holder of a master's degree from a Canadian university or a university post graduate diploma from the University of Toronto issued prior to the 31st day of December, 1979, with a major in community nutrition or public health nutrition;
- (b) be the holder of a master's degree from a Canadian university in human nutrition together with community nutrition courses or field or work experience in community nutrition or public health nutrition;
- (c) be the holder of a qualification issued by a university outside Canada and accepted as equivalent to the qualifications set out in either clause (a) or (b) by a Canadian university; or
- (d) has knowledge and experience that the Minister considers equivalent to the requirements set out in clause (a) or (b).

(2) Subsection (1) does not apply to a person who was employed as a public health nutritionist by a board of health on the 1st day of July, 1984. O. Reg. 164/84, s. 7.

Column 1 of Table 1 shall ensure that the cat or dog is immunized against rabies on and after the date set out opposite thereto in Column 2 of Table 1. O. Reg. 594/85, s. 1.

2.—(1) Every owner or person having the care or custody of a horse, cow, bull, calf or sheep or any class of horse, cow, bull, calf or sheep that is kept in a health unit or any premises or class of premises within a health unit listed in Column 1 of Table 2 shall ensure that each such animal or class of animal that is listed opposite thereto in Column 2 of Table 2 is immunized against rabies.

(2) Subsection (1) does not apply to a horse, cow, bull, calf or sheep or class of horse, cow, bull, calf or sheep that is accessible only to the person or persons who are responsible for the care and control of such animal or class of animal, as the case may be. O. Reg. 287/86, s. 1.

3.—(1) Every animal that is required to be immunized in accordance with section 1 or subsection 2 (1) shall be reimmunized in accordance with the date prescribed in the certificate of immunization issued with respect to the animal.

(2) Every owner or person having the care and custody of an animal referred to in section 1 or subsection 2 (1) that has been immunized prior to the 22nd day of November, 1985 shall ensure that the animal is reimmunized from time to time as specified by a veterinarian having regard to the type of animal and the type of vaccine used for the immunization. O. Reg. 594/85, s. 3.

4. Immunization against rabies shall be,

- (a) carried out by a veterinarian registered under the *Veterinarians Act*; and
- (b) by inoculation with a rabies vaccine that is licensed for use in Canada and that is administered in accordance with the instructions of the manufacturer who produced the vaccine. O. Reg. 594/85, s. 4.

5.—(1) The owner or person having the care and custody of an animal that has been immunized or reimmunized against rabies shall be issued a certificate of immunization by the veterinarian who carried out the immunization.

(2) In the case of a cat or dog, the veterinarian who carried out the immunization shall also provide the owner or person with a rabies identification tag. O. Reg. 594/85, s. 5.

6. A certificate of immunization shall be signed by the veterinarian who performed the immunization and shall contain,

- (a) the name and address of the owner or person having care and custody of the animal;
- (b) the species, breed, sex and age of the animal;
- (c) markings, if any, on the animal;
- (d) the address of the clinic or other location where the animal was immunized;
- (e) the name and code of the vaccine;
- (f) the date of the immunization;
- (g) the date that the animal is to be reimmunized; and
- (h) the number of the rabies identification tag that is issued with respect to a cat or dog. O. Reg. 594/85, s. 6.

7. A duplicate copy of each certificate of immunization issued under this Regulation shall be retained by the person who issued it for a period of three years from the date of its issue. O. Reg. 594/85, s. 7.

REGULATION 567

RABIES IMMUNIZATION

1. Every owner or person having the care and custody of a cat or dog three months of age or over that is kept in a health unit listed in

8.—(1) The owner or person having the care and custody of an animal that is in or has a physical condition that precludes the safe immunization or reimmunization of the animal against rabies is exempt from the requirement of this Regulation where,

- (a) a statement of exemption is issued by a veterinarian with respect to the animal that sets out the reason why the animal cannot be immunized or reimmunized; and
- (b) the animal is controlled in such a manner as to preclude its being exposed to rabies.

(2) An owner or person referred to in subsection (1) continues to be exempt from the requirements of this Regulation so long as the animal cannot be immunized or reimmunized. O. Reg. 287/86, s. 2.

TABLE 1

ITEM	COLUMN 1	COLUMN 2
	Name of Health Unit	Effective Date
1.	Borough of East York Health Unit	December 1, 1985
2.	Haldimand-Norfolk Regional Health Unit	April 1, 1986
3.	Haliburton, Kawartha, Pine Ridge District Health Unit	September 1, 1986
4.	Kingston, Frontenac and Lennox and Addington Health Unit	June 2, 1986
5.	Peterborough County City Health Unit	May 15, 1986
6.	Perth County Health Unit	October 1, 1986
7.	Hastings and Prince Edward Counties Health Unit	September 13, 1986

ITEM	COLUMN 1	COLUMN 2
	Name of Health Unit	Effective Date
8.	Middlesex-London District Health Unit	November 1, 1986
9.	Oxford County	March 1, 1987
10.	York Regional Health Unit	March 1, 1987
11.	Huron County Health Unit	March 1, 1987
12.	Simcoe County District Health Unit	
13.	Eastern Ontario Health Unit	July 20, 1987
14.	City of Toronto Health Unit	October 30, 1987
15.	Kent-Chatham Health Unit	June 1, 1988
16.	Leeds, Grenville and Lanark District Health Unit	June 1, 1988
17.	Bruce-Grey-Owen Sound Health Unit	December 1, 1989
18.	Windsor-Essex County Health Unit	February 1, 1991

O. Reg. 594/85, Table 1; O. Reg. 120/86, s. 1; O. Reg. 287/86, s. 3; O. Reg. 501/86, s. 1; O. Reg. 622/86, s. 1; O. Reg. 660/86, s. 1; O. Reg. 720/86, s. 1; O. Reg. 117/87, s. 1; O. Reg. 248/87, s. 1; O. Reg. 416/87, s. 1; O. Reg. 581/87, s. 1; O. Reg. 341/88, s. 1; O. Reg. 612/89, s. 1; O. Reg. 673/90, s. 1.

TABLE 2

ITEM	COLUMN 1	COLUMN 2	COLUMN 3
	Name of Health Unit	Animal or Class of Animal	Effective Date
1.	Peterborough County Health Unit	Riding, pleasure driving, show or competition horse	May 15, 1986
2.	Hastings and Prince Edward Counties Health Unit	Horse, cow, bull, calf, sheep, riding, pleasure driving, show or competition horse	September 13, 1986
3.	Huron County Health Unit	Riding, pleasure driving, show or competition horse	March 1, 1987
4.	Simcoe County District Health Unit	Horse, cow, bull, calf and sheep	May 8, 1987
5.	Bruce-Grey-Owen Sound	Riding horse	December 1, 1989
6.	Haliburton, Kawartha, Pine Ridge District Health Unit	Riding horse	February 1, 1991

O. Reg. 287/86, s. 4; O. Reg. 501/86, s. 2; O. Reg. 117/87, s. 2; O. Reg. 248/87, s. 2; O. Reg. 135/88, s. 1; O. Reg. 612/89, s. 2; O. Reg. 673/90, s. 2.

REGULATION 568

RECREATIONAL CAMPS

1. In this Regulation,

“class A camp” means a camp for recreational activities consisting of one or more tents, cabins, vehicles, buildings or other structures together with the land appertaining thereto, established or maintained as living quarters with or without charge for ten or more persons, for temporary occupancy of five or more days, but does not include a camp established by a person for his or her family

and guests or to a camping establishment as defined in subsection 1 (1) of Regulation 1037 of Revised Regulations of Ontario, 1990 made under the *Tourism Act*;

“class B camp” means a camp for recreational activities consisting of tents erected on a site together with the land appertaining thereto where sleeping, eating, cooking or other activities take place in the tents or in the open and where the tents are established or maintained as living quarters with or without charge for ten or more persons, for temporary occupancy of five or more days;

“day” means a continuous period of twenty-four hours;

“hazardous food” means any food capable of supporting the growth of pathogenic organisms or the production of the toxins of such organisms;

“operator” means every person who alone or by agents owns or operates a recreational camp;

“single-service article” means any container or eating utensil that is to be used only once in the service or sale of food;

“toilet” includes a privy;

“utensil” means any article or equipment used in the manufacture, processing, preparation, storage, handling, display or distribution of food, except a single-service article;

“washbasin” includes a pail or similar portable container of sound construction. O. Reg. 242/84, s. 1.

2. The following are classes of recreational camps:

1. Class A camps.
2. Class B camps. O. Reg. 242/84, s. 2.

NOTICE OF CAMP OPENING

3.—(1) Every person who intends to operate a recreational camp for the first time shall give written notice of the person's intention to do so to the medical officer of health at least sixty days before the camp is to be opened.

(2) Where an operator intends to open a recreational camp that has been closed for a period exceeding thirty days, the operator shall notify the medical officer of health of the proposed opening at least fourteen days prior to the re-opening of the camp. O. Reg. 242/84, s. 3.

CAMP LOCATION AND MAINTENANCE

4. Every operator shall ensure that each camp is so located and maintained as to be free from any condition that may endanger the health or safety of the campers or employees of the camp. O. Reg. 242/84, s. 4.

5. Every operator shall ensure that every person living in a camp or employed in a camp is free of any communicable disease or any infectious agent thereof. O. Reg. 242/84, s. 5.

CAMP STAFF

6. Every operator shall ensure that the campers in each camp are under the continuous supervision of an adult who has experience in administration and leadership in a recreational camp. O. Reg. 242/84, s. 6.

7.—(1) Every operator shall ensure that one of the following persons are present in each camp:

1. A physician.
2. A registered nurse.
3. A person who is a holder of,
 - i. a Canadian Red Cross Society's Standard First Aid Certificate,
 - ii. a St. John Ambulance Association's Standard First Aid Certificate, or
 - iii. a certificate that the medical officer of health considers equivalent to a certificate referred to in subparagraph i or ii.

(2) Where a physician is not in residence in a recreational camp, the operator shall ensure that the services of a physician can be obtained quickly in the case of a medical emergency.

(3) Every operator shall ensure that no animal that is susceptible to rabies is brought into a camp unless the animal has been immunized against rabies at least thirty days and not more than fifteen months prior to the bringing of the animal into the camp. O. Reg. 242/84, s. 7.

CAMP ACCOMMODATION

8.—(1) Every operator of a class A camp shall ensure that in each class A camp the floor area in the sleeping quarters is at least 3.72 square metres per camper or where single, double or triple tier bunk units are used, 2.79 square metres per camper.

(2) Every operator shall ensure that where a tent is used for accommodation in a camp the number of occupants in the tent shall not exceed the manufacturers' recommended limits. O. Reg. 242/84, s. 8.

VENTILATION

9.—(1) Every operator of a class A camp shall ensure that each sleeping area, dining room or any other building used by campers or employees in a class A camp is provided with,

- (a) natural ventilation adequate to ensure the elimination of all offensive odours; or
- (b) mechanical ventilation capable of providing at least one air change per hour.

(2) Every operator of a class A camp shall ensure that at least ten air changes per hour is provided in the food preparation area of each class A camp. O. Reg. 242/84, s. 9.

LIGHTING

10. Every operator of a class A camp shall ensure that each class A camp is provided with,

- (a) a minimum intensity of illumination of 100 lux in all hallways, corridors, stairways and sleeping areas;
- (b) a minimum intensity of illumination of 500 lux in the kitchen; and
- (c) a minimum intensity of illumination of 250 lux in all rooms other than those referred to in clauses (a) and (b). O. Reg. 242/84, s. 10.

FIRE PROTECTION

11.—(1) Every operator of a class A camp shall ensure that each permanent building used for sleeping in each class A camp that has a floor area of at least 55.8 square metres and that has a sleeping room that has no exit to the outside is provided with smoke alarms.

(2) Every operator of a class A camp shall ensure that each permanent building in a class A camp is equipped with a fire extinguisher in good working order.

(3) Every operator shall ensure that there are written procedures that shall be used in the event of a fire in each camp and that all campers and employees of the camp are trained in the procedures. O. Reg. 242/84, s. 11.

WATER SUPPLY

12.—(1) Every operator shall ensure that the water supply of each camp is,

- (a) obtained from a source or sources approved by the medical officer of health;
- (b) sufficient to meet the requirements of the campers and employees of the camp; and
- (c) potable.

(2) Where the medical officer of health is of the opinion that the water supply of a recreational camp requires treatment, he or she may require the operator to treat the water in order to render it safe and sanitary.

(3) Where an operator is required by the medical officer of health to treat water in order to render it safe and sanitary, the operator shall so treat the water and shall ensure that a record of the kind and method of treatment of the water supply is kept on the premises of the recreational camp for one year from the making of the record. O. Reg. 242/84, s. 12.

GENERAL

13. Every operator shall ensure that each tent and building in each camp is maintained in a sanitary condition at all times and that the grounds of the camp are free of litter and refuse. O. Reg. 242/84, s. 13.

SANITARY FACILITIES

14.—(1) Every operator shall ensure that each camp is provided with sanitary facilities in accordance with this section and sections 15 and 16.

(2) At least one separate sanitary facility for each sex shall be provided for the use of campers and staff in a recreational camp.

(3) A minimum of one toilet shall be provided for every ten campers of each sex in a recreational camp.

(4) One washbasin shall be provided for every five campers of each sex in a recreational camp.

(5) Where water-flush toilets are provided in a recreational camp, urinals may be counted as toilets for male use but the number of urinals shall not exceed 50 per cent of the number of toilets. O. Reg. 242/84, s. 14.

15.—(1) Every sanitary facility in a recreational camp shall,

- (a) be equipped with windows and self-closing, tight-fitting doors;
- (b) have all doors and windows screened against insects, rodents and vermin;
- (c) be ventilated so as to eliminate offensive odours; and
- (d) be kept sanitary and in good repair at all times.

(2) When a recreational camp is in operation, all toilet seats shall be thoroughly scrubbed daily with a sanitizing solution. O. Reg. 242/84, s. 15.

16. Every sanitary facility in a recreational camp shall be equipped with,

- (a) a supply of toilet paper;
- (b) a cleanable receptacle of sound construction for used towels and other refuse;
- (c) a supply of soap or detergent in a dispenser;
- (d) a supply of clean single-service towels or a hot air dryer;

- (e) where there are water-flush toilets, a supply of hot and cold water or a supply of cold water that contains a disinfectant; and
- (f) where there are privies, commercially packaged single-use moist hand towelettes or a supply of cold water that contains a disinfectant. O. Reg. 242/84, s. 16.

LAUNDRY OPERATIONS

17. Every operator shall ensure that the laundry operations in each camp are not carried on in a river, lake, stream or brook adjacent to or within the camp. O. Reg. 242/84, s. 17.

FOOD PREPARATION AND STORAGE

18.—(1) Every operator shall ensure that food in each camp is protected from contamination and adulteration and that foods not requiring refrigeration are kept in closed containers and stored in areas designated by the operator as areas for food storage only.

(2) Every operator shall ensure that each camp is provided with refrigerated space adequate for the safe storage of perishable and hazardous food.

(3) Every operator shall ensure that racks, shelves or pallets are provided for the storage of food in each camp and that no rack or shelf is placed less than fifteen centimetres above the floor.

(4) Every operator shall ensure that the food in each camp is stored on the racks, shelves or pallets referred to in subsection (3).

(5) Every operator shall ensure that in each camp hazardous food other than hermetically sealed food that has been subjected to a process sufficient to prevent the production of bacterial toxins or the survival of spore-forming pathogenic bacteria is stored, distributed, maintained, transported or displayed such that the internal temperature of the food is,

- (a) 5° Celsius, or lower; or
- (b) 60° Celsius, or higher,

except for such periods of time as may be necessary for the preparation, processing and manufacturing of the food.

(6) Every operator shall ensure that in each camp frozen food is stored and maintained at a temperature of minus 18° Celsius or lower.

(7) Every operator shall ensure that the food preparation and storage areas in each camp are so constructed, located and maintained as to provide protection against the entrance of insects, rodents, vermin, dust and fumes.

(8) Every operator shall ensure that in each camp temperature controlled rooms and compartments used for the storage of hazardous food are provided with accurate indicating thermometers that can be easily read. O. Reg. 242/84, s. 18.

19.—(1) Every operator shall ensure that each person who handles or comes into contact with food or with any utensils used in the preparation, processing, service or storage of food in a camp,

- (a) does not smoke while so engaged;
- (b) is clean;
- (c) wears headgear that confines the hair; and
- (d) washes his or her hands before starting work and after every use of a toilet or urinal.

(2) Every operator of a class A camp shall ensure that every person who handles or comes into contact with food or with any utensils

used in the preparation, processing, service or storage of food in a class A camp,

- (a) wears clean outer garments;
- (b) is free from any infectious agent of a disease that may be spread through the medium of food; and
- (c) submits to such medical examinations and tests as are required by the medical officer of health to confirm the absence of an infectious agent mentioned in clause (b).

(3) Every operator of a class A camp shall ensure that no person who has a skin disease performs any work that brings him or her into contact with food in a class A camp, unless the person has obtained the approval of the medical officer of health in writing before handling food.

(4) Every operator shall ensure that in each camp tongs, spoons and scoops of corrosion-resistant and non-toxic material are used wherever possible where food is being prepared or served to avoid direct hand contact with food.

(5) Every operator shall ensure that in each camp a basin only for hand washing is located in each food preparation area together with supplies of hot and cold water, soap or detergent in a dispenser and,

- (a) clean single-service towels;
- (b) a hot air dryer; or
- (c) a continuous roller towel in a mechanical device and a supply of paper towels.

(6) Every operator shall ensure that each food preparation area in each camp is provided with a supply of hot and cold potable water.

(7) Every operator shall ensure that cloths and towels used for washing, drying or polishing utensils or cleaning tables in each camp are,

- (a) in good repair;
- (b) clean; and
- (c) used for no other purpose.

(8) Every operator shall ensure that toxic and poisonous substances required for maintenance of sanitary conditions in each camp are,

- (a) kept in a compartment separate from food so as to preclude contamination of any food, working surface or utensil;
- (b) kept in a container that bears a label on which the contents of the container are clearly identified; and
- (c) used only in such manner and under such conditions that the substances do not contaminate food or cause a health hazard. O. Reg. 242/84, s. 19.

20.—(1) Every operator shall ensure that each article or piece of equipment that is used for preparation, service display, storage or transportation of food in a camp is,

- (a) of sound and tight construction;
- (b) kept in good repair; and
- (c) of such form and material that it can be readily cleaned and sanitized.

(2) Every operator shall ensure that in each camp equipment and utensils with which food comes in direct contact are,

- (a) corrosion-resistant and non-toxic; and
- (b) free from cracks, crevices and open seams.

(3) Despite subsection (2), cutting boards, blocks, tables, bowls, platters and churns of hardwood or other materials may be used in a camp where,

- (a) such equipment is maintained in a clean and sanitary condition; and
- (b) the manner and conditions of their use are not a health hazard. O. Reg. 242/84, s. 20.

CLEANING AND SANITIZING OF UTENSILS

21. Every operator shall ensure that utensils that are used in each camp are cleaned and sanitized in accordance with sections 23, 24, 25 and 26. O. Reg. 242/84, s. 21.

22.—(1) Every operator shall ensure that equipment and facilities for the cleaning and sanitizing of utensils in each camp is used for no other purpose and consists of,

- (a) mechanical equipment; or
- (b) equipment for washing by hand consisting of,
 - (i) a three-compartment sink or three sinks, of corrosion-resistant material of sufficient size to ensure thorough cleaning and sanitizing of utensils, or
 - (ii) a two-compartment sink or two sinks, of corrosion-resistant material for the cleaning and sanitizing of utensils where washing and rinsing can be done effectively in the first sink and the second sink is used for sanitizing as described in subsection 25 (1), and
 - (iii) drainage racks of corrosion-resistant material.

(2) Where the sinks referred to in subclause (1) (b) (i) or (ii) are not sufficient to effectively clean and sanitize the utensils, such additional sinks as will effectively clean and sanitize the utensils are required.

(3) Subclause (1) (b) (ii) does not apply to the cleaning and sanitizing of multi-service articles or utensils that directly contact ready to eat foods. O. Reg. 242/84, s. 22.

23. Utensils shall be,

- (a) scraped or rinsed;
- (b) cleaned;
- (c) rinsed; and
- (d) sanitized. O. Reg. 242/84, s. 23.

24. Where equipment for washing by hand is used in a recreational camp, utensils shall be,

- (a) cleaned in a sink in a detergent solution capable of removing soil;
- (b) rinsed in a second sink in clean water at a temperature not lower than 43° Celsius; and
- (c) sanitized in a third sink. O. Reg. 242/84, s. 24.

25.—(1) Utensils shall be sanitized by,

- (a) immersion in clean water at a temperature of at least 77° Celsius or more, for at least forty-five seconds;

- (b) immersion in a clean chlorine solution of not less than 100 parts per million of available chlorine at a temperature not lower than 24° Celsius for at least forty-five seconds;
- (c) immersion in a clean quaternary ammonium compound solution of not less than 200 parts per million at a temperature not lower than 24° Celsius for at least forty-five seconds;
- (d) immersion in a clean solution containing not less than twenty-five parts per million of available iodine at a temperature not lower than 24° Celsius for at least forty-five seconds; or
- (e) immersion in any solution containing a sanitizing agent that is non-toxic and that provides a bactericidal result not less than the result provided by clause (a), (b) or (c) and for which a convenient test reagent is available.

(2) A test reagent for determining the concentration of sanitizer and an accurate thermometer to determine the temperature of the sanitizing solution shall be readily available where the sanitizing takes place in a recreational camp. O. Reg. 242/84, s. 25.

26. Despite sections 24 and 25, utensils, other than utensils that come into direct contact with a milk product or ready to eat food, may be cleaned and sanitized in one operation provided that,

- (a) the chemical product used is designed for that purpose;
- (b) the product container bears directions for use indicating optimum temperature and exposure times;
- (c) the product is used in accordance with the directions for use;
- (d) a test reagent is readily available on the premises to determine the concentration of the sanitizing agent; and
- (e) the utensils so treated are completely rinsed with clean water. O. Reg. 242/84, s. 26.

27.—(1) Every operator shall ensure that mechanical equipment for the cleaning and sanitizing of utensils in each camp is,

- (a) so constructed, designed and maintained that,
 - (i) the wash water is sufficiently clean at all times to clean the dishes and is maintained at a temperature not lower than 60° Celsius or higher than 71° Celsius, and
 - (ii) the sanitizing rinse is,
 - (A) water that is maintained at a temperature not lower than 82° Celsius and is applied for a minimum of ten seconds in each sanitizing cycle, or
 - (B) a chemical solution described in clause 25 (1) (b), (c), (d) or (e); and
- (b) provided with thermometers that show wash and rinse temperatures and that are so located as to be easily read.

(2) An operator may use another machine or device other than the mechanical equipment referred to in subsection (1) where the machine or device will, in the opinion of the medical officer of health, effectively clean and sanitize the utensils and will result in a bacterial count on the utensils within the limits set out in section 29. O. Reg. 242/84, s. 27.

28. Where food processing equipment in a recreational camp is cleaned and sanitized in-place without disassembling the equipment, the operator shall ensure that instructions respecting,

- (a) the chemicals used for cleaning and sanitizing;
- (b) the strength of the chemical solutions used;
- (c) the length of time the equipment was exposed to the chemicals; and
- (d) the procedures used for cleaning and sanitizing the equipment,

are posted in a place accessible to the person carrying out the cleaning and sanitizing. O. Reg. 242/84, s. 28.

29. Every operator shall ensure that in each camp the standard plate count from a multi-service article does not exceed 100 bacterial colonies after cleaning and sanitizing and prior to re-use when tested by an official method in accordance with the standard plate test, utilizing the swab technique. O. Reg. 242/84, s. 29.

30. Every operator shall ensure that in each camp utensils that have been cleaned and sanitized are transported and stored in such a manner as to prevent contamination. O. Reg. 242/84, s. 30.

31. Every operator shall ensure that in each camp, where a utensil is so large as to preclude washing and sanitizing by means of sinks or other machines, it is washed or scrubbed with a detergent solution, rinsed with clean water and,

- (a) sprayed or rinsed with hot water or steam in a manner that creates a temperature of not less than 82° Celsius on the treated surface; or
- (b) sprayed or rinsed with a chemical solution of a type described in subsection 25 (1) at double the strength that is set out in the product directions. O. Reg. 242/84, s. 31.

DISPOSAL OF REFUSE

32. Every operator shall ensure that garbage and refuse in each camp is,

- (a) deposited in leakproof durable containers equipped with tight-fitting or self-closing tops;
- (b) removed after each meal from any room in which food is prepared, served or stored; and
- (c) collected daily and stored in a sanitary manner until final disposal.

WATER SAFETY

33. Where a recreational camp has a waterfront area that is used for aquatic activities the operator shall ensure that the waterfront area is operated in accordance with sections 34, 35 and 36. O. Reg. 242/84, s. 33.

34.—(1) Every waterfront area in a recreational camp that is used for aquatic activities shall be under the supervision of a waterfront director who is at least eighteen years of age and who holds one of the following qualifications that has been obtained within two years of acting as a waterfront director:

1. The National Lifeguard Service's registered lifeguard certificate.
2. The Royal Life Saving Society's Canada Bronze Medallion and aquatic instructor's certificate.
3. Any of the following certificates together with two years aquatic supervision experience:
 - i. The Royal Life Saving Society's Canada Bronze Medallion or higher award,

- ii. The Canadian Red Cross Society Water Safety Leader or Water Safety Instructor's certificate,
- iii. The Young Men's Christian Association's Basic or Senior Lifesaving certificate, or
- iv. A certificate that the medical officer of health considers to be equivalent to a certificate referred to in subparagraph ii or iii.

(2) The waterfront director shall ensure that, where the waterfront area in a recreational camp is in use, supervision is provided in accordance with the following Table:

TABLE

Number of Supervisors	Number of Campers in the water
2	1 to 25
3	26 to 100

For each additional twenty-five campers in the water or less where there are more than 100 campers, provide one additional supervisor.

(3) Despite the supervision required under subsection (2), the waterfront director shall ensure that, where non-swimmers, mentally or physically handicapped persons or campers under five years of age are using the waterfront area in the camp, additional supervision is provided that, in the opinion of the waterfront director, is adequate having regard to the type and number of children using the waterfront area.

(4) Every supervisor in a recreational camp shall be at least sixteen years of age and hold the Royal Life Saving Society's Bronze Medallion or qualifications that, in the opinion of the medical officer of health, are equivalent to the Bronze Medallion. O. Reg. 242/84, s. 34.

35. Every waterfront director of a recreational camp shall ensure that the following equipment is easily accessible at the waterfront area of the camp in case of an emergency:

1. One or more buoyant rescue aids attached to a shoulder loop with a six millimetre line at least 1.60 metres in length.
2. One or more reaching poles of three metres or greater in length.
3. One or more buoyant throwing aids attached to a six millimetre line at least eight metres in length.
4. A spine board.
5. A paddleboard or boat, when any part of the swimming area is more than fifty metres from the shore.
6. First aid supplies in sufficient quantities to meet the needs of the campers that shall include,
 - i. scissors,
 - ii. triangular bandages,
 - iii. water resistant, sterile bandages,
 - iv. sterile gauze pads (fifty millimetres by fifty millimetres and 100 millimetres by 100 millimetres),
 - v. rolls and gauze conform bandages,
 - vi. waterproof adhesive tape,
 - vii. blankets and pillows,

- viii. safety pins,
- ix. tweezers,
- x. ice packs,
- xi. antiseptic solution,
- xii. incident report forms. O. Reg. 242/84, s. 35.

36. The waterfront director of a recreational camp shall ensure that there are written instructions for emergency and operational procedures that shall be used in the event of an accident or emergency in the waterfront area and that all supervisors are trained in the procedures. O. Reg. 242/84, s. 36.

37. A reference in this Regulation to the medical officer of health means the medical officer of health of the board of health in the health unit in which the recreational camp referred to is situated. O. Reg. 242/84, s. 37.

REGULATION 569

REPORTS

1.—(1) A report required under section 25, 26 or 27 of the Act shall, with respect to the person to whom the report relates, contain the following information:

1. Name and address in full.
2. Date of birth in full.
3. Sex.
4. Date of onset of symptoms.

(2) A person who makes a report under section 25 or 26 of the Act and gives the information set out in subsection (1) shall, upon the request of the medical officer of health, give to the medical officer of health such additional information respecting the reportable disease or communicable disease, as the case may be, as the medical officer of health considers necessary.

(3) Despite subsection (1), a report under section 25 or 26 of the Act with respect to tuberculosis shall be made in Form 1 or Form 2, as the case may be, and with respect to leprosy shall be made in Form 3. O. Reg. 490/85, s. 1.

2. A report required under section 28 of the Act shall, with respect to the pupil to whom the report relates, contain the following information:

1. Name and address in full.
2. Date of birth in full.
3. Sex.
4. Name and address in full of the school that the pupil attends. O. Reg. 490/85, s. 2.

3. A report made under subsection 29 (1) of the Act shall, with respect to the person to whom the finding was made, be made within twenty-four hours of the making of the finding and shall contain the following information:

1. Name and address in full.
2. Date of birth in full.
3. Sex.

4. Date when the specimen was taken that yielded the positive finding.
 5. Name and address in full of the physician or dentist attending the person. O. Reg. 490/85, s. 3.
4. A report made under section 30 of the Act shall, with respect to the deceased, contain the following information:
1. Name and address in full.
 2. Date of birth in full.
 3. Date of death in full.
 4. Name and address in full of the physician who attended the deceased. O. Reg. 490/85, s. 4.
5. A report under section 25 or 26 of the Act shall contain the following information in addition to the information required under subsection 1 (1):
1. Syphilis:
 - i. The date of diagnosis.
 - ii. The name and address of the physician attending the person.
 - iii. The name of the hospital and the date of admission if the person is admitted to a hospital.
 - iv. Duration and stage of infection.
 - v. Drugs and dosage used for previous treatment, if any, of the infection.
 - vi. If previous treatment given, the place, date and physician responsible for the administration of the treatment.
 - vii. Current treatment, if any, of the infection, setting out the drugs and dosage used.
 - viii. If current treatment is being given, the place, date and physician responsible for the administration of treatment.
 - ix. Laboratory findings including serological tests, microscopic examination, cerebrospinal fluid examination.
 - x. The person responsible for tracing contacts of the person.
 2. Gonorrhoea due to penicillinase producing strain of *Neisseria gonorrhoeae*:
 - i. The date of diagnosis.
 - ii. The name and address of the physician attending the person.
 - iii. The name of the hospital and the date of admission if the person is admitted to a hospital.
 - iv. Place where infection is believed to have been acquired.
 - v. Initial treatment, if any, of the infection setting out drugs and dosage used.
 - vi. If initial treatment given, give place, date and physician responsible for administration of treatment.
 3. Acquired Immune Deficiency Syndrome (AIDS):
 - i. The date of diagnosis.
 - ii. The name and telephone number of the physician attending the person.
 - iii. The name of the hospital if the person is admitted to a hospital or is an outpatient.
 - iv. Medical conditions of the person including laboratory findings and date of onset of symptoms that are indicative of Acquired Immune Deficiency Syndrome.
 - v. Other medical conditions of the person that may have caused immuno-suppression (exclusion criteria).
 - vi. Country of birth, date of arrival in Canada, race and residence of the person at onset of illness.
 - vii. Current status of person infected (alive or dead) (if dead give date of death).
 - viii. Information preceding the diagnosis of Acquired Immune Deficiency Syndrome with respect to,
 - A. sexual relations of the person with a male partner;
 - B. sexual relations of the person with a female partner;
 - C. use by the person of needles for self-injection of drugs not prescribed by a physician; or
 - D. receipt by the person of blood or blood products (give dates).
 - ix. Information, preceding the diagnosis of Acquired Immune Deficiency Syndrome, with respect to heterosexual relations of the person with another person who is,
 - A. an intravenous abuser;
 - B. a bisexual man;
 - C. a person with hemophilia or a coagulation disorder;
 - D. a blood transfusion recipient with Acquired Immune Deficiency Syndrome or documented Human Immune Virus infection;
 - E. a person with Acquired Immune Deficiency
 - vii. Final effective treatment setting out drugs and dosage used.
 - viii. If effective treatment has been given, place, date and physician responsible for administration of treatment.
 - ix. The agency responsible for tracing contacts of the person.
 - x. The number of contacts of the person who have been traced.
 - xi. The number of contacts of the person found to be infected with penicillinase producing strain of *Neisseria gonorrhoeae*.

- Syndrome or documented Human Immune Virus infection;
- F. a person who was born or resided in a country where heterosexual transmission of Acquired Immune Deficiency Syndrome predominates (specify country).
- x. Information preceding the diagnosis of Acquired Immune Deficiency Syndrome, as to whether the person has worked or is working in a health care or clinical laboratory setting (give occupation and setting).
- xi. Information, preceding the diagnosis of Acquired Immune Deficiency Syndrome, as to whether there are no identifiable risk factors or any other exposures that could have been the source of the infection.
- xii. Information, in the case of a child who is one year of age or older but less than sixteen years of age, as to whether the child was infected as a result of perinatal transmission.
4. Lassa Fever, Marburg virus disease, Ebola virus disease and Plague:
- i. The date of diagnosis.
- ii. The name and address of the physician attending the person.
- iii. The name of the hospital and the date of admission if the person is admitted to a hospital.
- iv. Travel history outside Canada.
- A. Date and place of entry into country where disease acquired.
- B. Date of departure from country where disease acquired.
- C. Date and time of entry into Canada and carrier and flight number if applicable.
- D. Travel within country where disease acquired by date, place and length of stay.
- E. Any other places visited en route to Canada.
- v. List places and method of travel within Canada in the week prior to and since onset of illness.
- vi. Exposure to any of the following. (Give date and time).
- A. Rodents or monkeys.
- B. Persons with a similar illness.
- C. Virus in a laboratory.
- vii. Clinical history.
- A. Date of onset of illness.
- B. Symptoms and signs of the illness.
- C. History of malaria or malaria prophylaxis.
- viii. Laboratory specimens.
- A. List all specimens collected by type and date.
- B. Name of laboratory where specimens may be located.
- ix. State if ambulance was used and date of use.
O. Reg. 490/85, s. 5; O. Reg. 175/89, s. 1.
- 6.—(1) Where a medical officer of health receives a report made under section 25, 26, 27 or 28, subsection 29 (2) or section 30 of the Act, he or she shall forward a copy of the report to the Public Health Branch of the Ministry.
- (2) Where a copy of a report referred to in subsection (1) concerns a person who has,
- (a) amebiasis;
- (b) chickenpox;
- (c) epidemic diarrhoea;
- (d) genital chlamydia trachomatis infections;
- (e) genital herpes;
- (f) gonorrhoea, other than gonorrhoea due to penicillinase producing strain of *Neisseria gonorrhoeae*;
- (g) giardiasis;
- (h) influenza;
- (i) measles;
- (j) mumps;
- (k) pertussis; or
- (l) rubella,
- the copy shall be forwarded with the name of the person deleted.
O. Reg. 490/85, s. 6.

Form 1

Health Protection and Promotion Act

NOTIFICATION OF NEW ACTIVE OR REACTIVE TUBERCULOSIS CASE

2. Name of patient: (Surname) (Given names) (Maiden name)			3. Register case No.:					
4. Sex: M <input type="checkbox"/> F <input type="checkbox"/> 1 <input type="checkbox"/> 2 <input type="checkbox"/>			5. Permanent residence: (Number) (Street) (City, town, village) (County, division) (Province)					
6. Marital Status: Mar. or Single C.L. Sep. Wid. Div. 1 <input type="checkbox"/> 2 <input type="checkbox"/> 3 <input type="checkbox"/> 4 <input type="checkbox"/> 5 <input type="checkbox"/>		7. Origin: Unreg. Ind. or Reg. Ind. Metis Inuit Other 1 <input type="checkbox"/> 2 <input type="checkbox"/> 3 <input type="checkbox"/> 4 <input type="checkbox"/>		8. Date of diagnosis: Month Year				
10. Country of birth: 995 <input type="checkbox"/> Canada <input type="checkbox"/> Other (specify)			9. Date of birth: Day Month Year					
11. Year of arrival in Canada: (omit if born in Canada) 19			15. Bacillary status:					
12. Diagnosis (ICD) Respiratory: <input type="checkbox"/> Pulmonary: Far Advanced <input type="checkbox"/> Moderately Adv. <input type="checkbox"/> Minimal <input type="checkbox"/> <input type="checkbox"/> With associated silicosis (502) Miliary <input type="checkbox"/> Primary <input type="checkbox"/> Pleurisy (tuberculous) <input type="checkbox"/> Tuberculosis Laryngitis <input type="checkbox"/> Other Respiratory Tuberculosis (Specify) <input type="checkbox"/> Non-respiratory: (specify)			Microscopy					
			Sputum Other: (specify)			Cultura		
			Sputum Other: (specify)			Sputum Other: (specify)		
			Negative <input type="checkbox"/> <input type="checkbox"/> <input type="checkbox"/>			Positive <input type="checkbox"/> <input type="checkbox"/> <input type="checkbox"/>		
13. (a) Patient on preventive chemotherapy before? 1 <input type="checkbox"/> Yes 2 <input type="checkbox"/> No 0 <input type="checkbox"/> Unknown (b) If yes, give duration in months			16. (a) New active case? 1 <input type="checkbox"/> } Check one (b) Reactivated case? 2 <input type="checkbox"/> } box only (i) Year of first active episode 19 (ii) Country of first active episode (iii) Antituberculosis drugs administered previously as treatment for more than 90 days: 1 <input type="checkbox"/> INH 2 <input type="checkbox"/> SM 3 <input type="checkbox"/> PAS 4 <input type="checkbox"/> EMB 5 <input type="checkbox"/> ETA 6 <input type="checkbox"/> RMP 7 <input type="checkbox"/> PZA 8 <input type="checkbox"/> CS 9 <input type="checkbox"/> Other (specify) 0 <input type="checkbox"/> Unknown <input type="checkbox"/> No drugs administered					
14. (a) Previous BCG vaccination(s)? 1 <input type="checkbox"/> Yes 2 <input type="checkbox"/> No 0 <input type="checkbox"/> Unknown (b) If yes, indicate year of last BCG vaccination if known.... 19			17. Was this case discovered after death? 1 <input type="checkbox"/> Yes 2 <input type="checkbox"/> No					

Patient Occupation		Place of Employment	
PREVIOUS	TUBERCULIN TEST	Last Date Negative	Hospital Admission Yes <input type="checkbox"/> No <input type="checkbox"/>
	Result Unknown <input type="checkbox"/> Not Done <input type="checkbox"/>	First Date Positive	Admission Date
PRESENT	MANTOUX	Diameter Induration To STU mm	Does Patient require hospital treatment now Yes <input type="checkbox"/> No <input type="checkbox"/>
	OTHER (Specify and Indicate Size of Reaction)		Treatment Started as Outpatient <input type="checkbox"/> Inpatient <input type="checkbox"/>
METHDD OF DETECTION		Name of Physician or Clinic Supervising Treatment	
Symptoms <input type="checkbox"/>	Contact <input type="checkbox"/>	Routine <input type="checkbox"/>	Other (Specify) <input type="checkbox"/>
Other (Specify) <input type="checkbox"/>		Date Chemotherapy Started	

REMARKS

Physician's Name		Name of Medical Officer of Health	
Address		Signature and Date	
Physician's Signature and Date		Name and Address of Board of Health	

Form 2

Health Protection and Promotion Act



Ministère de la Santé Ontario

AVIS DE NOUVEAU CAS ACTIF DE TUBERCULOSE OU DE TUBERCULOSE RÉACTIVÉE
 Veuillez dactylographier ou écrire en lettres moulées. Il faut remplir toutes les rubriques, qu'il s'agisse d'une primo-infection ou d'une réinfection tuberculeuse.

3. Nom du malade : (Nom) (Prénom) (Nom de fille)			1. Province de
			3 5
4. Sexe : M <input type="checkbox"/> F <input type="checkbox"/>		3. Numéro au registre central :	
1 <input type="checkbox"/> 2 <input type="checkbox"/>			
5. Domicile : (No) (Rue) (Cité, ville, village) (Comté, division) (Province)			
8. Date du diagnostic : (mois) (année)		9. Date de naissance : (jour) (mois) (année)	
10. Pays de naissance : 905 <input type="checkbox"/> Canada <input type="checkbox"/> Autre (préciser) _____		15. État bacillaire :	
11. Année d'arrivée au Canada : (omettre, si malade est né au Canada) _____		Microscopie	
12. Diagnostic (ICIM) :		Culture	
Respiratoire <input type="checkbox"/> Pulmonaire : Tuberculose grave <input type="checkbox"/> modérée <input type="checkbox"/> minime <input type="checkbox"/> <input type="checkbox"/> Associé avec la silicose (S02) Miliaire <input type="checkbox"/> Primaire <input type="checkbox"/> Pleurésie (tuberculeuse) <input type="checkbox"/> Laryngite tuberculeuse <input type="checkbox"/> Autres tuberculoses pulmonaires (préciser) _____ Non respiratoire : (préciser) _____		Expectorations	
		Autre : (préciser)	
		Expectorations	
		Autre (préciser)	
13. a) Ce patient a-t-il déjà reçu une chimiothérapie préventive? 1 <input type="checkbox"/> Oui 2 <input type="checkbox"/> Non 0 <input type="checkbox"/> Non précisé		Négatif <input type="checkbox"/>	
b) Si oui, donner la durée en mois _____		Positif <input type="checkbox"/>	
14. a) Vaccination par le BCG antérieurement? 1 <input type="checkbox"/> Oui 2 <input type="checkbox"/> Non 0 <input type="checkbox"/> Non précisé		Non réalisé <input type="checkbox"/>	
b) Si oui, indiquer l'année du dernier BCG si elle est connue 19 _____		16. a) Nouveau cas actif 1 <input type="checkbox"/> Cocher une case	
		b) Tuberculose réactivée 2 <input type="checkbox"/> seulement	
		i) Année de la première période d'activité 19 _____	
		ii) Pays où cette première période d'activité est survenue _____	
		iii) Médicaments antituberculeux administrés antérieurement, comme traitement, pendant plus de 90 jours :	
		1 <input type="checkbox"/> INH 2 <input type="checkbox"/> SM 3 <input type="checkbox"/> PAS 4 <input type="checkbox"/> EMB	
		5 <input type="checkbox"/> ETA 6 <input type="checkbox"/> RMP 7 <input type="checkbox"/> PZA 8 <input type="checkbox"/> CS	
		9 <input type="checkbox"/> Autre (préciser) _____ 0 <input type="checkbox"/> Non précisé _____	
		<input type="checkbox"/> Aucun médicament administré	
		17. Ce cas a-t-il été découvert après le décès? 1 <input type="checkbox"/> Oui 3 <input type="checkbox"/> Non	

Emploi du malade		Lieu de travail	
PRÉCÉDENT	Test é tuberculeux	Date du dernier test négatif	Hospitalisation : Oui <input type="checkbox"/> Non <input type="checkbox"/>
	Résultats inconnus <input type="checkbox"/> omis <input type="checkbox"/>	Date du premier test positif	Date d'admission
PRÉSENT	Réaction de Mantoux	Diamètre de l'induration jusqu'à 6 UT mm	Nom de l'hôpital
	Autre (préciser le type de réaction et sa taille)	Omnia <input type="checkbox"/>	Le malade a-t-il besoin d'un traitement en milieu hospitalier? Oui <input type="checkbox"/> Non <input type="checkbox"/>
MODE DE DÉTECTION		À titre externe <input type="checkbox"/> hospitalisé <input type="checkbox"/>	
Symptômes <input type="checkbox"/>	Par Contact <input type="checkbox"/>	Nom du médecin ou de la clinique chargée de surveiller le traitement :	
Autre (préciser) <input type="checkbox"/>	Examen systématique <input type="checkbox"/>	Médicaments prescrits : INH <input type="checkbox"/> SM <input type="checkbox"/> PAS <input type="checkbox"/> EMB <input type="checkbox"/> ETA <input type="checkbox"/> RMP <input type="checkbox"/> PZA <input type="checkbox"/> CS <input type="checkbox"/>	
		Autre (préciser) <input type="checkbox"/>	
		Date de commencement de la chimiothérapie	

REMARQUES

Nom du médecin :		Nom du médecin-hygiéniste	
Adresse		Signature du médecin-hygiéniste	
Signature du médecin	Date	Date	
Nom et adresse du conseil de santé			

Form 3

Health Protection and Promotion Act

NOTIFICATION OF NEW ACTIVE—LEPROSY (HANSEN'S DISEASE)

DÉCLARATION—NOUVEAU CAS DE LÈPRE (MALADIE DE HANSEN)

Name of patient/Nom du malade		Sex/Sexe M <input type="checkbox"/> F <input type="checkbox"/>	
Date of birth/Date de naissance	Country of birth/Pays natal	Permanent residence/Domicile	
Occupation/Emploi:	Marital status/ État matrimonial	Separated/Divorcé(e) <input type="checkbox"/> Widowed/Veuve <input type="checkbox"/> Divorced/Divorcé(e) <input type="checkbox"/>	
Telephone/Telephone Bureau _____ Home/Domicile _____	Date of arrival in Canada/Date d'arrivée au Canada	Country in which infection occurred/Pays où la maladie a été contractée	
Date of first symptoms/Date des premiers symptômes	Date of first diagnosis/Date d'établissement du premier diagnostic	Date of residence in that country/Dates du séjour dans ce pays	
First diagnosis made in —/Lieu où la maladie a été diagnostiquée pour la première fois Canada <input type="checkbox"/> Other country/Autre pays <input type="checkbox"/> Specify/Préciser: _____			
CLINICAL DIAGNOSIS DIAGNOSTIC CLINIQUE	Tuberculoïd Tuberculose (TT) <input type="checkbox"/>	Borderline tuberculoïd Tubercu limiteigne (BT) <input type="checkbox"/>	Mis-borderline Limiteigne (BB) <input type="checkbox"/>
			Lepromatous Lépromateux (LL) <input type="checkbox"/>
			Borderline lepromatous Lépre limiteigne (BL) <input type="checkbox"/>
			Indeterminate Indéterminée (IND) <input type="checkbox"/>
HISTOPATHOLOGICAL DIAGNOSTIC HISTO- PATHOLOGIQUE	(TT) <input type="checkbox"/>	(BT) <input type="checkbox"/>	(BB) <input type="checkbox"/>
			(LL) <input type="checkbox"/>
			(BL) <input type="checkbox"/>
			(IND) <input type="checkbox"/>
SLIT SKIN SMEARS/FROTIS PRÉLEVÉS DES LÉSIONS CUTANÉES/IFor/Pour BB, BL, LL)			
Date	Nose - Blow Mucus nasal	Ear/Oreille R/D L/G	Elbow/Coude R/D L/G
			Hand/Main R/D L/G
			Knee/Genou R/D L/G
			Other Autres régions du corps
10 - 6 +) BI			
1% MI			
LEPROMIN SKIN TEST/LÉPROMINO - RÉACTION CUTANÉE			
Fernandez (mm) Mitsuda (mm)	Ulceration <input type="checkbox"/>	Date treatment first commenced /Date du premier jour de traitement	Duration of treatment/Durée du traitement
MEDICATION(S) / MÉDICAMENTS			
	d/s - day/jour	w/s - week/semaine	m - month/mon
PREVIOUS TRAITEMENT ANTÉRIEUR	Rifampin mg/ <input type="checkbox"/> <input type="checkbox"/> <input type="checkbox"/>	Dapsone mg/ <input type="checkbox"/> <input type="checkbox"/> <input type="checkbox"/>	Clofazimine mg/ <input type="checkbox"/> <input type="checkbox"/> <input type="checkbox"/>
			Thiambutide mg/ <input type="checkbox"/> <input type="checkbox"/> <input type="checkbox"/>
			Prednisone mg/ <input type="checkbox"/> <input type="checkbox"/> <input type="checkbox"/>
CURRENT AND DATE COMMENCED TRAITEMENT EN COURS ET DATE DE COMMENCEMENT	d/s w/s m mg/ <input type="checkbox"/> <input type="checkbox"/> <input type="checkbox"/>	d/s w/s m mg/ <input type="checkbox"/> <input type="checkbox"/> <input type="checkbox"/>	d/s w/s m mg/ <input type="checkbox"/> <input type="checkbox"/> <input type="checkbox"/>
			d/s w/s m mg/ <input type="checkbox"/> <input type="checkbox"/> <input type="checkbox"/>
			d/s w/s m mg/ <input type="checkbox"/> <input type="checkbox"/> <input type="checkbox"/>
If Admitted: Name of Hospital and Location (ie, city, town) Si le sujet a été hospitalisé, nom de l'hôpital et localité (ville, village, etc.)		Admission date Date d'admission	
		Discharge date Date de mise en congé	
Contact follow-up by Examen des personnes de l'entourage de	Number of household contacts Nombre des membres de la famille en contact avec le malade	Consultant Leprologist/ Leprologiste consultant	
Name and Address of Pathologist/Nom et adresse du pathologiste		Name and Address of Physician/Nom et adresse du médecin	
		Signature of Physician / Signature du médecin	
		Telephone / Téléphone	
Medical Officer of Health/Médecin-hygiéniste		Name and Address of Health Unit/Nom et adresse de la circonscription sanitaire	
Date of this Notification/Date du présent examen			

REGULATION 570

SCHOOL HEALTH SERVICES AND PROGRAMS

1. The health programs and services set out in Column 1 of the Table are prescribed for the purposes of subsection 6 (1) of the Act for the classification of pupils set out opposite thereto in Column 2 of the Table:

TABLE

ITEM	COLUMN 1	COLUMN 2
	Health Programs and Services	Classification of Pupils
1.	A health review consisting of, <ul style="list-style-type: none"> (a) the taking of a pupil's health and immunization history from the pupil's parent or guardian; (b) the provision of vision and hearing tests for ascertaining visual and hearing acuity; and (c) the observing and recording of any observable abnormalities. 	Pupils entering school for the first time.
2.	Advice to a parent or guardian of a pupil to consult a family physician, optometrist, ophthalmologist, otorhinolaryngologist, or audiologist.	Pupil referred to in item 1 who has been identified as having a problem related to health.
3.	Two vision screening tests in addition to those given under item 1 for the early identification of vision defects.	Pupils between grades 3 and 8 or pupils between 8 and 13 years of age with a minimum of three years between the second and third vision screening tests.
4.	Advice to a parent or guardian of a pupil to consult a family physician, optometrist or ophthalmologist.	Pupil referred to in item 3 who has been identified as having a possible vision defect.
5.	Hearing test in addition to that given under item 1 for the early identification of hearing defects.	Pupils in grade 2 or in their second year of school.
6.	Advice to a parent or guardian of a pupil to consult a family physician, otorhinolaryngologist or audiologist.	Pupil referred to in item 5 who has been identified as having a possible hearing defect.
7.	Counselling services on health related problems.	Pupils in elementary and secondary schools.
8.	The provision of professional staff and information on health education.	Pupils in elementary and secondary schools.
9.	Assessment of immunization status.	Pupils entering school for the first time in Ontario.

ITEM	COLUMN 1	COLUMN 2
	Health Programs and Services	Classification of Pupils
10.	The provision of immunization for designated diseases within the meaning of the <i>Immunization of School Pupils Act</i> .	Pupils who enter school for the first time in Ontario who have not been immunized in accordance with the requirements of the <i>Immunization of School Pupils Act</i> and the regulations thereunder and who do not have access to a family physician.
11.	Fluoride Program (i.e. a fluoride mouth rinse program that is done weekly or every other week in the school or the provision of daily fluoride tablets or supplements).	Pupils from grade 1 to grade 8 in schools in locations where the level of fluoride in the water system is below 0.7 parts per million.
12.	Dental screening examinations (i.e. examination of the teeth and the tissue of the oral cavity).	Pupils 5, 7, 9, 11 and 13 years of age.
13.	Advice to a parent or guardian of a pupil to consult a dentist.	Pupil referred to in item 12 who has been identified as requiring dental treatment.
14.	Individual topical fluoride application including dental health instruction.	Pupils from kindergarten to grade 8 who exhibit high caries activity.
15.	Dental health education program consisting of at least the following: <ul style="list-style-type: none"> 1. Information on nutrition. 2. Information on good dental habits and the importance of regular dental services. 3. Instruction respecting the cause of dental caries, periodontal disease and the structure and functions of teeth for each grade in each school year for a total of thirty minutes. 	Pupils in kindergarten to grade 8.
16.	Instruction on oral hygiene to include but not be limited to toothbrushing, flossing and plaque disclosing.	At least seven sessions between kindergarten and grade 8.
17.	Follow-up on advice given in items 2, 4, 6 and 13 to determine action taken.	Pupil who has been identified as having a health problem.

O. Reg. 516/84, s. 1.

2. It is a requirement for the provision of any health service or treatment under this Regulation that, where a consent is required by law before the service or treatment is given, such consent shall be obtained by the person providing the service. O. Reg. 516/84, s. 2.

3. Each board of health that carries out dental screening exami-

nations referred to in item 12 of the Table shall submit any statistical information on the dental conditions of the children screened to the Ministry. O. Reg. 516/84, s. 3.

REGULATION 571

SLAUGHTERHOUSES AND MEAT PROCESSING PLANTS

DEFINITIONS

1. In this Regulation,

“animal” means a domestic animal the meat of which is intended to be used for human consumption, and includes poultry;

“carcass” means the whole carcass of an animal;

“employee” means any person who,

- (a) is employed in a slaughterhouse or meat processing plant, and
- (b) handles or comes in contact with meat or a manufactured meat product in a plant;

“manufactured meat product” means food that is the product of a process and that contains meat as an ingredient and includes meat that is processed by salting, pickling, fermenting, canning, drying or smoking or otherwise applying heat or to which edible fats, cereals, seasonings or sugar have been added;

“meat” means animal flesh and organs intended for food;

“meat processing plant” means a plant where meat is processed or used in the production of a manufactured meat product and is located on the same premises as a slaughterhouse;

“operator” means a person who has responsibility for and control over the activities of the slaughterhouse even if there is more than one operator of the same slaughterhouse;

“plant” means slaughterhouse or meat processing plant;

“poultry” means chickens, ducks, geese, turkeys and other birds;

“sanitizing” means antimicrobial treatment, and “sanitize” has a corresponding meaning;

“utensil” means any article or equipment used in the slaughter of an animal or the processing of meat products. O. Reg. 293/84, s. 1.

2. This Regulation does not apply to,

- (a) a farmer who slaughters his or her own animal on his or her own premises and for his or her own consumption; or
- (b) a food premise wherein meat products are manufactured to which Regulation 562 of Revised Regulations of Ontario, 1990 applies. O. Reg. 293/84, s. 2.

3.—(1) No person shall slaughter an animal intended for food except in a slaughterhouse.

(2) No person shall process meat or use meat in the production of a manufactured meat product except in a meat processing plant or a food premise.

(3) No person shall slaughter or process meat or produce a manufactured meat product in a plant except in accordance with this Regulation.

(4) No person shall construct, operate or maintain a plant except in accordance with this Regulation. O. Reg. 293/84, s. 3.

4. No person shall establish a plant or construct premises for use as a plant without first,

- (a) notifying the medical officer of health of the person’s intention to do so; and
- (b) furnishing the medical officer of health with two copies of the plans or specifications of the premises proposed to be used or constructed. O. Reg. 293/84, s. 4.

CONSTRUCTION AND EQUIPMENT OF PLANTS

5. Every plant shall,

- (a) be located in a place free from conditions that might injuriously affect the sanitary operation of the plant;
- (b) be constructed and finished in such manner that the plant is capable of being maintained in a sanitary condition;
- (c) be equipped with refrigeration facilities capable of maintaining the temperatures prescribed by this Regulation;
- (d) be provided with a minimum of,
 - (i) 538 lux of illumination in every slaughtering and meat processing area, and
 - (ii) 322 lux of illumination in every other area; and
- (e) be so ventilated as to prevent condensation that may contaminate food. O. Reg. 293/84, s. 5.

6.—(1) Every slaughterhouse shall be equipped with,

- (a) livestock pens for the purpose of holding livestock before slaughtering;
- (b) humane handling and stunning equipment;
- (c) a killing room for the purpose of slaughtering animals;
- (d) a chill room for the purpose of chilling meat immediately after an animal is slaughtered; and
- (e) a storage room for inedible offal and meat that is not food.

(2) The humane stunning equipment referred to in clause (1) (b) shall only be used in the killing room.

(3) Where a slaughterhouse salts hides, the slaughterhouse shall be equipped with a hide room for that purpose. O. Reg. 293/84, s. 6.

7. Every meat processing plant shall be equipped with,

- (a) a processing room for the purpose of working with meat while it is being processed; and
- (b) refrigerated space for the purpose of storing meat and manufactured meat products. O. Reg. 293/84, s. 7.

8. Every plant shall have available a supply of potable hot and cold water under pressure and adequate for the efficient operation of the plant. O. Reg. 293/84, s. 8.

9. Floors shall be smooth, impervious to liquids and drained,

- (a) in livestock pens;
- (b) in killing rooms; and

- (c) in rooms in which carcasses, meats or manufactured meat products are chilled, manufactured, processed or stored. O. Reg. 293/84, s. 9.
10. A catch basin shall not be located in any room in which animals are slaughtered or in which meat is processed, prepared or stored. O. Reg. 293/84, s. 10.
11. The walls of a room in which animals are slaughtered and in which meat is processed or stored or in which a manufactured meat product is manufactured or stored shall be constructed of a smooth material that is impervious to liquids. O. Reg. 293/84, s. 11.
12. All outside openings in a plant shall be effectively screened or otherwise protected to prevent the entry of insects, rodents or vermin. O. Reg. 293/84, s. 12.
13. Utensils shall be of such material and so constructed that they can be easily and thoroughly cleaned and sanitized. O. Reg. 293/84, s. 13.
14. Rails, racks and hooks in a plant shall be,
- of metal construction; and
 - arranged so as to prevent contact of meat or a manufactured meat product with a wall or floor. O. Reg. 293/84, s. 14.
15. Tables, benches, blocks and containers in a plant shall be,
- free of any crack or crevice; and
 - kept clean, sanitary and in good repair. O. Reg. 293/84, s. 15.
16. Containers used in the rendering, preparation or storage of meat other than meat for food shall be,
- of metal or plastic construction;
 - marked to identify the use to which they are put;
 - used for no other purposes; and
 - kept clean and in good repair. O. Reg. 293/84, s. 16.
17. Every refrigerated room in a plant shall be equipped with a direct reading thermometer of known accuracy. O. Reg. 293/84, s. 17.
18. Every plant shall be provided with a basin only for handwashing in a location convenient for employees in each processing, preparation and manufacturing area, together with supplies of hot and cold water, soap or detergent in a dispenser and,

- clean single-service towels; or
- a continuous cloth roller towel in a mechanical device and a supply of paper towels. O. Reg. 293/84, s. 18.

MAINTENANCE

19. The floors, walls and ceiling of a plant shall be kept clean and maintained in a sanitary condition. O. Reg. 293/84, s. 19.
- 20.—(1) All waste and drainage from the operation of a plant shall be disposed of in a sanitary manner.
- (2) No operator shall allow refuse to accumulate in a plant or on or near the premises of a plant except in leak proof containers. O. Reg. 293/84, s. 20.
21. Animals other than those intended for slaughter shall not be permitted in a plant. O. Reg. 293/84, s. 21.

CLEANING AND SANITIZING

- 22.—(1) Sections 23 to 29 apply to utensils and cleaning equipment used in a plant.
- (2) All utensils in a plant shall be cleaned and sanitized before being put to use, and at the end of each day's use, and shall be maintained in a clean and sanitary condition at all times.
- (3) Utensils in a plant that have been in contact with contaminated material shall be immediately cleaned and sanitized. O. Reg. 293/84, s. 22.
- 23.—(1) Equipment and facilities for the cleaning and sanitizing of utensils shall be used for no other purpose and shall consist of,
- mechanical equipment; or
 - equipment for washing by hand consisting of,
 - a three-compartment sink or three sinks of corrosion-resistant material and of sufficient size to ensure thorough cleaning and sanitizing of utensils, or
 - a two-compartment sink or two sinks of corrosion-resistant material for the cleaning and sanitizing of utensils where washing and rinsing can be done effectively in the first sink and the second sink is used for sanitizing as described in subsection 26 (1), and
 - drainage racks of corrosion-resistant material.
- (2) Where the sinks referred to in subclause (1) (b) (i) or (ii) are not sufficient to effectively clean and sanitize the utensils, such additional sinks as will effectively clean and sanitize the utensils are required.
- (3) Subclause (1) (b) (ii) does not apply to the cleaning and sanitizing of utensils that directly contact ready to eat foods. O. Reg. 293/84, s. 23.
24. Where equipment for washing by hand is used, utensils shall be,
- cleaned in a detergent solution capable of removing soil;
 - rinsed in clean water at a temperature not lower than 43° Celsius; and
 - sanitized,
- and the cleaning, rinsing and sanitizing shall be carried out in the order set out in clauses (a), (b) and (c). O. Reg. 293/84, s. 24.
- 25.—(1) Utensils shall be sanitized by,
- immersion in clean water at a temperature of 77° Celsius or more for at least forty-five seconds;
 - immersion in a clean chlorine solution of not less than 100 parts per million of available chlorine at a temperature not lower than 24° Celsius for at least forty-five seconds;
 - immersion in a clean quaternary ammonium compound solution of not less than 200 parts per million at a temperature not lower than 24° Celsius for at least forty-five seconds;
 - immersion in a clean solution containing not less than twenty-five parts per million of available iodine at a temperature not lower than 24° Celsius for at least forty-five seconds; or
 - immersion in any solution containing a sanitizing agent that

is non-toxic and that provides a bactericidal result not less than the result provided by clause (a), (b), (c) or (d) and for which a convenient test reagent is available.

(2) A test reagent for determining the concentration of the sanitizer and an accurate thermometer to determine the temperature of the sanitizing solution shall be readily available where the sanitizing takes place. O. Reg. 293/84, s. 25.

26.—(1) Despite sections 24 and 25, utensils may be washed and sanitized in one operation provided that,

- (a) the chemical product used is designed for that purpose;
- (b) the product container bears directions for use indicating optimum temperature and exposure times;
- (c) the product is used in accordance with the directions for use;
- (d) a test reagent is readily available on the premises to determine the concentration of the sanitizing agent; and
- (e) the utensils so treated are completely rinsed with clean water.

(2) Where utensils come into direct contact with ready to eat foods and the procedure referred to in subsection (1) is used to clean and sanitize the utensil, a final sanitizing rinse shall be used in accordance with subsection 25 (1). O. Reg. 293/84, s. 26.

27. Mechanical equipment shall be,

- (a) so constructed, designed and maintained that,
 - (i) the wash water is sufficiently clean at all times to clean the utensils and maintained at a temperature not lower than 60° Celsius or higher than 71° Celsius, and
 - (ii) the sanitizing rinse is,
 - (A) water maintained at a temperature not lower than 82° Celsius and applied for a minimum of ten seconds in each sanitizing cycle, or
 - (B) a chemical solution described in clause 25 (1) (b), (c), (d) or (e); and
- (b) provided with thermometers that show wash and rinse temperatures and that are so located as to be easily read. O. Reg. 293/84, s. 27.

28. Where a utensil is so large as to preclude washing and sanitizing by means of sinks or other machines, it shall be washed or scrubbed with a detergent solution, rinsed with clean water and,

- (a) sprayed or rinsed with hot water or steam in a manner that creates a temperature of not less than 82° Celsius on the treated surface; or
- (b) sprayed or rinsed with a chemical solution of a type described in subsection 25 (1) at double the strength that is set out in the product directions. O. Reg. 293/84, s. 28.

29. Utensils that have been cleaned and sanitized shall be transported and stored in such manner as to prevent contamination. O. Reg. 293/84, s. 29.

OPERATION

30. Manufactured meat products that are customarily eaten without further cooking shall be subjected to a process sufficient to destroy pathogenic bacteria, parasites and the cystic forms of parasites. O. Reg. 293/84, s. 30.

31.—(1) Meat, manufactured meat products and any ingredient or material used in the processing or manufacture of meat or a manufactured meat product shall be kept in such manner and place as to protect them from becoming contaminated.

(2) Meat shall not come in direct contact with the floor or walls in a plant.

(3) Containers of meat or manufactured meat products shall not be placed in direct contact with the floor. O. Reg. 293/84, s. 31.

32. No meat or manufactured meat product that is not for food shall,

- (a) be present in a room in which meat for food is prepared, processed, packed, chilled or stored; or
- (b) come in contact with any equipment or material used in the preparing, processing, storing or handling of meat for food. O. Reg. 293/84, s. 32.

33. No operator shall bring or permit a dead or dying animal to be brought into a plant. O. Reg. 293/84, s. 33.

34. The following temperatures shall be maintained in a plant:

1. In a chill room, not less than 0° Celsius and not more than 5° Celsius.
2. In a room in which meat or a manufactured meat product is stored, not less than 0° Celsius and not more than 5° Celsius.
3. In a room in which meat or a manufactured meat product is cured, not less than 3° Celsius and not more than 5° Celsius.
4. In a sharp freeze room, minus 18° Celsius. O. Reg. 293/84, s. 34.

35. No meat or manufactured meat product shall be shipped from a plant for distribution as a frozen food unless it has first been frozen to minus 18° Celsius. O. Reg. 293/84, s. 35.

36. Where a mark is applied directly to meat, the mark shall be made from non-toxic edible ingredients. O. Reg. 293/84, s. 36.

37. Toxic and poisonous substances required for the maintenance of sanitary conditions shall be,

- (a) kept in a compartment separate from food so as to preclude contamination of any working surface or utensil;
- (b) kept in a container that bears a label on which the contents of the container are clearly identified; and
- (c) used only in such manner and under such conditions that the substances do not contaminate food or endanger the health of any person. O. Reg. 293/84, s. 37.

38. Every operator or employee who handles or comes in contact with meat or manufactured meat, or with any utensil used in the preparation or processing or service of meat shall,

- (a) not use tobacco while so engaged;
- (b) be clean;
- (c) wear clean outer garments;
- (d) wear headgear that confines the hair;
- (e) when required by the medical officer of health, submit to such medical examinations and tests as are necessary to confirm the absence of an infectious agent mentioned in clause (f);

- (f) be free from and not be a carrier of any disease that may spread through the medium of food; and
- (g) wash his or her hands before commencing or resuming work and after each use of a toilet, urinal or privy. O. Reg. 293/84, s. 38.

39. Every plant shall be provided with separate accommodation for washing and dressing for male and female employees. O. Reg. 293/84, s. 39.

SANITARY FACILITIES

40.—(1) Every plant shall provide for the use of the employees and the operator at least one separate sanitary facility for each sex, but where the total number of employees does not exceed five the same sanitary facility may be used by both sexes.

- (2) Every sanitary facility shall,
 - (a) be conveniently located and accessible to employees;
 - (b) have floor-to-ceiling walls and a full-length, self-closing, tight-fitting door;
 - (c) have toilet compartment partitions and doors that afford privacy for toilet use;
 - (d) have a sign clearly indicating the sex for which it is intended; and
 - (e) be kept clean, sanitary and in good repair at all times.
- (3) Every sanitary facility shall be equipped with,
 - (a) at least one toilet;
 - (b) at least one washbasin;
 - (c) a supply of toilet paper;
 - (d) a constant supply of hot and cold running water;
 - (e) a supply of soap or detergent in a dispenser;
 - (f) a receptacle of sound construction, cleanable and equipped with a self-closing lid, for used towels and other refuse; and
 - (g) a continuous cloth roller towel in a mechanical device together with a supply of paper towels, a supply of clean single-service towels or a hot air dryer.
- (4) Toilets shall be water-flush toilets with open-front toilet seats.
- (5) Washbasins, urinals and toilets shall be cleaned and sanitized at least once in every work day and as often as is necessary to maintain them in a sanitary condition. O. Reg. 293/84, s. 40.

RECORDS

41.—(1) Every operator shall maintain a record of each purchase of livestock, meats for process or manufacture and of slaughterings and each such record shall include,

- (a) the name and address of the person from whom the meat or livestock is purchased and the date of the purchase; and
- (b) the number and kind of animals slaughtered, and the date of slaughtering.

(2) A record required to be kept under subsection (1) shall be open to inspection by a medical officer of health or a public health inspector and retained by the operator for one year from the time of entry of the record. O. Reg. 293/84, s. 41.

42.—(1) Every manufactured meat product shall be identified as to the meat processing plant of origin by a tag, stamp or label and a bulk packed manufactured meat product shall bear the plant identification on the container.

(2) Subsection (1) does not apply to a manufactured meat product stored, offered for sale or sold in a retail outlet at the plant of origin. O. Reg. 293/84, s. 42.

43. A reference in this Regulation to the medical officer of health or the public health inspector means the medical officer of health or the public health inspector, as the case may be, of the board of health in the health unit in which the plant referred to is situate. O. Reg. 293/84, s. 43.

REGULATION 572

WARRANT

1. A warrant under section 43 of the Act shall be in Form 1. O. Reg. 163/84, s. 1.

Form 1

Health Protection and Promotion Act

WARRANT

WHEREAS evidence on the oath of

.....
 Name of Official
 has been made to me and I am satisfied that there is reasonable and probable ground for believing that it is necessary to enter the premises at

.....
 street address city
 to make examinations, investigations, tests and inquiries and to make, take and remove samples, copies or extracts related to an examination, investigation, test or inquiry for the purposes of the *Health Protection and Promotion Act*.

AND WHEREAS, the persons statutorily authorized to do the foregoing,

- (a) have been denied entry to the premises;
- (b) have been instructed to leave the premises;
- (c) have been obstructed; or
- (d) have been refused production of any thing or any plant or animal related to an examination, investigation, test or inquiry.

THIS is therefore to authorize,

.....
 (Name of Medical Officer of Health, Public Health Inspector or person acting on direction of Medical Officer of Health or Inspector appointed by the Minister)

.....
 (Name of Health Unit)

together with the assistance of a police officer or officers as may be called to enter and have access to, through and over the premises at

.....

 street address city
 to make examinations, investigations, tests and inquiries and to
 make, take and remove samples, copies or extracts related to an
 examination, investigation, test or inquiry for the purposes of the
Health Protection and Promotion Act, by force if necessary.

THIS WARRANT expires on the day
 of, 19...
 DATED AT
 this day of
, 19.....

THIS WARRANT shall be executed between
 and

.....
 Justice of the Peace
 O. Reg. 163/84, s. 1.
