

UC-NRLF



48 76 345

THE VENTILATION HAND-BOOK

HUBBARD

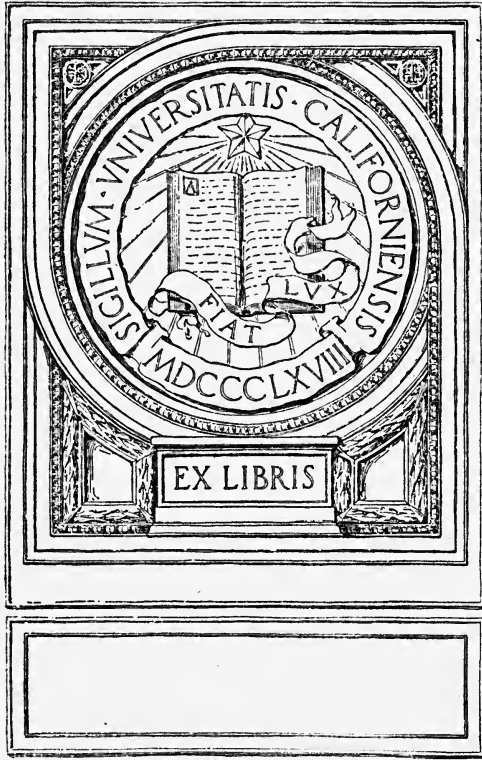

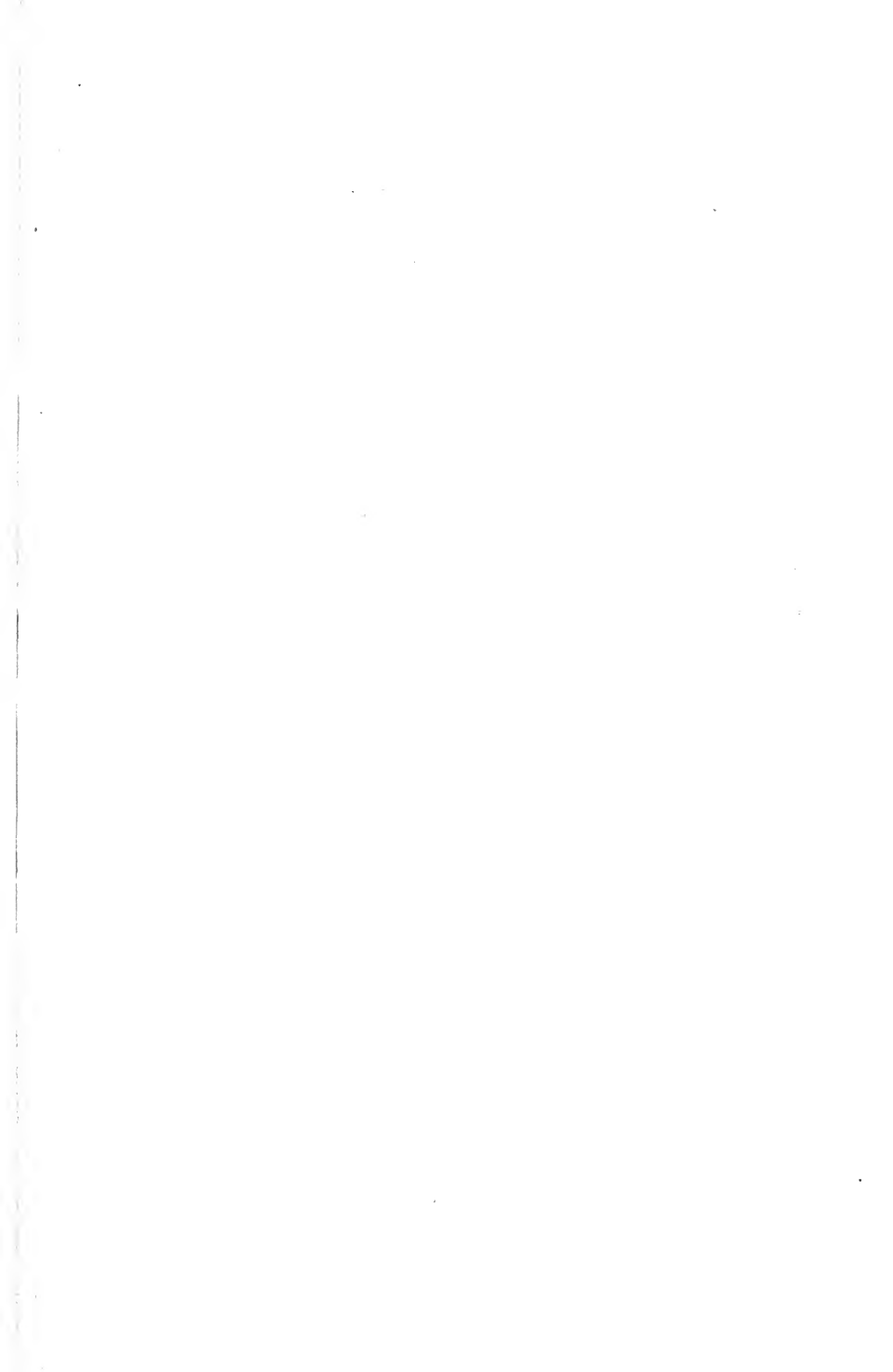

The Ventilation Hand Book

The Principles and Practice of Ventilation as Applied to Furnace Heating; Ducts, Flues and Dampers for Gravity Heating; Fans and Fan Work for Ventilation and Hot Blast Heating

BY CHARLES L. HUBBARD

A Series of Questions,
Answers and Descriptions,
Illustrated by One Hundred
and Thirty-seven Engravings

NEW YORK
CALIFORNIA

NEW YORK

The Sheet Metal Publication Company

1916

T. H. C.

COPYRIGHT, 1916
BY
THE SHEET METAL PUBLICATION COMPANY

NO. 1000
ANNOUNCER

THE HEPNER PRESS
NEW YORK

CONTENTS

	PAGE
PREFACE - - - - -	3
GENERAL DEFINITIONS, HEATING AND VENTILATING REQUIREMENTS, HUMIDITY - - - - -	7
CHAPTER II.	
SYSTEMS OF VENTILATION, GENERAL ARRANGEMENT, AIR MEASUREMENT - - - - -	26
CHAPTER III.	
COLD AIR SUPPLY DUCTS AND FLUES - - - - -	36
CHAPTER IV.	
WARM AIR SUPPLY DUCTS AND FLUES - - - - -	54
CHAPTER V.	
DISCHARGE VENTILATION - - - - -	66
CHAPTER VI.	
STACK CASINGS AND DAMPERS - - - - -	77
CHAPTER VII.	
FANS AND FAN DRIVES - - - - -	95
CHAPTER VIII.	
AIR FILTERS AND WASHERS - - - - -	119
CHAPTER IX.	
VENTILATION OF VARIOUS TYPES OF BUILDINGS - -	139
CHAPTER X.	
VENTILATION OF TOILETS AND CHEMICAL HOODS -	168
CHAPTER XI.	
WARM AIR FURNACE HEATING - - - - -	181

365554

Other Books by

CHARLES L. HUBBARD

POWER, HEATING AND
VENTILATION

IN THREE PARTS

Each complete in itself. Sold separately.

- Part I—Steam Power Plants
300 Pages. 183 Illustrations
- Part II—Heating and Ventilating Plants
308 Pages. 207 Illustrations
- Part III—Combined Power and Heating Plants
408 Pages. 220 Illustrations

P R E F A C E

The material contained in the following pages has been arranged from a series of articles prepared by the author for publication in SHEET METAL.

As indicated by the title, the object of the volume is to place in convenient form, for ready reference, the underlying principles of warm-air heating and ventilation, together with simple methods for computing the sizes of the various parts of a system of this kind.

Special care has been taken to keep all descriptions and mathematical work well within the understanding of the student and beginner.

The original form of questions and answers has been retained, as it tends to hold the interest of the reader more closely than the usual method of employing topics or headings.

After one has developed definite or fixed habits of study, the usual text-book arrangement may be followed without difficulty. When the reader has become thoroughly familiar with the contents of the handbook it will be advisable to make up a pocket note book based on data contained in the former, and covering the special line of work of the student. The general arrangement and method of condensing the data

should be carried out according to the ideas of the individual, and will prove of much value in fixing the information clearly in mind, as well as placing it in convenient form for quick reference upon the job. Furthermore, the reader is advised not to end his study with the present volume, but to broaden his knowledge by consulting freely the advanced works along the same line.

CHAPTER I.

GENERAL DEFINITIONS, HEATING AND VENTILATING REQUIREMENTS, HUMIDITY

What is meant by the term "Ventilation"?

Ventilation means the supplying of fresh air to a room or building for the purpose of improving its condition as regards the comfort and healthfulness of its occupants, and a system of ventilation comprises any arrangement of special apparatus for bringing about this result. Furnace heating, indirect steam and water heating, steam blast heating, etc., illustrate different types of ventilating systems, which should be properly designed and installed.

The removal of air from a building by means of vent flues or exhaust fans constitutes another form of ventilation. Natural ventilation, so called, is produced by the movement of fresh air through a room by means of open doors or windows.

How does the necessity for air compare with that for food and water?

It is possible for a man to live three weeks without food, three days without water, and three minutes without air; hence an abundance of fresh air is a matter of great importance in all rooms which are to be continuously occupied.

What is the effect of poor or vitiated air upon the occupants of a room?

Vitiated atmosphere lowers the vitality, and there-

fore increases the susceptibility to disease. That it decreases both the physical and mental capacity for work has been proved in many cases by the increased output, in shops and offices, where efficient systems of ventilation have been installed. The immediate effect of impure air is a feeling of weariness or drowsiness, usually accompanied by a dull headache.

What has been the effect upon the death rate in hospitals and prisons by the introduction of modern systems of ventilation?

Death rates have been greatly reduced by this means. Statistics show a reduction of about 90 per cent. in the case of children's hospitals, 70 per cent. in the general and army hospitals, and 90 per cent. in prisons.

Of what is the air composed?

Atmospheric air is a mechanical mixture, of which the principal constituents are oxygen and nitrogen, in the proportion of 1 part of oxygen to 1 of nitrogen by weight. In addition to these may be found carbon dioxide, and small quantities of nitric and nitrous acid, ammonia, sulphuretted hydrogen, sulphuric and sulphurous acids, floating organic and inorganic matter, and various local impurities. Water vapor is also found in varying amounts, depending upon the exposure to open bodies of water.

Which is the most important element of the air so far as heating and ventilation are concerned?

Oxygen is the most important element in this respect. It performs an active part in the process of combustion, and also in the chemical changes which takes place in the human lungs during respiration.

In the latter process it unites with the excess of carbon in the blood and forms carbon dioxide, or carbonic acid gas, which is given off with other impurities in the act of breathing.

Of what use is nitrogen in the atmosphere?

The presence of nitrogen in the air seems to be solely that of diluting the oxygen and rendering it less active. As an element of the air it is practically inert in all processes of combustion and respiration, passing through both the furnace and the lungs without change.

What is the significance of carbonic acid gas in a vitiated atmosphere, in what quantities does it exist in the open air, and what proportion is permissible in connection with good ventilation?

Carbonic acid gas in moderately large quantities, unless combined with other substances, is not especially harmful or disagreeable. Its general effect is to decrease the readiness with which the carbon of the blood unites with the oxygen, hence if present in sufficiently large quantities may produce fatal results.

Its real significance in connection with ventilation is the fact that it exists in a fixed proportion with certain other harmful gases and organisms which are produced in the process of respiration, and therefore acts as an indicator in determining the quality of the air. Its amount is easily determined by chemical analysis, and therefore provides a simple method of testing air samples for harmful constituents. Carbonic acid exists in the open country in the proportion of 3 to 5 parts in 10,000. For conditions of good ventilation it should not exceed 6 to 7 parts in 10,000, which allows for an increase of 2 to 3 parts over that of the open air.

How is the proportion of carbonic acid gas in the air of a room obtained?

The proportion of carbonic acid gas in a sample of air is commonly determined by finding the volume of air necessary to change a given amount of lime water from a clear to a milky appearance when shaken together in a glass bottle or other closed receptacle. There are several types of apparatus manufactured for this purpose, with special directions for the use of each. In the case of one device a given quantity of lime water is placed in a glass cylinder which is provided with a piston operated from the outside.

Air is drawn into the cylinder by means of the piston, and thoroughly mixed with the lime water by shaking. If the lime water becomes milky in appearance it indicates a certain definite amount of carbonic acid present in the air, depending upon the volume of the cylinder and the quantity of lime water used. If the lime water remains clear, the air is forced out and another cylinderful drawn in and the operation repeated. This is continued until a milky appearance is obtained, and the number of cylinderfuls of air required determines the proportion of carbonic acid gas present.

Table I.

Cubic centimeters of air.	Parts of carbonic acid gas in 10,000 parts of air.
100	16
200	12
250	10
300	8
350	7
400	6

If 15 cubic centimeters (.393 cubic in.) of lime

water are turned milky in appearance by being mixed with the following volume of air, the proportion of carbonic acid gas will be at least that given by the figures opposite each in the last column of Table I.

Standard of Air Purity

How is the standard of air purity for different degrees of ventilation determined?

The degree of purity is based upon the number of parts of carbonic acid contained in 10,000 parts of air, assuming 4 parts to be the average proportion in outdoor air, known as "pure" air, and 8 parts the proportion present when a room begins to feel stuffy and close, as the maximum to be allowed. In practice it is customary to so proportion the ventilating apparatus as to maintain a proportion at, or below, 6 parts of carbonic acid in 10,000 parts of air, under average working conditions.

What volume of pure air must be supplied per hour per occupant to maintain this degree of purity, and how is it computed?

In order to maintain a proportion of 6 parts of carbonic acid to 10,000 parts of air in a closed room, there must be supplied 3,000 cubic feet of outside air per hour per occupant. This is computed as follows: An adult person gives off about 0.6 cubic feet of carbonic acid gas per hour in the act of respiration. Assuming 4 parts of this gas in 10,000 of the outside air, and 6 parts in the room, allows for an increase of 2 parts; or there will be $2 \div 10,000 = 0.002$ cubic feet of carbonic acid added to each cubic foot of outside air supplied. Therefore, $0.6 \div 0.002 = 3,000$ cubic feet of fresh air will be required per hour per occupant to

12 *Definitions and Requirements*

maintain the assumed standard of ventilation; that is, 6 parts of carbonic acid in 10,000 of air.

What volume of air supply will be required to maintain other degrees of purity than the one above noted?

The air volume required for maintaining other degrees of purity is found by substituting the number of parts of carbonic acid to be allowed in place of 2 in the preceding example. The air volume for an increase of 1 to 4 parts over that of the outside air is given in Table II.

Table II.

Increase in carbonic acid over that of the outside air (parts in 10,000).	Standard parts of carbonic acid in 10,000 parts of air in the room.	Cubic feet of outside air required per hour per occupant.
1	5	6,000
2	6	3,000
3	7	2,000
4	8	1,500

In practical work how is the required air supply usually determined?

In practice it is customary to base the air supply on the number of occupants and the purpose for which the room or building is used. Laws in certain States fix the volume to be supplied in the case of school buildings at 30 cubic feet per minute per occupant, or 1,800 cubic feet per hour, although in the best class of work, the ventilating apparatus should be made of sufficient capacity to supply 50 cubic feet per minute, or 3,000 cubic feet per hour for each pupil. Table III gives approximately the quantity of air which should be supplied per minute per occupant in different kinds of buildings, in order to provide a good degree of ventilation.

What other method is used for determining the air supply when the number of occupants is variable or unknown?

When the number of occupants is not known, the air contents of the room may be changed a certain number of times an hour, instead of basing the supply on the number of people to be provided for. The number of changes per hour for various degrees of purity will depend upon the cubic feet of space allowed per occupant, which, of course, varies in rooms of different kinds.

Table III.

Kind of building.	Cubic feet of air per minute per occupant.
Churches	20 to 25
Halls	25 to 30
Theatres	30 to 35
Grammar Schools	40 to 45
High Schools	50 to 55
General Hospitals	70 to 80
Contagious Hospitals	80 to 100

For an air supply of 30 cubic feet per minute the following relation should exist between the cubic feet of space per person and the number of changes per hour, as given in Table IV. For other degrees of ventilation the number of changes will vary directly as the ratio between 30 and the assumed supply. For example, if 6 changes per hour corresponds to a supply of 30 cubic feet per minute per occupant, then 8

$$\begin{array}{r} 8 \times 30 \\ \text{changes per hour will correspond to a supply of } \frac{\quad}{6} \\ = 40 \text{ cubic feet per minute.} \end{array}$$

When the space allowed per person is not known, the

14 *Definitions and Requirements*

number of changes per hour may be based on the figures given in Table V, which, in practice, have been found to give satisfactory results under average conditions.

What is the effect of gas jets and lamps upon the ventilation of a room?

The burning of a gas jet or lamp not only consumes a certain amount of oxygen in the process of

Table IV.

Changes of air in room per hour.	Cubic feet of space allowed to each person.
18	100
9	200
6	300
4½	400
3½	500
3	600

combustion, but also throws off carbonic acid gas, thus lowering the standard of purity of the air. Under average condition each 4½-foot gas burner requires

Table V.

Kind of room.	Air changes per hour.
Living rooms	3 to 4
Restaurants	5 to 6
Offices	4 to 5
Public waiting rooms	5 to 6
Public libraries	4 to 5
Museums	3 to 4
Locker rooms	5 to 6
Public toilets	6 to 7

from 45 to 50 cubic feet of air per hour, which must be added to that necessary for the occupants of the room. The general introduction of incandescent electric lighting has been of much assistance in the prob-

lem of ventilation in the case of theatres and other public buildings which must be brilliantly illuminated. With this method of lighting the incandescent filament is enclosed in a glass bulb, from which the air has been exhausted, and no combustion takes place.

What effect does the leakage of air around doors and windows have upon the ventilation of a room?

It has been shown by tests that the leakage of air around the doors and windows and through the walls of a room of average construction will amount to from one to three changes of the entire contents per hour. In practice it is customary to count on at least one change per hour when considering the matter of ventilation. This is the reason why very fair ventilation may be obtained in dwelling houses, under certain conditions, with direct steam or hot water heating, and where no special means of ventilation have been provided. For example, a room 12 feet by 12 feet by eight feet has a cubic contents of approximately 1,200 feet. Assuming an air change due to leakage of one and one-half times per hour gives a supply of 1,800 cubic feet, which is a fair amount for one person. With more or less frequent opening of doors this supply might be doubled, making the room suitable for occupancy by two people without special means of ventilation.

Source of Air Supply

From what source should the fresh air be taken for ventilating purposes?

The outside air for a ventilating system should be taken from a point where there is little opportunity for dirt or objectionable odors being drawn into the building. In the case of churches, schools, etc., sur-

rounded by grass plots of considerable extent, the air may be taken from an elevation slightly above the ground level. In cities and large towns, where paving or dirt roads exist close to the building, the air supply should be taken from a point sufficiently high up to avoid drawing in surface dust, etc. In cases of this kind the air is brought down to the basement through a special intake of masonry or sheet metal provided with a suitable hood and shut off damper. Surface and cellar air is to be avoided unless the surroundings are sanitary. When the air is taken from an elevation care should be exercised to avoid smoke from nearby chimneys and foul air from adjacent vent flues. This may be done by placing the intake as far away as possible from such objects and also by protecting it by means of shields or deflectors, so that smoke or foul air will not be easily drawn into it under ordinary conditions.

Air Filters

How is air purified when it is impossible to prevent the presence of soot and dust?

Soot and dust are removed from air which is to be used for ventilating purposes by the use of dry filters and air washers or purifiers.

What is a dry filter, and what precautions are to be taken in its design and operation?

A dry filter usually consists of a series of cloth screens or bags so arranged as to present a large surface for the passage of air through them. They are placed between the inlet and the fan or heater and act as a strainer for removing the coarser particles of soot and dirt from the entering air. Care should be taken to have the surface for the passage of air bear a cer-

tain relation to the volume passing through, in order that the resistance may not be too great, and also to make the screens or bags easily removable so they may be cleaned at frequent intervals.

What is an air washer or purifier, and how does it operate?

An air washer removes the impurities from the entering air by passing it through a thick spray of water, instead of cloth, as in the case of a dry filter. This process removes a very large per cent. of the dry foreign matter contained in the air without offering the resistance of the average dry filter of moderate size. The excess of moisture is removed from the air by passing it through a series of baffle plates or eliminators after leaving the spray chamber. Purifiers of this type also act as air coolers in the summer time, and are therefore of especial value in the ventilation of hospitals.

Humidity

What is meant by the term "humidity"?

The term humidity relates to the amount of moisture which the atmosphere contains in suspension. Actual humidity means the actual weight of water which a given volume of air contains, while relative humidity relates to the amount of moisture present as compared with that of the point of saturation.

What is meant by "saturation"?

When air contains all the water in suspension which it is possible for it to contain at that temperature, it is said to be saturated. The humidity of air at the point of saturation is taken as 100 per cent. If the relative humidity of air at a given temperature is 75

per cent. it means that it holds in suspension only three-fourths as much water as it is possible for it to hold at that temperature. The actual humidity varies greatly with the temperature of the air, each having its own point of saturation.

How is the degree of humidity measured?

The humidity of the air at any given temperature is commonly found by gradually cooling a body and noting at what temperature dew or moisture is deposited upon it from the surrounding atmosphere. The depositing of moisture indicates the temperature at which the air is saturated, and by knowing both this and the actual temperature of the surrounding atmosphere, the percentage of humidity can easily be determined by the use of tables prepared especially for this purpose. The instrument commonly employed for this consists of two thermometers, the bulb of one being exposed directly to the surrounding air while that of the other is kept constantly wet by means of a piece of cloth or wicking extending into a cup filled with water. If the air is saturated, both thermometers will indicate the same temperature; but if not saturated, the readings will vary according to the degree of humidity.

What is a hygrometer?

A hygrometer is a device for determining the humidity of the air from direct readings, without making computations. A common form, called a hygrophant, is shown in Figure 1, and consists primarily of wet and dry bulb thermometers as shown. The evaporation from the moist wicking attached to the one on the left tends to cool it in proportion to the rate of evaporation. As this rate is dependent upon the amount of moisture

already in the air, the readings of the two thermometers serve to determine the relative humidity, which may be read directly from the scale on the vertical cylinder between the two thermometers. The numbers at the top of the columns on the cylinder (the

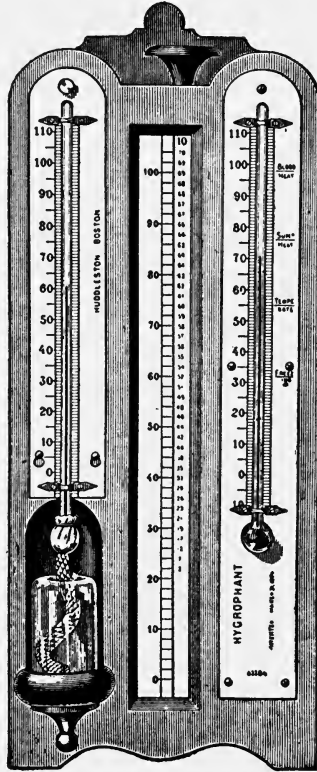

Fig. 1—A Hygrophant

small figures at the right of the heavy line), indicate the differences in temperature between the two thermometers (25 on the upper column and 75 on the

lower column, in the cut). The smaller figures beneath are the relative humidities, any value of which for a given difference may be read opposite the wet bulb temperature reading on the central plate beside it. Referring to Figure 1, the readings of the wet and dry bulb thermometers are 130 and 155 degrees respectively, or a difference of $155-130=25$ degrees. The cylinder is revolved by the small knob seen at the top until the number 25 appears at the head of one of the columns, which is the top one in this case. Following down the figures on the central plate at the left of the heavy line to 130, the reading of the wet bulb thermometer, the relative humidity is read from the corresponding column at the right, and is found to be 49 per cent. in the present case.

What effect does the degree of humidity have upon the air used for ventilation?

When the air is too dry, evaporation takes place more rapidly from the body, and produces a feeling of chilliness, even though the room be at a comfortable temperature. The effect of dry air upon the mucous membrane in the respiration tract is one of irritation, and renders a person liable to infection from floating germs. The average outdoor air in winter contains only about 2 grains of moisture per cubic foot, and when this air has been drawn over steam coils and raised to a temperature of 70 degrees, its relative humidity will not be more than about 25 per cent. For a comfortable and healthful atmosphere the amount of moisture should run from 50 to 70 per cent. of complete saturation. If higher than this, condensation is apt to take place on walls and windows, which are cooler than the atmosphere of the room.

The temperature of a room in which the air has been properly moistened may be kept 4 or 5 degrees lower than where the air is dry. This is because of the reduced evaporation from the bodies of the occupants, which tends to make the room seem equally warm, although actually at a lower temperature.

How is moisture introduced into air used for ventilating purposes?

Air is moistened in various ways, one of the simplest methods being the use of a water or evaporating pan placed inside the casing of a hot air furnace. The warm air passing over this takes up a sufficient amount of moisture to give it the desired quality for proper ventilation. In other cases evaporating pans are attached to the backs of steam or water radiators. When a fan system is employed the air may be moistened by the use of a washer of the type already described in connection with filters or evaporation pans may be placed in the main airways. In some cases steam is mixed with the entering air, being introduced through a number of small openings under a low pressure. Certain devices are also in use, especially in factories, where water is broken into a very fine spray and thrown into the air in the form of a mist, which is readily taken up by evaporation.

Relation of Heat to Ventilaton

How is the subject of heat connected with that of ventilation?

Heating and ventilation are intimately connected because fresh air cannot be properly admitted to a room unless its temperature has first been raised to a point equal to or above that of the room itself. If the

air is admitted at a temperature much below 70 degrees, cold drafts will be produced with resulting bad effects upon the occupants of the room. Devices admitting cold air through window openings, etc., can only be successful when so arranged that the entering air is first passed over a radiator or mixed with warm currents before reaching the occupants. In hot blast heating, indirect gravity heating, and furnace heating, both heating and ventilation are provided for in the same system.

How is heat measured?

The unit employed in measuring heat is known as the British Thermal Unit (B.T.U.) commonly called a thermal or heat unit (T.U.) and is the amount of heat required to raise the temperature of one pound of water one degree F.

What is meant by "temperature"?

Temperature means the intensity of heat and not the volume or quantity. An object may be very hot, that is, have a high temperature, and still contain less heat than some other object which has a lower temperature. For example, a teakettle of boiling water at a temperature of 212 degrees may contain a less quantity of heat than a kitchen boiler filled with water at a temperature of 150 degrees.

How is temperature commonly expressed in this country?

Temperature is commonly expressed in degrees Fahrenheit (F.) in this country. With this scale, the bulb of the thermometer is first placed in melting ice and then in boiling water, open to the atmosphere, and the difference in the height to which the mercury

or other fluid rises divided into 180 spaces called degrees. The temperature of melting ice, or the freezing point so called, is taken as 32 degrees above zero, which makes the boiling point $32+180=212$ degrees.

What quantity of heat is required to raise the temperature of air under given conditions?

One thermal unit will raise the temperature of one cubic foot of air 55 degrees, or it will raise the temperature of 55 cubic feet of air one degree. Example 1. What quantity of heat will be required to raise the temperature of 100,000 cubic feet of air 70 degrees?

$$\text{Solution } \frac{100,000 \times 70}{55} = 130,000 \text{ T. U.}$$

Example 2. To what temperature above zero will 140,000 T. U. raise 200,000 cubic feet of air?

$$\text{Solution } \frac{140,000 \times 55}{200,000} = 38 \text{ degrees.}$$

Example 3. How many cubic feet of air will 150,000 T. U. raise through 60 degrees?

$$\text{Solution } \frac{150,000 \times 55}{60} = 134,000 \text{ cubic feet.}$$

These methods of computation may be expressed in the form of simple equations as follows:

$$(1) H = \frac{V \times T}{55}, \quad (2) T = \frac{H \times 55}{V}, \quad (3) V = \frac{H \times 55}{T},$$

in which

H = heat required, in thermal units.

T = rise in temperature, in degrees F.

V = volume of air, in cubic feet.

24 *Definitions and Requirements*

How is the heat required for ventilation computed?

In determining the maximum heat required for ventilation alone it is customary to assume that the temperature of the air is to be raised from 0 to 70 degrees, and compute the thermal units required by equation 1.

Example 4. What quantity of heat will be required per hour in zero weather for ventilating a grammar school room seating 40 pupils, and allowing 2,000 cubic feet of fresh air per hour each?

$$\text{Solution — } H = \frac{2,000 \times 40 \times 70}{55} = 100,000 \text{ T.U.}$$

(approximately.)

If the outside temperature was 35 degrees above zero the heat required per hour would be only one-half that given above, or 50,000 T. U.

In southern New England and the Middle States it is customary to consider the coldest weather as zero when designing a heating and ventilating system, while in the more northern parts of the country temperatures 20 degrees or more below zero must be provided for.

How may the cost of ventilation be determined for any given case?

The cost of ventilation will depend upon the volume of air supplied, the average outside temperature, and the price of fuel. Assuming the average outside temperature for the entire heating season in New England to be 35 degrees, the heat required for rais-

ing the temperature of each 1,000 cubic feet of air to 70 degrees will be

$$\frac{1,000 \times 35}{55} = 637 \text{ T. U.}$$

In burning one pound of good anthracite coal in a hot-air furnace or under a boiler, about 8,000 T. V. are utilized in warming the air. Therefore, $637 \div 8,000 = 0.8$ pounds of coal are required for each 1,000 cubic feet of fresh air supplied. Assuming 3,000 cubic feet per hour per person, the cost per hour will be that given in Table VI.

Table VI.

Cost of coal per ton (2,000 lbs.).	Cost of ventilation per hour per person.
\$5.00	\$.0060
6.00	.0072
7.00	.0084
8.00	.0096

Applying this to a school of 400 pupils, and allowing thirty-eight weeks of thirty hours each, the cost of ventilation for the school year, with coal at \$6.00 per ton will be

$$30 \times 38 \times 400 \times .0072 = \$3,283.20$$

CHAPTER II.

SYSTEMS OF VENTILATION, GENERAL ARRANGEMENT, AIR MEASUREMENT

How is air moved for ventilating purposes?

Air for ventilating purposes is moved in two ways; first, by the expansion and decrease in weight due to heating, and second, by means of fans.

What are the advantages and disadvantages of these two methods?

The gravity method, so-called, is the simpler, and is employed in ordinary furnace heating and also in the case of indirect steam and water heating. When the temperature of the air supply must be raised for heating purposes, its decrease in weight may be used as a means for raising it to the rooms above, without extra expense, and in many instances this method is to be preferred on account of its simplicity. The force produced in this way, however, is very slight, and is easily overcome by friction in the air-ways and by outside wind pressure. When there is a considerable horizontal distance between the source of heat and the base of the vertical uptake flue it is often necessary to supplement the force of gravity by using a fan. By this method any reasonable amount of resistance may be overcome, and the ventilating system made reliable under all ordinary conditions. When applied to exhaust or discharge ventilation, the

fan method is much less expensive to operate, because the heat necessary to produce the required draft or velocity through the vent flues is greatly in excess of that which would be used in a steam engine to produce the same power. This condition differs from that of air supply because all heat used for this purpose is lost, being added to the air in the vent flue after it leaves the room and therefore being of no use for warming purposes. The advantages of the gravity system are its simplicity, being free from all mechanism requiring skilled attendance, and its low cost of installation. These features make it especially adapted to dwelling houses, small school buildings, churches, hall, etc., where the source of heat may be placed near the bases of the warm air flues and where the resistance to air flow is at a minimum. The fan system is more complicated, requiring some degree of skill on the part of those in charge, and is more expensive to install. On the other hand it produces much better results in buildings of large size, and is adapted to many locations where it would be impossible to secure adequate ventilation by any other means, as in theaters and other auditoriums of large size. A fan system in connection with an air washer provides a means of furnishing pure fresh air in certain localities where large quantities of soot and dust are present. Dry filters, the only type adapted to gravity heating, are so bulky for a given capacity that they can only be used in connection with systems of small size.

What two methods of ventilation are in common use employing fans for the movement of air?

The two methods of ventilation employing fans are

known as the plenum or positive method, and the exhaust or discharge method.

What are the advantages and disadvantages of each?

In the plenum method the air is forced into the room under a low pressure, with the result that the points of admission and the temperature of the entering air are under control. In addition to this, the room being under a slight pressure, all leakage is outward, thus preventing the drawing in of foul air from adjacent surroundings. This is often of much importance in the case of theaters and halls, which are in close proximity to foyers, lobbys, smoking rooms, toilets, etc. The most important point, however, is that the fan may be connected directly with the heater by means of suitable airways, thus making it possible to accurately control the temperature of the air delivered to the room. Practically the only disadvantages of the plenum system are its limitations under certain conditions, except in the case of smoking rooms, locker rooms, toilets, etc., to which it is not adapted. While possessing the various advantages named above, it does not provide a complete system of ventilation for a room like a theatre, where there are pockets beneath the balconies where the air movement is very sluggish unless special means are provided to produce a brisk circulation. In the exhaust method the air is drawn out of the room at one of more points by means of a fan. This produces a partial vacuum within the room with the result that outside air leaks in at the points of least resistance. It is evident that the air removed by the fan must be replaced by other air from outside, and unless this is properly warmed the process will be accompanied by uncomfortable,

if not dangerous drafts. In many cases it is a difficult matter to control the air temperature in this way. For the reasons above stated, the exhaust system of ventilation is generally employed as an adjunct to the plenum system, except under special conditions. In the case of rooms containing objectionable odors, such as chemical laboratories, toilets, smoking rooms, etc., it is desirable to maintain a slight vacuum in order to prevent any outward leakage to other parts of the building. Such rooms should be ventilated by the exhaust rather than by the leakage of air through spaces beneath the doors or by way of grilles in the lower panels. In school buildings, churches, etc., where the rooms are regular in form and the vent flues quite direct, there is usually sufficient pressure from a plenum system to force the air out without other means, but in theatres, etc., where there are air pockets and "dead spaces" it becomes necessary to use the plenum and exhaust systems in combinations to secure the best results.

Location of Supply and Vent Registers

At what points should the air be admitted to and removed from a room to secure the best results?

The best points for the admission and removal of air will depend upon the use of the room, the volume of air moved, and the type of heating or ventilating system to be used. In the case of dwelling houses and similar buildings employing hot air furnaces and indirect steam, the air is usually introduced through registers, either in the floor or baseboard. The latter are preferable, both on account of cleanliness and because they leave the floors free for the use of carpets and rugs. On the other hand, floor registers are

more convenient for warming and drying the feet, and are, in general, cheaper to install. For these reasons, especially the latter, floor registers are more frequently used than wall or baseboard registers. Buildings of this type are not usually provided with special means for discharge ventilation, outward leakage being depended upon around doors and windows and through fireplaces. If vent registers are furnished, they should be placed in the wall near the floor rather than at the ceiling, as in that case much of the heat would be carried from the room without being utilized for warming. Also, the greater the proportion of carbonic acid gas the heavier the air, hence the impure air falls to the floor and should be removed at that level except in special cases. In school rooms, and large hospital wards, where large volumes of air are introduced at moderate temperatures, the inlets are commonly placed 7 or 8 feet above the floor, and the vent outlets at the floor level as already described. When air is admitted to a room in this manner, it first rises to the ceiling, and then as it cools, falls gradually to the breathing line, thus keeping up a slow movement downward throughout practically the whole volume of the room. The relative location of the inlet and vent registers will depend somewhat upon local conditions and the available wall space. In general, however, they should be in the same wall, common arrangements being shown in Figs. 2, 3 and 4. The general path of the air when admitted and discharged through openings placed in this manner is shown in diagram in Fig. 5, and illustrates the evenness of diffusion throughout the room. In the case of theatres and large churches, where the audience is closely packed together, the best results are secured

by admitting the air at the floor through a large number of small openings and removing it at the ceiling.

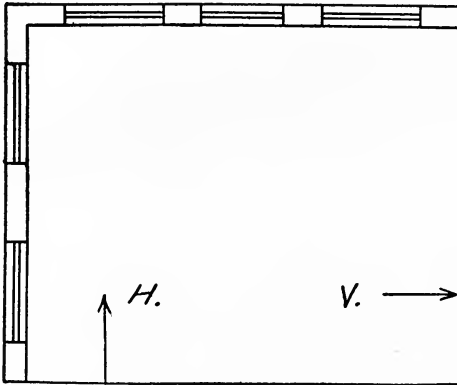

Fig. 2—Locating Inlet and Vent Register

Air introduced in this manner forms practically a solid column by the time it reaches the breathing line,

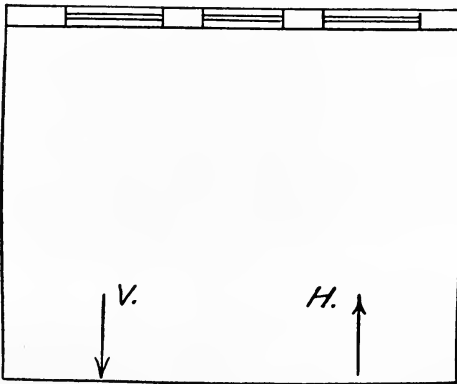

Fig. 3—Arrangement for Inlet and Vent Register

and its temperature being still further increased by the animal heat given off from the bodies of the audi-

ence, it continues to rise, although containing an increased amount of carbonic acid gas, and is taken off

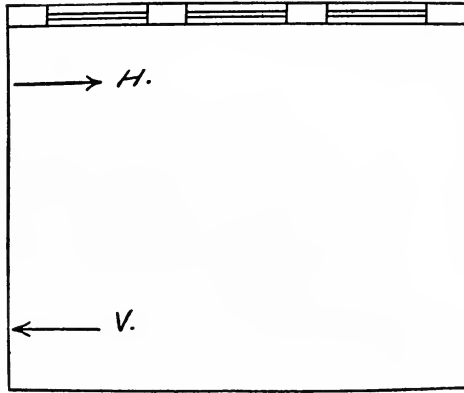

Fig. 4—Another Form of Arrangement

through ceiling registers in the main auditorium and at the rear of the balconies, these connecting with

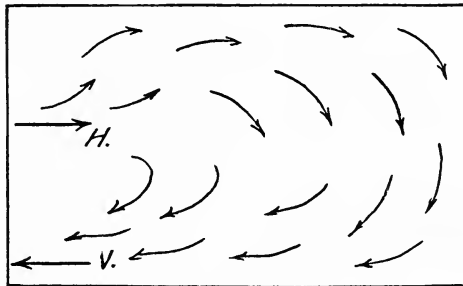

Fig. 5—General Path of Air

exhaust fans either in the attic or basement as most convenient.

Air Velocity

At what velocity should air be introduced into a room?

In the case of furnace heating the warm air will enter through the first floor registers at a velocity ranging from 200 to 250 feet per minute, and through the second floor registers at a velocity of 300 to 350 feet per minute at the temperatures ordinarily carried in average winter weather. With indirect steam and hot water the velocities will be somewhat less, on account of the lower temperature of the entering air. Velocities of 200 feet per minute for first floor registers and 300 feet for the second floor are about as high as will be realized in practice under ordinary conditions. With these low velocities no special provision is needed to diffuse the entering air to avoid unpleasant drafts. In the case of forced ventilation by means of a fan care must be taken to limit the velocity of the entering air by properly proportioning the flues and registers and by using diffusers in special cases. The velocity through floor registers should never exceed 300 feet per minute, and 350 feet per minute should be the limit for wall registers in schoolhouse work. When properly designed diffusers are placed over the inlets a velocity as high as 500 feet per minute may be allowed without unpleasant drafts.

How are air velocities measured?

Air velocities are commonly measured by means of an instrument called an anemometer, one form of which is shown in Fig. 6. This consists of a delicate fan wheel whose motion is transmitted to a system of gearing within the case. This movement is indicated by the hands on the dial, from which the linear move-

ment of the air current in which it is placed may be read for any given length of time. The movement or velocity of the air, in feet per minute, multiplied by the sectional area in square feet of the duct or orifice, will give the volume in cubic feet per minute.

What precautions are necessary in measuring air velocities in this manner?

The air entering through a register, especially if placed in the wall, does not have the same velocity over the entire surface, usually being much greater

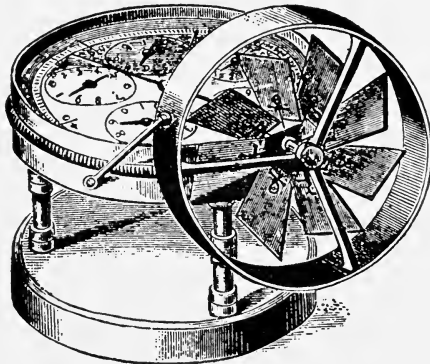

Fig. 6—An Anemometer

at the top of the register than at the bottom. On this account great care must be taken to get readings which will represent the average over the entire area of the opening. For approximate work this may be done by slowly moving the anemometer across the opening in either vertical or horizontal parallel lines, so that the reading will be made up from velocities taken from all parts of the opening, and will therefore represent a fair average. If more accurate readings are desired, the opening may be divided into a number of squares by stretching threads across it, and readings be taken

at the center of each square. The average of all the readings will give the velocity to be used in computing the air volume. When taking measurements at registers for ordinary work the anemometer should be held about 4 inches from the grill work, as at this point the air passing through the various openings has been formed into a solid column, and the gross area of the register may be used in computing the air volume. If more accuracy is required, the register should be removed. Minute readings are commonly used for making adjustments and approximations. For careful measurements a longer period of five minutes or so should be used.

CHAPTER III.

COLD AIR SUPPLY DUCTS AND FLUES

What is one of the first things to be considered in designing a system of ventilation or warm-air heating?

One of the first items of importance in the design of a system of this kind is the provision of an abundant supply of fresh outside air for the furnaces, or the heating stacks in the case of steam and hot-water systems.

Is this matter commonly considered as carefully as it should be in the average building of small or medium size?

It is not; the furnaces or heating stacks are often placed where most convenient and the "cold-air box," or supply duct, made a matter of minor importance, both as regards size, form, and location.

What general method should be followed in laying out the different parts of a heating system of this type?

The cold air supply, the source of heat, and the warm-air or distributing flues should be considered together by means of a rough sketch, and then such changes made as will give the best results, considering the system as a whole, without improving one part at the expense of some other detail equally important.

What special items should be considered in designing the fresh-air inlets and ducts?

Ample size, to deliver the normal supply required with the probable minimum velocity of flow under average conditions; location of inlets, so that the pressure due to prevailing winds may be taken advantage of, so far as possible, in the case of gravity systems; inlets upon two or more sides of the building, when practicable, in order that the supply may be as uniform as possible regardless of the direction of the wind; some method of automatically equalizing the effect of the wind pressure, so that sudden gusts will not carry large volumes of cool air into the rooms; the selection of inlet windows so located that dust or foul odors will not be carried into the building under normal conditions.

Are these same precautions necessary in case of a fan system?

No; the suction produced by a fan is sufficiently strong to overcome ordinary changes in wind pressure, and a single inlet of proper size, located as most convenient, is all that is usually necessary in cases of this kind.

Size and Location of Cold-Air Supply Duct

How is the area of the cold-air box or inlet to a furnace commonly determined?

If short, and without sharp bends, its area should not be less than two-thirds the total area of all the hot-air pipes connecting with the furnace.

If it is of considerable length, or somewhat indirect, it should be made from three-fourths to the full size of all the hot-air pipes.

How is the area of the cold-air duct supplying an indirect steam or hot-water stack determined in the case of dwelling houses and similar buildings?

The area of the cold-air duct to an indirect heating stack in dwelling house work should be made from $1\frac{1}{2}$ to 2 square inches per square foot of radiating surface, depending upon the length and directness of the duct.

How is the area of the cold-air supply duct determined in the case of halls, churches, schools and hospitals?

In buildings of this type, where larger volumes of air are to be provided at lower temperature, the area of the supply duct may be made from 2 to $2\frac{1}{2}$ square inches for each square foot of radiating surface in the stack.

If a single air inlet is provided, upon which side of the house should it be placed?

Usually the prevailing winds in the coldest weather are from the north or west, and the cold-air inlet should be placed so that the winds from this general direction will blow directly into it. In some cases near the coast the strongest winds are from the east, and the inlet should be located accordingly.

When more than one inlet is provided how are they located, and how are the ducts arranged?

When there are two inlets, one is commonly placed so as to open toward the northwest and the other toward the southeast. Sometimes the northeast and southwest are more convenient or effective, owing to local conditions. When two inlets are used in this way, each should be made the full size called for by the methods previously given, and should connect with a main or trunk line, leading to the furnaces or heating stacks. Each inlet should be provided with a hand damper, or automatic air-check, to prevent the air from

blowing into one inlet and out of the other without passing through the heaters. When three or four inlets are used, the size should be such that the areas of any two will be equal to the total area required.

Cold Air Chambers and Return Ducts

What is the best method of equalizing the air flow to furnace and other indirect heating systems, without the use of hand dampers?

Cold-air chambers, so called, are used for this purpose. These consist primarily of a small room partitioned off in the basement, and taking outside air from one or more inlets. The duct supplying the heating system is so placed that the outside air cannot blow directly into it, and the velocity of flow through it is due rather to the pressure within the air-chamber than to the effect of the gusts of wind entering through the inlet windows.

What is the usual method of constructing the cold-air box for a single furnace, and what precautions should be taken?

The cold-air box for the usual furnace system is commonly connected with one of the regular cellar windows, and is then carried overhead to a point near the furnace where it drops and connects with the base of the casing. Care should be taken, however, not to let the vertical portion of this duct come too near the furnace, for if the air within it becomes warmed to any extent it will tend to produce an upward current, and therefore interfere with the supply, either by weakening the flow or actually reversing its direction in some cases. For this reason, it is well to drop near the inlet window, preferably on an angle, and then extend the duct to the furnace horizontally, either above or

below the basement floor as may be desired. When the horizontal distance is of considerable length and floor space is valuable an underground duct of brick or cement may be used, care being taken to make it watertight. The cold-air box should be provided with an adjustable slide or damper for regulating the flow of air in windy weather, but should be so constructed that it cannot be entirely closed, else the air supply may be completely shut off through carelessness and the furnace fail to heat properly.

What is a "return-air" duct, and what are its advantages and disadvantages?

A return-air duct in furnace heating is an arrangement by means of which a portion or all of the air supplied to the furnace may be taken from the interior of the house and reheated, instead of admitting the whole volume required from out of doors. The advantage of this is that in windy weather more fresh air is likely to be admitted than is necessary for good ventilation.

This may result in cold rooms if the furnace does not have sufficient reserve capacity, or in waste of fuel if the house is kept warm under these conditions. On the other hand, if all or too large a proportion of the air is taken from the inside, air of the proper degree of purity will not be obtained for good ventilation. Systems equipped in this manner are commonly operated in mild or still weather by taking practically all of the air supply from out of doors and using the return arrangement only for warming up the house in the morning and on windy days.

Of what material are cold-air supply ducts usually constructed?

In the cheaper grade of furnace heated houses the cold-air box is commonly made of matched sheathing. The objection to this is that the joints are apt to open, due to shrinkage of the wood, and cause the leakage of cellar air and dust into the duct. This can be avoided to some extent by thoroughly oiling and painting the woodwork of the duct, both outside and inside. For the best construction in furnace heating, and for indirect steam and water systems, galvanized iron ducts should always be used, or a combination of iron and masonry where the latter may be used to advantage in underground work and in damp locations.

What devices are commonly used for closing the inlet windows and for regulating the flow of air to the different furnaces and heating stacks?

Each cold-air inlet window should be closed by a sash or damper according to its size. It is usually hinged at the top and arranged to close by its own weight, although local conditions may require other treatment in certain cases. When hinged at the top it is a good plan to have it close at a small angle from the vertical, so that a flat bar of lead or iron attached to the lower edge will hold it in place against ordinary wind pressures. As dampers of this kind are not usually accessible they are commonly opened by means of a chain and pulley arrangement brought outside the duct. Full guarded pulleys and plumbers' chain of good weight should be used for this purpose. Wooden handles or stout iron rings attached to the ends of the chains give a finished appearance, and hook or key-hole plates should be provided for adjustment. Small inlet openings are usually covered with galvanized wire netting of $\frac{1}{2}$ to $\frac{3}{4}$ inch mesh, while larger ones

generally have, in addition, a heavy wire grille in a channel iron frame screwed or hinged to the window.

How is cold-air or mixing chamber constructed?

One form of mixing chamber is shown in Fig. 7. In this case the entering outdoor air is first thrown downward by a deflecting hood, which breaks the force of the current during high winds and also causes the coarser particles of dirt and dust to fall to the floor. The opening into the flue leading to the furnace is at a point near the ceiling, and so situated that

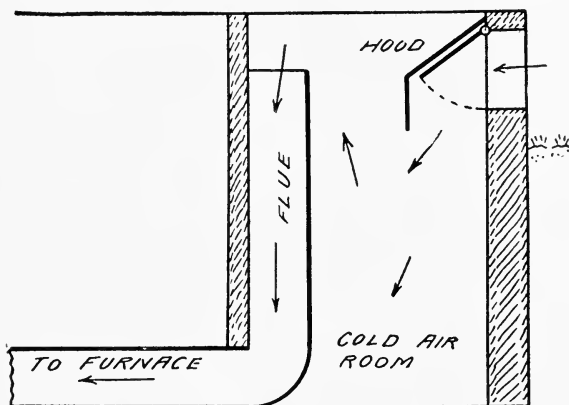

Fig. 7—One Form of Mixing Chamber

the entering air cannot blow into it, hence the velocity of flow through it is produced by the general pressure in the chamber. When air is returned from the building, to be mixed with outside air and reheated, it is best brought back to the cold air chamber, where it mingles with the cooler air before passing into the furnace casing. In the arrangement shown the inlet window is hinged at the top and swings upward into the hood as indicated. The chamber may be parti-

tioned off from the basement by means of 8-inch brick walls, wire lath and plaster, or a wooden construction of matched sheathing may be used if it is desired to keep the expense as low as possible.

The hood and duct in the cut are of galvanized iron, but these may also be constructed of wood if more convenient, although special care must be taken to make the joints tight against the inleakage of dust. Another form of air chamber is shown in Fig. 8. In

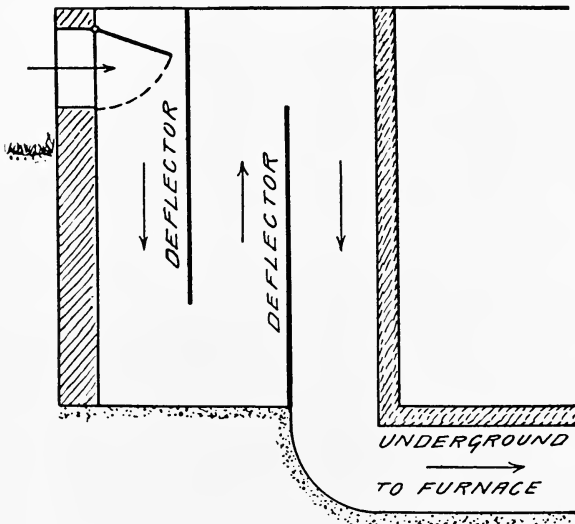

Fig. 8—Another Form of Mixing Chamber

this case the hood and downtake flue are replaced by two or more deflectors, or baffle plates, extending entirely across the chamber. These serve the purpose of breaking up the air currents and throwing down the heavier particles of dirt. The deflectors shown in this case are of galvanized iron, and the under-

ground duct leading to the furnace is constructed of concrete.

What should be the size of a cold-air or mixing chamber?

There is no particular rule to be followed in regard to the size, as much will depend upon the available space. The larger it is made, within practical limits, the better will be the results. For a single furnace of medium size a room 5 or 6 feet square may be used if space permits it. Sometimes, when the basement is clean and contains nothing objectionable, a room of sufficient size is partitioned off to accommodate the furnace and coal bin and the remainder used as a mixing chamber. This arrangement is especially adapted to cases where return air ducts are brought down from different rooms, more or less widely scattered, and where the mixture of air is at a somewhat higher temperature than out of doors, otherwise the floors of the first story rooms will become chilled.

What form of device is sometimes used for automatically regulating the air flow into a cold-air box without the use of a mixing chamber?

A device of this kind is shown in Fig. 9, and consists essentially of a damper D hinged at the top as indicated. When there is no wind this damper hangs in a vertical position and gives the full area of the duct for the passage of air beneath it as shown by the arrow. As the strength of the wind increases the damper is forced inward, thus cutting down the area of the passage as indicated by the dotted line starting from the lower edge of D.

By properly weighting this damper it can be adjusted to close a given amount for any strength of wind pressure as may be desired.

Cold-Air Supply for Schoolhouses

What are some of the details of construction employed in schoolhouses and similar buildings where hot-air furnaces are employed and the air is taken from two sides of the building without the use of mixing chambers?

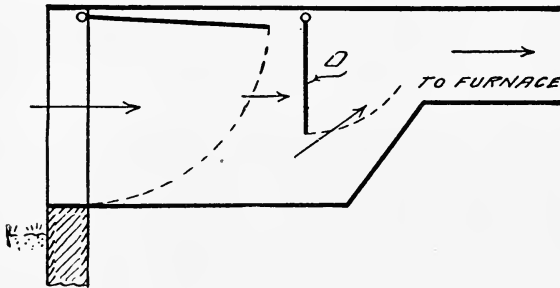

Fig. 9—Device for Regulating Air Flow

An arrangement of this kind is illustrated in Fig. 10, which shows in diagram the basement of a building heated by two furnaces.

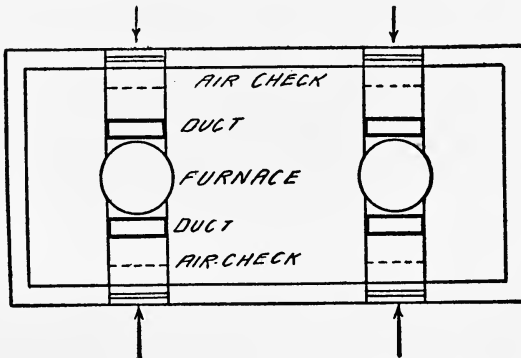

Fig. 10—Plan of Basement of Building Heated by Two Furnaces

A duct of the full area required is taken from each

side of the building and carried along the ceiling to a point near the furnace, where it drops and connects with the base of the casing. If more convenient, the ducts may drop at the basement wall and extend underground to the furnace. An important detail in connection with this arrangement is the air check placed between each inlet window and the furnace to prevent the air from passing in at one side of the building and out at the other without entering the furnace casing.

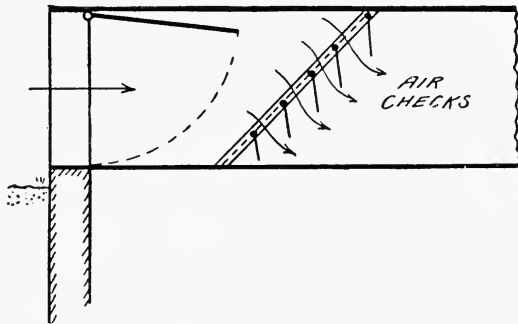

Fig. 11—Simple Form of Air Check

What is the construction of an air-check and how does it operate?

A simple form of air check for use in a horizontal duct is shown in Fig. 11. This consists of a light iron frame covered with a wire netting of $\frac{3}{4}$ to 1 inch mesh and placed in the duct in an inclined position as indicated. To this are attached horizontal rods, 3-16 to $\frac{1}{4}$ inch in diameter, carrying flaps or checks of strong duck or canvas, hemmed at both edges. As will be seen by reference to the cut these will open inward upon the slightest air pressure from the outside, but any reversal of the current will close them tightly against the netting.

These checks or flaps are made from 4 to 6 inches in width and extend entirely across the duct. A door should be placed in the side of the duct for inspecting the checks and adjusting them in case they become caught or out of place.

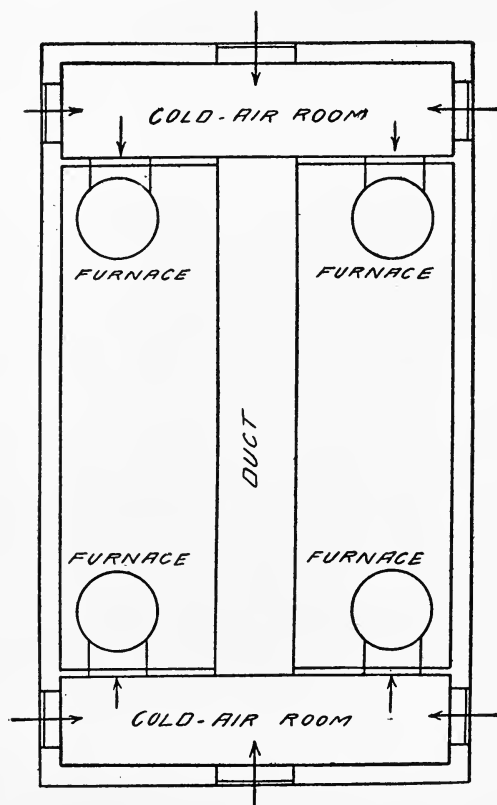

Fig. 12—Plan of Church Basement, Showing Equalizing Duct

This device should be located far enough from the inlet window to be out of the way of snow and rain.

Equalizing Ducts and Trunk-Line Systems

What is an "equalizing duct," as used in connection with two or more cold-air chambers?

The use of an equalizing duct is illustrated in Fig. 12, which shows the basement layout for a church or hall heated by four furnaces. In this arrangement there are two cold-air rooms, one at each end of the building, and each provided with inlets to take air from three points of the compass. The furnaces are placed in the main basement and take their air supply from the chambers, as indicated by the arrows. The efficiency of the system is increased by connecting the two cold-air chambers by an equalizing duct, so called, which has the effect of making all of the furnaces draw their air supply from a single reservoir having inlets upon all four sides of the building. By a proper opening or closing of the inlet windows advantage can be taken of the wind pressure, regardless of its direction. If desired, the supply system can be made practically automatic by placing galvanized iron casings, containing air checks, inside of each inlet window. Ordinarily a building of this size is in charge of a competent janitor, who is easily able to adjust the inlet windows to take advantage of the wind from day to day or as the building is in use.

What arrangement may be used in place of that just described, when the basement is used for other purposes and the cold-air chambers must be independent and kept as small as possible?

A layout of this kind, using indirect heating stacks instead of hot-air furnaces, is shown in Fig. 13. In this case the cold-air chambers are independent and have two inlet windows, one in each outside wall.

The sashes or dampers are in two parts and hinged at the sides. They are also arranged to open either outward or inward and may be adjusted in any position desired.

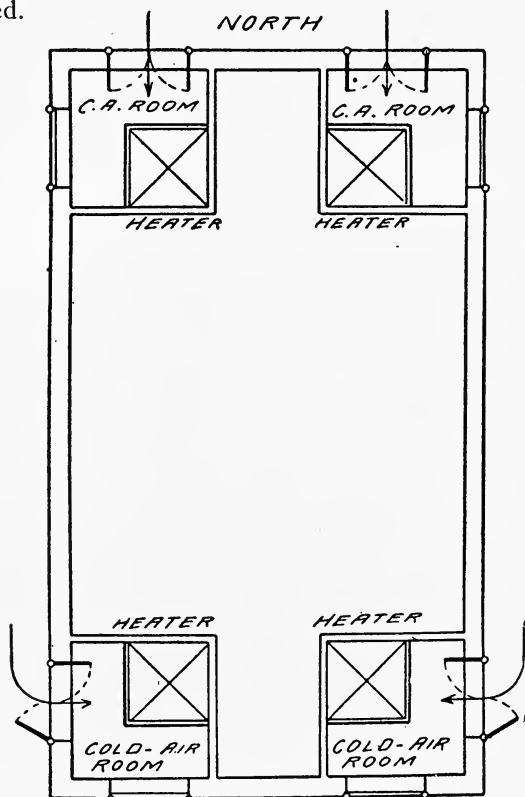

Fig. 13—Plan of Church Basement Arranged for Independent Air Chamber

In the case shown it is assumed that the wind is from the north, hence the northerly windows in the air chambers at the top of the cut are open with the

sashes swung inward. The effect of the wind pressure is taken advantage of in case of the air chambers at the other end of the building by arranging the sashes in the side windows to act as deflectors by catching the air as it passes by and turning it into the rooms as indicated by the curved arrows. It is evident that the sashes or shutters in the different windows may be set so as to catch the wind from any direction. The heating stacks in this case are placed inside the air chambers and are provided with casings of galvanized iron having open bottoms, as shown in section in Fig. 14. The path of the air is indicated by arrows, from

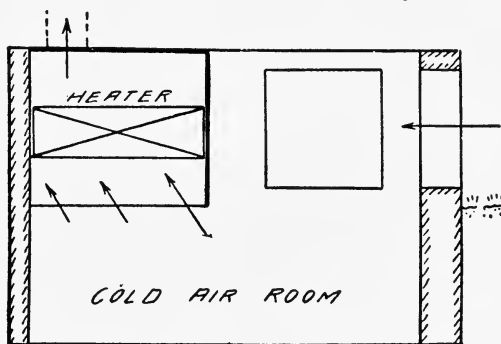

Fig. 14—Section of Air Chamber Used in Fig. 13

the inlet, through the heater, and up the hot-air flue to the room above.

What is a “trunk line” system of air supply for indirect steam and hot-water heating?

A trunk line system is where all of the heating stacks are supplied from a single reservoir with air under practically the same pressure. Such an arrangement is shown in diagram in Fig. 15. The air supply is taken in through four openings, one on each side of

the building, and are of such size that the sum of any two will give the full area required. Each inlet is provided with a sash or damper for closing and an air

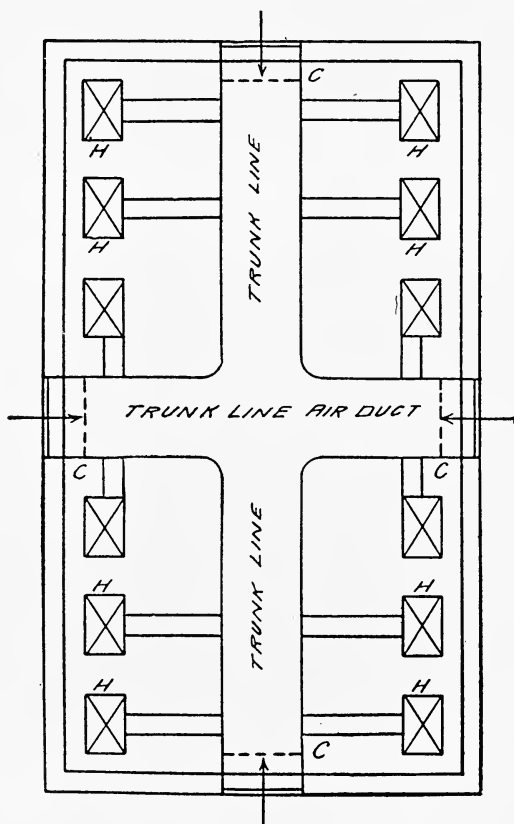

Fig. 15—Plan Showing Arrangement of Trunk Line Duct

check, C, for preventing the outflow of air on the leeward side. The heating stacks, H, H, are connected with the trunk line by branches of the proper size,

each being provided with an adjustable damper for regulating the air flow to the different rooms. If all of the heaters are connected with the same room, as in the case of a church or hall, these dampers may be omitted. But if they supply separate rooms, especially on different floors, dampers should be provided.

Air Supply for Fan Systems

What are the general requirements for the air supply to a fan system and how are the ducts usually constructed?

The supply duct to a fan system should be so located that the air will be as pure and free from dust as possible. In cities and towns it is usually taken from an elevation to avoid surface dust, but in doing this the location of adjacent chimneys should be considered, else the soot and smoke drawn in will be worse than the surface dirt.

All of these matters should be considered in locating the intake, also the position of the fan room and the general arrangement and construction of the building. Fresh air downtakes are made of brick, concrete, wire lath and plaster and of galvanized iron, according to size and local conditions.

A typical air shaft upon the outside of a building, or in a light well, is shown in Fig. 16. The top should be provided with a hood for keeping out the snow and rain, with wire netting over the inlets. A shutoff damper at some point in the shaft is necessary for closing when the fan is not in use. When the building is surrounded by a lawn the air may usually be taken in at a point slightly above the ground level.

How is the size of supply duct for a fan system determined?

The size is usually based on the velocity of air flow through it, which may be taken from 800 to 1,000 feet per minute under average conditions. This

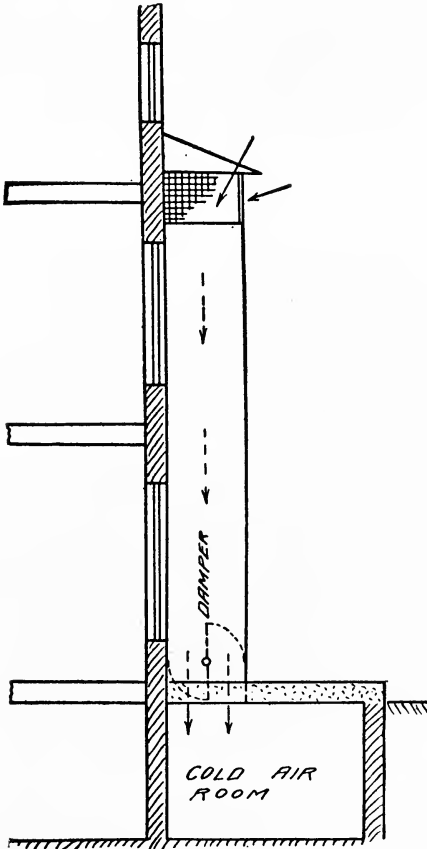

Fig. 16—Outside Air Shaft

means that 1 square foot sectional area should be provided for each 800 to 1,000 cubic feet of air to be supplied to the fan per minute.

CHAPTER IV.

WARM AIR DUCTS AND FLUES

What does the general term warm-air ducts and flues usually include?

This term includes all ducts and flues carrying warm or tempered air whether for supply or discharge ventilation. Briefly, it refers to the air-passages between the heaters and the rooms, and between the rooms and the outdoor air.

How are warm-air flues subdivided?

Warm air flues are subdivided into supply and vent flues, according to their use, and are rectangular, circular, or oval in form.

What are the advantages and disadvantages of each?

Rectangular ducts take up the least room for a given capacity and fit into the building construction better than any other form, especially those of large size. They are more easily constructed and braced for rigidity than those of circular form. Rectangular ducts are used extensively in connection with fan work, where large volumes of air are moved through basements and other occupied rooms. Ducts of this kind are often carried at the ceiling and must take up as little room as possible. In the case of indirect gravity heating ducts of this form are also used for the reasons already mentioned.

The principal disadvantage of rectangular ducts is the greater friction to the air flow for a given size,

the corners adding comparatively little to the carrying capacity.

Ducts of circular form are the most efficient, so far as friction is concerned, and are extensively used for the smaller sizes in both fan and gravity work on this account. The larger sizes are bulky, require a considerable amount of head room, and are difficult to construct with the required rigidity for fan work. Both circular and oval pipes are used in furnace heating, the latter more especially for vertical flues which are carried up in partitions. Unless flattened too much they have some of the advantages of the rectangular flue while retaining to a considerable extent the efficiency of the circular form.

Methods of Construction

What construction should be given to the tops of all warm-air inlet flues to obtain the best results?

All supply flues should be curved at the top in order to turn the air into the room with the least possible resistance.

Should this same construction be applied to the bottoms of vent flues?

It should when possible, although it is not so important as in case of the supply flues. Both kinds of flues may be constructed of galvanized iron, wire lath and plaster, brick, terra cotta blocks, glazed tile, or flue linings.

Under what conditions are each commonly employed?

Galvanized iron is more frequently used than any other material where it is not exposed to excessive moisture. It is comparatively light, may be easily

made in any form and concealed in the building construction. Wire lath and plaster on an angle-iron frame is frequently used in the construction of very large ducts and flues. This is especially adapted to cases where main distributing ducts are formed by placing false ceilings in the corridor ways of large buildings. When this is done it should be smoothly finished on the inside. Brick flues are often provided in school buildings and similar cases where air ways of large size are required. Great care should be taken to make them smooth on the inside and to remove any projecting pieces of mortar, else the friction will interfere with their successful operation. Terra cotta blocks are often substituted for brick in this class of work; when used, the same precautions should be taken as noted above. When for any reason air ways are to be carried underground, they are usually made water-tight by constructing them of concrete, or of glazed tile with cement joints. Ducts of large size are commonly built in rectangular form of concrete construction, while the smaller sizes 24 inches in diameter and smaller, are of tile. When it is desired to carry up flues of small size in brick walls, rectangular flue linings should be used to give a smooth finish to the interior.

In determining the sizes of tile and of flue linings to be used it should be remembered that the former are commonly designated by the inside diameter and the latter by the outside dimensions.

When should flues be protected against the cold, and how is this commonly done under different conditions?

When warm-air flues are carried up in outside walls,

or other exposed locations, they should be insulated in some manner against loss of heat by transmission and radiation. This applies to all supply flues, and to vent flues which are not connected with an exhaust fan. Galvanized iron flues are commonly protected with some form of block or plastic covering of asbestos or magnesia on the exposed side, or sides, before furring in. In the case of brick flues air spaces 2 to 4 inches in thickness are commonly provided.

Registers and Grilles

What form of construction is commonly used in the inlet and outlet openings to the rooms?

These openings are usually provided with a register or grille of suitable form and material.

What is the general construction of the ordinary hot-air register, and when is it used?

This commonly consists of a grille or fretwork of cast iron, back of which is a series of vanes or shutters by means of which the opening may be closed when it is desired to shut off the air from the heater or fan. The fretwork without the vanes is commonly called a **register face**, and is used in vents and other openings where it is not desired to close off the duct, or where special dampers are provided for this purpose.

What is a grille and where is it used?

A grille commonly refers to a register face of wire or other light ornamental construction, and may be used either in a supply or a vent opening. It is not provided with vanes or shutters, a special damper being furnished for this purpose in the connecting duct when necessary.

How should the area of a register or grille be taken?

The free area through a register will depend upon its pattern. As commonly designed, the net or free area may be taken at about two-thirds that of the overall or gross area.

Location and Size of Flues for Gravity Work

What conditions should be considered in locating the supply flues for indirect gravity heating?

The flues, if possible, should be carried up in inside walls; they should be direct, and without bends or offsets, except where positively necessary. Flues for school buildings are commonly arranged in groups of two to four, while those in hospitals and similar buildings, are necessarily more scattered owing to the greater number and smaller size of the rooms.

What precaution should be taken in mixing the warm and the cool air currents from a furnace or indirect stack in order to prevent cold drafts in the rooms above?

When warm air and cold air are mixed by means of a special damper, as at D in Figs. 17 and 18, care should be taken that the cooler air will pass up the back of the flue and so flow into the room through the top of the inlet register above the warm-air current. In Fig. 17 the arrangement is such that the cool air passes up the front of the flue, as indicated by the arrows drawn in full lines, with the result that it falls directly toward the floor after passing into the room, while the warm air, shown by the dotted arrows, rises to the ceiling. In Fig. 18 the arrangement is reversed, the warm air passing up the front of the flue and into the room through the bottom of the register. In this case the rising currents of warm air and falling cur-

rents of cool air are mixed as they enter the room, and cold drafts are thus prevented. This is shown graphically by the full and dotted arrows passing through the register in Fig. 18. The desired result in cases of this kind can usually be obtained by a suitable arrangement of the mixing damper D. When it is not

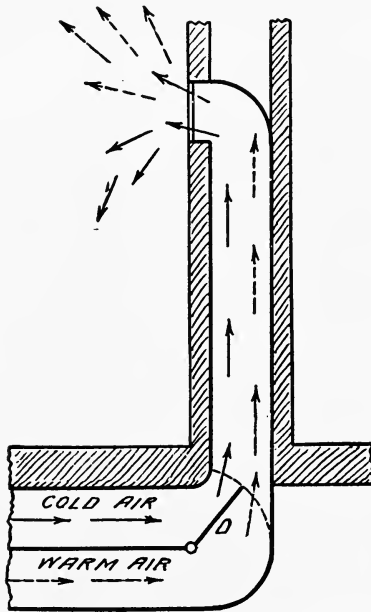

Fig. 17—Improper Arrangement of Warm and Cold Air Flues

to the front of the flue by means of a spiral deflector placed a short distance above the damper. possible to do this, the warm air is sometimes thrown

When two or more flues connect with the same furnace or heating stack, how is the air flow through them equalized?

The airflow through a series of supply flues is equalized by placing adjustable dampers in the uptakes at some convenient point between the heater and the inlet register. These dampers should be set or adjusted to give the desired results with the system working under normal conditions, and then fastened

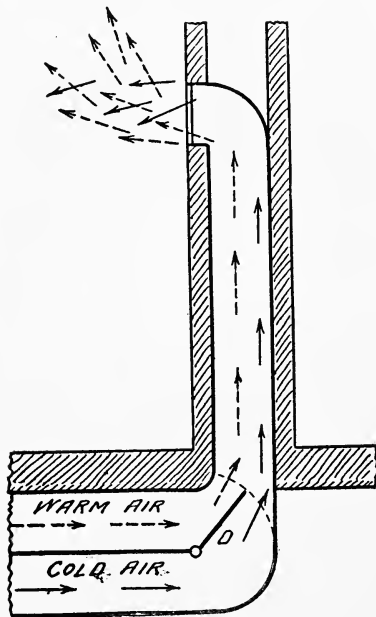

Fig. 18—Proper Arrangement of Warm Air and Cold Air Flues

in place permanently by means of a set screw or other convenient device.

How are the sectional areas of the supply flues determined for different classes of buildings?

In the case of indirect steam and water heating, it is customary to allow $1\frac{1}{2}$ square inches for each square

foot of radiating surface in the stack for first floor rooms, $1\frac{1}{4}$ square inches for second floor rooms, and 1 square inch for third floor rooms, in dwelling houses; and 2, $1\frac{1}{2}$ and $1\frac{1}{4}$ square inches respectively for cottage hospitals. In the case of schoolhouses, supply flues to standard classrooms seating fifty pupils may be proportioned as follows: First floor, 7 square feet; second floor, 6 square feet; third floor, 5 square feet. For churches and halls it is customary to allow from 10 to 12 square feet sectional area for each 100 occupants.

Location and Size of Ducts and Flues for Fan Systems

How are the supply flues commonly located in case of a fan system?

The same general rules should be followed in locating the supply flues for a fan system as for one operating by gravity, although the various conditions mentioned are not of so much importance. This is because any small loss in motive power due to friction or cooling of the air may be easily offset by speeding up the fan slightly. However, waste of power or heat means increased operating expenses, so that all unnecessary losses should be eliminated so far as possible.

How is the discharge outlet from a fan usually connected with the uptake flues to the rooms?

The main duct and branches connecting the fan with the flues are usually of galvanized iron when overhead, and of masonry of some form when carried underground.

How is the air properly distributed among the different branches?

The air is distributed as required, first, by proportioning the sectional area to the volume of air to be carried, and second, by the use of adjustable deflectors at the junctions of the branches, as shown in Fig. 19.

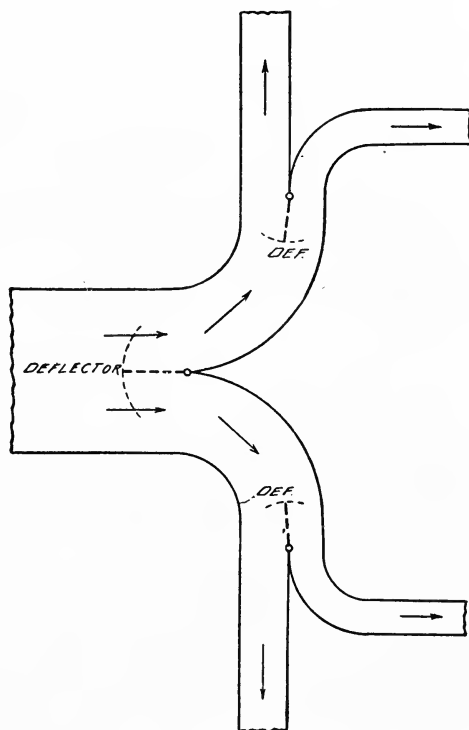

Fig. 19—Plan View Showing Arrangement of Deflectors

How are these deflectors constructed?

They are usually made of heavy galvanized iron, rigidly stiffened to prevent vibration, and provided with means for securing in position after permanent adjustment.

How are the sizes of the distributing ducts determined in fan work?

The sectional areas of the main ducts and branches are usually based on an assumed velocity of airflow, and the volume to be carried in a given length of time. In the case of schoolhouses, churches, etc., velocities of 1,000 to 1,200 feet per minute are allowed in the main ducts, and from 800 to 1,000 feet per minute in the smaller branches leading to the flues. In factory and shop heating, with forced blast, velocities from 1,500 to 2,000 feet per minute are employed.

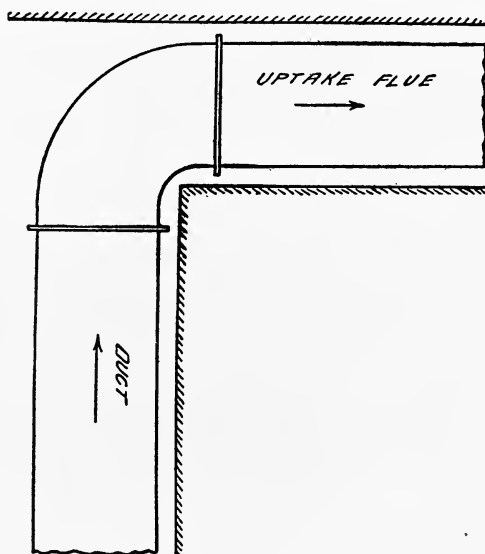

Fig. 20—Bend to Avoid Friction

How should the horizontal ducts from the fan be joined to the uptake flues to give the best results?

The change of direction from horizontal to vertical should be made by means of an easy bend, as shown in

Fig. 20, to reduce frictional resistance as much as possible.

How are the sizes of the uptake flues determined for fan work in different types of buildings?

These, like the horizontal ducts, are based on the velocity of airflow and the volume of air to be delivered. For schools, halls and churches, velocities of 600 to 700 feet per minute are commonly employed, while in the case of office buildings, institutions, etc., where small flues are built into the walls, higher velocities of 1,000 to 1,200 feet per minute may be used, if the flues are smooth, in order to reduce their size. In cases of this kind it is necessary to run the fan at a higher rate of speed with increased power.

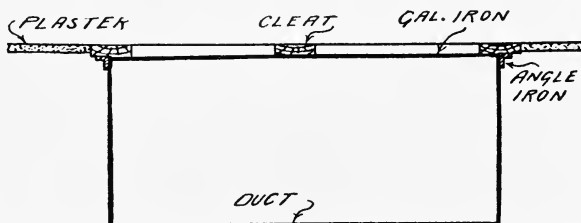

Fig. 21—Method of Supporting Overhead Ducts

How are overhead ducts of galvanized iron usually supported?

Different methods of support are used, depending upon the size of the duct and the construction of the ceiling to which they are attached. A good arrangement having a neat appearance, is shown in section in Fig. 21. Wooden cleats running lengthwise of the duct are fastened to the ceiling, screws or nails being used if the joists are of wood, and clamps if of iron. Light angle irons are screwed to the outer cleats and the sides of the duct are fastened to this by stove bolts or

rivets. The top of the duct may be stiffened by nailing to the cleats. The same arrangement may be applied to the smaller branches by omitting the angle iron and nailing the top of the duct directly to the cleats, using washers of good size under the nail heads.

How is the air introduced into the room from a fan system, without unpleasant drafts?

If the air is blown into a room at the flue velocity of 600 or 700 feet per minute, disagreeable drafts will be produced. This is avoided by placing a series of vertical blades in the opening for spreading the air

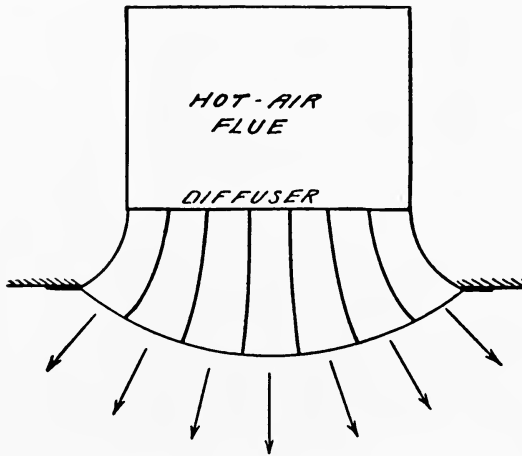

Fig. 22—Arrangement of Diffuser

and breaking up the current as it enters the room. Such an arrangement is called a diffuser, and one form is shown in section in Fig. 22. Other patterns are designed to hang in front of grilles or registers already in place.

CHAPTER V.

DISCHARGE VENTILATION

What points should be considered in locating the vent flues of a building?

The vent flues are commonly placed along the inner walls, both on account of inducing a proper circulation of air in the room and for keeping them warm when the airflow through them is due to gravity alone. When connected with an exhaust fan, the matter of air temperature does not enter into the problem.

What two general types of vent flues are commonly used?

Vent flues are known as **individual flues** and **common** or **group flues**. The former term refers to cases where a separate flue or series of flues is provided for each room. Common flues may connect with a number of rooms. Separate flues are usually more satisfactory, as the outflow from the different rooms is more easily regulated, and sound cannot pass from one room to another, which is a matter of considerable importance in the case of hospitals and school buildings. Individual vent flues may be carried through the roof separately or may be gathered into one or more common chambers in the attic, which in turn are vented by means of a single shaft through the roof. Common or group flues, being of comparatively large size, are usually constructed of brick and carried through the roof independently.

What is the office of a deflector in connection with a vent flue?

A deflector is commonly used back of each room outlet into a common flue, in order to direct the air upward and prevent it from passing from one room into another. They also serve to some extent as sound deadeners.

Size of Vent Flues

How are the sizes of vent flues determined in gravity heating, in different types of buildings?

In the case of dwelling houses and cottage hospitals they may be given the same sectional area as the warm air flues supplying the rooms. In school buildings, two stories in height, they may be made to have 6 square feet area on the first floor and 7 square feet on the second. In three-story buildings they may be 5 square feet on the first floor, 6 on the second, and 7 on the third. In the case of churches and halls they may be given the same area as the supply flues, adding also a ceiling vent equal to one-half that area for use in warm or heavy weather. When schoolrooms are supplied with air by means of a fan, and the air passes out through the vent flues by means of gravity and the slight pressure due to the fan, the vent flue from a standard size classroom should be made about 5 square feet in sectional area. When vent flues are connected with an exhaust fan, the size is based on the velocity of flow, which commonly ranges from 600 to 800 feet per minute.

Special Forms of Vent Outlets

What are back drafts and how may they be prevented?

The term back draft is used to indicate a reversal of current in the vent flues. This is apt to take place at night or in the morning before a strong current has been established in the warm-air supply flues. This may be prevented by the use of dampers in the vent flues near the top for night closing, or it may be done

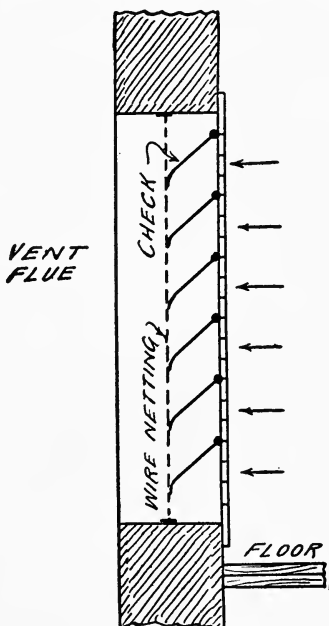

Fig. 23—Checks to Prevent Back Draft

automatically by placing air-checks in the room outlets, as shown in section in Figure 23. These consist of a series of light checks of gossamer cloth strung on wires and attached to the back of the grille or register face as indicated. A wire netting of $\frac{3}{4}$ -inch mesh is placed about 3 inches back of the grille to support the tips of the checks and

prevent fluttering when air is passing through them from the room. Any tendency to a reversal of flow will close them tightly against the back of the grille and prevent the cold air from flowing into the room.

What special form of vent outlet is frequently used in hospitals and sometimes in school buildings and what are its advantages?

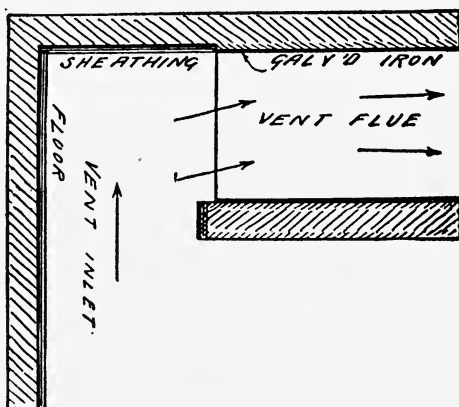

Fig. 24—Sanitary Outlet Used in Hospitals

A sanitary outlet especially adapted to hospitals is shown in section in Fig. 24. In this case no grille or register is used in the opening, and the floor is carried through to the back side of the flue as indicated. With this arrangement there is no chance for the accumulation of dust, as the bottom of the flue is swept out each time the floor is cleaned.

Flue Heaters and Aspirating Coils

What means are usually necessary to strengthen the outward flow of air through the vent flues in a gravity system of indirect heating?

In order to produce sufficient draft in cases of this kind it is usually necessary to heat the air in the vent flues to a temperature somewhat above that of the rooms with which they connect.

What are some of the methods commonly employed for doing this?

A simple method often used for heating two class room vent-flues in a school building is shown in Fig. 25. This is especially adapted to furnace heating

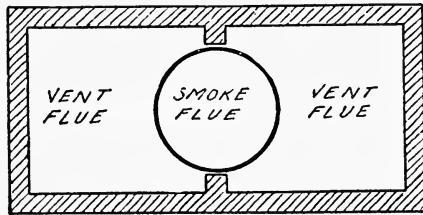

Fig. 25—Heating Two Vents in Schoolhouse

where a separate furnace is provided for each pair of class rooms. In this arrangement an iron chimney or stack is used, and is carried up between the two vents as indicated. The heat radiated from the hot stack is sufficient to properly warm the outflowing air in the flues and produce a strong draft. This device is especially economical, as the heat utilized would otherwise be wasted.

Another method commonly used for this purpose in connection with furnace heating employs what is known as a stack heater, and is shown in section in Fig. 26. This consists of a small stove of special form supported in the base of the flue, which should be of brick through the basement portion at least. The vents from the first floor are brought down and connected

with the main uptake flue below the heater. Vents from the upper floors may be connected directly into the flue by using deflectors back of the openings, of the

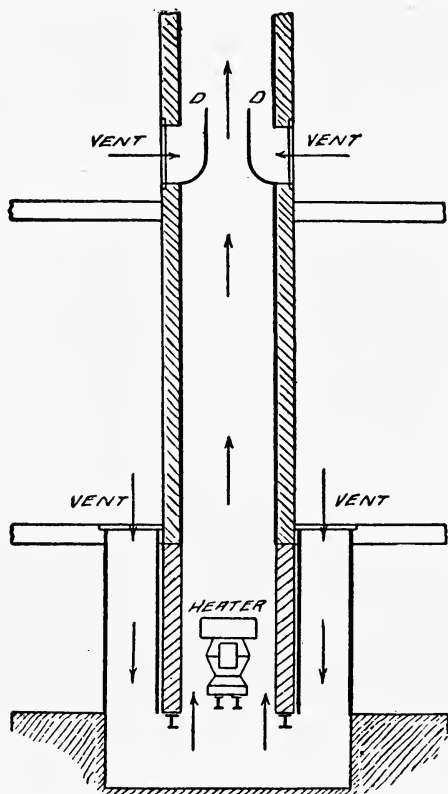

Fig. 26—Use of Stack Heater for Heating Vent

general form shown at D D. Another form of flue heater used in connection with indirect steam heating, and known as an aspirating coil, is shown in Fig. 27. This is made up of lengths of steam pipe screwed into

a cast iron base, and placed in the vent flue just above the outlet from the room. The cut illustrates a group

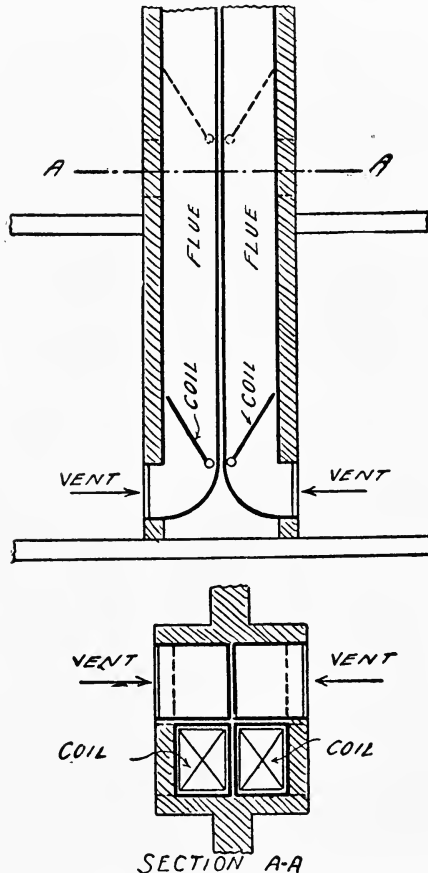

Fig. 27—Plan and Sectional View of Flue with Aspiring Coil

of four independent flues, two from the first floor and two from the second. A separate heater or coil is placed in each flue as indicated.

Hoods and Wind Guards

What means are commonly provided for protecting the top of an outboard vent shaft?

Outboard vent shafts should be protected with some form of hood to prevent the entrance of snow and rain, and also to avoid so far as possible, down drafts of cold air. Figs. 28 and 29 show two forms of patented devices for this purpose. The latter has a glass top to admit light, and is also provided with a shut-off

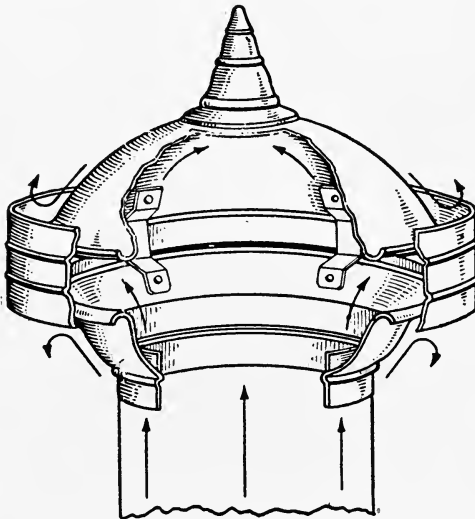

Fig. 28—One Form of Vent Shaft Protection

damper for closing when not in use. The prime object in the design of a hood of this kind is to prevent the entrance of snow and rain with a minimum obstruction to the airflow.

Fig. 30 shows a typical design of the outboard vent connections from a gravity system of heating. The various uptake flues in this case are connected with the main vent chamber by means of two large horizontal ducts in the attic space. The top of the main outboard

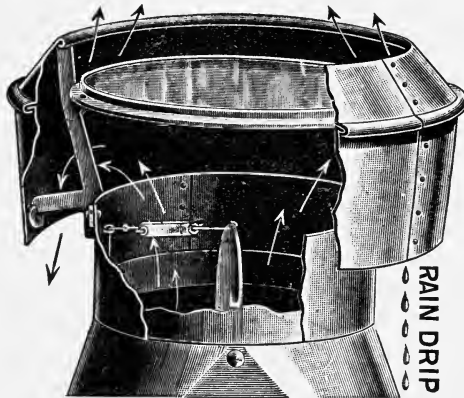

Fig. 29—Another Form of Vent Shaft Protection

shaft is provided with a roof and the air passes outward through louvred openings in the sides, as indicated by the arrows. The drippings from rain or melting snow are caught by a water-tight pan at the bottom of the shaft and drained away to the sewer by means of suitable piping. A shutoff damper is placed directly beneath the main hood as indicated.

What is the purpose of a wind-guard, and how is it constructed?

A wind-guard is a device for preventing strong winds from flowing into the louvre openings of a vent shaft and producing down drafts. It is usually con-

structured of sheet metal on an iron frame, and extends a short distance above the roof of the vent hood. A

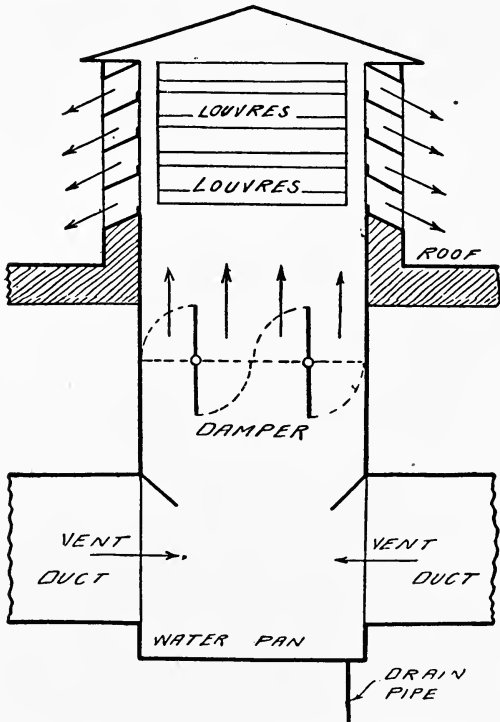

Fig. 30—Ordinary Method of Protecting Outboard Flues

space should be left at the bottom for drainage, as indicated in Fig. 31.

How is the discharge outlet from an exhaust fan of the blower type usually constructed?

In cases of this kind a shaft the size and form of the fan outlet is commonly carried above the roof and provided with a cone hood, or deflector, as shown in

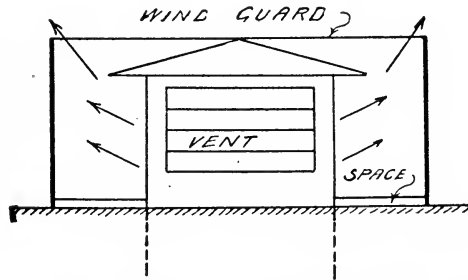

Fig. 31—Wind-Guard for Louvre

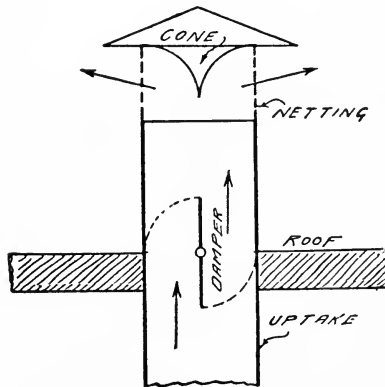

Fig. 32—Cone Hood with Deflector

Fig. 32. A damper should be placed in the shaft for closing when the fan is not in use.

CHAPTER VI.

STACK CASINGS AND DAMPERS

What is the third division of sheet metal work in a system of indirect heating and ventilation?

The stack casings and dampers make up the third division of the sheet metal work, and should be given careful attention in order to secure the best results.

Design of Stack Casings

What conditions should be considered in the design and construction of stack casing?

There should be ample air space above and below the heater, commonly ranging from 8 to 12 inches in dwelling house work, and as much as 24 inches in the case of large stacks in schools and churches. It is the usual practice to make the cold air space beneath the heating stack about three-quarters that of the hot air space above, but if there is ample room they may be made the same. The casings should be constructed of iron of good weight, not lighter than No. 24 gauge, and should be put together with stove bolts so they may be readily removed for access to the heater. It is important that the sides fit the heater closely, else cold air will find its way past and the rooms will fail to heat properly in consequence.

How are the air passages arranged in the simplest form of casing?

One of the simplest arrangements is shown in Fig.

33. The cold air supply is brought along the ceiling from the inlet window and drops beneath the heater as indicated by the arrows. It then rises between the sections, and becoming heated in the passage flows upward through the supply flue to the room above. A slide should be placed in the bottom of the casing for access to the heater.

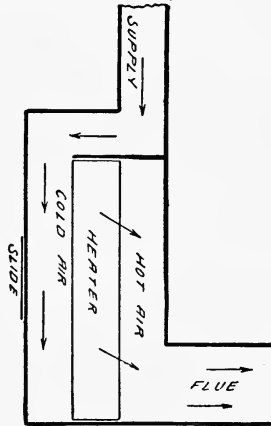

Fig. 33—Arrangement of Air Passages

What arrangement is sometimes used for catching and removing the dirt which falls through floor registers, and what is the advantage of this?

When the heating stack is placed directly beneath a floor register, dirt and dust are likely to accumulate upon it which, when heated, will cause disagreeable odors to rise to the room above. This may be avoided by placing the heater at one side of the uptake flue, as in Fig. 34, and providing a dirt pan and clean out door directly beneath the flue, as indicated. Anything falling through the register will pass by the heater

into the dirt pan, which should be cleaned out at frequent intervals. The general arrangement of the air passages is practically the same as in Fig. 33.

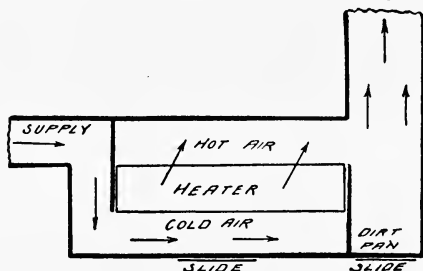

Fig. 34—Arrangement to Avoid Accumulation of Dirt

Mixing Dampers

What means are commonly used for regulating the amount of heat given off by an indirect heater?

In the arrangements shown in Figs. 33 and 34 the only means of regulating the heat supply is to either close the inlet register to the room, or to shut off the steam from a portion or the whole of the stack. The first method not only shuts off the heat but the air supply also, while the last is extremely inconvenient and is only resorted to for rough regulation at different seasons of the year. In the best class of work a device called a **mixing damper** is used by means of which the amount of heat delivered to the room may be varied without affecting to any great extent the volume of air supplied. A common form of mixing damper and its position with reference to the heater, is shown in Fig. 35 at D. When set in mid-position, as in the cut, part of the air passes upward through the stack and becomes heated, while the remainder passes

beneath the stack and meets the hot air at the damper D, from which point the mixture passes up the flue to the room above.

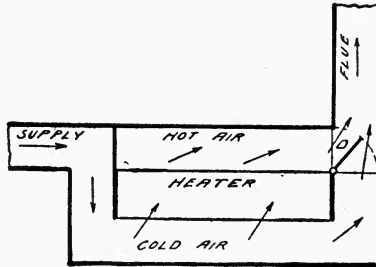

Fig. 35—Mixing Damper

When this arrangement is applied to first floor rooms there is sometimes difficulty in securing a proper mixture in the short vertical uptake, and the air passes through the register in two currents, one hot and the other cold. In the case of second and third floor rooms the vertical flue is longer and the two currents have more of an opportunity to become mixed. For the rea-

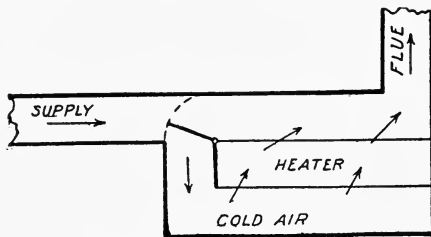

Fig. 36—Arrangement for First Floors

son above noted, the arrangement shown in Fig. 36 is often used for first floor rooms. In this case the mixing damper is placed at the other end of the heater, and as the hot air is beneath the current of cool air, it

tends to rise through it, and therefore becomes quite thoroughly mixed before passing into the uptake flue. The principal defect in this arrangement comes from the fact that a portion of the cool air passing above the stack is likely to fall between the sections, and becoming heated rise again, thus increasing the temperature of the mixture more than is desired. This, however, can be largely overcome by a proper manipulation of the mixing damper, so as to pass more of the air above the heater and less through it.

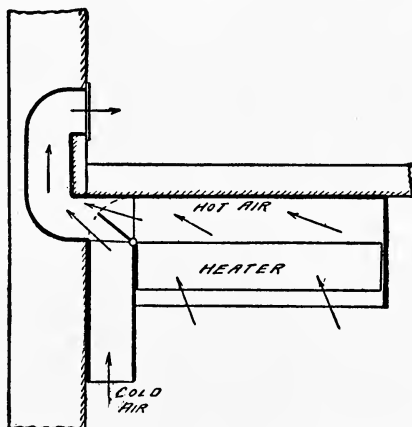

Fig. 37—Arrangement of Mixing Damper and Heater Casing for Hospital Work

How are the heater casing and mixing damper arranged when placed in a cold-air chamber, as in hospital work?

Under these circumstances the bottom is omitted from the casing, so the air can pass directly upward through the heater as indicated by the arrows in Fig. 37. The cold air connection with the mixing damper is carried downward some distance so that the air enter-

ing it will not be warmed by passing across the bottom of the heater.

What is a double mixing damper?

A double mixing damper is made up of two parts joined by a link or connecting rod, so that when one opens the other closes. This form of damper is often used when operated by compressed air, and is shown in diagram in Fig. 38.

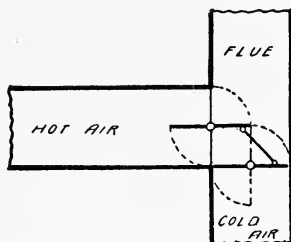

Fig. 38—A Double Mixing Damper

What is the general construction and method of operation of the ordinary form of mixing damper?

This is shown in plan and section in Fig. 39. The damper should be of heavy iron and is usually of the "pan" form to give it stiffness. The edges should form a true plane, so far as possible, and close tightly against light, angle iron flanges in both horizontal and vertical positions. The practice of using felt or asbestos to make it tight is not to be recommended, as it soon wears out in places, thus producing a leaky joint. It is much better to make a metal to metal joint, which when properly constructed, will last indefinitely.

Mixing dampers are usually operated from the rooms above by means of chains passing over guarded pulleys.

Keyhole catch plates are placed either on the reg-

ister face or adjacent wall for holding in any desired position.

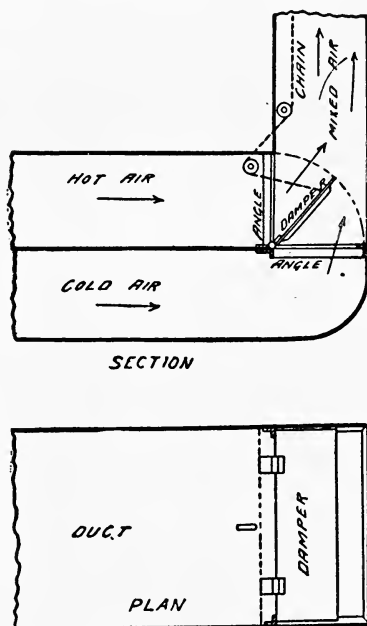

Fig. 39—Plan and Sectional View of Ordinary Mixing Damper, Showing Construction

Special Flue and Heater Arrangements

What arrangements of heating stacks and cold-air chambers are commonly used when the basement space is limited?

One arrangement of this kind is shown in Fig. 40. In this case the heaters are placed as indicated with ample head room beneath the bottoms of the casings. The cold air is supplied to a narrow chamber between them, from which it passes beneath the heaters through openings in the brick walls at either side. The mix-

ing dampers are placed at the bottom of the flues which connect with both the cold air chamber and the hot air spaces above the heaters. This arrangement is very compact, and all parts easily accessible for inspection

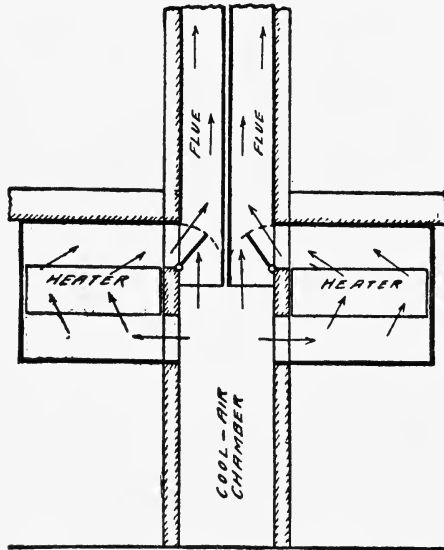

Fig. 40—Arrangement of Heating Stack and Cold Air Chambers When Space is Limited

and repairs. It is especially adapted to hospitals and office buildings where the indirect system is used. By using the upper part of the basement corridor as a cold air chamber, by means of a false ceiling, the whole construction may be kept out of the way and the entire floor be retained for useful purposes.

What arrangement of flues and heaters is especially adapted to schoolhouse work, where there is ample room for cold-air chambers?

A typical layout for this class of work is given in

Fig. 41, which shows two of a group of four flues, the second pair being located directly back of those shown. The cold air is admitted on both sides of the chamber through checks of the type already described in a previous chapter. The heaters are located on either side

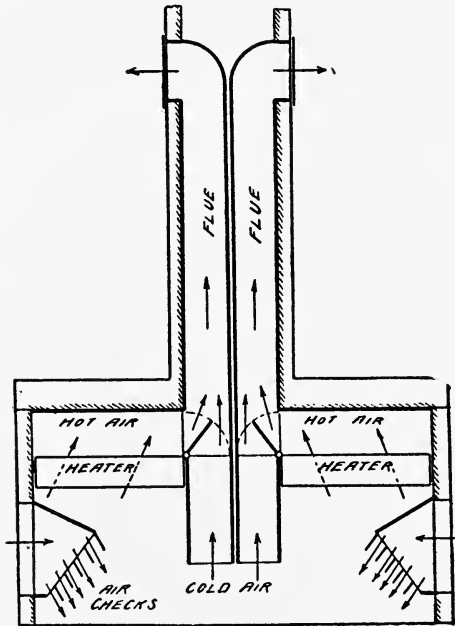

Fig. 41—Arrangement of Flues and Heaters
Adapted to School House Work

of the flues, which are extended to a point near the floor, in order to secure the coldest air for mixing purposes in mild weather. It will be noted that the mixing dampers are so placed with reference to the heaters that the warm air will pass up the front of the flues and flow into the rooms through the bottom of the inlet registers. The casings around the heaters are

formed partly by the brick walls of the chamber and partly by galvanized iron, the bottom of the casing being left open as in Fig. 37. The mixing dampers are operated from the rooms above by means of chains, not shown in the cut. The proper air supply

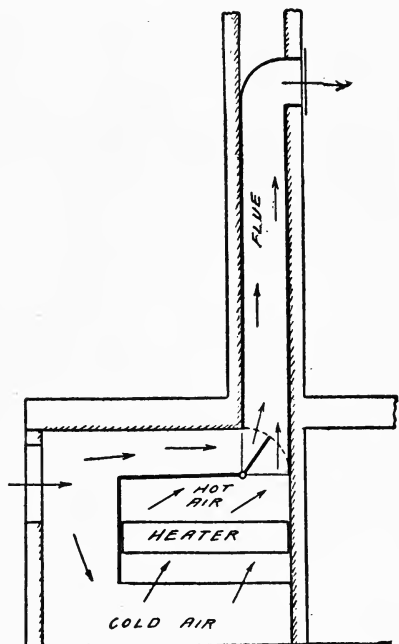

Fig. 42—Arrangement to Cause Warm Air to Pass Up From Flue

to each room is secured by means of divisions in the hot air chambers above the heaters which set off the proper number of sections for each flue. Arrangements of this kind are adapted to the warming of churches and halls as well as school buildings, by making such minor changes as may be necessary to adapt them to local conditions.

How may the warm air be made to pass up the front of the flue when conditions are such as to bring it at the back with the arrangement shown in Fig. 41?

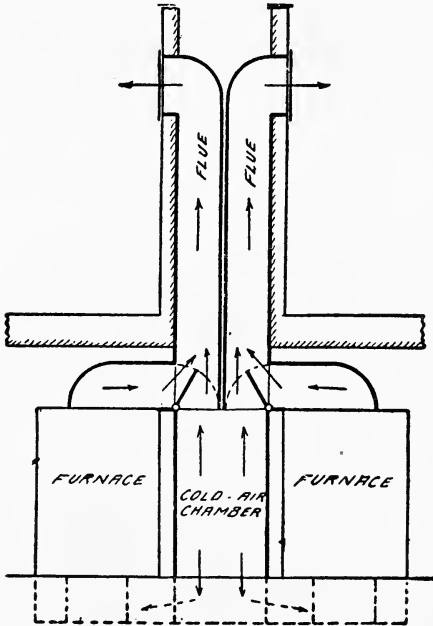

Fig. 43—A Pair of Furnaces Arranged for Heating a Large Building

In this case the desired results may be obtained by dropping the stack a certain distance from the ceiling and passing the cold air over the top of the casing as in Fig. 42. In this layout the heater is supported in a cold air chamber and provided with a casing having an open bottom. The top of the casing is some distance below the ceiling, allowing the cold air to flow above it and pass up the back of the flue as shown. In low basements this may not always be convenient

on account of interfering with head room, but if the heater is placed in a cold air room no inconvenience will be experienced. If this arrangement brings the heaters too near the water line, the boiler may be placed in a pit. To prevent cooling the air in the space above the heaters, the tops of the casings should be covered with an inch or more of plastic asbestos or magnesia. The general location of the mixing damper, and the path of the hot and cold air currents are clearly indicated in the cut.

What are the essential features in designing the flue and damper layout for furnace heating in large buildings, like schools and churches?

In buildings of this kind special provisions must be made for furnishing large volumes of air, and for regulating the temperature without cutting down the amount passing to the rooms. A typical layout for a pair of furnaces is shown in section in Fig. 43. The cold air is supplied to a chamber located between the furnaces, from which it passes into the pits beneath the casings and into the bases of the uptake flues by way of the mixing dampers. The hot air from the top of the furnace casings enters the uptake flues through side openings and passes up at the front of the flues as indicated. All flue and damper work in this connection should be of heavy galvanized iron, well stiffened, and with tight joints. The flue sizes may be practically the same as for indirect steam heating under similar conditions.

By-Pass Dampers

What is a by-pass damper, and how is it used in fan work in connection with a main or primary heater?

A by-pass damper, as its name signifies, is used for

passing part of the air supply around the heater instead of through it, in order to reduce the final temperature of the mixture at the fan. Rough temperature regulation is generally secured by means of the steam valves, shutting off or turning on more sections as may be necessary, and then using the by-pass damper for the final regulation. A typical layout for a pipe heater

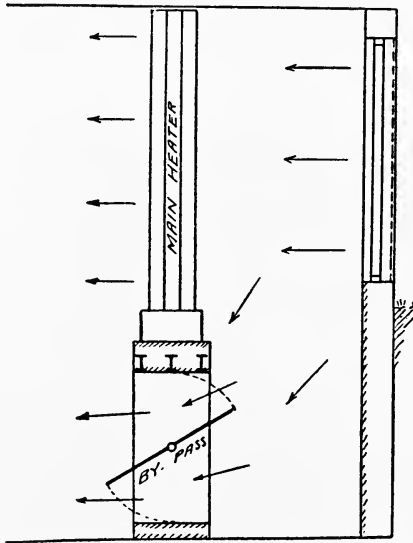
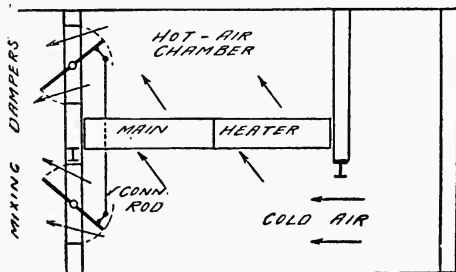

Fig. 44—A By-Pass Damper for Use in Fan Work

and by-pass is shown in Fig. 44. In this case the damper is placed in an opening in the heater foundation, which is made especially high for this purpose. In some instances it is more convenient to have the by-pass at the top, while in others, especially in low basements, it is made to turn on a vertical spindle at the side of the heater. By-pass dampers are often operated automatically by means of a hot air thermostat placed

in the air duct beyond the fan, where the warm and cool currents of air will have become thoroughly mixed.

How does the by-pass arrangement for a cast iron heater vary from that just described for a pipe heater?



SECTIONAL VIEW.

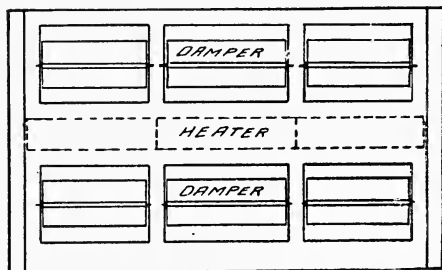

FRONT ELEVATION.

Figs. 45 and 46—By-pass Damper Arranged for Cast Iron Heater

A typical arrangement for a heater of this type is shown in Figs. 45 and 46. The sections are supported upon I beams about midway between the floor and ceiling, as indicated in Fig. 46, which represents a longitudinal section through a heater and damper. The cold air enters the chamber through an opening near

the floor, a portion of it passing upward between the sections of the heater and the remainder flowing through the lower member of the mixing or by-pass damper as indicated by the arrows. If the temperature of the mixture becomes too high, the mixing dampers are set to throw more of the air through the lower or cold air by-pass and less through the upper or hot air damper.

The walls of the heater chambers are of brick supported upon I beams, while the dampers are of heavy galvanized iron set in angle iron frames attached to the brickwork. Fig. 45 is a front elevation of the wall facing the heater and shows the three pairs of mixing dampers. Automatic actuation is usually provided for dampers of this type, the three pairs being moved simultaneously by means of the same rod.

Shut-Off Dampers

What form of construction are commonly used for the shut-off dampers in large vent flues, and what especial conditions must be considered?

Dampers of large size must be very carefully constructed to give the necessary stiffness without excessive weight. They should be made to close tightly against metal stops and be counter-balanced in order that they may be easily operated.

A simple form of single damper is shown in Fig. 47. It turns on a horizontal spindle and closes against angle iron stops on all four sides at an angle of 45 degrees. The spindle is placed slightly above the center so the damper will open by its own weight. It is closed by means of a chain and pulley attachment as indicated.

Dampers of this type are commonly made on the "pan" design in order to secure the desired rigidity; others are constructed with an iron framework. In some cases a wooden damper is first made and then

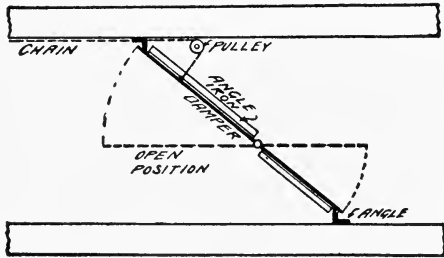

Fig. 47—Simple Form of Single Damper

covered with galvanized iron. Care should be taken in the construction of the spindle bearings to make them durable and to secure a free movement of the damper. When of medium size the spindle may turn in short

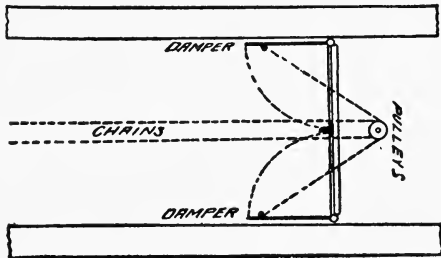

Fig. 48—Damper in Two Sections

lengths of wrought iron pipe built into the side walls of the flue. In the case of heavy dampers of large size, roller bearings should be used, supported on heavy angle iron brackets, anchor bolted to the walls.

Fig. 48 shows a damper made in two sections which

are hinged at the sides as indicated. These are operated independently by means of chains and pulleys carried down the flue, and close upward against a tee bar at the center. Angle iron flanges are provided at the sides in order to make tighter joints. Dampers of this design are sometimes preferred in flues of large size where it would be difficult to construct a single

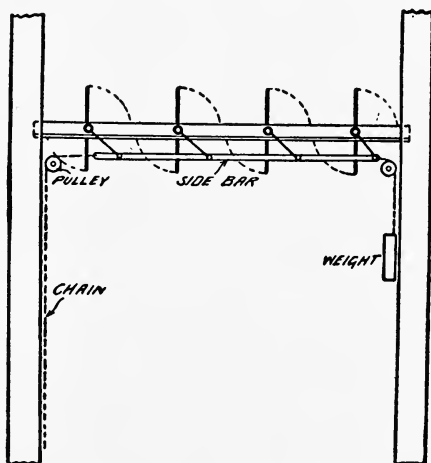

Fig. 49—Lower Damper for Large Flues

section of sufficient rigidity to close tightly against the flanges. Dampers of this type are partially balanced by attaching counter weights to the chains.

For very large flues the sectional or lower damper shown in Fig. 49 is the best. This is made up of a series of sections turning on horizontal spindles passing through angle irons at the sides. The spindle of each section is attached to a side bar by means of a bell crank as shown. One end of the bar is weighted

sufficiently to open the damper, while a chain at the other end gives a means of closing it. The action is improved by the use of roller bearings, which may be easily attached to the horizontal flange of the angle iron side bars. A small copper gutter around the flue, just below the damper, is often used to catch any water which may find its way in during the night when the damper is closed.

CHAPTER VII.

FANS AND FAN DRIVES

What two general types of fans are used in ventilating work?

The centrifugal fan, sometimes called a blower, and the disk or propeller fan.

What is the principle of the centrifugal fan, and how is it constructed?

A centrifugal fan is made up of a number of floats or blades extending radially from a shaft or hub as shown in diagram in Fig. 50. The curved arrows at the perimeter indicate the direction of rotation, and the radial arrows along the blades the path of the air. When in motion, the air in contact with the blades is thrown outward by centrifugal force, and is delivered at the tips the same as mud is thrown from the rim of a rapidly revolving buggy wheel, or water from a grindstone. This action produces a partial vacuum at the center of the wheel and more air flows in to replace that which has been discharged. The tips of the blades are usually curved slightly for ventilating work as the fan operates more quietly when designed in this way.

The construction of an actual fan wheel is shown in Fig. 51. It consists of one or more cast iron hubs with projecting arms called spiders. These are keyed to a shaft running in adjustable bearings as indicated. The blades, straight in this case, are of steel plate

riveted to the spiders, and stiffened by a conical ring at each side which makes the blades somewhat narrower at the outlet or tip than at the base. In practice this type of fan is enclosed in a casing of steel plate of the general form shown in Fig. 52. Air enters the fan through a circular opening in the side of the casing (not shown in the cut), and is thrown off by the revolving blades into a space between the fan tips

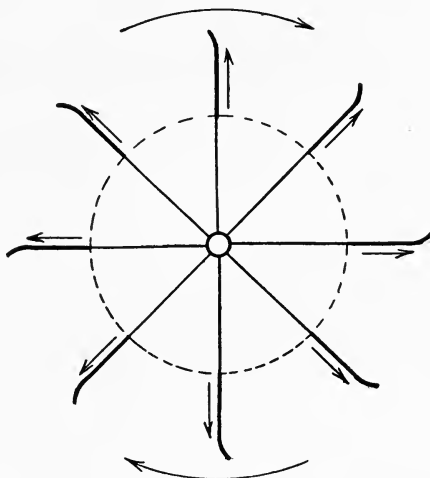

Fig. 50—Principle of Centrifugal Fan

and casing, provided to receive it. From here it is discharged into the distributing ducts through an outlet in the circumference of the casing as indicated in the cut.

What is a cone fan, and under what conditions is it used?

A cone fan is a special form of the centrifugal type designed for use without a casing. It is placed back of a circular wall opening (see Fig. 53) and discharges

the air from its periphery directly into the room in which it is located. This fan has an especially large inlet on one side and takes its name from the large conical hub which serves to deflect the air from the inlet into the spaces between the blades. Two cone

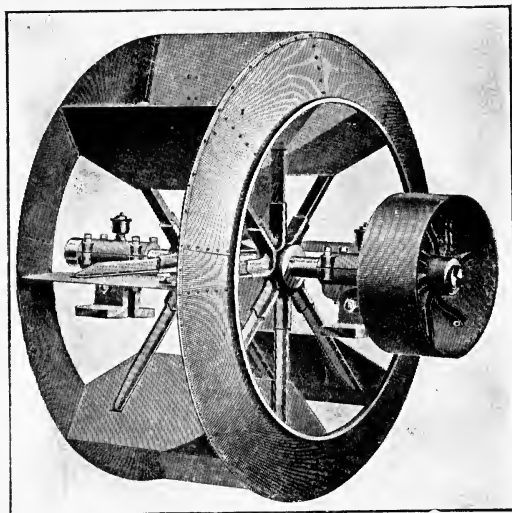

Fig. 51—Construction of Centrifugal Fan

fans are sometimes placed back to back and enclosed in a steel casing of regular form having an inlet opening in each side.

Cone fans have a high efficiency and are capable of moving large volumes of air at moderate speeds. The room into which a fan of this type discharges is called a plenum chamber, and connects with the distributing ducts which supply the various uptake flues.

What is a multivane fan?

This type of centrifugal fan is shown in Fig. 54.

It is enclosed in a steel casing similar to that shown in Fig. 52 and operates upon the same principle as the standard form of wheel. Its peculiarity of construction is its large number of narrow corrugated blades. It runs at a comparatively high speed and de-

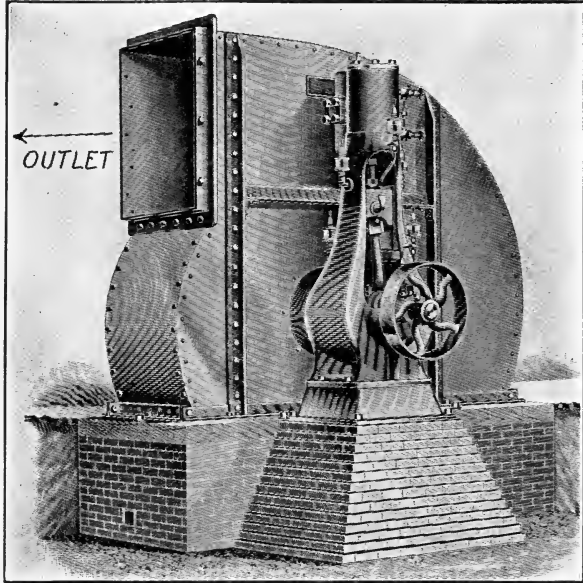

Fig. 52—Casing and Drive of Centrifugal Fan

livers a much larger volume of air for a given size than the standard form shown in Fig. 51.

This is a fan of recent design and is made in several different forms.

What is the difference between a blower and an exhauster?

The term blower is commonly applied to fans hav-

ing an inlet opening upon each side of the casing and used for forcing the air through the supply ducts of a ventilating system.

An exhauster is constructed in the same manner except there is only one inlet. Fans of this type are commonly used for exhaust ventilation by attaching

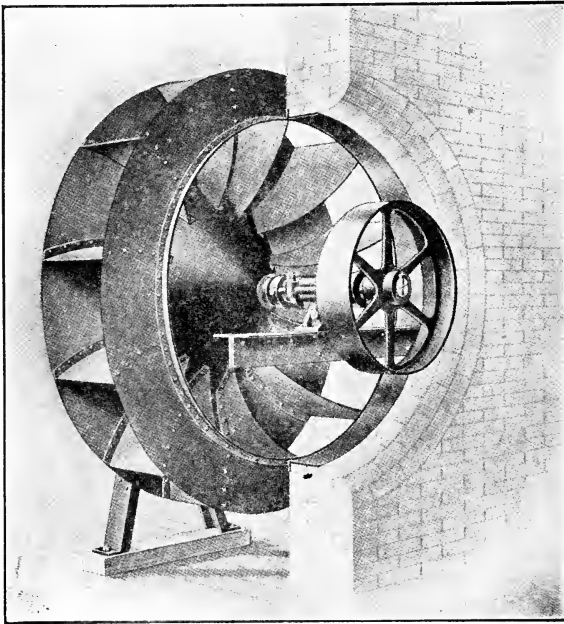

Fig. 53—A Cone Fan

the main vent duct to the fan inlet. Blowers are often used as exhausters and vice-versa under certain conditions. In the case of large buildings it is frequently advisable to use a double inlet fan for exhaust purposes, placing it in the center of a large vent chamber with which the various exhaust ducts connect.

Exhausters are often used as supply fans for smaller ventilating systems, a duct from the heater being connected with the single inlet.

Is the standard form of exhaust fan suitable for the transmission of wool, shavings, etc., in manufacturing plants?

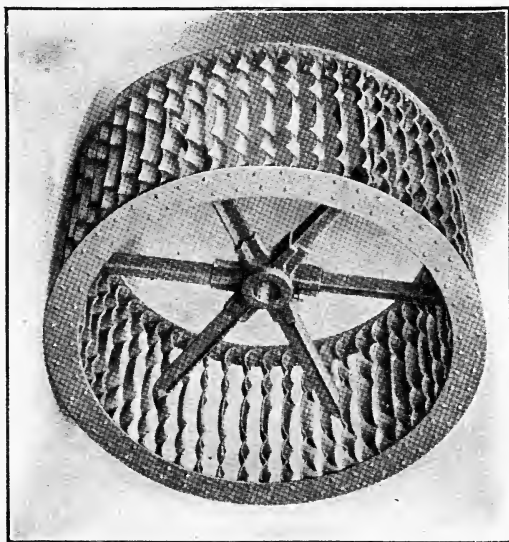

Fig. 54—A Multiple Fan

No, a special form of fan wheel is required, depending upon the substance to be moved. A cotton or wool wheel is shown in Fig. 55, and one designed for long shavings in Fig. 56. The purpose for which a fan is to be used should always be described in detail when ordering from the makers.

Are the various proportions of a centrifugal fan

wheel made according to the same standard by different manufacturers?

No, different makers proportion their fan wheels differently, although there is not a wide variation in the relative dimensions. The following gives the average relations of width to diameter as made up from the dimension sheets of several makers of this type of fan:

Width of wheel at center = $.5 \times$ diameter.

Width of wheel at periphery = $.8 \times$ width at center.

Diameter of inlet = $.7 \times$ diameter of wheel.

What is a double fan?



Fig. 55—Exhaust Fan for Wool, Shavings, Etc.

A double fan is one having a width equal to twice that of a standard fan. According to the above relation, the width of a double fan would be approximately the same as its diameter.

What is the capacity of a double fan as compared with a single fan?

The capacity of a double fan at a given speed is approximately twice that of a single fan of the same diameter and requires twice the power to run it.

May the position of the outlet be varied according to the requirements of different locations?

Yes, the outlet may be placed in any position desired. These are commonly designated as "top horizontal discharge" (Fig. 52), "bottom horizontal discharge" (Fig. 65), "up discharge" (Fig. 58), "top angular up discharge" (Fig. 57), "bottom angular down discharge," etc.

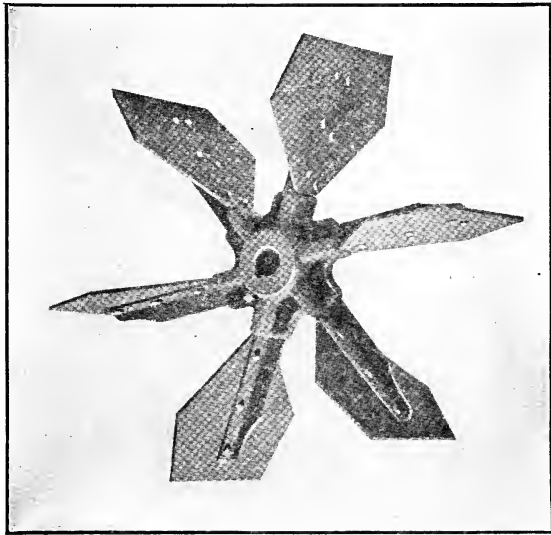

Fig. 56—Design of Blades for Fan for Long Shavings

What effect does the form of fan outlet have upon the quietness of action of a fan?

The usual form of the outlet from a fan casing is rectangular, as seen in Fig. 52, and shown in front elevation in Fig. 59. The objection to this, where quietness of operation is important, is a humming noise

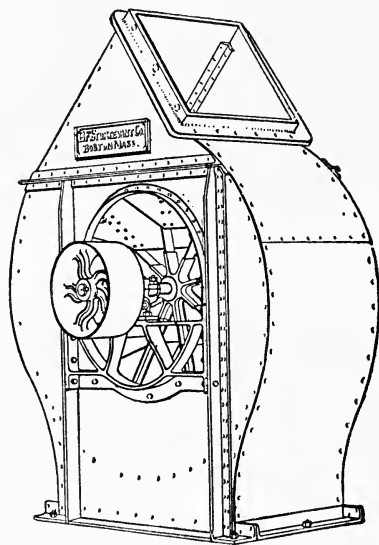

Fig. 57—Top Angular Up Discharge

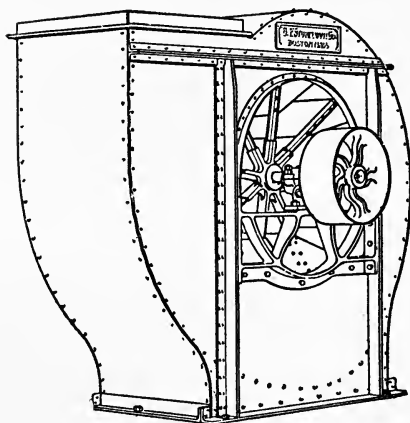
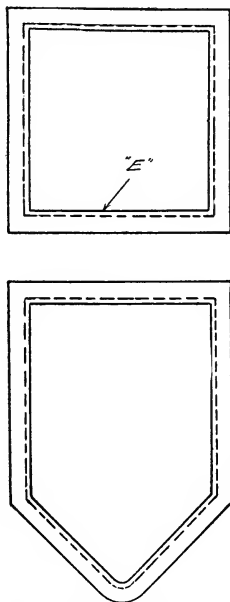

Fig. 58—Up Blast Discharge

produced by the air impinging upon the lower edge of the opening as indicated at "E" in Fig. 59. This may be overcome by changing the form to that shown in Fig. 60, known as a V-shaped or vanishing outlet. This construction is especially desirable in fans designed for churches, schools, hospitals, etc., where noise of any kind connected with the ventilating system is objectionable. The leading manufacturers will provide this form of outlet, if so requested at the time the fan is ordered.



Figs. 59 and 60—Forms of Blades

What provisions are sometimes necessary for preventing the vibration of the fan from being communicated to the connecting ducts?

The first precaution in the prevention of vibration

is a suitable foundation for the fan; next the use of a vanishing outlet and moderate speed; and finally, duct construction of heavy iron, rigidly braced and firmly secured to the ceiling.

If further precautions are necessary a canvas sleeve may be used between the fan outlet and the main duct. These are made in different ways, a common form being shown in Fig. 61. This is attached to the fan outlet and duct by means of an angle-iron upon the outside and strap-iron on the inside, held together by bolts as indicated.

Computing the Capacity of Centrifugal Fans

Upon what conditions does the capacity of a centrifugal fan depend?

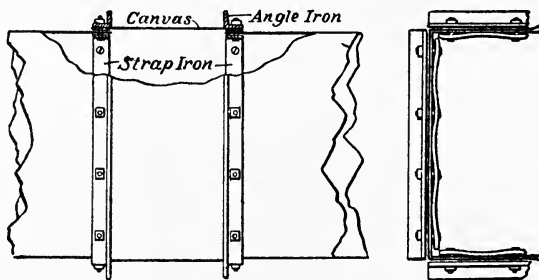

Fig. 61—Canvas Sleeve to Avoid Vibrations

The volume of air moved by a given fan depends upon its speed and the resistance against which it operates. The speed at which a fan should run in general ventilating work is limited to a peripheral velocity of about 4,000 feet per minute, on account of the noise produced at higher speeds. For churches and schools it is better not to exceed 3,000 to 3,500 feet for continuous operation.

In the case of factories, where the noise is not ob-

jectionable, better efficiencies may be obtained by speeding the fan up to 5,000 feet per minute, or even more.

The resistance against which a fan operates is made up principally of the friction in the ducts with which it connects, although a certain amount of power is required to set the air in motion.

How does the volume of air delivered vary with the speed of the fan?

Theoretically, the volume varies directly as the speed; that is, doubling the speed doubles the capacity under given conditions.

How does the power for operating the fan vary with the speed?

The power varies as the cube of the speed; that is, doubling the speed will increase the required power $2 \times 2 \times 2 = 8$ times. This applies only to theoretical cases, and does not take into account the increased efficiency of the fan at higher speeds. It is true, however, that under actual conditions the power increases much faster than the volume delivered with a given increase in speed, and this should always be taken into account when determining the most economical speed at which to operate a fan continuously.

What uniform condition is commonly assumed when computing the capacity of a fan by different methods?

It is commonly assumed that the fan is discharging into the free atmosphere; that is, there are no ducts connected with the mouth of the fan casing. As the resistance varies so greatly under different conditions, it is best to make all computations on this basis, and then make such corrections as experience has shown to

be necessary for the usual practice in different types of buildings.

What is the pressure commonly spoken of in connection with a fan?

This refers to the pressure produced within the fan casing by the air as it is thrown from the tips of the blades. With a given outlet or discharge area to the casing, there is a definite relation between the peripheral velocity of the fan and the pressure produced, and the velocity of flow through the outlet depends, in turn, upon the pressure within the casing.

What is the theoretical relation between the peripheral velocity of the fan and the discharge velocity through the outlet?

When the area of the outlet is small, and the fan discharges into free air, the velocity of outflow will be the same as the peripheral or tip velocity of the fan.

What is the projected area of a fan wheel?

The projected area of a fan wheel is found by multiplying the diameter by the width of the blades at the tip.

What is the blast area of a fan?

As previously stated, if the outlet area is small, the velocity of outflow will equal the tip or peripheral velocity of the fan wheel. If now the area of outlet be slowly increased, a point will be reached where the velocity of outflow will drop below the peripheral velocity. The area of the outlet when this change begins to take place is called the blast area of the fan. This will vary in different makes and designs of fans, but for the usual blower, as used in ventilating work, it may be taken as approximately one-third the projected area of the fan wheel.

How is the theoretical capacity of a fan computed?

Under the conditions noted above, the capacity of a fan, in cubic feet per minute, will be equal to the outlet velocity in feet per minute, times the area of outlet in square feet. If the outlet velocity is the same as the peripheral velocity, it will be equal to the circumference of the fan in feet, multiplied by the number of revolutions per minute. The outlet area is taken the same as the blast area, and is equal to the width of the fan tips multiplied by one-third the diameter of wheel. This may be expressed in the form of an equation as follows—

$$(4) V = (C \times R) \times \frac{Dw}{3}, \text{ in which } V = \text{cubic feet of}$$

air discharged per minute.

C = circumference of fan wheel, in feet.

R = revolutions of fan per minute.

D = diameter of fan, in feet.

w = width of tips of blades, in feet.

How does the area of outlet or discharge area in actual practice compare with the blast area?

It is always larger, but the exact ratio varies with the type and make of fan. For average conditions, however, the effective outlet area of the ordinary blower may be taken as approximately 1.8 times the blast area.

How does this condition affect the volume of air delivered by the fan as compared with its theoretical capacity?

It affects the capacity in two ways. First, the area of outlet is increased; and second, the pressure is diminished, which reduces the velocity of outflow. The

net result of these two effects is to make the actual capacity about 1.4 times the theoretical, when discharging into free air.

What is the effect upon the capacity of a fan when distributing ducts are connected to the discharge outlet?

Its capacity is reduced a certain amount, depending upon the resistance introduced. In the case of duct velocities commonly employed in schools and churches, the volume of air moved will run from .7 to .8 of the delivery into free air, and in shops and factories from .6 to .7.

Power for Driving Fans

How is the horse-power for driving a fan determined?

The computations for determining the theoretical horse-power for driving a fan under different conditions are very complex, hence it is more usual to base it upon practical results obtained by tests upon fans of different sizes running at different speeds under actual working conditions.

In what form are fan data usually put for convenient use in practical work?

Data relating to the operation of fans under practical working conditions are usually arranged in the form of tables for convenient use.

Table VII gives diameters of fans, usual speed, actual capacity, and horse-power of engine or motor, for the usual conditions found in schools, churches, halls, etc. Table VIII is similar in form, and applies to shops and factories.

Table VII.

Fan Data for Schools, Churches, Halls, Etc.

Diam. of fan, feet.	Rev. per min.	Cubic feet of air per min.	H. P. of engine or motor.
3	300	4,500	2
4	250	8,000	3
5	225	13,500	5
6	200	20,500	8
7	175	27,000	10
8	150	36,000	13
9	125	42,500	15
10	100	46,500	15

Table VIII.

Fan Data for Shops and Factories

Diam. of fan, feet.	Rev. per min.	Cubic feet of air per min.	H. P. of engine or motor.
3	400	4,500	2
4	350	9,000	4
5	275	13,500	6
6	250	21,500	10
7	225	29,000	14
8	200	39,000	20
9	175	48,500	25
10	150	56,500	28

Disk or Propeller Fans

For what purposes are disk or propeller fans used and what are their advantages and disadvantages?

Disk fans are more commonly used for discharge or exhaust ventilation than for supply. They are light in construction, having no casing, and are capable of moving large volumes of air at low pressures with a comparatively small expenditure for power. They are especially adapted for use in attics and roof spaces

where it would be difficult to support a fan of large size of the centrifugal type. Although frequently used in connection with a heater for supply purposes, they are more particularly adapted to small installations of this kind where the resistance is low.

How is the capacity of a disk fan determined?

The capacity of disk fans is usually based on actual tests and generally given in the form of tables. As in the case of centrifugal fans, the capacity and horsepower at different speeds will depend largely upon the resistance due to the ducts.

Table IX.
Data for Disk Fans

Diam. of fan, feet.	Rev. per min.	Cubic feet of air moved.	H. P. of motor.
18	600	1,200	$\frac{1}{8}$
24	530	1,600	$\frac{1}{4}$
30	460	2,200	$\frac{1}{2}$
36	370	3,400	$\frac{3}{4}$
42	310	4,900	1
48	275	9,600	$1\frac{1}{2}$
60	250	17,000	$2\frac{1}{2}$
72	200	24,000	$3\frac{1}{2}$
84	160	28,800	4
96	140	40,000	$5\frac{1}{2}$

Table IX is based upon average duct velocities with the usual number of bends, for buildings of moderate size. For shorter ducts and lower velocities, the air volume will increase in proportion, while for great resistances the opposite will be true. This is the reason why capacity tables for disk fans hardly ever agree.

What are some of the general forms of construction of disk fans?

Fig. 62 shows a common design of disk fan with flat

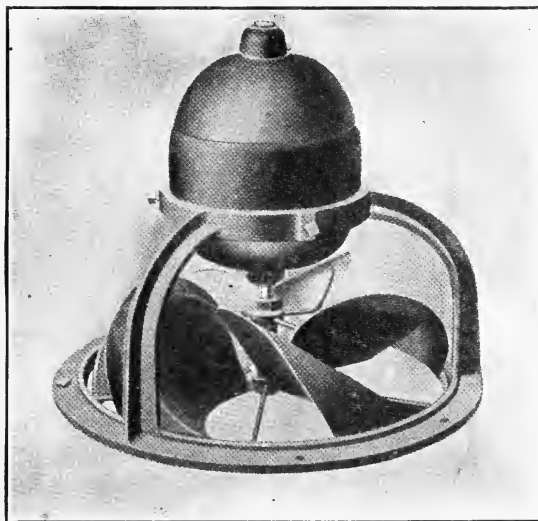

Fig. 63—Disk Fan with Curved Blades

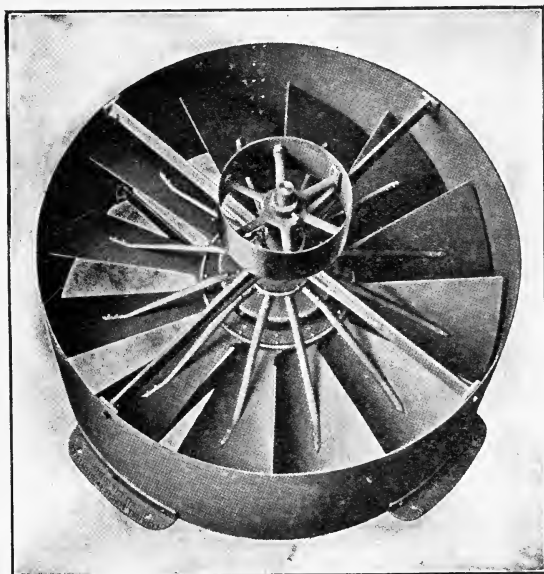

Fig. 62—Disk Fan with Flat Blades

blades or vanes. These revolve in a metal ring or sleeve, which is set either in an opening in a brick wall or is bolted to a wooden or metal partition in front of the exhaust opening, as local conditions may call for. Another type of disk fan with curved blades is shown in Fig. 63. This has no enclosing sleeve, but runs in front of an iron ring which is bolted to the wall or partition in front of a circular opening of proper size. There are many forms of disk fans on the market, but those shown represent the two general types.

Fan Drives

What are the most common methods of driving fans in ventilating work?

The methods most frequently employed for driving ventilating fans are electric motors, steam engines, steam turbines, and from counter-shafts in manufacturing plants.

What are the advantages and disadvantages of each?

Electric motors are probably used to a greater extent than any other method, especially in large buildings having their own generating plants. They are quiet in action, particularly when direct connected and run at the same speed as the fan. Direct current motors have an economical range of speed of 25 to 50 per cent. variation when equipped with a suitable regulating rheostat. When belted motors are used, the low speed type should be employed on account of greater quietness of operation. Motors are easily cared for, and when the fans are in places not easily reached the switches may be located in such a manner that the motors may be started and stopped at some convenient point some distance away. When this is done,

however, the switch should be placed within sight or hearing of the motor, so that the attendant may know if it starts up properly. Fan and motor should be inspected daily for cleaning and oiling, even when controlled from a distance.

If an alternating current is used it will be necessary to belt the fan, as motors of this type run at a higher speed than is desirable for fan work. Belts used in this connection should be single ply of sufficient width to give the required strength, rather than double ply, because they are more pliable and run with greater quietness. All joints should be lapped and cemented instead of laced, for the same reason.

Steam engines are commonly used in school house work and other buildings where the fans are operated for considerable periods of time, and where electricity must be purchased, on account of economy of operation. The cost of running an engine during the heating season may be practically ignored, because the exhaust steam may be turned into the coils and do useful work in warming the air used for ventilation. Steam engines for this purpose are usually provided with especially large cylinders so they may run at low pressures. They are both belted and direct connected, as most convenient. When the latter arrangement is used especial care should be taken to have them carefully adjusted, for any knocking in the cylinder or other connections will be communicated to the fan and carried to the rooms above.

Special low speed steam turbines are now used to a considerable extent for driving ventilating fans. They operate quietly, and when the exhaust can be turned into the heating system, make a satisfactory form of fan drive. In manufacturing plants where it is not de-

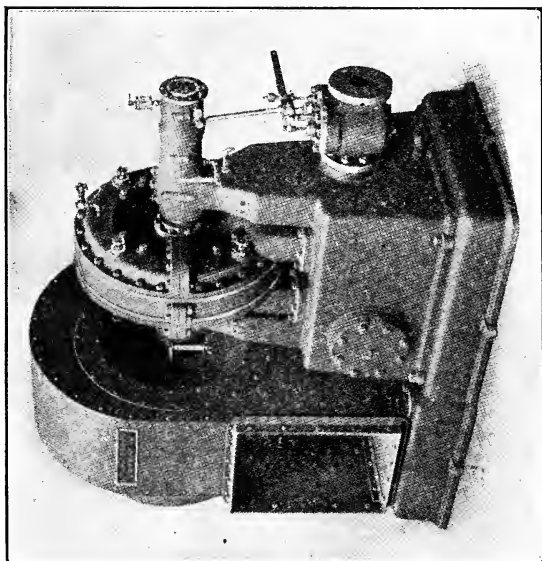

Fig. 65—Turbine Fan

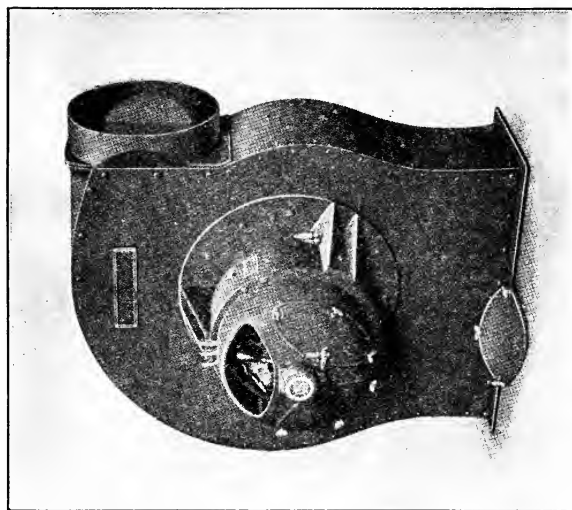

Fig. 64—Motor Driven Fan

sired to run the fans, except when the machinery is in motion, they may be belted to convenient countershafts. Fans driven in this way must always run at the same speed for there is no way of securing regulation in this case except by the use of stepped pulleys. A fan driven by a direct connected engine is shown in Fig. 52. Motor driven fans are shown in Figs. 63 and 64, and a turbine fan in Fig. 65.

Foundations

What precautions are necessary in the construction of the foundations for ventilating apparatus?

The foundations and supports for all ventilating apparatus should be designed and constructed with special reference to the prevention of vibration. For blowers and exhausters, of medium and large size, a foundation of brick or concrete should be provided, extending from 12 to 18 inches below the level of the

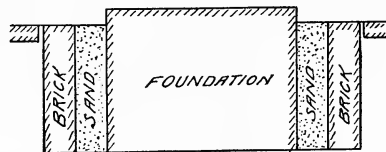

Fig. 66—Foundation to Prevent Vibration

cement floor of the basement. These should be capped with wooden sills, anchor-bolted to the masonry to which the base of the fans may be fastened by means of lag screws. For fans of small size the wooden frame or sill may be placed directly on the concrete floor without the use of a special foundation, provided it is of good thickness. The foundations for motors and engines, especially the latter, require particular attention. One of the best arrangements for preventing vibration is shown in Fig. 66. The main or cen-

tral foundation is constructed as indicated ; outside of this, about 8 inches distant, is a brick wall entirely surrounding the main foundation, and the space between the two filled with moist sand tamped hard. There should also be a narrow space of about an inch be-

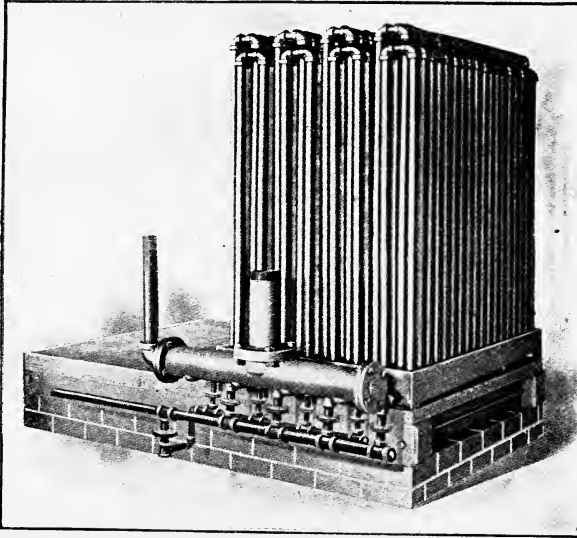

Fig. 67—Mounting and Connecting Pipe Heater

tween the brick wall and the concrete floor. Vibration is also prevented by simply placing a number of layers of hair felt, protected by sheets of lead, between the foundation and the bed of the engine or motor.

Hot Blast Heaters

What forms of steam heaters are commonly used in connection with fans for hot blast heating and ventilation?

Two general types of heaters are used for this pur-

pose, those made up of wrought iron pipes screwed into cast iron bases, and cast iron heaters, composed entirely of sections similar to those used in indirect gravity heating. A typical pipe heater is shown in Fig. 67, together with the method of mounting and connect-

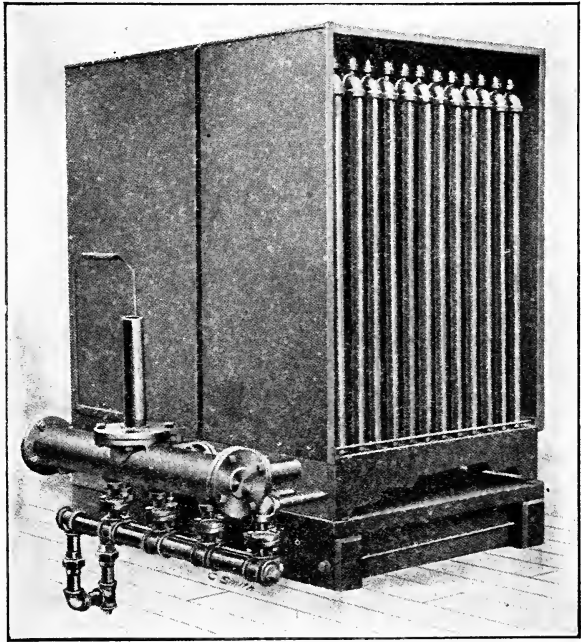

Fig. 68—Steel Plate Casing for Pipe Heater

ing. Heaters of this type are enclosed in a steel plate casing as in Fig. 68, and are connected with the cold air inlet and the fan by means of suitable ducts. Cast iron heaters are usually supported on iron beams in brick chambers and the air drawn through them as shown in Fig. 45.

CHAPTER VIII.

AIR FILTERS AND WASHERS

When designing a system of ventilation, what condition must be considered of equal importance with the air quantity?

In planning a system of ventilation, air quality must be considered as well as quantity.

In what general form do most of the impurities appear in the outside air?

Impurities in the open air are largely in the form of dust, although special impurities may be present in gaseous form. Air purification, as practiced by the ventilating engineer, is concerned chiefly in the removal of dust and other solid matter. Harmful or objectionable gases require special treatment and cannot be covered in a general way.

What is a common estimate of the amount of dust contained in the air in different locations?

It has been estimated that one cubic inch of air in the open country carries about 2,000 dust particles; in cities, 3,000,000 or more, and in occupied rooms 30,000,000.

Of what is the dust in the air ordinarily composed?

Dust has its origin in many ways, among which may be mentioned animal and vegetable matters of all kinds, including bacteria and moulds, particles carried from the soil by winds, soot from chimneys and gas

burners, the discharge from volcanoes, and dust from meteorites.

Examinations of the dust found on the window ledges of city buildings give the following results: Specimens from the lower ledges are found to be made up mostly of sand, while higher up the proportion of animal matter becomes larger, and there are also found pollen from plants, soot, and germs from decomposed animal and vegetable matter.

Air samples taken at the street level in a large city are found to contain an almost endless variety of substances, among which may be mentioned ashes, sand, pulverized excreta of animals, plaster, soot, brick dust, fibres of clothing, hairs, steel abrasions from the wheels and rails of street cars, and a great variety of micro-organisms in masses and clusters.

Into what two classes is dust commonly divided?

There are two classes of dust, that which is easily visible as such, and dust which is ordinarily invisible, but may be seen in a beam of sunlight or thrown upon a screen by a magic lantern.

Is ordinary dust in itself injurious to health?

Except for its irritating effect upon the mucous membrane of the respiratory tract, dust is not especially harmful unless it contains the living germs of disease. In city buildings, however, the large amount of dust and soot brought in by unfiltered ventilating air may produce a considerable amount of damage, both to the building and its contents.

Is there any way of telling when dust contains disease germs and when it does not?

No, any dust, especially that in towns and cities, is liable to contain the living germs of some disease.

Is the danger of infection from this source as great in the open air as indoors?

It is not. In the open the dust is greatly diluted, while in occupied rooms it is constantly being stirred up and any germs which it may contain are breathed over and over again.

In view of the above, what precaution should be taken in providing the air supply for buildings located in the thickly settled portions of cities and towns?

It should be purified by passing it through a filter of suitable form before delivering it to the distributing ducts leading to the rooms.

What two general types of filters are used for this purpose?

Dry filters or screens, and spray filters or washers. To these may be added certain forms of wet filters in which the spray is not used, the water being simply used to wet the filtering substance as in the case of coke filters.

Dry Filters

What are some of the advantages and disadvantages of the dry filter?

The advantages of a dry filter are its simplicity and low cost of installation, which make it possible to secure a certain degree of purification in cases where it would not be practicable to use a filter of the washer type. The principal disadvantages are, first, the large space required to obtain the necessary filtering surface, else it will impose too great a resistance to the flow of air and cut down the supply; second, it can only be relied upon to remove the coarser particles of dust unless of such fine mesh as to make it impracticable;

third, filters of this type must be cleaned or renewed at frequent intervals, in many cases every day, or even oftener, else they will become clogged and interfere seriously with their usefulness.

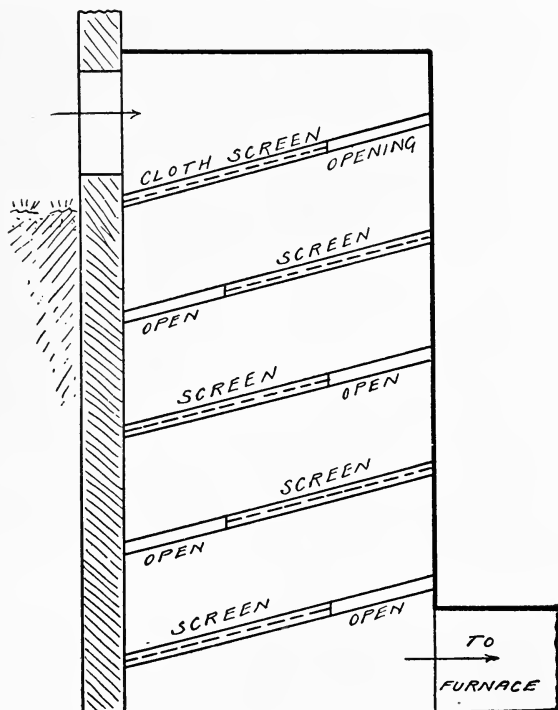

Fig. 69—Dry Filter Composed of Screens

What are some of the more common forms of dry filters?

A simple filter adapted to furnace heating or other cases where small volumes of air are required is shown in section in Fig. 69. This consists of a cold-air chamber of suitable size containing a series of screens placed

in a nearly horizontal position. These are made with a strong wooden frame, about two-thirds of which is covered with cheesecloth or bunting, the remainder being left open in order to lessen the resistance to air flow. Air enters the inlet window as indicated by the arrow and the heavier particles of dust fall on the screen. Part of the air passes through the screen and part through the opening where the same process is repeated, the heavier impurities still remaining being caught by the second screen, and so on, to the bottom.

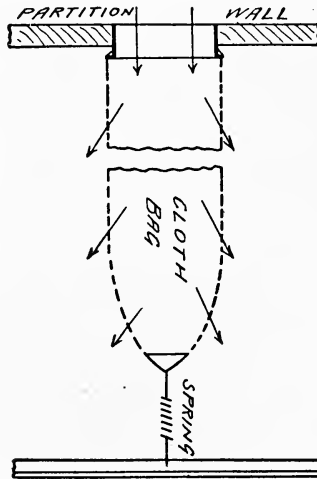

Fig. 70—Bag Filter

When properly proportioned and cleaned at frequent intervals, filters of this kind will remove a large proportion of the coarser dust and soot contained in the air supply. With this particular design of filter the area of the screens should be from ten to twenty times that of the inlet window. When space is available, the latter ratio should be used as it will offer less resistance and require cleaning at less frequent intervals.

The cloth filter which gives the greatest amount of free surface in a given space is that known as the bag filter and is made in different forms to suit special locations. Fig. 70 shows the two ends of a horizontal bag used in this way. The partition wall at the left forms part of the cold-air room and contains a considerable number of circular openings the size of the filter bag. These openings are provided with a galvanized iron sleeve having a wired edge and projecting about 3 inches beyond the wall. The mouths of the bags are drawn over these sleeves and tied by means of a stout cord passed around back of the wire. The other end or bottom of the bag is closed and provided with a wooden cone attached by means of a coil spring to an upright tee bar. The air enters the mouth of the bag as shown and passes out through the meshes of the cloth as indicated by the arrows. By increasing the length of the bag the ratio between the filter surface and supply duct can be increased sufficiently to reduce the resistance well within practical working conditions. The number of bags used will depend upon their length and the volume of air to be passed through them. In designing a filter of this kind care should be taken to have sufficient space between the bags for the air to flow away from them freely. Another arrangement of the bag filter is shown in Fig. 71. In this case the bag hangs in a vertical position, and is kept in place by a fairly heavy iron ring at the bottom. The path of the air is indicated by the arrows as before. A typical arrangement of filter, heater, and by-pass, together with a galvanized iron casing, is shown in Fig. 72. The cold air enters at the right, near the top, and passes downward through the bags, then upward through the heater or through the by-pass damper, as may be necessary to

secure the desired temperature. Another method of securing a large filter surface in a limited space is shown in plan in Fig. 73. This is made up of a series of wooden frames, to which cheesecloth is tacked, arranged in saw tooth fashion as indicated in the cut. In the case of large filters of this kind, it is customary to use upright pieces of tee iron and attach the wooden frames to these by means of thumb screws, so that they may be easily removed for cleaning.

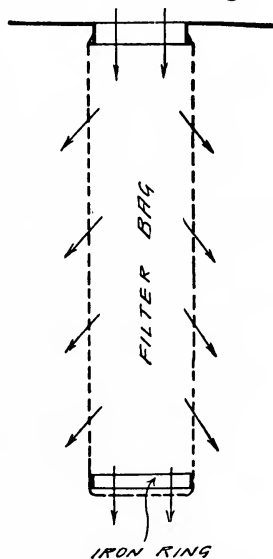

Fig. 71—Another Arrangement of Bag Filter

Sometimes fine wire screens are used instead of cloth. This is subject to the same objection, however, that of clogging and requiring frequent cleaning to get satisfactory results. Filters of this type are sometimes provided with a vacuum arrangement which removes the dust automatically as fast as it accumulates.

Wet Filters or Air Washers

What are some of the principal advantages and disadvantages of the wet filter or air washer?

Among the principal advantages of this type of filter may be mentioned smaller space required for a

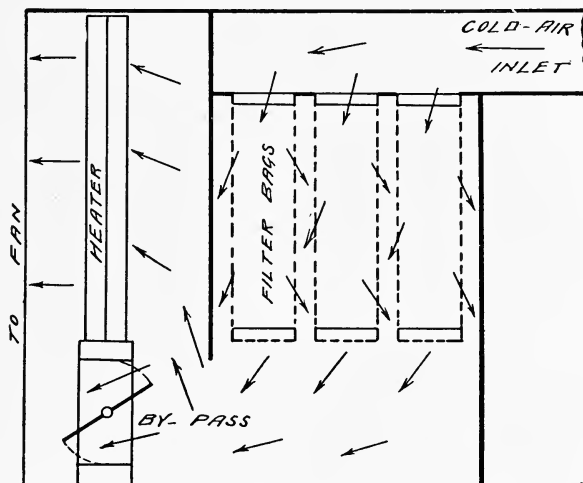

Fig. 72—Typical Arrangement of Filter, Heater and By-Pass given capacity when compared with a dry filter; greater efficiency, as small particles of dust are removed as well as the larger ones; the removal of certain gases and odors which are not affected by a dry filter; the ability to regulate the humidity of the air within certain limits; the cooling effect upon the air, and the comparative ease with which the apparatus is kept in effective working order. The principal disadvantage is the first cost of an apparatus of this kind.

What are the essential parts of an air washer and how are they arranged with reference to one another?

The essential parts are: First, a tempering coil or

heater, for raising the temperature of the entering air to a point somewhat above freezing; second, a spray chamber, containing spray heads or perforated pipes, where the incoming air is thoroughly mixed with the water and purified; third, an eliminator or separator,

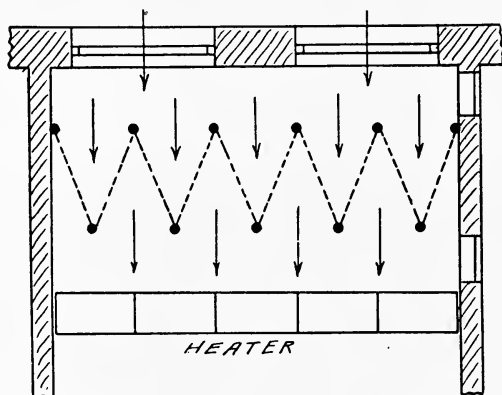

Fig. 73—Securing Large Filter Surface in Small Space

for removing the excess of moisture from the air before it passes through the secondary heater to the fan; fourth, a tank or trough beneath the spray chamber, for catching the water as it falls from the sprays and eliminator blades; fifth, a suitable pump and driving motor, for maintaining the necessary pressure at the spray heads.

The general arrangement of the various parts of the apparatus is clearly shown in Fig. 74. The air entering the outside windows first passes through the tempering coil, then enters the spray chamber and eliminator in succession, and finally passes through the secondary or main heater to the fan.

In what form is the tempering coil usually made?

This is usually made up of wrought iron pipes screwed into a cast iron base, and contains sufficient

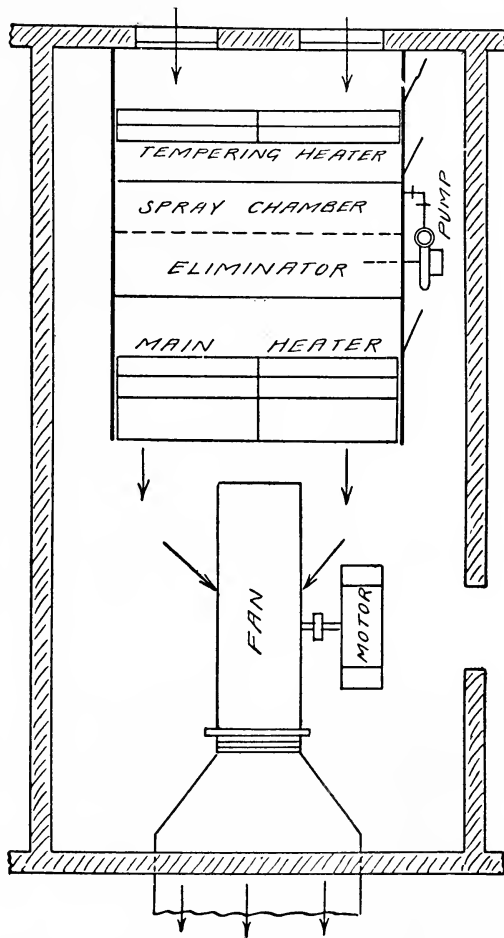

Fig. 74—Arrangement of Air Washer, Heaters and Fan surface to raise the temperature of the total air volume to about 40 degrees in the coldest weather. A heater

of this type should be made three rows of pipe deep for zero conditions. The heater is usually made in one section, as it is generally necessary to use the entire coil under most conditions. Any temperature regulation at this point is commonly obtained by the use of a by-pass damper placed either above or below the heater.

What substitute is sometimes used for a tempering coil?

In some cases the tempering coil is omitted and the spray water heated by means of steam coils before being pumped into the washer.

What forms of spray are produced in different washers and what are the characteristics of some of them?

In some types the water simply falls from the ceilings; in others it is sprayed in thin sheets at right angles to the air current; in others it falls over the edges of troughs like rain; and in still other forms a very fine spray or mist is produced.

What are the relative effects of different forms of spray?

It has been found that air is most thoroughly washed and cleansed by passing through a spray chamber having nozzles producing a rain effect. On the other hand, a fine spray or mist is much less efficient in cleansing the air, but by its more intimate contact with it, evaporates more quickly, and therefore produces a much greater cooling effect.

What is the best form of nozzle for all around service?

For ordinary service a nozzle producing a combination of rain and mist effect is the most desirable.

If cleansing only is desired a coarse spray may be used or a very fine one when cooling is the more important.

What feature should always be considered when selecting a nozzle or spray head?

The nozzles should be easily adjusted and either self cleaning or so constructed that the entire member may be flushed out by means of a single lever placed outside the casing of the spray chamber. This is an important matter, as the successful operation of the washer depends largely upon the proper action of the spray nozzles, and the easier they are kept in working order the more likely those in charge are apt to attend to them.

What form of pump is commonly used for supplying the nozzles and what pressure is required?

A centrifugal pump is generally used for this purpose driven by an electric motor. Sometimes the pump is belted to the fan shaft, but experience has shown it to be much better to provide an independent motor. With this arrangement the washer may be started up and adjusted or flushed out before the fan is started. Again washers are often installed separately from the fan equipment, where the fan drive or motive power has been proportioned for operating the fan only and will not work satisfactorily under the added load. The required pressure will depend somewhat upon the type of nozzle used, but under average conditions should run from 15 to 30 pounds per square inch.

What piping is involved in connecting a pump with an air washer?

The usual piping is shown in Fig. 75, although it will differ somewhat in detail in different makes. The pump and motor are shown at the left. The suction

connects with the tank or trough at the bottom of the spray chamber and is furnished with a suitable strainer. The discharge pipe leads to the different groups of spray heads and is provided with a pressure gauge as indicated. At the right of the tank there is an overflow and drain to the sewer. Fresh water is admitted automatically by means of a ball cock shown at the left.

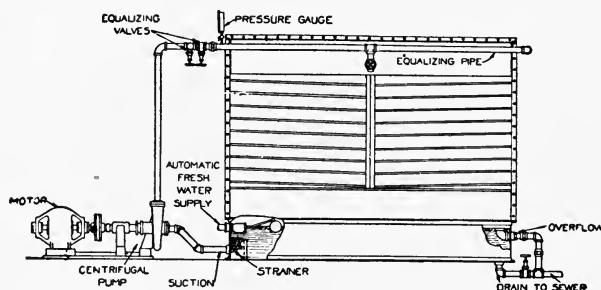

Fig. 75—Piping for Air Washer

What is the general construction of an eliminator and what conditions are to be met?

The eliminator is usually made of galvanized iron or copper. It operates on the principle that by a sudden change of direction the air passes on, but the particles of moisture and accompanying dirt are thrown against the wet surfaces of the eliminator and drain to the tank through channels provided for that purpose. In some cases the eliminator blades are vertical, while in others they are nearly horizontal, and drain separately into a channel at one side of the chamber. It is claimed that with vertical blades the water and dirt are liable to be picked up again by the air as the downward stream increases in size near the bottom of the chamber. In any arrangement part of

the eliminator surface should be passed by the air at high speed, so as to drive the particles of dirt against the wet plates. The remainder of the surface should be passed more slowly, in order that as much of the moisture as possible may be deposited.

How is the area for the passage of air through the spray determined?

This is based upon the velocity of flow, which commonly varies from 400 to 500 feet per minute, although different makes require different velocities in order to obtain the best results.

What percentage of the contained solid matter may be removed by the use of a washer?

The manufacturers of the leading makes of washers guarantee to remove not less than 98 per cent. of the solid matter from the air passing through them.

May the organic impurities thrown off by respiration and perspiration be removed from the air by washing?

It is claimed that a suitably designed and operated washer will remove a large proportion of these from the air passed through it. This makes it possible in many cases to recirculate the air to a certain extent in buildings heated by the hot blast system, thus reducing the fuel cost materially.

Can injurious gases and disagreeable odors be removed in a similar manner?

Certain gases which are soluble in water may be removed, also odors of some kinds.

Humidity Control

What is the effect of humidity upon the comfort of a room when considered in connection with heating?

Increasing the humidity has the effect of making a room comfortable at a lower temperature. This is due to the fact that the cooling effect of evaporation which takes place more rapidly in a dry atmosphere is reduced. This is so marked that with a proper degree of humidity a room will be comfortable at a temperature 6 to 8 degrees lower than in the case of a dry atmosphere. In large buildings it is evident that quite a saving in fuel may be effected by properly moistening the air and carrying a lower temperature in the rooms.

What effect does humidity have upon the occupants of schools and hospitals?

In buildings of this kind, heated by hot blast systems, the air is apt to become overdry unless artificial means are provided for moistening it. The effect of this is to produce headache, mental lassitude, and also an irritated condition of the mucous membrane of the nose and throat. These symptoms may be avoided by supplying an abundance of fresh air at the proper degree of humidity.

What is the effect of humidity in factories and manufacturing of different kinds?

The proper degree of humidity is very important in textile mills, in order to prevent static electricity and also the roughness and breaking of threads. It is also important in tobacco factories, leather warehouses, bakeries, etc. When humidification is combined with suitable ventilation much lower temperatures may be carried, which adds greatly to the comfort and efficiency of the operatives, as well as improving the quality of the manufactured goods.

What objection is sometimes raised to humidifying the air, and may this objection be overcome?

It is sometimes claimed that the air will absorb so much moisture from passing through the spray of a washer that it will be deposited upon the walls and windows of the rooms. This may be avoided by maintaining a temperature in the spray chamber which will never exceed a mean between the temperature of the external air and that of the room. For example, if the temperature of the room is 70 degrees and the outside air 10 above zero, the temperature in spray chamber

$$\frac{70 + 10}{2}$$

should not exceed $\frac{70 + 10}{2} = 40$ degrees. This is true,

because the glass itself is at a temperature midway between the two extremes, and, therefore, is unable to lower the temperature of the air to its dew point.

To what extent may the temperature of the entering air be lowered in the summer time by the use of a washer when no steam is on the coils, and in what way is it done?

Under average conditions the temperature of the air during the warm months may be cooled from 6 to 8 degrees by passing it through a suitable spray. The reason for this is the evaporation of the moisture, and the latent heat required to do this is taken from the air itself.

Types of Wet Filters

What are some of the details of construction of representative types of washers?

A front elevation of a common form of washer is shown in Fig. 76 and a side view in Fig. 77. The lipped perforations of the deflector or eliminator blades are shown in Fig. 78. In operation the spray from the nozzles discharging against the perforated

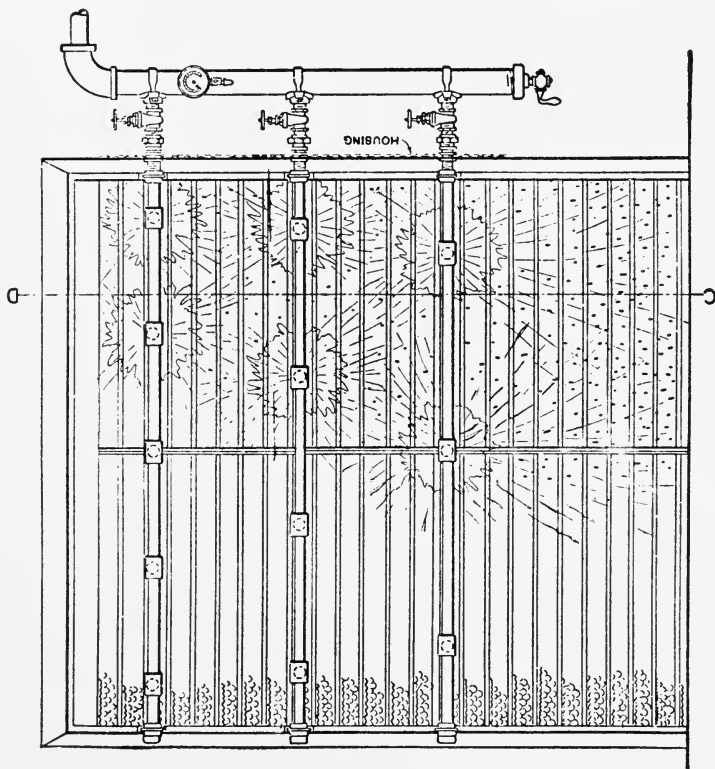

Fig. 76—Front Elevation of Common Form of Washer

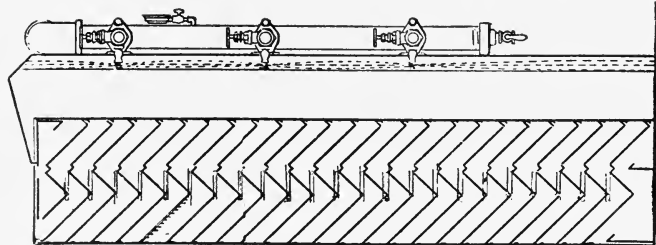

Fig. 77—Cross Section on Line C, D of Fig. 76

deflectors, impinges upon the lips of the openings and drips with rain-like effect from one section to another, forming a current of moisture through which the air must pass. In the ordinary sized washer three rows of spray pipes are required, as shown in the cut. If it is desired to increase the humidity of the air it may be done by the use of an ejector, connected with an adjacent steam pipe and with the pump discharge. This arrangement throws a fine mist into the chamber and therefore increases the evaporation. Another form of washer is shown in Fig. 79. In this case the air is drawn through two complete semicircles within the

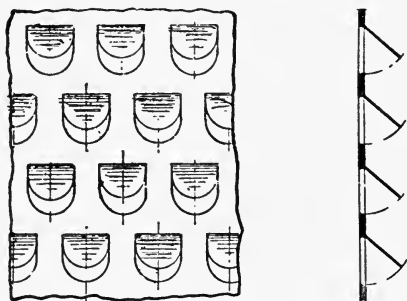

Fig. 78—Tipped Perforations of Deflector Blades

spray chamber. The water is thrown in radial sheets by the spray heads, so that it splashes against the curved walls of the air passage, producing the effect of rain and keeping a constant film of water on the surfaces over which the air flows. When it is desired to increase the humidity, a form is used in which the air is drawn upward against the spray, thus producing a fine mist within the casing. The eliminator blades in this instance are vertical instead of horizontal, as in the one previously described. The casing is made either of sheet metal or of concrete.

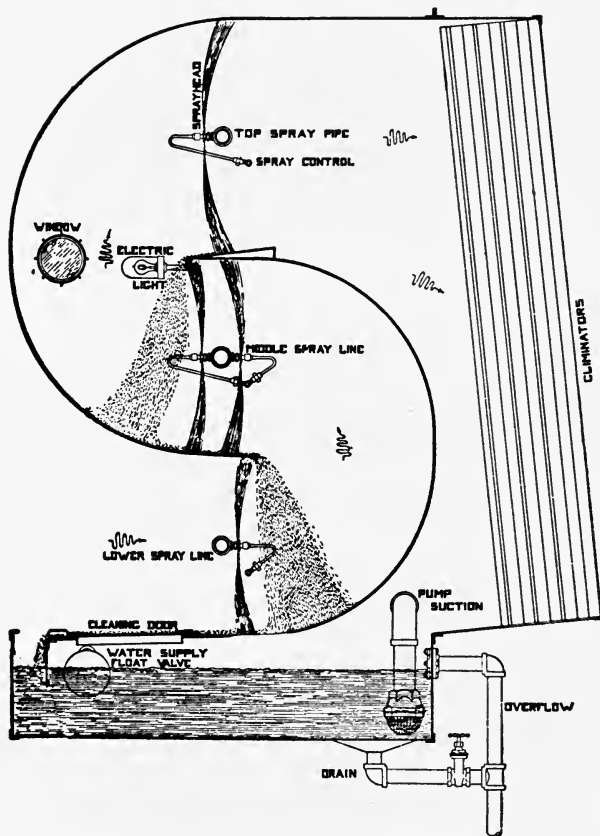

Fig. 79—Another Form of Air Washer

What form of wet filter is sometimes used, which varies from the air washer in having no spray heads or eliminator?

The oldest type of wet filter is that employing some coarse material, like coke, over which water is made to trickle by means of a distributing pipe at the top.

Such a filter is shown in Fig. 80, and consists of a double wire screen of coarse mesh, the sides of which are placed about 8 inches apart, and the space between filled with coke, the lumps of which must be between $1\frac{1}{2}$ and 2 inches in size to get the desired results.

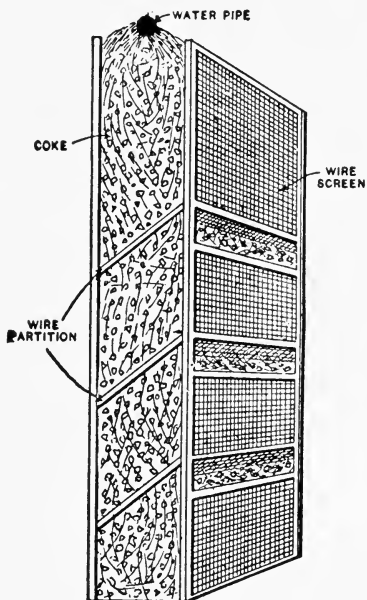

Fig. 80—A Wet Filter

The objections to such a filter are its size and the expense for water, which must flow over it constantly, and, having no pump connection, as ordinarily used, this must go to waste. In order not to produce too much resistance the gross area must be from 8 to 10 times the area of the air duct.

CHAPTER IX.

VENTILATION OF VARIOUS TYPES OF BUILDINGS

Kitchens and Restaurants

What particular fixtures should be ventilated in the kitchen of a restaurant or hotel?

In kitchen ventilation the air should be removed from points where it will carry away the greatest amount of heat, steam and odor from the room.

This is best done by producing a strong outward draft of air from hoods placed over the range, oven and tea and coffee urns.

How is this draft of air best produced?

Fans, either of the disk or centrifugal type, should always be used for the ventilation of restaurants, as the natural draft of heated flues is not sufficient for this purpose, except in special cases.

What is an exception to this rule?

In some cases sufficient ventilation from a small room may be obtained by connecting the vent duct with a brick flue surrounding an iron boiler stack. This should only be done when a lighting or elevator outfit is included in the building plant, so that the boilers will be in use the year around.

When should a disk fan be used, and when is one of the centrifugal type best adapted to the work?

Disk fans are commonly used for this purpose when the ducts and flues are of comparatively short lengths

and of generous area, so that the resistance operated against is small. They are particularly adapted to cases where the air may be blown directly outward through a wall opening. When the vent flue must be carried from the basement to the roof, as is commonly the case in city buildings, it is necessary to use an exhauster of the centrifugal type in order to overcome the resistance.

Should the fan be placed at the top or bottom of the flue in a case of this kind?

In general, it is better to place the fan at the bottom of the flue just beyond the junction of the different branches, as shown in Fig. 81.

What is the reason for this?

First, it is usually more convenient to care for a fan and motor located in the basement than on the roof; and second, there is more chance for inward leakage with a long suction pipe, which tends to weaken the draft at the points where it is desired to have it the strongest.

Of what material should the ducts be constructed in kitchen ventilation, and why?

Ducts and flues for this purpose are best constructed of galvanized iron on account of their smooth interior surfaces and the ease with which bends of large radii are provided for. Vertical flues of larger size may be of brick, tile or cement, provided care is taken to make the interior surfaces as smooth as possible.

What special precaution should be taken in the construction of kitchen vents?

They should always be made fireproof, and so arranged that they cannot set fire to surrounding wood-work if they become overheated. The smoke from a

range, where meats are cooked, causes the formation of a greasy soot in the flues which is very inflammable and burns with an intense heat for a short time.

What should be the general form of the range hood to secure the best results?

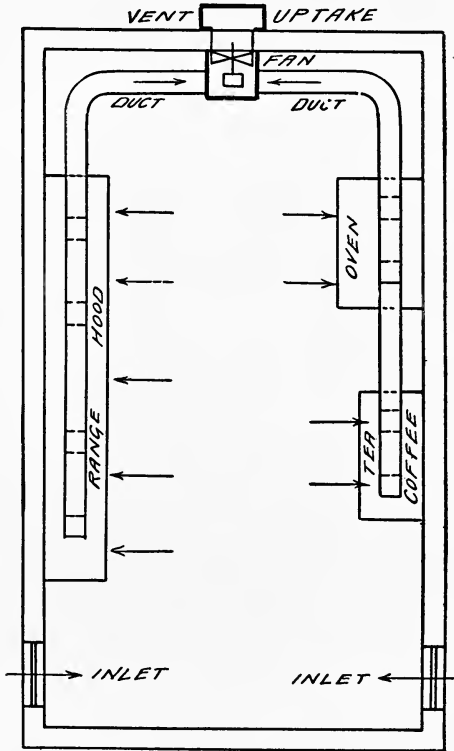

Fig. 81—Disk Fan Placed at Bottom of Flue

This is shown in section in Fig. 82, and is provided with a deflector running the entire length, and forming a closed chamber with a slot about $1\frac{1}{4}$ inches in width along the edge.

The top of the hood is connected at intervals with the duct leading to the fan, as shown in Fig. 81.

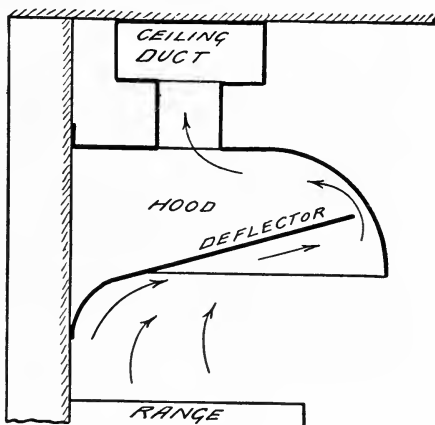

Fig. 82—Range Hood, Showing Deflector

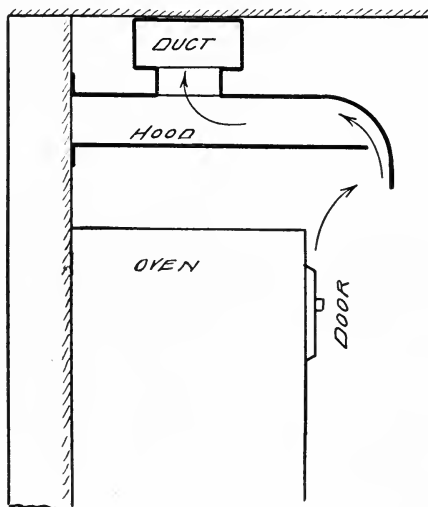

Fig. 83—Hood for Ventilating Oven

What is the advantage of this construction over the usual form of open hood?

With this arrangement, the entire volume of air exhausted from the hood is drawn through the slot at a high velocity, thus catching all smoke before it has an opportunity to pass under the edge of the hood into the room. The general path of the smoke and hot air is indicated by the arrows in Fig. 82.

What point should be most strongly ventilated in case of an oven?

In the case of oven ventilation, provision should be made for catching the outward rush of hot air which occurs when the door is opened. The general form of a hood for this purpose is shown in Fig. 83.

Cottage Hospitals

How is ventilation usually obtained in the case of cottage hospitals?

In buildings of this kind the ventilating system is usually combined with the heating, as shown in Fig. 84. The wards in this case are heated by the introduction of warm fresh air which also serves for the ventilation. The illustration shown is for a two story building. A cold air supply duct, or chamber, is formed by constructing a false ceiling over the basement corridor with connections leading to windows in the outside walls, either at the sides or end of the building, or at both, if it is of considerable length. When supply openings lead in from opposite sides of the building they should be provided with canvas checks to prevent the air from blowing entirely through.

What is the arrangement of the heating stacks?

These for both the first and second floor wards are located in the basement on either side of the cold air

duct. They are enclosed in galvanized iron casings and connected with the air chamber as shown.

How is the temperature of the air supplied to the different wards regulated?

This is cared for partly by dividing the heating stack into two or three separately valved groups, and partly

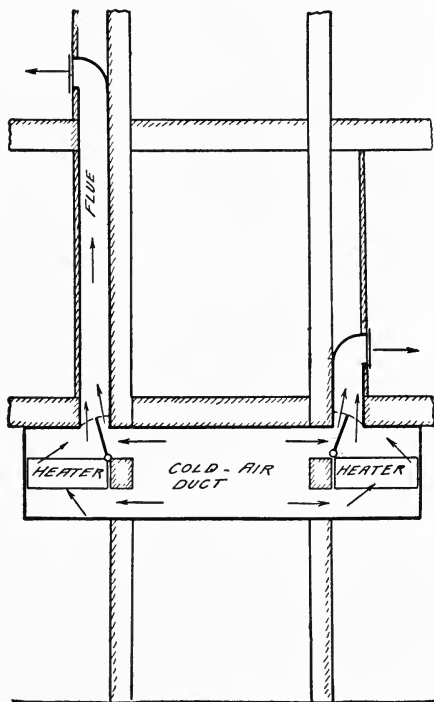

Fig. 84—Ventilation Combined with Heating for Cottage Hospital

by the use of mixing dampers placed at the base of the flue and operated by a chain extending to the room above.

How is the area of the cold air duct determined in a case of this kind?

A simple way to determine the size of the cold air supply duct for this class of work is to allow 4,000 to 5,000 cubic feet of air per occupant per hour, and figure on a maximum velocity of flow in the duct of about 250 feet per minute. The warm air uptakes may be proportioned on a velocity of 250 feet per minute for the first floor rooms, and 300 for the second.

How is the discharge ventilation in a building of this kind cared for?

This is provided for either by the use of fireplaces or special galvanized iron flues leading from the different rooms to the attic space, where they are gathered into one or more main ventilators leading through the roof.

How is a strong draft established in these vent flues in mild weather?

This is done by starting fires in the fireplaces and placing steam coils in other vent flues for heating the air to a temperature somewhat above that of the connecting room.

What is the best arrangement for supplying cold air to the indirect heating stacks when the basement is not used for other purposes?

When the basement of a ward building is not used for other purposes it may be utilized as a cold air chamber, as shown in Fig. 85. Air is admitted through two windows on each side of the building, the same being provided with checks for preventing back drafts, as already described. The heating stacks have open bottoms and take the air directly from the basement;

otherwise, the arrangement is the same as that shown in Fig. 84.

What is the advantage of the method of air supply described above?

When the air is first admitted to a large chamber it serves to equalize the pressure so that each stack receives its proportional share; at the same time, the

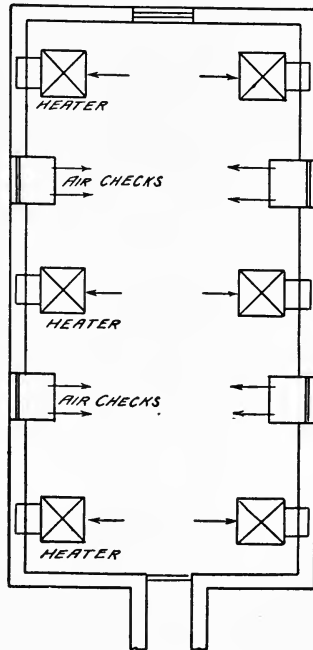

Fig. 85—Basement Used for Cold Air Chamber

temporary effects of gusts of wind are avoided and the entire system works more smoothly than when the stacks have independent inlets or are connected with an air chamber of smaller size.

Audience Halls

How does the heating and ventilation of a hall vary from that of a hospital or similar building?

A hospital is made up of a large number of com-

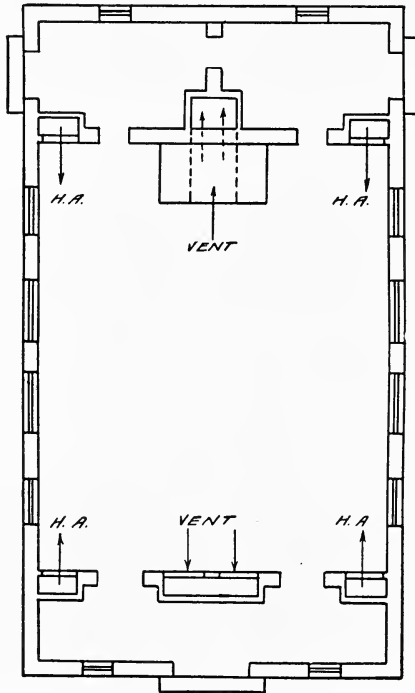

Fig. 86—Arrangement of Supply and Vent Flues

paratively small rooms which must be regulated separately, both as to their heat and air supply, while a hall consists of one large room, with the addition of vestibule and ante-rooms which are only heated.

What is the proper arrangement of the supply and vent flues in a hall of medium size?

These are shown in Fig. 86. The warm, fresh air is brought in through four wall registers placed 7 or 8 feet above the floor. The arrangement at the base of each flue for supplying the heat is shown in Fig. 87, and consists of a heating stack with cold air chamber and mixing damper, as already described in connection with hospital work.

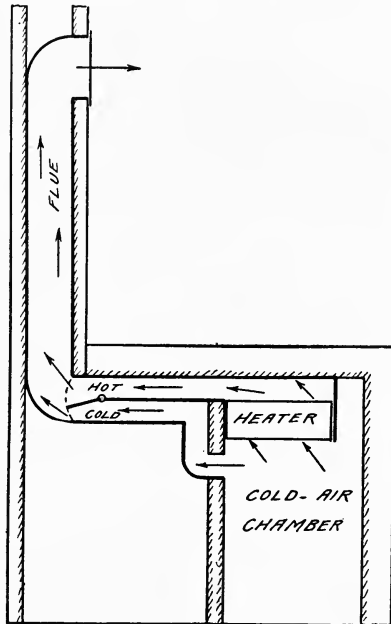

Fig. 87—Supplying Heat at Base of Each Flue

What is the best method of supplying the warm air to a large hall?

In this case, a fan should be employed, as increasing the number of indirect stacks and cold air rooms complicates the system and makes it more difficult to operate properly.

How many heaters are required with a fan system?

When a fan is used, the entire heating can be done by means of a single large heater divided into a number of valved sections and provided with a by-pass or mixing damper for the final temperature regulation.

What precaution is necessary when a fan is used for this purpose?

When the air is supplied by a fan through a limited number of large openings, care must be taken to so distribute the entering currents as to avoid drafts of air from blowing directly upon the heads of the audience.

What is the best method of doing this?

This may be done by placing a diffuser outside of the register face, with the blades so arranged as to throw the air sidewise in each direction from the center. When the vent registers are near the floor, a portion of the air may also be thrown upward, as it will find its way to the breathing line when it cools and falls.

Sometimes sufficient diffusion may be obtained by using an ordinary register valve back of the cast iron face, with the vanes in a horizontal position, and set to throw the air slightly upward as it enters the room.

How is the discharge ventilation from a hall best arranged?

For ordinary use, the discharge ventilation should be through registers near the floor, as shown in Fig. 86, but in addition to these, there should be one or more ceiling vents for use in hot weather or for changing the air quickly when the hall is crowded or overheated.

What provision should be made for accelerating the flow of air through the vent flues?

In the case of small buildings it is usually sufficient to place aspirating coils in the flues or to make use of a brick flue surrounding the boiler stack as already noted in connection with kitchen ventilation. For large halls, employing the gravity system of heating and air supply, it is much more satisfactory to employ a fan for the removal of the air from the building.

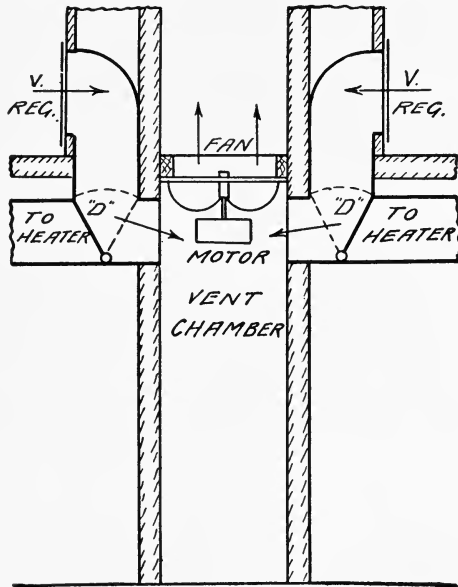

Fig. 88—Disk Fan Used for Two Vent Registers

What are the advantages of this method over gravity flow?

A fan is positive in its action under all conditions of temperature and wind pressure, and produces a slight vacuum in a closed room, which assists in drawing in the fresh air supply through the heaters.

What type of fan is best adapted to this purpose and how should it be arranged?

Disk fans are commonly used for this purpose, being of light weight and easily mounted in ducts and flues above the basement.

A simple method of connecting with two vent registers, an arrangement which is also adapted to school-house work is shown in section in Fig. 88.

The fan in this case is mounted in the base of a large flue leading outward, and drawing its air from a vent chamber with which the various registers are connected. The fan is driven by a direct connected electric motor, and is mounted with its shaft in a vertical position.

Air Rotation

What is meant by "air rotation" in connection with a system of indirect heating, and how is it provided for?

In buildings like halls, churches, schools, etc., where ventilation is required for only a part of the time, while audiences or classes are assembled, and where heat is necessary at other times, provision should be made for passing the air through the heaters again and again, taking the supply from the building itself instead of from out of doors. This is accomplished in some cases by opening stairway and corridor doors and allowing the air to pass down to the chambers beneath the stacks without the use of special ducts. In other cases, the vent registers are made use of as in Fig. 89. When dampers "D, D," are in the position shown by the full lines, the air passes to the vent chamber and is discharged by the fan in the usual manner. When ventilation is not required, the dampers are thrown over the position indicated by the dotted

lines and the air then passes back to the heaters, where is reheated and flows into the rooms again. Local conditions will usually indicate the best arrangement to employ in cases of this kind.

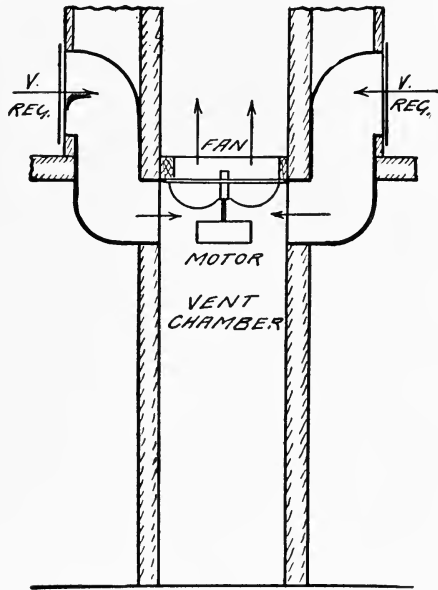

Fig. 89—Vent Registers Used for “Air Rotation”

How are the vestibules and ante-rooms provided for?

It is not customary to supply fresh air to these rooms, and they are usually heated by direct radiation. If it is desired to ventilate the ante-rooms, they may be connected with the main vent flues by means of ducts carried at the basement ceiling.

Churches

How does the ventilation of a church differ from that of a hall?

There is very little difference between the methods employed in heating and ventilating a church from those used in case of a hall when the gravity system of air supply is employed, and the diagrams shown in Figs. 86, 87, 88 and 89 apply equally well to either case.

What are the best methods of introducing the air when a fan system is employed, and what precautions must be taken?

The best method of introducing the air to a church when a fan is used consists in delivering it through a large number of small streams at a low velocity, in order to reduce the danger of drafts to a minimum.

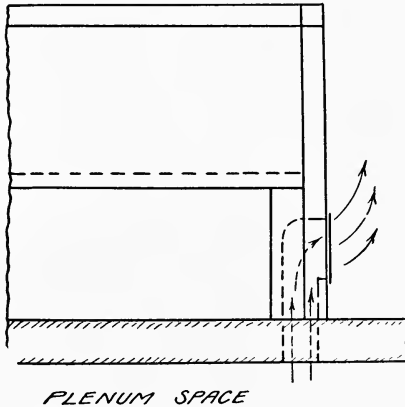

Fig. 90—Introducing Air Through Small Registers
in End of Pews

A common arrangement is to provide an air, or plenum, space beneath the entire floor by means of a false ceiling in the basement, or by raising the floor itself with a gentle rise toward the rear. The air is then brought from this space into the room through small register faces in the ends of the pews, as shown in Fig. 90.

The flues connecting the plenum space with the registers are made of galvanized iron and concealed in the leg of the pew as indicated. When this arrangement is used, it is usually sufficient to place a register in every other pew, alternating upon opposite sides of the aisle.

When a better distribution of air is required, a portion of it may be turned inside the pew as well as into the aisle.

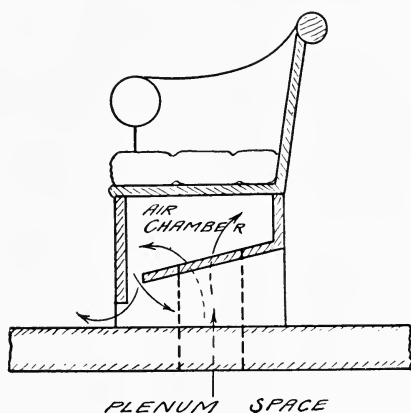

Fig. 91—Another Arrangement for Obtaining Better Distribution

Another plan is shown in Fig. 91, in which case an air chamber is constructed under each pew, running the entire length. Air is admitted to this from the plenum space and finds its way into the room through a narrow slot, about 1 inch in width, as indicated by the arrows.

How should the discharge ventilation be arranged when the air is admitted in this manner?

When the air is introduced near the floor through a large number of evenly distributed openings, it rises slowly to the breathing line in a solid layer, and after

being used, passes upward to the top of the room, where it should be removed through the ceiling vents.

No vent registers are required near the floor, neither are aspirating coils or heaters necessary, as the pressure from the supply fan is sufficient to force the air out.

Schoolhouses

What three general systems are commonly employed in the ventilation of school buildings?

School buildings are ventilated by hot air furnaces, indirect steam with gravity in circulation, and by fans.

To what class of buildings is each adapted?

Furnace heating is adapted to buildings of small size, say up to four class-rooms; indirect gravity heating, up to eight rooms, and fan systems, to those of larger size.

What are the advantages and disadvantages of furnace heating in this class of work?

Buildings of this size are commonly found in small towns where the matter of expense is an important item, and as a furnace system is cheaper to install than steam it is more frequently used in buildings of this kind. Furnaces are also easily cared for and require less skill than either of the other two systems, which is also a matter of some considerable importance in certain localities. The principal disadvantage is the difficulty of regulating the air flow to the different rooms in windy weather.

How may this disadvantage be largely overcome?

By placing the furnace directly beneath the vertical flues and avoiding horizontal ducts of any length; also by providing cold air equalizing chambers, with inlets from at least two sides of the building.

How is the temperature of the air best regulated?

Temperature regulation is secured by proper control of the fire and by the use of mixing dampers at the bases of the flues.

What size of furnace is commonly used in school-house heating and how are they best arranged?

It has been found by experience that an efficient type of furnace with a grate 32 inches in diameter, or its equivalent, will properly heat and ventilate two standard sized (28'×32') school rooms in zero weather. They are commonly arranged so that one furnace will supply two rooms, being placed near, or directly below the partition line separating them, in order to avoid the use of horizontal pipes.

How does the furnace used for this class of work differ from that used in heating residences?

Chiefly in its greater size and in the larger area for the passage of air between the body of the furnace and the casing. This area should be such that the velocity will not exceed 400 feet per minute when supplying the maximum amount to the building.

Why cannot furnaces be used in large buildings as well as in those of small size?

The principal objection to this is the multiplication of furnaces, which makes it difficult to care for the plant properly and adds to the dirt and litter caused by the handling of coal and ashes. In addition to this, it is somewhat difficult to run a number of separate fires in such a manner as to heat all parts of a building evenly.

How are the vent flues heated when a furnace system is employed?

Two methods are commonly employed for this pur-

pose; one being to carry the iron chimney flue from the furnace up through a brick stack, of sufficient size to ventilate two class-rooms, and thus utilize the heat which would otherwise be wasted. When this is done, a central wall is usually provided which separates the flue into two equal parts, each containing one-half the iron stack.

The other method is to place a small coal stove, called a "stack-heater," in the base of each flue, and carry a separate fire in each. When these are used, the air from the vent register should be brought into the flue below the heater by means of a galvanized iron duct.

What is the advantage of indirect gravity heating over the furnace system for larger buildings?

In this case the entire heating and ventilating can be done by means of a single boiler, or battery of boilers, thus simplifying the work of firing and ash handling.

How are the heating stacks best arranged in this method of heating?

Each class-room is provided with a separate stack placed at the base of the vertical supply flue and enclosed in a galvanized iron casing or a brick chamber. Cold air is brought to the heating stacks in a manner similar to that already described for halls and churches.

Temperature regulation is best secured by means of mixing dampers at the heaters and operated from the rooms above.

What method is employed for warming the vent flues in this system of ventilation?

The vent flues are heated by aspirating coils, from

30 to 40 square feet of heating surface being placed in the vent from each standard class-room.

What three arrangements are commonly employed when a fan is used?

The three common arrangements, employing a fan for air supply, are the following: The double-duct system; a fan and heater for ventilation only supplemented by direct radiation in the rooms; and the same with secondary heaters at the bases of the flues, instead of direct radiation in the rooms.

What is the principle of the double duct system?

In this arrangement the air is first drawn through a heater which raises its temperature to about 58 or 60 degrees; then a portion of this is passed through another heater beyond the fan which raises the temperature to about 110 or 115 degrees. Air at these two temperatures is carried to the base of each flue in separate ducts, and there mixed by suitable dampers in the proportion necessary to give the desired temperature to the room. This is the older system and is not so frequently used as the other two.

What are the advantages of the second method and how does it operate?

In this case the heating and ventilating systems are entirely independent. The air for ventilating purposes is raised to a temperature of 70 degrees by drawing it through a main or primary heater and is delivered to the rooms at that temperature regardless of the outside weather conditions. The heat lost by transmission and leakage through walls and windows is then made up by direct steam coils or radiators placed in the rooms. The advantage of this is greater simplicity in the duct construction and the delivery of heat

along the outer walls of the building, where it is most needed.

What are some of the more important features of the third system?

In this case the heating surface is placed in the air-way at the base of the duct instead of in the room and the additional heat required for warming is carried in with the air supply, the same as in the double-duct system. The advantage of this consists in keeping the radiation and piping out of the rooms, the appearance of these being objectionable to some owners and architects.

Theatres

What are the principal conditions to be met and overcome in the ventilation of theatres?

A theatre differs from other buildings in the large number of people seated on a given floor space. The problem, therefore, is to supply sufficient air without uncomfortable drafts.

How is this best done?

A theatre should always be provided with fans, both for supply and discharge ventilation, as gravity circulation is not sufficient to overcome the resistance met with in this class of work.

What arrangements are commonly employed for introducing the air to the auditorium of a theatre?

A simple method, adapted to small theatres, is shown in Fig. 92. The seats are placed on a raised floor, like broad stairs, with a plenum space beneath connected with the fan. The air passes from here into the room through narrow slots extending the full length of the risers, as indicated by the arrows.

Another arrangement, used extensively in large thea-

tres, is to provide an opening under each chair, covering the same with a spherical head for deflecting the air downward as it enters. These inlets, commonly called "mushrooms," are made of cast-iron and are usually provided with dampers for regulating the air flow. In other cases the air is admitted through perforated chair legs, of cast-iron, connecting with the plenum space below.

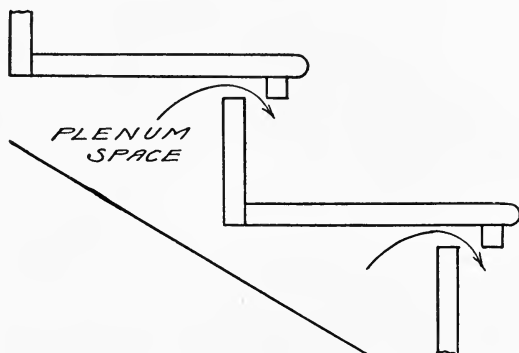

Fig. 92—Introducing Air into Auditorium of Theatre

How is the foul air best removed from a theatre to secure the most satisfactory results?

The vent registers should be located at the sides and back of the room, beneath the galleries, and also in the ceiling of the main auditorium. These should all be connected with one or more vent fans for producing a strong draft, especially from the openings beneath the balconies or galleries.

Ventilation of Isolated Rooms

What method is often used for supplying fresh air to an isolated room where direct cast-iron radiators are used for heating?

A simple arrangement for this purpose, where the radiator stands in front of a window, is shown in Fig. 94. This consists of a casing of galvanized iron or sheathing, so arranged as to take air from beneath the raised sash and pass it beneath the sections of the radiator, as indicated by the arrows. The temperature of the air is regulated by a mixing damper "D," and the mixture of cool and warm air passes into the room through a register in the top of the casing. During the night, or when ventilation is not required, the register near the floor is opened and the window closed.

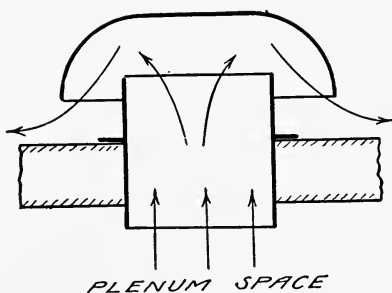

Fig. 93—A Mushroom Inlet

What simple and effective means may be used for discharging air from a room or office having a fireplace?

An arrangement for this purpose, which may be adapted to a flue without interfering with the use of the fireplace, is shown in Fig. 95. An opening is cut into the flue at some point above the mantel, and an iron sleeve introduced provided with a damper "D," hinged at the bottom. A shelf is placed in front of the opening and on this an ordinary electric desk fan, so arranged as to draw air from the room and force it into the flue. When it is desired to use the fireplace, the

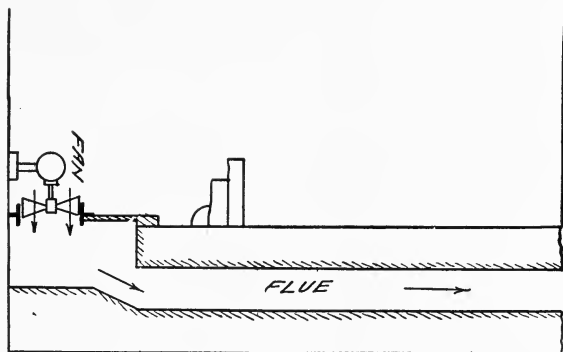

Fig. 96—Another Arrangement for Same Purpose as Shown in Fig. 95

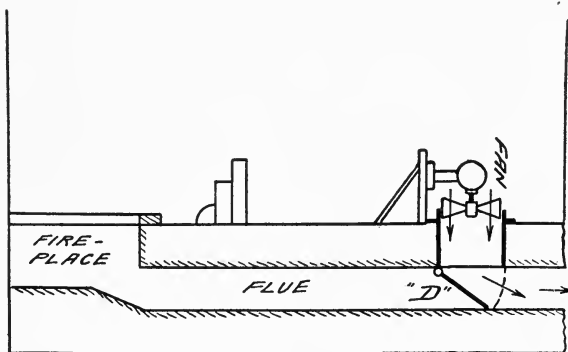

Fig. 95—Discharging Air from Room with Fireplace

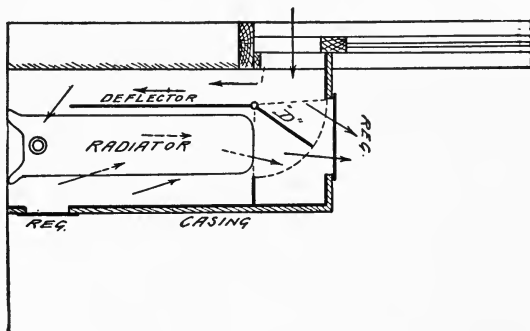

Fig. 94—Supplying Fresh Air to Isolated Rooms

damper may be raised to cover the opening at the fan and the fire started in the usual manner. This device is especially adapted to offices and other rooms where it is desired to clear the air quickly of tobacco smoke. Another arrangement of a similar kind is shown in Fig. 96. In this case the air is drawn from the bottom of the room instead of the top, and is therefore more suitable for general ventilation than for the removal of smoke.

What simple arrangement may be employed for the ventilation of a large office where a considerable volume of fresh air is required?

A general plan of a system of this kind is shown in Fig. 97, and consists of a small fan and heater enclosed

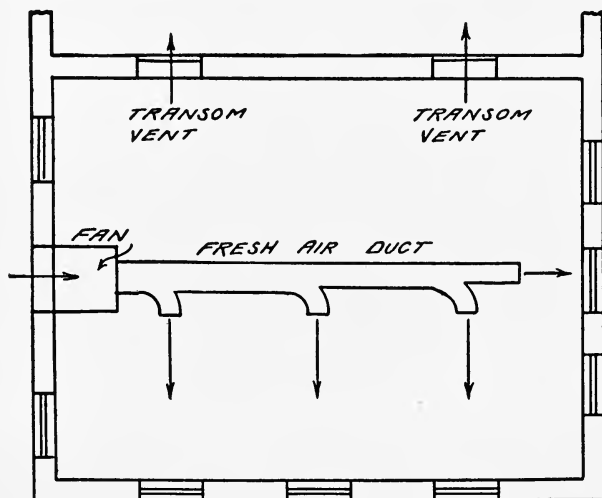

Fig. 97—Method of Ventilating Large Office

in a galvanized iron casing and supported at the ceiling of the room. This may draw its air from the top of

a window and discharge it at various points through a system of galvanized iron ducts running on the ceiling.

Air is discharged from the room through transoms into the main corridor of the building, from which it finds its way out through open doors and skylight ventilators. A section through the apparatus is shown in Fig. 98. The heater in this case is made up of iron pipes screwed into a cast-iron base. A fan of the disk type, driven by a direct connected electric motor, draws the air through the heater and discharges it into the distributing duct, as shown. Temperature regulation is secured partly by varying the number of heater sections and partly by means of a mixing damper.

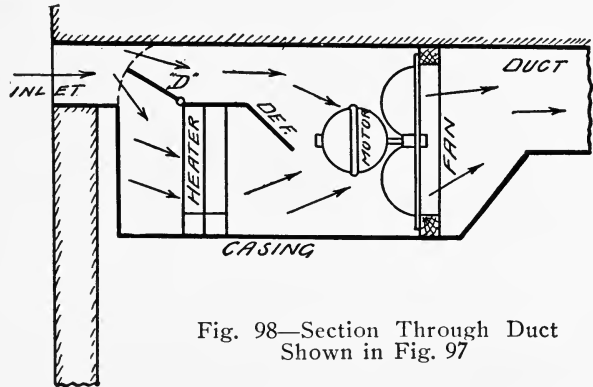

Fig. 98—Section Through Duct
Shown in Fig. 97

This particular arrangement is well adapted to the ventilation of large offices, drafting rooms, stores, etc., where only one or two rooms are to be provided for.

What form of apparatus is commonly employed for more extensive work, as the ventilation of a suite of banking rooms in an office building?

The best arrangement to use in a case of this kind

will, of course, depend upon local conditions. Fig. 99 shows the apparatus located upon a low roof at the

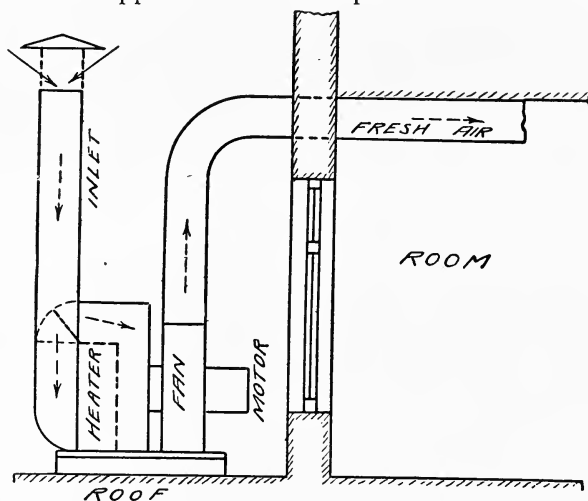

Fig. 99—Arrangement for Ventilating Large Suite of Rooms

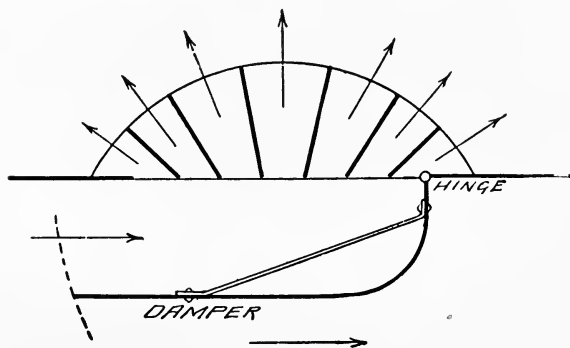

Fig. 100—Detail of Fresh Air Inlet

bottom of a light well. The air is taken from an elevation through a downtake flue in order to avoid surface

dust so far as possible. The heater in this case is made up of wrought-iron pipes, and a centrifugal fan is used, driven by a direct-connected motor. All parts of the apparatus are enclosed in water-proof steel casings, provided with tight-closing doors. The fresh air is carried to the different rooms through a system of ducts running at the ceiling. A detail of one of the fresh air inlets is shown in Fig. 100. Instead of using

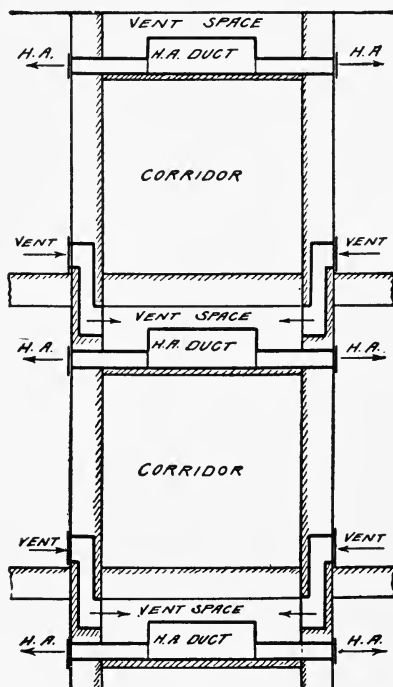

Fig. 101—Air Distribution for Large Office Building

a regular cast-iron register for this purpose, a deflector is constructed, consisting of a series of galvanized iron blades, with an adjustable damper back

of it in the duct, for giving to each inlet the right proportion of air to secure a proper distribution.

Office Buildings

When an office building is equipped with a complete ventilating plant how is the air distribution best arranged?

The large number of rooms in an office building, and the multiplication of stories, makes it impossible to run the distributing ducts in the basement and carry up flues to the different rooms in the usual manner.

Fig. 101 shows in section an arrangement well adapted to cases of this kind. The air supply for the entire building is carried up through one or more large flues, which connect with horizontal distributing ducts at the ceiling of each corridor. These ducts are concealed by a false ceiling, sufficient space being allowed to serve as a vent or discharge duct. The connections between the ducts and the rooms are clearly indicated in the cut.

The fresh air is supplied by one or more centrifugal fans located in the basement, while the foul air is removed by fans of a similar type, usually placed on the roof.

CHAPTER X.

VENTILATION OF TOILETS AND CHEMICAL HOODS

Toilets

What is one of the principal requirements for the ventilation of public toilet rooms?

In order to obtain the best results it is necessary to produce a slight vacuum within, and this cannot well be done if air is forced into the room. Hence it is evident that rooms of this kind should be provided with exhaust ventilation only.

How is the outward draft best produced?

This may be produced either by heated flues or by fans, the latter being necessary in the case of large toilets, except under special conditions to be mentioned later.

How is the air best supplied to a toilet to replace that which has been removed?

This is drawn in by suction through openings provided for this purpose near the floor. These openings may be formed by placing register faces or louvres in the lower panels of the door, or by cutting off 6 or 8 inches from the bottom, thus making an opening of sufficient size beneath it, at the floor.

At what points should the exhaust outlets be located?

In general, these should be near the fixtures, in order to prevent odors from spreading to the air of the room and thus finding their way into corridors, etc.

What simple method of piping may be used for connecting with the vent or discharge flue?

A simple and effective method of making the connections is shown in Fig. 102. In this case a horizontal duct is carried above the fixtures, leading to a

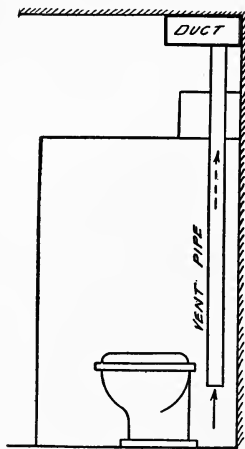

Fig. 102—Piping for Connection with Vent or Discharge Flue

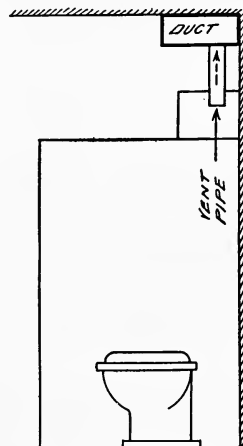

Fig. 103—Short Vent Pipes

fan or heated flue. From this, 4-inch pipes lead down beside, or at the rear, of each fixture, to a point 8 or 10 inches from the floor, thus producing a draft at the point most needed.

What modification of the above is sometimes employed?

As there is apt to be more or less smoking in public toilets, it is well to provide a certain amount of exhaust from the upper part of the room, which may be done by using short vent pipes, say, for every third fixture, as shown in Fig. 103.

What other method is often used?

Where the fixtures are provided with local vents, the best results are obtained by connecting the exhaust duct with these, as shown in Figs. 104 and 105. The local vent openings vary in size with different makes of fixtures running from about $2\frac{1}{2}$ to 4 inches in diameter. The smaller sizes are effective only when a fan is used, on account of the increased resistance.

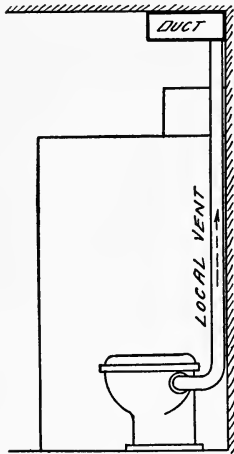

Fig. 104—Connecting Exhaust Duct with Local Vent

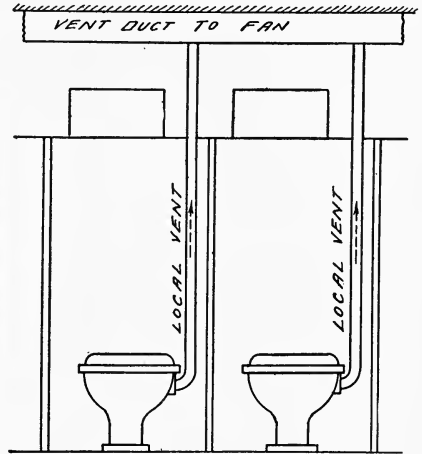

Fig. 105—Another Method of Connecting Exhaust Duct with Local Vent.

What special arrangement of local ventilation gives the best results when there is space for its construction?

The best arrangement is that shown in Figs. 106 and 107, and consists in setting the fixtures out from the wall sufficiently to allow for a closed chamber of slate or marble slabs, of the general form shown in Fig. 106. This should be from 12 to 18 inches in depth,

or sufficient to take in the plumbing connections leading from the closets. The local vents are connected directly into this space by short sleeves as indicated and the air exhausted through a single opening leading to a fan chamber or heated flue. The height of this space may be varied according to local conditions, but is frequently made the same as the dividing partitions between the closets.

Is it necessary to make this closed chamber air tight?

It is not, because any air which leaks into it simply adds to the general ventilation of the room.

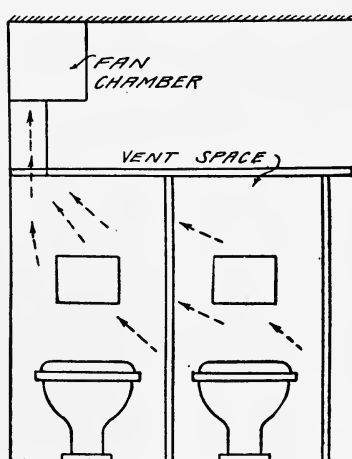
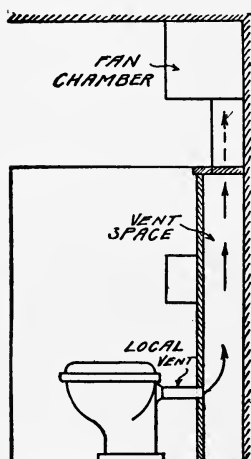

Fig. 106—Closed Ventilation Chamber of Slabs. Fig. 107—Set of Fixtures to Allow for Closed Ventilation Chamber

Should there be any other vent outlets from the room except through the local vents leading from the fixtures?

It is usually customary to place a register, with valves or shutters, in the end of the closed chamber farthest away from the fan. This is for general ven-

tilation of the room and may be set in such a manner as to draw just the right proportion of air from the upper part of the room to remove smoke, etc., if it be present. Care should be taken, however, not to make this so strong as to weaken the draft through the fixtures.

What system of ventilation is sometimes applied to fixtures already installed, where there are no local vents?

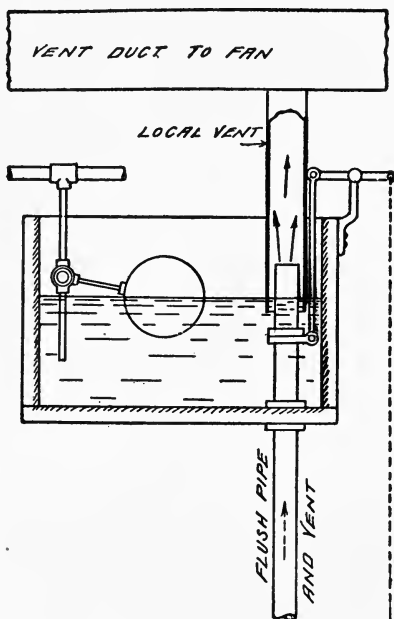

Fig. 108—Method of Ventilation for Previously Installed Fixtures

This is illustrated in Fig. 108, and consists in placing a hood over the top of the flush pipe, the same being sealed by the water in the tank, as indicated in the cut. These hoods are connected with an overhead

vent duct leading to the fan. When the closet is flushed, the seal is broken and air is drawn from the upper part of the room, but as soon as the water in the tank rises to its normal level, the hood is sealed and circulation is again established through the flush pipe, which becomes a local vent. As already stated, this is particularly adapted to old buildings where the fixtures have been installed without any means of ventilation.

How much air should be removed from toilet rooms to secure the best results?

This depends largely upon local conditions. Toilet room ventilation varies from that of other rooms, in that the idea is to remove odors rather than to furnish a supply of fresh air for breathing purposes. Rooms of this kind are not occupied by one person for any length of time, so that the condition of the air as to freshness, above a certain standard of purity, is not of so great importance as in other rooms. However, any system of ventilation for the removal of odors must necessarily bring in a certain amount of fresh air, so the supply is cared for in this way without special provision.

Fan Capacity

How is the fan capacity for toilet work usually computed?

This is found in different ways according to local conditions. In cases where the room is well filled with fixtures it is customary to allow for a discharge of from 10 to 12 cubic feet of air per minute, which gives a velocity of 125 to 150 feet per minute through a four-inch pipe, which is sufficient to carry off all odors and also provide ample ventilation for the room. In other cases, where the room is large compared with the

number of fixtures, the ventilation may be based on the number of air changes; from four to five per hour being sufficient for average conditions.

How are small private toilets commonly ventilated?

Small toilets, kept in good condition, are usually ventilated by means of the window. A local vent pipe carried to a cold flue is of no practical use, as the air is as likely to flow in one direction as the other. Sometimes the pipe is connected with a warm chimney flue, which tends to create an air movement in the right direction.

Type and Location of Fan

What type of fan is commonly used for toilet ventilation, and how is it best connected?

Disk fans are ordinarily used for this purpose where horizontal distances are short and the main outboard flue of good size. A good arrangement for a fan of this kind, drawing air from a closed space back of the fixtures and discharging into a nearby flue, is shown in Fig. 109. The fan is driven by a direct-connected electric motor of the enclosed type and the whole outfit placed in a galvanized iron casing, provided with tight-closing doors for reaching both fan and motor. The fan is mounted upon a wooden frame anchor bolted to the wall, and the motor, in turn, is supported from the fan frame.

What combination is sometimes employed for producing a draft in large buildings?

It often happens in large buildings like schools, etc., that a heated flue will ordinarily produce sufficient draft, while with mild or heavy weather, or during certain periods when the toilets are in more constant

use, it is desirable to increase the velocity of air flow. In cases of this kind the arrangement shown in Fig. 110 may be used. With this plan the ducts from the different toilets are brought into the main vent flue and an aspirating coil or heater placed just above the

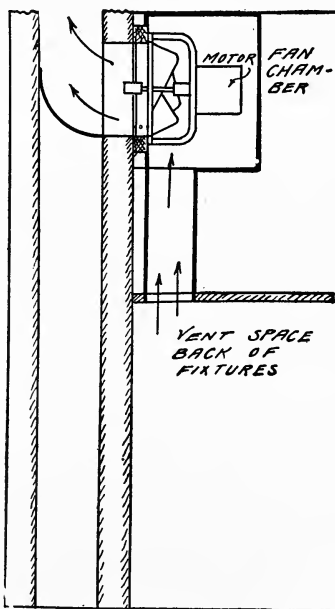

Fig. 109—Arrangement of Fan for Toilet Ventilation

connection. At some higher point, convenient of access, an exhauster of the centrifugal type is connected with the flue, as indicated in the cut. Under ordinary conditions the flue damper is opened and the air passes upward, due to the aspirating effect of the heater. When a higher velocity of flow is required, the damper is closed, as shown in Fig. 110, and the fan started.

Other Means of Producing Draft

How may sufficient draft be obtained in some cases without the use of fans or special heaters?

When the toilets are located close to the chimney, the arrangement shown in Fig. 111 may often be used to advantage. A brick flue is constructed, having an

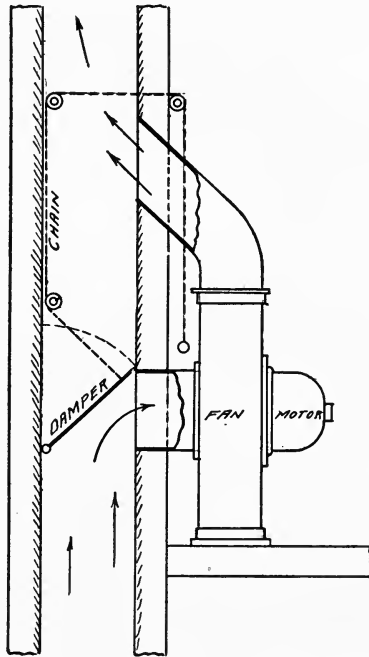

Fig. 110—Arrangement for Increasing Velocity of Air Flow

area equal to that required for the total toilet ventilation plus the area of the boiler stack. Inside this a steel chimney stack is carried to the top of the building. Referring to Fig. 111, the vent flues are marked "VV"

and the stack "C." The toilet fixtures connect through local vents with closed chambers, which in turn communicate with the heated vent flues as indicated.

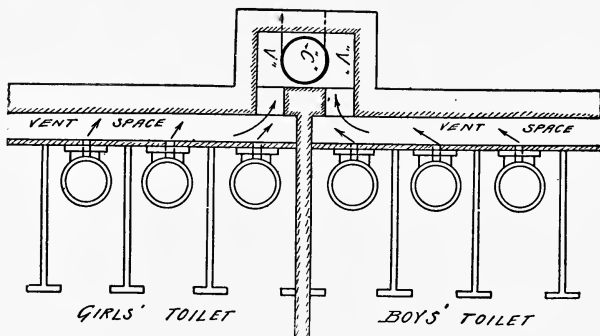

Fig. 111—Obtaining Draft Without Fans

What is the chief disadvantage of this arrangement, and how should it be provided for?

A system of this kind, when properly designed, will do the work satisfactorily as long as there is a fire under the boilers, but in early fall and late spring, when heat is not required in the building, some special means must be provided for accelerating the air flow when the flue is cold. If electric current is available, the fan arrangement shown in Fig. 110 is the most desirable, hinging the damper on the other side so that when it is open it will close the inlet to the fan.

Ventilation of Chemical Hoods

What substitute is used in place of a fan, when the building is not provided with electric current?

In this case a small boiler of the house-heating type

is provided, and an aspirating coil is placed at the base of the flue for temporary use in spring and fall.

What special ventilation is necessary in the case of high schools and colleges?

Buildings of this kind are commonly provided with chemical laboratories, in which hoods for carrying off the fumes form part of the equipment.

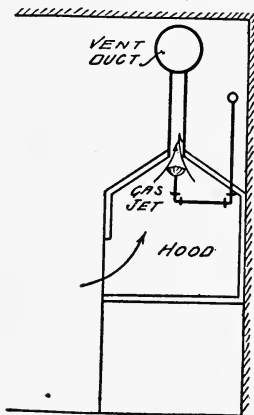

Fig. 112—Simple Form of Hood Ventilation

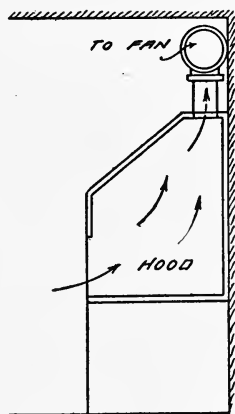

Fig. 113—Hood Ventilation for Large Laboratories

What is the simplest form of hood ventilation?

This is shown in Fig. 112. The hood consists of a tight chamber with a conical top and having a sliding sash in front. The top of the hood is connected with a vent flue by a pipe of copper, tile or galvanized iron coated with some non-corrosive substance. Heat for accelerating the air flow is provided by a gas flame just below the opening at the top of the hood, as shown. When in use, the sash is raised slightly, and a current of air passes upward through the hood, carrying with it the fumes which may be

given off by the chemical processes carried on within. The draft produced by this method is rather weak, but will answer very well in small buildings when electric current is not available for operating a fan.

What arrangement is necessary for hood ventilation in the case of large laboratories where a strong draft is necessary?

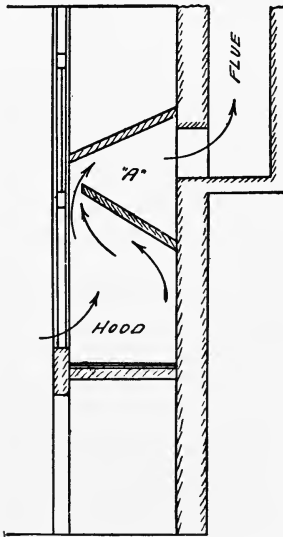

Fig. 114—Hood for Removal of Chemical Fumes

Under these conditions a fan should always be employed for this purpose. Tile connections between the hoods and fan are most desirable, and the fan should be especially constructed to withstand the corrosive action of the fumes. A common form of hood and the method of running the vent ducts is shown in Fig. 113. The fan chamber is commonly made of galvanized iron heavily coated on the inside with as-

phaltum. The motor should be placed outside away from all fumes, and connected with the fan by means of an extended shaft.

What special form of hood is best adapted to the removal of all fumes from the room?

The satisfactory removal of chemical fumes depends as much upon the form and construction of the hood as upon the strength of the draft. An especially good construction of this kind is shown in Fig. 114. The chamber "A" is common to all the hoods in the row and connects with a fan by means of the flue at the rear. The principle of this hood is the same as that already described in a previous chapter for range and oven hoods, the air passing out through a narrow slot, as shown by the arrows.

CHAPTER XI

WARM AIR FURNACE HEATING

What are the advantages of "furnace" or "warm air" heating?

The lower cost of installation as compared with steam and hot water, simplicity of operation, freedom from repairs, no danger of freezing in unoccupied rooms or when the building is closed, a supply of fresh air for ventilating purposes, ability to regulate the quantity of heat, thus preventing over-heating in mild weather, and the short time required for warming up a building in the morning.

What are the disadvantages?

The difficulty of warming all rooms evenly in windy weather, and the necessity of limiting the length of the horizontal pipes connecting the furnace with the uptakes, thus making it necessary to increase the number of furnaces in buildings of large size.

How can the first of these obstacles be overcome?

The heat distribution may be equalized to some extent by locating the furnace nearer the north, or northwest side of the building, or toward the side of the prevailing winds, thus shortening the length of the horizontal pipes leading to the colder rooms.

Is there objection to increasing the number of furnaces?

They are less convenient to care for and are less

efficient than when the coal is burned in larger and fewer furnaces.

To what types of buildings is hot air heating best adapted?

Residences of comparatively small size, four to eight room school houses, and halls and churches where the furnace may be placed more or less directly beneath the registers.

Types of Furnaces

What are the principal types of furnaces and what are the distinguishing features of each?

Furnaces are commonly classified as direct-draft and indirect-draft, according to their construction. In the first of these the gases pass from the top of the dome or combustion chamber into the smoke pipe by way of passages more or less direct. Fig. 115 shows a furnace of this general design, although in this case a special flue is provided for deflecting the gases downward and thus checking the draft when desired. Cheaper forms of this type do not usually have this feature. An indirect-draft furnace is shown in Fig. 116. In this case the gases pass downward to a radiator located near the bottom, then upward through other flues to the smoke pipe. A damper is provided to give a direct connection to the chimney for carrying off the increased amount of gas which is formed when coal is first put on. This damper is for use at such times only. In both cuts the passage of the air over the various heating surfaces is clearly indicated by arrows.

Are special furnaces constructed for different types of buildings?

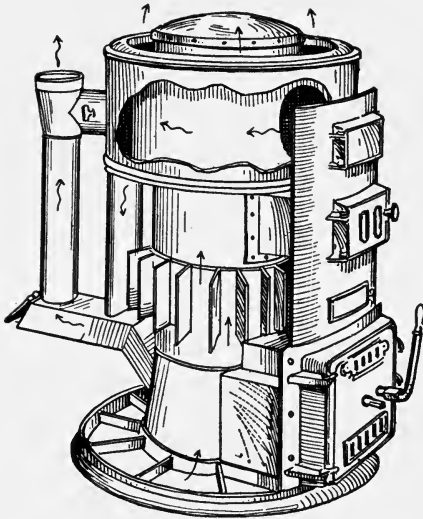

Fig. 115—Direct Draft Furnace

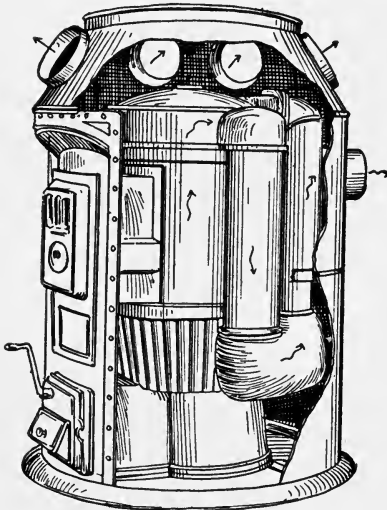

Fig. 116—Indirect Draft Furnace

They are, according to local requirements. Fig 117 shows a furnace having a large amount of heating

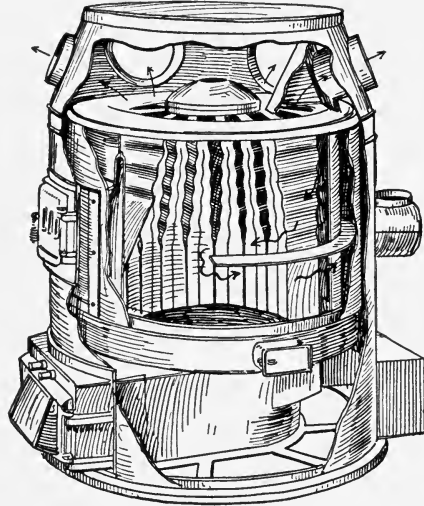

Fig. 117—Furnace with Large Amount of Heating Surface

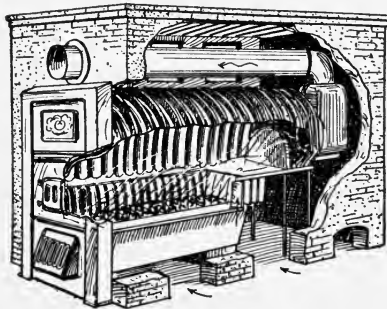

Fig. 118—Furnace Suited for School-house Work
surface in direct contact with the fire, or adjacent to it. This is made up of corrugated cast-iron flues and

gives a large heating capacity for a single furnace, thus adapting it to buildings of large size. That shown in Fig. 118 is designed especially for school-house work and similar conditions where a large volume of air heated to a moderate temperature is required. The ratio between the heating and grate surface is large in this case, thus more nearly approaching the results obtained with steam in this class of work.

Parts of a Furnace

What are some of the more important parts of a furnace which should receive attention when making a selection?

The grate, fire-pot, dome or combustion chamber, radiator and casing.

What is the general construction of each and what are the principal points to be considered?

Two common forms of grates for the ordinary type of furnace are shown in Figs. 119 and 120. The first of these is made up of two parts, an outer rim and a central portion, as shown. In shaking, the entire grate rotates back and forth about a common center, but the fire is dumped by withdrawing the central portion. The grate shown in Fig. 120 is made up of a series of triangular bars provided with teeth. These are connected by means of gears, and by turning the lever or crank, a slice of clinker and ash is cut from the entire fire with but little or no loss of unconsumed coal. Fire-pots are usually made of heavy cast iron, or of steel plates lined with fire brick. Those of cast iron are more effective as heating surface than the lined ones, and this difference must be

made up by increasing the size of the dome or radiator when the latter are used. Sometimes the heating surface of the fire-pot is increased by the use of "fins" or other methods of extension, as shown in Fig. 121

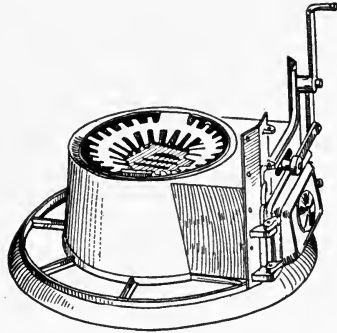

Fig. 119—Rotating Grate with Slide Center

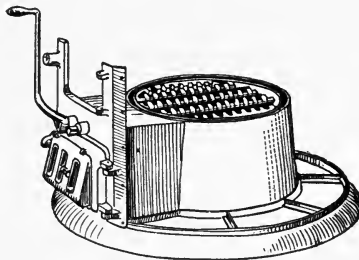

Fig. 120—Triangular Bar Grate

The dome or combustion chamber should be of sufficient size to permit the gases to become thoroughly mixed with the air as it enters through the fire or feed door, thus making combustion as complete as possible. The radiator is a chamber placed either at the top or bottom of the furnace and acts as a reservoir in which the hot gases are kept in contact with

the air passing over it. Radiators are built of cast iron, of steel plates, or of a combination of the two. Their effectiveness depends upon the form, the amount of heating surface, and the difference in temperature between the gases and the surrounding

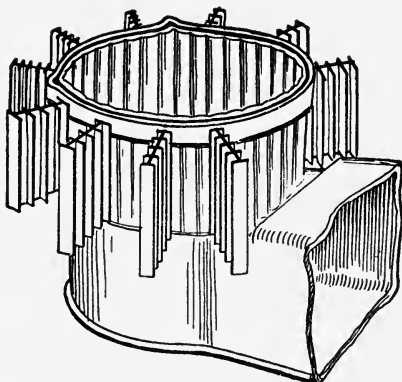

Fig. 121—Fins Attached to Firepot to Increase Radiation

air. If located near the bottom, as in Fig. 116, it comes in contact with the coolest air and is therefore more effective; but on the other hand, the gases have a tendency to condense, thus forming acids which are liable to corrode the iron. Vertical and horizontal sections through a radiator located at the top of a furnace are shown in Figs. 122 and 123 respectively. The casing of practically all portable furnaces is constructed of galvanized iron. There should be sufficient space above the furnace for a warm air chamber without interfering with the proper pitch of the pipes. The flow of air is assisted by placing an inverted conical deflector at the top of the casing.

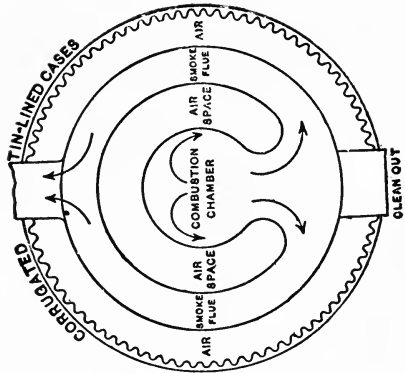

Fig. 123—Horizontal Section through Radiator

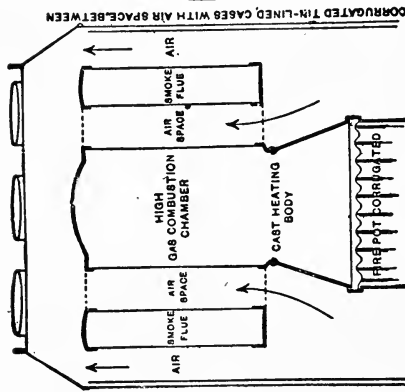

Fig. 122—Vertical Section through Radiator

What is the usual ratio between the heating surface and grate of hot air furnace?

This varies with the size and type, but commonly ranges from about 25 in the smaller sizes to 15 in the larger.

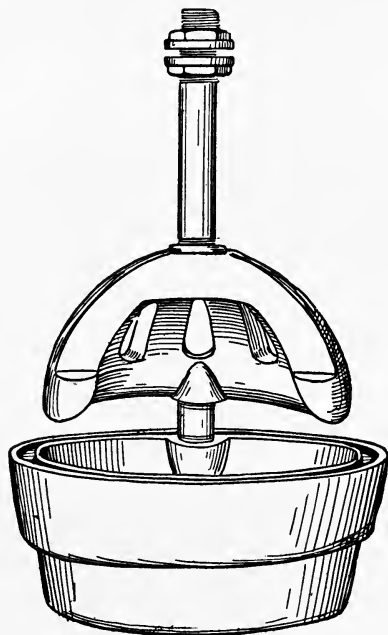

Fig. 124—One Style of Cast Iron Water Heater for Combination Heating

Combination Systems

What is a “combination system?”

This is an arrangement whereby a portion of the rooms are heated by hot air and a portion by hot water.

Is a separate heater or boiler required for heating the water?

It is not; the water is heated in chambers or coils suitably arranged inside the furnace. Fig. 124 shows a special cast-iron heater for this purpose. The lower part of this heater forms the upper part of the fire-pot, and is connected with the return from the radiators. From here it passes into the upper section, which is suspended above the fire, and from here flows into the supply main through the pipe at the top.

What are the advantages of a combination system?

With this arrangement the smaller and more distant rooms, which are difficult to reach with hot air, may be provided with hot-water radiators supplied from a special heater within the furnace.

What special precaution must be taken when this is done?

The heating surface in the furnace and the radiating surface supplied must be carefully proportioned to prevent over-heating and boiling within the system.

Furnace Efficiency

What is the efficiency of a furnace?

The efficiency of a furnace is the proportion of the total heat given off by the combustion of the coal which is utilized in warming the air supplied to the building. This depends upon the ratio of heating to grate surface, its character and arrangement, and the rate of combustion.

What efficiencies are commonly obtained in practice?

The efficiency commonly runs from 50 to 60 per cent., the higher figure fairly representing the results obtained under average conditions with furnaces of the best type and design.

What is the relation between furnace efficiency and weight of coal required for heating a building?

One pound of anthracite coal gives off approximately 12,000 heat units during the process of combustion, and if the furnace has an efficiency of 60 per cent., it means that $12,000 \times 0.6 = 7,200$ heat units are utilized in warming the building for each pound of coal burned in the furnace.

Rate of Combustion

How many pounds of coal are commonly burned per square foot of grate surface per hour in the average furnace?

This will vary a good deal with the chimney, the size of furnace and the care used in firing. Under ordinary conditions it may be taken from 3 to 4 pounds, in the case of dwelling houses, the higher figure being easily obtained in the coldest weather with reasonable care in firing. This also means that $7,200 \times 4 = 28,000$, or in round numbers 30,000 heat units per square foot of grate per hour are available for warming purposes with the best type of furnace of good size. For small furnaces, fired at longer intervals, this will drop to 20,000 or 25,000 according to conditions.

Computing Size of Furnace

How is the required size of furnace determined for warming a given house?

There are various methods employed for this pur-

pose, some using the heat or thermal unit basis, others depending upon the cubic contents of the building, while still others are made up of a combination of the two.

What is the "thermal unit" method?

In this case the total heat loss from the building per hour in the coldest weather is first computed, and the result divided by the heat units utilized per square foot of grate.

How is the heat loss from a building obtained?

This depends principally upon the difference between the inside and outside temperatures, the thickness and material of the walls, the tightness of construction, exposure to winds, and the proportion of glass area. Assuming a temperature difference of 70 degrees, the heat loss for ordinary building construction may be found by multiplying the outside wall surface by 20, the glass surface by 85, adding these and multiplying the sum by 1.5 for leakage and exposure to winds, and by 1.10 for the heat loss through roof.

What approximate method gives practically the same result and may be used for ordinary work?

By assuming the glass area to be one-sixth the total outside exposure, which is a safe assumption for dwelling houses, and using the same factors as above, the heat loss per hour from a building may be found by multiplying the total exposed wall surface (including windows) by 50. This applies to the walls only, the heat loss through the roof being included in the factor 50. The total heat loss divided by 30,000 will give the square feet of grate area required in a furnace of the best type.

Example—What size of furnace will be required to warm a building having ground dimensions 30'×40', and two stories, each 9' in height.

$$\text{Solution } \frac{(30+30+40+40) \times (9+9) \times 50}{30,000} = 4.2. \text{ There-}$$

fore 4.2 square feet of grate surface are required, which corresponds closely to one 28 inches in diameter.

How is the size of a furnace based on the cubic contents to be warmed?

Different proportions are used by different people according to their experience and the particular type of furnace. The following data is for dwelling house work where the space to be warmed is divided into a number of rooms. This will give safe results, and possibly a size larger furnace under given conditions than would be called for by the average manufacturer's catalogue of ratings, which is not at all objectionable.

Cu. ft. of space to be heated.	Diameter of fire-pot.
8,000	18"
10,000	20"
12,000	22"
14,000	24"
18,000	26"
22,000	28"
26,000	30"

Applying this to the example just given, we have $30 \times 40 \times 18 = 21,600$ cubic feet of space to be warmed, which from the above calls for a 28" fire pot, or practically the same as by the thermal unit method.

When the space is undivided, as in a church or store, where the furnace may be placed directly be-

neath the register, a somewhat smaller size may be used, according to data given below.

Cu. ft. of space to be heated.	Diameter of fire-pot.
12,000	18"
14,000	20"
17,000	22"
22,000	24"
26,000	26"
30,000	28"
35,000	30"

In case of school buildings where large volumes of air are required for ventilation, furnaces having fire pots 32" in diameter have been found to heat two standard class-rooms satisfactorily.

Smoke Pipe and Chimney Flue

What special conditions should be noted in connection with the smoke pipe and chimney flue?

The smoke pipe should be made the full size called for by the furnace outlet and should be carried to the chimney as directly as possible without the use of unnecessary bends, which tend to increase the resistance and diminish the draft. Protection against fire should be provided for, where pipes pass through wooden partitions, by the use of a soapstone or double perforated metal collar having a diameter at least 8 inches greater than that of the pipe. A space of 8 inches or more should be left between the top of the smoke pipe and unprotected beams. If these are covered with asbestos board or plaster and sheet metal, the space may be reduced to a minimum of 6 inches.

What precautions should be taken with regard to the chimney flue?

This for average conditions should not be less than 8" x 12" for dwellings of small and medium size, and 12" x 12" flues should be provided in large buildings. When based on the size of fire pot, the following may be used for chimneys of ordinary height:

Diameter of fire-pot.	Dimension of brick flue.
18"—20"	8"x 8"
22"—26"	8"x12"
28"—30"	12"x12"

The above dimensions are for hard coal; for soft coal make the dimensions 8" x 12", 12" x 12" and 12" x 16", respectively.

It is important that the interior surfaces should be smooth, and for this reason flue linings or tile are often used. Standard sizes corresponding most nearly to the above dimensions are given below.

Brick flues.	Rectangular tile (Outside dimensions.)	Round tile (Inside dimensions.)
8"x 8"	8½" x 8½"	8"
8"x12"	8½" x13"	10"
12"x12"	13" x13"	12"
12"x16"	14" x14"	16"

The furnace flue should be entirely independent, and no stove, range or ventilating register should be connected with it.

A clean-out, with tight closing door, should be provided at the bottom for the removal of ashes and soot.

Cold-Air Box and Return Flue

Upon what is the size of the cold-air box based?

Usually upon the total combined area of all the hot-air pipes connecting with the furnace.

What is the common relation between the two?

When the cold-air box is short and direct, and opens toward the north or west, it is usually given an area equal to three-fourths that of the warm-air pipes. Under less favorable conditions it is better to make it the full size and throttle it down in windy weather, if found too large at such times.

What details of construction are important?

The best material for the cold-air box is galvanized iron, but wooden ducts are sometimes used. If this is done, matched sheathing of good quality should always be employed in order to make the joints as tight as possible. All cold-air boxes should be provided with regulating dampers for varying the quantity of air admitted, and a wire netting should be placed over the outside opening to prevent the entrance of leaves, small animals and vermin.

What is a return flue, and under what conditions should it be used?

A return flue is an arrangement whereby a portion or all of the air supplied to the furnace may be taken from inside the building instead of the cold-air duct. It should only be used for warming up the building quickly in the morning and on windy days when there is considerable inward leakage of cold air around doors and windows.

Does the use of a return flue always mean reheating the same air and destroying ventilation?

It does not, for under proper conditions it is only used when fresh air is supplied in some other way. In the case of windy weather the principal reason why a furnace fails to heat properly is because outside air enters around windows and doors and causes

a pressure which tends to prevent the hot air from entering through the registers.

How are the usual conditions reversed by the use of a return duct?

By means of a return duct, the inleaking air is taken from the rooms, carried to the furnace and heated, and then discharged through the register in the usual manner. It is simply adapting the system to the reversal of conditions and taking the air in through leakage at the upper part of the house instead of through the cold-air box in the usual manner.

Fan-Furnace Heating

What weak points in furnace heating have been previously mentioned?

The difficulty of forcing hot air into certain rooms in windy weather, and the limited distance which it will flow through horizontal pipes under the slight pressures available in ordinary gravity heating.

How may these points be overcome and the system made positive in its action regardless of the strength and direction of the wind?

By the use of ventilating fans placed in the air ducts.

Is this method adapted to dwelling houses as well as schools and churches?

Fans are adapted to dwelling house work as well as to larger buildings, and are especially valuable for temporary use in warming up a house quickly in the morning and for equalizing the air flow to the different rooms in windy weather.

Does a fan need to be run constantly under these conditions?

It does not; after a circulation has been well estab-

lished the fans may be shut down or run at a very low speed.

What type of fan is required for this class of work, and under what conditions is it possible to use it?

The ordinary electric desk fan may be used for this purpose by twisting the blades slightly to give them a higher pitch, and thus cause them to move a greater volume of air. Either the pedestal or ring type may be used, according to local conditions. The only special requirement for this method of heating is that the house be wired for electricity.

Is the cost and operation of a fan expensive?

It is not. The installation complete should not average more than \$20 to \$25 under ordinary conditions. The current required for running a fan of this type is practically the same as for a 16-candle-power incandescent lamp, and will average about one cent per hour.

What sizes and speed of fans are required?

These fans are commonly made 12" and 15" in diameter, and are given three speeds. The smallest size is usually large enough for furnaces having fire pots from 18" to 22" in diameter, while the larger fan will give very good results when connected with furnaces having fire pots up to 28" in diameter. It is usually necessary to limit the speed to the medium, or second point, owing to the noise produced when run at the highest or maximum speed.

How is the fan best connected into the furnace ducts and what conditions should be taken into account?

The fan should be so placed, and the ducts so arranged, that the air may either be re-circulated through a return duct or taken in from out of doors, as de-

sired. Under ordinary conditions the air will be drawn from the return duct when warming up the building in the morning and when there is a high wind pressure outside, as in the latter case there will be ample quantity of fresh outside air supplied by leakage. Provision is also made in some cases for drawing the supply by means of the fan from outside.

A detail of a pedestal fan arranged for rotation only is shown in Fig. 125. In this case the fan is placed at the junction of the return and fresh-air ducts,

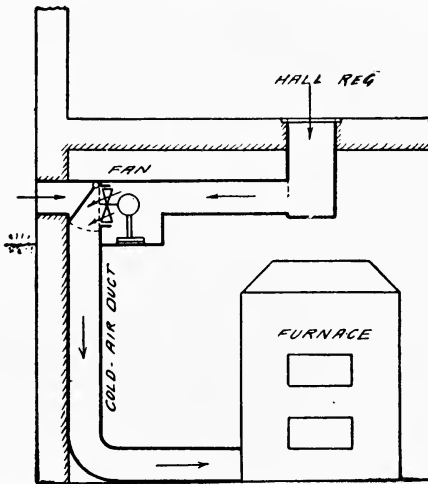

Fig. 125—Detail of Pedestal Fan for Rotation

and by means of a switch damper the air may be taken in from the outside by gravity or it may be rotated by means of the fan. In Fig. 126 a fan of the ring type is used, attached to a frame just below the return register. Here, as before, a switch damper is placed at the junction with the cold-air inlet, so that either source of supply may be used.

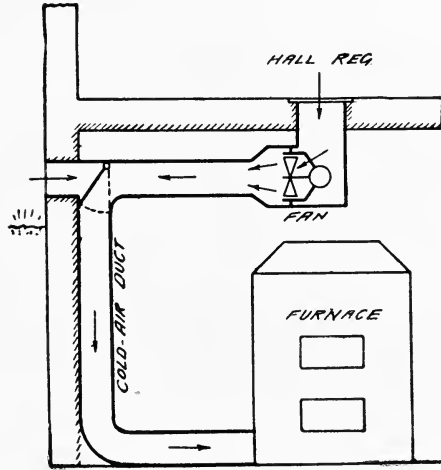

Fig. 126—Ring Type of Fan Attached to Frame

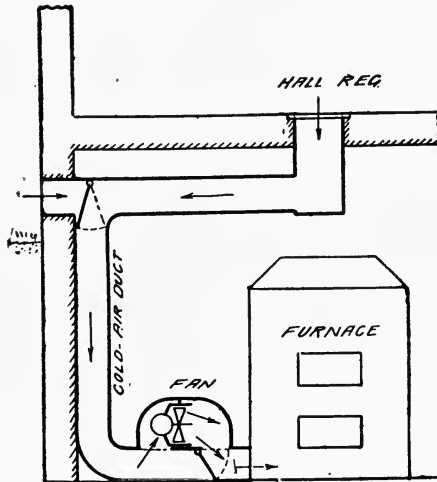

Fig. 127—Approved Form of Arrangement

The best arrangement under most conditions is shown in Fig. 127. In this case the fan is placed in a by-pass on top of the supply duct to the furnace, and by means of a drop damper may be thrown into use or cut out as may be desired. A switch damper is placed at the same point as before. By this arrangement the air supply may be drawn either from the return duct or from out of doors, or partly from each source in such proportions as may be desired. When gravity circulation proves sufficient the fan may be cut out entirely by raising the drop damper and the system operated in the usual manner.

Are special fans made for this purpose?

They are, several having been placed upon the market by the makers of ventilating equipment.

Where are the switches best placed?

Both the electric switches and the chain for operating the switch damper are best located at a convenient point on the first floor, so that the apparatus may be started and stopped without going to the basement.

How are fans adapted to furnace heating in larger buildings, such as schools, churches and halls, and what types are employed?

Fans are used in larger buildings in much the same manner as above described for a single furnace. When several furnaces are required, a system of distributing ducts leading from a single fan is made use of. For a single furnace a disk fan with direct-connected motor and of sufficient capacity to furnish the required amount of air is usually employed, while a centrifugal fan is often made use of when a system of distributing ducts is required.

What is the common arrangement for a single furnace and fan where a constant supply of fresh air is required, as in a schoolhouse or church?

A common arrangement of this kind is shown in Fig. 128. The fresh air is supplied by a disk or propeller fan placed near the furnace, as indicated, or at any other convenient place in the cold-air duct. Temperature regulation is obtained partly by varying the intensity of the fire and partly by means of a mixing damper at the base of the warm-air uptake.

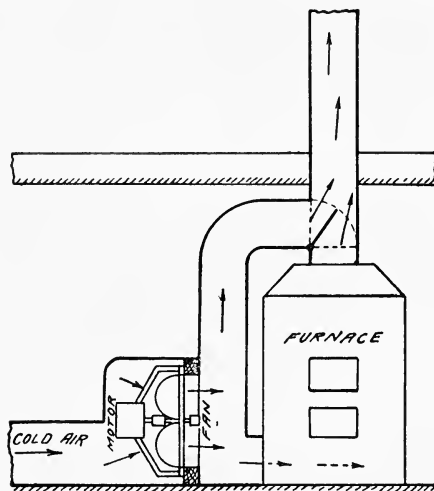

Fig. 128—Arrangement for Single Furnace and Fan

What constitutes a good arrangement for a building containing two or more furnaces?

A simple layout for two furnaces is shown in Fig. 129. In this case a centrifugal fan is used, located in a cold-air room. The fresh air is carried in underground ducts and delivered to the pits beneath the furnaces, as indicated in the cut.

What would be the arrangement for a four-furnace building?

This would be practically the same as shown in Fig. 129, except two furnaces would be placed in a battery at each end of the building.

What should be the arrangement of the ducts and dampers at the furnace for the general plan shown in Fig. 129?

This is indicated in diagram in Fig. 130. The cold-air from the fan is delivered to the pit beneath the furnace, and passes up inside the casing in the usual

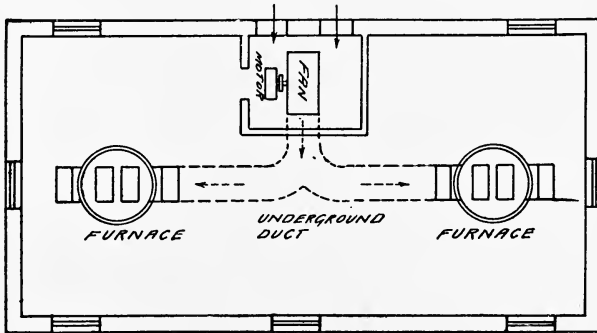

Fig. 129—General Plan

manner. The cool air for tempering purposes is carried up in outside flues to the dampers, and a more thorough mixture is produced by providing the baffles "B," "B" in the vertical flues above the dampers; otherwise, a layer of cool air would be likely to flow out through the lower part of the register, thus causing uncomfortable drafts upon those sitting near it.

Are special furnaces required for this class of work?

While the ordinary well-designed house heating furnace is often used in this way, the best results are

obtained when there is a comparatively large ratio between the heating and grate surfaces, and the passages of air flow are made sufficiently large to permit the air to pass through them at a moderate velocity. A furnace designed for this special purpose is shown in Fig. 131. The casing in this instance is of brick

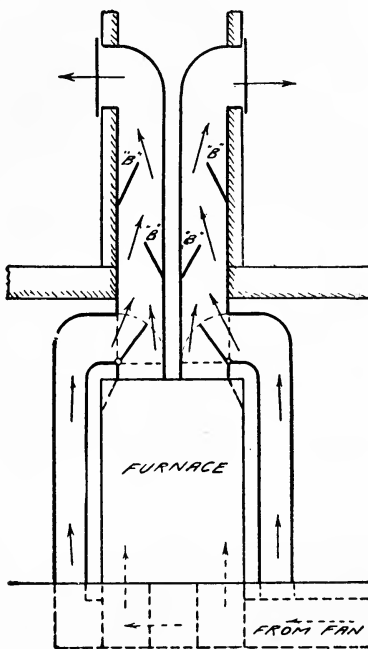

Fig. 130—Arrangement of Ducts and Dampers

and the furnace itself somewhat in the form of a locomotive boiler. By this arrangement conditions may be made to approach those of steam heating, where a comparatively large volume of air is supplied at a moderate temperature. Another form of hot-air heater, especially designed for fan work, is shown

in Fig. 132. This has a high efficiency, from 85 to 90 per cent. being claimed by the makers. The heating surface consists of a series of horizontal tubes

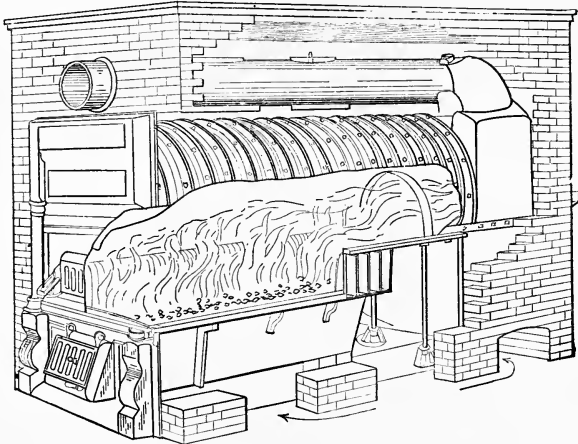

Fig. 131—Furnace and Casing

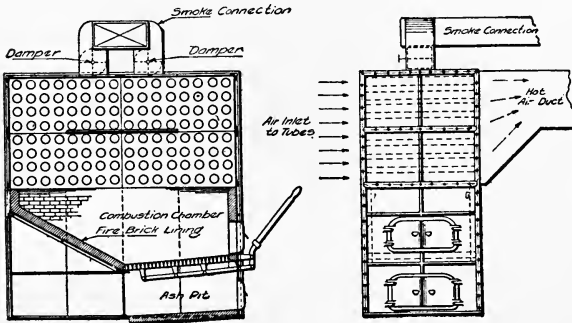

Fig. 132—Another form of Heater

placed directly above the combustion chamber and therefore in a position to absorb the greater amount of heat possible from the fire.

Size and Arrangement of Hot-Air Pipes

How are the areas of the hot-air pipes determined?

There are different ways of finding the areas of these pipes, some being based upon the quantity of heat to be supplied and some upon the cubic contents of the rooms.

What are the simple rules for each?

In case of the thermal unit method, with the hot air entering at about 120 degrees, divide the heat units required per hour by 250 for first floor rooms, and by 350 for second and third floor rooms. The result will be the area of the pipe in square feet. A simple rule based on the cubic contents is to allow 1 square inch sectional area for each 25 cubic feet of space for northerly and westerly rooms on the first floor, and 1 square inch for each 30 cubic feet for other exposures. For upper floors use the figures 30 and 35 in place of 25 and 30. The following table will be found useful in connection with the above rules:

Dia. of pipe in inches.	Area in sq. inches.	Area in sq. feet.
6	28	0.196
7	38	0.267
8	50	0.349
9	64	0.442
10	79	0.545
11	95	0.660
12	113	0.785
13	133	0.922
14	154	1.07
15	177	1.23
16	201	1.40

What is the best form for the hot-air pipes of a furnace system?

When space allows, both the vertical and horizontal pipes should be circular in section. When the thickness of the partitions will not allow of this form they may be ovoided, but the shorter dimension should not be less than 5 or 6 inches, except for the smallest pipes, and then never less than 4 inches.

How is the flow of air to the different rooms equalized?

This is done by placing adjustable dampers in each pipe near the furnace.

What precautions should be taken against fire in running the hot-air pipes?

A clear space of at least $\frac{1}{2}$ inch should be left between the pipes and studding, and the latter should be carefully tinned. Wire lath or asbestos board should always be used instead of wooden lath for covering hot-air pipes.

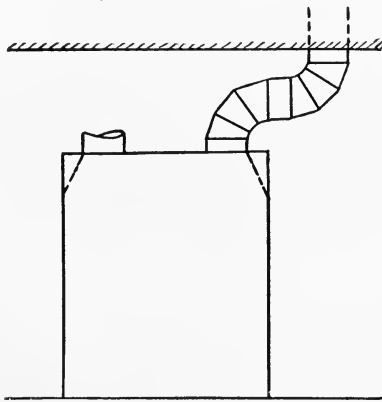

Fig. 133—Furnace Casing Connection

What two arrangements are commonly used for connecting the furnace casing with the vertical flues, and which is the better?

Two common arrangements are shown in Figs. 133 and 134. The latter gives the best results, because the turns are less abrupt and therefore produce less resistance to the flow of air.

What precautions should be noted in running the "horizontal" pipes?

They should be given as much upward pitch as the height of the basement will allow, and the length should be limited to 12 or 14 feet at the most.

What are the best methods of connecting the horizontal pipes with the vertical flues?

The best plan is to use an elbow connecting with the bottom of the flue, as shown in Fig. 135. When

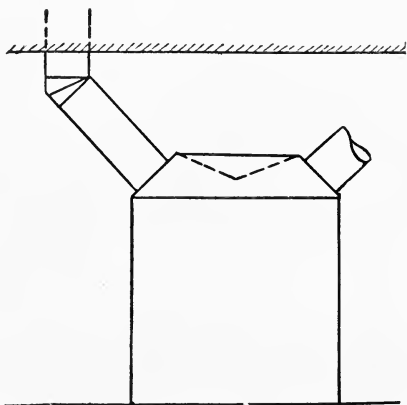

Fig. 134—Better Method of Connection

the horizontal pipe is carried straight into the side of the flue, the bottom of the latter should be enlarged and curved at the back, as in Fig. 136. The common practice of extending the vertical flue downward the same size, and connecting the horizontal pipe into the side of it at right angles, is not to be recommended.

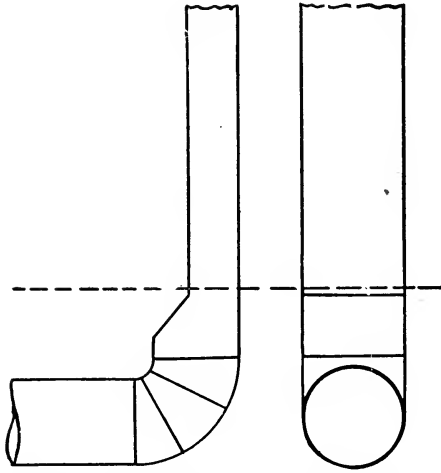

Fig 135—Elbow Connecting with Bottom of Flue

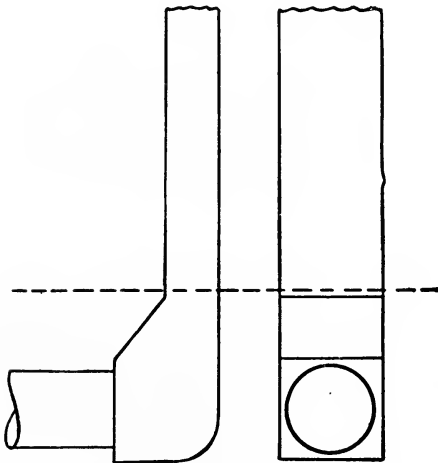

Fig. 136—Flue Curved at the Back

Size and Location of Registers

How are the sizes of the registers determined?

They should have a free area through them from 10 to 20 per cent. greater than that of the pipe with which they connect. This relation may be very nearly obtained by using registers having the short dimension equal to, and the long dimension about one-half greater than the diameter of the pipe. For example, use an 8 x 12 in. register with an 8-inch pipe, a 12 x 16 in. register with a 12-inch pipe, and so on.

What is the best location for the hot-air registers?

They may be placed either in the floor or baseboard; the latter has the advantage of greater cleanliness, avoids the cutting of rugs and carpets, and discharges the air in a horizontal direction across the floor. On the other hand, floor registers are more convenient for warming or drying the feet and are commonly used in halls and living rooms. Baseboard registers are generally used in upper rooms, as the flues are carried up in partition walls, and it is a simpler matter to connect with a register in this location than with one in the floor.

Design of Combination Systems

How are the connections for a combination system commonly made?

These are shown in Fig 137. The supply pipe is carried from the upper connection of the furnace to the top of the radiator, and continued from here to the vented expansion tank, as indicated. An overflow pipe should extend from the tank to a basement sink for indicating when the tank is full, and also for

catching any overflow due to expansion when the water is heated. The return pipe from the radiator is carried to the lower connection of the furnace, as shown, and is provided with a feed pipe for filling the system and with a drain discharging into the sink.

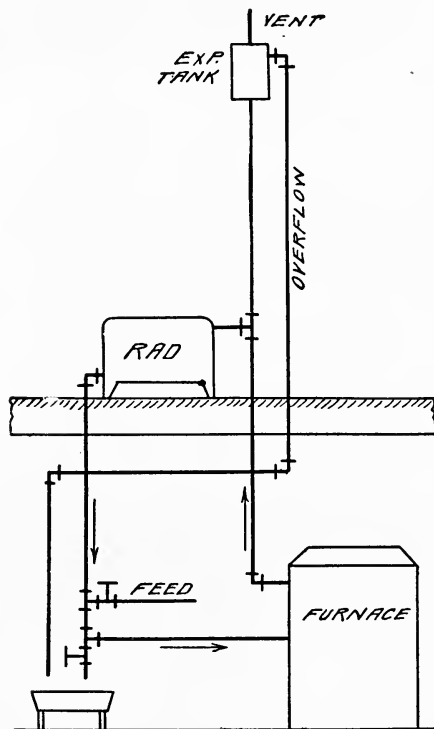

Fig. 137—Connections for Combination System

How is the size of radiator for a given room determined?

This may be found by providing 1 square foot of surface for each 2 square feet of glass, and the same amount for each 8 square feet of outside wall surface.

For exposed rooms on the north or west side of a building, multiply the results obtained by this method by 1.3.

What should be the ratio between the radiating surface in the rooms and the heating surface in the furnace?

This will depend upon the character of the heating surface in its location. Under ordinary conditions 1 square foot of heating surface in contact with the fire will supply from 40 to 50 square feet of radiation, and 1 square foot suspended over the fire will supply from 15 to 25 square feet.

What should be the size of the supply and return pipes leading to the radiator?

For the conditions found in this class of work the supply and returns are made the same size, and a 1-inch pipe will supply about 35 square feet of surface in the first floor rooms and 60 square feet on the upper floors, while a 1¼-in pipe will supply 60 and 100 square feet, respectively, under the same conditions.

What should be the size of the expansion tank?

This may be found, in gallons, by dividing the square feet of radiation by 40.

Care and Operation

What points should be especially noted in the care and operation of warm-air furnace?

In operating a furnace, the fire should be thoroughly shaken once or twice daily, depending upon the outside temperature, but not so much as to cause the live coals to fall into the ash pit. The fire pot should be kept even full at all times, but if it is desired

to check the fire in mild weather it may be done by allowing the ashes to accumulate on the grate by shaking less frequently.

If the fire has become low, a small amount of fresh fuel should be added and the drafts opened until it becomes ignited; the fire should never be shaken at such times, as it is likely to go out. The rate of combustion should be controlled largely by means of the ash pit slide, the smoke pipe damper being opened only just enough to produce the proper draft. The check damper should only be used for a short time after adding fresh coal or for checking the fire quickly in mild weather.

The ashes should be removed every day or two, according to the amount of coal burned, and the cold-air box should be kept wide open except in very windy weather, as an abundant supply of fresh air is important to the proper working of the furnace.

If the warm air fails to reach any particular room, close the dampers in the other pipes for a few minutes, until a flow has been established, after which they may again be opened.

The smaller sizes of coal, such as "stove" and "egg," give the best results under ordinary conditions.

INDEX

	Page
Air Check	46
Air, Composition and Important Elements.....	8-9
Air Cooler	134
Air, Effect of Poor.....	8
Air Leakage, Around Doors	15
Air, Necessity of	7
Air Quality	119
Air Removal	26-27-28
Air Rotation	151
Air, Source of Supply	15
Air, Standards of Purity	11-12
Air Supply for Fan System.....	52
Air Velocity	33
Air, Volume of Supply	12-13
Air Washer	126-134-137
Asbestos	194-207
Asphaltum	179
Aspirating Coil	150
Back Drafts	67
Bad Odors Removed	132
Bag Filter	123
Blast Area	107
Carbonic-acid Gas, in Air	9
Carbonic-acid Gas, Proportion Determined	10
Centrifugal Fans, Capacity of.....	105-140
Chimney Flue, Size of.....	195
Clean Out Flue	78
Coal, Sizes for Furnaces.....	213
Coke Filter	138
Cold Air Box, Size of	195
Cold Air Chambers	39
Cold Air Supply Ducts.....	36-37-39
Combination System	189-211
Cost of Ventilation	24

Index

215

	Page
Damper, By-pass	88
Damper, Cold Air	41-44
Damper, Shut-off	91
Deflectors	62-67-136
Diffuser	65-149
Dirt Pan	78
Discharge Method	28
Disk Fan	110-139
Distributing Ducts, Area of.....	63
Double Duct Fan System.....	158
Draft, Production of	174
Dust	119
Efficiency of Furnace	190
Eliminator	131
Equalizing Ducts	48
Exhauster	98
Exhaust Method	28
Expansion Tank	212
Fan Drives	113
Fan Speed	106
Fan Substitute	177
Fan Systems	27
Fans, Double	101
Fans, Quietness	102
Fans, Types of	95
Fans, Velocity of Periphery.....	107
Fans, Vibration of	104
Filters, Dry and Wet.....	16-17-121-126
Fire-proof Vents	140
Flues, Outboard	75
Flues Protected from Cold	56
Foundations	116
Fresh-air Inlets and Ducts.....	36
Furnace Fans, Cost of	198
Furnace Fans, Difficulties of	197

	Page
Furnaces, Computing Size of.....	192
Furnaces, Direct and Indirect Draft.....	182
Gas-jets, Effect on Air	14
Grille	57
Gravity Systems, Good Features of.....	26-27
Heaters Required for Fan System.....	149
Heat Loss	192
Heat, Measurement of	22
Heat, Quantity to Raise Temperature.....	23
Heat, Relation to Ventilation	21
Hoods	73
Horse-power for Fans	109
Hot-air Furnace	156
Hot-air Pipes, Form of	207
Humidity Control	132
Humidity, Definition and Measurement of.....	17-18-20-21
Hygrometer	18
Indirect Gravity Heating	58
Inverted Conical Deflector	187
Kinds of Warm Air Furnaces.....	185
Local Vents	170
Louvres	168
Mixing Chamber	42
Mixing Damper	79-82-144
Mushrooms	160
Nitrogen, in Air	9
Operation, Warm Air Furnace.....	212
Oxygen, in Air.....	8
Pipe Heater	117

Index

217

	Page
Plenum Space	153-159
Plenum System	28
Positive System	28
Pressure, Fan	107
Purification of Air.....	16
Radiating Surface, Ratio of	212
Radiators, Size of	211
Range Hood	141
Recirculating Air	132
Registers, Location of and Size.....	29-210
Return Air Duct	40
Return Flue	196
Saturation, Definition of.....	17
Screen for Furnace	196
Soapstone	194
Spray Pumps	130
Sprays	129
Stack Casing	77
Stack Heater	70-157
Supply Register	29
Supply Vent	54
Supply Flues, Area of	60
Supply Flues, Location	61
Temperature	22
Tempering Coil	127
Tempering Coil, Substitute	129
Thermal Unit	192
Thermal Unit Rules	206
Toilets, Private	174
Trunk-line System	48-50
Types of Warm Air Furnaces.....	185
Uptake Flues, Size of.....	64

	Page
Vacuum	150-168
Velocity of Air, Measurement of.....	33
Vent Flue	54-66
Vent Flue, Size of	67
Vent Outlet, Sanitary	69
Vent Register	29
Ventilation, Cost of	24
Ventilation, General Definitions	7
Weight of Coal	191
Wind Guards	74
Wind Pressure	37

SHEET METAL

PUBLISHED MONTHLY

A *Specialized Journal*, accepted and approved as the authoritative organ of its field in which it enjoys a universal circulation. It deals exclusively with the various branches of modern sheet metal work, including the business problems and the technical procedure of the trade.

SHEET METAL presents an unequaled variety and quality of reading matter for sheet metal workers, each number containing expositions of modern methods and examples of current practice in construction and erection work. Among the leading subjects considered are the following:

The various phases of Architectural Sheet Metal Work, including Cornice and Skylight Making, Metal Roofing, etc.

The Construction and Installation of Heating, Ventilating, Blower and Exhaust Systems.

Expert Demonstrations of Problems in Pattern Cutting.

The Plainest and Most Practical Articles on Warm Air Furnace Heating.

These Practical Discussions are Supplemented by the Latest Sheet Metal Trade News, Market Reports, and Reliable Current Price Lists of Materials.

SHEET METAL is Designed for Practical Purposes, in the Office, the Shop and for Home Reading or Reference.

ONE DOLLAR A YEAR

SHEET METAL PUBLICATION COMPANY
Tribune Building, New York

Progressive Furnace Heating

A Practical Manual of Designing, Estimating and
Installing Modern Systems for Heating and
Ventilating Buildings with Warm Air

By A. G. KING

Together with a Complete Treatise on the Construc-
tion and Patterns of Furnace Fittings

By WILLIAM NEUBECKER



This work constitutes a complete modern guide to warm air furnace heating, its design and installation, with working plans and methods of estimating and full information regarding up-to-date accessories and equipment. The most approved practice is brought out and made clear, without departure from the uses of plain arithmetic in the making of calculations.

CONTENTS

Chapter

- 1—The Chimney Flue.
- 2—The Furnace—Character, Size, Location and Setting.
- 3—Pipes, Fittings and Registers.
- 4—Installation of the Furnace.
- 5—Trunk Line and Fan-Blast Hot Air Heating.
- 6—Estimating Furnace Work.
- 7—Intelligent Application of Heating Rules.
- 8—Practical Methods of Construction.
- 9—What Constitutes Good Furnace Work.
- 10—Ventilation.
- 11—Ventilation by the Use of Propeller Fan.

Chapter

- 12—Humidity and the Value of Air Moistening.
- 13—Recirculation of Air in Furnace Heating.
- 14—Auxiliary Heating from Furnaces.
- 15—Temperature Regulation and Fuel Saving Devices.
- 16—Fuel: Its Chemical Components and Combustion.
- 17—Cement Construction for Furnacemen.
- 18—Construction and Patterns of Furnace Fittings.
- 19—Rules, Tables and Information.
- 20—Recipes and Miscellaneous Data.
Index to Furnace Heating.
Index to Furnace Fittings.

Size 6 x 9 inches, 280 pages, 189 illustrations in line (from pen and ink drawings) and half tone (from photographs).
Elegantly Bound in Cloth. Price, \$2.50.

SHEET METAL PUBLICATION COMPANY
Tribune Building, New York

Hand Book of Sheet Metal Duct Construction

A PRACTICAL TREATISE ON THE CONSTRUCTION AND
ERECTION OF HEATING AND VENTILATING DUCTS

By WILLIAM NEUBECKER

An exceptional publication, full in description and illustration of all the individual operations comprised in the handling of materials and the erecting and installing of ducts for heating and ventilating systems. The 217 illustrations, mostly from pen and ink drawings, make plain almost every method described in this clear and carefully-prepared manual.

Chapter

- 1—Tools, Machinery and Materials.
- 2—Sheet Metal Work in Heating and Ventilating Systems.
- 3—Cutting Material, Bending, Forming, Seaming, Grooving and Bracing.
- 4—Constructing the Various Slip Joints.
- 5—Hanging Ceiling Ducts—Supporting and Fastening Ducts.
- 6—Methods of Laying Out and Constructing the Elbows.
- 7—Constructing Register Boxes, Cleanouts and Ceiling Ventilators.
- 8—Registers for Heating and Ventilating Ducts.
- 9—Fastening and Adjusting Registers.

Chapter

- 10—Connecting Heating and Ventilating Ducts.
- 11—Ducts for Direct-Indirect Heating.
- 12—Construction of Casings for Indirect Heating.
- 13—Assembling Casings and Constructing Air Filters.
- 14—The Construction of Mixing Dampers.
- 15—Making Dampers for Large Ducts.
- 16—Calculating Areas of Pipes and Ducts.
- 17—Various Types of Ventilators.
- 18—Construction of a Large Ventilator.

Elegantly Printed and Substantially Bound in Cloth
Price, \$1.50

SHEET METAL PUBLICATION COMPANY
Tribune Building, New York

Practical Exhaust and Blow Piping

A Treatise of the Planning and Installation of Fan Piping in all its Branches

BY WILLIAM H. HAYES

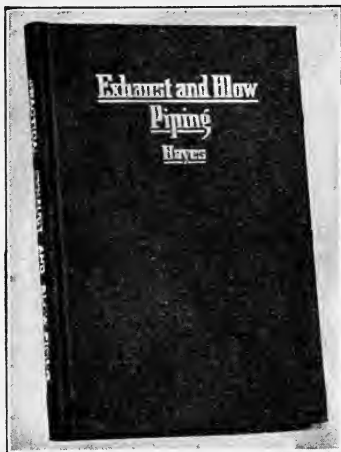

At the present time no department of sheet metal work offers a more profitable field of opportunity for sheet metal workers than exhaust and blow pipe work. Every operator should be qualified with a practical knowledge of the correct design and installation of fan piping systems.

This book was written by an expert of long and varied experience in the field, as a foreman and superintendent and the treatment is based on practical daily work. It is reliable, easily understood and applied, covering the essentials of efficient construction very clearly.

Contains Sixteen Sections

Each devoted to a special phase of the work, including full and specific information on construction, installation and costs.

General Rules.
Connecting Dust Separator and Feeder.
Piping for Automatic Firing System of Boilers.
Constructing the Feeder Nozzle and Switch.
Piping System for a Planing Mill.
Pipe Connections for a Flooring Machine.
Designs for Hoods and Sweepers.
Hoods for Special Machines.
Proper Construction of the Separator.

Efficiency of the Exhaust Fan.
Use of the Two-Way Mixing Valve and the Automatic Damper.
Piping a Forge Shop, including the Blast and Suction Systems.
"Don'ts" and "Don't Forgets" for Blow Pipe Men.
Correspondence Relating to Special Problems.
Hints on Installing an Exhaust System.
Hints on Estimating the Cost of an Exhaust System.

160 pages, 51 illustrations. Printed on heavy paper, durably bound in cloth.....Price, \$2.00

SHEET METAL PUBLICATION COMPANY
Tribune Building, New York

ELBOW PATTERNS FOR ALL FORMS OF PIPE

A treatise upon the elbow pattern explaining the most simple and accurate methods for obtaining the patterns for elbows in all forms of pipe made from sheet metal

With Useful Mathematical Rules and Tables

By F. S. KIDDER

One of the first and most important considerations for the sheet metal worker is to be possessed of a method for securing the patterns for elbows in the least possible time consistent with accuracy. To meet the popular demand and provide a means by which unnecessary expenditure of time and labor may be avoided, the author presents here a method for laying out elbows with accuracy, despatch, and

Without Resort to Geometrical Display.

With the service of this handbook, the mechanic will be enabled to quickly produce the patterns for elbows in round pipe of any size, angle or number of pieces, by the simple employment of a pair of compasses and a straightedge.

Size, $4\frac{1}{2} \times 6\frac{1}{2}$ inches (for the pocket), 73 pages, 35 figures, cloth bound.Price \$1.00

SHEET METAL PUBLICATION COMPANY

Tribune Building, New York

SHEET METAL WORK

A Practical Guide to Sheet Metal Work, Cornice Work, Skylight Work, Metal Roofing, Pattern Drafting, Etc.

By **William Neubecker**

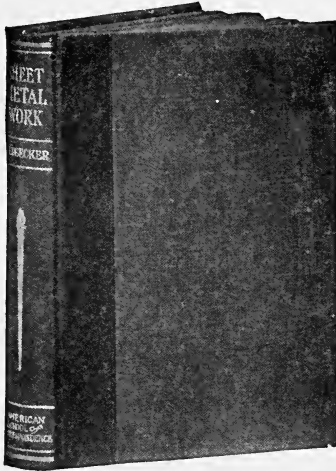

This volume contains under one cover, in Mr. Neubecker's practical and reliable style of writing, a general treatise on the approved present day methods of laying out and constructing the standard types of cornices, skylights and metal roofing, with attention to the commonly occurring problems of pattern cutting. The work constitutes a first-class general reference book for the foreman and operator.

	Page
Tools and Methods of Obtaining Patterns.....	3
Workshop Problems	26
Skylights	133
Roofing	158
Cornice Work	193
Index	263

Size, 6½ x 9¾ inches, 267 Pages, 358 Cuts, Cloth, Leather Back\$3.00

SHEET METAL PUBLICATION COMPANY
Tribune Building, New York

**THIS BOOK IS DUE ON THE LAST DATE
STAMPED BELOW**

**AN INITIAL FINE OF 25 CENTS
WILL BE ASSESSED FOR FAILURE TO RETURN
THIS BOOK ON THE DATE DUE. THE PENALTY
WILL INCREASE TO 50 CENTS ON THE FOURTH
DAY AND TO \$1.00 ON THE SEVENTH DAY
OVERDUE.**

NOV 9 1932

NOV 23 1932

NOV 7 1939

iku a
200 m

15 38770

TH7653
H8 365554

Hubbard

UNIVERSITY OF CALIFORNIA LIBRARY

