



LIBRARY  
OF THE  
UNIVERSITY OF CALIFORNIA.

*Class:*

---

## **The D. Van Nostrand Company**

intend this book to be sold to the Public at the advertised price, and supply it to the Trade on terms which will not allow of reduction.

---





WATER SOFTENING AND  
TREATMENT



# WATER SOFTENING AND TREATMENT

CONDENSING PLANT, FEED PUMPS  
AND HEATERS FOR STEAM USERS  
AND MANUFACTURERS

By

WILLIAM H. BOOTH

STEAM ENGINEER, ARTESIAN ENGINEER AND HYDROGEOLOGIST; MEMBER OF THE AMERICAN SOCIETY OF CIVIL ENGINEERS; FORMERLY HON. SEC. ENGINEERING ASSOCIATION OF NEW SOUTH WALES; OF THE NEW SOUTH WALES GOVERNMENT RAILWAY DEPARTMENT; LATE OF THE MANCHESTER STEAM USERS ASSOCIATION; LATE OF THE BRITISH ELECTRIC TRACTION COMPANY; AUTHOR OF "LIQUID FUEL AND ITS COMBUSTION," "SMOKE PREVENTION AND FUEL ECONOMY," "STEAM PIPES THEIR DESIGN AND CONSTRUCTION"



NEW YORK  
D. VAN NOSTRAND COMPANY

23 MURRAY AND 27 WARREN STS.

1906

TJ375  
B1

**GENERAL**

BUTLER & TANNER,  
THE SELWOOD PRINTING WORKS,  
FROME, AND LONDON.

## PREFACE

THE treatment of water for steam-boiler and manufacturing purposes is a question of prime importance to the steam user, who understands by treatment something that will reduce the amount of hard scale deposited in his boiler or fabrics. Incidentally, such reduction benefits his pocket by reason of the better efficiency of the boiler-heating surface; less obviously but as certainly there accrues to him a saving, because his boilers are less strained; labour is economized upon cleaning and the number of boilers at work and spare may be less for a given duty. No apology, therefore, need be put forward in attempting to lay before steam users some of the chief facts connected with the softening of water. Equally important is the subject to certain manufacturers, notably dyers, one of whom informed the author that foreign competition in dyeing had no terrors for him. He could obtain for his dyed wools in delicate shades sixpence per pound more than other dyers, for he employed a water-softening process, whereas his neighbours were content to use untreated water.

There are limits to the powers of the water-softening chemist, and it is well these limits should be recognized in order to prevent disappointment; but there are few cases which cannot be taken in hand and some improvement secured. No attempt is made to enter too deeply into finer points of chemistry. Water softening and general treatment for the steam user must of necessity be kept within the bounds of the more simple reactions and the commercial reagents.

## PREFACE

In laundries chemicals are added in the wash-tub for the purpose of softening water and saving soap. London water, say Messrs. Mather & Platt, will destroy 20 lb. of soap per 1,000 gallons, at a cost of 3s. 4d., whereas the water could be properly softened before use for 1d. per 1,000 gallons.

By using softening chemicals in the wash-tub the soap is saved, but the lime salts are deposited in the texture of the things washed, and these acquire a yellow tinge. As well as in steam boilers, hard water is harmful and costly in laundries, tanneries, dye works and paper mills, etc., for iron, which exists in many waters, is removed in the process of softening.

In dye works the most delicate colours cannot be obtained except with soft water, and in the tanyard the presence of lime carbonate in the hides destroys tannin by converting it into lime tannate, and this is not only a loss of tannin but detracts from the quality of the leather, which is hardened and rendered harsh in feeling through the choking of its substance with mineral matter.

In preparing this volume the Author has drawn on many sources to supplement his own experience, and is indebted to various firms for kindly supplying information of their particular apparatus, which have been selected, as explained in Chapter VIII., purely as types of construction and not because such apparatus is in his opinion better or worse than others named or unnamed.

The complaints as to the destruction of fabrics in laundries by the use of chemicals arise probably as the result of using chemicals in dry form thrown directly into the washing vats.

The same chemicals, properly employed in correct quantity would do no harm, but rather good. Where softeners are used in the washing vessels themselves, even in correct quantity, the goods are exposed to the lime salts, which are



## PREFACE

thrown out of solution. It is thus in every way best to soften water as a preliminary operation and to remove the separated lime salts by deposit and filtration.

The second part of the book deals with Condensing Plant, Feed Pumps and Heaters, and Water Coolers, and appears naturally to ally itself with the subject of water softening. The examples illustrative of these sections are also selected for the same reasons as those in the first portion of the book.

The Author has endeavoured to make clear the important bearing which the laws of mixed vapours have upon the subject of condensing, and hopes that thereby the folly of overrunning of air pumps may be more clearly perceived. Not only upon condensers, but also upon air-pump design, these laws have their bearing. Rankine very clearly stated the law, and was more than usually particular in illustrating it by plain figures. Yet the law has been little grasped. Indeed, the Author has been induced himself to emphasize the point by Mr. George Higgins, M.Inst.C.E., of Melbourne, who pointed out where he, the Author, had himself neglected to give sufficient consideration to the law.

The provision of condensing plant has often been very fortuitous in the past, especially in electrical stations, which have been often patched up in a very haphazard manner.

Perhaps no detail has been worse neglected than the feed pump. It is to be hoped that the future will see a full return to older practice, which was based on slow, easily-worked substantial pumps, which did not strive to make their presence known by clouds of steam and a perennial water puddle.

If the steam engine is to continue to hold its own against newer heat motors there must be better and more scientific practice, based on a recognition of those factors on which permanence and durability depend. There has been a great departure along toy lines, and much attempt to hold that

## PREFACE

things could be done that were opposed to known laws and practical experience. The result as regards electrical experience has been millions of tons of coal wasted, and in nothing perhaps worse than in ill-considered condensers and feed-plant apparatus.

The Author's thanks are due to various firms for information of their respective apparatus.

In order to render the subject more complete, sections on Feed-heating and Water-cooling have been added to deal with these essentials, which require quite as much care, and judgment in the selection of the proper apparatus for each case as do the other matters dealt with.

As far as possible the basis of design and calculation has been made the British Thermal Unit, for by its use the elements of design all fall naturally together, and the haphazard system of basing design on a horse-power basis is altogether too foolish to be seriously entertained.

WM. H. BOOTH.

25, QUEEN ANNE'S GATE,  
WESTMINSTER.



# CONTENTS

## SECTION I

### THE TREATMENT OF WATER BY SOFTENING, OIL SEPARATION AND FILTRATION

	PAGE
CHAPTER I	
NATURAL WATERS—SCALE—CLEANING BOILERS—BENEFITS OF PURE WATER—GENERAL LINES OF PURIFICATION—COOLING BOILERS—SOAP WASTE—COSTS. . . . .	3
CHAPTER II	
WATER : ITS SOURCES AND IMPURITIES—NATURAL HARDENING OF WATER—GEOLOGY—NATURALLY SOFT WATER—RIVER WATER—PUBLIC WATER SUPPLIES—BORINGS—CHOICE OF SITES FOR WELLS . . . . .	7
CHAPTER III	
THE SALTS CONTAINED IN WATER—LIME AND MAGNESIA CARBONATES, SULPHATES, ETC.—VARIOUS OTHER SALTS—CLARK'S PROCESS . . . . .	13
CHAPTER IV	
THE REACTIONS OF SALTS IN SOLUTION—CHEMICAL FORMULÆ—FLOURY DEPOSIT—EFFECTS OF HEAT—GREASE—MAGNESIA EFFECTS—MILK OF LIME—LIME WATER—SODA, SODA ASH, BUXTON OR FAT LIME—BARIUM ALUMINATE . . . . .	19
CHAPTER V	
THE LESS USUAL REAGENTS—SILICATE OF SODA—OXALATE OF SODA—ALUM—ALUMINO FERRIC—HEAT—BARIUM CARBONATE, BARIUM OXIDE, ETC. . . . .	27
CHAPTER VI	
SCALE AND ITS EFFECTS—STROMEYER'S TABLE OF HEAT DISTRIBUTION IN BOILERS—GREASE—ORGANIC MATTER—EFFECT OF SCALE—PLATES OF BOILER UNDERNEATH SCALE—COLLECTION OF SCALE . . . . .	32
CHAPTER VII	
WATER ANALYSIS—STANDARD SOAP SOLUTION—STANDARD HARD WATER—FRENCH SOAP SOLUTION—APPARATUS FOR ANALYSIS—SOLUBILITY OF GASES AND SALTS IN WATER—BOILING-POINTS OF SALT SOLUTIONS . . . . .	36
CHAPTER VIII	
APPARATUS IN COMMERCIAL USE—SETTLING TANKS—CONTINUOUS PROCESS—APPLICATION OF REAGENTS—PROPORTIONING REAGENTS—COST OF SOFTENING . . . . .	44

# CONTENTS

CHAPTER IX	PAGE
EXAMPLES OF APPARATUS—THE ARCHBUTT-DEELEY—CRITON, DOULTON, GUTTMANN, BAKER, REISERT, BRUNN-LOWENER, DESRUMEAUX, STANHOPE, WOLLASTON, CARROD, PATERSON—COST OF SOFTENING—SIZE OF APPARATUS—WORKING .	48
CHAPTER X	
DETARTARIZERS—DELHOTEL, GRANDDEMANGE, CHEVALET-BOBY—WEIR FEED HEATER—PATERSON FEED HEATER	83
CHAPTER XI	
FILTERS—FILTERING MEDIA—SAND FILTRATION—SETTLING POND—RETAINING WALLS—TANK CONSTRUCTION—CAST-IRON TANKS—QUALITY OF SAND—RAPID FILTERS—THE REISERT FILTER . . . . .	88
CHAPTER XII	
BOILER COMPOUNDS—FRENCH PRACTICE—DISINCRUSTANTS—VARNISHES—CLEANING A BOILER—THE USE OF ACIDS .	96
CHAPTER XIII	
CORROSION—PRICES OF CHEMICALS—EFFECT OF ACID WATER—GROOVING—GALVANIC ACTION—DANGEROUS FEED SUPPLIES—CORROSIVE WATERS . . . . .	102
CHAPTER XIV	
INCRUSTATION OF PIPES—ACTION OF SURFACE WATERS—FERRUGINOUS WATER—ANGUS SMITH'S COMPOUND—SOLVENT ACTION ON LEAD . . . . .	107
CHAPTER XV	
OIL SEPARATION—GREASE EFFECTS—OIL SEPARATORS—HOOPER'S SEPARATOR—CHEMICAL OIL TREATMENT—COAGULATION OF OIL—PATERSON'S GREASE SEPARATOR .	109
CHAPTER XVI	
MECHANICAL BOILER CLEANERS—THE HOTCHKISS APPARATUS—ACTION OF MECHANICAL CLEANERS . . . . .	119
CHAPTER XVII	
PURE WATER—STANDARD OF PURITY—EFFECT OF COPPER SULPHATE—DRY STEAM AND BREWING . . . . .	121
APPENDIX I. REPORT OF DR. ANGUS SMITH TO THE MANCHESTER STEAM USERS' ASSOCIATION ON SOFTENING WATER . . . . .	123
,, II. TABLE IX.—THE SOLUBILITY OF GASES IN WATER AND ALCOHOL . . . . .	140
,, III. INFLUENCE OF SALTS ON BOILING-POINT OF WATER—TABLE X.: THE SOLUBILITY OF SALTS AND BOILING-POINTS . . . . .	142
,, IV. WATER AND ITS PROPERTIES—TABLE XII.: THE SOLUBILITY OF SALTS—SOLUBILITY OF LIME AND ITS SALTS	144

# CONTENTS

## SECTION II

### AIR PUMPS, CONDENSERS, AND CIRCULATING PUMPS

#### CHAPTER XVIII

PAGE

HEAT—SPECIFIC HEAT—LATENT HEAT—UNITS OF HEAT—UNIT OF WORK—THE THERMAL UNIT AS A BASIS FOR DESIGN—THE BAROMETER . . . . .	149
--	-----

#### CHAPTER XIX

CONDENSING APPARATUS—MEAN PRESSURES—VALUE OF VACUUM—TABLE XIII. : PROPERTIES OF LOW PRESSURE STEAM—LAW OF MIXED VAPOURS—AIR-PUMP ACTION—WATER REQUIRED FOR CONDENSING—RATIO TO FEED WATER—CAPACITY OF CONDENSERS—VARIETIES OF CONDENSERS—THE JET CONDENSER—THE SURFACE CONDENSER—TURBULENT FLOW IN TUBES—EJECTOR CONDENSER—ATMOSPHERIC CONDENSER—CALCULATIONS—GENERAL DESIGN—WORKING OF AIR PUMPS—LOCATION OF CONDENSING PLANT—CIRCULATING WATER—SILTING OF PIPES—AIR-PUMP DRIVING—EXHAUST PIPES—COOLING SURFACE—BAROMETRIC CONDENSER—JET CONDENSER—COOLING SURFACE—INCRUSTATION—ECONOMY OF CONDENSING—SOLUBILITY OF GASES IN WATER . . . . .	154
---	-----

#### CHAPTER XX

EXAMPLES OF CONDENSERS—WORTHINGTON'S BAROMETRIC HEAD—THE WHEELER CONDENSER—MORTON'S EJECTOR CONDENSER, BY LEDWARD—SURFACE CONDENSER—THE VERTICAL CONDENSER—EVAPORATIVE CONDENSER—COUNTER-CURRENT CONDENSERS: JET, SURFACE, BALCKE'S—BRACKETT'S—ATMOSPHERIC VALVES . . . . .	173
---	-----

#### CHAPTER XXI

AIR PUMPS: PLAIN, EDWARD'S—WORKING OF PUMPS—BAROMETRIC EFFECT—THE AIR-PUMP BUCKET—GENERAL FORMS . . . . .	194
---	-----

#### CHAPTER XXII

TYPES OF AIR PUMPS: "THE EDWARDS," ELECTRICALLY-DRIVEN PUMPS, COMBINED AIR AND CIRCULATING PUMP, VERTICAL AIR PUMP, EJECTORS, DISPLACEMENT PUMPS, THE HORIZONTAL AIR PUMP, TAIL-ROD PUMPS, STEAM-DRIVEN PUMPS, COMPOUND AIR PUMPS, JET AUGMENTOR, ROTATIVE PUMP, LOCATION OF CONDENSING PLANT . . . . .	201
---	-----

#### CHAPTER XXIII

CIRCULATING PUMPS—DISPLACEMENT TYPE—CENTRIFUGAL PUMP—COEFFICIENT OF CONTRACTION OF FLOW . . . . .	218
---	-----

# CONTENTS

## SECTION III

### FEED HEATING—STAGE HEATING

#### CHAPTER XXIV

PAGE

FEED HEATING—ECONOMIZERS—ECONOMY TABLES—PURE WATER ECONOMIZER—FULLY HEATED FEED WATER—STAGE HEATING—BOILER, ETC., FOR STAGE HEATING—THE NORMAND EFFECT—WEIR FEED HEATER—SURFACE FEED HEATERS—TRAY FEED HEATERS . . . . .	223
--	-----

#### CHAPTER XXV

PRACTICAL APPLICATION OF STAGE HEATING—THE “CRUSE” APPARATUS—THE COMBINED FEED HEATER, BOILER AND SUPERHEATER—STEAM MANUFACTURING . . . . .	244
---	-----

## SECTION IV

### WATER COOLING

#### CHAPTER XXVI

WATER COOLING—HYGROMETRIC PROPERTY OF AIR—CALCULATION OF AIR FOR COOLING—COUNTER CURRENTS—THE POND—EVAPORATION—ATMOSPHERIC EVAPORATOR—TOWER COOLERS—FAN COOLERS—SPRAY NOZZLES . . . . .	255
---	-----

## SECTION V

### FEED PUMPS—INJECTORS

#### CHAPTER XXVII

FEED PUMPS—EFFICIENCY—HEAD AND PRESSURE OF WATER—BAROMETRIC PRESSURES—WEIR PUMP—DIRECT-ACTING STEAM PUMPS—DUPLEX FEED PUMP—FLYWHEEL PUMPS—“FROMENTIN” FEEDER—THE INJECTOR—THE EXHAUST INJECTOR—VELOCITY OF FLOW OF STEAM—CAPACITY AND POWERS . . . . .	271
--	-----

APPENDIX V. SOLUBILITY OF AIR IN WATER—TENSION OF WATER VAPOUR—EQUIVALENCE OF WATER AND MERCURY PRESSURES—STEAM TEMPERATURE AND PRESSURES—FACTORS OF EVAPORATION—ECONOMY OF FEED HEATING—SATURATED STEAM TABLE—USEFUL UNITS AND DEFINITIONS—ECONOMIZERS . . . . .	289
---	-----

„ VI. ELECTRICAL OIL SEPARATION . . . . .	302
---	-----

## LIST OF TABLES

		PAGE
I	Heat Distribution in Boilers . . . . .	32
II	Loss of Heating Power due to Scale . . . . .	34
III	Solubility of Gases and Salts . . . . .	41
IV	Boiling-points of Salt Solutions . . . . .	43
V	Cost of Softening various Waters . . . . .	53
VI	Tank Sizes for various outputs. . . . .	54
VII	Dimensions of Doulton Apparatus . . . . .	59
VIII	„ „ Oil Separators . . . . .	113
IX	Solubility of Gases in Water and Alcohol . . . . .	140
X	„ „ Salts and Temperatures of Evapor- ation . . . . .	142
XI	Weight of Water per cubic foot . . . . .	144
XII	Solubility of Salts . . . . .	145
XIII	Properties of Low-pressure Steam . . . . .	155
XIV	Economy of Condensing . . . . .	171
XV	Solubility of Gases in Water . . . . .	172
XVI	Centrifugal Pump sizes . . . . .	205
XVII	Capacity of Ejectors . . . . .	205
XVIII	Saving due to Feed-heating . . . . .	230
XIX	„ „ „ „ . . . . .	231
XX	Economizer Performance. . . . .	232
XXI	„ Chamber Spaces . . . . .	233
XXII	Specific Heat of Water . . . . .	241
XXIII	Expansion of Water . . . . .	242
XXIV	Hygrometric Property of Air . . . . .	256
XXV	Output of Spray Nozzles . . . . .	268
XXVI	Head and Pressure of Water . . . . .	273
XXVII	„ „ „ „ „ . . . . .	274
XXVIII	Areas of Circles . . . . .	275
XXIX	Pump Suction at various Altitudes. . . . .	276



## LIST OF TABLES

		PAGE
XXX	Capacity of Weir Pumps . . . . .	280
XXXI	Capacity of Double Ram Pumps . . . . .	283
XXXII	Capacity of Exhaust Injectors . . . . .	288
XXXIII	Height of Lift for Self-acting Injectors . . . . .	288
XXXIV	Solubility of Air in Water . . . . .	289
XXXV	Tension of Water Vapour in Millimetres of Mercury . . . . .	289
XXXVI	Volume, Specific Gravity, and Tension of Water Vapour . . . . .	290
XXXVII	Relative Equivalence of Water and Mercury Columns . . . . .	291
XXXVIII	Temperature and Pressure of Steam for each $\frac{1}{2}$ -inch of Vacuum . . . . .	292
XXXIX	Factors of Evaporation . . . . .	293
XL	Percentage of Saving due to Heated Feed . . . . .	294
XLI	Temperature Pressure Table of Saturated Steam . . . . .	295
XLII	Comparison of Regnault's Experiments with Rankine's Equation . . . . .	299

# LIST OF ILLUSTRATIONS

FIG.		PAGE
1	The Archbutt-Deeley Apparatus (Mather & Platt)	49
2	The Archbutt-Deeley Apparatus (Mather & Platt)	50
3	The Archbutt-Deeley Apparatus (Mather & Platt)	51
4	The Criton Apparatus (Pulsometer Co.)	56
5	The Doulton Apparatus	58
6	The Doulton Apparatus	58
7	The Guttman Apparatus (B. & W. Co.)	61
8	The Baker Apparatus	64
9	The Reisert Apparatus (Royle)	66
10	The Brunn-Lowener (Lassen & Hjort)	69
11	The Desrumeaux	71
12	The Desrumeaux	72
13	The Stanhope	74
14	The Wollaston	76
14a	The Wollaston	77
15	The Carrod	78
16	The Paterson	80
16a	The Paterson (details)	81
17	The Chevalet-Boby Detartarizer	84
18	The Chevalet-Boby Detartarizer (details)	85
19	The Paterson Feed-Water Heater and Purifier	86
20	The Reservoir Wall Diagram	92
21	The Reisert Filter	94
22	Oil Separator (Holden & Brooke)	110
23	The Baker Grease Separator	111
23a		112
23b		
24	Illustrations of Coagulation	
24a		114
25		
26		
27	The Paterson Grease Separator (section)	115
28	The Paterson Grease Separator (elevation)	116
29	The Paterson Grease Separator (plan)	117
30	The Hotchkiss Boiler Cleaner	119
31	Primitive Ideal Barometric Condenser	169
32	Jet Condenser	169
33	Surface Barometric Condenser	170
34	Horizontal Surface Condenser	170
35	Worthington Condenser Head	173
36	Wheeler Condenser	174
37	Morton's Ejector Condenser (Ledward)	175
38	Cross-Section of Surface Condenser (Storey)	176
39	Vertical Condensers: Yorkshire Power Station	179
40	Cross-Section of Horizontal Condenser	180
41	Vertical Single Flow Condenser	181
41a	Vertical Double Flow Condenser	182
41b	Vertical Single-Flow Condenser for Muddy Water	183
42	Evaporative Condenser	184
42a	Evaporative Condenser	185

## LIST OF ILLUSTRATIONS

FIG.		PAGE
43	Baleke's Jet Condenser . . . . .	187
44	Brackett's Concentric Condenser . . . . .	188
45	Atmospheric Valve (Templer & Ranoe) . . . . .	190
46	Atmospheric Valve (T. Walker) . . . . .	191
47	Atmospheric Valve (Spencer) . . . . .	192
48	Atmospheric Valve (Spencer) . . . . .	193
49	Atmospheric Valve (details) . . . . .	193
50	Plain Air Pump . . . . .	194
51	Edwards Air Pump . . . . .	196
52	Edwards Air Pump . . . . .	201
53	Electrically Driven Air and Circulating Pump . . . . .	203
54	Double-Acting Air and Circulating Pump . . . . .	203
55	Vertical Air Pump . . . . .	204
56	Ejector Condenser . . . . .	206
57	Displacement Air Pump . . . . .	207
58	Air Pump Diagrams . . . . .	208
59	Horizontal Air Pump . . . . .	209
60	High-Speed Tail-Rod Pump . . . . .	210
61	Combined Tail-Rod Air and Circulating Pump . . . . .	211
62	Steam-driven Horizontal Air-Pump . . . . .	212
63	Direct-Acting Air and Circulating Pumps . . . . .	213
64	Two-Stage Air Pump with Jet Augmentor . . . . .	215
65	Rotative Air Pump for Augmentor Work . . . . .	216
66	Air Pump Diagrams . . . . .	217
67	} Displacement Circulating Pump . . . . .	219
68		
69	Economizer Cross-Section . . . . .	224
70	Green's Economizer, with Hot-water Return . . . . .	226
71	Green's Economizer, with Hot-water Return . . . . .	227
72	Economizer with Internal Scrapers . . . . .	228
73	Independently fired Controllable Superheater . . . . .	234
74	Independently fired Controllable Superheater . . . . .	235
75	Independently fired Controllable Superheater . . . . .	236
76	Weir Feed Heater . . . . .	238
77	Row Feed Heater . . . . .	240
78	Berryman Feed Heater . . . . .	241
79	Cruse Combined Boiler, Feed Heater, and Superheater . . . . .	247
80	Cruse Combined Boiler, Feed Heater, and Superheater . . . . .	249
81	Cruse Combined Boiler, Feed Heater, and Superheater . . . . .	251
82	Chimney Cooling Tower . . . . .	261
83	Fan Cooling Tower . . . . .	263
84	Fan Cooling Tower . . . . .	264
85	Spraying Nozzle . . . . .	267
86	Weir Feed Pump . . . . .	278
87	Duplex Feed Pump (Worthington) . . . . .	281
88	Cameron or Flywheel Pump . . . . .	282
89	Exhaust Injector . . . . .	284
90	Combined Injector . . . . .	285
91	Exhaust Injector . . . . .	286
92	Electrical Oil Separator . . . . .	302



Section I

THE TREATMENT OF WATER BY  
SOFTENING, OIL SEPARATION  
AND FILTRATION





## CHAPTER I

### INTRODUCTORY

ALL natural waters contain some impurity, the amount of which depends upon the nature of the soil over or through which the water has passed between such time as it descended in the form of rain and the time when it was impounded in some non-soluble vessel. When introduced to a steam boiler it is found that the impurities come out of solution either because water loses its soluble power at higher temperatures, or, owing to evaporation of some of the water, the remainder becomes super-saturated and the excess of impurity crystallizes out or otherwise deposits.

As deposited in a steam boiler, these impurities take the form of crusts more or less hard and adherent. These crusts are a source of trouble more or less serious and dangerous. In the first place, when they occur on heated parts of the boiler they reduce the efficiency of the transmission of heat through the metal plates, and, if very thick, the resistance to the passage of heat may be so great that the metal is rendered so hot as to become reduced in strength, and a dangerous condition may ensue, ending in serious collapse or rupture of the parts overheated, or even general explosion.

In process of time the amount of deposit becomes so great that its removal becomes imperative. In cleaning a boiler it is often requisite to employ picks, or the hammer and chisel, and in course of time the surfaces of the boiler become hacked over like a coarse rasp, by reason of the unskilful use of the cutting instruments. The cleaning of a boiler by these means is expensive, and it is work requiring considerable time. Water which causes deposit necessitates,

## WATER SOFTENING AND TREATMENT

therefore, a larger provision of boilers for a given duty. Incrustation has a powerful influence upon the design of steam boilers, and boilers, otherwise sound in principle and good in practice, may be barred out of use by the difficulty that would be experienced in respect of cleaning. In considering the cost of treating feed water so as to prevent deposits by removing the impurities from the water before its entrance into the boiler, there is to be set against the cost of treatment, the expense of cleaning, the waste of capital which represents the reduced life of the boiler, and the interest and depreciation charges on the increased plant which it is necessary to employ.

All the above inconveniences and expenses are avoided when a boiler is fed with initially pure water, or water that has been purged of its impurities by artificial means; and it may be added that pure water is beneficial in manufacturing processes, particularly in the preparation of high-class fabrics, the dyeing of fine wools, especially of the fancy order, such as Berlin wools; in brewing, in drug extracts, and in cleaning and washing purposes. Great waste of soap and detergents is obviated when pure water is used.

The purification of water for boiler feed purposes is carried out along two main lines.

First, by chemical means, such reagents being added to the water as to cause sedimentation of the impurities.

Secondly, by the aid of heat, which reduces the power of water to hold certain salts in suspension.

Thirdly, may be named filtration, by which matters held in mechanical suspension may be removed from water commonly termed dirty. Water of this kind will cause deposit in a boiler generally of a softer order than incrustation proper, for such mechanically suspended matter will usually be of a more or less clayey description. Such impurities will deposit in a large pond just as the muddy river Rhone emerges from the Lake of Geneva as a bright stream. Filtration is a substitute for time and area.

Fourthly may be named a combination of the first and second processes, but this can hardly be claimed as a distinct process, the addition of heat merely assisting the

## INTRODUCTORY

chemical process, though it may be substituted for it in certain cases, such as temporary hard waters.

Properly to clean a boiler when it is laid off from work it should be left full of water until, with its brickwork foundation, it has fallen to atmospheric temperature. This process can be hastened by allowing air to flow through the flues to as full an extent as admissible consistently with not vitiating the draught of other boilers or unduly cooling the economizer. Without either of these possible inconveniences, the removal of back plates of the down take will help to cool the flues of a boiler. If rapid cooling is imperative, the Manchester Steam Users' Association advise that cold feed may be introduced, while hot water is run out at the blow-out tap. A boiler should never be blown out under steam pressure if this can be avoided. Sometimes it is necessary to do this where the boiler is below the drain level, as is the case with boilers set in basements. This can sometimes be avoided if a supply of compressed air is available for blowing out the water, but the combination will be rare. An electrically-driven pump should be employed if a supply of electricity is available. The objection to emptying a boiler when hot and surrounded with hot brickwork is that the incrustation is dried and baked hard, and while drying it is exposed to the action of the air, and may absorb carbonic acid gas from the air, and this will help to fix the deposit more firmly.

Speaking generally of hard water, the Desrumaux Co. state that for every cwt. of soap used, at least 80 lb. will be converted into the well known scum which is an insoluble lime soap that settles in the texture of fabrics washed in hard water. Since 4 lb. of lime will soften as much water as 80 lb. of soap, the economy of softening is obvious.

They give a table compiled from data supplied by Messrs. S. Sutcliffe & Sons, of Bradford, showing the soap required to soften 1,000 gallons of water of three different degrees of hardness. It is calculated on the basis of  $2\frac{1}{2}$  ozs. of soap per 100 gallons per degree of hardness, or 1 lb. 9 ozs. per 1,000 gallons at 18s. 8d. per cwt. This represents a loss of



## WATER SOFTENING AND TREATMENT

$3\frac{1}{8}d.$  per degree of hardness. The insoluble lime soaps formed in fabrics cannot be completely removed, even by vigorous treatment, and good dyed tints cannot be obtained with hard water washed goods, nor can white goods be prepared. The lime soaps give a yellow tint and also stick to dirt.

As compared with the cost of boiler compositions, one chemist states that where it cost £177 per year to soften 33,000 gallons a week from  $11^{\circ}$  of hardness, the cost of chemicals for 70,000 gallons per week was only £35 per year, or less than one-tenth the former cost, and the water formerly used in boilers only was used after softening for dyeing also. Hence the increase in the weekly quantity.

## CHAPTER II

### WATER : ITS SOURCES AND IMPURITIES

ALL water has its origin in the sea. From the sea, and to a less extent from lakes and from land surfaces, the sun raises vapour to form clouds, and the condensation of this vapour produces rain, and this is the only natural source of so-called fresh water. In its descent to earth the rain dissolves from the atmosphere some of its constituents, notably carbon dioxide gas— $\text{CO}_2$ —of which four parts in 10,000 of the atmosphere consists, i.e. 0.0004. This gas is the chief agent in producing incrustation, because it enables water to dissolve certain salts of lime and of magnesia. In manufacturing localities the rain also clears the atmosphere of the acids produced by the combustion of coal, of ammonia, and of solid matters such as soot and wind-raised dust; but these latter impurities are not of serious importance from a steam user's point of view. Having fallen to earth, rain at once seeks lower levels, and finds them by sinking into the soil by gravity and absorption, or by travelling over the surface into streams and rivers.

Approximately of the rain which falls one-third runs off the surface into the rivers, one-third sinks deeply, and one-third is re-evaporated.

In traversing the surface, water dissolves a portion of the rocks and earths with which it comes in contact, and the same when it sinks to deeper levels and then travels gradually towards the sea along the rock planes. The character of the water in any district is thus determined by the rocks with which it has come into contact. In Great Britain the surface rocks are of great diversity.

## WATER SOFTENING AND TREATMENT

Generally they consist of alternations of clays, sands and limestones. The strata forming these islands are much disturbed and inclined downwards at a considerable angle. A study of the Geological Map of England will show that roughly each distinct stratification dips towards London, the outcrops lying in approximately concentric bands struck from a locus of centres between Dublin and Belfast. The various strata dip successively one below another, so that it may be inferred within limits that a hole bored at any spot will reach successively the strata lying progressively to the north-west of that spot. Faults and dislocations and the occurrence of rocks which do not outcrop upset this general scheme to such an extent that every case must be considered by itself in the light afforded by proved geological facts, assisted by experience and aided by the general principles enunciated. The rapid alternations of strata produce an equally rapid change in the character of the waters obtainable in different areas about the country.

Speaking generally of the five main divisions into which the rocks may be divided, it may be said that these are Clays and Marls, Sands, Limestones and Granites.

The clays—including slates—and marls are not themselves soluble, but frequently contain soluble salts, which are dissolved out by water. The marls often contain lime salt such as gypsum or sulphate of lime— $\text{CaSO}_4$ —which is absorbed by water. The clays are represented by the London Clay, the Gault Clay, the Lias Clay, Kimmeridge Clay, Weald Clay, Oxford Clay, etc. Slates are clays metamorphosed by heat and pressure, and so are the shales of the coal measures.

The marls are represented by the Old Red Marl and the New Red Marl, both of which contain gypsum, and by the marl of the Permian Beds, etc.

The sands are represented by the Bagshot Beds found on the highest points of the London Clay area as Hampstead, Highgate, Epping, Laindon Hill, etc.; by the Lower Greensand, the various beds of the New Red Sandstone, the Permian Beds, the many beds of the Carboniferous series, the Old Red Sandstone, and many of the older rocks.



## WATER : ITS SOURCES AND IMPURITIES

The representatives of the limestones are the Chalk, the Oolites, the Magnesian limestone, the Carboniferous limestones and many beds in the older rocks.

Granite occurs at the surface only in the west of the country, or in upheavals, as in the Charnwood Forest district.

Wherever there is lime in any form there will be hard water. Naturally soft water occurs with the sandstones and granites and the purer clay. Some of the water from these rocks is so pure that it requires no further purification.

Thus the water supply of Glasgow is taken from Loch Katrine, fed with rain that has fallen on non-cretaceous rocks, and it is quite soft. The old supply of Manchester is obtained from the Longdendale valley, which is superficially of millstone grit, and the only impurity of any consequence to the boiler user is a small amount of peat acid acquired from the peat which occurs upon the gathering ground. Many other of the northern towns have a public water supply which approximates closely to that of Manchester in origin and character, while Birmingham has obtained similar water from a higher barren tract of land in Wales of Silurian rock.

The coal measures, while yielding pure water from the sand rocks, will often produce very bad water in the region of the coal itself, water of very corrosive acid nature. No natural water is perhaps better than that from the Millstone grit, e.g. the Manchester supply from Longdendale.

A river water does not necessarily bear the character of the rocks over which it runs. The Millstone Grit and the Carboniferous limestone being contiguous rocks a river may be found running over one of these rocks, while its chief sources may have been the other rock. Thus the course of the Derwent in Derbyshire is almost wholly upon the rocks of the carboniferous period, yet it is largely fed from the area of mountain limestone of which middle Derbyshire consists, receiving as tributary the Wye, which with its sub-streams the Lathkill and Bradford, drains the Peak district. The Derwent is thus by no means a soft water river. Similarly the Thames, which runs over a clay country, passes through a chalk area west of London and contains

## WATER SOFTENING AND TREATMENT

some 20 grs. per gallon of lime carbonate. Again, wells bored in a sandstone or a limestone area do not necessarily yield water of a character corresponding to those rocks, for the borehole may have penetrated into lower rocks of a different order, as for example the numerous artesian wells in London which penetrate the London Clay and the lower Tertiary Beds and obtain their water from the Chalk. At the same time many of the chalk wells of London obtain their supply from water which has reached the chalk through the superincumbent bed of Thanet Sand, usually 30 to 40 ft. thick. When this is the case the chalk wells of London yield a water of small hardness, but apt to be heavily charged with salts of soda. It was hoped at one time to obtain really soft water at about 1,100 ft. depth in London from the Lower Greensand formation, but this expectation was disappointed, and at that depth much older rock, probably of Devonian age, was touched, and further evidence from subsequent deep borings at Crossness, Streatham, Harwich, Ware, Stutton, Kentish Town, Turnford, Culford, etc., and the coal borings at Dover, has demonstrated that a ridge of old rocks runs beneath London and south-eastern England and has interfered with the deposit of newer rocks. The nearest artesian well to London which has obtained water from the Lower Greensand is that at Winkfield, near Windsor, which touched the Greensand at 1,234 ft. below surface, entered it to 1,243 ft., and produces a flow of water which rises to 7 ft. 8 in. above the surface, or to about 225 ft. above ordnance datum. This well, sunk under the Author as engineer, probably draws its supply from rain which falls upon the outcrop of the Lower Greensand in the locality of Leighton Buzzard.

In this case the borehole was started upon a surface of London Clay, penetrated the chalk beneath and the gault, and only extracts any water from the Lower Greensand, and the water is soft. The instances cited will be sufficient to show to steam users that a merely superficial examination of their particular environment is insufficient on which to found a policy of water supply.

In originating a new manufactory it is too frequently the

## WATER : ITS SOURCES AND IMPURITIES

custom to consider everything except the water supply, and, when the money is spent and buildings have been erected, the water supply is taken in hand and may prove far more difficult a problem than anticipated. In a case familiar to the Author, where a pure supply of water was imperative, the same course of action was followed out. A boring was then made, and at 1,100 ft. below surface a supply of useless salt water was obtained and necessitated heavy payments for water from a source out of the control of the factory. Though dealing with the treatment of water the advice of the Author is to secure a supply, if possible, that does not require to be treated. This ideal water is rarely to be obtained, and treatment must be resorted to, but there must be frequent instances where, of two or more sites, one can be shown to contain better prospects of a suitable water than the others, not merely in respect of quantity, but also of quality.

This point is emphasized because the strata in Great Britain are often so disturbed that a very small difference of site may be of the utmost importance in respect of the artesian prospects, and the experience of the author in his capacity of Hydro Geologist has shown him the need for very careful investigation, especially in parts of the country geologically faulted. In order to determine the prospects of a supply and its quality it is necessary to make a close examination of the locality both in regard to levels and to geological conditions. Needless to say the water diviner's art is not reliable, though probably some men who affect to discover water and make frequent apparent successes have real geological knowledge, and they easily undergo their facial contortions and cause their mystic twig to jump at just such points as fit with their preconceived ideas or actual knowledge. Their failures are more numerous than those made by skilful engineers who study the site by light of geology, and often they will ignorantly diagnose ample water supply over hundreds of feet of impervious clays.

While for very large water supplies large dug wells are sunk with extensive galleries or headings driven as deeply as possible below water rest level, these wells are difficult



## WATER SOFTENING AND TREATMENT

and costly and involve heavy pumping or the compressed air system of working.

In most manufacturing establishments a bored tube well will be found sufficient. These are lined with steel tubes driven tightly into the strata and extending preferably below the point at which the water stands during pumping. When the water is below suction reach from the surface a long deep well pump is hung down the borehole. Frequently a borehole may tap water in more than one rock formation, and the water from each may be of different quality. The less desirable quality may be shut out if there is an ample supply of the more desirable. Unless of great depth and expense an independent water supply will usually be cheaper than a public water supply. But some of the public companies pumping hard water put it through the Porter Clark process and soften it before passing into their distribution mains.

## CHAPTER III

### THE SALTS CONTAINED IN WATER

THE salts usually responsible for the incrustation in a boiler are those of lime and magnesia. These salts, in the form of carbonates, are but slightly soluble in water, but as bicarbonates they dissolve freely. It is usual to state that carbonate of lime and of magnesia are soluble in water only in presence of an additional quantity of carbon dioxide gas. The fact that this gas is disengaged by boiling in the proportion of its chemical equivalent seems to show that it is as bicarbonates that the salts named really dissolve. The salts of lime and magnesia are the carbonates and the sulphates, and the treatment of boiler feed water consists, in the main, in getting rid of these two or four salts more or less completely.

It is necessary therefore to describe these salts and other impurities of feed water and to acquire some knowledge of their characteristics and general properties, before the method of their removal can be understood. They are as follows :—

Carbonate of Lime or Calcium Carbonate  $\text{CaCO}_3$ , or better to indicate its formation  $\text{CaO}, \text{CO}_2$ , is the substance that is formed when lime unites with carbon dioxide gas. Lime is the oxide of the metal calcium and is a white powder which greedily absorbs carbonic acid gas thus—Lime =  $\text{CaO} + \text{Carbonic acid} = \text{CO}_2 = \text{CaCO}_3$  as above. This salt of lime is very sparingly soluble in water, but if a second molecule of carbonic acid gas be added the salt readily dissolves.

Thus  $\text{CaO} + \text{CO}_2 + \text{CO}_2 = \text{CaO}2(\text{CO}_2)$ .

## WATER SOFTENING AND TREATMENT

In nature, lime carbonate is widely spread and constitutes the bulk of the chalk and of the mountain limestone formations, and is indeed the main constituent of all limestone rocks, marbles, etc. When dissolved as bicarbonate there is supposed to be present also a molecule of water,  $=\text{H}_2\text{O}$ , so that dissolved lime carbonate has the formula  $\text{CaO}, \text{H}_2\text{O}, 2\text{CO}_2$ .

The attachment of the additional molecule of carbon dioxide is but feeble, and the application of heat is sufficient to drive it off and render the remaining carbonate of lime insoluble. Thus it is that when a lime carbonate water that has been gradually heated in an economizer enters a boiler, it often throws off at once the additional molecule of  $\text{CO}_2$  and deposits lime carbonate crystals,  $\text{CaCO}_3$ , about the feed inlet. A small quantity of carbonate remains in solution to the extent of only 0.03 per 1,000 of water, corresponding to 2.1 grs. per gallon (10 lb.).

Pure carbonate of lime does not produce a scale of great hardness at first, but it hardens with heat and dryness. It is recognizable by the peculiar and characteristic appearance of the crystals of lime carbonate under the microscope. If a carbonate water be heated very quickly the lime salt is more likely to be deposited as mud. When slowly heated the lime salt forms the well known mineral calcite, and, according to Stromeier, this constitutes a hard scale. It may do so when baked or when exposed to even gentle heating for some time as on a boiler bottom, but when, as frequently happens, the passage of such a water through an economizer just suffices slowly to raise the water to depositing point, the calcite crystals will separate out upon the perforated feed inlet pipe, and upon the boiler side near the open end of a feed pipe, in large pulverulent masses of slightly adherent crystals. The deposit has somewhat the appearance of a reddish sandstone, but the calcite is easily distinguishable by the microscope. A boiler must be opened up before its usual time in many cases to clear the feed pipe of the obstruction to the flow of water. The openings to water-gauge taps also become incrustated, and may give rise to dangerously delusive gauge appearances.

## THE SALTS CONTAINED IN WATER

Indeed it is probable that these dangers have been diminished largely because a glass gauge is a condenser and maintains a constant stream of soft water back to the boiler through the lower taps. To intensify this effect copper bulbs are sometimes connected above the upper fitting for the purpose of pouring a steady stream of pure condensed steam down the gauge glass and through the lower cocks.

When other salts are present the scale is modified. The molecular weight of lime carbonate is 100, its specific gravity is 2.7. It combines with 44 parts of carbon dioxide,  $\text{CO}_2$ , to form bicarbonate. If to water in which calcium carbonate is dissolved by the influence of an excess of carbonic acid there be added 56 of lime =  $\text{CaO}$  for each 100 of lime carbonate,  $\text{CaCO}_3$ , held in solution by 44 of carbonic acid— $\text{CO}_2$ —there will be a total of 200 of simple lime carbonate formed. The lime joins with the carbonic acid gas to form carbonate of lime.

Carbonate of magnesium,  $\text{MgCO}_3$ , is the same salt relative to magnesium that carbonate of lime is to calcium. Its molecular weight is 84, its specific gravity is 2.94. It is usually found in nature in combination with carbonate of lime in the shape of a double salt known as dolomite. The behaviour is generally similar to that of lime carbonate, but because of the smaller atomic weight of magnesium compared with calcium the molecular weight is less, and 84 of magnesium carbonate requires an equivalent of 100 of calcium carbonate. Some authorities state also that magnesium carbonate is decomposed by heat into magnesium hydrate and carbon dioxide thus,  $\text{MgH}_2\text{O}_2 + \text{CO}_2$ .

It is soluble in water to the extent of 0.02 per cent. = 14.00 grains per gallon.

The salt next in importance, and even more troublesome, is the sulphate of lime,  $\text{CaSO}_4$ , or  $\text{CaO}, \text{SO}_3$ . This salt is found in the keuper marls of the new red series and in the old red marls as gypsum. It was also found in the subwealden boring in Sussex, and it forms the salt in the waters of Burton-on-Trent which gives the special character to the Burton Ales.



## WATER SOFTENING AND TREATMENT

Sulphate of lime, or gypsum, is found as a hydrate in nature, and if burned or dehydrated it again unites with water to form plaster of Paris. As a boiler incrustant it is hard and adhesive. In boilers at Burton-on-Trent the scale is of a glistening white, but underneath the scale the iron of the plates and rivets is corroded and oxidized. The sulphate is readily soluble at ordinary temperatures in water, the solubility at  $34^{\circ}\text{C.} = 93^{\circ}\text{F.}$  being 0.212 per cent. or 148.4 grains per gallon. At the boiling point,  $100^{\circ}\text{C.} = 212^{\circ}\text{F.}$ , the solubility has fallen to 0.162 per cent. or 113.4 grains per gallon.

In sea water there is considerable gypsum, the solution being assisted by common salt. The molecular weight of sulphate of lime is 136, its specific gravity is 2.927.

Sulphate of lime makes a hard scale because it does not deposit until compelled to do so by concentration. At the temperature due to high pressures water will dissolve, according to Stromeier, 20 grains per gallon. Then, if the boiler be let down somewhat, some of the scale redissolves until, when cold, there are 170 grains per gallon, and this process loosens the scale, which can be more readily removed wet. If allowed to dry the concentrated solution in the body of the scale simply crystallizes and cements the mass hard.

The slowness with which the sulphate deposits is the cause of its adhering so firmly to the plates.

When there is sulphate in the scale it is doubly important promptly to wash out the boiler while still wet, and to keep it wet by successive sluicing with the hose while in process of cleaning. As sulphate is fairly soluble in pure water the use of a soft water should soon begin to tell on old sulphate scale, which will ultimately be quite removed or disintegrated.

Sulphate of magnesia,  $\text{MgSO}_4$ , is the salt of magnesia which corresponds with the sulphate of lime. Its molecular weight is 120 and it is very soluble in water. The formation in nature of this salt is said to be due to the action of lime sulphate water on carbonate of magnesia, the result being carbonate of lime and sulphate of magnesia, but this action is reversed when hot and there is produced sulphate of lime



## THE SALTS CONTAINED IN WATER

and magnesium carbonate from carbonate of lime and sulphate of magnesium.

The solubility of the salt is 24.7 per cent. at  $0^{\circ}\text{C.} = 32^{\circ}\text{F.}$  and 132.5 per cent. at  $105.5^{\circ}\text{C.} = 222^{\circ}\text{F.}$  Its specific gravity is 1.751 in crystal form.

Waters containing salts other than the above salts are not widespread. Chloride of sodium or common salt,  $\text{NaCl}$ , is found plentifully of course in the sea and in the salt districts of Cheshire and Worcestershire. Nitrates and chlorides are particularly pernicious in that they produce in the presence of the magnesium salts a deposit of hydrated carbonate of magnesium which is not soluble, and of hydrochloric acid which, in its nascent state, is particularly destructive of boiler plates and tubes. At high pressures and temperatures this action is particularly marked, and has put out of use water that was more or less admissible in the time of lower pressures. High temperature in fact appears to exercise a peculiarly bad effect in decomposing the salts of magnesia and the chloride of sodium, and such waters should be avoided if possible.

In table I will be found a list of the chemical and physical properties of the chief impurities of water, and of the substances employed in purification and formed in the processes of treatment.

Speaking in a general sense the treatment of water for scale prevention is carried out along two lines.

In one, some substance is added to the water which causes the scale forming salt to become insoluble, when it may be precipitated or filtered out.

In the other a salt of small solubility is changed into one of high solubility which will accumulate in the boiler without crystallizing out until such time as the solution becomes very dense, when the boiler must be wholly or partially emptied.

The first method is that most commonly practised because the commonest form of incrustation is the lime carbonate,  $\text{CaCO}_2$ . Dr. Clark, who discovered the process, has given his name to it.

It depends upon the solubility of bicarbonate of lime in

## WATER SOFTENING AND TREATMENT

the feed water, the insolubility of carbonate of lime and the affinity of lime hydrate for carbonic acid gas. River and spring and other natural waters can hold bicarbonate of lime in solution to a considerable extent. A quite usual quantity is 20 grains per gallon =  $\frac{1}{3500}$  or 0.03 per cent. Table I shows that carbonate of lime has only about one-tenth this solubility. Dr. Clark reasoned that if he added hydrated caustic lime,  $\text{CaOH}_2\text{O}$ , to water containing bicarbonate of lime in solution he would convert the soluble bicarbonate into insoluble carbonate, for the hydrate would greedily absorb the second molecule of carbonic acid gas, and it would change itself also into insoluble carbonate. Thus both the lime salt naturally present in the water and that artificially present would become insoluble carbonate and would precipitate together.

## CHAPTER IV

### THE REACTIONS OF SALTS IN SOLUTION

UPON the reactions which occur between various salts in solution depends the purification that can be effected. This reaction, as it relates to the use of lime as a reagent, has already been referred to in Chapter III.

Expressed in chemical notation the action is as here represented. Under each substance is placed its formula and its equivalent weight, so that the whole process may be traced out.

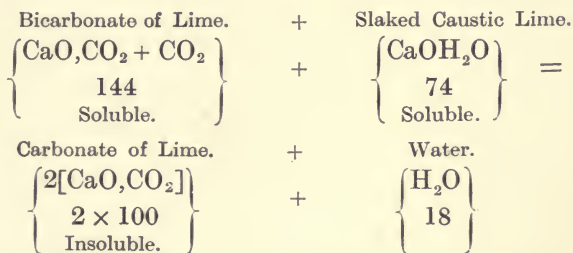

In this reaction a weight of 100 of carbonate of lime is held in solution by 44 parts of carbonic acid. There is added 56 of caustic lime hydrated with 18 of water. The 56 parts of lime seize the 44 parts of carbonic acid and convert themselves into 100 parts of lime carbonate. The loss of the extra 44 of carbonic acid leaves 100 parts of the original matter now insoluble and 200 parts of a chalky mud are precipitated. The process is very effective and it is the cheapest known.

When water is analysed for carbonate of lime the extra molecule of carbonic acid does not appear, and the analysis is stated in terms of simple carbonate only or  $\text{CaOCO}_2$ ; = molecular weight 100.

## WATER SOFTENING AND TREATMENT

Similarly in preparing lime water for treatment no notice is taken of the hydration water, but the dry lime is taken just as fresh burned as possible. Thus for each 100 parts of carbonate of lime there are required 56 parts of freshly-burned unslaked lime.

It is known, say, that a feed water contains 20 grains per gallon of carbonate, and the water consumption is 10,000 gallons per day. Then  $10,000 \times 20 \div 7,000 = 29$  lb. nearly of dry scale per day that would be deposited in the boilers or economizers, etc.

This figure multiplied by  $\frac{56}{100}$  or  $29 \times 56 \div 100 = 16.24$  lb. of dry caustic lime necessary to soften 10,000 gallons of water. The result would be nearly 60 lb. of chalky mud when dry.

Bicarbonate of lime, though given in Table I as an anhydrous salt, and it may be so considered for convenience, is not known in that form. It is supposed only to exist in water charged with carbonic acid, and its formula then is  $\text{CaO}, \text{H}_2\text{O}, 2\text{CO}_2 = 162$ . When boiled the extra volume of  $\text{CO}_2$  is driven off, and the carbonate, now no longer soluble, becomes mud or scale. Some processes of water softening employ heating in a convenient vessel in which the scale deposits harmlessly and it can be removed at convenient times.

### Carbonate of Magnesia.

Next to carbonate of lime the common scale-forming salt is carbonate of magnesia. Except that its molecular equivalent is 84 instead of 100 its action is the same as that of lime carbonate, but more caustic lime is necessary to precipitate it in the ratio of course of 100 : 84.

Thus each 100 of carbonate of magnesia demands  $56 \times \frac{109}{84} = 66.66$  of caustic lime to absorb the excess of  $\text{CO}_2$ , the result being a deposit partly of magnesium carbonate and partly of lime carbonate. Expressed in formula as in the previous case—



## THE REACTIONS OF SALTS IN SOLUTION

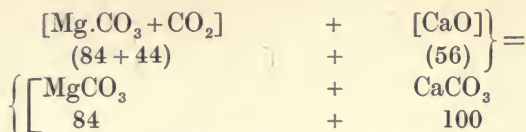

a total deposit of 184 takes place where 200 took place in the case of lime carbonate.

Carbonate of magnesia usually occurs with lime, and the two are treated together.

When water charged with carbonate of lime enters a boiler the water being already hot, and the boiler being, at say, 350° F., the deposit of the lime is very rapid. It crystallizes around the feed pipe and on the side of the boiler close by, and soon chokes the feed pipe perforations. This is one reason why water ought to be treated outside the boiler.

If carbonate of magnesia be present it often separates out as a fine flour which floats for a time on the surface of the water, is often carried off in priming water, but is peculiarly dangerous when the feed water contains grease.

[Fortunately when waters are greasy they have often been purged of all scale-forming matter, coming as they do from surface condensers.]

The floury deposit combines with grease to form a peculiar spongy substance, which will collect into balls and sometimes will collect on furnace crowns. Being a non-conductor of heat such a deposit on the furnace crown will cause overheating and collapse of the plates. Grease must be avoided at all costs, for magnesia may still find its way in by way of the making up water.

Except that magnesium carbonate decomposes at high temperatures into carbonic acid and the hydrate, the behaviour is that of lime. This one difference is not of importance except so far as that the effect takes place in the feed pipes and chokes these with a sort of gelatinous paste. It is to avoid this effect that water is recarbonized in the Archbutt-Deeley process to enable it to absorb or avoid such deposits. Water fully saturated with carbonic acid can absorb as much as 70 grains per gallon of lime carbonate. Distilled water, says Mr. Archbutt, will only dissolve 1.3 grains per gallon.

## WATER SOFTENING AND TREATMENT

He has rarely found more than 5 to 6 grains of carbonate of magnesia, occasionally twice this quantity, and once 28·8 grains.

He also states that sufficient lime must be added to a magnesia water to decompose the carbonate of magnesia into hydrate thus—

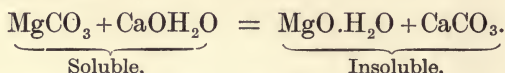

This, if done, implies an additional quantity of lime of 66·66 lb. for each 100 of magnesia carbonate, or just double in all what the first calculation gives, i.e. 134 of dry caustic lime per 100 of magnesium carbonate. This is advised because it is considered that the carbonate is much more soluble than is lime carbonate, but the hydrate is insoluble or nearly so. This further treatment demands the recarbonating of the finally treated water, which converts all remaining lime and magnesia into the soluble bicarbonate.

In the year 1858 Dr. Angus Smith, F.R.S., was asked to investigate the waters used in and around Manchester on behalf of the Manchester Steam Users' Association, and his report was issued in 1859 and has since been reprinted. This report is given in the appendix, but it must be noted, of course, that the one line of chemical symbols is not written on present day notation, the accepted atomic weights being now different.

The most usual salt in hard water being carbonate of lime or of magnesia, so is lime, quick or caustic, CaO, the most usual reagent. The proper quality of lime to employ is that known as fat—that is, it is a pure lime free from clay or argill. Dorking grey lime, made from the lower chalk, is partially hydraulic, and therefore unsuitable. The upper chalk will produce white or fat lime, and so also does the carboniferous limestone of Derbyshire, the lime from which is sold under the generic name of Buxton lime.

In using lime it must be stored carefully, and should be contained in an air-tight vessel or it will absorb carbonic acid from the air. It is usual to slake it with water sufficient to form a paste the day before use. If the operation



of softening is done by hand there should be two tanks, each holding not less than a day's supply for use alternately. The proper weight of lime for one tank of water after slaking is to be further mixed with water to a creamy consistency, emptied into the tank and thoroughly well stirred together with the deposit, some of which must always be left in the tank from the previous operation, as the presence of this deposit facilitates the sedimentation of the new deposit.

When mechanical apparatus is employed the lime is mixed either as milk of lime or as lime water. Milk of lime is more or less uncertain in its composition according to the vigour with which it is kept agitated. Lime water is a certain product which contains just so much lime as water will absorb, and it is thus nominally a simple matter to divert a suitable proportion of a given stream of water through a vessel of lime, such proportion being fixed at what will carry the amount of lime necessary to soften the whole.

Thus when lime is present in abundance a passing flow of water will take up 1.3 grams of lime,  $\text{CaO}$ , per litre or 0.13 per cent. As in commercial lime only a part is effective it is necessary to provide more lime to the extent of about 30 per cent. more or less. The use of lime water demands that for each degree of temporary hardness about 0.55 per cent. of lime water must be employed. This implies the division of the stream of water in ordinary cases in the ratio of 1 : 10, but while this may present some inconvenience, yet it enables graduation to be better effected, and is easily managed in mechanical apparatus of the continuous order.

#### Soda.

This reagent exists in many forms more or less pure. In its caustic state, as  $\text{NaHO}$ , it is a solid crystalline substance dangerous to handle and very destructive to the skin, and dangerous to the eyes.

Soda Ash is nominally Carbonate of Soda,  $\text{Na}_2\text{CO}_3$ , anhydrous, and is rated commercially on its percentage contents of  $\text{Na}_2\text{O}$ .

Dissolved in water it crystallizes, when evaporated gently, with 10 parts of water and becomes soda crystal or common

## WATER SOFTENING AND TREATMENT

washing soda,  $\text{Na}_2\text{CO}_3 + 10\text{H}_2\text{O}$ , of which only 106 parts out of 286 are carbonate of soda, and only about 21 per cent. is rateable as alkali or  $\text{Na}_2\text{O}$ .

Caustic soda must be kept from the air as carefully as lime, or it will become carbonate, and being also hygroscopic, will ultimately convert itself into crystal soda.

### Magnesia as a Re-agent.

As with lime, so also with magnesia, may both lime and magnesia carbonates be thrown down. Thus—

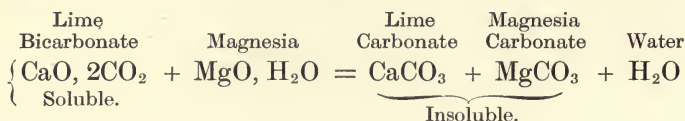

and—

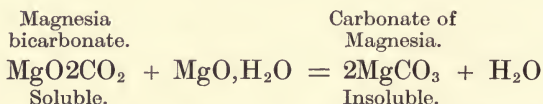

A reaction not much recognized is claimed for the precipitated carbonate of magnesia, namely, that if sulphate of calcium be present in the water the magnesia deposit will act upon it as follows :—

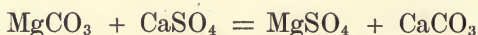

forming insoluble carbonate of lime precipitate and soluble sulphate of magnesia.

If no other salts are present than the sulphate and carbonate of lime, the employment of the magnesia reaction should produce complete purification when the ratio of carbonate and sulphate lies within certain limits. But as already stated, magnesia must not be employed where even small quantities of chlorides are present by reason of the acid corrosion which will result.

All the magnesium salts except the bicarbonate produce permanent hardness, and they are also with that one exception very soluble. They are nitrates, chlorides and sulphates, and they destroy soap.

By means of caustic lime and soda ash Stromeyer says

## THE REACTIONS OF SALTS IN SOLUTION

all the magnesia salts can be converted into insoluble hydrate, with the formation of carbonate of lime, etc.

Though lime is so cheap an agent, the ordinary boiler user pins his faith on some salt of soda or more rarely of potash.

Hydrated caustic soda,  $\text{HNaO}$ , or hydrogen sodium oxide has, like caustic lime, a powerful affinity for carbonic acid gas, and will deprive bicarbonate of lime of the extra molecule of the gas, thus—

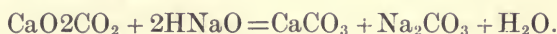

The carbonate of soda is very soluble, and it also possesses the power of decomposing sulphate of calcium, when the following interchanges occur—



The last salt, sulphate of soda, remains in solution, and can only be dealt with by blowing out so as to avoid undue concentration.

Sulphate of magnesia will be similarly acted upon with formation of magnesia and sodium sulphate.

Caustic soda, however, is a much more expensive salt than caustic lime, and is not much employed. In general good practice carbonate of soda is employed in combination with caustic lime, thus—

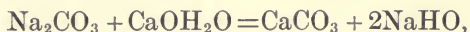

the soda being rendered caustic by the lime, which is converted into insoluble carbonate, and the caustic soda produced then acts on any carbonate present, and becoming itself carbonate, is ready to act on lime sulphate and converts itself into sulphate of soda. A sufficient explanation of the double effect will be found in Dr. Angus Smith's report in the appendix.

### Soda and Potash as Carbonates.

Carbonate of lime may be precipitated by carbonate of soda in a continuous manner. The following reactions are considered to occur.

In the first place carbonate of soda—

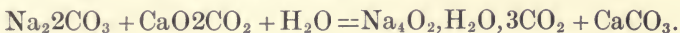

## WATER SOFTENING AND TREATMENT

The soda salt is presumed to be in the form of sesquioxide and to decompose into  $\text{Na}_2\text{CO}_3 + \text{H}_2\text{Na}_2\text{2CO}_3$ , and then into  $(\text{Na}_2\text{2CO}_3) + \text{CO}_2 + \text{H}_2\text{O}$ .

The carbonate of soda appears to possess the property of depriving the carbonate of lime of the excess of carbonic acid which keeps it in solution. The highly carbonated soda salt then throws off the carbonic acid free and attacks a fresh quantity of lime carbonate. Its action is thus successive and cumulative.

With sulphate of lime and carbonate of soda or potash the result is carbonate of lime and sulphate of soda, or

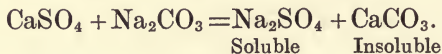

Soda has also a decomposing effect on calcium chloride, from which it produces sodium chloride and carbonate of lime as below—

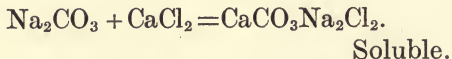

The foregoing are the chief reactions in ordinary use, and this is accounted for by their general low cost rather than by their effects, for there are equally good and even better effects to be produced by other reagents, which however are too costly for regular trade purposes.

### Barium Aluminate.

One of the best reagents is the double salt of barium and aluminium,  $\text{Al}_2\text{O}_3\text{BaO}$ . With carbonate of lime the reaction is as follows—

$\text{Al}_2\text{O}_3\text{BaO} + \text{CaO}, \text{H}_2\text{O} \text{2CO}_2 = \text{CaCO}_3 + \text{BaCO}_3 + \text{Al}_2\text{O}_3\text{H}_2\text{O}$ .  
All the salts which result from this reaction are very insoluble and are precipitated. So with calcium sulphate the reaction is—

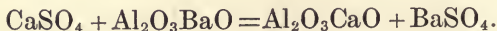

Thus no salt is formed which remains soluble, and water may thus be purified completely by the aid of this double salt of barium and aluminium.



## CHAPTER V

### THE LESS USUAL REAGENTS

#### Silicate of Soda.

**T**HIS salt will precipitate lime carbonate with formation of a gelatinous silicate of lime and carbonate of soda, thus—

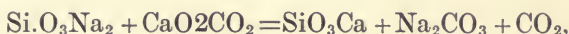

carbonic acid being set free. If sulphate of lime be also present, the carbonate of soda formed in the above reaction then serves to decompose the sulphate as well perhaps as to act continuously as explained on lime carbonate.

Silicate of soda may be used on a simple lime sulphate water, thus—

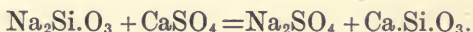

M. Taveau says that 600 grammes of silicate of soda solution of 35° Beaumé per horse-power if renewed every month will disincrust most ordinary waters.

#### Oxalate of Soda.

This salt is expensive, but is a good reagent. It forms a precipitate of calcium oxalate of a particularly insoluble nature. Thus—

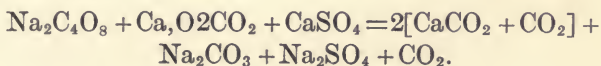

The potash oxalate  $\text{K}_22[\text{CO}_2]_2$  has a similar action.

## WATER SOFTENING AND TREATMENT

It has been proposed in Germany to employ chromate of soda or potash as a reagent for both lime carbonate and lime sulphate. Thus for chrome potash—

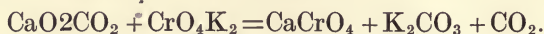

For lime sulphate the reaction is—

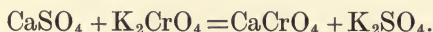

The chromate of lime is insoluble, but the process is out of the range of practice, for the chromic alkalies are expensive and moreover have a very high molecular weight, and to precipitate a molecule of lime carbonate of the weight 100 one molecule of chrome potash would be required of which the molecular weight is 194.5.

In many of the reactions shown in this and the preceding chapter it will be noted that a salt which has precipitated one impurity has itself changed, so that it is now in a form to attack a second impurity. Thus caustic soda will attack carbonate or rather bicarbonate of lime and cause it to precipitate, and the caustic soda becomes carbonate of soda, and will then precipitate lime sulphate in the form of carbonate, and only sodium sulphate is left in solution.

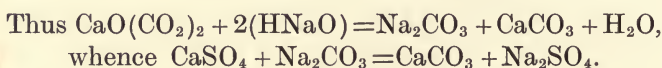

As explained in Dr. Angus Smith's report (*see* Appendix No. 1) a water containing both carbonate and sulphate in the ratio of 100 of carbonate to 136 of sulphate (the molecular weight ratios) can be exactly treated by this method. If the carbonate is in excess the excess of carbonate is to be more cheaply treated by caustic lime. If the sulphate is in excess an additional amount of carbonate of soda must be added. The subject is fully dealt with in the report referred to.

### Alum and Alumino Ferric.

When a water contains organic matter, as will be the case if it is sewage polluted, or if it comes from an ordinary



## THE LESS USUAL REAGENTS

river flowing under healthy conditions, and therefore more or less charged with the germs of green plant life, it will be found more difficult to soften than a water from an artesian well of the same degree of mineral impurity. With such waters it is usual to add a very small amount of some chemical having the power of coagulating organic matter. Such a substance is alum,  $\text{Al}_2\text{K}_24\text{SO}_4 + 24\text{H}_2\text{O}$ . This is a double salt of aluminium and potassium, and is known otherwise as potash alum. Added to water together with the usual reagents it coagulates the organic matter, and this facilitates the deposit of the newly-formed lime precipitates.

Alumino ferric is an alum in which  $\text{Al}_2\text{O}_3$  is replaced by  $\text{Fe}_2\text{O}_3$ . Its name is misleading, for it should rather be called potassia-ferric, for it contains no alumina. It is powerfully astringent and is employed not only to coagulate organic matter as described, but also in the process of separation of oil from the water discharged from surface condensers.

### Heat.

The heating of water is often made to do duty in removing temporary hardness, leaving the permanent hardness to be dealt with by soda. To this extent therefore heat may be almost classed as a reagent, but its complete effect is only secured at the atmospheric boiling point. Inside a high-pressure boiler water already fairly hot when it enters the boiler will reject its lime carbonate very promptly.

Heat, even if only a few degrees temperature additional, will always facilitate the discharge of the  $\text{CO}_2$  from temporarily hard water, and render softening more complete or reduce the time duration of the process.

In Chapter X will be found further remarks on the heat treatment of temporarily hard water, with suggestions for carrying this out when the use of so much steam is not permissible as in non-condensing steam plants and where use is desirable of the heat otherwise wasted in the flue gases but available for feed heating.

## WATER SOFTENING AND TREATMENT

### Barium Carbonate, etc.

This salt may be used for removing calcium sulphate, and, apart from its price, it is a most satisfactory reagent, for it leaves no salt in the water as does sodium carbonate, which changes into sodium sulphate which is very soluble, but in time will of course concentrate.

Barium carbonate,  $\text{BaCO}_3$ , is itself an insoluble salt and cannot be added in the ordinary way by solution. A large quantity of the salt may be dumped at once into the softening apparatus, for no more will be taken up than is necessary to take up the sulphuric acid present in either the free or combined state. The products of the reaction are barium sulphate and lime carbonate, both insoluble salts.

The barium salts being many of them insoluble, are thus excellent reagents. Any carbonate of lime held in solution by carbon dioxide must be treated by lime.

Barium hydrate,  $\text{BaO}, \text{H}_2\text{O}$ , soluble in three times its weight of boiling and 20 of cold water, may be added to reduce permanent hardness.

In comparing this with soda Mr. McGill says that 300 parts of soda,  $\text{Na}_2\text{O}$ , will reduce 271 units of permanent hardness. A unit of permanent hardness is 1 part of  $\text{CaO}$  per million. Soda ash at  $\frac{3}{4}d.$  per lb. of true carbonate, and caustic soda at  $1\frac{1}{4}d.$  per lb. of true hydrate, involve a cost of 3.85 pence per 1,000 gallons, so that 4.25 pence may be taken as the outside cost per 1,000 gallons.<sup>1</sup>

To obtain the same result with barium 7.4 lb. of the oxide, equivalent to 15.2 lb. of the crystallized hydrate, or  $\text{BaOH}_2\text{O} + 8\text{H}_2\text{O}$ , would be necessary. Its price would have to be only 0.575*d.* per lb. for oxide and 0.28*d.* for hydrate to compete with soda. The lowest price yet quoted appears to be  $3\frac{1}{2}$  times these figures in Germany, and  $2\frac{1}{2}$  times at Niagara. The barium salt may ultimately be electrically manufactured at cheaper rates. The use of barium hydrate will of course set free lime hydrate, which will reduce any lime carbonate present in the water to the

<sup>1</sup> Mr. McGill writes from Montreal, so it is to be presumed he means the British gallon.

## THE LESS USUAL REAGENTS

insoluble state. Otherwise barium must be used as both hydrate and carbonate in proper proportions to suit the carbonate and sulphate of lime present.

It requires 153 parts of barium oxide = 315 of crystallized hydrate to deal with 56 units of permanent hardness, and the product will then deal with 56 of temporary hardness also. At present treatment by barium is not commercially practicable as a rule, but occasions may happen when it could be used with advantage.

## CHAPTER VI

### SCALE AND ITS EFFECTS

**F**OR any particular area of incrustated plate the presence of scale will seriously reduce the passage of heat and plates may become overheated. But if only a part of a surface be covered with scale the efficiency of the part covered will be reduced, but the clean part will be improved.

To show this idea in approximate figures Mr. Stromeyer<sup>1</sup> has given the following table of temperature distribution in a boiler—

TABLE I.  
HEAT DISTRIBUTION IN BOILERS.

Sq. ft. heating surface per lb. of fuel per hour.	0	$\frac{1}{4}$	$\frac{1}{2}$	1	2	4	8
Flame and flue temp. F.° .	3,000	2,421	1,961	1,335	728	426	381
Maximum plate temp. . . .	400	396	392	387	383	381	380
Total heat transmitted%	0	19.8	35.6	57.0	77.8	89.2	89.7
Boiler with scale, $\frac{1}{8}$ in. thick.							
Flame and flue temp. . . .	3,000	2,484	2,070	1,471	835	459	384
Maximum plate temp. . . .	691	630	581	510	434	389	382
Total heat transmitted%	0	17.5	31.8	52.4	74.2	87.0	89.5

<sup>1</sup> *Proc. Inst. M.E.*, 1903.



## SCALE AND ITS EFFECTS

As boilers usually have  $1\frac{1}{2}$  to 2 sq. ft. of surface per lb. of fuel per hour the total loss from scale will not be so great, and with light work as represented by 4 sq. ft., it has fallen to less than 3 per cent. Still the presence of scale is harmful. The plates are hotter and the entry of cool air produces greater contraction just as the high temperature has produced a greater expansion, grooving, and similar forms of corrosion are set up as a witness to the movements that are in progress, and these movements are producing stresses and gradually destroying the boiler, and this alone is a sufficient reason for the use of soft water.

### Grease.

Though introduced with a nominally clean water from surface condensers, grease is more of a danger than scale. The merest film of grease on a furnace plate will cause overheating and collapse, and though water may be deprived of much of its grease by slow settlement and by filtration through sawdust, there is difficulty in removing all. Combined with carbonate of magnesia grease forms a peculiar spongy deposit which, if it settles on a furnace, will quickly produce collapse.

Apart from the grease, however, the water from a surface condenser has no impurities. If mixed with a hard water and treated by some of the methods described, the precipitation of the lime salts will carry with it the oil also. Condenser water should apparently be carbonated, well mixed with ground chalk, and then re-softened.

Only lime carbonate would be present to be dealt with, and there would be no other salts to deal with. It is most important that no oil should enter a boiler.

### Organic Matter.

The purification of a well water free from organic matter is easier to carry out than the purification of water of the same quality after it has flowed down a stream. Thus the water of the Thames is more difficult to soften than water

## WATER SOFTENING AND TREATMENT

from a chalk well of equal character, except for the organic life.

The deposit of the lime salts is more slow. This difficulty is got over by means of alum, as already described in Chapter V.

For any particular area of heating surface the loss of efficiency due to scale is given by the following table—

TABLE II.  
LOSS OF HEATING POWER DUE TO SCALE.

Thickness of Scale	In. $\frac{1}{64}$	In. $\frac{1}{32}$	In. $\frac{1}{16}$	In. $\frac{1}{8}$	In. $\frac{3}{16}$	In. $\frac{1}{4}$	In. $\frac{3}{8}$	In. $\frac{1}{2}$	In. $\frac{5}{8}$	In. $\frac{3}{4}$
Loss of Heating Power . . .	2%	4%	9%	18%	27%	38%	48%	60%	74%	90%

These losses are not found to occur in boilers, because the whole of the boiler surface does not usually become covered. Still the loss is always serious apart from the stresses set up in the boiler plates.

At Burton-on-Trent many boilers are fed with water that is heavily charged with sulphate of lime, and the whole interior of a boiler up to the water line presents a dazzling white appearance of great beauty. If the scale however be attacked with a hammer and broken away from any portion, as from a rivet head, the plate or rivet will be observed to be in a rough corroded state, very black and exuding a blackish liquor which is probably a compound of iron with sulphuric acid from the scale.

This appearance of plates under scale is not universal, possibly it is an attribute of the more purely sulphate scales, and it might perhaps be corrected by the use of an alkali. But at Burton any chemical treatment is debarred so far as relates to any boiler supplying steam for brewing purposes, and chemical treatment in a boiler is frequently debarred in other industries also, and this is an argument for treatment in separate vessels. The more entirely carbonate scales behave differently. A carbonate water heated well towards boiling temperature, if then fed into a boiler at about 150 lb. pressure, will acquire a considerably higher temperature as



## SCALE AND ITS EFFECTS

it travels along the feed distribution pipe and will promptly part with its lime carbonate, which will collect in large masses upon the feed pipe and immediately around, and the feed will ultimately become completely enclosed and choked as already stated.

The presence of magnesia seems to be responsible for that fine floury deposit which gets itself carried over to the engines and mixes with oil in the boiler to form a light spongy mass that will cause the furnace crowns to come down should it happen to settle on them.

The most usual scale is constantly becoming loose from the plates, and as constantly does it become re-cemented by freshly-formed scale. Most of the scale formed collects at the quieter parts of a boiler, which are, in the Lancashire type, the back end at the bottom and along the lower parts of each side of the shell, and in the water-tube type in mud drums placed out of reach of the hotter gases. But scale will collect in water tubes, which must eventually become burned as a result, for, unlike fire tubes, the scale in a water tube cannot automatically break away from the metal. On the furnace crowns of shell boilers and on fire tubes scale as a rule is somewhat easily detached, but the appearance of any boiler using hard water should be sufficient in itself to compel the owner to soften the water. Unfortunately boiler owners are too rarely acquainted with the interior of their boilers, and do not therefore attach sufficient weight to the representations of their engineers, and water softening is yet far from universal. Very often it is obvious that the scale in some parts of a boiler is merely built up of bits that have separated from other parts. Thus the cross tubes that were once so much used in Lancashire boilers have been found choked up with re-cemented scale of this nature.

## CHAPTER VII

### WATER ANALYSIS

THE analysis of water in its more particular aspect is of too special a nature to justify full treatment in a book of this nature. The ordinary steam user will not require to conduct his own water analysis. The analytical chemist who does such work will obtain any assistance of which he is in need from more strictly chemical treatises. In a very large number of cases the steam user who suspects carbonate of lime only in serious amount, as for example those cases which lie on the chalk outcrop that extends over so much of the country south-east of the curved line between Hull and Dorchester, will often be able to treat the feed water of his district by a trial and error process, simply adding progressive amounts of caustic lime to a definite volume of water until the pink reaction with phenolphthalein or the light straw colour with nitrate of silver, shows the alkalinity that proves a sufficiency of treatment.

One of the methods of water analysis is that which rests on the power possessed by soap of rendering water frothy when the water is pure, and of not producing a lather so long as any earthy salts are held in solution, particularly those of lime and magnesia. The soap solution is made of a certain fixed strength, so that each unit of the solution decomposed by a hard water may represent a definite degree of hardness.

#### Standard Soap Solution.

In England standard soap solution is made from Castile soap, which should be made from olive oil and soda. This solution, however, is said to be unstable, and sodic oleate may be purchased for the purpose. About 13 grammes of

## WATER ANALYSIS

soap are dissolved in 500 c.c. of methylated spirits and 500 c.c. of pure water. 1 c.c. should serve to neutralize .001 gramme of carbonate of lime or be equivalent to 1 degree of hardness.

To test the solution 12 c.c. of the standard hard water are diluted to 70 c.c. in a burette. To this is added 1 c.c. at a time of soap solution, and for each addition the burette is shaken until a five minutes' lather persists. Each 12 c.c. of standard hard water requires 13 c.c. of soap solution, the extra 1 c.c. being that required for absolutely soft water. The actual figure will be less than 13, and the soap solution must be proportionately diluted. Thus if the soap solution used is only 12 c.c., each 12 c.c. requires diluting by  $13 - 12 = 1$  c.c.

Standard hard water is made by dissolving 1.11 grammes of pure fused chloride of calcium in water and diluting to 1,000 c.c. at  $15^{\circ}$  C., or 1 gramme of pure carbonate of lime is dissolved in 50 c.c. of  $\text{EHCl}$ ,<sup>1</sup> evaporated to dryness, dissolved in 50 c.c. of water and carefully neutralized with 5EAm.H.O. Each of these standards should for each c.c. be equivalent to 0.001 gramme of carbonate of lime.

### Standard Soap Solution in France.

This is made by dissolving 100 grammes of white curd soap—Marseilles soap—in 1,600 grammes of alcohol at  $90^{\circ}$  C. The soap is scraped into shreds and dissolved in the alcohol by heating to ebullition point. The solution is filtered, and to it is added 1,000 grammes of pure distilled water.

The solution before use is tested by the aid of a solution of calcium chloride,  $\text{CaCl}_2$ , of  $\frac{1}{4000}$  strength, or 0.25 gramme per litre of water, or with a solution of barium nitrate, of a strength 0.59 gramme per litre. These are normal solutions.

The apparatus required is as follows :—

(1) A bottle of about 80 c.cm. capacity marked at 10, 20, 30 and 40 c.cm. by circular marks.

<sup>1</sup> An E solution is one containing an equivalent weight in milligrammes per c.c. of water. Thus 5E.AmH.O. contains 175 m.g. or 175 grams in 1 c.c. of water ; 35 being the equivalent of ammonium hydrate. EH.Cl. means 36.5 m.g. of hydrochloric acid per 1 c.c. of water.



## WATER SOFTENING AND TREATMENT

(2) A burette graduated so that a length containing 2.4 c.cm. shall be divided in 23 equal parts. Each division represents a degree, but in order that for each test the burette shall be filled to the top division, there is a space between this circular mark and the zero division sufficient to contain the amount of soap solution necessary to maintain a persistent lather on 40 c.cm. of pure water. The following divisions of the burette then represent exactly the quantity of soap solution destroyed by the salts in the water. The little extra solution is necessary to form a persistent lather even with distilled water, and represents the amount of solution needed by the water in any sample as distinct from the salts in that water.

(3) A bottle of the soap solution.

(4) A bottle flask of distilled water.

(5) A flask of oxalate of ammonia containing 166.66 grammes of oxalate per litre or a solution of  $\frac{1}{60}$ th.

(6) A flask of barium nitrate containing 2.14 per cent. of azotate.

(7) A pipette divided in tenths of a cubic centimetre.

(8) A globe flask gauged by a circular mark at the base of the neck.

A spirit lamp and stand, a glass, a glass stirrer, thermometer, and a flask of normal solution of nitrate of barium (0.59 grammes per litre), and one of nitrate of silver containing 2.78 grammes of silver nitrate per 100 of water.

To make a test 40 c.cm. of the water are placed in the flask and to it are added successive small amounts of solution from the burette. The flask is shaken at each addition until signs of a lather are seen. The solution of soap is then added carefully until the lather is persistent, when it should form a persistent thickness of half a centimetre, and should last ten minutes before it evanesces. The number of divisions of the burette of solution which have been used are the number of degrees of hardness of the water.

The soap solution is tested for strength with 40 cubic centimetres of the standard solution of calcium chloride or barium nitrate. This quantity should require 22 divisions in the burette of standard soap solution. If less than 22

## WATER ANALYSIS

degrees are required, the solution must be let down by adding about one twenty-third of its weight in water to correct the solution by one degree, when a new determination must be made until the correct solution is obtained.

In making a test a preliminary trial is made in a test tube with 20 to 25 grammes of water and 1 c.cm. of the soap solution. If when agitated the water goes milky without flocculent appearance, the water can be tested as it is. But if a flocculent formation is visible, the water is too much charged with salt and must be diluted by means of distilled water, so that the diluted mixture has less than 30° of hardness. The test being thus made the result must be multiplied by 2, 3, or 4 according as the dilution has been effected by adding 1, 2 or 3 volumes of distilled water.

It is usual in particular work to test the distilled water, which should not require more than one division of the burette of soap solution to set up a persistent lather.

If this is not so, the correction to be made is  $x = (n + 1)a - nA$ , where  $a$  is the degree found.  $A$  is the degree of the distilled water, and  $\frac{1}{n}$  is the ratio of mixture.  $x$  is the true degree of hardness.

To determine the constituents of the water in carbonic acid, lime salt and magnesium salt, the following trials must be successively made :—

(a) The degree of hardness of the natural water.

(b) The hardness after depositing the lime by means of oxalate of ammonia.

(c) The degree of hardness after having eliminated the carbonic acid and carbonate of lime by boiling.

(d) The degree of hardness after elimination by oxalate of ammonia of the lime carbonate not precipitated by boiling.

(a) having been found as already described, (b) is found by adding 2 c.cm. of  $\frac{1}{60}$ th solution of oxalate of ammonia to 50 c.cm. of water. After brisk agitation and half an hour precipitation the filtered liquor will be free of lime salts. The hardness is then found of 40 c.cm.

Test (c) is made by first boiling gently for half an hour a



## WATER SOFTENING AND TREATMENT

fresh sample of the water measured in a gauged bottle. The original measure is then made up by distilled water and the whole filtered to clear the deposited lime salt. Then the hardness of 40 c.cm. is found.

Test (*d*) is made by boiling and filtering 50 c.cm. of the water and adding 2 c.cm. of oxalate of ammonia, which precipitates what lime has been left by the boiling. Again filtering the hardness of 40 c.cm. is found.

From the hardness *c* a subtractive correction of 3 is made for the lime carbonate, which does not deposit by boiling. The corrected value is  $C_1 = C - 3$ .

Then *a* is the total hardness made up of the carbonic acid and all the salts of lime and magnesia.

*b* gives the salt of magnesium and the carbonic acid which remain after eliminating the lime. Then  $a - b = c =$  lime salts.

$C_1$  represents magnesium and calcium salts other than carbonates, whence  $a - C_1 = e =$  carbonate of lime and carbonic acid.

*d* finally represents the magnesium salts. The total analysis is thus—

$$\begin{array}{rcl}
 a = \text{CO}_2 & = & b - d = f. \\
 b = \text{CaCO}_3 & = & e - f = g. \\
 c = \text{CaSO}_4, \text{ etc.} & = & h - g \\
 & \text{or} & = c^1 - d \quad \left. \vphantom{c = \text{CaSO}_4, \text{ etc.}} \right\} = m. \\
 d = \text{MgCO}_3, \text{ etc.} & = & \quad \quad \quad d. \\
 & & \quad \quad \quad \hline
 & \text{Total} & a.
 \end{array}$$

The results in degrees are convertible into grammes per litre by multiplying by certain coefficients as follows :—

Chloride of Calcium . . . . .	0·0114
Carbonate of Calcium . . . . .	0·0103
Sulphate of Calcium . . . . .	0·0140
Chloride of Magnesium . . . . .	0·0090
Carbonate of Magnesium . . . . .	0·0088
Sulphate of Magnesium . . . . .	0·0125
Chloride of Sodium . . . . .	0·0120
Sulphuric Acid . . . . .	0·0082
Chlorine . . . . .	0·0073
Carbonic Acid . . . . .	0·005 litre.

## WATER ANALYSIS

Usually no great error will be made if all lime salts are assumed to be either carbonate or sulphate, and the only magnesium salt the sulphate.

Then the above supposititious sample will contain :—

of CO <sub>2</sub>	$g \times 0.005$ litres
Calcium Carbonate	$h \times 0.0103$ grammes
„ Sulphate	$i \times 0.0140$ „
Magnesium „	$d \times 0.0125$ „

Approximate determinations may be made by weight with commercial alcoholic soap solution, finding as above the total and the permanent hardness, diminishing the latter by 3° as a correction and multiplying by 0.013 grammes. This gives the sulphates and chlorides contained in 1 litre of water.

The difference between the total and the corrected permanent hardness is the approximate weight in centigrammes of carbonates in a litre of water.

But a full treatment of water analysis is beyond the scope of this book. Readers who wish to gain further information on this point are referred to works on chemistry, and particularly to the French of M. A. Taveau.<sup>1</sup>

TABLE III.  
SOLUBILITY OF GASES AND SALTS IN WATER.

Name.	Formula.	Molecular Wt.	Solubility per cent. at 0° C. and at 100°	Specific Gravity
Oxygen . . .	O	16	0.04 vols.	—
Hydrogen . . .	H	1	0.02	—
Carbon . . .	C	12	—	—
Sulphur . . .	S	32	—	2
Water . . .	H <sub>2</sub> O	18	—	1
Carbonic acid .	CO <sub>2</sub>	44	1.8 vols. at 0° C. 0.9 „ „ 20° C.	—
Sulphuric acid .	H <sub>2</sub> OSO <sub>3</sub>	988	—	—
Chlorine . . .	Cl.	35.5	—	—
Hydrochloric acid	H.Cl.	36.5	—	—
Calcium . . .	Ca	40	—	1.58

<sup>1</sup> *Épuration des Eaux*, par A. Taveau, Gauthier-Villars, to whom the above method is due.

# WATER SOFTENING AND TREATMENT

## TABLE III. (continued)

SOLUBILITY OF GASES AND SALTS IN WATER.

Name.	Formula.	Molecu- lar Wt.	Solubility per cent. at 0° C. and at 100°	Specific Gravity
Caustic lime . . .	CaO	56	—	—
Lime hydrate . . .	CaOH <sub>2</sub> O	74	0·14-0·09	—
„ carbonate . . .	CaOCO <sub>2</sub>	100	0·0036	2·7
„ bicarbonate . . .	CaO,2CO <sub>2</sub>	144	—	—
„ sulphate . . .	CaOSO <sub>3</sub>	136	·0212-·0162	2·93
„ aluminate . . .	CaOAl <sub>2</sub> O <sub>3</sub>	159	—	—
„ chloride . . .	CaCl <sub>2</sub>	111	400	—
Magnesium . . .	Mg.	24	—	1·74
Magnesia . . .	Mg.O	40	0·002	3·2
„ carbonate . . .	MgO,CO <sub>2</sub>	84	0·020	2·94
„ hydrate . . .	Mg.OH <sub>2</sub> O	58	—	—
„ sulphate . . .	MgOSO <sub>3</sub>	120	24·7-130	1·75
„ chloride . . .	MgCl <sub>2</sub>	95	200-400	1·56
„ bicar- bonate . . .	MgOH <sub>2</sub> O 2(CO <sub>2</sub> )	146	—	—
Sodium . . .	Na	23	—	0·97
Soda, caustic . . .	HNaO	40	61	2·13
„ carbonate . . .	Na <sub>2</sub> CO <sub>3</sub>	106	7-45	2·5
„ bicarbonate . . .	HNaCO <sub>3</sub>	84	7	—
„ chloride . . .	NaCl.	58·5	35-40	2
„ sulphate . . .	Na <sub>2</sub> O.SO <sub>3</sub>	142	5-42	2·63
Potassium . . .	K	39	—	0·865
Caustic potash . . .	K.H.O.	56	200	2·04
Carbonate of potash . . .	K <sub>2</sub> CO <sub>3</sub>	138	83-153	2·26
Sulphate „ „ . . .	K <sub>2</sub> OSO <sub>3</sub>	174	10	2·66
Bicarbonate „ „ . . .	H.K.CO <sub>3</sub>	100	20	—
Chloride „ „ . . .	K.Cl.	74	29-59	1·94
Barium . . .	Ba	137	—	—
„ chloride . . .	BaCl <sub>2</sub>	208	35-60	2·66
„ oxide . . .	BaO	153	—	—
„ hydrate . . .	BaOH <sub>2</sub> O	171	5-10	1·66
„ aluminate . . .	BaOAl <sub>2</sub> O <sub>3</sub>	255	—	—
„ sulphate . . .	BaOSO <sub>3</sub>	233	Insoluble	4·73
„ carbonate . . .	BaOCO <sub>2</sub>	197	„	—
Aluminium . . .	Al.	27·4	—	2·6
Alumina . . .	Al <sub>2</sub> O <sub>3</sub>	103	—	3·9
Aluminium Sulphate . . .	Al <sub>2</sub> 3SO <sub>4</sub>	343	33-89	1·6
Alum . . .	Al <sub>2</sub> K <sub>2</sub> 4SO <sub>4</sub>	517	9·5-357	1·72
Ammonium Chloride . . .	HN <sub>4</sub> Cl	53·5	35-100	—
„ Carbonate . . .	2NH <sub>4</sub> CO <sub>3</sub>	96	20-volatile	—
„ Sulphate . . .	2NH <sub>4</sub> SO <sub>4</sub>	132	66-100	—

# WATER ANALYSIS

TABLE IV.  
BOILING-POINTS OF SALT SOLUTIONS.

	C.°	F.°
Barium Chloride, Saturated . . . . .	104.4	220°
Potassium Carbonate „ . . . . .	135.0	275
Sodium „ . . . . .	106.0	222.8°
„ Chloride . . . . .	108.4	227.1

The following is the form of analysis asked for by Mather & Platt in connexion with their Archbutt-Deeley process.

## PARTICULARS AND ANALYSIS OF HARD WATER.

SOURCE OF SUPPLY :

PURPOSES FOR WHICH THE SOFTENED WATER IS REQUIRED :

ANALYSIS : GRAINS PER GAL.

- Total Solids (dry at ) . . . . .
- Lime (Ca O) . . . . .
- Magnesia (Mg O) . . . . .
- Sulphuric Anhydride (S O<sub>3</sub>) . . . . .
- Chlorine (Cl) . . . . .
- Alkalinity, calculated as Carbonate of  
Lime (Ca C O<sub>3</sub>) . . . . .

REMARKS :

## CHAPTER VIII

### APPARATUS GENERALLY IN COMMERCIAL USE

TO carry out the process of water softening requires a certain amount of apparatus, which must have space to stand in. The simplest and minimum apparatus consists of two tanks each holding as much water as will be consumed while the softening process is in progress in the other tank. In this simple system the reagent already prepared is added to the one tank of hard water and the whole thoroughly stirred up with the deposit at the bottom. Some deposit must always be left, as it hastens the progress of sedimentation.

The tank is then left to settle, and the capacity of the tank in use must obviously be so great that it will serve the supply until sedimentation has cleared the water in process of softening below the draw-off point. Clearly shallow tanks are indicated, for a shallow tank will clear more quickly than one of greater depth. This system demands considerable area and leads the engineer to seek for accessory means of minimizing space. One such means is the floating take-off or outlet. This consists of a jointed pipe and float arranged like a ball valve float with an opening to the tubular arm of the float, maintained just under the water surface. Let a tank 20 ft. long be supposed of such area that its level is lowered 3 inches by the demand for water, in the same time that sedimentation goes on to the extent of say 4 inches. Then in one hour after mixing the reagent there will be 4 inches of clear water in the tank, and if the take-off is then started the sedimentation point will always be more than 4 inches below the level of the floating outlet. A second idea to secure the same end would be to use a number of



## APPARATUS IN COMMERCIAL USE

shallow tanks superposed. There are obvious inconveniences to this method, not the least of which is that the mud space at the bottom of each tank must be nearly as great as that at the bottom of a deep tank.

The problem is solved in practice by the adoption of a continuous process. The stream of water to be softened is split into two streams, one of which is turned through a vessel containing caustic lime. The water takes up a full dose of this in solution and, passing on, reunites with the main stream in a suitable mixer which may be in the form of a trough with lateral divisions alternately projecting partly across the trough from the two sides and serving to turn and mix the water, which then falls to the settling tank and may be drawn off by a float outlet at the extreme end of the tank. Circulating currents are stopped by suitable diaphragms. Or the settling tank may be divided into a number of shallow tray-like divisions inclined or horizontal, each of which serves to receive the sediment of a moving sheet of water only perhaps 3 or 4 inches deep. Sludge taps serve to blow out the deposit when sufficient. All the regular apparatus sold on the market consists of some modification or application of these principles with a view to effecting complete purification in a minimum of space and time. Caustic lime can always be added in the way above described, for the proportion of water can be adjusted which flows by the lime tank, and if care is taken to provide an excess of lime the amount carried off by the water will always be a certain fixed weight per gallon.

For soda and the more soluble reagents a small tank of the salt solution must be provided that will run empty in about the time necessary, or some means provided so that in a continuous process the correct amount of soda is added.

In some apparatus the chemicals of all sorts are added in a dry state to the water by means of a measuring wheel rotated by the water supply, the chemicals being mixed by agitation before the water reaches the depositing tank.

When a carbonate water is first treated the carbonate of lime separates out in a colloidal condition like thin blue

## WATER SOFTENING AND TREATMENT

starch, and this will pass through filters untouched. Later, and more quickly if heated, it begins to crystallize, and according to Professor Wanklyn, will settle through  $\frac{3}{4}$  inch of water in twenty-five minutes, and it requires eight hours to settle 20 inches when cold. Mixing in old deposit hastens the action, and it is assisted by bringing in the freshly-treated water from below.

Magnesia is even more gelatinous than the carbonate of lime. Even with large apparatus some sediment fails to deposit, and many apparatus employ a finishing filtration of closely woven cotton bags, wood-wool or sponge, the most efficient being perhaps those in which the water flows upwards against the filtering surface, and the deposit is free to drop off by gravity or to be forced off occasionally by a reverse flow.

In mixing lime water about 97 grains of caustic lime will dissolve in water at  $32^{\circ}$  F. =  $0^{\circ}$  C., 91 grains per gallon at  $59^{\circ}$  F. =  $15^{\circ}$  C., 70 grains at  $111^{\circ}$  F. =  $44^{\circ}$  C., and only 40 grains at  $212^{\circ}$  F. =  $100^{\circ}$  C. According to the temperature of the water, so must the proportion sent through the lime tank be divided. Soda is recommended by Mr. Stromeyer to be best supplied by an iron pump from a tank in which from time to time a definite weight of soda is put with a definite volume of water. Weirs, scoop wheels, cocks are all used, and the division of the supply to the lime tank may be made by a shifting plate of metal movable so that a different proportion may be made to pass either side as required. All these and other details are found in some or other of the various apparatus described in Chapter IX.

No matter what chemicals may be selected, the apparatus employed will be the same. The principle enunciated by Dr. Clark underlies the action of all, and all apparatus represents after all different ways of carrying out the same thing.

In selecting a few only out of the many the author wishes to disclaim any intention of putting any apparatus forward as better than others not mentioned. Those described are put forward as types or variants of a general design, and will appeal to users in proportion as their particular arrangement

## APPARATUS IN COMMERCIAL USE

or mechanism suits the conditions which the user may have to meet.

It is necessary to state these facts, because there are a large number of apparatus, and this book is not a catalogue of the whole number, and in brief some few must be chosen for the purpose of description, and those selected happen to have most readily come under the author's notice at the time Chapter IX was written.

The cost of water softening plant per 1,000 gallons treated per hour may be generally set down at £100 to £150, the smaller plants costing more per unit of capacity than larger plants. As with soft water a boiler may be worked continuously for long periods, it will be cheaper to lay down a softening plant than to put down a spare boiler, which would be required in the absence of the plant. Thus in every way the softening of water will produce a handsome return.

## CHAPTER IX

### EXAMPLES OF WATER-SOFTENING APPARATUS

#### The Archbutt-Deeley Process

**I**N this process, in addition to the softening process there is a further treatment of the softened water with carbonic acid gas for the purpose of preventing the subsequent deposit in the pipes of a peculiar gelatinous hydrate, which is found frequently to occur and chokes the pipes.

To prevent this deposit the softened water is charged with carbonic acid gas produced in a coke stove, and the particles of lime or magnesia which would deposit in the pipes are converted into bicarbonates. The water is thereby again naturalized or it acquires a small degree of temporary hardness.

For 3,000 gallons per hour or less one softening tank and a storage tank are necessary.

For 10,000 gallons per hour not fewer than three tanks are needed.

Hard water being turned into one tank, Figs. 1, 2, 3, the caustic lime and carbonate of soda are weighed out and boiled together in the little chemical tank by means of live steam. The large tank having now filled to a gauge mark the inlet valve is closed and a steam blower or aspirator is put into action to draw water from about the middle height of the tank and deliver it through a horizontal perforated pipe placed about four-fifths down the tank depth. Into the pipes of this circulating system the chemical solution is allowed slowly to run and the chemicals are evenly diffused throughout the tank. This done, any alumino-ferric is run in in the form of a standard solution. Air is then admitted to the steam blower and a three-way cock being reversed,



# WATER-SOFTENING APPARATUS

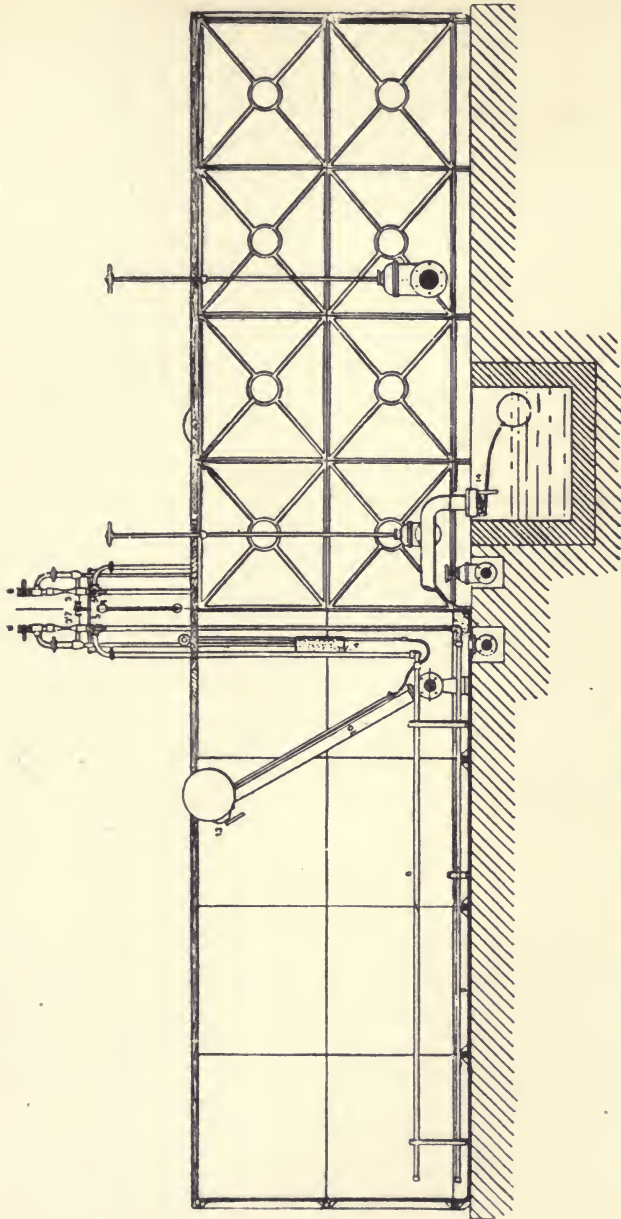

FIG. 1. THE ARCHBUTT-DEELEY WATER SOFTENER. ELEVATION.



## WATER SOFTENING AND TREATMENT

the air is discharged into the bottom of the tank through perforations in the lower side of a pipe laid along the tank bottom. This air stirs up the old deposit left in the tank for about ten minutes, and in an hour the tank will have cleared to a depth of perhaps 6 ft. The water is then tested by adding a few drops of a solution of silver nitrate to some of the water in a small white basin.

If too little lime has been employed, the water will turn milky white ; if too much, a dark brown colour will be pro-

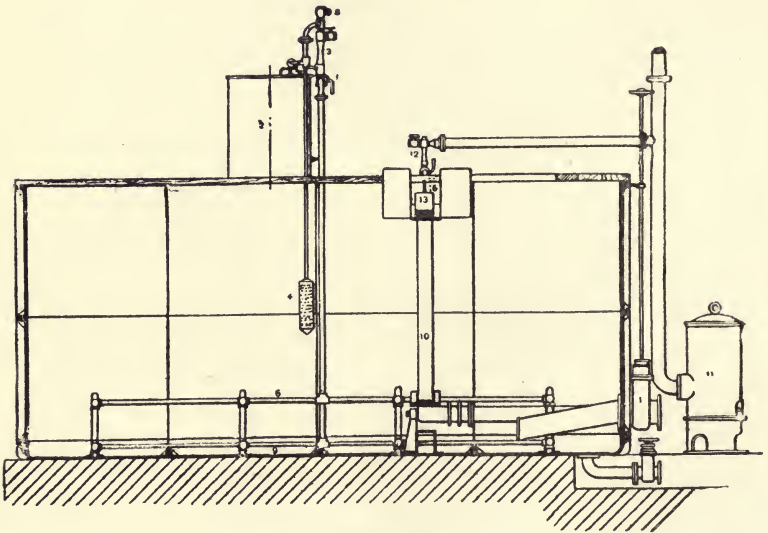

FIG. 2. END ELEVATION.

duced. Correctly treated water will show a faint straw colour, and so long as this is perceptible the less of it the better. Water is drawn off by a hinged floated pipe, into which, at the upper end, is forced by a steam blow carbonic acid gas from a small stove. The gas is carried down the pipe, which is rectangular and fitted with baffle plates, and re-carbonates the water in the process. The finished product is discharged into the small supply tank.

A final test of the water is made by means of phenolphthalein, which will turn pink in water containing free

# WATER-SOFTENING APPARATUS

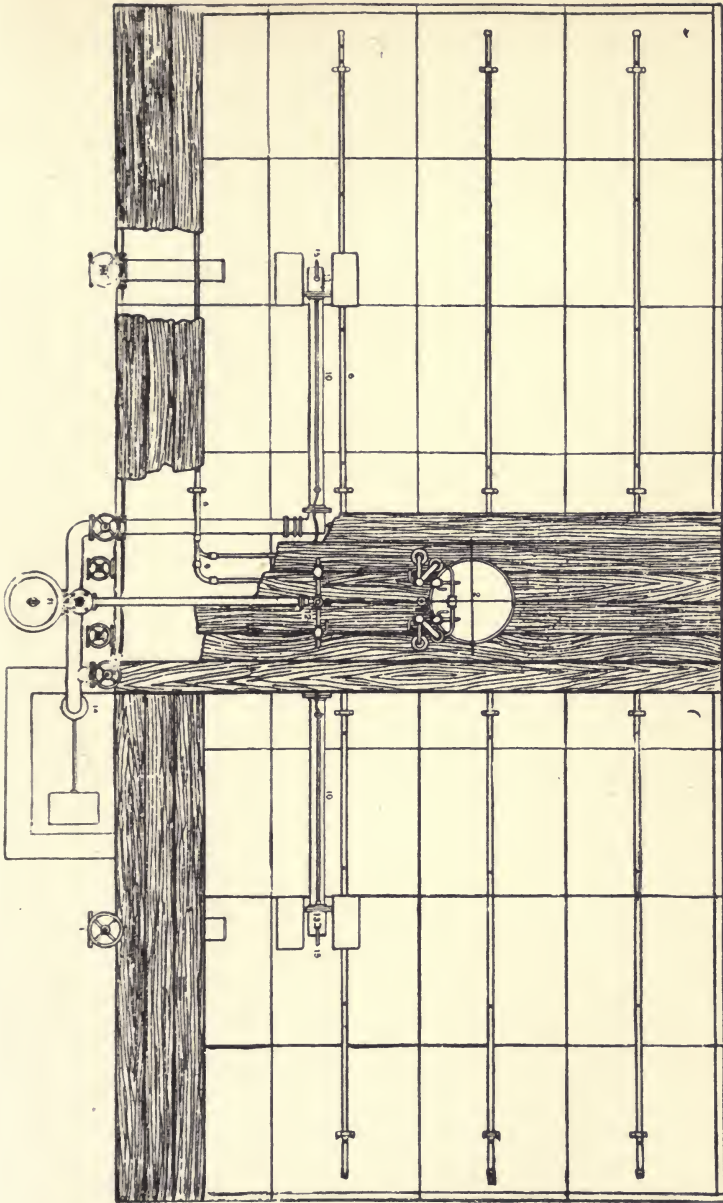

FIG. 3. PLAN OF THE ARCHBUTT-DEELEY WATER SOFTENER (Mather & Platt).

## WATER SOFTENING AND TREATMENT

alkali but remains unchanged if there is the least trace of carbonic acid in excess. Re-carbonating is not always necessary.

The mud deposited in the softening tank is variously removed by a sludge cock, by sweeping it through mud doors or by raising it with a steam lifter into a cart containing furnace ashes, which let the water pass and intercept the chalky mud.

The apparatus described is made by Mather & Platt, to whom is due the Table V., showing the estimated cost of softening a number of different waters per 1,000 gallons.

While some waters are costly to soften, it is well remarked that the costliness is often a measure of the necessity, and that it may still be cheaper to soften a bad water than to purchase water which may be little or nothing better and must still be softened.

It is indeed a bad water that costs 3*d.* per 1,000 gallons to soften and few public water supplies can be purchased for even 6*d.*

In Table VI. are given the dimensions of tanks necessary for various quantities of water to be treated per hour. The figures are based on the conditions enunciated at the head of each division of the table.

The steam used by the blower only raises the temperature of the water about 2° F. and is not all lost, for it returns more or less to the boiler.

TABLE V.

SHOWING THE VARIABLE CHARACTER OF WATER FROM DIFFERENT SOURCES AND THE CONSEQUENT DIFFERENCE IN THE COST OF SOFTENING.

SOURCE . . . . .	GRAINS PER GALLON.										Disused Shaft.	Well.	Brook.	Clay Pit.
	Well.	River.	River.	River.	Canal.	Well.	Brook.	Well.	Well.	Well.				
Calcium Carbonate ( <i>Carbonate of Lime</i> ) . . . . .	10	8.74	13.15	16.39	10.99	9.19	2.06	9.41	8.3	1.39				
Magnesium Carbonate . . . . .	4.76	2.78	.33	.31	2.76	1.4	.94	1.	2.82	1.78				
Sodium Carbonate . . . . .	4.19	—	—	—	—	—	—	—	—	—				
Calcium Sulphate ( <i>Sulphate of Lime</i> ) . . . . .	—	3.26	—	4.3	2.99	12.17	47.34	22.91	40.61	54.14				
Magnesium Sulphate . . . . .	—	—	1.96	1.28	12.41	7.05	5.7	15.9	22.25	22.46				
Sodium Sulphate . . . . .	4.15	1.44	.3	—	18.96	—	9.98	—	2.65	28.96				
Magnesium Nitrate . . . . .	—	—	—	—	—	13.69	—	11.5	—	—				
Sodium Nitrate . . . . .	—	—	.96	small	—	—	—	—	small	—				
Magnesium Chloride . . . . .	—	—	—	—	—	.64	—	2.08	—	—				
Sodium Chloride . . . . .	1.65	2.72	2.06	3.05	5.28	6.3	6.77	5.05	6.35	5.28				
Silica . . . . .	—	.43	.39	.42	.31	.62	.62	.9	.84	.36				
Total Lime (Ca O) . . . . .	24.75	19.37	19.15	25.75	53.7	51.06	73.41	68.75	83.86	114.37				
Total Magnesia (Mg O) . . . . .	5.6	6.24	7.36	10.95	7.39	10.16	20.64	14.7	21.39	23.07				
CALCULATED HARDNESS ( <i>i.e.</i> Total Lime and Magnesia, calculated to Carbonate of Lime) . . . . .	2.28	1.33	.81	.58	5.48	7.02	2.36	9.82	8.81	8.38				
Approximate Cost of Chemicals required for softening 1,000 gallons . . . . .	15.65	14.5	15.16	20.99	26.77	35.53	42.7	50.57	60.02	61.95				
Approximate Cost of Chemicals required for softening 1,000 gallons . . . . .	0.2d.	0.5d.	0.4d.	0.6d.	1.2d.	2d.	2.8d.	3.1d.	3.6d.	4.2d.				

NOTE.—The above estimates of cost are based upon the following prices, viz. :—  
 Quicklime . . . . £1 per ton. 1  
 58% Alkali . . . . . £4 per ton.



# WATER SOFTENING AND TREATMENT

## TABLE VI.

SHOWING NUMBER AND SIZE OF TANKS REQUIRED FOR VARIOUS QUANTITIES, UNDER ORDINARY CONDITIONS.

Tank calculated to fill in twenty minutes, and to empty in twenty minutes into reserve tank, allowing ninety minutes for treating and settling.

CAPACITY.	Number and approximate Dimensions of Tanks.	Hard Water Supply required per min. Gallons.	Diam. of Inlet Pipes.	Diam. of Outlet Pipes.
Gallons per hour.				
600	1.. 7' 0" × 7' 0" × 7' 0"	70	3"	3"
1,000	1.. 8' 0" × 8' 0" × 8' 0"	120	4"	4"
1,500	1.. 12' 0" × 8' 0" × 8' 0"	180	4"	5"
2,000	1.. 12' 0" × 8' 0" × 10' 0"	240	5"	6"
2,500	1.. 12' 0" × 10' 0" × 10' 0"	300	6"	6"
3,000	1.. 12' 0" × 12' 0" × 10' 0"	360	6"	7"

*Each* tank calculated to fill in twenty minutes, and to give continuous delivery, allowing ninety minutes for treating and settling.

4,000	2.. 12' 0" × 12' 0" × 10' 0"	360	6"	4"
5,000	2.. 13' 6" × 13' 6" × 10' 0"	450	7"	4"
6,000	2.. 15' 0" × 15' 0" × 10' 0"	560	8"	4"
7,000	2.. 16' 6" × 16' 6" × 10' 0"	680	8"	5"
8,000	2.. 17' 6" × 17' 6" × 10' 0"	765	9"	5"
9,000	2.. 18' 6" × 18' 6" × 10' 0"	855	10"	5"
10,000	2.. 19' 6" × 19' 6" × 10' 0"	950	10"	5"
12,500	3.. 15' 6" × 15' 6" × 10' 0"	600	8"	6"
15,000	3.. 17' 0" × 17' 0" × 10' 0"	720	9"	6"
17,500	3.. 18' 0" × 18' 0" × 10' 0"	810	9"	7"
20,000	3.. 19' 6" × 19' 6" × 10' 0"	950	10"	7"
25,000	3.. 21' 6" × 21' 6" × 10' 0"	1,160	10"	8"
30,000	3.. 23' 6" × 23' 6" × 10' 0"	1,380	12"	9"
35,000	4.. 21' 0" × 21' 0" × 10' 0"	1,100	10"	9"
40,000	4.. 22' 6" × 22' 6" × 10' 0"	1,270	12"	10"
45,000	4.. 24' 0" × 24' 0" × 10' 0"	1,400	12"	10"
50,000	4.. 25' 0" × 25' 0" × 10' 0"	1,560	12"	12"
60,000	4.. 27' 6" × 27' 6" × 10' 0"	1,850	14"	12"

In cases where the supply available is only equal to the demand, larger tanks, or more of them than given above, are required.



## WATER-SOFTENING APPARATUS

### The Criton Apparatus.

This apparatus is made by the Pulsometer Engineering Co., Ltd.

In this apparatus the quantities of the reagents delivered are measured by the displacement of plungers, the submerged bulk of which can be accurately adjusted to give the required proportions of reagents to hard water, and cannot afterwards vary from any accidental cause. Neither the lime water nor the softened water, before settlement, passes through ball valves or other openings liable to choke.

The amount of reagent displaced can be varied in a few seconds by means of the nuts which govern the submersion of the plungers.

The proportion of reagents to hard water remains the same, no matter at what speed the plant is run, and the speed of the plant is controlled by a single valve on the hard-water inlet.

The reagents and the hard water are admitted at the same time and place, and thorough mixing is thus secured.

Complete removal of suspended matter is obtained by the use of a filter with a granular filling.

This filter bed is cleaned by a reverse current of water, thus avoiding the trouble and expense of removing the dirty filtering material for washing or renewal.

The attention required is that of one man for half-an-hour to an hour once every twelve hours, according to the size of the plant.

Reference to the diagram (Fig. 4) shows that the hard water is supplied intermittently by means of a syphon trap in the upper float tank.

A float in this top tank actuates a displacement plunger in the lime tank and a smaller plunger in the little soda tank which is kept full of soda solution by means of a ball valve.

The lime tank which contains an excess of lime is kept full by a ball valve, water entering at the conical base and rising through the lime.

While the hard water is filling the top syphon tank the

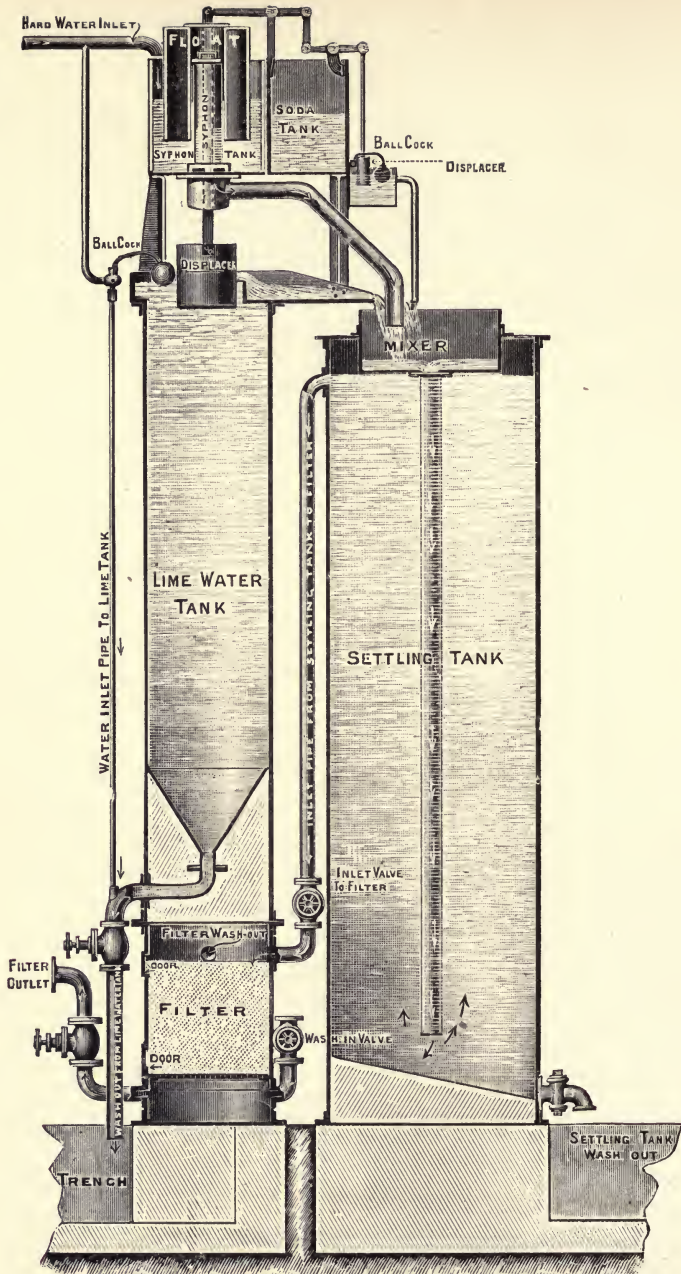

FIG. 4. THE CRITON WATER SOFTENER (Pulsometer Co.).

## WATER-SOFTENING APPARATUS

lime and little soda tanks are filled by their respective ball valves and when the syphon discharges to the mixer the float falls and depresses the lime and soda plungers and the chemicals flow to the mixer in even proportion with the hard water. The mixer discharges by a down pipe to the base of the settling tank, stirring up the older deposit there and precipitation is facilitated by this and by the precipitate constantly descending from the upflowing water.

The settling tank discharges at the top into the filter.

### The Doulton Apparatus.

In this apparatus—the low form of which is illustrated in Fig. 5—the hard water enters by a ball valve over a water wheel, which drives the stirrer at the bottom of the reagent tank.

The day's supply of chemicals is placed in a hopper through which the reagent tank is filled from the stop-cock, thus forming a saturated solution, the supply of which is automatically regulated in the following manner :—

The hard water flows from the tank containing the water wheel into the Regulating Box, thereby raising a float, which opens a valve and permits the solution from the reagent tank to flow in. The hard water and reagents then mix together by means of the swirl made in the circular funnel leading to bottom of settling tank ; there all impurities are deposited. The softened water finally rising through the filter bed to the outlet.

Should the supply of hard water cease or be reduced, the float will lower itself, and thus regulate the flow of reagent automatically in proportion to the water to be treated, as shown in Fig. 6.

The reagent and settling tanks are provided with sludge cocks and pipes for cleansing purposes, and all working parts are accessible by means of the platforms and ladders as shown.

Softeners have all the same action and are variously adapted according to the waters to be treated. The low shapes are designed for use where height is limited and



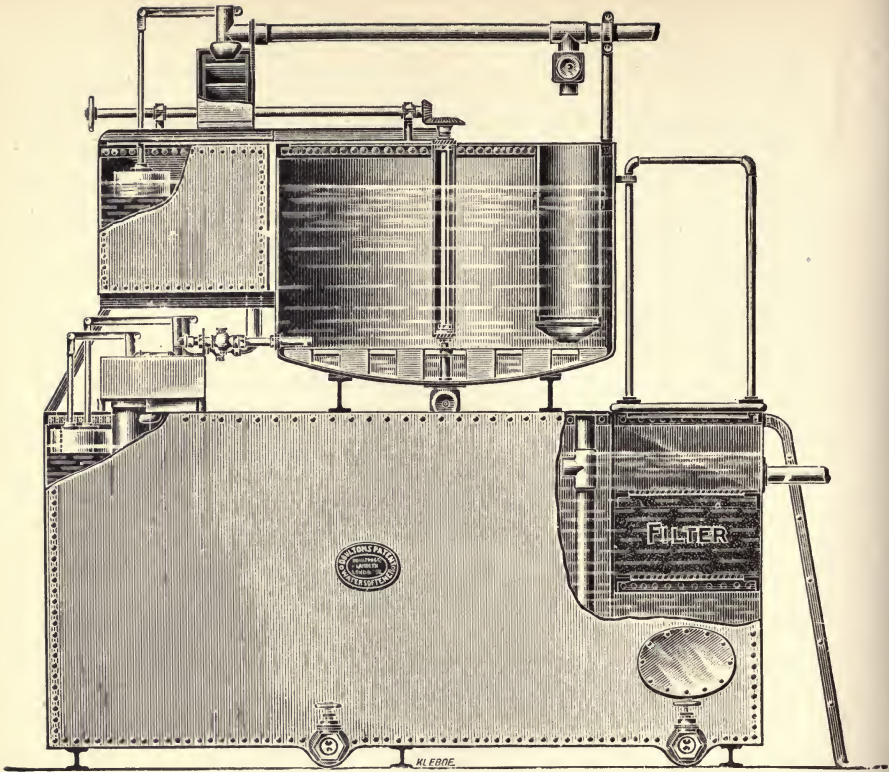

FIG. 5. THE DOULTON SOFTENER (Doulton & Co.).

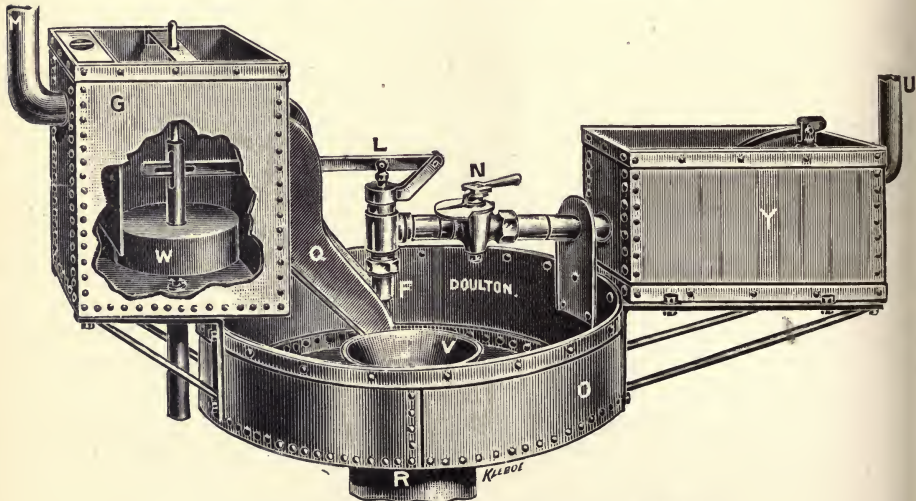

FIG. 6. DOULTON SOFTENER (DETAIL OF MIXER).

## WATER-SOFTENING APPARATUS

ground space available (or for special positions, such as on joists over boilers), whilst the tall shapes are for use where ground space is limited and height available. These latter can be made to deliver at any height required, and the low shape can be designed to suit any available space.

These softeners require attention once a day for filling in reagents, which occupies very little time, and for which no skilled labour is necessary.

In the automatic cut-off arrangement just referred to (Fig. 6) the hard water is delivered through the pipe M into the regulating box G and passes out through the shute in front of same, in its passage raising the float W and consequently opening the reagent valve L to an amount proportionate to the quantity of water passing through box G. The reagent is supplied through the pipe U and the tank Y, the regulator N and valve L; thus a definite quantity of reagent is supplied to a definite quantity of water, the reagent falling into the mouth of the shute Q. They are mixed by being whirled round the standing outlet V, over which the water and reagent fall and are led by the pipe R to the bottom of the settling tank.

TABLE VII.

### APPROXIMATE SIZES OF DOULTON APPARATUS.

			LOW SHAPE.		
To Soften.			Ground Space.		Total Height.
galls. per hour,			by		
300			8 ft. 0 in.	5 ft. 0 in.	8 ft. 0 in.
500	"	"	10 ft. 0 in.	6 ft. 0 in.	9 ft. 3 in.
800	"	"	12 ft. 0 in.	7 ft. 0 in.	8 ft. 8 in.
1,500	"	"	13 ft. 0 in.	10 ft. 0 in.	10 ft. 2 in.
2,000	"	"	15 ft. 0 in.	10 ft. 0 in.	11 ft. 6 in.
4,000	"	"	17 ft. 0 in.	12 ft. 0 in.	14 ft. 6 in.
6,000	"	"	20 ft. 0 in.	14 ft. 0 in.	15 ft. 2 in.

			TALL SHAPE.		
To Soften.			Ground Space.		Height of Delivery.
galls. per hour,			by		
400			6 ft. 0 in.	4 ft. 0 in.	10 ft. 6 in.
1,200	"	"	8 ft. 0 in.	5 ft. 6 in.	18 ft. 0 in.
2,000	"	"	9 ft. 0 in.	6 ft. 0 in.	23 ft. 0 in.
4,000	"	"	12 ft. 6 in.	6 ft. 0 in.	27 ft. 6 in.
6,000	"	"	13 ft. 0 in.	6 ft. 0 in.	34 ft. 6 in.



## WATER SOFTENING AND TREATMENT

The above sizes can be varied to suit any available position. They are given for softeners worked on lime and carbonate of soda principle, to serve as a general guide to the floor space and height requirements of softening apparatus.

### The Guttman System.

This system (Fig. 7) is worked by the Babcock & Wilcox Co. of London. It combines heat treatment for dealing with the temporary hardness and soda to treat the permanent hardness.

The apparatus consists in the main of a soda tank, a reaction tank, a filter box and soft-water tank which is so arranged that the drawing off of soft water regulates the amount of soda added to the incoming stream of hard water. The process is thus of the continuous order. The filter is usually wood-wool.

The apparatus can be used with any softening process, employing either lime, caustic soda, or other chemical; but the use of carbonate of soda (alkali), or of mono-silicate of soda, is preferred.

Either exhaust or live steam can be employed. When exhaust steam is available this is utilized for heating the water to a temperature of 180° F. to 200° F., thus effecting a saving in fuel consumption. A small amount of live steam is sometimes required to bring the temperature of the water up to boiling point.

The apparatus is thus a water softener and feed-water heater combined, the pure water being fed into the boilers at a high temperature.

Grease contained in the exhaust steam is trapped by the wood-wool in the filter tank.

The apparatus occupies space as below—

Quantity treated per Hour.	Length. ft. in.	Width. ft. in.	Height. ft. in.
300 Gallons ..	13 10 ..	3 0 ..	7 6
1,000 do. .. ..	13 10 ..	3 6 ..	8 0
3,000 do. .. ..	16 0 ..	5 3 ..	10 6
6,000 do. .. ..	17 4 ..	5 3 ..	13 0
10,000 do. .. ..	19 4 ..	7 6 ..	16 0

# WATER-SOFTENING APPARATUS

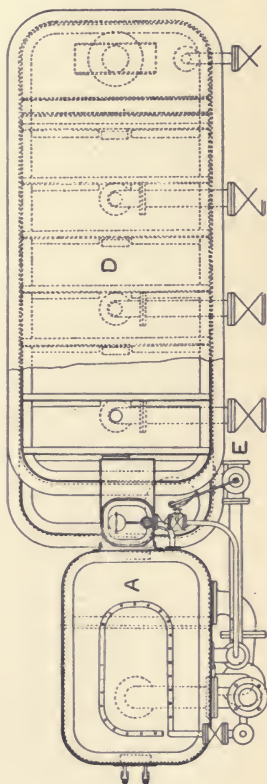
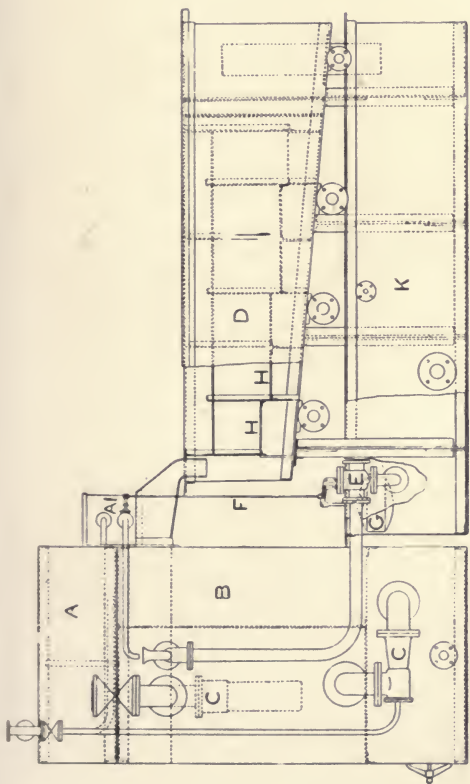
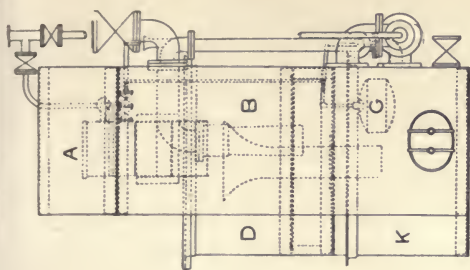

FIG. 7. THE GUTTMANN SOFTENER (Babcock Co.).

## WATER SOFTENING AND TREATMENT

As shown in Fig. 7, it consists of a tank A, into which the chemical required for the day is put, and the tank is then filled with water. Underneath is the reaction tank B. The hard water enters at E, the admission being controlled by a valve which is actuated by a rod F, connected to the float G in the soft-water storage tank K. A similar valve, connected to the same float, controls the admission of the chemical solution, and between this valve and the chemical tank a cock is interposed to provide for any variation in the strength of the chemical solution or in the composition of the water. The hard water and soda solution in the reaction tank are raised to boiling point, and at the same time thoroughly agitated by means of one or more steam injectors C.

The water then flows over a weir into the filter tank D, which has divisions reaching alternately to within a few inches of the bottom and top, forming compartments, which compel the water to take a zig-zag course. A perforated plate H forms the bottom of each compartment, which is filled, as a filtering medium, with wood-wool compressed to the required density; a similar perforated plate being placed on the top of the wood-wool in each compartment. Below the bottom perforated plates is a settling chamber for the interception of sludge, which is removed by opening the blow-off cocks attached. Thus a free passage way is provided for the water, which leaves the filter in a perfectly clear state and flows into the storage tank K, from whence it can be drawn off.

The following example shows the results obtained with East London water :—

	Hard Water, grains per gallon.	Softened Water, grains per gallon.
Temporary hardness . . . .	14·2	3·7
Permanent            ,, . . . .	3·1	none
Total                   ,, . . . .	17·3	3·7

Of the 3·7 grains per gallon 2·7 grains are further precipitated by prolonged boiling in the boiler itself; the remaining 1·0 grain represents the solubility of calcium and magnesium carbonates.



## WATER-SOFTENING APPARATUS

The following test is advised by the makers to show whether the proper amount of soda solution is being employed—

A piece of litmus paper of neutral tint is dipped into the last compartment, say, twice a day. Upon withdrawal, the litmus paper should show a very faint blue colour, indicating that the water is slightly alkaline; if a darker colour is shown, less soda solution should be employed; if no colour, more solution should be run in.

### The Baker Apparatus.

This is an apparatus of the type which divides the treated water into numerous thin sheets for the purpose of reducing the distance through which deposit has to take place.

Fig. 8 represents the apparatus in elevation. The hard water enters by the pipe A and passes on to the tank B which is partitioned and contains in one part the soda solution, and in the other part the hard water, each compartment being provided with a valve which regulates the flow of liquid into the proportioning or measuring tank C. This measuring tank C has four compartments, and receives a constant supply of (1) hard water to be softened, (2) of lime water, and (3) of soda solution, the fourth compartment being open to the flow of liquids from the three other compartments, but when the storage cistern is full (not shown) a valve, operated by a float, closes at the bottom of this fourth compartment. The closing of this valve stops the flow of the liquids above-named until the level of softened water in the storage tank is lowered. The mixture of the hard water with lime water and soda solution immediately becomes turbid and passes down two sides of the settling tank EE by the segmental spaces PP, the heavier portion of the precipitate falling immediately into the cone H at the bottom of the settling tank, whence all deposits are discharged at intervals by opening the flushing valve J.

After passing down the two spaces PP the turbid water passes up into a central space V and branches off right and left, rising at an angle between the louvres of settling plates



## WATER SOFTENING AND TREATMENT

GG, which are about two inches apart, so that the sediment has only two inches of vertical distance to fall between each

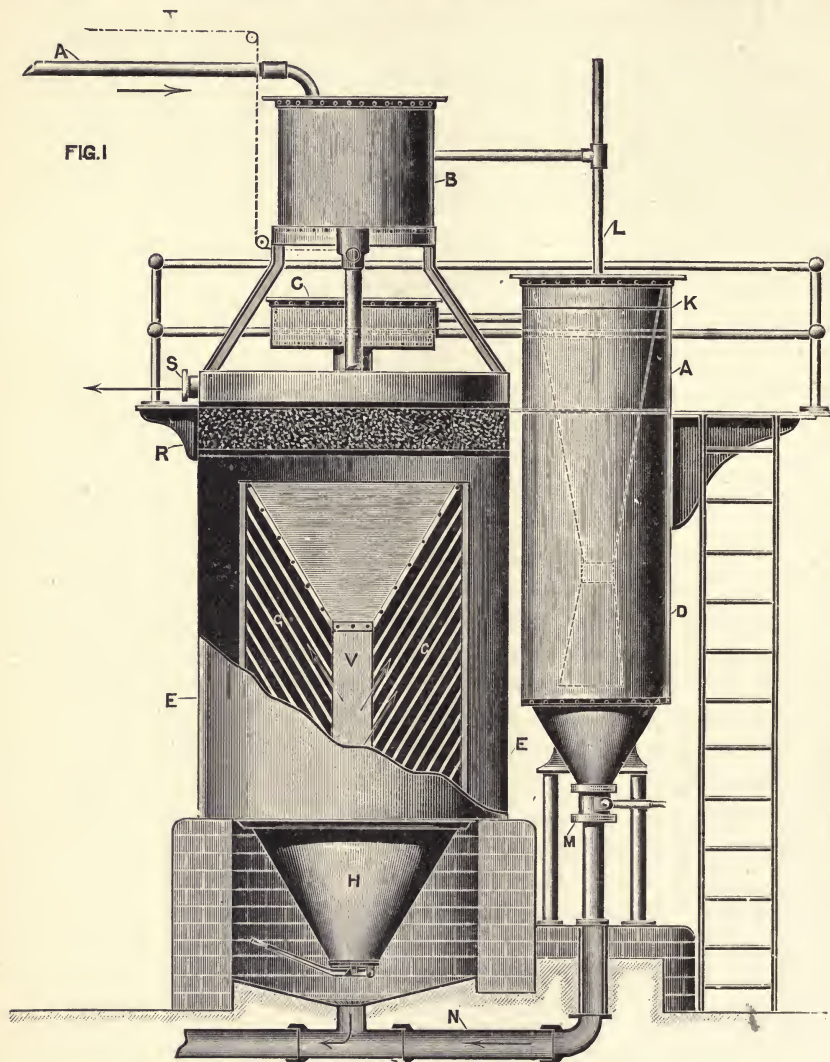

FIG. 8. THE BAKER SOFTENER (Baker).

pair of plates, and the settlement in even this small depth is claimed to be hastened by the attraction of the plates for



## WATER-SOFTENING APPARATUS

the particles in suspension ; consequently the passage between each pair of settling plates is found to clarify the formerly turbid water, which then passes upward through a fibre filter R, finally passing out at the delivery pipe S, which may be connected either to a storage tank or to service pipes. The preparation of lime water is effected in the vessel DD which is fitted with a perforated tray at K upon which the lime is placed, and where it gradually dissolves and is constantly stirred up from the conical bottom of the vessel by means of a current of air and water which passes down by the pipe L.

The clear lime water rises to the top between the external cylinder D and the internal cone, overflowing in a measured stream to the measuring tank C. A valve M at the bottom of the cone discharges undissolved lime and other impurities which settle there.

### The Reisert Softener.

The action of this apparatus will be evident from the illustration (Fig. 9). It consists of a lime saturator S, a soda chamber N, a water-distributing tank R, lime being slaked in the right-hand division. There is a reaction tank D and a filter F which is self-cleansing. The conical shape of the vessel S ensures a quick mixing action of the water which enters by way of the pipe V and a slow final movement which enables undissolved lime particles to settle back and leave the effluent clear to flow by the pipe W to the reaction chamber D by way of the mixing pipe E.

The *soda apparatus* N acts as follows. Whereas lime dissolves only in a definite proportion, there is almost no limit to the solubility of soda. A quantity of soda, therefore, that will suffice for one day, is dissolved all at once in the chamber N. The action of the soda apparatus is based on the fact that the soda solution has a greater specific gravity than water.

The water flows from the distributing tank R through the micrometer valve M—which is adjusted in accordance with the amount of soda required—into the soda chamber N

## WATER SOFTENING AND TREATMENT

and remains *always on the surface of the soda solution* (no mixing occurs) and displaces the same, through the small

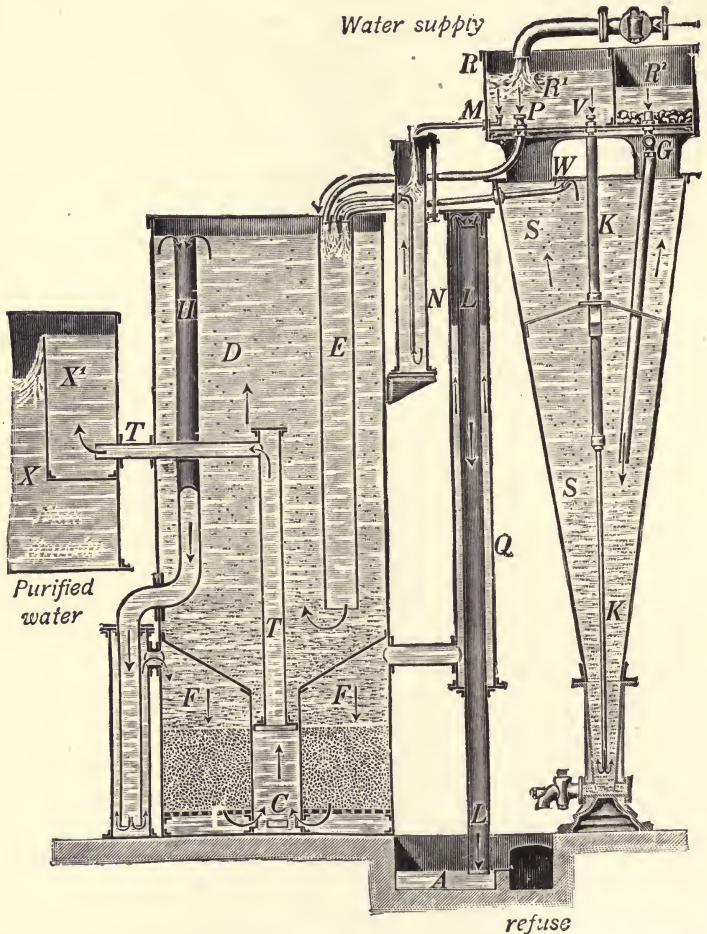

FIG. 9. THE REISERT SOFTENER (Royle).

pipe from the bottom upwards, and into the mixing pipe E, and finally into the reaction chamber D.

R is the water-distributing tank, and is supplied with the hard water to be treated by pipe and cock as shown ;

## WATER-SOFTENING APPARATUS

it is also provided with an overflow pipe. It is further provided with three micrometer valves at an equal height, first P for the inflow of the untreated water, the second V for the lime water, and the third M for the soda chamber. By arranging these three valves at an equal height, the quantities of water flowing from them are always proportionate or simultaneous and cease flowing in the event of the water supply ceasing altogether.

From the *lime-slaking division* R<sup>2</sup> the lime paste is conveyed in bulk to the bottom of the lime-saturator S through the short depending pipe.

The *reaction chamber* D thus receives, through the pipe E, the untreated water, lime water and soda water.

The water now overflows viâ the pipe H into the filter chamber F following the course of the arrows downward through the filter bed and upwards through the pipe T into the reserve tank X, in its course keeping constantly full the small tank X<sup>1</sup>. The height of the column of water in the pipe H will vary with the resistance of the filter bed, and as the latter becomes foul the water will rise higher in H. Similarly it will rise to an equal height in the annular pipe Q. Within the pipe Q a pipe L is arranged as shown, and as soon as the resistance through the filter bed reaches such a point as to cause the water to overflow this pipe L a SYPHON action is started, and instantly reverses the current through the filter bed, drawing backwards the clear water held in the small tank X<sup>1</sup> and thus automatically cleansing the filter, the sediment being discharged at L into the gully A. The small tank X<sup>1</sup> is proportioned to hold sufficient water thoroughly flush to the filter F and as soon as the tank is empty air enters viâ the pipe T and destroys the syphonic action. The filter then resumes its normal action and so continues until the fouling is again such as to cause the pipe L to overflow when the cleansing action is repeated.

The filtering material does not require renewing and never wears away.



## WATER SOFTENING AND TREATMENT

### The Bruun-Lowener System.

In this apparatus the water to be treated is led by a pipe into one of the chambers of an oscillating receiver C.

When this chamber is filled the receiver tips over, pouring its contents into the intermediate tank B below, and bringing the other chamber of the receiver below the orifice of the pipe K. Above the oscillating receiver is a semi-circular tank D, containing the chemicals, and in the bottom of this tank is a valve through which the chemicals fall into the chamber of the oscillating receiver. The receiver at every oscillation actuates the valve in the bottom of the tank D through a system of levers. The lift of the valve is regulated by two nuts fixed on the valve spindle, so that a given quantity of chemicals can be mixed with the water.

The lime milk in this apparatus has a strength of 10 per cent. ; the lime water used in other apparatus has only an average strength of 0.13 per cent. ; the lime milk therefore has a strength of nearly 100 times that of the lime water, making it possible to reduce the size of the tanks containing the lime in the same proportion. A further advantage claimed for lime milk is, that a certain quantity of fresh burnt lime is mixed with a certain quantity of water, a solution being obtained the strength of which is always known.

In order to keep the lime milk in constant motion an agitator is fixed inside the semi-circular vessel containing the chemicals, and the oscillation of the receiver C is utilized for driving the agitator.

The water and the chemicals in the mixing tank B are kept in motion by means of a plate S, fixed to the bottom of the receiver C. The mixture then passes from B into the heating chamber H, which is provided with a steam nozzle for either live or exhaust steam. The water is generally heated to a temperature of about 150° F. to facilitate the precipitation of the foreign matters. Where steam is not available the water can of course be treated cold.

From the heating chamber the water passes through the by-pass pipe G into the settling tank A, where precipitation



# WATER-SOFTENING APPARATUS

takes place. Before leaving the tank the water is passed

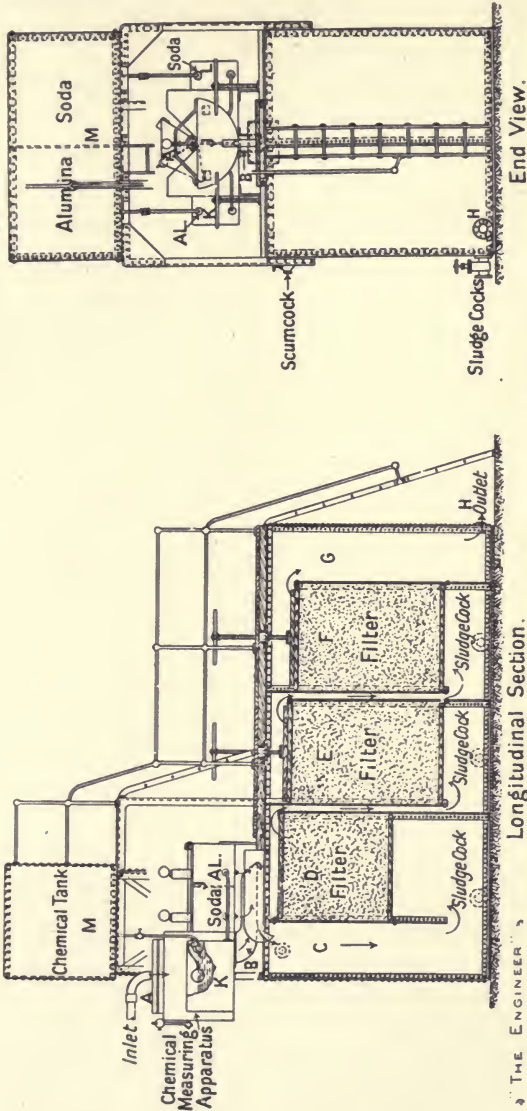

FIG. 10. BRUUN-LOWENER SOFTENER (Lassen & Hjort).

through the filter I, which is filled with wood-wool, packed tightly between two rows of wooden bars. The filter can

## WATER SOFTENING AND TREATMENT

be taken out and cleaned by removing the top bars, and the filtering material can be used over and over again, after having been properly cleansed. A sludge cock F is provided for drawing off the deposit.

The softened and purified water coming from the filter flows into the storage tank O at the end of the softener and is drawn therefrom. The flow of water to the oscillating receiver is regulated by means of a high pressure ball valve P fixed on the pipe K.

### The Desrumeaux Apparatus.

This apparatus (Figs. 11, 12) consists of three parts, viz., a saturator, a soda or reagent tank and a settling chamber.

The saturator is usually a cylindrical tank into which a portion only of the water is admitted. It contains a mixer actuated by a small water wheel driven by the water to be softened. The lime water is supplied, therefore, fully saturated with lime, for the water to be saturated rises up through the lime and past the rotating mixing blades or arms.

The soda tank is fitted with a device which scoops up a definite quantity of soda solution to suit the amount of water passing over the small water wheel. The lifter being worked by the wheel is thus automatically regulated. The mixed water finally passes to the base of the settling tank and travels upward between the blades or plates of multiple spiral cones arranged at such an angle that the deposit will slide down the blades and drop to the base of the vessel, whence it is discharged.

The illustration (Fig. 12) makes this more clear than words. The correct action depends simply upon the diversion of a suitable proportion of the water through the lime tank and the correct regulation of the soda lifter. Once fixed the process should continue correctly so long as the quality of the water remains constant. The mixing of the two waters takes place in the vertical central tube of the settling tank.

A filter of wood-wool is placed at the top of the settling tank to remove the last trace of deposit.

# WATER-SOFTENING APPARATUS

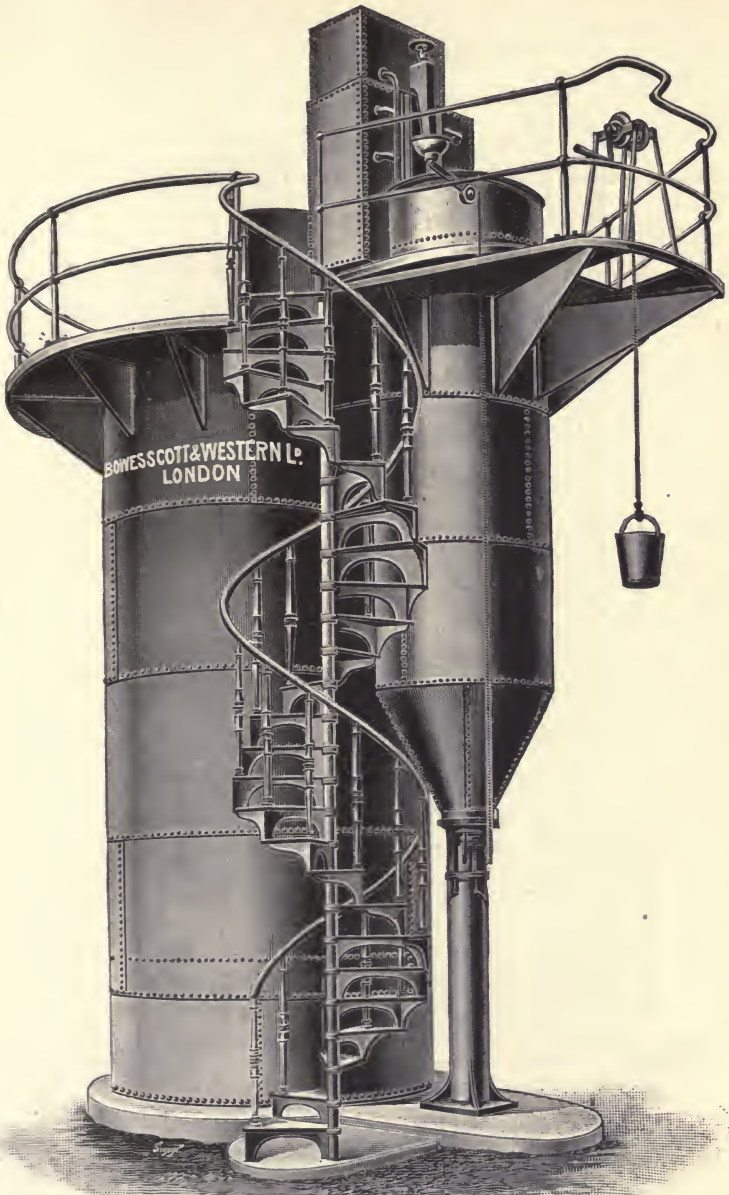

FIG. 11. THE DESRUMEAUX SOFTENER.



# WATER SOFTENING AND TREATMENT

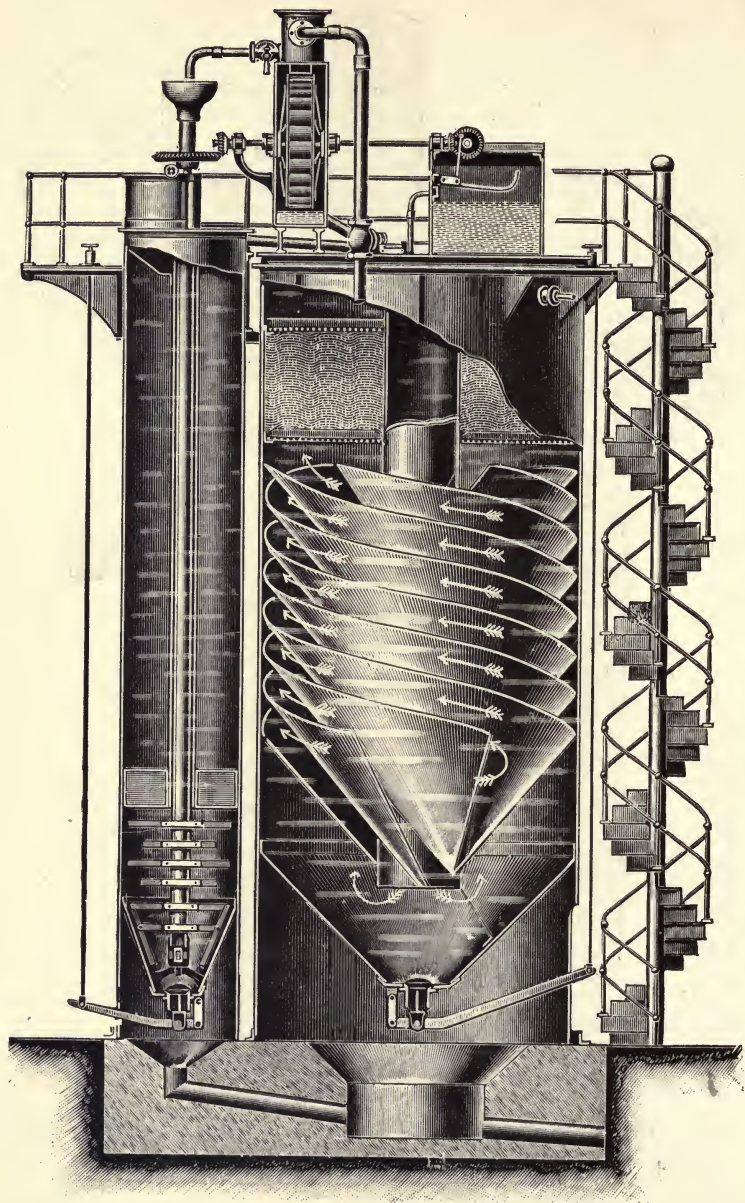

FIG. 12. THE DESRUMEAUX SOFTENER. SECTION OF DEPOSIT TANK.



## WATER-SOFTENING APPARATUS

The action of the plant is as follows :—A definite amount of lime, which is ascertained by test, is placed in the lime tank and slaked. When thoroughly slaked this is let down to the bottom of the saturator, through a valve on the lime tank. If the water requires soda treatment a certain weight of soda ash is placed in the soda tank and dissolved. On the water being let into the distributing tank, part is diverted into the cup on the top of the central tube of the saturator, whence it passes to the bottom of saturator and rises through the lime. As more water enters, the water gradually rises in the saturator, until it overflows at the top as clear saturated lime water, which passes by a trough into the central tube of the decanter. The remainder of the water which enters the distributing tank falls over the water wheel, thus actuating the lime agitators at the bottom of saturator and also the soda delivery gear. This water then falls down the central tube of decanter where it becomes intimately mixed with the lime water and soda solution. On reaching the bottom of the decanter it passes upwards through the settling plates, and through the filter, and flows out at the top ready for use. The greater part of the precipitated matters is deposited on the settling plates, whence it gravitates to the conical mud chamber, from which it can be removed by opening the purging valve.

The apparatus treats the water cold, and is continuous in its action, and special note is made of the ease by which the precipitated matters and waste lime are flushed out.

Average London water usually costs in reagents about 0.5 of a penny per 1,000 gallons treated.

Average London water is practically filtered Thames water, some of the supplies being considerably reinforced by water from chalk wells.

### The Stanhope Water-softening Apparatus.

The Stanhope apparatus (Fig. 13) is one which carries out the continuous process and is arranged for automatic regulation, the water supply being divided into suitable proportions before passing through the reagent tank or to

# WATER SOFTENING AND TREATMENT

the mixing tank. Thus the reagent solution is saturated lime water and the soda solution is measured off by the lime-mixing gear which is driven by a water wheel actuated by the actual water entering the apparatus. This wheel keeps the lime constantly agitated and ensures saturation

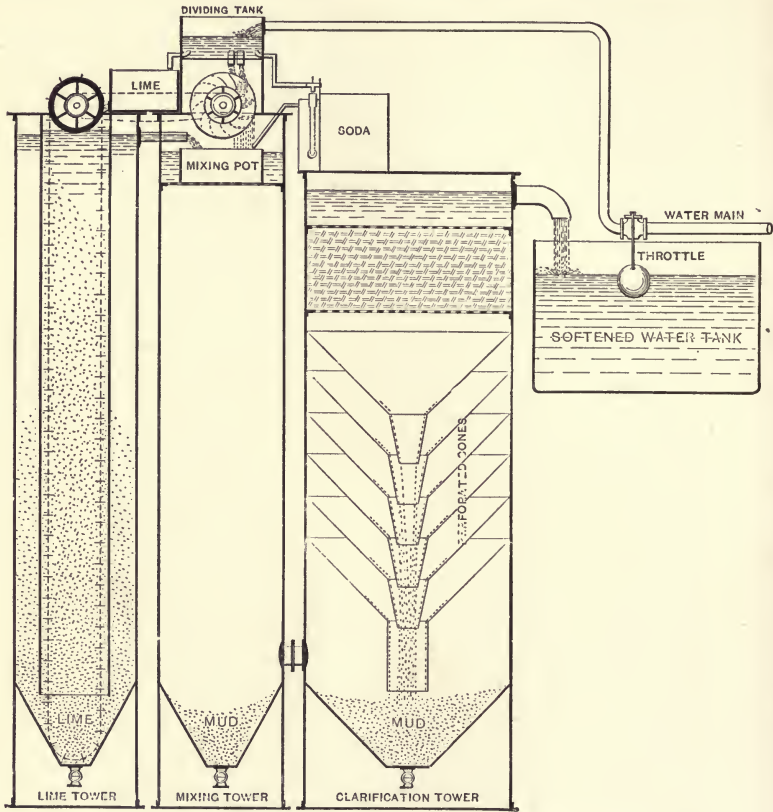

FIG. 13. THE STANHOPE SOFTENER (The Stanhope Co.).

of the portion of water which flows through it. The lime mixer is a small pump-chain, as shown in the illustration, except that in the present type of apparatus the up-running chain is inside a pipe and is thereby more efficient.

The water from this and from the soda tank falls with the main supply into a mixing vessel and some of the deposit

## WATER-SOFTENING APPARATUS

is there deposited, the water thence flowing to the base of the settling tank, up which it slowly rises through the perforated cones which are steeply inclined so as to shed the deposit, which they receive, towards the central tubes which convey it to the base of the vessel. Above the cones is a filter box of wood-wool.

The ground area occupied by the apparatus is approximately as below :—

500 gallons per hour	. . .	9 ft. × 5 ft.	} For small type plant rectang- ular tanks.
1,000 " " "	. . .	11 ft. × 6 ft.	
2,000 " " "	. . .	14 ft. × 8 ft.	
2,000 " " "	. . .	11 ft. × 8 ft.	} Large type plant circular tanks.
6,000 " " "	. . .	15 ft. × 15 ft.	
8,000 " " "	. . .	18 ft. × 18 ft.	
10,000 " " "	. . .	20 ft. × 20 ft.	

The figures of cost given by the Stanhope Co. are that each degree of hardness destroys 1·7 lb. of best hard soap per 1,000 gallons, in addition to the soap that really does duty as a detergent. Washing of a fabric does not take place, in fact, until the water lathers freely and to produce the beginning of a lather destroys the above amount of soap.

One pound of lime will soften as much water as  $4\frac{3}{4}$  lb. of soda carbonate, or 17 lb. of hard soap.

The relative cost at ordinary prices, is :—with lime, 1 ; soda carbonate, 50 ; soda hydrate, 30 ; soap, 500.

Not only is soap costly, but the product it forms is a scum and cannot be removed by settlement. It is also sticky and disagreeable.

A water of 16° of hardness can be softened by lime and soda to 3° for an average cost of one penny per 1,000 gallons. This would cost 3s. 6d. in soap.

London water requires 20 lb. of soap per 1,000 gallons more than the water supplied to Glasgow or Manchester and other of the northern towns.

The soda is regulated neither by a cock nor by a dipper. A small portion of the hard water passes by a special nozzle from the inlet tank into the soda tank by two outlets which move up and down on a pivot, and are governed by a large

## WATER SOFTENING AND TREATMENT

hydrometer in a second compartment of the soda tank ; according as the soda solution (which runs out past the hydrometer) is strong or weak, the hydrometer tilts the outlets so that the water either goes direct to the solution and dilutes it or goes direct to the soda and so strengthens the solution. The effect is, that the soda solution is always of the same effective strength, the requisite strength being determined by weights on the hydrometer.

### The Wollaston Apparatus.

In this apparatus (Figs. 14, 14a) the process is continuous. The hard water is delivered down a cascade or modification of a salmon ladder and preferably meets a flow of exhaust steam which helps to facilitate the chemical reactions. The

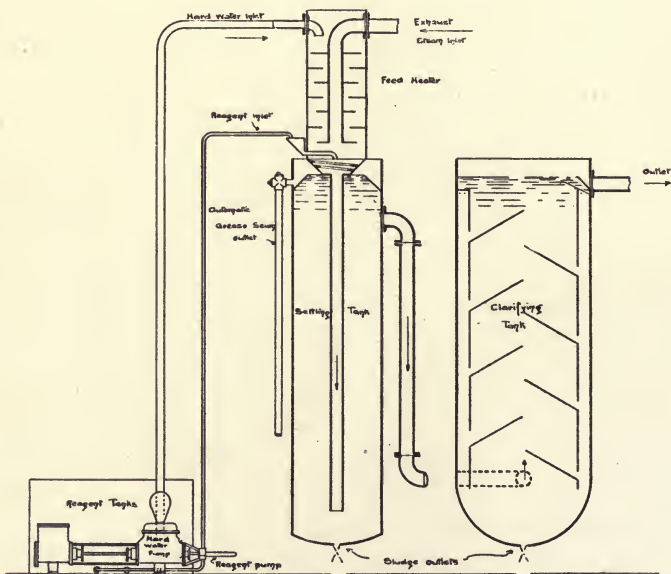

FIG. 14. WOLLASTON APPARATUS (DIAGRAMMATIC).

reagents are fed, as is also the total water, by means of pumps geared together to a suitable speed. The mixed waters fall on a centrifugal mixer A and then descend to the base of the settling tank and away by the pipe B to the



## WATER-SOFTENING APPARATUS

clarifying tank C, in which its course is deflected to and fro over the edges of the inclined shelves D, which catch deposit and discharge it as indicated in the figure to the bottom, whence it is discharged.

Probably all these continuous apparatus would be quickened in action if supplied with a means of returning some small portion of the old sludge to the hard water inlet so as

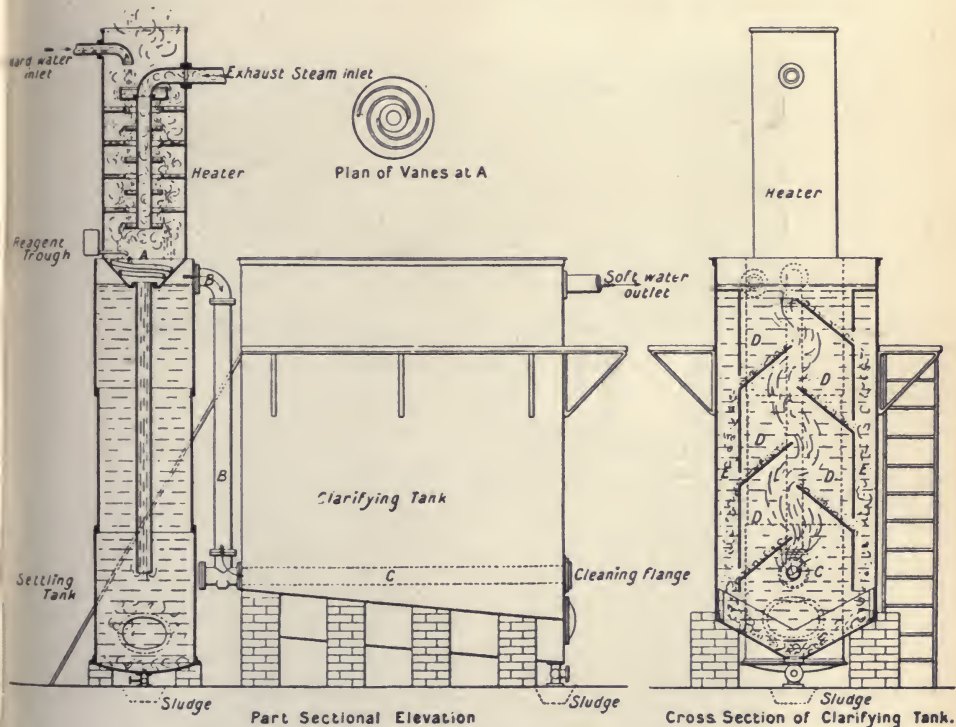

FIG. 14a. WOLLASTON APPARATUS.

to provide the nuclei which are found to facilitate the crystallization of freshly formed deposit.

In a modification of the Wollaston apparatus the same pump forces water to both the lime solution tank and to the mixing tank, through a valve that is so geared to the pump that for each 100 strokes any desired proportion of the strokes deliver entirely to the lime tank and the remainder

## WATER SOFTENING AND TREATMENT

entirely to the mixing tank. The relative proportions are thus very positively determined. The soda pump is also positively geared in correct ratio with the hard water pump so as to ensure correct treatment.

### The Carrod Apparatus.

This apparatus which, like others, works on the lime or lime soda process, according to the degree of temporary

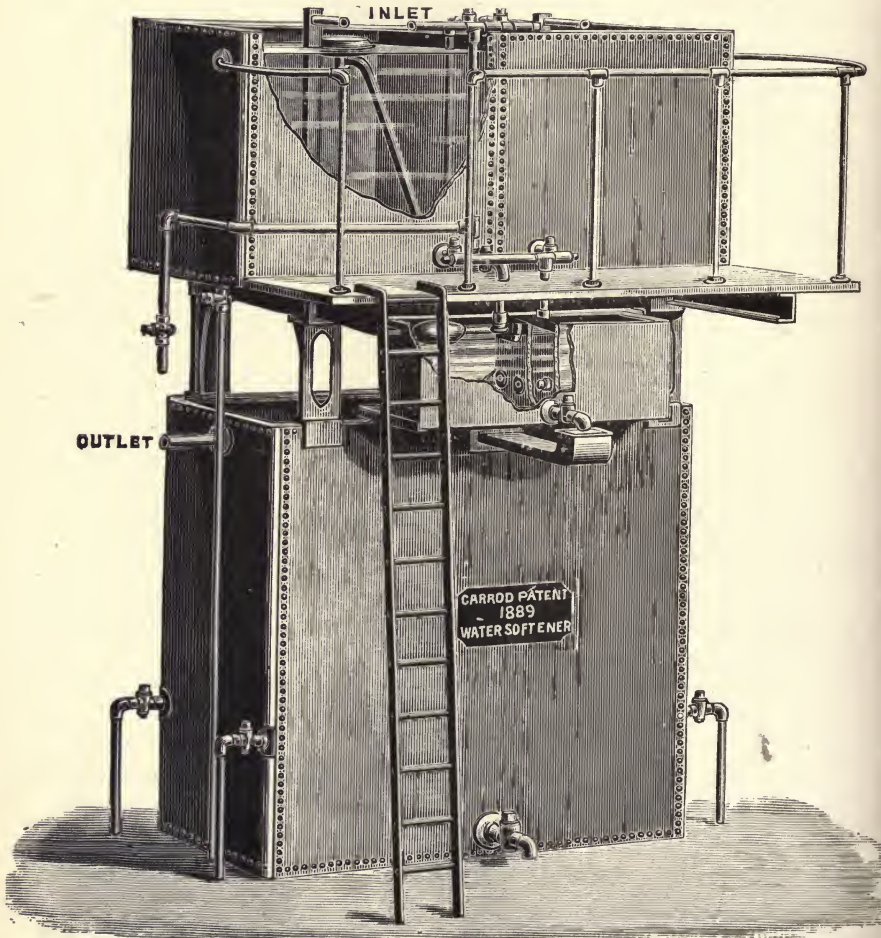

FIG. 15. THE CARROD SOFTENER.

## WATER-SOFTENING APPARATUS

or permanent hardness, is put forward as occupying little space. A capacity of 100,000 gallons per day calls for a floor space 18 ft. by 10 ft., and a height of 18½ ft.

The operation is of the continuous order and automatically adjusts itself upon the opening of the water-supply valve.

The mixture tanks at the top of the apparatus (Fig. 15) are in duplicate, the mixtures being prepared in one tank while the other is being used. The proportion of water diverted to the reagent tanks is decided by the size of the nozzles, the flow through which is kept constant by the constant head maintained in the tanks by ball float valves.

### The Paterson Water Softener.

The Paterson Engineering Company are the makers of the water softener (Fig. 16). Lime and soda are the softening reagents used. The hard water enters through an inlet controller into an automatic chemical supply apparatus, in which it is measured continuously, in its passage through a narrow vertical discharge weir, described later. Alongside the main re-action tank there is a lime water saturator. The measured water necessary to form the lime-water passes down the central pipe to the tapered bottom of the saturator, and in its passage upward through the cream of lime, with which the conical bottom has been charged from the slaking tank carried overhead, it becomes a clear saturated solution of lime, and as such flows into the mixing box. The supply of soda is drawn from the storage tank by a floating outlet and thence through a ball valve to the chemical supply apparatus.

The hard water, soda and lime water are mixed in the mixing box, pass down an external drop pipe, shown dotted, and thence into the precipitating chamber, tangentially. Here the precipitation of the bulk of the impurities is facilitated by dividing the water into thin films over a series of inclined settling plates. The semi-purified water then passes upwards through a preliminary strainer of wood fibre contained in the annular space between the quartz-sand filter and the shell of the main tank.

The quartz-sand filter is for removing the last trace of oil



# WATER SOFTENING AND TREATMENT

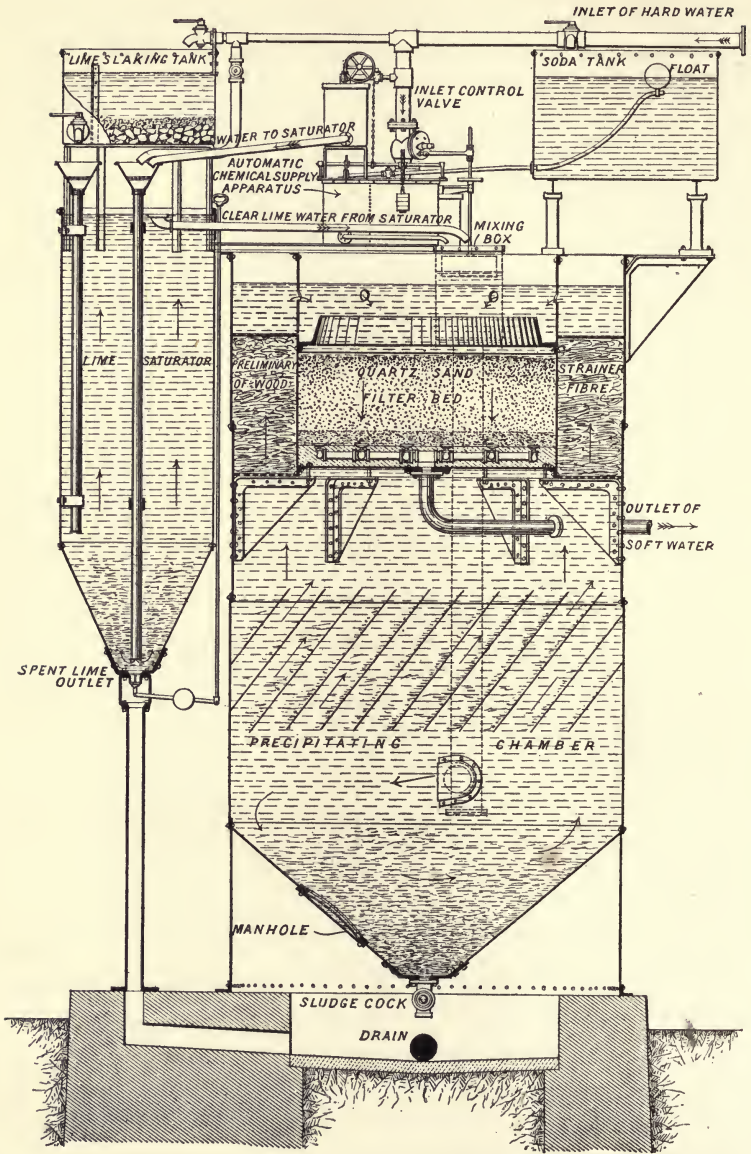

FIG. 16. THE PATERSON WATER SOFTENER AND GREASE ELIMINATOR.



## WATER-SOFTENING APPARATUS

and finely suspended matter. The filtering medium employed is a specially prepared quartz silver sand resting upon a bed of fine pea gravel. The filtered water is drawn off by a large number of finely perforated gun-metal strainers, screwed into the manifold pipe system leading to the pure water outlet.

The filter bed is cleaned by reversing the current of water through it, the impurities overflowing into the annular gutter, and thence through a waste pipe to the drain. An

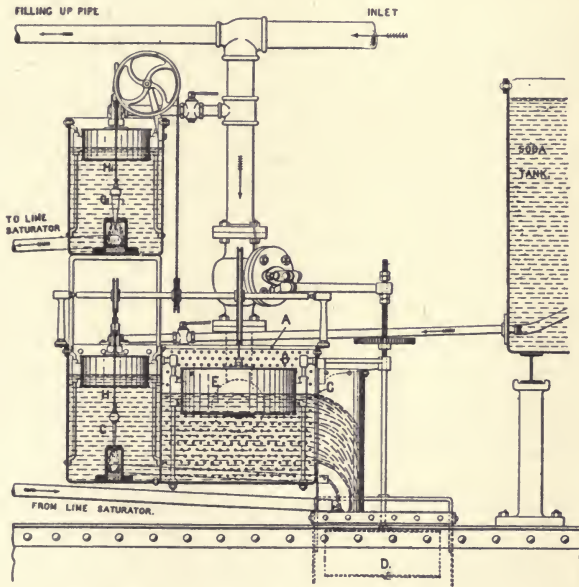

FIG. 16A. DETAIL OF REGULATING APPARATUS.

air compressor assists this process, by thoroughly agitating and aërating the filtering medium.

The automatic chemical supply regulating gear is shown enlarged in Fig. 16a.

The hard water enters the chamber A through the inlet control valve operated by the large float in the mixing box D, passes through the perforated plate B, which frees it from undue agitation into the measuring chamber, in the side of which is a long narrow vertical discharge weir C. It is

## WATER SOFTENING AND TREATMENT

obvious that the level of the water in this chamber bears a definite relation to the amount of water passing through. The weir being long and narrow, gives a large range of motion to the float E, which rides on the surface of the water. This float is counterpoised by a balance weight, to which it is connected by a flexible cord passing round and fixed to the motion pulley keyed to the cross spindle, from which the needle valves G and G<sup>1</sup> are hung, which control the supply of softening reagents.

These needle valves are carefully calibrated, so as to ensure that the ratio between the amount of hard water discharged by the weir C, and the quantity of reagents added is a constant at all variations of the load. The proportions of the reagents, however, can be varied to suit the nature of the water, by adjusting the floats of the ball valves, so as to increase or diminish the head of solution above the valve seats.

The valve G<sup>1</sup> in the chamber H<sup>1</sup> regulates the supply of water to the lime saturator, from which it overflows to the mixing box as a clear saturated solution, whilst the valve G in the chamber H controls the supply of soda solution, the head of solution in these tanks being maintained at a constant level by the ball valves, connected to the soda tank and the main water inlet.

## CHAPTER X

### DETARTARIZERS

**A** PART from the class of water softeners which employ heat and soda on ordinary softening operations, there is a class of apparatus known as detartarizers, of which one of the best known type is the Chevalet Boby (Figs. 17, 18). It consists of a cylindrical vessel built up of several similar sections, usually five. Each tray is pierced by several pipes or cones, which dip below the water in the next lower tray. Steam, preferably exhaust, circulates in the same direction as the water—viz., downwards. Cold water is admitted to the upper part of the apparatus, steam also entering the same top compartment. Both escape by the overflow tuyère to the tray below, and this continues all the way down, the steam being well mixed with the water. The various trays and cones adhere to the lime salts, which separate out of the heated water, and any oil not previously removed from the steam goes into the deposit.

The non-condensed steam escapes from the lower opening by an outlet pipe, and a float in the lower tank regulates the admission of the cold fresh water to suit the demand.

In the Delhotel purifier the steam and water travel in contrary directions. In the Buron purifier water is fed in a shower through the steam, which is also made to escape by way of dip pipes extending below the water surface, which is kept to an even height by means of a float in the draw-off vessel.

The Granddemange detartarizer is built up also in sections like the Chevalet, but the passage downwards of steam and water is by way of the circular rims of the various trays

## WATER SOFTENING AND TREATMENT

and baffles which dip below the water level in the trays. The water supply is regulated by a float in the lower casing which receives the water, and the surplus steam escapes by a pipe from the lower case. Water and steam travel in the same direction.

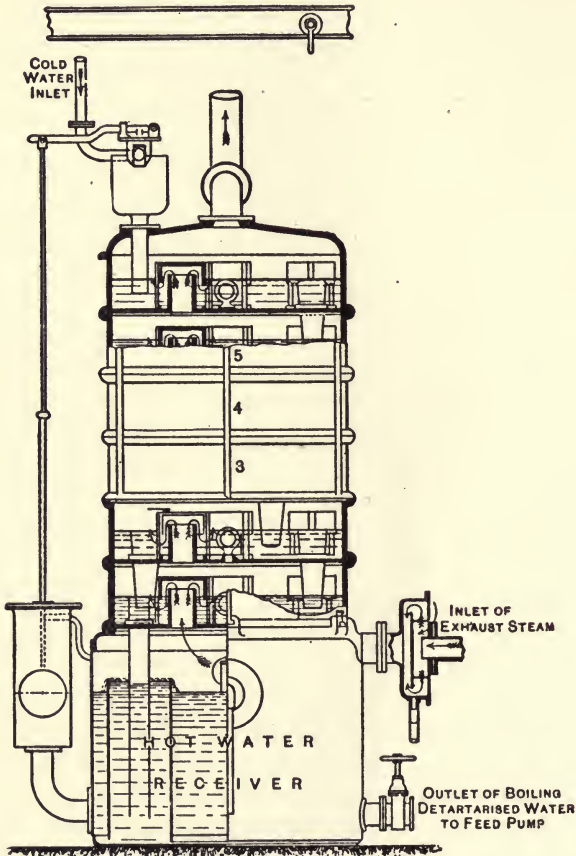

FIG. 17. CHEVALET-BOBY DETARTARIZER.

In the Weir Feed Heater (Fig. 76) the water is sprayed through steam and regulated by a float, and air or other gases which are held to be responsible for so much corrosion are trapped off at the top of the apparatus.

All these apparatus, when arranged to collect deposit on



## DETARTARIZERS

their trays and tuyères, are made so that they can be completely dismantled for cleaning when a sufficient accumulation of scale has taken place. Such accumulations are not difficult to move when attacked fresh and wet before they have had time to dry or to absorb carbonic acid from the air.

They all act on the principle that at  $100^{\circ}\text{C.} = 212^{\circ}\text{F.}$  the excess of carbonic acid which keeps lime carbonate in solution, is given off, and if lime sulphate is present the addition of carbonate of soda serves to convert this into lime carbonate, which deposits, and soluble sodium sulphate.

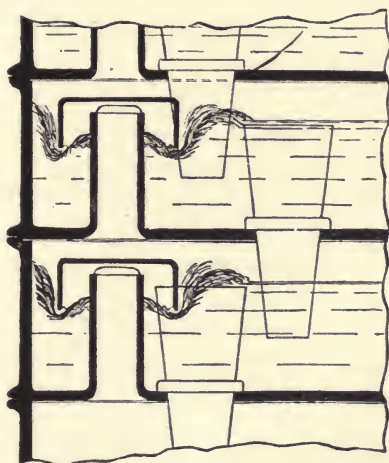
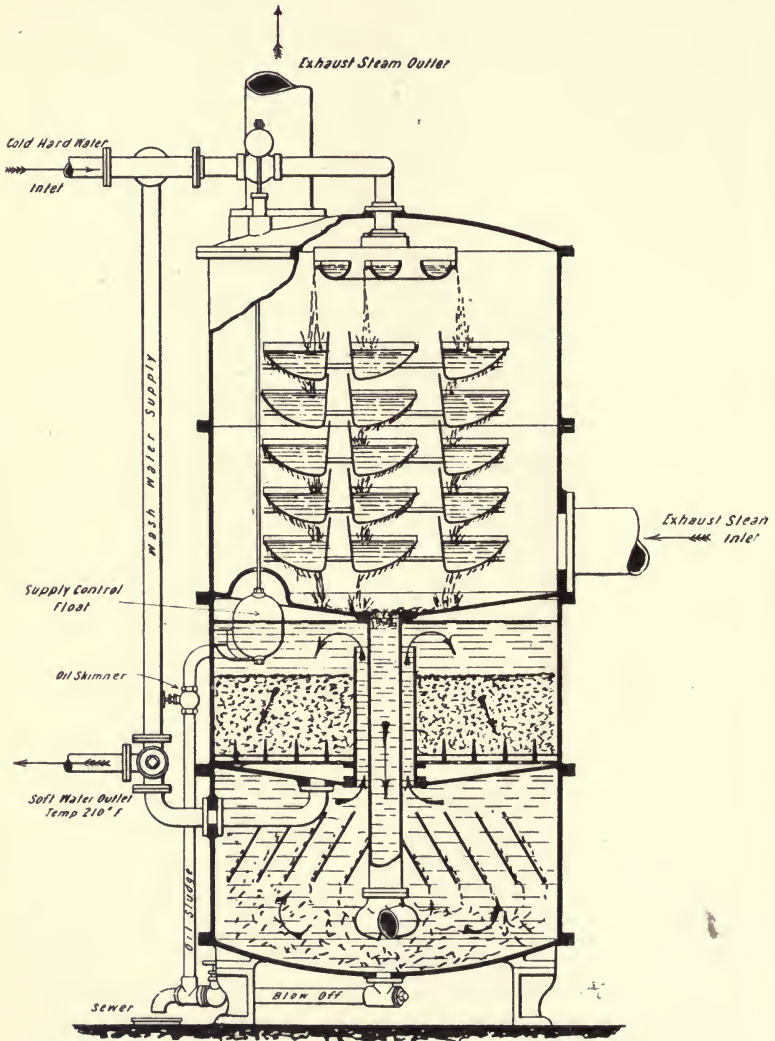

FIG. 18. DETAIL OF TRAYS. CHEVALET-BOBY DETARTARIZER.

They find their chief field where steam engines work non-condensing, or where there are no flue feed heaters. Even where these are present there appear reasons to consider that the detartarizer might be advantageously placed between two flue feed heaters, one of which should be fed with water at  $100^{\circ}\text{F.}$  from the condenser, and the second should be fed with water at  $212^{\circ}\text{F.}$  from the intermediate detartarizer, which receiving water at perhaps  $180^{\circ}\text{F.}$  from the first heater, would add sufficient steam to raise the temperature to  $212^{\circ}\text{F.}$  for causing deposit, and so saving the formation of scale in the second section of the flue heater.

## WATER SOFTENING AND TREATMENT

As elsewhere stated, the operation of water softening may be very varied, and it must be arranged to suit the conditions of each particular case.



SECTIONAL ELEVATION

FIG. 19. THE PATERSON FEED-WATER HEATER AND PURIFIER.

## DETARTARIZERS

The Paterson feed-water heater and purifier, shown in section Fig. 19, is designed to utilize exhaust steam for raising the temperature of the feed water. The steam enters at the side of the heater, and rises to the top through a series of settling and scale-arresting trays. The hard water is admitted at the top through an automatic inlet control valve to the distributing box, from which it passes to the upper settling tray, over the edges of which it flows in a thin film, adhering to the underside, and thence trickling in a fine rain into the next tray, and so on through the series; as a consequence the water is brought into intimate contact with the exhaust steam, and is rapidly raised to a temperature of 212° F. The carbonic acid gas is driven off, and the scale-forming salts deposited in and upon the trays.

After leaving the trays the water passes to the precipitating chamber, where the great bulk of the impurities is deposited, and thence to the quartz-sand filter bed, where purification is completed, and from which the boiler feed is drawn absolutely free from any trace of oil or suspended matter, and at a temperature of from 210° to 212° F.

## CHAPTER XI

### FILTERS

**E**SPECIALLY where space is limited the complete precipitation of the lime salts separated from a treated water is not always possible by the method of settlement. A certain amount of the finer deposit is sometimes carried forward, and if it is desired to remove this filtration must be resorted to.

Filtering material must be easily permeable to water but of such a nature as readily to pick up the fine particles of deposit. One such material is the common sponge of the Bahama Islands ; another is wood-wool, produced from pine wood, a material much used for packing purposes and very cheap. It is produced by some process which leaves it very rough, and it offers therefore an immense amount of surface for catching deposit. Broken coke may also be employed as a filtering medium. Other filters are made from flat bags of closely woven cotton canvas held in frames between supporting flat plates of perforated metal.

In an ordinary filter of sponge or other filling it is convenient that the water should enter below and pass upward through the material. For this purpose the base of the filter is simply a free space into which enters the water. A hopper bottom collects sediment, which can be run out by a sludge tap. The upper boundary of this base piece is a perforated plate or a grid supporting a depth of a few feet of filtering medium which is held down by an upper plate or grid. At the top is the outlet. In order to cleanse such filters the course of the water is reversed and the deposit collected on the sponge, etc., is washed off and discharged through the sludge tap. This type of filter is not considered



## FILTERS

suitable for more than mechanical filtration, or simply to follow up the action of depositing chambers. No doubt a very cheap filter could be arranged in a tall storage or depositing vessel by hanging a grid below a second grid by means of rods coming through to the top of the tank. Between the grids would be a mass of wood-wool, and cleaning would be accomplished by agitating the material by raising and lowering the lower grid so as to cause the deposit to be washed off the fibres, this being done when no water is passing through and the agitation can be followed by a period of rest for the deposit to sink away from the filter grid. For ordinary boiler-feeding purposes no serious harm occurs from such small quantities of carbonate of lime deposit as is carried through to a boiler when the softening apparatus is of ample size. Some deposit will even be found after filtration through cotton bags. These bags, when choked with sediment, can only be cleaned by removing them from their frames and washing out in water, the bags being turned inside out.

For large supplies of water a dirty or muddy source may be made bright and clear by the aid of large sand filters of the type employed by the water companies. These filters consist of large tanks or dams with evenly sloped bottoms on which are laid lines of perforated or open jointed pipes buried in a layer of large stones. Above this follows layers of smaller stuff in gradually decreasing size, the top layer being several inches of sharp sand. From the pipes ascend above the top sand a number of air-vent pipes to allow the filter bed to become full of water. Slow downward movement through the sand is permitted, and the dirt remains behind on the sand, the surface of which is scraped off from time to time as it becomes choked and inoperative. The scraped-off sand is washed for use again and again.

This filtration only removes suspended matter and bacteria. It does not abolish the necessity for softening, but the softening process may cause the deposit of mud carried in suspension. Occasions will arise where preliminary filtration may be an advantage, or where being present for other reasons may be utilized.

## WATER SOFTENING AND TREATMENT

It is customary to allow one square yard of filter bed for each 700 gallons per twenty-four hours, but this allowance must be increased for very muddy waters, hence the advisability of settling ponds. From 3 to 6 inches per hour is a suitable downward rate of flow through the filtering materials, and 9 inches of head of water should produce a sufficient pressure to do this when the filter is clean, and when the head reaches 24 or 30 inches it is time to clean the surface.

A usual depth of bed is 6 feet, made up of 30 inches of fine sand, 6 inches of coarse sand, 6 inches of shells and 30 inches of gravel. The open joint pipe drains are in lines every 2 to 3 yards, and an air pipe is provided for each 9 to 16 square yards of area. The sand surface is lightened up with forks at each cleansing to correct any hard packing.

Where large quantities of water are required and there is ample ground space available, a settling pond may with advantage precede the filter proper. The dirty water is first pumped into the settling pond, one end of which is divided off by a wall within which the pumped water becomes quiescent. It escapes thence over the wall into the main division and is taken off preferably from the surface at the extreme end. When possible a sludging drain is provided to remove accumulated mud or the tank must be periodically emptied. It is therefore better to have settling ponds in two parts if the water carries much mud.

The settling tank eases the duty of the filter. Needless to say such settling tanks may even be the sediment tank of the actual softening process, but for the present the filtration of a water supply is alone under consideration. A settling pond may be filled by pumping, or it may have direct supply from a river. They may be wholly excavated in the ground or wholly raised above ground. A very cheap type of partly excavated tank has been constructed by the Author as follows. First the foundation of a brick wall has been dug out to a depth of about 3 feet 6 inches, and a wide bed of good concrete filled in on which a brick wall of 18 inches has been built in cement mortar up to the ground level. Above this the thickness is reduced to  $13\frac{1}{2}$  inches. A collar joint of neat cement is run round every course. As

## FILTERS

the wall rises in height the interior of the tank is excavated and the material tipped and rammed outside the wall. If the calculations are properly made the earth excavated will suffice to form an outer flat-topped sloped bank to assist the stability of the brickwork. The concrete foundation being now exposed inside the tank is washed clean and the tank bottom laid in concrete to join up to it. The whole interior is rendered in sharp sand and cement mortar and finished smooth with a finer and richer coat thinly applied on a well scribed surface.

The outlet or sludge pipe is placed solidly in a concrete-filled trench and curves up to finish flush with the tank bottom. The outer earth slopes are grassed over.

Where a brick wall must be depended upon to retain water, it should not be less than 14 inches thick at the top, and should be built with a collar joint of cement mortar. The base thickness should be at least two-thirds the height, to resist the overturning moment, which is found by the formula  $P = 10.4 H^3$ ; where  $P$  is the pressure concentrated at one-third the depth of the water from the bottom, and  $H$  is depth in feet.  $P$  is thus the overturning moment in foot-pounds, and should not exceed one-third of the stability. The stability is the product of the weight of a foot length of wall into the distance from the outer toe to a perpendicular let fall through the centre of gravity of the section. Thus in a pond 6 feet deep the overturning moment is 2,246 lb. If the wall is 2 feet thick at the top and 4 feet at the base, and battered equally on each face, and has a weight of 150 lb. per cubic foot, its stability about the outer toe will be  $3 \times 150 \times 2 \times 6 = 5,400$  foot-pounds, an amount that is so nearly sufficient that it would be made obviously safe by reducing the top to 18 inches and thickening the base to 4 feet 6 inches. Sometimes division walls are built in the reservoir, dividing it into several sections, through which the water flows in succession.

The graphic method of determining the stability of a wall is shown in Fig. 20.

Let  $P$  be the overturning moment  $= 10.4 H^3$  acting at one-third the depth of water from the bottom.



## WATER SOFTENING AND TREATMENT

Let  $a b = P$  to any convenient scale.

Let  $a c = W$  to the same scale as  $a b$ , where  $W$  is the weight of a foot length of a wall of the section  $e f g h$ .

Then  $a c$  must be drawn vertically through the centre of gravity of the figure  $e f g h$ .

Complete the rectangle  $a b c d$ , and join  $a d$  cutting the base of the wall at  $n$ . Then  $h n$  must measure more than one-third of  $h g$ , or the wall will be of too low a stability. If  $h n$  is found to be less than one-third of  $h g$ , the wall section must be increased and a fresh calculation made. Obviously, if battered on the outer side, the centre of gravity may be brought nearer the water face, and stability secured

more surely than by the battering of the inner wall. It is, however, to be remembered that a batter on the water face transfers some of the weight of the water itself in a downward direction and helps the stability.

It is most important that joints in the brickwork should be good. Hence the advantage of cement rendering of the water face. Otherwise

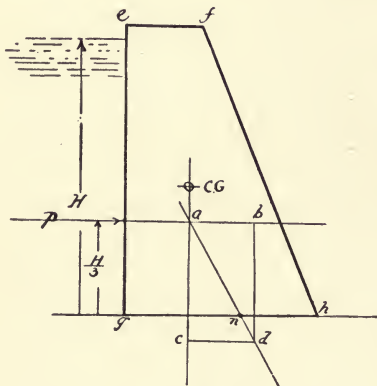

FIG. 20.

water pressure getting in between joints may assist to overturn a wall.

Large tanks can be built in a minimum of space of cast-iron plates bolted together with internal or external flanges. These are often rendered water-tight by rust cement joints. Tank plates with machined flanges can be jointed with thin painted brown paper, and such plates with suitable lugs for internal stays are now made by Mather & Platt in standard sizes for tanks of any desired size or shape.

An ordinary sand filter bed is rectangular in shape and about 8 feet deep, with a bottom gently sloped to a central channel covered with flag or filled with big stones. The



## FILTERS

cross drain pipes run to this central channel, but some prefer to cover the whole bottom with large stones in place of using pipes, as they consider the percolation more even. Others again cover the whole filter bottom with drain pipes packed in pebble gravel.

The actual filtering sand is best when 0.008 inches in diameter, the limits of size being preferably 0.005 to 0.01. Practically all filtration is done at the upper surface, and it is claimed by some that no real filtration takes place until the surface has acquired a sort of gelatinous vegetable growth over it. It is generally agreed that until this growth is formed full-rate filtration should not be allowed. When the filter surface finally becomes choked by this growth and by mud the filter is allowed to run dry, and the top layer of sand is sliced off thinly, about  $\frac{1}{4}$  inch or  $\frac{1}{2}$  inch only being removed. This is washed and stored for future use. Cleansing in time reduces the thickness of the sand to 12 inches. It is then time to fill up the original with the washed sand, the filter surface being first thickly sliced off and the new sand well bonded to the old by forking.

For manufacturing purposes a filter may then usually be at once used, but for potable purposes a newly sanded filter is best filled up from below with previously filtered water, otherwise the first water from a newly sanded filter must be returned to the top or run away. An average spare area to allow for cleaning is provided to the extent of 20 per cent. more or less according to conditions.

### Rapid Filters.

Where space is an object filters are made in the form of closed tanks, and water is forced through them under pressure at rates of flow upwards of two or even three hundred times that usual in ordinary filters. Such mechanical filters are cleaned by reverse flow of about one-twentieth the amount of water filtered. They are not suitable for potable water purposes, but only for manufacturing uses.

Large open sand-filter beds have considerable decolorizing effects on water. The Author has purified the dye-stained

## WATER SOFTENING AND TREATMENT

water of the River Mersey, black with dye from hat works, by similar settling ponds and sand filtration.

When softening is not to follow filtration the operation of the filter will be facilitated by the use of a grain or two grains

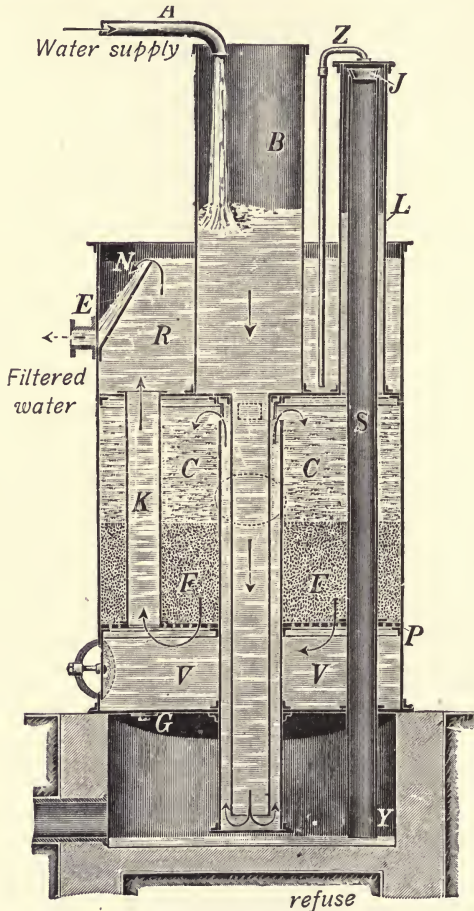

FIG. 21. REISERT FILTER (Royle).

of alum per gallon of water to coagulate organic matter and assist sedimentation. It is a question whether such alum should not be added to the supply as it flows into the settling pond.

## FILTERS

### The Reisert Filter.

In this apparatus (Fig. 21) automatic cleansing is resorted to. The muddy water to be filtered enters the chamber B and flows downwards as shown by the arrows, into the chamber C and so reaches the filter bed F, through which it passes leaving behind its impurities on the upper surface of the filter.

The filtered water from the chamber V finds its way upwards viâ the pipe K into the chamber R and finally overflows the diaphragm N into the filtered water outlet E. Obviously, the rate of filtration will vary with the state of the filter bed and the head of water in B. As the filter bed becomes foul and its resistance to the flow of water increases, the water level in B rises and establishes a corresponding level in the pipe L, which it will be observed is in connexion with C. Inside this annular pipe L is another pipe S, which extends from nearly the top of L right through the filter bed and receiver V to the waste water channel G, forming the base of the filter. As the water rises in L there presently arrives a time when it overflows at J and so forms a syphon. The current through the filter is thus rapidly reversed, the water in R flowing back through K and upwards through the filter bed, the deposit on the filter being thoroughly disturbed and carried into the waste channel G. The chamber R is proportioned to contain sufficient water to effect this cleansing operation thoroughly, and as this chamber empties, air enters and destroys the action of the syphon and the cleansing ceases. The filter then resumes its normal working. This cleansing operation is repeated as often as the state of the filter requires and is entirely automatic.

The Reisert Water Softening Apparatus has a filter similarly arranged for automatic syphonic cleansing. Such filters must of course be filled with a suitable material of the nature of sand, which will readily part with the dirt and deposit collected and will also settle back when cleaned into place for further action. The reverse flush also must be so proportioned to the space occupied that it will not carry away the filtering material.

## CHAPTER XII

### BOILER COMPOUNDS

**B**Y far the most usual method of treating boiler-feed water for prevention of scale and the boilers themselves for removal of old scale is to add to the feed-water tank certain compounds. Considerable mystery is always attached to these compounds, but there is nothing really mysterious in their composition. Their basis is soda, and their other ingredients are extracts of tannic substances, and many of them contain starchy or gelatinous matter which is supposed to serve the purpose of coating each individual grain of scale-forming material with a mucilaginous cover, whose purpose it is to prevent the particles adhering. A loose mud is thus formed which can be more readily blown out.

Where proper care is taken to suit the compound to the water boiler compositions may be fairly effective. When the deposition of additional scale is prevented by them and no further cementitious action can take place, the natural effect of working a boiler is to set free scale from the plates.

The cost of boiler compounds is very great as compared with the amount of active material present, for so large a proportion of water is present in all compounds of a liquid or gelatinous nature. As stated above most compounds contain carbonate of soda, which serves to reduce the lime sulphate and precipitate it as carbonate of lime in muddy form. No doubt also caustic soda is a component part of some compounds. Indeed it would be a very proper constituent where the compound is fed into the feed tank, for here we have an approximation to that external treatment



## BOILER COMPOUNDS

of feed water which it is the object of this book to recommend as the most correct method of treatment.

The tannic compounds in boiler compositions are extracted from such timbers as oak, quebracho, chestnut, logwood and others which contain tannin.

The object in employing these products with soda is to introduce organic matter into the old scale in order that when it has penetrated to the surface of the metal below the scale, decomposition may be set up which causes a disruptive effect and splits off the scale, sometimes in large slabs.

The following reactions are claimed by M. Taveau to take place when tannic acid produced from nutgalls or oak-apples is treated with water and subsequently submitted to prolonged boiling.

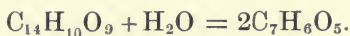

After boiling  $C_7H_6O_5 = CO_2 + C_6H_6O_3$ , or carbonic acid and pyrogallic acid which forms with the lime salts, digallate, gallate and pyrogallate of lime. M. Taveau<sup>1</sup> gives a formula for a quebracho mixture used by the Chemins de fer de l'Ouest. It is made from 24 kilos. of quebracho and 12 kilos. of caustic soda boiled in a vessel of 100 litres capacity for three hours and made up finally to 180 litres, which when cold has a specific gravity of 11° to 12° Baumé. The liquid is fed in amounts of a quarter to half a kilo. per boiler after each cleaning, and a tenth to a fifth of a kilo. per cubic metre of subsequent feed water.

The Chemin de fer du Midi employ an extract of quebracho in the proportion of 0.175 of tannin per gramme of lime or magnesia in 1,000 litres of water.

The State Railways of France boil 130 kilos. of campêche wood with 150 kilos. of carbonate of soda in 1,000 litres of water, and employ 0.0156 kilos. of the liquid per cubic metre of water per degree of hardness.

The Orleans Railways use a liquid at 8° to 10° Baumé produced by prolonged boiling of 60 kilos. of carbonate of soda, 75 kilos. of campêche and 25 kilos. of quebracho. It is used

<sup>1</sup> *Epuration des Eaux.* Paris : Gauthier Villars.

## WATER SOFTENING AND TREATMENT

in the proportion of 0.016 kilo. per degree of hardness per cubic metre.

The Chemins de fer de l'Est employ extract of chestnut 12 kilos., carbonate of soda 10 kilos., and water 78 litres. The chestnut extract has a gravity of 25° Baumé, and contains 40 per cent. of extracts of which tannin amounts to three-fourths. Every day 2 litres are placed in the water tanks of the tender and 4 litres are used in each boiler direct after cleaning, which occurs about every ten days.

M. Taveau strongly recommends aluminate of barium, which has the disadvantage of high price enhanced by the high atomic weight of barium—viz., 137 against calcium 40. By its use new deposits are rendered quite pulverulent and old scale is disintegrated. He does not profess to explain these reactions, for theory does not explain the results which demand a quantity of the reagent far superior to the quantities employed successfully.

He suggests that the reagent becomes successively regenerated, and is able to act again and again much as carbonate of soda acts on carbonate of lime.

Aluminate of barium of 5° Baumé solution is advised to be employed in doses proportionate to the degrees of hardness and generally about 10 grammes of the solution per degree of hardness per metre cube of feed water. With a notable proportion of lime sulphate,  $n = 10(\frac{3}{4}A + B)$ , where A is the total hardness in degrees, B is the permanent hardness, and  $n$  is quantity of solution in grammes per cubic metre.

### Various Substances.

Of the many other substances employed as disincrustants petroleum has the credit of loosening scale from boiler plates and of preventing adherence of fresh deposits. It appears probable that the addition of petroleum in a dried out boiler would ensure the absorption of the oil by the scale, and that when under steam again the oil would be driven off and produce no evil effects. Without expressing any opinion on the safety of petroleum the Author would say that

## BOILER COMPOUNDS

nothing heavier than the lamp oils should be used, for a heavy oil which did not readily evaporate at the steam temperature might have effects as bad as an organic oil, though this is denied. Experiment seems to be wanting to prove the true effect of mineral lubricating oils as compared with organic oils in retarding the passage of heat from the plates to the water and in mixing with lime or magnesia salts to form spongy compounds. Caution should be exercised in regard to all mineral oils pending further knowledge.

**VARNISHES.**—M. Taveau states that the adherence of scale may be prevented if the interior of a boiler is painted with a mixture of graphite 25 per cent. and black mineral varnish 75 per cent., and that the results are good even if the application is inconvenient.

He comments also on the introduction of potatoes and other starchy substances, which when hydrated become converted into cyanodextrin and dextrin thus—

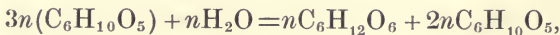

and these combine with the precipitant salts and form a slippery mud which cannot compact itself and is more easily removed.

No doubt all the similar bodies have somewhat these effects, such as the Irish moss, slippery elm bark, etc.

Talc to the weight of one-tenth the weight of the incrusting matters of the water is sometimes employed, and though often considered inert it is thought may give rise to reactions akin to those of the alkaline silicates.

The promiscuous use of boiler compounds is not to be advised. They should never be placed *en masse* in a newly-cleaned boiler, but should be thoroughly dissolved and run in with the feed. When the boiler is set to work the compounds should only be added with the feed, being dissolved and fed to the feed tank or pumped into the feed pipes by a small pump which will only pump in the proper quantity by working constantly.



## WATER SOFTENING AND TREATMENT

### Cleaning a Boiler.

Much of the good accomplished by a successful disin-crustant will be lost by improper cleaning of a boiler.

To clean a boiler properly a quantity of water may if required be first blown out and its place filled by a further supply. The boiler must then be left until it has become cold, the dampers to the chimney being a little open to cool the flues, or if other boilers are at work and this cannot be done because of chilling the economizer, a current of air can be ensured by opening up the back downtake of a Lancashire boiler or some suitable door in other boilers.

When cold the water should be run out, and while still wet and before acted on by air the loose mud should be washed off the whole interior with a hose and the cleaners sent in at once to scrape off the scale while soft. If left to dry, the deposit, which is free from the second equivalent of carbonic acid,  $\text{CO}_2$ , begins to absorb this gas from the air and to form harder crystalline scale.

It has been found to promote scale removal to supply a big dose of soda, and successively raise the boiler full of water to  $212^\circ \text{F}$ ., and to cool it twice.

Some years ago a process was introduced for freezing boilers free from scale. A boiler thoroughly wet was frozen by pumping cold air through it. The water in the scale disintegrated this by its expansion when forming ice, and caused it to separate. The process was said to be effectual and is based on sound theory apparently, but the Author has no information as to cost or its present position, or if it is in practical use.

Scale of long standing is apt to be very tough. The Author has seen the spaces between the shell and flue tubes of Lancashire boilers completely blocked with scale, and the lower back end of the shell covered perhaps 6 inches thick. It is very difficult to remove such scale while the water that produces it still continues to be employed. Where an alternative water supply is available the boilers may be cleansed by one water of the deposit caused by another. This is more readily possible with locomotives. In one case



## BOILER COMPOUNDS

which came particularly under the Author's notice certain locomotives which had become considerably incrustated by the use of water from a chalk well were found to be thoroughly cleaned when fed with a mixture of water obtained from a borehole which collected its supply from the sandstone of the Upper and Lower Tunbridge Rocks and the Ashdown Sands. These sand waters were soft and had a soluble effect on chalk scale.

This fact brings up a possible effective cleansing process. It has been suggested that weak acid will attack lime scale before it will attack the plates of a boiler. The following effect is supposed to be produced by adding hydrochloric acid to carbonate of lime scale,

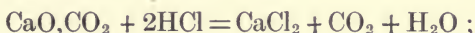

soluble calcium chloride being produced with water and carbonic acid.

Similarly if sulphuric acid is employed the result is  $\text{CaSO}_4$ , or lime sulphate, instead of chloride, and the scale is softened for removal especially if treated with a wash of soda, caustic or carbonate, to intensify the breaking up effect. Possibly even with a lime sulphate scale some effect could be obtained with hydrochloric acid. The Serpollet tube boiler is cleaned with acid. Condenser tubes have been cleaned by circulating acid water through or over them, and there seems no reason why the same effect should not be secured with scaled boilers if the process is carefully conducted. Especially after the proper softening of a water has been commenced old scale would be gradually loosened by aid of a very gentle acidulation of the feed water, which will not, it is thought, attack the plates so long as any scale remains on which the acid can extend its energies. Such operations, of course, require to be carried out under intelligent supervision.

## CHAPTER XIII

### CORROSION

**S**TEAM boilers suffer from corrosion due to the solvent properties of the feed water.

The Longdendale Water Supply of the City of Manchester comes from a gathering ground of the Millstone Grit Formation, more or less clothed with peat bog. The water contains some acid, probably tannic, and has a slight corrosive effect upon boilers. In the district of Mytholmroyd in Yorkshire some of the streams are exceedingly corrosive, and will eat away the whole inside of a boiler very rapidly. The canal at Walsden fed from such streams, and perhaps further contaminated by acid manufacturing wastes, is also exceedingly corrosive.

Coal-pit water is also frequently destructive by reason of its acidity.

All such waters can be neutralized by the use of soda, and should be neutralized until they show an alkaline reaction with red litmus paper. But soda is more expensive than lime, and it would appear more rational to pass the feed water through a mass of limestone chippings or to add lime to it in order to neutralize the acidity. Should the neutralization be so complete and thorough as to cause scale to be deposited in the boiler, a slight cessation of the neutralizing treatment would speedily remove the scale. Acid water in fact only requires treating on exactly the same lines as, when applied by Nature, produce the natural hard waters. Steam users who stand aghast at the Author's suggestion to employ weak acid in order to destroy thick scale by dissolution will stand unconcernedly by and watch the water from an acid

## CORROSION

canal rapidly dissolve a £500 boiler to danger point and scrap value.

One pound of sulphuric acid will destroy one pound of carbonate of lime scale. Three-fourths of a pound of hydrochloric acid will produce the same effect and hydrochloric acid will be the cheaper agent to employ for boiler cleaning so long as its price is less than 4 as compared with 3 for sulphuric by weight.

From the price list annexed, as given in a number of the *Electrical Review*, it will be seen that hydrochloric acid is cheaper per cwt. than sulphuric by about 10 per cent., and that as a destroyer of scale it is therefore nearly a third less costly.

CHEMICALS, ETC.		£	s.	d.	
Acid :	Hydrochloric . . . . .	0	5	0	0percwt.
„	Nitric . . . . .	1	2	0	„
„	Oxalic . . . . .	1	12	0	„
„	Sulphuric . . . . .	0	5	6	„
Alumina :	Alum, Lump, loose . . . . .	5	5	0	per ton
„	„ „ in casks . . . . .	5	7	6	„
„	„ Ground, in bags . . . . .	5	15	0	„
„	Sulphate of (14%) . . . . .	4	10	0	„
Ammonia :	Carbonate . . . . .	0	0	0	3½per lb.
„	Muriate (crystal) . . . . .	33	10	0	per ton
„	„ „ . . . . .	30	0	0	„
Ammoniac :	Sal, Lump, 1sts (delvd. U.K.) . . . . .	42	0	0	„
„	„ „ 2nds „ . . . . .	40	0	0	„
„	„ „ . . . . .	2	2	0	percwt.
Barytes :	Lump Carbonate, 90-92% . . . . .	3	10	0	„
„	Sulphate, No. 1, White . . . . .	2	15	0	„
Bleaching Powder . . . . .		5	5	0	„
Borax :	British Refined Crystal . . . . .	12	0	0	per ton
Potash :	Bichromate (delvd. England) . . . . .	0	0	3	per lb.
„	Carbonate, 90-92% (c.i.f. Hull) . . . . .	18	0	0	per ton
„	Caustic, 75-80% (c.i.f. Hull) . . . . .	20	10	0	„
„	Caustic, 75-80% . . . . .	24	0	0	„
Soda :	Ash, Caustic, 48%, Ordinary . . . . .	5	5	0	„
„	„ „ 48%, Refined . . . . .	6	5	0	„
„	„ Carbonated, 48% . . . . .	5	10	0	„
„	„ „ 58% (Ammonia Alkali) net . . . . .	4	10	0	„
„	„ Bleachers' Refined Caustic 50-52% net . . . . .	6	10	0	„
„	Caustic White, 77% . . . . .	10	10	0	„
„	„ „ 70% . . . . . net	9	12	6	„
„	„ „ 70% . . . . . „	10	15	0	„
„	„ „ 60% . . . . . „	8	12	6	„

## WATER SOFTENING AND TREATMENT

Soda: Caustic Cream, 60%	. . . . . net	8 10 0	per ton
„ Crystals	. . . . .	3 0 0	„
„ „ in bags	. . . . .	3 0 0	„
„ „ in barrels	. . . . .	3 7 6	„
„ Bicarbonate, in 1 cwt. kegs	. . . . .	6 15 0	„
„ Bichromate (delvd. England)	. . . . .	0 0 2 $\frac{1}{4}$	per lb.
„ Silicate, Solution, 140 Tw.	. . . . .	4 10 0	per ton
Sulphate of Magnesia	. . . . .	4 10 0	„
Talc: (French chalk) c.i.f. Liverpool	. . . . .	3 10 0	„

As visible in steam boilers corrosion takes several forms. A very usual form is that known as pitting, which consists of isolated circular spots of active corrosion which attack the plates of the boiler by no means generally. This pitting will occur internally along the line of the seatings of the Lancashire boiler. Pitting is thought to be due partly to something in the nature of the metal which is more easily attacked at certain spots. It is recommended that pits should be thoroughly scraped clean and painted with red oxide or red lead paint, and that further progress will be checked. When very frequent they become confluent and begin to present more the appearance of general corrosion. Pitting is apt to occur near the inlet of cold feed water, and much evidence points to it being caused by gases set free from insufficiently heated feed, for pitting will occur when scale is deposited and the presence of acid is negatived.

Really acid water produces general corrosion of the whole interior under water surface of a boiler. Sometimes the effect is so even and continuous that no very accurate estimate of the amount eaten away can be made. Sometimes the shell rivet seams will hardly be touched, and in that event the body of a plate may be very seriously corroded without reducing the strength of a boiler.

Grooving is a form of corrosion which attacks plates and angles when subject to bending, as at the line of contact of the front end plates of a shell boiler with the attaching angle irons, at the root of those angle irons, and even along the longitudinal rivet seams of the shell of a lap-riveted boiler and at the root curve of the flanged seams of the furnace tube and round the base ring of the locomotive or vertical boiler firebox.

This grooving is largely a mechanical product, but though



## CORROSION

it will occur in neutral water it is much intensified by acidity, and it is dangerous in certain situations, as when it occurs in longitudinal seams under tension stress.

Some waters not naturally acid become so at high temperatures, as when chloride of magnesia decomposes with formation of free hydrochloric acid. This phenomenon has become more serious as pressures and therefore temperatures have become higher.

Galvanic action has been advanced as a cause of corrosion and its remedy proposed by the fixing of blocks or slabs of zinc in metallic connexion with the boiler. The boiler is saved at the cost of the zinc. Galvanic action, when expended on the boiler itself, attacks some parts more than others. Hence the objection to copper, which throws the destructive action upon the iron, and hence the use of zinc which is attacked before iron. Generally the immunity from attack depends on the relative electro-positiveness of the different metals involved. Oil and grease of an organic nature, apart from their dangers in other respects, will decompose to fatty acids and destroy boiler plates with the formation of iron soaps. The general fact may be stated that a boiler fed with hot water and kept faintly alkaline will not suffer from corrosion to any serious extent, for the hot feed implies freedom from corrosive gases, and the alkalinity implies freedom from acid and galvanic action. Mr. Weir provides air traps to remove the air from heated feed and prevent its entry to the boiler.

Absolutely pure water may be assumed to have an effect on a boiler, and roof-collected rain contains acids, especially in manufacturing districts, and also carbonic acid. In every works the whole available roof and yard area should be utilized for rain collection as boiler feed, for it will contain no scale-forming material.

Boilers are sometimes exposed to peculiar conditions as to feed supply.

A singular case of explosion occurred in Sheffield. A boiler using a river water exploded from rapid acid corrosion in the hands of new owners, who treated it as they treated their other boilers drawing from the same stream a few

## WATER SOFTENING AND TREATMENT

yards lower down stream below a slight weir. Investigation disclosed the fact that the waste acid from an electro-plating works dribbled into the edge of the stream a few yards higher up stream, and this acid flowed directly past the intake of the feed to the exploded boiler. The fall over the weir thoroughly mixed the acid with a large bulk of water, and boilers below the fall were not affected. The incident serves to show how alert the engineer must be to detect faults. The new owners treated the exploded boiler exactly as they did others ostensibly fed from the same source, though actually there was no similarity between the two feed waters, for one was a powerfully acid water, the other a large river in which acid had been mixed in small comparative quantity.

The water of the Mersey which has in the main flowed from the millstone grit area of East Lancashire and the North Peak district, and received as sewage the soft water supplies of the cities and towns of East Lancashire, is specially pumped at Warrington for boiler purposes, or was some years ago. On the Thames at Deptford the water is so bad, probably because of chloride of magnesia, that water tubes are rapidly corroded through in holes. The general nature of the water in any district may be judged by tracing the river courses on the geological maps.

Many boilers fed with muddy water would be improved merely by provision for the water to settle out its mud, a process that may be hastened by the use of alums and by filtration.

Every case requires individual attention, and there are few cases where an improvement cannot be made.

In Chapter VI. reference will be found to the corrosion which takes place under a thick sulphate scale such as occurs in many of the low-pressure boilers of the Burton breweries.

## CHAPTER XIV

### INCRUSTATION OF PIPES

**W**HEN the flow of water through a pipe is rapid the corrosion and incrustation is worse than with gentle flow.

Chalk well water softened by the lime or Clark's process produces a clean layer of carbonate of lime inside a pipe. Hard chalk water resting in a pipe and exposed to heat, even gentle, may deposit some of its lime salt.

Surface waters, especially if at all peaty, will produce rust in pipes. It is said that water from the Old Red Sandstone will neither produce rust nor deposit, but that from the Lower Greensand will produce rust. It is often a more or less ferruginous water, and on exposure to air its soluble iron acquires a further proportion of oxygen, becoming insoluble peroxide. The process may be hastened by blowing air through the water or by sprinkling the water through the air. The change is fairly rapid, and the iron, first producing cloudiness, soon gathers as a flocculent body and is deposited, leaving the water bright and clear. Until this is complete the water ought not to be passed through pipes, for it will fill them in process of time with an ochreous mass of rust. Pipes will not rust themselves if properly treated with Angus Smith's compound of pitch and tar. Before treating they should be cleaned from end to end from each end with a revolving steel brush. They are then to be heated and dipped vertically into the melted compound, in which, while standing, they ought to be again brushed, the brush revolving each way, to remove all traces of air bubbles, for it is at the pin holes caused by air that rust always

## WATER SOFTENING AND TREATMENT

begins in a coated pipe. The Author has used glass-lined pipes for particular cases. Galvanized or zinc-coated pipes are also much used, but zinc is by no means a permanent covering, and it is soluble in rain water to some extent, for drinking of water collected on zinc roofs is a somewhat powerful dentifuge.

Water containing peaty acids particularly, and rain water also, particularly from town roofs, and perhaps all soft water, are more or less powerful solvents of lead, and much lead-poisoning has been caused in the North of England by lead pipes. In that part of the country house-service pipes are of lead and are powerfully dissolved, especially in the hot water systems. In London, where the water supply is hard and does not affect lead, the house-service pipes are of iron.

The lead solvent action is curable by a sufficient dosage of ground whiting introduced near the headworks of the water supply so as to ensure thorough mixture and solution before reaching the houses. If not thus treated to prevent its solvent action, such water should only be served through tin-lined pipes in the houses. Probably lead pipes have been used because of the rusting action of peat waters on iron pipes. When a water is safe to pass through lead or to store in lead cisterns it will produce a white-coloured lining on the lead.

Lead pipes are rendered safe by a tinned interior if this is well applied. Iron pipes are tin lined by first threading a tin pipe through the iron pipe and causing the tin tightly to expand by exposing it to a heavy hydraulic pressure.



## CHAPTER XV

### OIL SEPARATION

**I**N order to render condensed steam fit for use in a boiler it is essential to safety that the oil it now contains should be removed. Oil separation is effected both mechanically and chemically.

Chemical oil separation is effected after the greasy exhaust steam has been condensed and it may be combined with a mechanical process.

Mechanical separation is effected either before or after the steam has been condensed.

Mechanical separation is effected more or less perfectly by the De Ryeke separator, which is an enlarged length of the exhaust pipe fitted with spiral blades, designed to impose a whirling motion upon the flowing steam whereby oil and water are thrown outwards by centrifugal action and drained off.

Other mechanical separators consist of a large area of sheet metal arranged to divide the flowing steam into numerous thin layers with the object of causing every particle of oil to touch such surface which will adhere to it. Such separators demand large area and considerable volume if they are to be successful.

The De Laval cream separator has been employed to separate oil from condensed water as this flows from the condenser.

Some modification of the ordinary separator is necessary to provide for the very small proportion of "cream"—i.e. oil. The oil discharged from such a separator comes off

## WATER SOFTENING AND TREATMENT

clean and apparently fit for use again. The sudden reversal of flow is made to cause oil separation, as in Holden & Brooke's Separator (Fig. 22).

To avoid grease there is a tendency to run engines without lubrication, but it is by no means certain that this practice can be of universal application. When grease enters a boiler, no matter how finely emulsified it may be, the conditions in the boiler appear very effective in causing the oil to separate. The oil appears to adhere to the plates of the boiler or to combine with some of the scale-forming salts, especially the carbonate of magnesia or floury deposit with which it produces a spongy greasy compound which, if it should settle on any heated plate, will cause overheating.

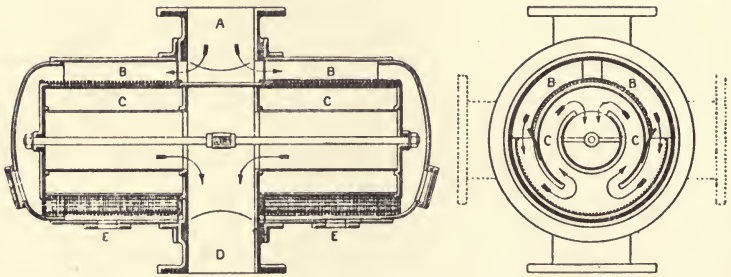

FIG. 22. HOLDEN & BROOKE.

Grease has a very peculiar effect in a boiler, for it retards the passage of heat very seriously. Stromeier says, that  $\frac{1}{8}$  in. of scale will raise the temperature of a plate  $300^{\circ}$  F., whereas less than 0.001 in. of grease will produce a far worse effect. He also states that the effects of grease are intensified where scale is also present.

Seeing that grease attaches so readily to mineral matter an effective method of clearing water from the evil is to mix it with hard water and put the whole through the customary softening operation, when the grease will disappear with the sediment.

Grease is essentially dangerous, and no effort must be spared to keep it out of boilers.

# OIL SEPARATION

## The Hooper Oil Separator.

This apparatus, as made by Lassen & Hjort, acts on the principle of admitting the greasy exhaust steam into a vessel of considerable area. This reduces the velocity of flow to a minimum. The steam has then to pass by a number of perforated plates which collect the oil and whence from their edges next the containing vessel the collected oil falls to the bottom of the separator and is drawn off when the gauge glass shows that a sufficient quantity has collected.

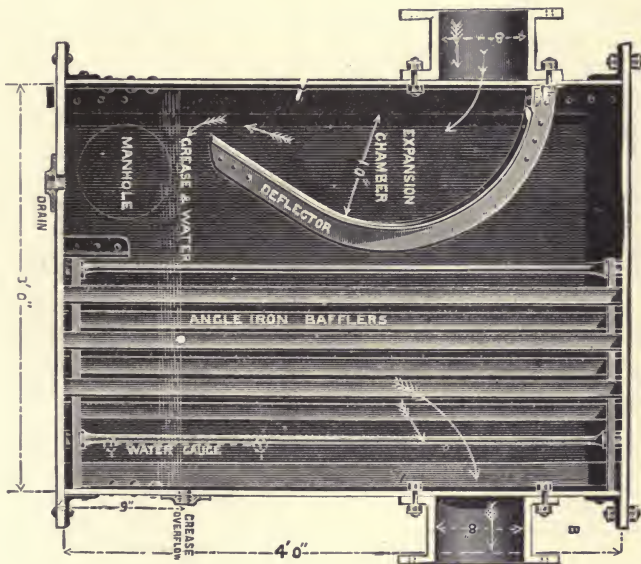

FIG. 23. BAKER GREASE SEPARATOR.

If a drop pipe can be brought down 35 ft. below the separator, it will be self-draining even when applied to the exhaust of a condensing engine. Otherwise, either an airlock must be provided or a small pump.

In the Baker separator (Fig. 23) the principles employed are wholly mechanical. These are stated as follows, and are generally applicable to all mechanical separators of static form. They are :—

## WATER SOFTENING AND TREATMENT

1. Ample capacity to allow the steam to expand, and consequently move slowly.

2. Forced contact of the steam with a surface of water which attracts and holds loose particles of oil which have been carried forward mechanically.

3. A slight lowering of the temperature of the steam, which is inevitable where expansion takes place, and at the same time a "dew-point" being reached, at which the vapour of oil begins to separate itself from the vapour of

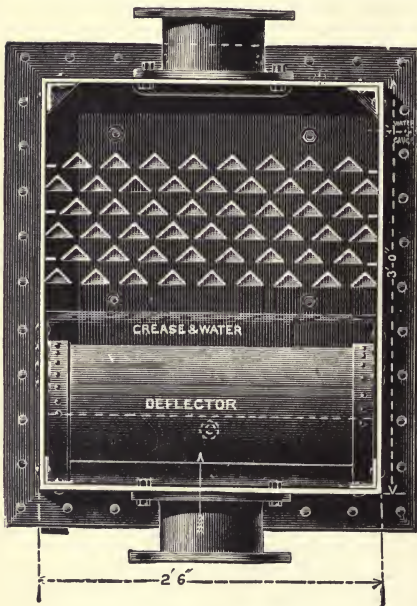

FIG. 23A.



FIG. 23B.

water, forming molecules which adhere to the first surface with which they are brought in contact.

4. A series of baffles which, dividing the steam into numerous thin streams, bring it into contact with one or another of these bafflers, which form at the same time channels for the grease to trickle down into the well at the bottom of the separator, sufficient aggregate area of steam passages must be provided necessary to avoid undue friction or back pressure.



## OIL SEPARATION

A considerable saving is claimed from the employment of separators, because the boilers are supplied with hot water (from the "hot well" at 100° F.) instead of with cold water at 50° F.

The abolition of grease also means enhanced safety for the boilers and better results from the surface condensers, which act better when their tubes are clean. Then the oil can be filtered and used again.

When, owing to the use of superheated steam there is not much water in the exhaust steam, some water must be added to assist oil separation. The greasy water discharged is collected in a large tank, and as it cools the oil separates out better and floats and may be removed for filtration. In the annexed Table VIII. are given as a guide a few dimensions of oil separators.

TABLE VIII.  
DIMENSIONS OF OIL SEPARATORS.

Pounds of Steam per Hour.	Approximate Diameter of Exhaust Pipes.	Diameter of Shell of Separator.	Height of Shell of Separator.	Face to Face of Flanges.	Approximate Weight.		
					Tons.	Cwt.	Qrs.
160	1½	1 ft. 0 in.	1 ft. 6 in.	1 ft. 10 in.	0	2	3
500	3	2 „ 0 „	2 „ 6 „	3 „ 0 „	0	8	0
3,000	6	3 „ 0 „	4 „ 0 „	4 „ 2 „	0	18	0
7,500	10	4 „ 0 „	6 „ 0 „	5 „ 6 „	2	3	0
18,000	19	5 „ 3 „	8 „ 0 „	6 „ 9 „	3	7	0
30,000	24	6 „ 6 „	9 „ 0 „	8 „ 0 „	6	3	0
60,000	24	8 „ 3 „	11 „ 0 „	9 „ 9 „	9	15	0
150,000	36	11 „ 0 „	15 „ 0 „	12 „ 6 „	16	10	0

### Chemical Oil Separation.

Complete oil separation by mechanical means is not possible. The very fine emulsion which gives a slightly milky colour to the water of condensation still persists.

In Fig. 24 is shown a magnified image of a small film of emulsified oil. The oil particles appear globular, distinct and independent.



## WATER SOFTENING AND TREATMENT

Fig. 24a, however, shows the same after treatment with alu-mino-ferric or the double sulphate of iron and alumina.

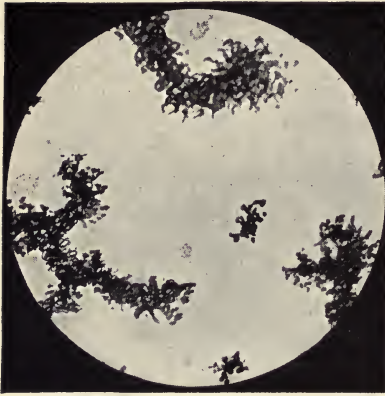

FIG. 24.

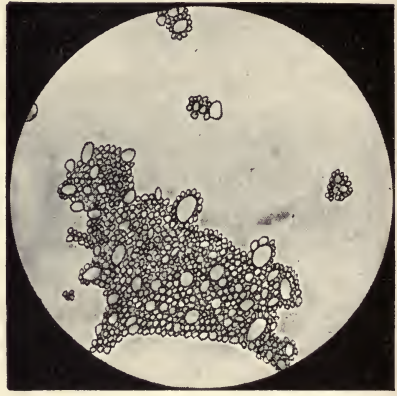

FIG. 24A.

MICRO-PHOTOGRAPHS OF GREASY CONDENSATION WATER, BEFORE AND AFTER FILTRATION.



FIG. 25.

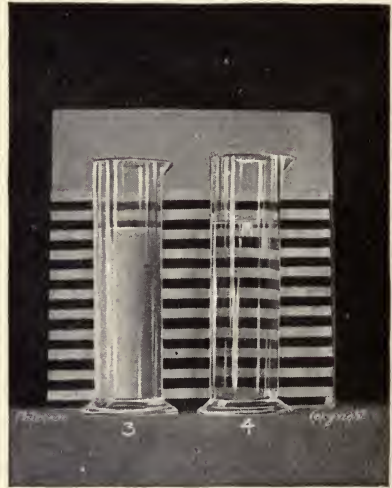

FIG. 26.

ILLUSTRATIONS OF EXPERIMENTS IN THE FILTRATION OF GREASY CONDENSATION WATER.

The effect of this is to coagulate the oil. Just what coagulation means is best shown by this microscopic enlargement.

## OIL SEPARATION

Similarly, Fig. 25, No. 1, shows the opacity of a glassful of emulsion before filtration. After filtration through an ordinary filter paper no effect is produced, Fig. 25, No. 2. The same after treatment with aluminiferrous is seen in Fig. 26, No. 3. The opacity still continues because the oil still remains in suspension and stays the passage of light.

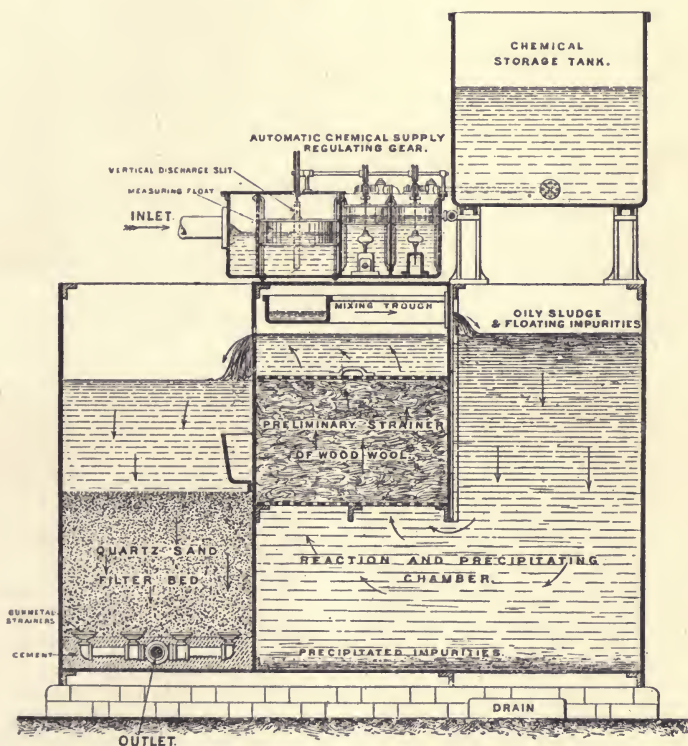

FIG. 27. PATERSON GREASE SEPARATOR.

If this treated water, however, is filtered, the effect of filtration upon coagulated oil is apparent in Fig. 26, No. 4. The only full remedy for oil is chemical treatment and subsequent filtration, and the remedy acts best when combined with the make-up water softened by the Porter-Clark process.

Examined microscopically, therefore, jars 1 and 2 would show the appearance of the micrograph (Fig. 24), while

## WATER SOFTENING AND TREATMENT

jar 3, though as opaque as jars 1 and 2, would give the micrograph (Fig. 24a). This explains why it is thus possible to filter out the coagulated oil and produce a pure clear water, as in jar 4.

Figs. 27, 28 and 29 give the plan and elevation and sec-

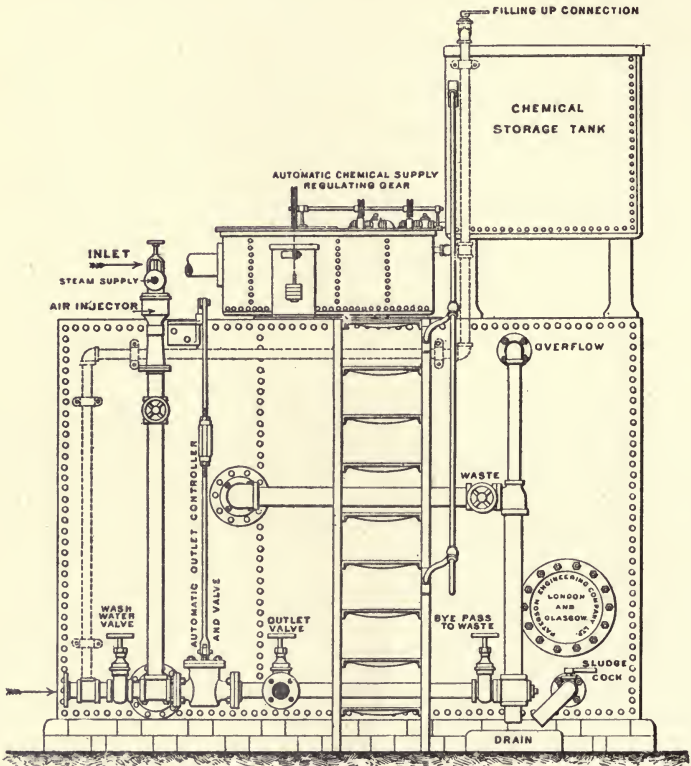

FIG. 28. PATERSON GREASE SEPARATOR.

tional elevation of the Paterson Condensation Water Purifier for the purpose of effecting the results just described.

It will be seen in Fig. 27 that the greasy condensation water, after passing through a perforated baffle plate to free it from undue agitation, enters the measuring float chamber of the automatic chemical supply regulating gear, and overflows through the vertical discharge slit or weir,



## OIL SEPARATION

shown dotted, into the mixing trough below, where it mingles with the coagulant discharged by the needle valve in the chamber adjacent to the chemical storage tank, to which it is connected by a ball valve for maintaining a constant head of reagent above the valve seat. The other valve chamber may be connected to the make-up water supply, and adjusted to add from 5 per cent. to 10 per cent. make-up at this point.

The bulk of the grease separates out on the surface of the water in the reaction and precipitating chamber in the form

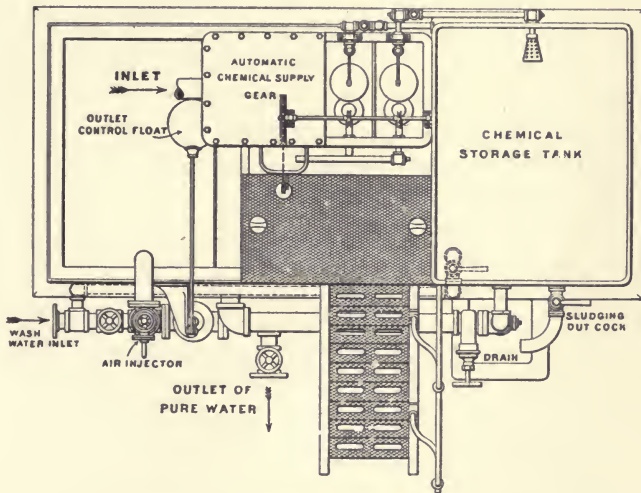

FIG. 29. PATERSON GREASE SEPARATOR.

of a thick sludge, which can be overflowed to waste when necessary. The sedimentary matter falls to the bottom and is flushed to the drain periodically. The water is partially clarified before passing into the filter by upward straining through wood-wool fibre, contained in the preliminary strainer.

The filtering medium employed is a special quartz silver sand (almost pure silica) resting upon a bed of fine pea gravel. The action of the coagulant is to form an exceedingly fine gelatinous precipitate, which seals up the interstices between

## WATER SOFTENING AND TREATMENT

the sand grains and forms an impervious barrier to the oily globules. The pure water is drawn off uniformly from the under side of the bed through a large number of gun-metal strainers, screwed into the manifold pipe system leading to the pure water outlet duct. These strainers are fitted with finely perforated renewable phosphorbronze screens. An automatic outlet controller, by throttling the outlet discharge, prevents the possibility of the filter being drained empty when running on light load.

To wash the filter the current of water is reversed through the bed and the impurities flushed over the waste gutter to the drain. This cleansing is assisted by the agitation, aëration, and sterilization obtained from forcing air through the bed by means of an air injector. Attention is required about ten minutes daily for re-charging the chemical storage tank and flushing out the filter. In electric lighting stations during the summer when the load is light, the purifier may only require attention once a week

## CHAPTER XVI

### MECHANICAL BOILER CLEANERS

**T**H**E**R**E** is a class of apparatus known as mechanical boiler cleaners, which depend for their effect on the fact that freshly separated lime and magnesia salts are often very fine and light and float at the surface. These boiler

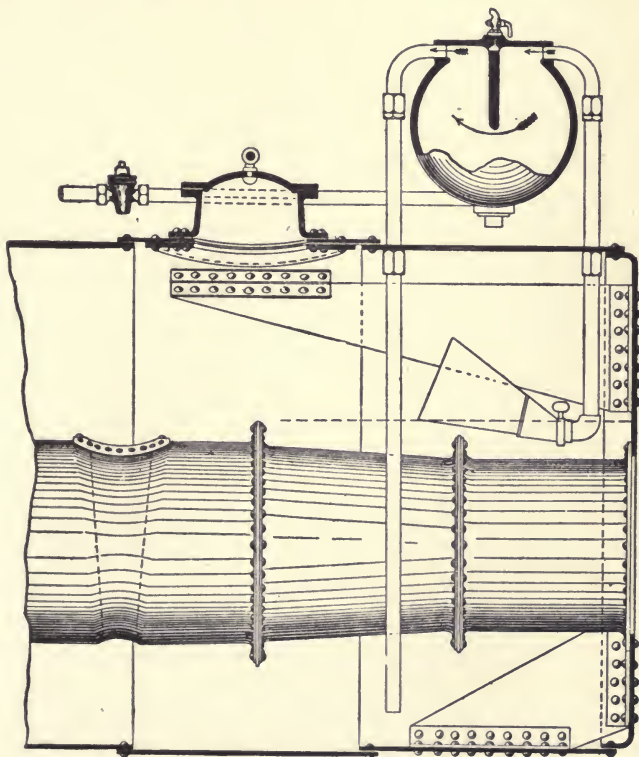

FIG. 30. THE HOTCHKISS APPARATUS.

## WATER SOFTENING AND TREATMENT

cleaners consist of a vessel placed above the boiler and connected with it by two pipes, one of which ascends from a skimming funnel placed at the water surface, while the other descends well below water level. It is found that a continuous circulation of water is maintained by reason of the fact that water in the rising pipe tends to form more or less foam as it attains a higher level and is under less pressure, whereas the descending column, entering upon horizons of greater pressure, is maintained as water. The upper vessel is divided by a diaphragm plate and the circulating water drops its sediment in the quiet vessel, whence it is blown out. In some cases the effect has been such that boilers have only required cleaning at long intervals. All the water appears to circulate through the cleaner or, at least, all the surface water carrying the new scale-forming matter. Only temporary hardness can be dealt with, any sulphate requires the help of soda in addition so as to convert the sulphate of lime to the carbonate which is then within the capacity of the cleaner to deal with.

The Hotchkiss apparatus (Fig. 30) is based on the above principles, and it is claimed to be effective, not only as a remover of the lime salts, but also of grease and oil, so that condensed greasy steam may be used in the boiler without danger. The economy of these apparatus lies in the fact that blowing-out ceases to be necessary and much heat is thus saved.



## CHAPTER XVII

### PURE WATER

**A** USUAL standard of purity for water is—

Hardness below 6°.

Chlorine not above 1 in 100,000 if of organic origin.

Nitrites and nitrates—indicative of previous sewage contamination, 0·2 to 0·3 parts per 100,000.

Ammonia salts not above 0·099 per 100,000.

Organic carbon, not over 2 per 100,000.

Organic nitrogen, not over 3 per 100,000.

Albumenoid ammonia, not above 0·0099 per 100,000.

Schomberg advises that a water may be made chemically pure by adding to each litre of water 0·06 gramme of free bromine in the form of potassium bromide. Very polluted water requires more and may be made slightly straw colour. In five minutes all injurious germs will be destroyed, and in another five minutes the addition of an equal amount of 9 per cent. ammonia solution will render the water clean and tasteless and fit to drink.

The addition of a minute fraction of sulphate of copper to water is said efficiently to destroy all bacterial life.

Pure water in the above senses is, however, not required for steam-boiler purposes and lies outside the scope of this volume, which deals with the reduction of deposit, for, both in steam raising and in manufacturing, the absence of deposit is conducive to efficiency in steam generation and good quality in the texture or colour, or both, of tanned goods, dyed goods or bleached fabrics. Rather than use any chemicals which will leave salts in solution in a boiler, such as sulphate of soda, when sulphate of lime is reduced by carbonate of soda, brewers will allow their boilers to become

## WATER SOFTENING AND TREATMENT

badly incrustated. Any salt in solution will, of course, pass over to the vats with the priming water. Experiment should show whether the usual steam dryers or water separators would not fully cure this. Dry steam will not carry salts. The Author hesitates to say if every particle of salt can be removed by a water separator and cannot say how small a proportion of sulphate of soda could be permitted in brewing. This point, however, is properly within the duty of the brewery chemist to consider, for if drying can be brought to a sufficient perfection it should pay well in fuel saved to put a stop to the very severe scaling which is found to occur in brewery low-pressure boilers using hard water.

The Author suggests that, low-pressure boilers are a mistake. The velocity of steam inside a boiler and through the outlet pipes is inversely as the absolute pressure, and priming is thus apt to be more severe with low-pressure boilers. When particularly pure steam is wanted the anti-priming pipes<sup>1</sup> in a boiler should be long and finely perforated, and even two outlet valves may be an advantage.

Pure water may be produced by the circulation of steam from a high-pressure boiler through the tubes of an evaporator. Low pressure steam may thus be raised from a scale forming water and the scale which forms on the evaporator coils can readily be removed. Unless sulphate of lime is present, needing soda to remove it, a water can be softened by lime without fear of the effects in brewing.

<sup>1</sup> See *Steam Pipes : their Design and Construction* (Constable & Co.).

## Appendix No. I

### ABSTRACT OF REPORT UPON THE INCRUSTATION IN BOILERS,

OCCASIONED BY THE ACTION OF SOME OF THE WATERS IN AND  
AROUND MANCHESTER AND THE NEIGHBOURHOOD.

BY

DR. R. ANGUS SMITH, F.R.S., F.C.S., ETC., ETC.

PART FIRST.

CHALK AND GYPSUM WATERS.

THE specimens sent to me to represent the waters of this district were of three kinds—1st, Alkaline or rather Chalk Water; 2nd, Neutral or Gypsum Water; and 3rd, Acid Water. The second is always in this district found mixed with No. 1 or 3. 1 and 3 are always mixed up with No. 2. Nos. 1 and 3 cannot occur in one specimen.

It is of course well known that all such waters are hurtful to boilers, but in very different ways. The first is hurtful because on being warmed the carbonic acid which keeps the lime in solution is driven off with the vapour of the water, and the carbonate of lime falls to the bottom in form of a crust more or less compact. This crust is a well known substance and is the source of many complaints, and the cause, no doubt, of many accidents and injuries.

As an example of crust from water belonging chiefly to the red sandstone, a specimen from Tyldesley and one from near Manchester were analysed, giving—

1. From Tyldesley :—

Carbonate of lime . . . . .	83.995 per cent.
Sulphate of lime . . . . .	3.625    ,,
Carbonate of magnesia . . . . .	8.833    ,,
Silica . . . . .	3.000    ,,
Oxide of iron and alumina . . . . .	0.500    ,,
	<hr/>
	99.953
	<hr/>

## WATER SOFTENING AND TREATMENT

### 2. From Manchester :—

Carbonate of lime with oxide of iron . . . . .	70·108 per cent.
Sulphate of lime . . . . .	3·220 „
Carbonate of magnesia . . . . .	21·876 „
Silica . . . . .	4·795 „
	99·999

Many attempts have been made to remove the crust without the use of the hammer, and many attempts have also been made to prevent its formation. The necessity of removing it by force occurs at intervals of days, weeks, or months, according to the amount of lime in the water and the amount of water evaporated. This mechanical method of removal must certainly be injurious to the boilers. Not to mention the great amount of vibration to which they are exposed by the process of hammering, a certain amount of oxide of iron is always removed by each removal of crust. This, of course, is soon succeeded by another coating, and the process of rusting is thereby facilitated.

To prevent the formation of the crust, it has been proposed to coat each particle of lime at the moment of its escape from solution with an organic substance, such as starch or mucilage, or any cheap material soluble to some extent in water. Such substances have been found in potatoes, buttermilk, gelatine, fish, blood, and oily or waste oleaginous matter, and we may add all the soluble parts of plants. When the carbonic acid leaves the water, the particles of carbonate of lime which are then allowed to fall cannot approach so closely to each other as in pure water, and instead of uniting into a compact body, they remain in a separate condition and form with the water a mass of mud. This mud is blown off from the boiler at given intervals, according to the circumstances of the case.

These methods are generally found sufficient for a short time, but seldom for a long one.

A cleaner and much more beautiful method was proposed some years ago. It consisted in the use of chloride of ammonium or sal-ammoniac. When this salt is boiled with carbonate of lime, the chlorine unites with the calcium and forms chloride of calcium, which is very soluble in water; the ammonia goes with the carbonic acid into vapour. I am told that the process is, or at least has been, used a good deal on the railways in the South of England, where the water contains carbonates of lime and magnesia, with frequently no more than a small trace of any other salt. Sal-ammoniac costs about £35 a ton. A ton will serve for about a million gallons of the water of the Thames.



## APPENDIX

When muriate of ammonia or sal-ammoniac is boiled in solution in water, some ammonia is given off and the acid remains. This acid (muriatic) dissolves iron unless a large amount of lime be present. The boilers are, of course, attacked by an excess of it. It is probable also that the ammonia or carbonate of ammonia given off in this process may come into contact with brass or copper, to which it is apt to be injurious.

When water, such as the first class or chalk water, is to be treated, the process of Professor Clark is by far the best. This process consists in adding caustic lime to precipitate the carbonate of lime or chalk. But neither of these processes fits well the waters of this district. Clark's process has not been found convenient for waters containing only 5 or 6 grains of carbonate of lime, although with great care it may be made to apply to them. Neither Clark's process nor the sal-ammoniac process has any effect on the sulphate of lime contained in water.

The waters around Manchester may be considered as represented by the following analysis, which represents no one specimen in particular—although nearly that of the old water supply. [*i.e.* prior to Longdendale. W.H.B.]

Carbonate of lime, 6 grains per gallon ;  
Sulphate of lime, 8 grains per gallon ;  
Carbonate of magnesia, 1 to 2 or 3 grains per gallon.

By Clark's beautiful process, 28 grains of caustic lime throw down 50 grains of carbonate of lime from the water, and become themselves converted into other 50 grains of carbonate of lime. By this means 28 grains of caustic lime thrown into a solution of carbonate of lime in water cause the precipitation of 100 grains of that salt. The lime when it exists in solution in water is made, properly speaking, a bi-carbonate, as, besides water to keep it in solution, there is also carbonic acid. The precipitate falls down white and like fine chalk, which it really is. If there be organic matter existing in the water the lime attaches itself to a large proportion of it, and the precipitate is thereby darker according to the amount of impurity, whilst the water is proportionately clear. This plan throws down, in many cases, also as much of the magnesia as may be in a state of carbonate. The sal-ammoniac process acts also on the carbonate of magnesia. It might be said that even with such waters as we have near Manchester this plan could be adopted, if great care were to be taken to remove the carbonate of lime ; the sulphate remaining, being soluble, would not form a crust, if it were blown off before the solution became extremely concentrated. I will not say that this is impracticable, but it seems to require more refinement than we can expect, as I have just been presented

## WATER SOFTENING AND TREATMENT

with a specimen of crust of extreme hardness, which, on analysis, gives 78·16 per cent. of sulphate of lime.

The existence of this crust is of itself a sufficient proof of the great importance of removing the sulphate of lime as well as the carbonate. The crust made by the former is generally harder and more difficult to remove, whilst it is scarcely possible to affect it by any chemical method. At the same time it must be added that there are waters in Lancashire to which this process of Professor Clark's can most readily be applied, such as some from parts of the red sandstone, and contain 12 to 15 grains of carbonate of lime per gallon, with very little sulphate. The necessity of overcoming the difficulty presented by the sulphate of lime induced me to make many trials; the results of the most practicable will be here given. It is known that carbonate of soda throws down the lime from sulphate of lime, or rather decomposes the salt. If we add carbonate of soda to a water containing sulphate of lime or gypsum, carbonate of lime falls down, and sulphate of soda remains in solution. Now, sulphate of soda is an extremely soluble salt, it is extremely innocent, and would rarely require blowing off.

By two processes, then, the whole of the lime may be removed from the water. One process by caustic lime removes the carbonate, and another process by carbonate of soda removes the sulphate. As it is found that a small amount of carbonate of lime does not precipitate well, this additional quantity derived from the sulphate will assist it in rapidly falling.

It is not agreeable to render anything complicated, and one process has already been found too much. By a little consideration we can convert these two processes into one.

Caustic soda, when added to a solution of carbonate of lime in water, or a solution of bi-carbonate of lime, takes up the carbonic acid exactly in the same manner as caustic lime, and precipitates carbonates. (This is similar to Clark's process, but so far is inferior that the caustic soda will not itself fall out of the water.) In doing this the caustic soda becomes carbonate of soda, which, as we have seen, decomposes sulphate of lime. Now, if we add caustic lime to carbonate of soda, we obtain caustic soda. By the use of caustic soda, then, we unite the two processes into one. Again, as caustic soda is formed by the mixture of lime and carbonate of soda, we may use them together for precipitation, or we can make the caustic soda separately and then use it. When rapid precipitation is wanted the lime and carbonate of soda are best used together; when a large precipitate is to be avoided, then it is better to use the caustic soda alone.

*Carbonate of soda and lime* are equivalent to *caustic soda* used alone. 31 grains of dry caustic soda will throw out of solution

## APPENDIX

50 grains of carbonate of lime. 28 grains of lime do the same, but they fall down also and make the precipitate 100 of carbonate of lime. Soda, therefore, causes a less bulky precipitate than lime when chalk alone is to be treated in the water, because the soda, instead of falling like the lime, remains in the solution. But now comes the chief difference. When the caustic soda has removed the carbonate of lime, it becomes converted into carbonate of soda, and this carbonate of soda acts upon the sulphate of lime, forming carbonate of lime again and sulphate of soda. The whole of the lime, therefore, falls in whatever condition it be, and a little sulphate of soda only remains. The salts in the water are composed thus :—

<i>Lime</i>	. . . . .	Carbonic acid.		
		Carbonic acid.		
<i>Lime</i>	. . . . .	Sulphuric acid.		

Add caustic soda and we have—

<i>Lime</i>	. . . . .	Carbonic acid.		
<i>Soda</i>	. . . . .	Carbonic acid.		
<i>Lime</i>	. . . . .	Sulphuric acid.		

Which again breaks up into—

<i>Soda</i>	. . . . .	Sulphuric acid, or sulphate of soda.		
<i>Lime</i>	. . . . .	Carbonic acid, )		
<i>Lime</i>	. . . . .	Carbonic acid, ) or carbonate of lime.		

These two latter portions of carbonate of lime fall together, and the sulphate of soda remains.

As many persons who read this will not understand chemical symbols, I have used the full words ; chemists can easily translate it into their formulas. It might be shortly written so—

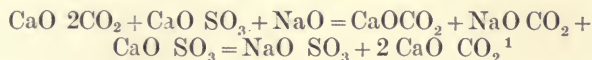

Carbonate of magnesia and sulphate form similar compounds and undergo the same decompositions, according to circumstances to be noticed. Let us apply the decomposition to the normal water around us containing 6 grains of carbonate of lime dissolved in carbonic acid and water, and let us suppose 8·16 grains of sulphate of lime. Add 3·72 grains of caustic soda ; these at once become 6·36 grains of carbonate of soda, and 6 grains of carbonate of lime fall. The 6·36 grains of carbonate of soda attack the 8·16 grains of sulphate of lime and become 8·52 of sulphate of soda, whilst other 6 grains of carbonate of lime fall. Altogether there

<sup>1</sup> In the present day notation for Na read Na<sub>2</sub> in each case. The present atomic weight of Na is 23 to oxygen = 16.—AUTHOR.



## WATER SOFTENING AND TREATMENT

are 12 grains thrown down, and the soda is made to act twice decomposing the salts. The first action is by absorbing an acid; the second is by changing this acid for another. Used in this manner 31 grains of caustic soda throw down 100 grains of carbonate of lime.

If any one will say that the soda goes to the sulphuric acid at once, and not in the method I have pointed out, I shall only add that the result will be exactly the same.

If grains are not found agreeable as units, it is, of course, easy to make the calculations on a larger scale. If we use 7,000 gallons of water, our numbers will remain the same, pounds taking the place of grains.

7,000 gallons of water, such as mentioned, contain—  
6 lbs. of carbonate of lime,  
8.16 lbs. of sulphate of lime,  
add 3.72 lbs. of caustic soda,  
the result is 8.52 lbs. of sulphate of soda in solution.  
and 12 lbs. of carbonate of lime thrown down.

Thus, as before, 28 lbs. of lime remove 50 of carbonate of lime from chalk waters.

31 lbs. of soda remove 100 of carbonate of lime from mixed waters such as this.

Soda, therefore, removes nearly double the quantity removed by lime, in the case of mixed chalk and gypsum waters, but the price is about 20 times greater than that of lime. The process will, therefore, be 10 times more expensive than the lime process. It is, however, scarcely fair to compare the two, as the lime process will not answer the purpose in view. Let a ton of carbonate of soda cost £10, the caustic soda in it and the lime used would cost about £18. The calculation of 20 times is, therefore, rather low. However, a ton of soda costing about £18 would precipitate 2,107,527 gallons of water, with 12 grains of carbonate of lime in solution, or 4,215,054 of mixed water, such as we have in view.

It may be asked, in what way the precipitant should be used. I believe the best of all methods is to have a tank for precipitation, and when the clear water remains after the fall of the lime, it may be transferred to the boiler. As the precipitation occurs very rapidly, it would not be needful to have more than a day's supply of prepared water. I believe that, in many cases, a few hours' supply would be enough. According to experiments made to try Professor Clark's process, six hours' supply, or even less, would be enough.

Caustic soda is made by adding slaked lime to carbonate of soda.



## APPENDIX

	Carbonate of soda.	Caustic lime.
1 ton of caustic soda (dry) is made by	3829·6 lbs.	and 2023 lbs.
	= 34·19 cwt.	,, 18·06 cwt.
	or 34 cwt. 21 lbs.	
112 lbs.	191 lbs.	and 101·15 lbs.
1 lb. or 7,000 grains	11967·7 grains	,, 6322·1 grains.
	or 27·36 ounces or 14·4 ounces.	

To prepare caustic soda the carbonate of soda is, of course, used in solution. It is better warmed, but this is not needful; the warmth of newly-slaked lime assists the action. As it is not possible to weigh the caustic soda dry, and not convenient to weigh it in any condition, I shall make the calculations on the amount of carbonate converted into caustic.

Amount of carbonate of soda to be  
converted into caustic and used for  
1,000 gallons of the water to be treated.

	in solution in a gall. water	
Supposing 1 gr. carbonate lime to exist		1060 grains.
,, 2 grains	,, ,,	2120 ,,
,, 3 ,,	,, ,,	3180 ,,
,, 4 ,,	,, ,,	4240 ,,
,, 5 ,,	,, ,,	5300 ,,
,, 6 ,,	,, ,,	6360 ,,

and so on. This is equal to 2·42 ounces of carbonate of soda for 1,000 gallons of water for every grain of carbonate of lime per gallon. This will also precipitate the lime from the sulphate at the rate of 8·16 grains of sulphate for every six grains of carbonate.

If sulphate of lime should exist in the water alone, the carbonate of soda may be used by itself without adding lime to reduce it to caustic soda, although it is better to add a minute quantity of caustic soda in order to remove the small amount of carbonic acid dissolved even in such waters. In this case the amounts used will be—

	Carbonate of soda for 1,000 gallons.
For 1 grain of sulphate of lime in a gallon of water, use .	779·4 grns.
,, 2 grains	,, . 1558·8 ,,
,, 3 ,,	,, . 2338·2 ,,
,, 4 ,,	,, . 3117·6 ,,
,, 5 ,,	,, . 3897·0 ,,
,, 6 ,,	,, . 4676·4 ,,
,, 7 ,,	,, . 5455·8 ,,
,, 8 ,,	,, . 6235·2 ,,

This is equal to 1·78 ounce of carbonate of soda per 1,000 gallons for each grain of sulphate of lime per gallon.

## WATER SOFTENING AND TREATMENT

For salts of magnesia :—

	Carbonate of soda made caustic and added to 1,000 gallons of water.
For 1 grain of carbonate of magnesia in a gallon, use ..	1261·9 grns.
„ 2 grains „ „ „ „ ..	2523·8 „
„ 3 „ „ „ „ „ ..	3785·7 „

This is equal to 2·88 ounces of soda per 1,000 gallons for each grain per gallon.

For sulphate of magnesia existing where there are no carbonates the amounts are as follow—

	Grains of carbonate of soda reduced to caustic and added to 1,000 gallons of water.
For 1 grain of sulphate of magnesia per gallon, use ...	883·33 grns.
„ 2 grains „ „ „ „ ...	1766·60 „
„ 3 „ „ „ „ „ ...	2649·90 „

This is equal to 2·01 ounces of carbonate of soda per 1,000 gallons for each grain of sulphate of magnesia per gallon.

It is not needful to add any soda to precipitate the sulphate of lime or magnesia unless existing in a greater proportion than 8·16 of sulphate of lime to 6·0 of carbonate.

There are cases where special calculations must be made ; for example, where there are mixtures of carbonates and sulphates of lime and magnesia, but I fear to complicate the matter.

The precipitation by caustic soda is not exactly a novelty, but I have not seen it carefully examined, and the examination and full explanation of the matter are somewhat new. Mr. Thom, of Birkacre, Chorley, has used it for some time there, and at Mayfield some time before 1847. I recommended it in one case several years ago. Mr. Thom found the complete removal of lime by soda to be very valuable when printing delaines. The soap made with the lime a coating which became yellow when heated, and injured the whites. The double action on the carbonates and sulphates of lime has not, as far as I know, been noticed.

I am aware of certain advantages occasionally received from having a small amount of impurities suspended in the water. If a boiler be inclined to leak slightly, even if in good order or quite new, a little mud in the water gradually fills up the spaces—too small to be found by the eye, and not easily cured by the hammer. This is a most legitimate use of insoluble matter, and I do not suppose that it is advantageous to have the metallic surface of the iron within the boiler completely exposed. Anything which exposes it constantly is apt to prepare the way for a new oxidation. But there is no fear of this great purity of water, it is not easy to keep it long in the boiler even in a moderate condition of clearness. However, the use of a little lime or muddy water, to fill up minute crevices, is very different

## APPENDIX

from the constant accumulation of mud in the boiler. I have tried silicate of soda by itself as a precipitant, but without any success. One of the substances sold for preventing crust has been brought to me when writing this ; it is composed of caustic soda and carbonate, as well as soap.

### EXPERIMENTS RELATING TO THE PRECIPITATION OF LIME AND MAGNESIA.

Nearly all the lime may be precipitated, and practically we may say that all may be. The following are fair specimens of what may be obtained in practice—

On using strong solutions of carbonate of lime, the amount left in solution was when—

	Not Precipitated.
Precipitated by caustic soda . .	1·06 grains per gall.
" " lime . .	1·23 " "

When tried on specimens of water sent by Messrs. Clegg, of Tyldesley—

Specimen 1, amount of lime left in a gallon .	Grains.
" 2, " "	0·80
" 3, " "	1·06
" 4, " "	0·13

When these specimens were precipitated with great care and kept free from the influence of the air, the whole was thrown down. If removed too early, the precipitate is not found at the bottom ; if allowed to stand too long, a little becomes dissolved. On a large scale we cannot go farther into minutiae.

When sulphate of lime exists in the water the amount precipitated was as follows—carbonate of soda being used—

Grains of Sulphate of lime in the Gallon of Water.	Amount of Carbonate of lime to which the Sulphate is equal.	Amount of Carbonate of lime actually recovered.
5·000	3·670	3·57
4·000	2·940	2·94
3·090	2·270	2·26
3·000	2·200	0·68
1·615	1·187	1·13
1·292	0·950	0·93
0·969	0·712	0·71
0·646	0·475	0·20

In nearly every case the third column is equal to the second, showing a complete removal of the lime.

In another case water was precipitated by these four agents, with the following results—

## WATER SOFTENING AND TREATMENT

	Grains of Carbonate of lime removed.
By caustic soda . . . . .	6.46
„ caustic lime . . . . .	2.66
„ soda lime . . . . .	3.33
„ carbonate of soda . . . . .	0.55

This water contained carbonate of lime ; the carbonate of soda is introduced merely to show that it can be of no advantage in this case unless made caustic. I find that caustic soda precipitates carbonate of lime in a laboratory with much more facility than caustic lime does, and when a little excess is added, it is allowed to gather carbonic acid from the air without forming a crust such as lime forms. But this is not an objection to lime when used on a large scale, as the water is then put in motion and no crust forms ; besides it is possible on a large scale entirely to avoid excess.

I was not so fortunate in precipitating sulphate of magnesia when it existed alone in the water. Indeed, when the precipitate was allowed to stand long, absolutely nothing was to be got. In the following five experiments 0.08 gr. remains, about the weight of two filters—

Amount of sulphate in solution . . . . .	12.50	10.00	7.50	5.00	2.50
Amount of precipitate . . . . .	0.08	0.08	0.08	0.08	0.08

A fair specimen of the experiments with carbonate of soda and a little caustic soda, is—

Grains of Sulphate of magnesia in solution.	Grains of Carbonate of magnesia.	Carbonate of magnesia, precipitate.
5.0	= 3.5	. . . 1.60
3.0	= 2.1	. . . 2.07
2.0	= 1.4	. . . 1.14

This shows that there is a possibility of entirely removing it. When precipitated along with lime there is less need of care, and three results gave of carbonate remaining unprecipitated—

Grains in a gallon. . . . . 1.30    0.82    0.407 grains.

But, again, another gave 3.7, this depending on the management of the precipitate, as explained, and partly on the amount of alkaline salts in the water. At the same time, the precipitation of the magnesia from the sulphate of magnesia is not of importance, as that salt is so very soluble as to be incapable of making a crust unless with the greatest carelessness, and even then water would be sufficient to remove it.



## APPENDIX

### SUMMARY.

I will now sum up the conclusions to which I have come relating to these classes of waters :—

1. That chalk waters are best treated by Clark's process ; that is, by caustic lime.

2. That mixed chalk and gypsum waters can be precipitated completely by caustic soda.

3. That gypsum waters may be precipitated by carbonate of soda, with the addition of a minute quantity of caustic soda.

4. That these precipitations are far more elegant, complete, efficient, and satisfactory when made in a separate vessel, the pure water alone entering the boiler.

5. That in many cases the precipitation answers very well conducted in the boiler.

### RULES FOR WATERS (1 AND 2) AND THEIR MIXTURES.

#### *Rule 1.*

Water No. 1.—Carbonate of lime alone in the water.

The following is the method of treating 1,000 gallons—

For every grain of carbonate of lime, per gallon = 1,000 grains per 1,000 gallons, use 1,060 grains of carbonate of soda, made caustic with 560 grains of burnt lime.

#### *Rule 2.*

Water No. 2.—Sulphate of lime in the water.

Treat 1,000 gallons so—

For every grain of sulphate of lime, per gallon = 1,000 grains per 1,000 gallons, use 779·4 grains of carbonate of soda.

#### *Rule 3.*

Nos. 1 and 2.—Mixed.

- a. For every grain of carbonate, per gallon, add according to Rule 1.
- b. When the sulphate of lime is not above 8 to 6 of carbonate neglect it entirely.
- c. If there be any sulphate beyond that amount, treat it according to Rule 2.

### QUESTIONS REQUIRING INVESTIGATION.

Effect of perfectly pure water in a boiler.

Effect of water containing only a little carbonic acid.

Effect of precipitation in a boiler both by soda and by lime.

Fuller account of substances sold for preventing and destroying crusts.

## WATER SOFTENING AND TREATMENT

I shall now add the analysis of some waters which have been sent to me from this district, and some others previously examined.

### WATER SENT BY THOMAS CLEGG & Co., OF TYLDESLEY.

No. 1 is from a well at Tyldesley.

No. 2 is from the brook in the morning.

No. 3 is from the brook at noon.

	Grains per gallon.		
	No. 1.	No. 2.	No. 3.
Carbonate of lime . . . . .	8·119	4·04	3·47
Sulphate of lime . . . . .	8·570	18·83	19·97
Carbonate of magnesia . . . . .	7·700	7·94	5·57
Oxide of iron . . . . .	0·220	0·75	0·72
Silica . . . . .	0·850	1·74	1·51
Chloride of sodium, alkaline carbonates, and loss . . . . .	1·341	0·50	—
Inorganic matter . . . . .	27·80	33·8	31·24
Organic matter . . . . .	3·85	4·6	4·00
Total . . . . .	31·68	38·4	35·24
Hardness . . . . .	23·00	21·0	21·00
Hardness after liming . . . . .	9·50	12·9	12·60

No. 3 analysis is exact in the lime, which is the essential point and was more than once ascertained; also in sulphates; but the alkalies and the magnesia are a little uncertain. However, as it was an accidental condition of things, on account of water flowing from other works, it was not worth the trouble of ascertaining it more exactly; it would not be the same two days together.

### WATER FROM DEEP WELL AT SEEDLEY PRINT WORKS.

Sulphate of lime . . . . .	2·714	grains per gallon.
Carbonate of lime . . . . .	6·115	,,
Carbonate of magnesia . . . . .	2·050	,,
Silica . . . . .	0·360	,,
Carbonic salt . . . . .	1·650	,,
Other alkaline salts, and loss. . . . .	0·111	,,
Total inorganic matter. . . . .	13·000	,,
Hardness . . . . .	10·9	degrees.
Hardness after boiling . . . . .	5·2	,,
Hardness before liming . . . . .	5·2	,,
Alkalinity . . . . .	5·6	,,

## APPENDIX

### SPRING WATER AT SEEDLEY.

Sulphate of lime . . . . .	9.45	grains per gallon.
Carbonate of lime . . . . .	1.51	,,
Magnesia =		
Carbonate of magnesia . . . . .	4.74	but most as chloride, and to be treated as if carbonate.
Silica . . . . .	0.61	,,
Oxide of iron . . . . .	0.66	,,
Alkaline salts . . . . .	0.49	,,
	<hr/>	
Total inorganic matter . . . . .	17.46	,,
	<hr/>	
Organic and volatile matter . . . . .	5.20	some of this is nitric acid from nitrates in the water.
Hardness . . . . .	16.50	degrees.
After boiling . . . . .	10.50	,,
After precipitating by lime.	10.45	,,
Alkalinity . . . . .	2.40	,,
Chlorine in a gallon . . . . .	0.42	the alkalies not sepa- rately determined.

### BROOKS NEAR LEVENSHULME.

	1	2
Carbonate of lime . . . . .	11.52	2.76
Carbonate of magnesia . . . . .	2.09	4.04
Sulphate of magnesia . . . . .	1.06	0.51
Sulphate of soda . . . . .	2.65	2.50
Sulphate of potash . . . . .	1.76	1.56
Chloride of magnesium . . . . .	0.69	1.32
Silica . . . . .	0.52	0.34
Oxide of iron and alumina . . . . .	0.50	0.14
Nitrate of magnesia . . . . .	0.69	—
	<hr/>	<hr/>
	21.48	13.17
Error in excess . . . . .	.08	
	<hr/>	
Total obtained . . . . .	21.40	

### WATER FROM NEAR BURY.

	Surface.	Well.
Sulphate of lime . . . . .	1.265	1.292
Sulphate of magnesia . . . . .	0.363	3.950
Carbonate of magnesia . . . . .	0.110	3.000
Silica . . . . .	0.750	0.320
Alkaline salts . . . . .	0.980	2.420
	<hr/>	<hr/>
Inorganic matter . . . . .	3.468	10.980
Organic matter . . . . .	0.780	1.740

The first needs no treatment—the second very little.

# WATER SOFTENING AND TREATMENT

## WATERS FROM WIGAN.

### *Specimens of Surface Water.*

	1	2	3
Sulphate of lime . . .	8·67	9·72	5·77
Carbonate of lime . . .	1·78	0·48	4·65
Phosphate of lime . . .	0·06	0·02	slight
Carbonate of magnesia . . .	1·89	1·44	4·67
Oxide of iron . . .	0·05	0·42	0·06
Chloride of potassium . . .	0·54	0·43	0·51
Salts of soda . . .	4·07	1·53	0·54
Silica . . .	0·45	0·63	0·48
Organic matter . . .	6·00	15·40	5·82
	23·41	30·07	22·50
Inorganic matter . . .	17·41	14·67	16·68

In analysing waters for practical purposes, I find it much more convenient to put the sulphuric acid first to the lime. It is in fact necessary, in order to obtain the end in view, although it may be objected to on theoretical grounds.

### PART SECOND.

The water from Rochdale Canal has frequently been complained of, on account of the property it has of dissolving iron and of causing the oxidation of still more of that metal than it can dissolve. I first heard at Littleborough of this quality of the canal water, and obtained a specimen from that village. I found it to be slightly alkaline, and not to contain much carbonic acid. Further inquiry, however, showed a very different condition of things. The acidity at Littleborough has been found to be equal to the saturation of 0·070–0·140 grains of carbonate of soda per gallon. At 0·140 the amount in sulphuric acid would be equal to 0·101 or 101 grains in 1,000 gallons.

Near Manchester the acidity in the canal rises higher, and has been found equal to 3·99 grains of carbonate of soda per gallon, although in Ancoats it was generally alkaline or neutral. 3·99 grains must be considered a very large amount when it is in contact with iron.

The mode of dealing with such water is simple, as it only requires to be treated with an alkali. For the specimen taken near Manchester the amount of carbonate of soda necessary is 3·99 grains per gallon, or 1 lb. to 1,754 gallons. Lime will also neutralize the acidity, but it is preferred not to add lime.

The amount of carbonate of soda required for neutralizing water of 0·070 acidity, such as is frequent at Littleborough, is 70 grains per 1,000 gallons.



## APPENDIX

Amount required to neutralize 1,000 gallons of water of the acidity of 3·99—

Carbonate of soda . . . . .	3,990 grains = 9·12 ounces.
or Caustic lime . . . . .	2,031 „ = 4·6 „
Amount of water neutralized by 1 lb. of Carbonate of soda . . . . .	1,754 gallons.
Amount of water neutralized by 1 lb. of Caustic lime . . . . .	3,446 „

When soda is used this neutralization may take place in the boiler without causing much inconvenience, the amount of precipitate not being great, especially in the case of the Littleborough water. If lime be used, it is much better to have a separate vessel or tank for the mixture. In any case there is no difficulty in curing this evil which has been so widely complained of.

### Rochdale Canal at Littleborough—

Sulphate of lime . . . . .	1·916
Sulphate of magnesia . . . . .	0·642
Chloride of magnesium . . . . .	0·318
Chloride of iron . . . . .	0·467
Silica . . . . .	0·380
Other salts . . . . .	0·187
	3·900
Organic matter . . . . .	1·040
Hardness . . . . .	0·140
Acidity—when acid . . . . .	0·070

### Rochdale Canal, near Newton Heath—

Sulphate of lime . . . . .	2·50
Sulphate of magnesia . . . . .	1·90
Chloride of iron . . . . .	0·28
Silica . . . . .	0·75
Alkaline salts . . . . .	2·26
Sulphate of alumina . . . . .	0·09
	7·03

### Rochdale Canal, at Messrs. M'Connel's, Ancoats—

Sulphate of lime . . . . .	4·12
Sulphate of magnesia . . . . .	2·88
Sulphate of iron . . . . .	0·43
Alumina and oxide of iron . . . . .	0·14
Alkaline salts . . . . .	1·49
	9·06

## WATER SOFTENING AND TREATMENT

Hardness . . . . .	6·20
Alkalinity . . . . .	0·07

---

In order to obtain a complete answer to all the questions suggested by the varying acidity of the Rochdale Canal, it would be necessary to have very numerous examinations made at various times and in many places. Many causes contribute to its acidity, but I am inclined to think that one only renders it peculiarly hurtful to boilers. The water at Littleborough was from 0·07–0·14 of acidity, but some taken from a boiler which had been boiling down for a month was 9·8, whilst another rose to 21·3. This was, in fact, a solution of iron. When the acid water at Littleborough was boiled down far, it gave off muriatic acid, and when boiled still farther, almost to dryness, it gave off sulphuric acid. A minute quantity of alumina was got in solution. These facts indicate the existence of waters flowing into the canal having acid salts in solution, sulphates of iron, and of small quantities of alumina. Indeed the existence of such water is not a supposition, although I have not inquired at what point it enters the canal. Possibly it may flow in at various points. At Littleborough a manufacturer was using water from a well near the canal strongly impregnated with sulphate of iron. He used it to avoid the water of the canal, but he had chosen the worse, and the deposit from the boiler was rich in oxide of iron. This will point out one source from which the canal obtains impure water; there may be thousands of others. Or, as the water is not at all times equally acid, the acidity may rise from occasional discharges from coalpits also, or even from manufactories. In one other respect the water of Littleborough has a slightly increased inclination to act on metals, both lead and iron, because of the greater amount of chlorides in it than waters from the hills generally contain. In this respect even the water which is not acid will be injurious when it has been much boiled down. The amount of chlorides found in water from a boiler was just 70 times greater than in the canal water, so much greater that the solution of the sulphate of lime was prevented. From this water alkalies throw down a bulky white precipitate.

On trying the action of Rochdale Canal water at Littleborough and of Manchester pipe water in dissolving iron wire, I found that in a month the canal water had oxidized 6·7 per cent., and the Manchester water only 4·07. This, of course, was under circumstances favourable to oxidation; boilers are not often acted upon so violently.

Peaty matter is another cause of the acidity of water. The moss water is alkaline, in warm autumns especially, becoming acid in winter. I should expect this acid to act although slightly

## APPENDIX

on the boilers, but experiments have not yet favoured that view, although I have obtained water from Dumfriesshire much browner than any water to be found in Lancashire, and also very acid from humic or peaty acids. Although this is interesting, and will probably engage my attention, it has only a limited bearing on the manufactures of the neighbourhood. The Littleborough reservoir, when tried in December 1859, was found to be decidedly alkaline ; at the same time the canal was neutral at Littleborough. The variations are many, and scientifically it might be interesting to inquire into many questions readily suggested to a chemist ; but practically I can only add, that the acidity must be removed by alkali, and even when this is done it is necessary to empty the boiler or blow out a large portion of the water at frequent intervals. These intervals must be more frequent, according as the situation is nearer Manchester.

Mr. M'Connel was kind enough to give me a great deal of information and to supply me with many specimens ; I did not analyse all of them fully, as I found that they were not acid, and that their action on the boiler chiefly arose from their containing a good deal of chlorine, and being unprotected by alkalinity.

### RULE FOR ACID WATERS.

Add carbonate of soda, or an alkali. A degree of acidity is the same as the amount of carbonate of soda required to neutralize it. Therefore, for every degree of acidity add one grain of carbonate of soda per gallon. For 0·10 deg. add 0·10 of carbonate of soda per gallon, made caustic or otherwise.

I would prefer carbonate of soda, and to precipitate in a separate vessel. In this way not only is the acid removed, but the gypsum decomposed according to the rules in Part First. Before the canal approaches near Manchester, the water contains so little lime that this precaution is less required.

## Appendix No. 2

### TABLE IX.

SOLUBILITY OF GASES IN WATER AND ALCOHOL (BUNSEN).

Gas.	Volume of gas dissolved in 1 Vol.			
	Of Water.		Of Alcohol.	
	At 32° F.	At 59° F.	At 32° F.	At 59° F.
Ammonia	1049·6	727·2	—	—
Hydrochloric Acid	505·9	458·0	—	—
Sulphurous Acid . .	68·86	43·564	328·62	144·65
Sulphuretted Hydrogen	4·37	3·2326	17·891	9·539
Chlorine . . . .	Solid.	2·368	—	—
Carbonic Acid . . .	1·797	1·002	4·3295	3·1993
Protoxide of Nitrogen	1·305	0·0778	4·1780	3·2678
Olefiant Gas . . .	0·2563	0·1615	3·5950	2·8825
Binox. of Nitrogen	—	—	0·31606	0·27978
Marsh Gas . . . .	0·0545	0·03909	0·52259	0·4828
Carbonic Oxide	0·03287	0·02432	0·20443	0·20443
Oxygen . . . . .	0·04114	0·02989	0·28397	0·28397
Nitrogen. . . . .	0·02035	0·01478	0·12634	0·12142
Air . . . . .	0·02471	0·01795	—	—
Hydrogen . . . .	0·01930	0·01930	0·06925	0·06725

All gases are more or less soluble in water and the solubility increases as the elasticity of a gas decreases. Hence the increase at lower temperature and greater pressure.

Dr. Henry stated that the volume of a gas dissolved was the same at all pressures for any given temperature. Hence the rule that the weight of gas dissolved increases with the pressure. In the table above the volumes stated are those reduced to 32° F. and 29·92 inches of mercury.

In case of a mixed gas the volume dissolved of each constituent will be proportionate to the relative volume of each gas multiplied of its coefficient of solubility. Thus, if air be taken



## APPENDIX

as an example of a mixture of 1 of oxygen and 4 of nitrogen, the proportion of each gas dissolved will be at 59° F.

$$\text{Oxygen} \quad \frac{1}{5} \times 0.02989 = 0.00597$$

$$\text{Nitrogen} \quad \frac{4}{5} \times 0.01478 = 0.01162$$

0.01759 of air.

## Appendix No. 3

### INFLUENCE OF SALTS UPON THE BOILING POINT OF WATER

THE presence of salts in water invariably raises the temperature of ebullition. This depends upon the adhesion of the salt to the water.

Legrand (*Annales de Chimie*, II. lix. 423) published the following table.

In Table X. the weights are taken of the anhydrous salts.

Experiments are wanting to determine the action of salts at higher pressures and temperatures but it may be assumed that the bad effect of soda in hindering the transmission of heat to water from heated plates has some connexion with this subject.

TABLE X.

SOLUBILITY OF SALTS AND TEMPERATURE OF EVAPORATION.

Salt.	Parts of Salt per 100 of Water.		Boiling Point of Saturated Solution.	Parts of Salt per 100 of Water when Saturated.
	212° F. to 213·3°	213·8° F. to 215·6°		
Nitrate of Soda . . .	9·3	9·4	250° F	224·8
„ „ Ammonia . . .	10·0	10·5	—	Unlimited
„ „ Potash . . .	12·2	14·2	240	335·1
Chlorate „ „ . . .	14·6	14·6	220	61·5
Chloride „ Sodium . . .	7·7	5·7	227	41·2
„ „ Potassium . . .	9·0	8·1	227	59·4
Carbonate of Soda . . .	14·4	12·3	220	48·5
Acetate „ „ . . .	9·9	7·7	256	209·0
Chloride of Barium . . .	19·6	12·9	220	60·1
Tribasic Phosphate of Soda and Water . . . . .	21·0	19·8	224	112·6
Sal Ammoniac . . . . .	7·8	6·1	238	88·9
Chloride of Calcium . . . . .	10·0	6·5	355	325·0
Acetate of Potash . . . . .	10·5	9·5	336	798·2
Carbonate of „ . . . . .	13·0	9·5	275	205·0
Nitrate of Lime . . . . .	15·0	10·3	304	362·2
Chloride of Strontium . . . . .	16·7	8·5	244	117·5
Tartrate of Potash . . . . .	26·9	20·3	238	296·2

The steam which rises from the above at once assumes the

## APPENDIX

temperature proper to the superincumbent pressure, the influence of the salt ceasing at the surface of the water.

The more soluble salts do not necessarily produce the higher boiling points.

(See also Appendix No. 4.)

## Appendix No. 4

### WATER AND ITS PROPERTIES

**P**URE water is a compound of 2 parts of hydrogen and 16 parts of oxygen. Its specific gravity is unity being the basis on which all other specific gravities are stated.

To heat 1 lb. of water 1° F. from 32° to 33° requires 1 British thermal unit.

To heat 1 kilo. = 2.204 lb. 1 degree Centigrade from 0° to 1° = 1½° F. requires 1 calorie of heat = 3.9683 B.Th.U.

Thus 1 B.Th.U. = 0.252 calorie.

One imperial gallon of water at 62° F. = 10 lb. and measures 277.479 cubic inches. The American gallon weighs 8½ lb. and measures 231 cubic inches.

The litre of water weighs 1 kilo. = 2.204 lb. and 1,000 kilos., therefore, weigh nearly 1 ton.

A column of water 1 foot high exerts a pressure of 0.434 lb. per square inch, and a pressure of 1 lb. conversely represents a water pressure of 2.3 feet. Hence one atmosphere of pressure equals 33.8 feet of water.

Water is nearly incompressible, the coefficient at 0° C. = 32° F. being 0.000052, and at nearly 35° C. = 127° F. = 0.00041. It is thus negligible for the purposes of this book. The heat expansion is more considerable but does not amount to 5% under atmospheric pressure. The following table XI. gives the weight per cubic foot at different temperatures Fahr.

TABLE XI.  
WEIGHT OF WATER PER CUBIC FOOT.

Temp.	Weight.	Temp.	Weight.	Temp.	Weight.
212	59.71	350	55.52	500	49.61
250	58.81	400	53.64	550	47.52
300	57.26	450	50.66	62	62.2786
102	62.00	158	61.00	203	60.00



## APPENDIX

Water solidifies at 32° F. = 0° C. and ice has a specific gravity of 0·922 and a specific heat of 0·504.

Water at 32° F. solid absorbs 142 B.Th.U. in becoming liquid at 32° F.

The latent heat of water is thus 142 B.Th.U. per lb. = 78·86 calories per kilo.

The specific heat of water being 1·00 at 32° F. increases slowly with temperature and becomes 1·0568 at 446°.

As the expansion of water is greater than its rise of specific heat the total heat of water per cubic foot will not increase as quickly as the temperature.

The evaporation of 1 lb. of water at 212° into steam at 212° F. demands 966 B.Th.U.

Sea water contains 38 parts per 1000 of dissolved matter, of which 25 to 28 parts are common salt or NaCl. The other salts of sea water are magnesium chloride and sulphate, calcium sulphate, potassium sulphate and chloride, bromide of soda, the carbonates of lime and magnesia and others of less importance.

The annexed table gives a few of the figures relative to the solubility of salts in parts per 100 of water.

(See also Appendix No. 3.)

TABLE XII.  
SOLUBILITY OF SALTS.

Salt.	Temperature F.		
	32° F.	70° F.	212° F.
Calcium Chloride . .	400	—	—
Magnesium Sulphate .	24·7	35·0	130
Potassium Carbonate .	100	80·0	—
„ Chlorate . .	3·33	8·0	60
„ Chloride . .	29·21	34·0	60
„ Nitrate . .	13·32	30·0	240
„ Sulphate . .	—	12·0	26
Sodium Carbonate . .	6·97	21·7	45·1
„ Bicarbonate . .	6·9	9·6	—
„ Chloride . .	35·5	36·0	39·6
„ Sulphate . .	5·02	22·0	42·6
Barium Chloride . .	35·0	—	60·0
Calcium Carbonate . .	0·0036	—	—
„ Sulphate . .	0·23	—	0·21
Magnesium Chloride .	200·0	—	—
„ Carbonate . .	0·02	—	—

## WATER SOFTENING AND TREATMENT

SOLUBILITY OF THE CARBONATES AND OXIDES OF LIME AND  
MAGNESIA AT 60° F. AND 212° IN GRAINS PER IMPERIAL GALLON.

	66° F.	212° F.
Carbonate of Lime $\text{CaCO}_3$ . . . . .	2.5	1.5
Bicarbonate $\text{CaO} \cdot 2\text{CO}_2$ . . . . .	60.0	0
Calcium Oxide $\text{CaO}$ . . . . .	93.0	—
Magnesium Carbonate $\text{MgCO}_3$ . . . . .	1.5	1.5
„ Bicarbonate $\text{MgO} \cdot 2\text{CO}_2$ . . . . .	50.0	0
Magnesium Oxide $\text{MgO}$ . . . . .	0.15	—
Calcium Sulphate $\text{CaSO}_4$ . . . . .	161.0	—

## Section II

# AIR PUMPS, CONDENSERS, AND CIRCULATING PUMPS





## CHAPTER XVIII

### HEAT

**I**N questions of condensation and feed heating some knowledge of heat and its effects is necessary to enable the engineer to make correct calculations.

We only know heat by its effects and assume it to consist in atomic or molecular vibration.

A body is said to be hot when it can communicate heat to other bodies at a less temperature, but temperature is merely that quality of heat which is sensible to our nerves. Temperature heat is measured by its effects in causing bodies such as mercury to expand, and also by the electric current that is caused to flow when two different bodies in circuit are equally exposed to heat as in the thermopile. But temperature is no measure of heat. It is merely that quality which enables heat to pass from one body to another, and in this way a body containing little heat can be made to pass some of its small store to a body containing more heat at a less temperature. Thus a pound mass of iron at  $100^{\circ}$  F. of temperature will supply heat to a pound mass of water at any lower temperature. Yet the water contains several times as much heat as iron. The actual quantity of heat is given usually by stating how many pounds or kilogrammes of water can be raised one degree of temperature F. or C., by a given amount of heat. The two quantities of heat necessary for 1 lb. or 1 kilo. are called the British Thermal Unit and the Calorie respectively.

#### Specific Heat.

That property of a body which determines how much heat is represented by a rise or fall in that body of  $1^{\circ}$  F. or

## WATER SOFTENING AND TREATMENT

1° C. is called the specific heat of the body. Thus the thermal unit which raises 1 lb. of water through 1° F. will raise 5 lb. of some other body through 1° F. The specific heat of the other body is therefore  $\frac{1}{5} = 0.2$  relative to that of water which is rated at unity as standard.

The Fahrenheit thermometer divides the difference of temperature between the freezing point of water and its boiling point into 180° parts. The Centigrade thermometer makes 100 divisions only. Thus, pure water under the mean atmospheric pressure of 14.7 lb. boils at 212° F. = 100° C. and it freezes at 32° F. = 0° C.

Evidently there must be no confusion of thought between quantity of heat and temperature. If 1 lb. of water, containing 100 B.Th.U. above some given temperature, is said to contain heat = H, then if it be further heated through 10° F. it will contain H + T very nearly, or 110 B.Th.U. But it is not strictly correct so to express the operation, though the result is correct practically simply because the specific heat of water is so nearly constant at all temperatures concerned in this book that the temperature rise practically equals the added number of heat units. But such a formula would only serve with water. It would be wrong for other cases, especially of mixtures of two different substances.

A mass of 1 lb. of iron heated to 132° F. contains 12.98 B.Th.U. measured above 32° F. A pound mass of water at 82° F. contains approximately 50 B.Th.U. above 32° F. Yet if the iron is placed in the water, heat will leave the iron which already contains so little and will enter the water already so well furnished. The final temperature will be removed from the initial temperature of the water about 5° F. only and the iron will lose 45° F. of the initial difference of 50° F. The temperature of the two substances will then be about 87° F., showing that the specific heat of the iron is about one-ninth that of water.

### Latent Heat.

Latent heat is heat which ceases to show temperature effects, being otherwise employed in maintaining a body in

## HEAT

a changed state. Thus water is said to have a latent heat of 142·6 B.Th.U., because in melting 1 lb. of ice from 32° F. to water at 32° F. nothing is shown by the thermometer, yet the heat has gone into the ice and is all absorbed in keeping up the molecular activity of liquidity and enables the water to remain liquid or mobile. This same water, if further heat be added, now shows rises in temperature until it reaches 212° F. Then no further rise takes place, yet the water all disappears as steam at 212° F., and no fewer than 965·7 B.Th.U. disappear with it. Thus we say that the latent heat of steam is 965·7 because this amount of heat is hidden in preserving the high molecular mobility necessary to keep water in the gaseous state. In this volume therefore the

### Unit of Heat

is that amount of heat necessary to raise the temperature of 1 lb. of water through 1° F., at or near 39·1° F. It is nearly the same at higher temperatures and for the purposes of this book the unit of heat may be taken equal to the above duty at any temperature of water used herein. The calorie or metric heat unit, is the heat required to raise 1 kilo. of water through 1° C. at or near 4° C, water being at maximum density at 39·1° F. = 4° C.

Since 1 kilo. = 2·204 lb. and 1° F. =  $\frac{5}{9}$ ° C., it follows that  $2·204 \times 9 \div 5 = 3·968 =$  number of B.Th.U. in 1 calorie.

Consequently 1 B.Th.U. = 0·252 calorie.

1 cal. = 3·968 B.Th.U. or approximately the ratio is 1 : 4 for most ordinary calculations.

### Unit of Work.

The relation of heat to work units will not be much needed in this book. It will suffice merely to say that the mechanical equivalent of heat is as follows—

1 B.Th.U. = 772 foot-lb.

1 calorie = 423·55 metre-kilos. = 3063·54 foot-lb.

## WATER SOFTENING AND TREATMENT

If we take the more recent determinations of the equivalent we have—

1 B.Th.U. = 778 foot-lb. = 107.78 kilogramme-metres.

1 cal. = 426.84 kilogramme-metres = 3087.3 foot-lb.

TABLE OF LATENT HEAT VALUES.

	Per Pound.		Per Kilo.	
	B.Th.U.	Cal.	Cal.	B.Th.U.
Ice to Water. Both at 32°	142.6	35.93	79.2	314.3
Water to Steam. Both at 212°	965.7	243.3	536.4	212.8

In steam at 100° F. or thereabouts, which is practically the temperature of condensers, there are very approximately 1,000 B.Th.U. of latent heat. This number is thus useful for rapid calculation. One pound of steam will have to lose this amount and a little more. If 1 lb. of cooling water disappears, it must gain the amount and a little more. The round figure will serve very well for our purpose.

It will now be obvious that while calculations are often made on secondary facts, it is always better to start from a definite datum line.

Many engineers ignore the thermal unit altogether, and if asked how to find the amount of air to cool the condensing water of a certain power plant, they would assume so many pounds of evaporation per pound of fuel, so much steam per h.-p. hour, so many times the feed water to pass through the condensers, and so on, whereas, given the coal contain 14,000 B.Th.U. per pound, there will be 30 per cent. lost by radiation or up the chimney and, therefore, 9,800 units will get to the engines, and since some heat is converted into work—perhaps 5 to 10 per cent.—there may be as many as 9,000 B.Th.U. per pound of coal to be carried off in the cooling tanks, and this is then the figure on which to calculate the air supply. The water is merely the vehicle of the heat and is hotter or colder according to its quantity, but the heat units remain the same.



# HEAT

## The Barometer.

The height of the barometer varies slightly with the latitude, though hardly sufficient to be of any account in steam engineering and, indeed, quite insignificant as compared with the ordinary weather variations.

A mercury column will stand at 14.704 in London, 14.6967 = 1.0333 kilos. per cm. at Paris and 14.686" at New York. To reduce to any other latitude the height will be in millimetres—

$$H = 760 \text{ mm.} \times \frac{(1 + 0.00531 \text{ Sin.}^2 48^\circ 50')}{(1 + 0.00531 \text{ Sin.}^2 L)}$$

is the latitude of Paris.

Variation of altitude is serious. At any elevation = R feet above sea-level the barometric height in inches will be—

$$H = 60,000 (1.477 - \log. R) \text{ where}$$

1.477 = log. of 30 (inches).

The weight of a cubic foot of air at 62° F. = 532.5 grains. When moisture saturated the weight is 529 grains.

The specific gravity of air is 819 times less than that of water and 13.146 cubic feet at 62° = 1 lb.

The Specific heat of air is 0.2375 at constant pressure and 0.1686 at constant volume.

At 32° F. 1 lb. of air measures 12.385 cubic feet and 1 cubic foot = 0.08073 lb. One litre of air at 0° C. and 760 mm. pressure weighs 1.292743 grams.

## CHAPTER XIX

### CONDENSING APPARATUS

THE condenser of a steam engine is a contrivance whereby the atmospheric pressure is removed from the exhaust side of the working piston in order that the mean effective pressure on the working side of the piston may be correspondingly increased. The maximum possible increase of effective pressure is one atmosphere = 14.7 lb. per square inch at the level of the sea. Thus if a non-condensing engine with a given rate of expansion had a mean pressure of 48 lb. the addition of a condenser, producing a vacuum of say 12 lb., would add 25 per cent. to the mean pressure and effect a corresponding economy.

The mean pressure of factory engines on steady duty is about 40 to 45 lb. referred to the final cylinder. About a third of this is due to the condenser, or say 14 lb. below the back pressure line of a non-condensing engine. The economy due to the condenser is thus  $\frac{40}{40-14}$  to  $\frac{45}{45-14}$  or say 35 to 31 per cent., neglecting other modifying conditions.

Where engines work with a poor load factor, as in the case of small and moderate electric tramway systems, the mean pressure is never great and the relative importance of the steady vacuum is proportionately enhanced and the economy to be derived from a condenser may be very great—perhaps 40 or 45 per cent.

If it were not that a quantity of air gains entrance to the condenser with the exhaust steam and through undiscovered leaks, the only thing necessary to secure the maximum possible vacuum would be to carry a drain pipe

## CONDENSING APPARATUS

from the condenser to a distance of 34 feet vertically below it and allow it to terminate in a tank of water or with a turned-up end. The maximum vacuum, consistently with the water temperature would then be secured. But air is always present and must be removed. Hence arose the air pump for taking off the air.

TABLEX III.

PROPERTIES OF LOW PRESSURE STEAM.

Equiv- alent Head of Water. Ft.	Lbs. per square inch.		Tempera- ture in Degrees Fahren- heit.	Total Heat in 1 lb. of Steam raised from water at 0° F. British Thermal Units.	Weight of 1 cubic foot of Steam in lbs.	Volume of 1 lb. weight of Steam in cubic feet.	Specific Volume or cubic feet of Steam from one cubic foot of water.
	Total or Absolute Pressure.	Pressure on Gauge.					
1.15	0.5	14.2	80	1137.5	.0013	726.60	45307
2.31	1	13.7	102	1145.0	.0030	330.36	20600
4.62	2	12.7	126	1152.2	.0058	172.08	10730
6.93	3	11.7	141	1156.8	.0085	117.52	7327
9.24	4	10.7	153	1160.1	.0112	89.62	5589
11.50	5	9.7	162	1163.0	.0138	72.66	4530
13.86	6	8.7	170	1165.3	.0163	61.21	3816
16.17	7	7.7	176	1167.3	.0189	52.94	3301
18.48	8	6.7	182	1169.2	.0214	46.69	2911
20.79	9	5.7	188	1170.8	.0239	41.79	2606
23.10	10	4.7	193	1172.3	.0264	37.84	2360
25.41	11	3.7	197	1173.7	.0289	34.62	2157
27.72	12	2.7	202	1175.0	.0314	31.88	1988
30.03	13	1.7	205	1176.2	.0338	29.27	1844
32.34	14	0.7	209	1177.3	.0362	27.61	1721
34.00	14.7	0	212	1178.1	.0380	26.36	1644
34.60	15	0.3	213	1178.4	.0387	25.85	1611
46.20	20	5	228	1182.9	.0507	19.72	1229

### The Law of Mixed Vapours.

If reference is made to the annexed Table XIII. of the properties of saturated steam it will be observed that a pressure of 1 lb. absolute accompanies a temperature of 102° F., which therefore corresponds with a vacuum of 13.7 lb. or 27.95 inches of mercury. In the absence of air this vacuum would be secured where the condenser temperature

## WATER SOFTENING AND TREATMENT

was as low as  $102^{\circ}$  F., for water vapour at  $102^{\circ}$  F. cannot alone exert a pressure greater than 1 lb. per square inch. By the law of mixed vapours enunciated by Dalton, however, the pressure in a space containing a liquid and above that liquid is the pressure of the vapour proper to the temperature of the liquid *plus* the pressure of any gas, as air, occupying the space, such pressure being what would be exerted by such air if alone in the space. That is to say, the pressure in a space above water exerted by water vapour is a function of the temperature and a given weight of vapour must always be present in a given volume, irrespective of how much air is made to enter the same space.

Thus, a vessel of one cubic foot capacity will contain 0.03797 lb. of steam at  $212^{\circ}$  F. and one atmosphere pressure. A cubic foot of air at  $212^{\circ}$ , containing 0.080728 lb., will exert a pressure of 1.365 atmospheres.

If, therefore, into a space of one cubic foot there be placed this weight of air at  $212^{\circ}$  F. and one boundary of the vessel be water at  $212^{\circ}$  F., the pressure in that vessel will be 2.365 atmospheres, or the joint pressure of the air and water. It is very usual to assume that water vapour will condense if pressure be increased, but this is not so where the increase of pressure is produced by the addition of a gas exerting no appreciable chemical attraction on the water. In other words it is necessary, says Rankine, to molecular equilibrium that a cubic foot of space at  $212^{\circ}$  F. should contain 0.03797 lb. of water vapour, no matter how much other gas be present. Similarly, at any other temperature a cubic foot of space must contain that *weight* of water vapour proper to the temperature and as shown in the tables of saturated steam.

Thus, if  $p$  is the pressure of saturation of the steam for a given temperature  $T$ , and  $P$  is the total pressure for a mixture of the vapour and a gas, as air, the density of the gas alone in that space is less than its density at the pressure  $P$  in the ratio  $\frac{P-p}{P}$ . Thus, in a space at  $50^{\circ}$  F. and atmospheric pressure = 14.7 lb., what is the air present in a cubic foot of space ?



## CONDENSING APPARATUS

The steam pressure at  $50^{\circ}$  is 0.173 lb. Therefore the air pressure will be  $14.7 - 0.173 = 14.527$  lb. The weight of a cubic foot of air at  $50^{\circ}$  and 14.7 lb. pressure is —

$$0.080728 \times \frac{493.2}{50^{\circ} + 461.2} = 0.077885 \text{ lb.}$$

Whence the weight of air actually present with the steam in one cubic foot will be—

$$0.077885 \times \frac{14.527}{14.7} = 0.07698 \text{ lb.}$$

The foregoing point has been considerably elaborated because the law teaches us that air present in a condenser adds to the pressure and diminishes the volume. The amount of air present is found from the thermometer and the vacuum gauge thus. If the pressure of water vapour at the condenser temperature of say  $102^{\circ}$  is 1 lb., and the vacuum gauge reads 12.5 lb. while the barometer reads 14.5 lb., then the total pressure  $P$  is 2 lb., and as 1 lb. is the pressure of the water vapour, the remainder is that due to the air = 1 lb. Consequently there must be air present in the condenser that has a density of 1 as against its external density of 14.5 lb. Knowing then the density of air in the condenser, we can calculate how much is drawn out at each stroke of the air pump.

In a tight air pump, when the bucket is at the top of its stroke, the space above the bucket is filled with water at the condenser temperature. There is no air, for this has all passed through the delivery valve, the clearance being water-filled. When the bucket descends it creates a vacuum between itself and the delivery valve as good as can exist in presence of water at the temperature of that present. This vacuum will be better than that in the condenser, which contains air, so that when communication is now established between air pump and condenser, the superior pressure in the latter will cause some of its contents to enter the air pump to establish an equilibrium since it is not possible for two unequal pressures to exist in connected spaces. Assume that the absolute pressure in the air pump

## WATER SOFTENING AND TREATMENT

is one half that in the condenser, then the volume of vapour entering the condenser will be only about one-half the air-pump capacity, for the vapour already existent will simply be moved up to the top end of the barrel as the further vapour enters. The only air present in the pump will be what rushes in with this last entering vapour, and in ordinary practice the volume of such a pump as the Edwards will therefore be halved so far as its capacity to abstract air is concerned. Probably in practice the inrush of water which takes place in these pumps carries in with it a greater proportion of air than the above and somewhat improves the pump efficiency, but *prima facie* an air pump with a foot valve should have a better volumetric efficiency than a pump without a foot valve, for the foot valve pump draws in the average mixture from the condenser. It suffers, however, from such diminution of efficiency as is represented by the pressure required to lift the foot valves. This need not necessarily be great.

The law of mixed vapours has been generally neglected by all writers on condensation, not excepting the Author. It is, however, not now desirable that this point should be further neglected in view of the high vacua that are considered desirable for steam turbine work. The subject is further touched on when dealing with actual air pumps.

Having thus far dealt with the question of condensation on general principles we may now turn to matters of more detail.

### The Water Required for Condensing Steam.

It is of little use, of course, to keep a condenser very cold when much air gains an entrance, and at no time is it desirable to reduce its temperature unduly, for the temperature of the condenser approximates the temperature of the moisture which evaporates in the cylinder during the exhaust stroke and is thus a measure of the loss due to re-evaporation. Moreover, the condenser outlet temperature is the initial temperature of the boiler feed water, and if the condensed steam passes to the feed heater or economizer, it ought not to enter this latter below 100° F. or thereabouts,

## CONDENSING APPARATUS

and a condenser temperature of 110° F. or 100° F. should be low enough.

To calculate how much water is required for condensing a given quantity of steam, it is known first that 1 lb. of water heated 1° Fahr. requires one unit of heat = 1 B.Th.U. One lb. of exhaust steam at ordinary condenser temperature contains about 1,150 B.Th.U. above 0°. Of the total steam used by an engine, not less than 10 per cent. will pass to the condenser as water. Consequently, if its temperature at exhaust is let us say 200° F. and the condenser has a temperature of 100° F., the water will lose 100° F., or say about 100 B.Th.U. per pound.

Then for 1 lb. of feed water supplied there will be  $\frac{1}{10}$ th lb. of water cooled to 100° F. = 10 B.Th.U., and  $\frac{9}{10}$ th lb. of steam, which will lose  $\frac{9}{10}$ ths of  $\left\{ \frac{1050}{(1150-100)} \right\} = 945$  B.Th.U. The total heat to be absorbed will be 945 B.Th.U. and for convenience the amount may be taken at 1,000 B.Th.U. per lb. of steam used or feed water supplied. Considering the heat lost by radiation, it is likely that not more than 900 B.Th.U. really remain to be absorbed in the condenser, so that the figure named should be ample for use in the formula below.

Calling R = the ratio of condensing water to feed water.

T = Condenser discharge temperature.

t = temperature of circulating or injection water.

W = weight of circulating or injection water.

w = weight of feed water.

Then  $R = \frac{W}{w} = \frac{1000 - T}{T - t}$ . Thus where T = 100° and

t = 50°;  $R = \frac{1000 - 100}{100 - 50} = 18$ , or the condensing water

required in these circumstances is eighteen times the feed water. In practice R varies from 20 to 50 and even more where the supply of water is warm, as from an insufficient pond or cooling tower.

The condenser temperature will be  $T = \frac{1000 + R t}{1 + R}$ .

# WATER SOFTENING AND TREATMENT

## Capacity of Condensers.

The capacity of a condenser depends to some extent upon the speed of the air pump. It must be of such volume that the pressure of accumulating air shall not be a serious fraction of the condenser mean pressure during one cycle of the air pump.

A condenser must also be large enough to accept the volume of steam from the cylinder and expose it to sufficient surface of cold tubes or of water spray instantly to condense it.

The air which enters a condenser may come in to the amount of 5 per cent. of the volume of injection water. This air only enters injection condensers.

Gland leakage accounts for about five times the above quantity. The total volume at atmospheric pressure may thus be 0.30 of the volume of the water. Arrived in the condenser the air expands in accordance with the absolute pressure therein. In practice one can only find how much air is present when we know the pressure and temperature as explained earlier.

Condenser capacities have been fixed by practical experience at one-fourth to one-half the capacity of the low-pressure cylinders they serve. When of surface type this does not include the volume occupied by the tubes.

## Varieties of Condensers.

There are three main varieties of condenser—viz., Jet, Surface and Ejector.

*The Jet Condenser.*—This is a plain vessel which admits steam usually at the top and water is injected at right angles to the steam entrance and is sprayed by the whirling motion imparted to it by its passage through the injection valve. The base of the condenser (Fig. 32) is connected with the air pump, a foot valve being interposed in old practice, but now usually omitted.

A jet condenser may always be employed if a soft clean feed is available. In such a case it is good practice to pass



## CONDENSING APPARATUS

the feed water through a small surface condenser placed in the path of the exhaust steam to the jet condenser.

*The Surface Condenser.*—This is intended to conserve the condensed steam in order to avoid scale in the boilers. In its usual form it consists of a cylindrical vessel closely packed with tubes through which the condensing water is circulated. With ample surface well distributed so that the whole tube surface is swept by the steam and short circuits of steam avoided the amount of circulating water should not be greater than that called for by jet condensers. More is often required, but the mean temperature of the circulation water will be low, indicating inefficient tube surface. About 10 lb. of steam per hour can be condensed per square foot of tube surface. The indented tube of Row is claimed to have double this efficiency owing to the turbulence of flow through it and it has been shown by Stanton<sup>1</sup> that better results are obtained by small tubes of great length placed vertically with down-flowing water, owing to the turbulent flow which Professor Reynolds shows to exist when the velocity of flow passes a certain critical rate  $V$ , where  $V = \frac{P}{.847 D}$ , where

$D$  = the diameter of tube in feet and  $P$  is a value based on the temperature Centigrade =  $t^\circ$  C.  $P = (1 + 0.0336 t^\circ + 0.000221 t^2)^{-1}$ .

Turbulent flow adds greatly to heat absorption efficiency.

Ordinary condenser tubes are from  $\frac{5}{8}$  to  $\frac{3}{4}$  inch diameter and  $\frac{1}{20}$  inch in thickness, but it is suggested that diameters of  $\frac{1}{4}$  inch and  $\frac{3}{8}$  inch would be better.

In order to promote efficiency the water usually makes two passes through the tubes. The steam meets first the pipes of the second pass and finally the first pass tubes. Suitable baffle plates are applied in order to spread the steam throughout the body of the condenser.

It is quite usual to pass feed water through a small section of the surface condenser, certain tubes being set apart for this purpose so as to encounter the exhaust steam fresh from the cylinder.

<sup>1</sup> *Minutes of Proc. I.C.E.*, vol. cxxxvi. part 2.

## WATER SOFTENING AND TREATMENT

It is sometimes the case that steam to be condensed passes through the tubes, the water surrounding them. Where the water supply is very large this is perhaps the better way. It is the practice with water supply companies, who thus make use of the whole water supply as circulating water, passing it all through the condensers.

Mr. R. W. Allen finds the friction of water through smooth condenser tubes by the following formula<sup>1</sup>—

$$h = f \frac{l v^2}{d 2g}, \text{ where } h = \text{head, in feet, lost.}$$

$l$  = tube length in inches.

$v$  = velocity of flow in feet per second.

$d$  = internal tube diameter in inches and  $f$  is a coefficient which appears to have a mean value of 0.024 for rates of discharge of from 3 to 11 gallons per minute.

Condenser tubes being of brass are always smooth internally and when used with salt or corrosive water they are tinned for protection against corrosion.

Messrs. Allen & Co. make condensers in which the upper bank of tubes in a horizontal condenser are more widely spaced apart than the lower bank tubes in order better to admit steam which strikes first the upper bank of tubes. Another method of arriving at the same end is by omitting some of the tubes as will be seen illustrated later. They also construct a condenser in which the lower tubes are immersed in the condensed steam, which is thus cooled to a minimum temperature and a better air-pump efficiency is obtained, as described under the head of vertical condensers.

*The Ejector Condenser.*—In this apparatus the energy in the exhaust steam is made to produce the necessary vacuum by reason of the velocity of flow impressed on a stream of water.

The outflow of steam is governed by the laws of fluid motion. The outflow velocity of a fluid is  $V = \sqrt{2gh}$  where  $g$  = gravity = 32.2  $h$  = head in feet and  $V$  = feet velocity per second. For steam the head  $h$  at 3 lb. pressure absolute is more than 7,000 times that of water.

<sup>1</sup> *Minutes of Proc. I.C.E.*, Session, 1904-5.

## CONDENSING APPARATUS

Thus, if the pressure difference in an ejector is 2 lb. or say 4.6 feet of water head, the steam head is  $4.6 \times 7,330 = 33,718$  feet and  $V = 1,472$  feet.

A simple formula for  $V$  is  $V = 60 \sqrt{T}$  where  $T$  is the absolute temperature. A minimum of 888 feet per second is also given for the velocity of steam into a pressure less than three-fifths its initial pressure. In any case the velocity is high and the mean velocity of a combined jet of steam and water will depend on the ratio of weights of water and steam. Thus, assume 29 of water and one of steam or a total combined jet of 30, then the velocity will be one-thirtieth of say  $900 = 30$  feet per second, or one-thirtieth of say  $1,200 = 40$  feet per second, velocities corresponding with a pressure of 6 and  $10\frac{3}{4}$  lb. respectively. With less water and an initial water velocity the combined velocity will often be such as to produce a vacuum of 26 inches of mercury, or about 13 lb. This represents a head of about 30 feet of water and a velocity of nearly 44 feet per second.

It is therefore advantageous that the water should approach a condenser at the maximum velocity and that it should be as cold as possible in order that as little as possible should be employed, and that the steam energy should be utilized in adding to the velocity of approach and not in moving the water from a state of rest. Ejector condensers work best when the water flows from a reservoir above. In practice the water is often supplied to them by a centrifugal pump.

The atmospheric condenser is merely a special case of the surface condenser, but the cooled surface is exposed to the air and the cooling effect is sometimes augmented by the flow of a thin film of water over the surface of the pipes. In this case the condenser is known as the evaporative condenser because the steam within the pipes is cooled by the abstraction of heat necessary to permit of the absorption of the external film of water by the passing air. An evaporation of 1 lb. of water outside the pipes will absorb the latent heat of an equal weight of steam inside them. An exposed position, as on a roof, is best for these atmospheric condensers.

## WATER SOFTENING AND TREATMENT

### Calculations.

All calculations for condensing plant should be based simply on the thermal units to be dealt with. Statements of horse-power are useless. The weight of steam to be condensed must be known and this will vary from as little as 13 lb. per kilowatt hour to as much as 50 lb. according to the load factor of the running plant. As stated already, 1,000 B.Th.U. may be assumed per pound of steam condensed and 1 B.Th.U. per pound of water raised 1° F.

### General Design.

This may vary much. Large modern power stations are tending very much in the direction of separate units, each main engine having its own condenser plant as well as its own particular set of boilers. Thus the Chelsea Power House of the Metropolitan District Railway of London is little else than eight distinct one-engine stations housed under a single roof, each of the 5,500 kw. turbines drawing its steam from eight boilers and passing it on to one condenser. There are thus eight turbines, sixty-four boilers and eight condensers: and eight air pumps. Much of course will depend on the size of a station. The condensing plant may consist of fewer units than the engines, more than one engine exhausting to each condenser. Or each engine may drive its own air pump and use a common condenser, so that the maximum of condenser area is always in use and each engine draws off its own proportion of air.

Again, the air pumps may be entirely separate from the main engines and may be driven by their own direct-acting steam cylinder, by a high-class rotative engine, or in an electric station by an electric motor. There is, indeed, no limit to the permutations and combinations that may be effected and good reasons can be found for or against any arrangement.

Thus, an independent air pump may be wastefully over-driven to conceal air leakages. Needless hardly to say, air leakage should be so minimized that when everything is shut down the condenser vacuum should not fall 3 lb. in



## CONDENSING APPARATUS

an hour. Good joint rings and well painted vacuum surfaces and fibrous packing to vacuum glands can be made to permit of this.

A common air pump, other conditions being good, can, on the other hand, be varied in speed to suit the number of engines at work. The independent air pump also allows of the vacuum being pumped up before the main engine is started.

Where steam-driven independent air pumps are employed they may usefully exhaust to the intermediate receiver of a main engine.

In tramp steamers, which have the most economical steam plant, everything is driven off the main engine and it is obviously more economical to drive from the main engine than it is to employ numerous auxiliaries.

It is often urged that auxiliaries can use their exhaust to heat the feed, but this is a partial truth only, for the economizer or flue feed heater will usually supply feed water hotter than it can be given by exhaust steam heating. Where there is no economizer the feed pump steam may thus be used.

The position of condensing plant is generally below the main engines for convenience in drainage and water supply. The injection or jet condenser will draw its own water from a depth of 17 feet as a rule without risk of failure. It is also undesirable to raise the circulating water too high above supply level and the circulating system should be a closed circuit, so that the only duty of the circulating pump should be to keep the water moving, since the descending stream will balance the ascending stream. Air will sometimes lodge at the high points in a circulating system and these high points may be all piped by small air pipes to an ascending main carried up fully 36 feet to a small closed tank from which the air is drawn off to the air pumps. This will safeguard the centrifugal pump from failure, for it must be one of the trapped points.

In large stations the circulating water is led through the station in a large pipe, from which each condenser pump draws its supply and every condenser circuit discharges into another parallel pipe. It is usual to provide that either pipe can be used alternatively as the supply or the discharge

## WATER SOFTENING AND TREATMENT

main in order to overcome any trouble with silting up, especially when drawing from a muddy or tidal river, the silt being driven out by the reversed flow at times of low tide.

A silted pipe may be cleared by passing through it in the direction of flow a large wooden ball slightly smaller than the pipe bore. The ball floats in the full pipe and the rush of water past the narrow crescent beneath it sluices forward all mud. Certain silt will settle so firmly as not to be moved by the ordinary flow, and as such supply pipes must be wholly below lowest water level, silting is apt to be very troublesome.

When an air pump is directly driven by the main engine and this is of large vertical type, there is no better style of pump than the vertical driven by a lever of the first order pivoted on the back standards of the engine and driven off the cross-head. To shorten the height necessary the air pump may have a trunk bucket, the connecting link to the driving lever being pinned to the bottom of the trunk. But ordinary rods and glands are usually available. The air pump is practically of the type of Fig. 50, but with a closed top for delivery of the water except at sea, or with surface condensing, the water may flow down to a well to supply the feed pumps, or to be removed by other means. In the old factory beam engine the air pump is almost invariably driven off the inner pin of the parallel motion at half the stroke of the steam piston or thereabouts. Some large horizontal engines drive the air pump by an *L* lever from the tail rod of the engine, while others again have driven an inclined air pump off the crank pin by a long diagonal rod. Air pumps have also been driven by large eccentrics, but this cannot be regarded as a very satisfactory method and the eccentrics are apt to run hot.

### Exhaust Pipes.

An exhaust pipe between an engine and a condenser must obviously be much larger than the steam supply pipe because of the increased bulk of the steam.

A customary rule in English practice is to make the exhaust pipe twice the area of the steam pipe. American

## CONDENSING APPARATUS

practice favours a ratio of 3 to 2 only in area, or the steam pipe has an area 7 per cent. of the cylinder and the exhaust pipe of 10 per cent.

Whereas steam velocity is limited to 100 feet per second, that of the exhaust may be upwards of 200 feet per second according to Rankine. But looked at in another way the density of high-pressure steam is that equal to a volume of 2.5 cubic feet per pound. At atmospheric pressure the density is that of 26.33 feet per pound or 1 : 10, and at condenser pressure it is more nearly 1 : 100, as compared with initial steam. We know, however, that the velocity of flow of exhaust steam is very great indeed, for at once when the exhaust valve opens the pressure very quickly falls to that proper to the condenser temperature. A rule for velocity in feet per second is  $V = 60.2 T$  where  $T$  is the absolute temperature and  $V$  = the velocity of flow into a vacuum. Steam of any pressure flowing into any other pressure less than three-fifths the initial has a velocity of 888 feet per second. Hence the weight discharged is proportionate to the density, and the weight discharged per minute may be found by multiplying the area of pipe in square inches by 370 times the weight of a cubic foot.

Thus, an engine of 6,000 horse-power uses 12 lb. of steam per horse-power hour, or 1,200 lb. per minute.

Exhausted at 3 lb. absolute into a condenser at less than  $\frac{3}{5}$ ths of 3 lb., or say 1.5 lb., the velocity being 888, the area in square inches will be found from the foregoing formula, or  $W = 370 \times A \times D$ . Now  $D$  for 3 lb. is 0.00853 lb., whence

$$A = \frac{W}{370 \times D}$$

Now  $W = 1,200$ , so that

$$A = \frac{1,200}{3.15} = 380 = 22 \text{ inches diameter.}$$

In brief, the area of an exhaust pipe in square inches may be a fourth to a third of the pounds of steam used per minute. A deficiency of area will increase the back pressure in the cylinder and a cold condenser will help to keep down the pressure in this to less than three-fifths the cylinder back

## WATER SOFTENING AND TREATMENT

pressure, and so help to maintain the flow velocity of 888 feet per second. The law of mixed vapours here points out unmistakably the importance of keeping air out of the condenser.

### Cooling Surface.

This at 10 lb. of steam per square foot per hour would amount in the above example to 7,200 square feet. With  $\frac{7}{8}$  tubes the approximate external area is 1 square foot per 4 feet length of tube. The tube length must therefore be 28,800 linear feet.

If the tubes are 7 feet long there will be 4,111 tubes in all. The area of a  $\frac{7}{8}$  tube is 0.6 square inch and the equivalent area reduced for effect of *vena contracta* is 0.36. Then  $4,111 \times 0.36 = 1480$ , or fully 10 square feet. This is so great an area for water passage that it is obviously possible if we desire it to add to the length of the tubes and reduce their diameter and number.

The actual tube area is 2466.6 square inches, or 17 square feet.

At 30 times the feed water the amount of circulating water is nearly 10 cubic feet per second, so that the velocity of flow is under 8 inches per second.

Taking Professor Reynolds' rule for turbulent flow and assuming the water to have a temperature of 30° C., we have

$$V = \frac{P}{84.7 D} \text{ and } P = (1 + 0.0336 T + 0.000221 T^2)^{-1}.$$

$$\text{Then } P = (1 + 1.008 + 0.199)^{-1} = 0.45.$$

$$\text{Now } D = \frac{7}{8} \text{ inch} = 0.073 \text{ feet. Whence } V = \frac{0.45}{6.183} = 0.073$$

feet per second =  $\frac{7}{8}$  inch per second. Turbulent flow is thus assured.

The rule is applicable to vertical tubes with down-flowing water and does not seem to have much connexion with practice, for the velocity of flow can hardly ever be less than that which gives turbulent flow if the rule is correct.

If the water flows downwards in the tubes the steam should flow upwards. It is usual to make the water flow through the tubes in two sections. This at once halves the area as found above to the equivalent of 5 square feet



## CONDENSING APPARATUS

effective or 8.5 actual and increases the velocity to 16 inches per second.

Even three sections of tubes are sometimes arranged so that the steam can enter at the top of the condenser and the condensed water can be led away from the base. More usually condensers are horizontal, the water making two passes through the tubes and the steam meeting first the hotter water, or, as before said, even a feed water heater nest of tubes through which the feed passes on its way to the economizer.

Many horizontal condensers have tubes of about  $1\frac{1}{2}$  inch diameter, fitted sometimes with internal pipes, the water tube being closed at one end and the inner tube serving to carry water into it, the water returning by the annular space between the inner and outer tubes. Such tubes being free



FIG. 32. JET CONDENSER.

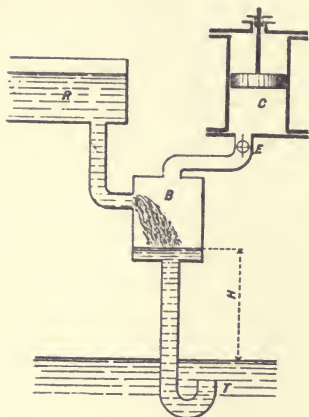

FIG. 31. PRIMITIVE IDEAL BAROMETRIC CONDENSER.

at one end do not suffer expansion stresses and may be expanded at the other end into tube plates. When both ends are fixed in tube plates the stresses soon cause leakage, and though one end may be expanded fast the other end must have a gland and packing of cotton so as to allow slight movement of the tube.

Wooden ferrules are sometimes used as packing. One-half the tubes may be fixed into one tube plate and the remainder into the other. This leaves more room for the packing glands or permits closer nesting of the tubes.

When steam enters a condenser and meets the surface of closely packed tubes the space between the tubes is not

## WATER SOFTENING AND TREATMENT

sufficient to allow free passage of the steam to all the tube surface. It is now the practice to omit certain tubes, so that gaps are left in the external wall of tubes by which the exposed walling of tubes is much increased and steam is taken well into the middle of the nests of tubes, as in Fig. 38.

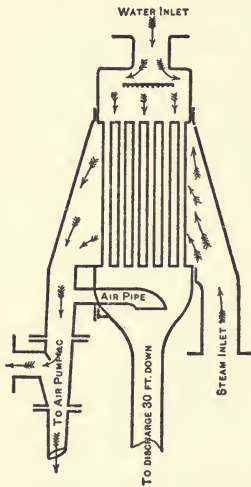

FIG. 33. SURFACE BAROMETRIC CONDENSER.

Steam enters at S, water at W and the air pump draws away steam and water from the base.

A barometric condenser may be arranged on the surface principle, as in Fig. 33, the dry air pump serving to withdraw any air not carried off by the down-rush of water.

The general idea of the horizontal surface condenser is that of Fig. 34, where the condensed steam is drawn off by a feed pump and the air by a separate air pump, which may also, if large, be used to draw the

The various condenser systems described are shown in the accompanying figures. Fig. 31 is the first idea of a barometric condenser B, placed so that the height H is over 30 feet. Steam enters from the cylinder C through a valve E and water enters from R.

This arrangement will act until it becomes full of air. A small dry air pump is required to make it a continuous success.

The plain jet condenser is that in Fig. 32 and is simply a cast-iron jar.

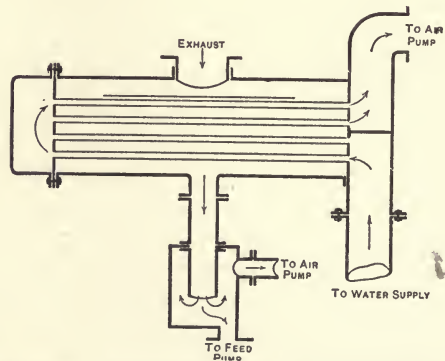

FIG. 34. HORIZONTAL SURFACE CONDENSER.

condensed steam is drawn off by a feed pump and the air by a separate air pump, which may also, if large, be used to draw the

## CONDENSING APPARATUS

circulating water through the tubes. This implies special design.

### Incrustation.

Condenser tubes are apt to become coated with scale on the water side in process of time. They can usually be cleaned by circulating through them a current of water acidulated by hydrochloric acid in order to dissolve the crust which is carbonate of lime. The acid should be a 20 per cent. solution only, or even less.

### Economy of Condensing.

The following Table XIV. is given by the late Charles E. Emery, Ph.D., to show the economy that may be secured by condensing, according to the class of steam engine employed. It is for average conditions and steady loads. For underloaded engines, as in a traction plant, the economy will often be very much greater than given in the table, on account of the very low mean pressures that are usual in most traction engines.

TABLE XIV.

TYPE OF ENGINE.	Feed-water per Indicated Horse-power per hour.				Per Cent. Gained by Condensing.
	Non-Condensing.		Condensing.		
NAME.	Probable Limits.	Assumed for Comparison.	Probable Limits	Assumed for Comparison.	
	lb.	lb.	lb.	lb.	
Simple High-speed	35 to 26	33	25 to 19	22	33
Simple Low-speed	32 to 24	29	24 to 18	20	31
Compound High-speed	30 to 22	26	24 to 16	20	23
Compound Low-speed	—	24	20 to 12 $\frac{3}{4}$	18	25
Triple High-speed	27 to 21	24	23 to 14	17	29
Triple Low-speed	—	—	18 to 12 $\frac{3}{4}$	16	—

# WATER SOFTENING AND TREATMENT

## Solubility of Gases in Water.

The volume of gas that will dissolve in one volume of water is called the coefficient of absorption, the volume of gas being measured at 32° F. and 30 inches barometer (0° C. and 760 mm.). Bunsen's table of solubility coefficients is given below for a few gases likely to occur in feed water.

TABLE XV.

Temperature: {	0° C. 32° F.	5° C. 41° F.	10° C. 50° F.	15° C. 59° F.	20° C. 68° F.
Hydrogen . . .	0·01930	0·01930	0·01930	0·01930	0·01930
Oxygen . . .	0·04114	0·03628	0·03250	0·02989	0·02838
Nitrogen . . .	0·02035	0·01794	0·01607	0·01478	0·01403
Air . . . . .	0·02475	0·02179	0·01953	0·01795	0·01704
Carbonic acid . .	1·7967	1·4497	1·1847	1·0020	0·9014
Carbonic oxide .	0·03287	0·02920	0·02635	0·02432	0·02312
Carburetted hydro- gen, CH <sub>4</sub> . . .	0·05449	0·04885	0·04372	0·03900	0·03499
Carburetted hydro- gen, C <sub>2</sub> H <sub>4</sub> . . .	0·2563	0·2153	0·1837	0·1615	0·1488
Sulphuretted hydro- gen . . . . .	4·3706	3·9652	3·5858	3·2326	2·9053
Ammonia . . . .	1049·6	917·9	812·8	727·2	654·0

At the boiling-point practically all gas is occluded. The solubility increases in proportion with the pressure, showing that gases are soluble by volume and not by weight. The above table contains all the information likely to be needed in practice, and shows that ordinarily it is carbonic acid gas which is to be dealt with, but that in sewage or other badly polluted water there may be large volumes of sulphuretted hydrogen in the injection water, such as is so much used in the town of Oldham for example.



## CHAPTER XX

### EXAMPLES OF CONDENSERS

OF actual condensers the barometric type finds its practical extension in Fig. 35, which shows the head of the Worthington Central Condenser. Here the exhaust steam enters at one side

and the water enters on the opposite side and flows past the tubular air cooler and is sprayed by a special nozzle into the path of the steam. The air pipe is brought into the centre as shown and if the down-pipe is not too large the falling water will carry with it much of the air and the apparatus may work without an air pump. An air pump is usually added to improve the vacuum. Hence the air cooler. Such a condenser is particularly fitted to

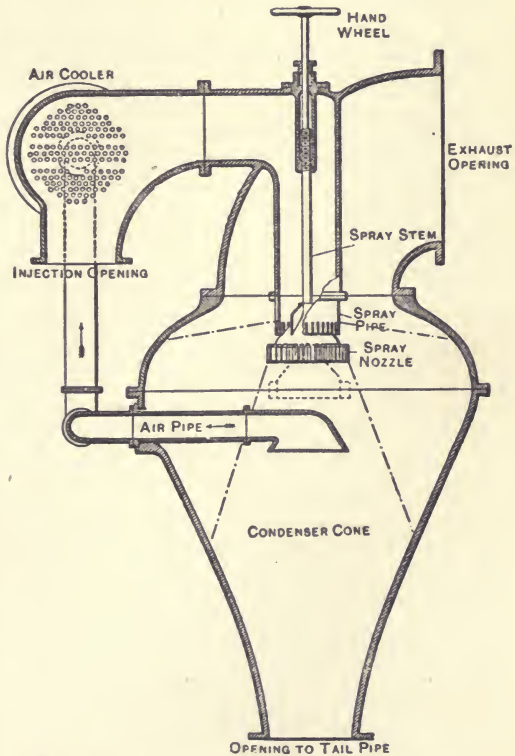

FIG. 35. WORTHINGTON CONDENSER HEAD.

## WATER SOFTENING AND TREATMENT

deal with a good supply of water falling from above. The ejector condenser may also be assisted by a barometric discharge or gravity pipe.

### The Wheeler Condenser.

The single-ended condenser, used in America but little employed in Great Britain, with inner pipes and double water chambers is shown in Fig. 36, where a combined air and circulating pump is shown attached below the con-

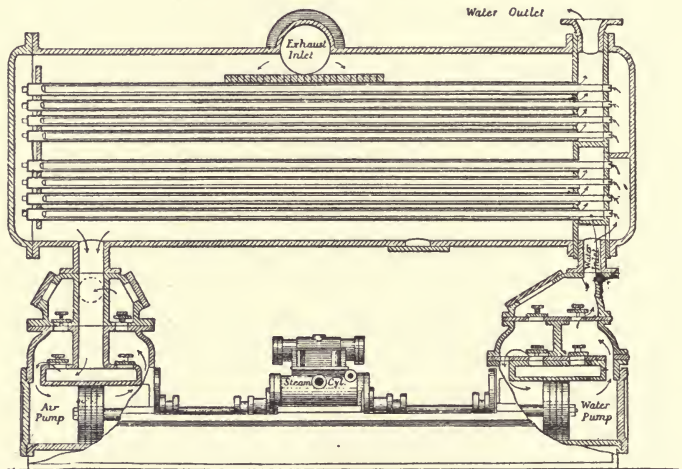

FIG. 36. WHEELER CONDENSER.

denser. These condensers may be either circular or rectangular in cross section. Note the baffle plate under the steam inlet to spread the steam. The air and circulating pumps are driven by a central steam cylinder, the exhaust from which should pass into the intermediate receiver of the main engine or through a feed heater, if either course is open. There is an objection to this double-tube design in the cooling of the outgoing water by the ingoing stream and *vice versâ*, and the single tube is to be recommended in preference.

## EXAMPLES OF CONDENSERS

### Morton's Ejector Condenser,

as made by Ledward & Co. is shown in Fig. 37. It consists of a series of combining cones by which steam enters a flowing stream of water from a nozzle above. The principle of action has already been explained. The 1½ inch size will condense ordinarily 200 lb. of steam per hour and the 18 inch size as much as 36,000 lb., the ratio of water to

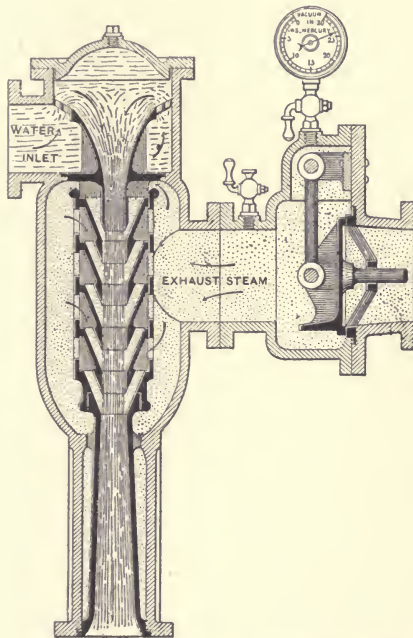

FIG. 37. EJECTOR CONDENSER (Ledward).

steam being assumed 27 : 1, the power to pump which is considered to amount only to about 3 per cent. of the economy due to the condenser.

### Surface Condenser with Through Tubes.

This type is illustrated in Fig. 38 in cross section for the purpose of showing the rows of tubes omitted to facilitate

## WATER SOFTENING AND TREATMENT

entry of steam. Here the steam first strikes a distributing perforated baffle plate, and is subsequently further regulated by other baffle plates. The illustration is from a design by Isaac Storey & Sons, Ltd.

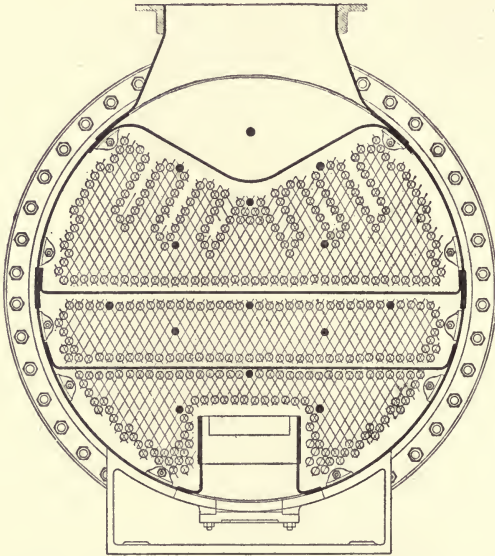

FIG. 38. CROSS SECTION OF SURFACE CONDENSER (Isaac Storey & Sons).

### The Vertical Condenser.

In Fig. 39 is shown the arrangement of the vertical condensers of the Yorkshire Power Station at Thornhill, and of the Lancashire Power Station at Radcliffe. Each of three condensers is intended to deal with 37,000 lb. of steam per hour and a vacuum of 28 inches is sought with a 30-inch barometer.

There are 4,500 square feet of cooling surface disposed in solid drawn brass tubes, 1 inch external diameter, of 18 s.w.g., and 12 feet 6 inches between tube plates, which are of  $1\frac{1}{8}$  inch rolled brass. It may be noted here that a brass tube plate possesses the advantage of having a similar coefficient of expansion to the brass tubes.



## EXAMPLES OF CONDENSERS

The water and steam run in counter current through the condenser and each makes three passes through the full length of the condenser.

The air pumps in this case are three-throw Edwards pumps 15 inches diameter, 8 inches stroke and run at 165 to 170 r.p.m., with brass liners and buckets and rods driven by 15 horse-power direct-coupled motors. There is a flanged coupling between the motor and the pump shaft with three-sixteenths clearance between the faces.

The driving pins are fixed in one half and fit into clearance holes in the other half.

Provision is made to circulate forty-five times the feed water supply at a temperature not exceeding 60° F., with a view to a high vacuum for the turbines.

This high vacuum is sought in another way by the device shown in Fig. 40, which is a cross section of a condenser by G. & J. Weir. In this condenser the outlet for the water is a bonneted stand pipe A, so arranged with an outer sleeve B and cover C that the air pump always draws the lowest water from the condenser and the accumulation of water extends to E E above several rows of tubes, which serve to chill the water on its way to the air pump. Thus any vapour in the air pump can only exist at the pressure proper to the temperature of the cooled water, and since there cannot be two different pressures in the same space vapour and air rush to the pump to restore equilibrium. The vapour condenses and the rush continues until equilibrium is established by the air. There is thus more air in a unit space in the air pump than in the condenser and the pump efficiency is therefore improved and the condenser is better depleted of air.

In the vertical condenser plant above described there are small air pipes carried from the top of the condenser and of the centrifugal circulating pumps and every high point where air might lodge. These are carried to a closed tank about 40 feet high, which is exhausted by a special pump. The object is to ensure that no air shall lodge in any of the above points to destroy the action of the centrifugal pumps or otherwise hamper circulation.



# EXAMPLES OF CONDENSERS

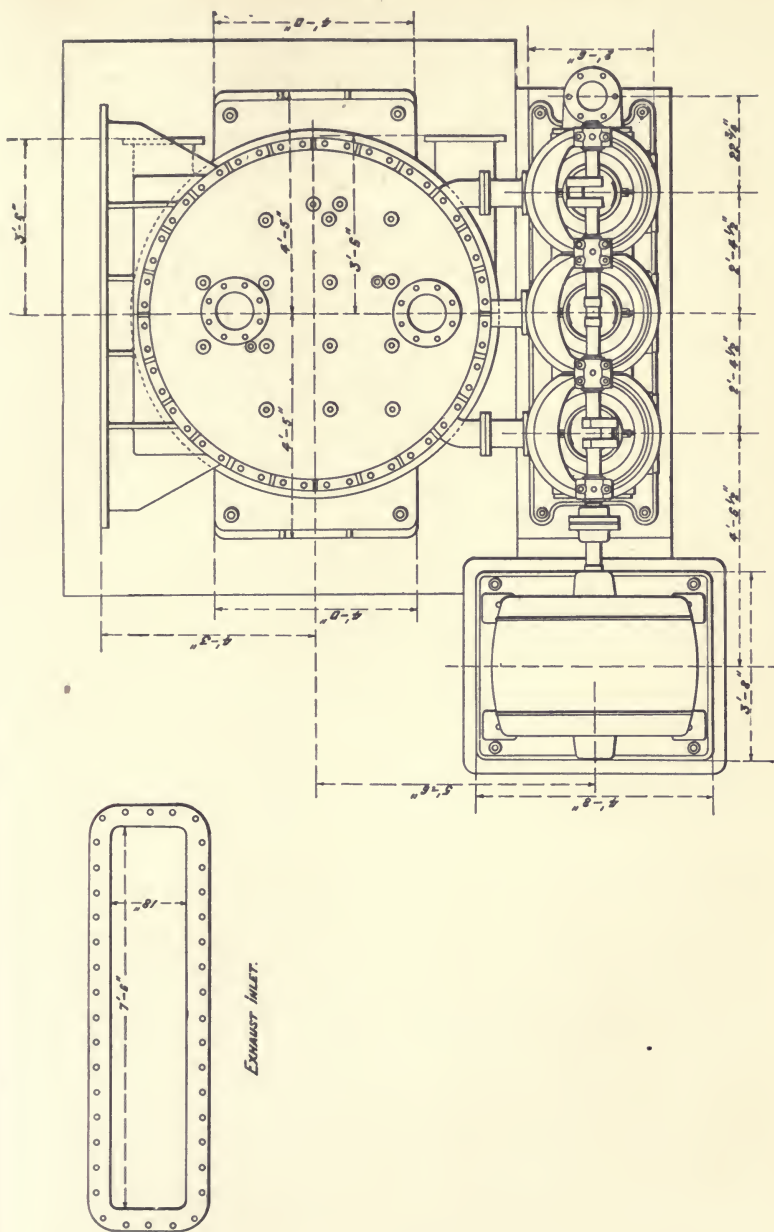

FIG. 39.  
VERTICAL CONDENSER AND AIR PUMPS. YORKSHIRE POWER STATION, THORNHILL.

## WATER SOFTENING AND TREATMENT

In Fig. 41 is shown the vertical single-flow condenser built by James Simpson & Co., Ltd., for the Underground Electric Railways of London and installed at Lots Road, Chelsea.

Eight of these condensers have been built and fixed, each having a cooling surface of 15,000 square feet, and

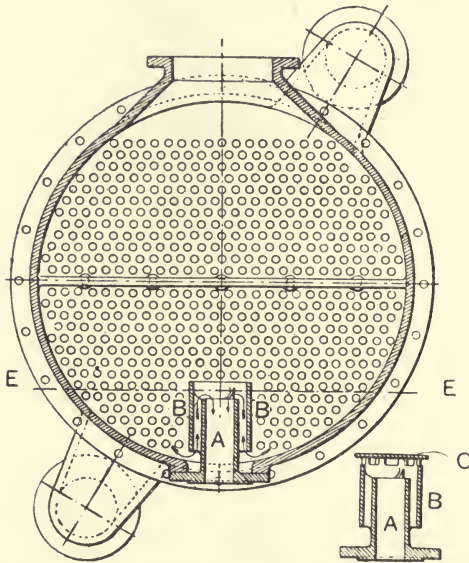

FIG. 40. CROSS SECTION OF HORIZONTAL CONDENSER SHOWING WATER OUTLET.

capable of dealing with a normal load of 85,000 lb. of steam per hour.

The air pumps are of the dry vacuum type, and have a displacement of about 900 cubic feet per minute.

The condensed water pumps are of the centrifugal type and each is capable of dealing with the above quantity of steam.

Each of the eight condensing sets is independent in every way of the others, and is proportioned to deal with an overload of about 50 per cent.

At Fig. 41a is shown a Vertical Double-flow Surface Condenser, also by James Simpson & Co., Ltd. This con-





# EXAMPLES OF CONDENSERS

denser has a cooling surface of 5,400 square feet, and is capable of dealing with about 50,000 lb. of steam per hour.

From the arrangement of the inlet and outlet branches for steam, circulating water, and air-pump discharge, it will

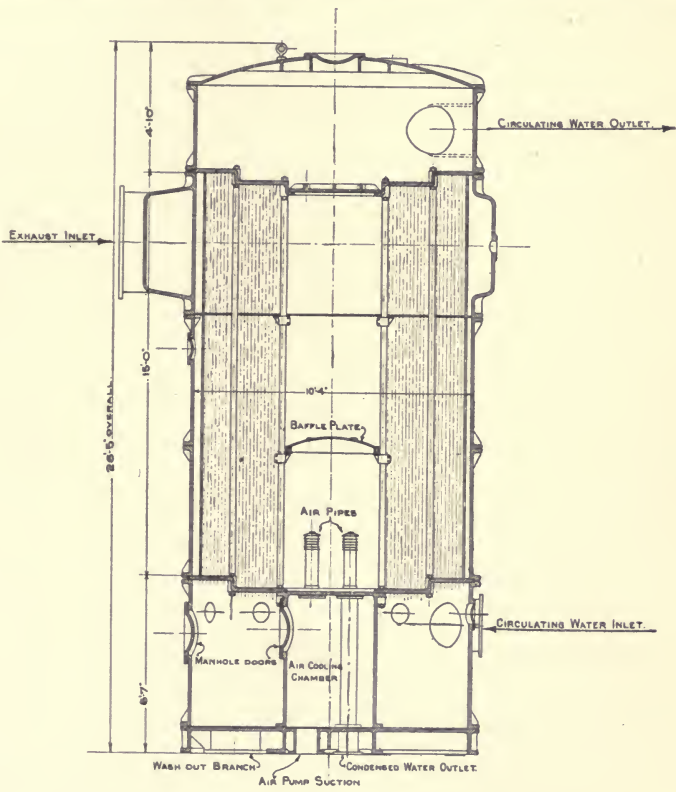

FIG. 41. VERTICAL SINGLE-FLOW SURFACE CONDENSER.

be noticed that the steam passes through the length of the condenser twice, viz., down one side and up the other.

Air pumps of the dry vacuum type are used in connexion with this type of condenser, so that the vapours and the condensed water are taken out separately.

In Fig. 41b is shown the same firm's Vertical Single-flow Surface Condenser suitable for muddy circulating water.

## WATER SOFTENING AND TREATMENT

This condenser was specially designed with the object of using very dirty circulating water carrying considerable quantities of mud and leaves: special means have been provided for arresting this matter by providing a large chamber at the bottom of the condenser, to act as a settling chamber; and gratings or screens to arrest any floating

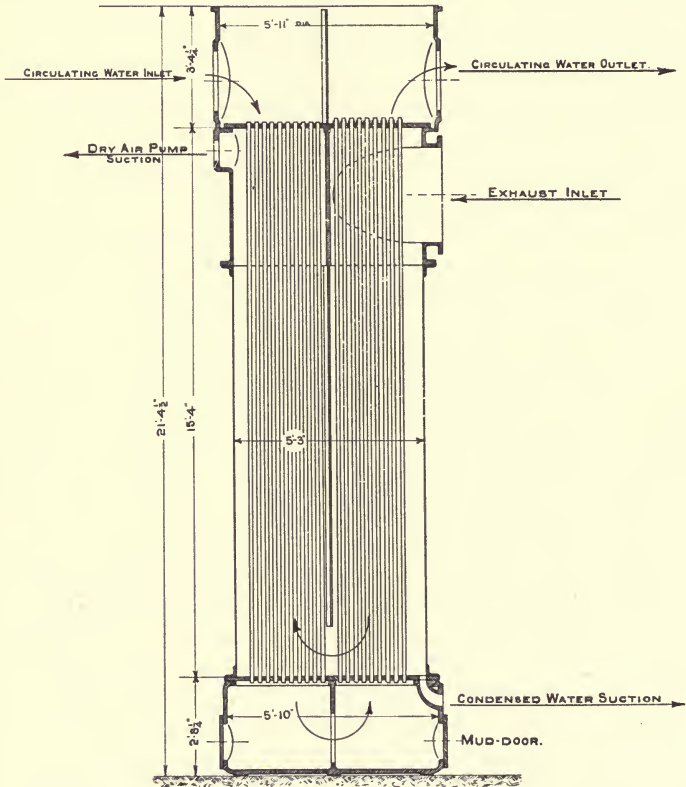

FIG. 41A. VERTICAL DOUBLE-FLOW SURFACE CONDENSER.

substance, while the pipe connexions are arranged in such a way that both halves of the condenser can be worked at the same time, or separately, so that by closing down one half of the circulating system it can be readily cleaned, whilst the other half is carrying the load with a slightly reduced efficiency.

## EXAMPLES OF CONDENSERS

This condenser is capable of dealing with 85,000 lb. of steam per hour, with the circulating water at a temperature of from 60 to 70 degrees.

The cooling surface provided is about 8,500 square feet.

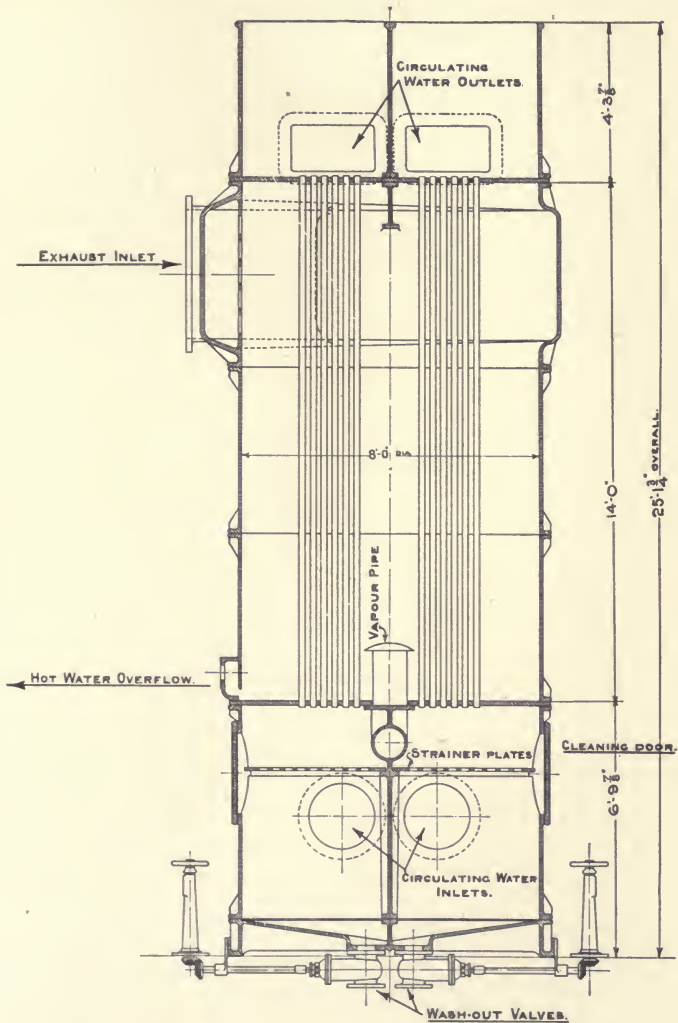

FIG. 41b.—VERTICAL SINGLE-FLOW SURFACE CONDENSER, SUITABLE FOR MUDDY CIRCULATING WATER.

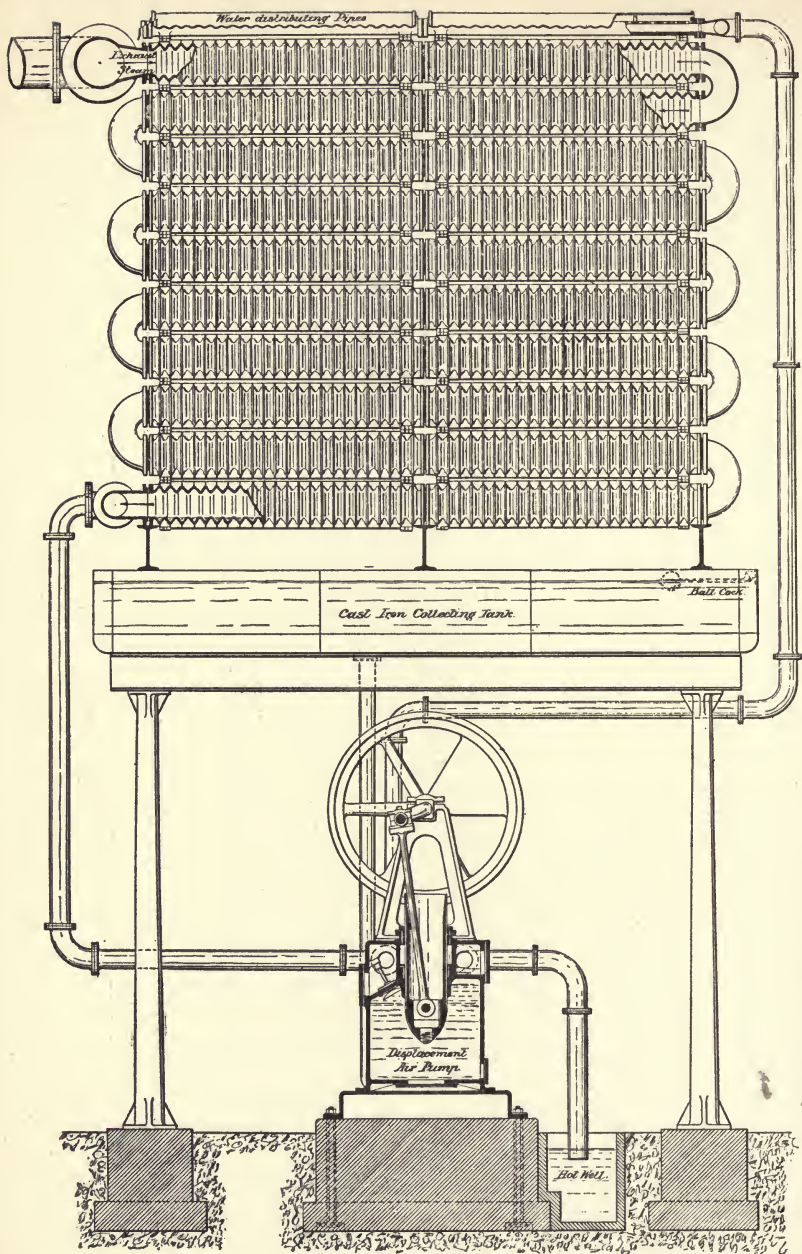

FIG. 42. EVAPORATIVE CONDENSER (Ledward). SIDE VIEW.



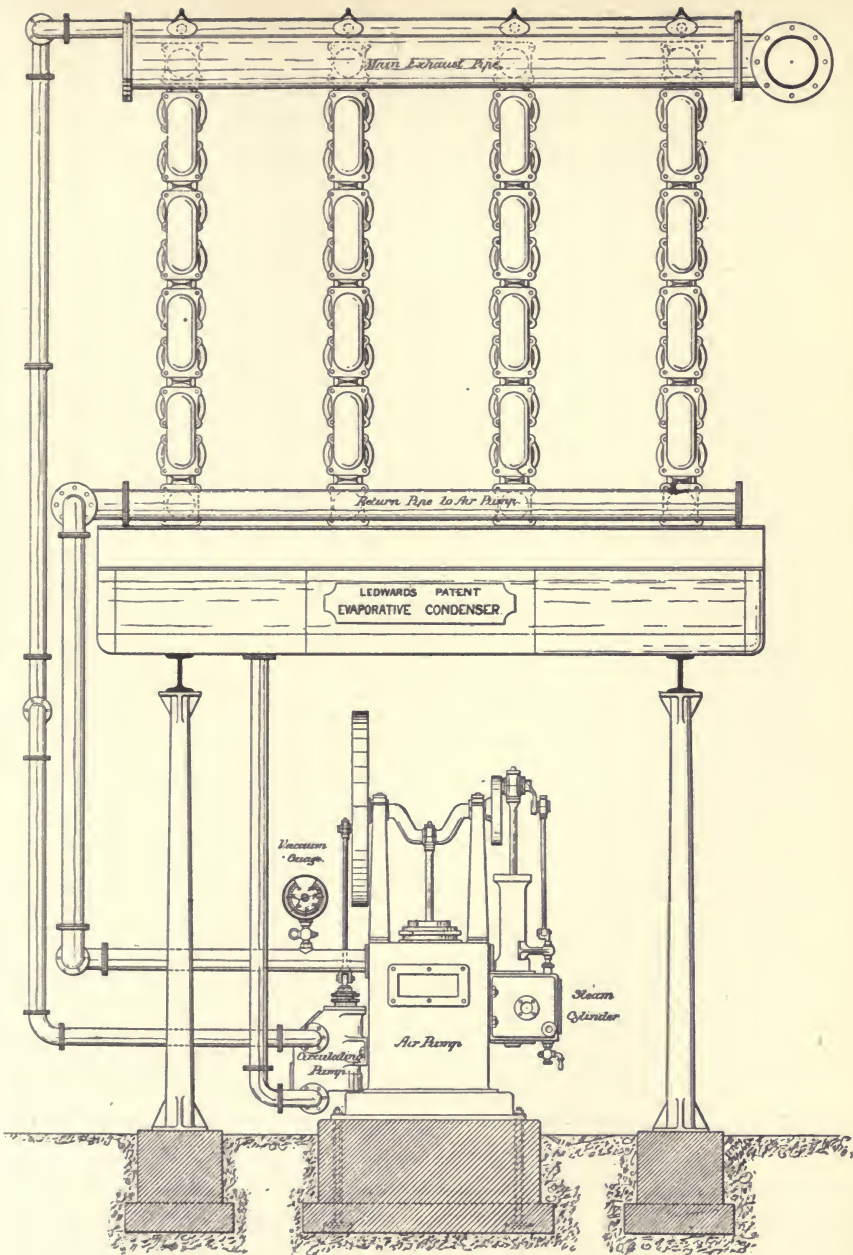

FIG. 42A. EVAPORATIVE CONDENSER. END VIEW.

## WATER SOFTENING AND TREATMENT

### The Evaporative Condenser.

This condenser is shown in Figs. 42, 42*a*, and consists of an arrangement of gilled cast-iron pipes exposed to air and to films of water. About two-thirds the weight of steam condensed by them is evaporated on their outer surfaces.

It appears from some tests made by Mr. Longridge that about  $1\frac{1}{2}$  to 2 lb. of steam may be condensed per square foot of surface per hour with an attained vacuum of 24 inches.

It is important that the pipes of these condensers should be free from blown or spongy parts, for it does not appear desirable to paint them, and if not sound they would admit air too freely.

It seems to the Author that the steam should preferably flow upwards—counter-current fashion—instead of as shown, and that small water drains should be carried down from some of the end bends direct to the air pump. Still under ordinary conditions, with the steam entering at the upper end, a vacuum of 24 inches is guaranteed and even more is often secured.

Such a condenser as shown in Fig. 42, consisting of eighty corrugated pipes, is capable of dealing with 2,400 lb. of steam per hour. The total cooling surface of the condenser is 2,400 square feet, and for its efficient working it is necessary to provide 200 gallons = 2,000 lb. of water per hour to replace the cooling water lost by evaporation, or four-fifths only of the weight of steam used by the engine.

### Counter Current Jet Condenser.

The Balcke condenser, in which the principle of counter current is adapted to a jet condenser is shown in Fig. 43. Here the water is removed at a definite rate by the lower pump and air is removed by the upper pump from the top of the condenser. By means of a float the volume of the injection is regulated by the water level which is kept uniform. The water enters by way of a circular lip to the upper water channel and is well spread by perforated diaphragms. Steam enters below the water spreader and air is drawn up

## EXAMPLES OF CONDENSERS

through the cold water, so that as fully as possible the air is freed from water vapour and the capacity of the dry air pump is utilized to its fullest practicable extent.

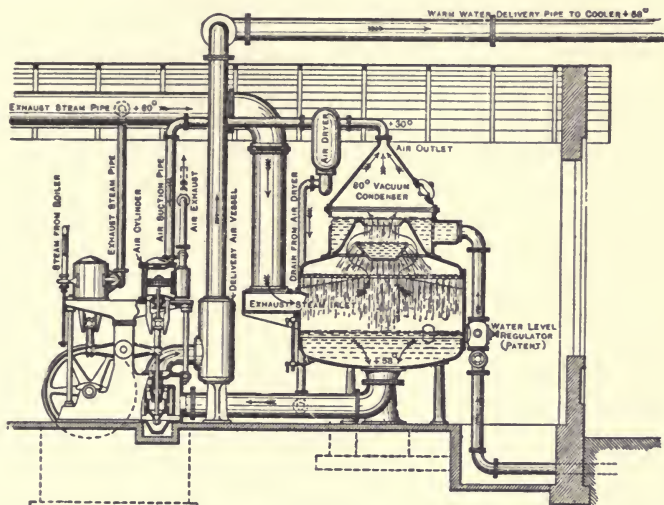

FIG. 43. BALCKE'S JET CONDENSER.

Feed water is drawn from the base of the condenser and the remainder drawn out by the wet "air" pump is, when necessary, forced by that over the cooling towers.

### Counter Current Surface Condenser.

The principle of counter current condensation and an assured turbulence of flow is secured in the condenser shown in Fig. 44, which is that of the Concentric Condenser Co.

In this Concentric Condenser of Bracket a series of alternately plain and corrugated tubes are nested one inside the other and held between gun-metal heads, in which are a number of concentric grooves turned to fit the tube ends. These heads are so cast that every other space communicates with the steam chamber and the other alternate spaces with the water chamber in the heads. A special cement, which softens only the first time it is heated, renders the tube ends tight against leakage. Steam passes one way and water

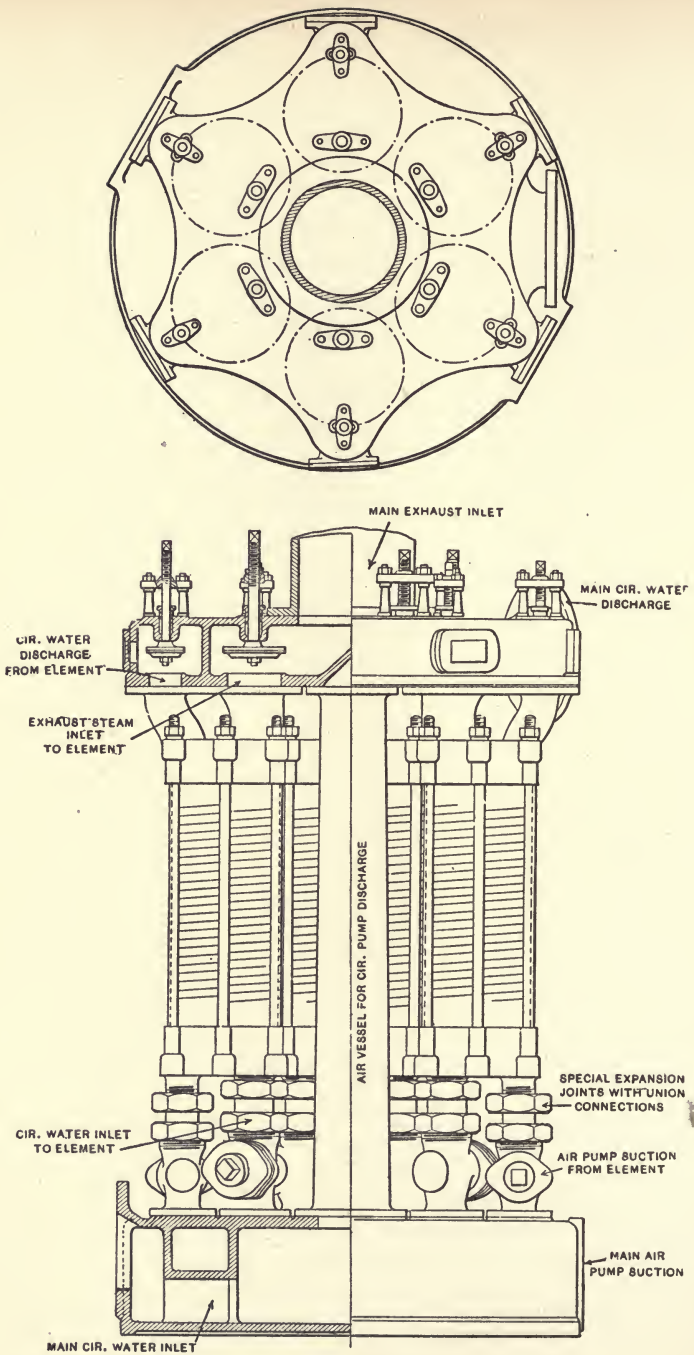

FIG. 44. BRACKET'S CONCENTRIC CONDENSER.



## EXAMPLES OF CONDENSERS

moves through the alternate tubes in opposite directions. Thus, each annular passage has one plain and one corrugated boundary and the escaping condensed steam is reduced to a temperature as low as possible, while the water of circulation escapes as hot as possible.

### Surface or Tubular Condenser.

At Fig. 61 in the chapter on air pumps will be found illustrated the condenser of Pollitt and Wigzell, which is an ordinary tubular condenser through which the circulating water passes twice, the second pass being where it should be nearest the hotter or steam inlet position.

The special point is the entry of the steam parallel with but above the tubes and by a sloping inlet cover piece which extends the full length of the tubes and serves to distribute the steam from end to end of these without short circuit danger to the final outlet. By this means every unit of tube surface is made useful and efficient. These condensers have been much used in the Yorkshire woollen factories, being placed behind the L.P. cylinder of tandem engines. The air pump is placed in the base of the condenser, and a nearly full length opening is left below the tube surface in order to prevent short circuit. The degree of vacuum secured is very good, and may be explained by the careful well considered points of the design.

### The Atmospheric Valve.

An important detail of a modern plant is the atmospheric automatic exhaust valve. This is a mushroom valve fitted with a balance lever and opening upwards. In case of failure of a condenser to act, the pressure of steam, which would rise to a dangerous degree and might burst a cast-iron condenser casing, raises the atmospheric valve and allows the steam to escape into the atmosphere. These valves, of which two illustrations are given, Fig. 45 of the valve made by Templer & Ranoe of Coventry, and Fig. 46 that made by Thomas Walker of Tewkesbury, should have an oil dashpot to restrain too rapid movement. The valve should have a

## WATER SOFTENING AND TREATMENT

drain pipe from an inch or two above the level of its lip in order to seal this effectively against air leakage. There

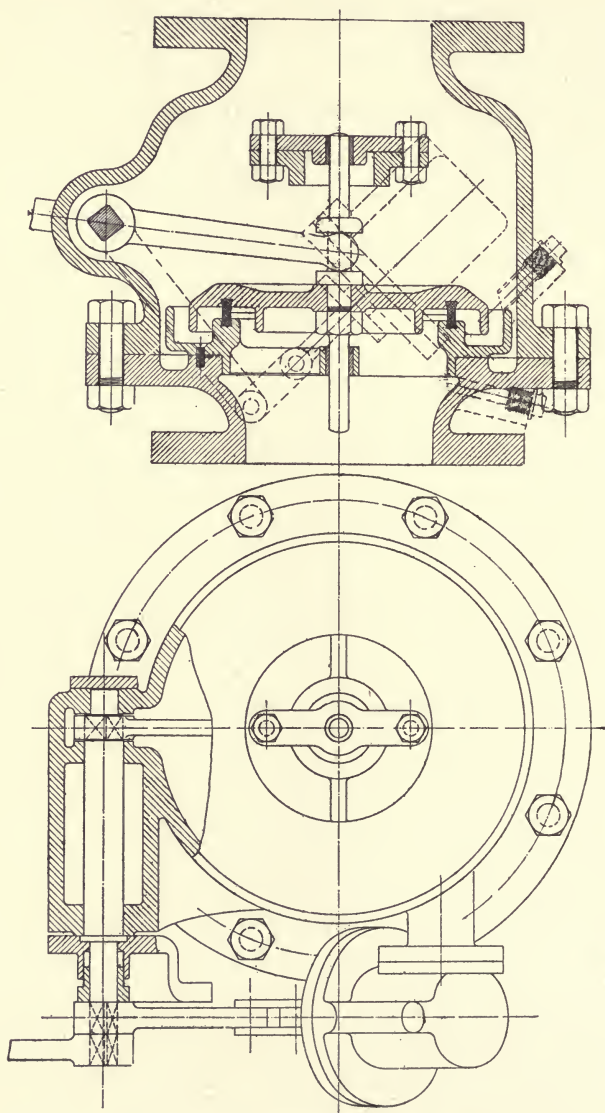

FIG. 45. ATMOSPHERIC VALVE.



## WATER SOFTENING AND TREATMENT

ment of the seating shown in more detail in Fig. 49. It will be noticed that the valve must rise from its seat a dis-

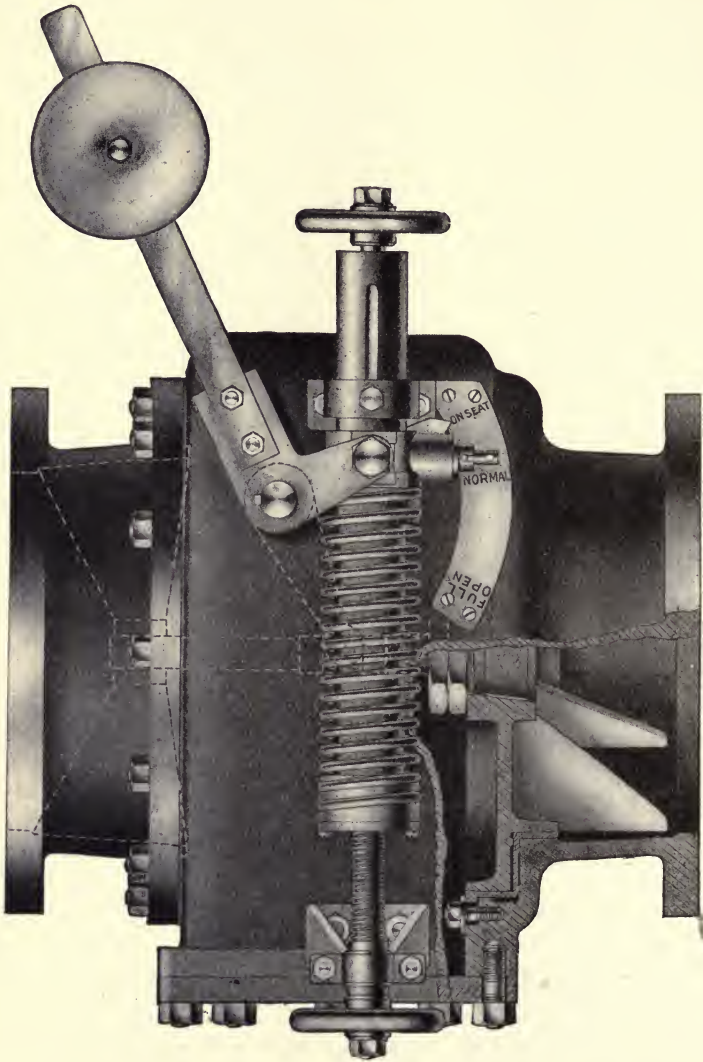

FIG. 47. ATMOSPHERIC VALVE (W. H. Spencer).

tance B before steam can pass, and the annular space N forms a cushion which prevents the valve from hammering



## EXAMPLES OF CONDENSERS

on the seat. The seating is made renewable. The balance weight is set to balance the valve and the spindle. The spring is used to regulate the valve, and is normally regu-

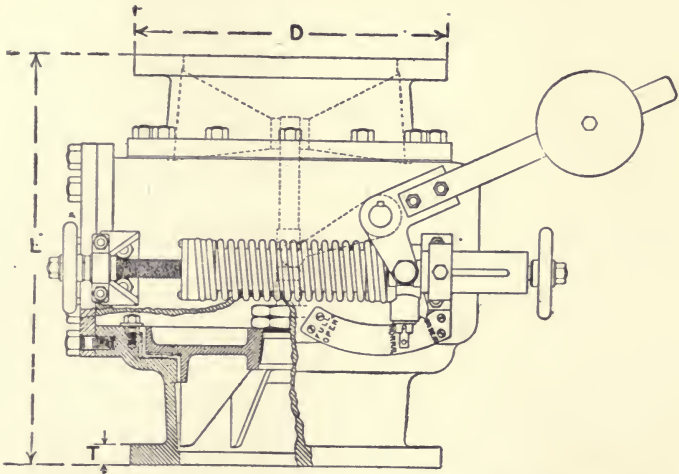

FIG. 48. SECTION OF ATMOSPHERIC VALVE (W. H. Spencer).

lated so that when the valve is under equal pressure on each side it is raised by the spring nearly the height B. It thus lifts promptly as soon as the vacuum is broken, but the

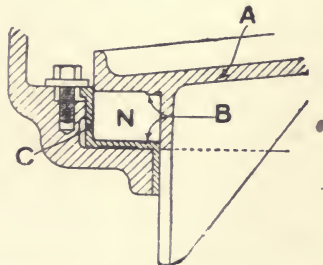

FIG. 49. DETAIL OF SEATING OF ATMOSPHERIC VALVE (W. H. Spencer).

spring tension is easily overcome when there is a partial vacuum under so large a valve, which is then pulled down to its seat.

## CHAPTER XXI

### AIR PUMPS

**T**HE Air Pump is essential to most condensing systems. The old type of air pump, as fitted to jet condensers of Boulton and Watt and other engine builders, was a pump of the type of Fig. 50, but with flap foot-valve and flap discharge-valve. With the condenser it was fully immersed in a deep tank. The bucket also had a pair of flap valves opening upwards like the wings of an insect. Hence the name "butterfly" valve. All modern air pumps are merely a development of this original air pump.

The air pump is only necessary to prevent the gradual accumulation of air from the feed-water and from leakage, that would ultimately fill the condenser to boiler pressure.

The action of a pump is as follows:—

Assume that its capacity is one half that of the condenser. Then each stroke of the pump will take out half the vapour contents of the condenser, and therefore approximately half the air. It would remove exactly half the air were it not that the relief of pressure and abstraction of air will allow more vapour to rise from the water and this might get to the air pump instead of the mixed vapour. Thus apart from this the rarefaction would proceed according to the square of the number of strokes. But each stroke of the pump

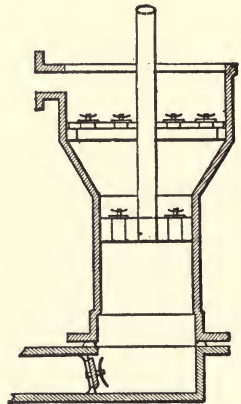

FIG. 50. PLAIN AIR PUMP.

## AIR PUMPS

draws out more water vapour and less air, and as air is always entering the condenser, the time arrives when the intake of the pump is exactly equivalent to the inflow of the air, and this marks the maximum possible vacuum.

A vacuum can never be better than that proper to the water temperature, and will be less according to the laws of mixed vapours, see Chapter XIX.

Every cubic foot of air which enters the condenser expands to from 5 to 25 cubic feet. The speed and capacity of the air pump have an effect on the capacity of the condenser, for the air pump is intermittent in action and the condenser, if very small, would show a fluctuating pressure with each stroke of the pump. Large condensers and multiple fast-running pumps thus show the steadiest vacuum gauge. An important point in air pump design is to arrange that no air that gets above the bucket shall remain undischarged that same stroke. As perfect a vacuum as possible is formed above the descending bucket, and the space is filled by mixed vapour from the condenser. The foot valve prevented the back flow of the enclosed volume of vapour under the bucket, but in some modern pumps there is no foot valve, and obviously the space above the bucket is filled by vapour rising from the water seal upon the bucket. Compare Fig. 50 with Fig. 51 to gain a clear idea of the difference.

In the type of Fig. 51, or Edwards pump, the condenser pressure is that of the vapour and of the air, and the air-pump pressure is that of the vapour only. If the mixed vapour pressure is two parts due to vapour and one part to air, only one-third of the pump barrel will be apparently available to take a further supply from the condenser, but, as will be seen later, this view must be modified by other reasoning.

Continuous running of an air pump without the addition of further air or warmth to the condenser, would finally result in refrigeration of the condenser by evaporation. An air pump overrun tends to cause refrigeration at the expense of wasted power.

The theoretical power absorbed by an air pump in dis-

## WATER SOFTENING AND TREATMENT

charging air is that represented by the work in compressing and delivering the air to and at atmospheric pressure and isothermally, for substantially the temperature remains unchanged.

Per cubic foot of free air, i.e. air at atmospheric pressure, this work is given in foot pounds by the following formula—

$$W = At \times \text{hyp. log. } \frac{p}{P_0}, \text{ where}$$

$W$  = foot pounds of work,  $t$  = absolute temperature, usually

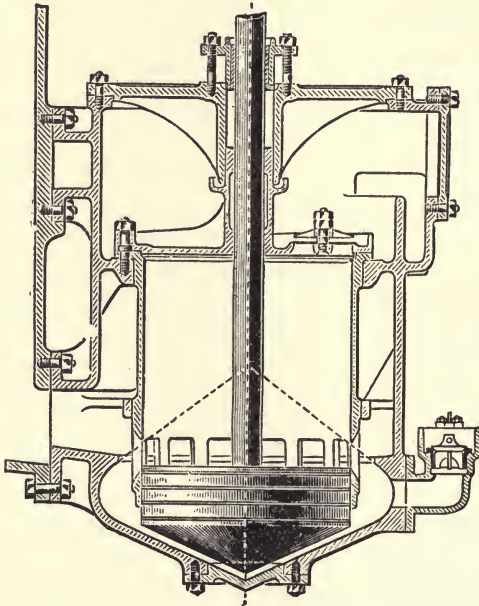

FIG. 51. EDWARDS AIR PUMP.

about  $560^{\circ}$  F.,  $p$  = atmospheric pressure, and  $P_0$  = condenser pressure.

$A$  is approximately = 4 or the constant number  $53.15 \div (13 +$  or the number of cubic feet per lb. of air at the temperature  $t$ ).

Thus for  $t = 576^{\circ}$ ;  $P_0 = 1.5$  lb.  $p = 15$  lb., we have log.

$$\frac{p}{P_0} = 2.3,$$



## AIR PUMPS

and  $W = 4 \times 576 \cdot 0 \times 2 \cdot 3 = 5,300$  foot pounds or about one-sixth of a horse-power minute. Power is also absorbed by the discharge of water, which must be pushed into the atmospheric pressure. The rest of the power absorbed is friction.

In the working of the common air pump with a through valve in the bucket, this evidently descends in a condition of equilibrium on its two faces and absorbs no power beyond frictional effect. On the upstroke it is exposed to condenser pressure below it. Above it the space is continually more restricted. But practically the space above the bucket does not vary its temperature, and that part of the pressure due to water vapour will remain constant, for the restriction of the space will simply send part of the water vapour into solution in the water present with it. If therefore the vacuum gauge shows  $2\frac{1}{2}$  lb. pressure, corresponding with a vacuum of 12.2 lb. normally, and the condenser temperature corresponds with a steam pressure of  $1\frac{1}{2}$  lb., then the air is *per se* at a pressure of 1 lb., and the work done by the bucket will be that represented by the compression of air from 1 lb. pressure at the condenser temperature up to 14.7 lb. or one atmosphere. The net foot lb. per cubic foot of air at atmospheric air will be as stated above =

$$W = At \times \text{hyp. log.} \frac{p}{P_0}.$$

For the figures named  $t^\circ$  is about  $115^\circ + 461 = 576^\circ$  (see Table I.)  $p = 14.7$  and  $P_0 = 1$ .

Per pound of air the formula becomes—

$$W = 53 \cdot 15t \times \text{hyp. log.} \frac{p}{P_0}.$$

For pumps of the Edwards type the conditions are a little different. The bucket descends against the constant pressure of the air in the condenser, for it is practically exposed on both sides to the pressure of the vapour of water. There is no serious compression of air below the bucket owing to the large relative capacity of the condenser. Otherwise the bucket does slightly raise the condenser pressure.

On its ascent the bucket is exposed to exactly the same

## WATER SOFTENING AND TREATMENT

conditions as those stated for the common type of pump. In other words we may consider only that component of pressure difference of the mixed vapour due to the air and consider only that isothermal conditions prevail, because of the effect of the water present and the small intensity of the maximum pressure dealt with, namely one atmosphere which does not involve great heat production in generating. It is thus easy to see that the work of driving an air pump may very well be chiefly made up of friction, and that where air is present in small volumes only, a friction-producing bucket had better be run as slowly as may be possible, whereas with a grooved ringless bucket there is no friction and a better speed may be run with economy.

The volume to be generated by an air pump bucket should not be less than 0.75 cubic feet per pound of steam dealt with by the condenser plant. Mr. R. W. Allen<sup>1</sup> has made tests with as little air-pump capacity as 0.5 cubic feet and he gives 0.6 cubic foot as a minimum.

With a temperature of discharge of circulating water 96.5° F., he obtained a vacuum of 26.91 inches by gauge, corresponding with 27.18 inches if corrected for 30-inch barometer. The vacuum corresponding with the temperature of air-pump discharge—110.5° F., is 27.1". The vacuum efficiency is given as 99.25 per cent., being the ratio of 26.91 to 27.18 inches. The air pump generated 0.496 cubic feet per pound of steam condensed, but there was perhaps special air-tightness in this case.

### Barometer.

The variations of the barometer either by variable weather conditions or altitude have no serious effect on air-pump work in this country, but at high altitudes (see Table in Chapter XXVI.) the pressure of the air is seriously less. Boiler pressure is greater, per gauge, with higher altitude because the air pressure is reduced. A boiler at 14.7 lb. absolute pressure always contains water at 212° F., if no air be present in it. An air pump has therefore less to do when pushing its discharge into the atmosphere.

<sup>1</sup> *Minutes of Proc. Inst. C.E.*, Session 1904-5.

## AIR PUMPS

There is less to be gained from condensing at high altitudes than at low. The same size of condenser is required, indeed it must be larger, and the only credit item must come in the fact that slightly less power should be absorbed in driving the air pump, and there should be less air to deal with both from the injection in a jet condenser and from leakage through glands, etc., owing to the reduced atmospheric pressure which tends to reduced air solution and to reduced leakage.

These are small items, and generally it may be said that condensing provides less economy, but the question will scarcely arise on which this need be considered, for even so high up as the Rand, S.A., the atmospheric pressure is still over 12 lb.

### The Air-Pump Bucket.

In the early air pumps the bucket consisted of a plain casting like a thick flanged pulley, the space between the flanges being filled with blocks of spruce pine tightly driven in dry and turned to fit the barrel. When wetted the bucket became a tight fit in the barrel, and very soon it wore easy and worked quite as well and with much less friction.

In other cases the wood was replaced by greased rope. Then about 1870 the metallic pump bucket with rings sprung in like a steam piston became more and more used. It is however a mistake to use rings in a wet air pump. They are a frequent cause of failure, breaking and overriding, etc. A bucket should be as long, or nearly so, as its diameter, especially in small sizes, and never less than five inches long. In ordinary water pumps the Author makes buckets about four inches long, plus half the diameter.

The bucket should be a plain cylinder fitting the barrel closely. Its surface should be cut into grooves about  $\frac{1}{4}$  to  $\frac{5}{16}$  wide by  $\frac{1}{16}$  to  $\frac{1}{8}$  deep, with spaces between of  $\frac{1}{4}$  to  $\frac{3}{8}$ . Thus made there will be no serious leakage nor wear, and no friction. The packing of a pump bucket or the use of rings will not bear reasoning upon. Indeed it is absurd to suppose that leakage can take place through the length of a bucket with its score or more of eddy-forming square-cut grooves.

## WATER SOFTENING AND TREATMENT

### General Forms of Air Pumps.

There are two main types of pump in respect of their action, viz., bucket pumps and plungers or displacers. The bucket pump requires no further special description. In the displacement pump the bucket is merely a solid plunger, often more or less ogival ended, which enters upon and recedes from the space volume of the barrel or end chambers.

Whereas pumps work best perhaps when vertical, they are often made horizontal, but even in certain horizontal pumps the real surface which expels air is the surface of water, in the end chambers of the pump, which is caused to rise and fall by the displacement of the horizontally-moving plunger. Pumps are made single or double acting, and in certain forms of horizontal pumps it becomes necessary to take into consideration certain effects of gravity in determining the movement of the water so as to avoid shock.

The various points can perhaps best be brought forward in the explanation of the several pumps employed as illustrative examples.



## CHAPTER XXII

### TYPES OF AIR PUMPS

#### The Edwards Air Pump.

**I**N this pump (Figs. 51, 52) the speed is high and the water is compelled to enter the pump by the sudden blow of the conically-pointed bucket striking the water collected in the lower chamber and impelling it round the curved passages which direct it through the ports just opened by the descent of the bucket past them, as seen in Fig. 52. The descent of the bucket in a space vacant of air produces, as explained previously, a vacuum above the bucket as perfect as the water temperature will allow. There is no air effect, and when the ports are open the mixed air and gas in the condenser rush in to fill the vacancy. The volume of the barrel above the bucket is thus available to the extent of the absence of air which is present in the condenser, and it must not be imagined that the full volume of the bucket stroke is abstracted at each stroke.

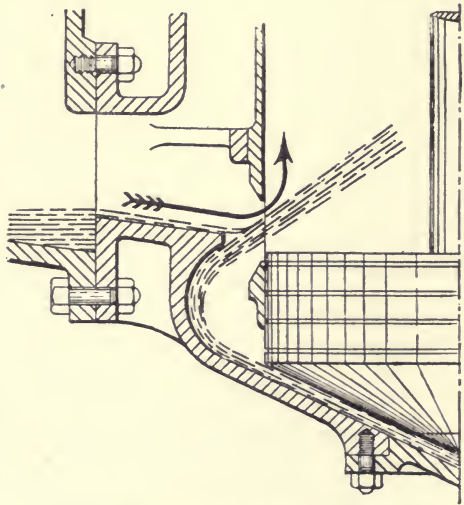

FIG. 52. EDWARDS AIR PUMP.

## WATER SOFTENING AND TREATMENT

When applied to jet condensers the speed is more moderate, as shown by the annexed table, which shows the effect of the larger volume of water introduced with the jet as compared with that in the discharge from a surface condenser.

Type of Condenser.	Revolutions per Minute.	Vacuum in Inches.	Barometer in Inches.	Temperature of Air Pump Discharge in Degrees Fahrenheit.	Pressure due to Temperature in Inches.	Difference between Vacuum obtained and highest Vacuum theoretically possible if no air present
No. (1) Surface.	240	30.2	30.85	65	.619	.03
	250	29.6	30.8	83	1.1	.1
No. (2) Surface.	375	28	30.45	107	2.369	.081
No. (3) Jet.	128	28.25	30	88	1.328	.422
	128	28.375	30	84	1.169	.456

This pump is very commonly made with three barrels. Such a pump with three 14-inch diameter barrels and a stroke of 12 inches is rated for 45,000 lb. of steam per hour from a surface condenser if run at a speed of 150 r.p.m. This rating points to a capacity of 0.66 of a cubic foot per pound of feed water, calculated of course on one working stroke of each barrel per revolution.

A convenient way of driving these pumps is by an electric motor through gearing which may include a raw hide pinion, and in any case should be broad, of fairly fine pitch, and with teeth not above half the pitch in length.

In Fig. 53 is seen a combined air and circulating pump with electric drive, as arranged by the Mirrlees Watson Co., and in Fig. 54 a double-barrel Edwards air pump with circulating pump and surface condenser complete by Isaac Storey & Sons, Ltd.

It should be added that when the bucket uncovers the ports to the condenser and mixed vapour rushes into the pump barrel to equalize pressure therein with that in the condenser, the inrush will continue until either the port is again closed or the vapour mixture in the barrel becomes identical with that in the condenser, for since the air pump

## TYPES OF AIR PUMPS

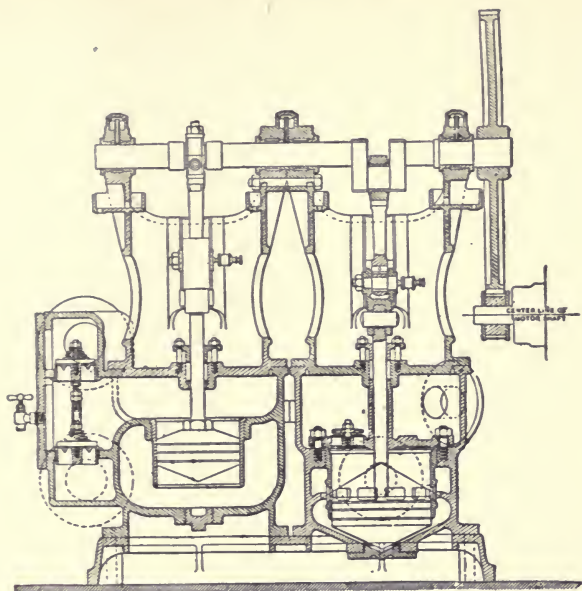

FIG. 53. ELECTRICALLY DRIVEN AIR AND CIRCULATING PUMP (Mirreless Watson Co.)

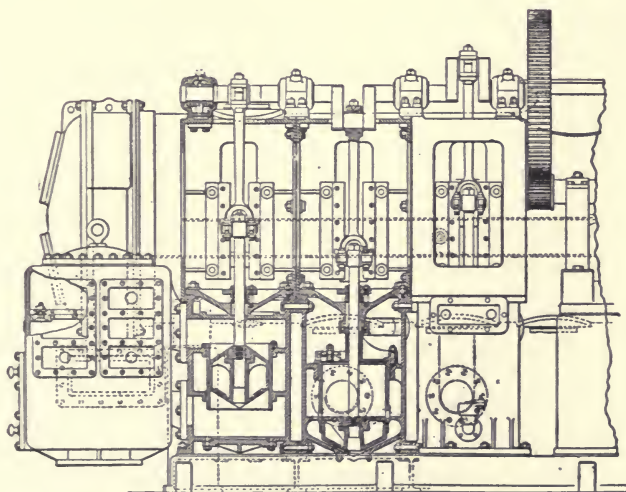

FIG. 54. DOUBLE AIR PUMP AND CIRCULATING PUMP ELECTRICALLY DRIVEN (Isaac Storey & Sons, Ltd.)

## WATER SOFTENING AND TREATMENT

contains only water vapour this must have a pressure proper to the temperature. But when it is exposed to the higher pressure of the condenser it is compressed into smaller space, and it is not possible for more water vapour to exist in such smaller space. The law of molecular equilibrium forbids this. Therefore the pure unmixed water vapour must all condense to water, and the pump barrel must become full

of the same ratio of mixed vapour as exists in the condenser. The Edwards and similar classes of pumps do, therefore, work at full efficiency if there is time to allow of this while the ports are uncovered by the bucket. It is all a question of rapidity of condensation of water vapour exposed to a pressure inconsistent with the law of molecular equilibrium, see Chapter XIX.

The Brake Horse Power required to drive these pumps may be taken as 1 h.p. for every 5,000 gallons per hour raised 20 feet, or 10,000 gallons raised 10 feet and so on. Pipe friction must be added extra.

The vertical air pump of Davey Paxman & Co. is shown in Fig. 55. It is double acting and draws its supply through

a port which is uncovered by the bucket at each stroke. On the upstroke of the bucket, discharge takes place through the top discharge valves. On the down stroke, discharge takes place into the bucket and thence through the central guide plunger, which is water sealed as shown plainly in the figure. This is a high-speed pump and can be run direct off a high-speed engine, the 14-inch dia.  $\times$  7-inch stroke three-crank pump being run at 250 revs. per minute.

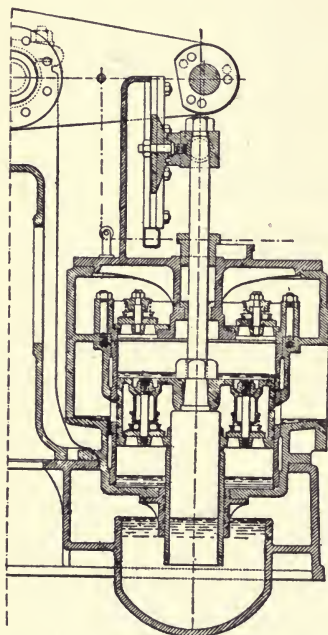

FIG. 55. VERTICAL AIR PUMP  
(Davey Paxman & Co.)



## TYPES OF AIR PUMPS

Rather over half the duty is done by the upper side of the bucket, and being double acting the bucket diameter need not be above about seven-tenths that of a single-acting pump.

TABLE XVI.

SIZES OF CENTRIFUGAL PUMPS SUITABLE FOR EJECTOR CONDENSERS.

Diameter of Suction and Discharge pipes in inches.	Revolutions per minute for lifts of 30 feet.	Water discharged per minute.	Suitable for Ledward's Condenser No.
2	1650	68 galls.	3 to 4
3	1372	150 „	5 to 6
4	1372	250 „	6 to 7
5	1000	420 „	8 to 10
6	1000	620 „	12
7	769	850 „	12 to 14
8	796	1100 „	14 to 16
10	686	1900 „	18
12	686	2500 „	20

TABLE XVII.

CAPACITY OF EJECTORS.

No. corresponding to diameter of Exhaust Pipe in inches.	Capacity Steam Condensed per hour. Lb.	Condensing Water required per hour. Gallons.
1½	200	550
2½	400	1100
3	800	2200
4	1500	4000
5	2000	5500
6	3000	8250
7	4000	11000
8	6000	16500
10	8000	22000
12	12000	33000
14	20000	55000
16	28000	77000
18	36000	99000
20	48000	132000
22	56000	165000
24	66000	198000

# WATER SOFTENING AND TREATMENT

## The Ejector Air Pump.

This, already referred to as the Ejector Condenser (Fig. 37), acts by the conversion of the molecular kinetic energy in the exhaust steam into kinetic mass energy of water. The jet of water flows into the vacuum formed in the combining head (Fig. 56) and carries with it the air present with the steam. It is considered best to allow water to enter

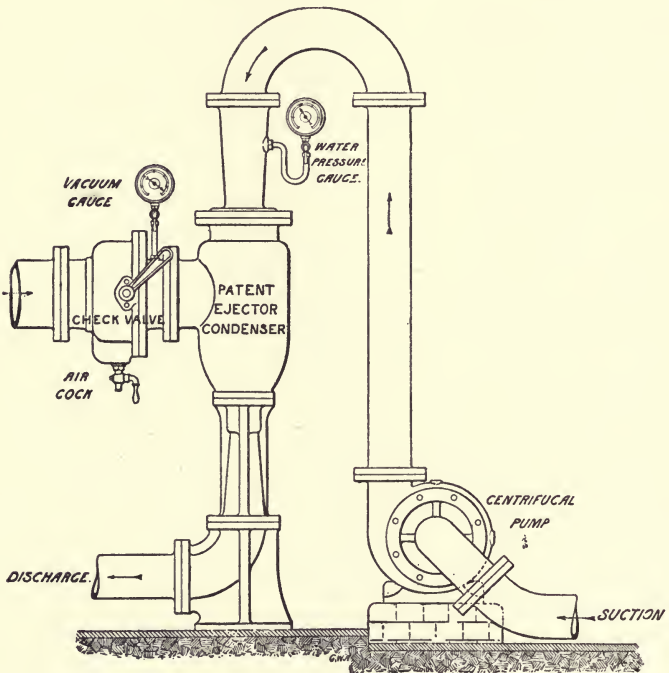

FIG. 56. EJECTOR CONDENSER WITH PUMP (Ledward.)

from an elevation of 15 to 20 feet or to connect a centrifugal pump directly to the ejector so as to have a closed cycle from the water supply to the ejector discharge.

The direct connexion of a pump is shown in Fig. 56, and such pumps may be motor driven. Ordinary centrifugal pumps will perform as per the annexed Table XVI., and the general dimensions of ejectors are given in the Table XVII.,

## TYPES OF AIR PUMPS

together with their capacity in steam condensed calculated on the assumption of a water supply at 60° F. For warmer water the ejector requires to be correspondingly larger. When fixed horizontally, as they may be, the steam should enter from above, and the water supply should have a velocity equivalent to a head of 20 to 30 feet.

### The Displacement Pump of Hick Hargreaves Co.

In this pump (Fig. 57) a round-ended solid plunger works in a barrel so connected to a valve chamber that the plunger is double acting. The inlets are by the inclined laterally placed valves which open inwards and downwards, and the outlet valves are at the top of the central and annular outlet chambers. It will be noted that this pump is always full of water and air, and that as the air enters it rises at once to the top of the outlet chambers under the valves and is the first to be expelled. The outlet valves are always drowned and therefore air-sealed. This type of pump was applied to the 3,000 h.-p. engines of Messrs. Sassoon of Bombay, together with a circulating pump of similar type. The diagrams 1 to 4 (Fig. 58) show the general form of indicator diagrams from good air pumps, the compression being indicated by the upward curve, the expulsion to the atmosphere by the short horizontal line at the top of the diagrams, and the return stroke by the lower curve. The diagrams teach by the length of the level portion

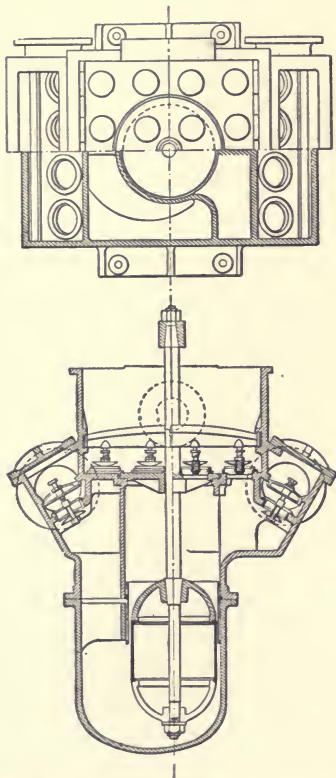

FIG 57. DISPLACEMENT AIR PUMP.

## WATER SOFTENING AND TREATMENT

that the pump is delivering during about  $\frac{1}{8}$  to  $\frac{1}{20}$  of its travel, No. 1 top taking in less air evidently than the bottom side.

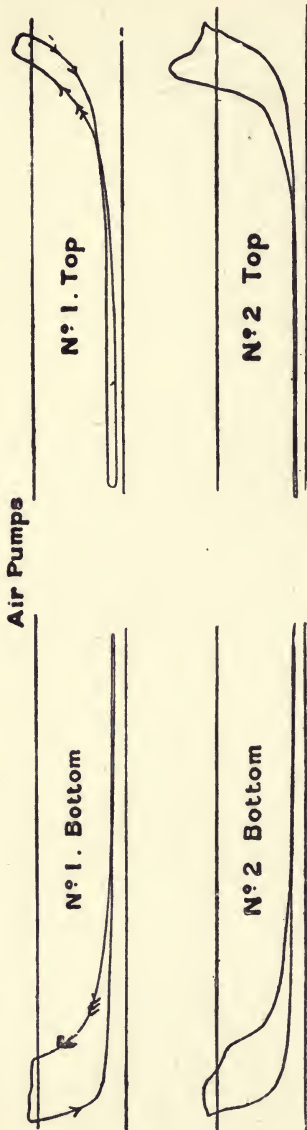

FIG. 58. AIR-PUMP DIAGRAMS.

### The Horizontal Air Pump.

When horizontal air pumps were first employed they often gave poor results. This was explained by Mr. Longridge in his report of 1888<sup>1</sup> as due to bad design. Thus in pumps of the type of Fig. 59 he states that the velocity of the water in the barrel must not exceed that due to the head measured from the bucket centre to the water surface in the end chambers. Proper design therefore includes a question of height of end chamber.

These pumps have been much employed tandem with the steam cylinders, and therefore with a bucket velocity of 600 to 700 feet per minute as a mean and therefore a maximum speed, 1.57 times this, or say 950 feet per minute in a given case. With square-ended barrel the vena contracta effect adds 50 per cent. to the water velocity necessary to follow the bucket solidly. Let this velocity be put down roundly at 25 feet per second. Then since  $V =$

<sup>1</sup> See *Annual Report 1888, Engine, Boiler and Employers' Liability Association, Ltd.*



## TYPES OF AIR PUMPS

8  $\sqrt{H}$  and  $V=25$  feet we have  $\sqrt{H}$ =fully 3 feet and  $H=9$  feet. If this height cannot be allowed, then the velocity must be less. It can be kept down to that of the bucket by flaring out the barrel ends to the correct conoidal form so that  $V$  shall only be 16 to 18 feet per second, and then  $H$  becomes 4 to  $5\frac{1}{2}$  feet, but height and correct entrance are needed to keep the water solidly against the bucket face, and the movement of the water thus to and fro so rapidly means considerable stress on parts. Obviously the water surfaces in the end chambers simply move up and down and are the real acting faces of the bucket in expelling air and drawing it in from the condenser.

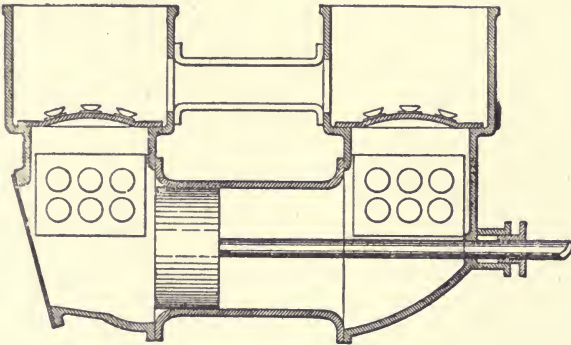

FIG. 59. HORIZONTAL AIR PUMP.

Generally the pump as shown in Fig. 59 is useful for lower speeds and for driving by direct acting steam cylinders. It then forms a good combination, and the bucket, being always drowned, is airtight.

### Tail Rod Pump.

The high-speed tail-rod pump by Pollitt & Wigzell (Fig. 60) is of different design from the foregoing and consists of an air-pump barrel standing out horizontally in the base of a jet condenser. The bucket is solid and uncovers a series of ring ports, on its outward course, through which enter water and air to be expelled through the end delivery valves. The water about the pump is always maintained as a mini-

## WATER SOFTENING AND TREATMENT

imum quantity. Though made for long-stroke engines this arrangement is silent, and it is run at upwards of 880 feet per minute and to as many as 150 revolutions. When attached to a surface condenser the arrangement is that of Fig. 61, with often a circulating pump in combination. Here the circulating pump must not be called on to lift its supply too far. Say that the minimum speed of the bucket is  $V = 820$  feet per second in a particular case. Then the equivalent head will be  $6\frac{1}{4}$  feet or  $V = 20 = 8 \sqrt{H}$ . If the pump ordinarily would lift its water  $23\frac{1}{4}$  feet at slow speed, it should not be required to lift more than  $23\frac{1}{4} - 6\frac{1}{4} = 17$  feet, or to allow ample effect, say 14 feet.

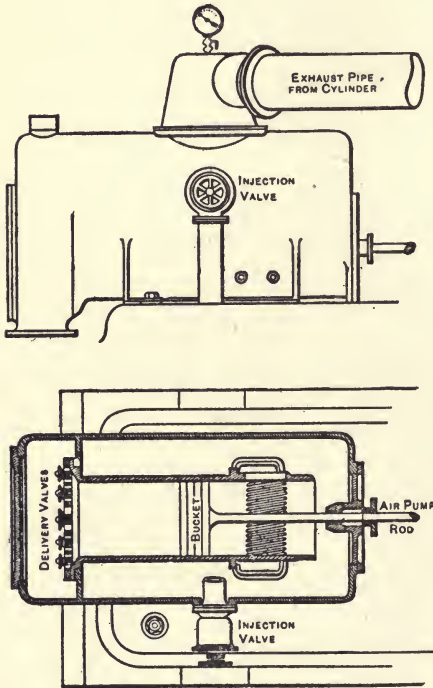

FIG. 60. HIGH-SPEED TAIL-ROD AIR PUMP.

Owing to the bucket velocity the water pushed before it distributes evenly over the bucket face, and in the air pump this ensures that the air shall first be expelled through the delivery valves. If run at a slow speed, the water would collect on the lower part of the barrel and much air would remain behind to vitiate the vacuum on the return stroke. Probably this explains the failure of slow-running horizontal air pumps not supplied with end-water chambers of a height sufficient to drown the bucket. It will be noted that the circulating pump in Fig. 61 is double acting, and draws its water from a surrounding casing.

## TYPES OF AIR PUMPS

In Fig. 62 the jet condenser is seen combined with a steam-driven horizontal air pump with flywheel. This enables the steam to be used expansively. Steam enters the

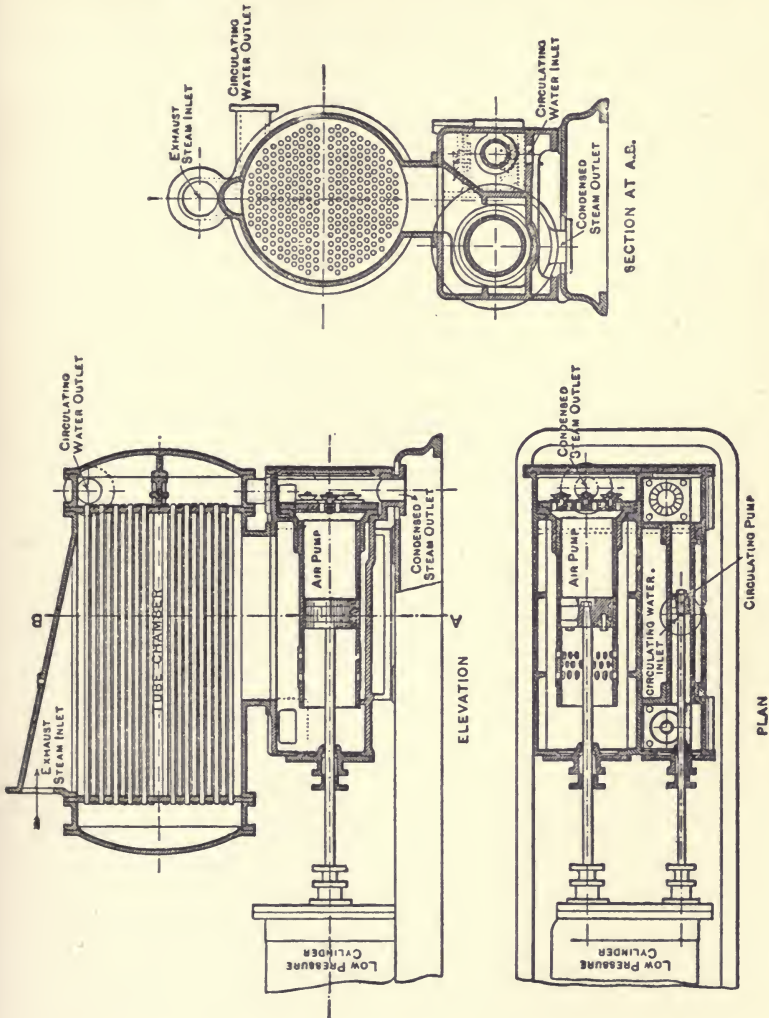

FIG. 61. COMBINED TAIL-ROD AIR AND CIRCULATING PUMPS.

condenser round the water-inlet valve, and is drawn into the pump from below. The air rises directly to the outlet valves and is promptly discharged.

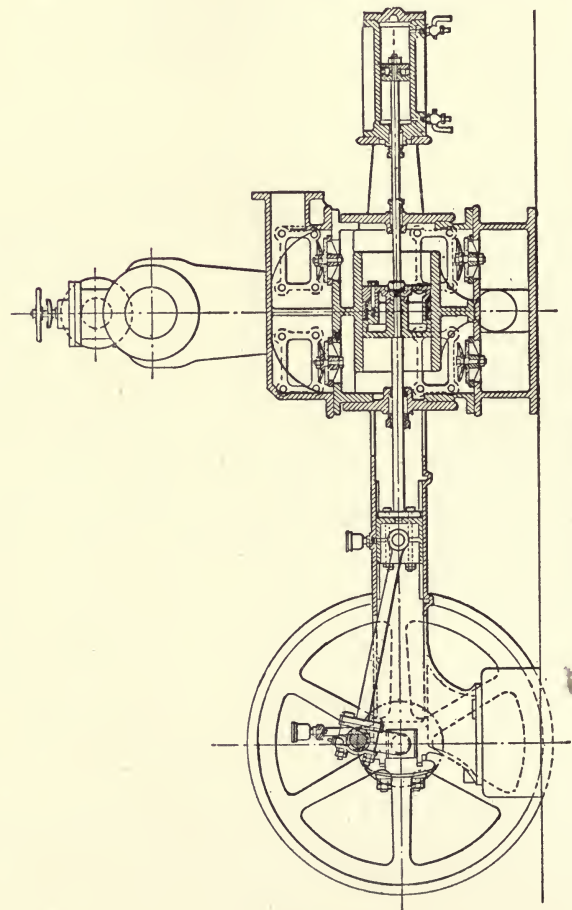

FIG. 62. STEAM-DRIVEN HORIZONTAL AIR PUMP (Pulsometer Co.).



## TYPES OF AIR PUMPS

### Combined Direct-driven Air Pumps.

In Fig. 63 is shown the Worthington Co.'s direct driven air and circulating pump with tubular surface condenser. For an area of 1,075 square feet of surface steam cylinders of 6 and 10 inches compound tandem type are arranged on the same rod as 10 $\frac{1}{4}$ -inch air pumps and 10 $\frac{1}{4}$ -inch circulating pumps. The stroke of all is 10 inches, and the duplex arrangement is adopted, making two complete sets side by side of the above details. The Author's experience of such

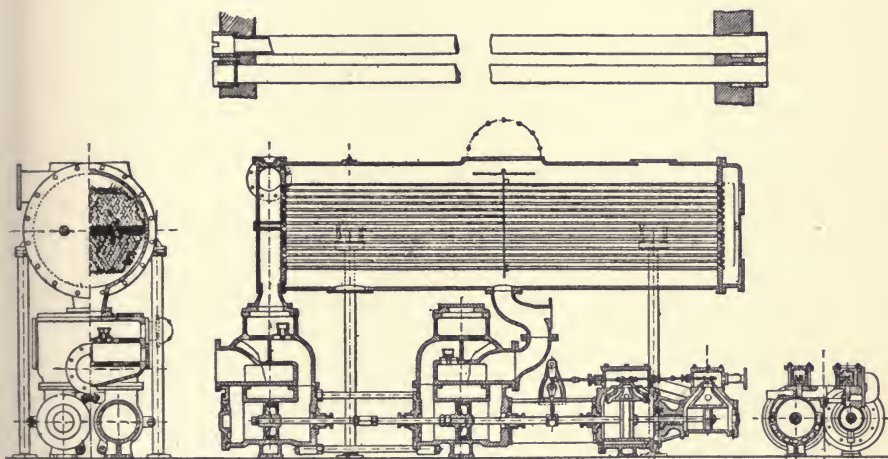

FIG. 63. COMBINED AIR AND CIRCULATING PUMPS.

pumps with flat indiarubber valves is that frequently the valves cockle up and the pumps fall off in efficiency or refuse work entirely. Dermatine valves stand much better than rubber. These pumps are always fixed below the condenser, which is of the usual two-pass type as regards water. The tubes of the Worthington condenser are flanged and held in one tube plate by a packing ring and screwed ferrule. At the other end they are packed and fitted with a screwed gland.

### Compound Air Pumps.

The ratio of the atmospheric pressure to the pressure in a good condenser is very high. The action of an air pump

## WATER SOFTENING AND TREATMENT

drawing from a cold condenser is equivalent to that of an air compressor compressing to a very high degree.

Thus if atmospheric pressure is 14.7, and a vacuum of 28 inches is secured, the absolute pressure of which is 0.944 lb., this represents the maximum possible vacuum for a temperature of 100° F.

Then  $14.7 - 0.944 = 13.756$  lb. In this case there could be no air present. But suppose with a temperature of 100° F. that the vacuum was only  $27\frac{1}{2}$  inches or 1.189 lb., then  $1.189 - 0.944 = 0.245$  lb. unaccounted for, or rather accounted for by air pressure. Then  $14.7 \div 0.245 = 60$ , and the air pump in such a case will be called on to compress the air sixty times in delivering it to the atmosphere.

Ostensibly because of the theory that air forms a blanket about the tubes of a condenser, the supplementary condenser of Parsons is employed for the Parsons turbine. Actually this augmentor is a form of compound air pump—the addition of a second stage such as would be naturally applied were an air compressor required to compress to sixty atmospheres. Let it be supposed that by means of the augmentor the air is gathered from the condenser and condensed from 0.245 lb. to as much as 2.45 lb.—the Author has no figures showing the effect of the augmentor—then the ordinary air pump, instead of compressing sixty times will be called on to compress only six times. Fig. 64 shows an arrangement of this two-stage air pump. It will be observed that the condenser is slightly inclined, and the water-outlet pipe is cranked below the indraught power of the regular air pump, thus forming an air trap. On the left a steam ejector draws air and vapour out of the condenser and forces them through the small augmentor condenser, which is full of water tubes, and forward to the intake of the air pump, which is thus enabled to pick up at each stroke as many times the quantity of air as is represented by the ratio of compression performed by the ejector. The steam consumption of this steam jet is said to be  $1\frac{1}{2}$  per cent. of the total steam used at full load by the engine. The water vapour present in the augmentor space is only that proper to the temperature. The increase of pressure due to the

## TYPES OF AIR PUMPS

augmentor jet simply causes the water vapour to condense until only so much is present as satisfies the molecular equilibrium.

It is said that the effect is to increase the pressure at the air pump to about 26 inches, when the condenser vacuum is  $27\frac{1}{2}$  to 28 inches, that is, the effect of the jet is to produce a difference of  $1\frac{1}{2}$  to 2 inches or 0.736 to 0.982 lb.

If this effect were produced with reciprocating engines having a mean pressure referred to the l.-p. cylinder of even as low as 30 lb., the advantage gained would be less than 3 per cent. gross and only  $1\frac{1}{2}$  per cent. nett. The circulating water used in turbine work is usually large, about fifty-fold

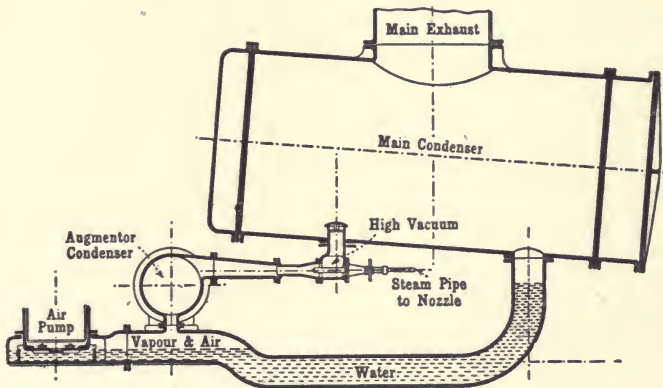

FIG. 64. TWO-STAGE AIR PUMP WITH JET AUGMENTOR.

the full load steam consumption in place of an ordinary thirty-fold. An average of 0.4 per cent. of the total steam is used up in the circulation of so much water, and the vacuum is improved, says Mr. Parsons,  $\frac{3}{4}$  to 1 inch, which represents 4 to 5 per cent. gain of power in the turbine. The auxiliary condenser has a surface one-twentieth that of the main condenser. If from these figures<sup>1</sup> the air pressure be assumed increased even four times by the steam augmentor, the actual air pump is rendered so many times more efficient, but the paper gives no temperatures from which any reliable data can be abstracted on this item.

<sup>1</sup> *Journal Inst. C.E.*, vol. xxiii. pt. 4.



## WATER SOFTENING AND TREATMENT

Without a knowledge of condenser temperatures it is impossible to judge the efficiency of operation or of the amount of air present.

A form of compound air pump is that arranged with the barometric condenser at the Manhattan Power Station, New York. Originally fitted with ordinary triple-barrel air pumps these proved unsatisfactory. In place of these pumps a rotatory dry air pump was arranged to take "dry" air from the head of the barometric condenser, no attempt being made to carry off the air in the water column, though some is thus carried off. But the dry rotating air pump

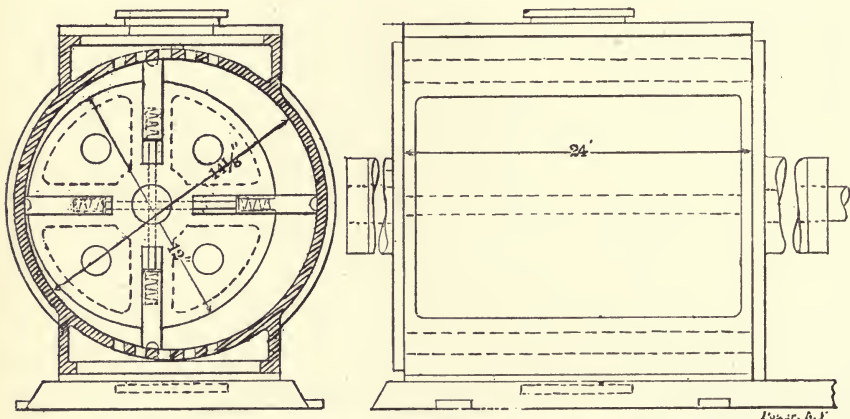

FIG. 65. ROTATIVE AIR PUMP FOR AUGMENTOR WORK.

compresses the air somewhat and delivers into the barometric discharge pipe in small bubbles, which are carried away to the descending column of water.

The air pump is simply a modified Beales gas exhauster, and consists of a cylindrical casing containing a smaller rotating cylinder fitted with four sliding blades pressed outwards by springs against the inner surface of the casing, as shown in Fig. 65. Thus, instead of the air-pump diagram being like the full diagram A in Fig. 66, it becomes truncated to the form B. The difference of pressure against which the rotating exhauster works is thus reduced to one-third of what would be necessary if discharging to atmosphere.



## TYPES OF AIR PUMPS

Hence the possibility of using this gas exhauster otherwise not suitable for air-pump work.

### Position of Condensers and Air Pumps.

Given absolute airtightness there appears no reason why the condensing plant should not, if necessary, be placed a considerable distance from the engine if circumstances call for this. The exhaust pipe should be larger when long. But where reasonably practicable the condenser should be close to the engine, and so should the air pump, if only to reduce the area of parts containing pressures below the atmosphere. A long exhaust pipe, especially in the open

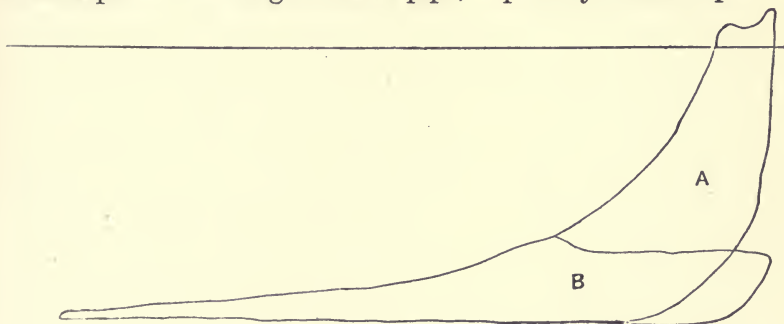

FIG. 66. AIR-PUMP DIAGRAMS.

air, will act as a condenser and relieve the work on the condenser proper. In all probability the poor vacua which attend long exhaust pipes arise from air leakages through badly jointed pipes and bad castings, especially about the chaplet marks of horizontally cast pipes. All good pipes should be vertically cast and should be dipped hot into tar and pitch mixture and kept well painted.

Given large and tight exhaust pipes, there seems no reason why steam should not be carried far to a condenser in preference to pumping a large weight of water uphill to an engine, as is done at the Newcastle-on-Tyne Manors Power Station.

## CHAPTER XXIII

### CIRCULATING PUMPS

SOME of these will be found illustrated with air pumps and condensers, as in Figs. 36, 39, 53, 54, etc. Generally speaking, if not driven by the main engine, the centrifugal pump is the best and cheapest form of pump for lifting or forcing a large body of water at a low pressure through a condenser. This pump is most conveniently driven by an electric motor, which like the pump requires to run at a high rate of rotation. They are small in bulk for their output. Centrifugal pumps are rated for size by the diameter of their inlet and discharge pipes, and their output ratio varies about with the square of this diameter. Thus while a 5-inch pump should discharge about 30,000 gallons per hour under certain conditions, a 7-inch under similar conditions will discharge nearly 50,000 gallons. A rule for output is thus  $F = 3D^2$  where  $D$  is the diameter in inches and  $F$  = cubic feet per minute. The diameter of the rotating fan or runner is about  $3D$ .

With a foot valve and a temperature about 52° F. the Author has run a 5-inch centrifugal pump and discharged 20,000 gallons per hour with a suction lift of over 30 feet below the pump. The water supply was an artesian well, and the probability is that there was little free gas in the water and the vacuum proper to a temperature of 52° F. is over 29½ inches of mercury, or less than half a foot of water head. This shows the effect of air in vitiating a vacuum and the advantage of its absence in securing maximum pump efficiencies.

Any kind of water pump may be employed for circulating

## CIRCULATING PUMPS

purposes. That of Hick Hargreaves, shown in Fig. 67, resembles their air pump and consists of an ogival double-headed plunger moving to and fro in a sleeve between two water chambers. It will be observed that such a pump may be placed horizontally or vertically. The illustration is

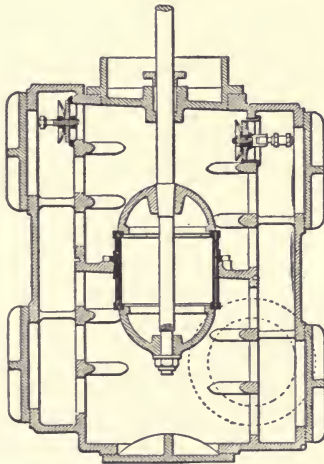
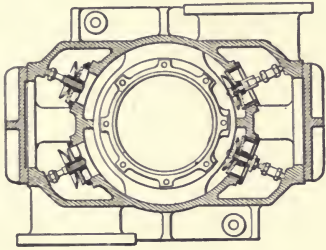

FIG. 67. DISPLACEMENT CIRCULATING PUMP.

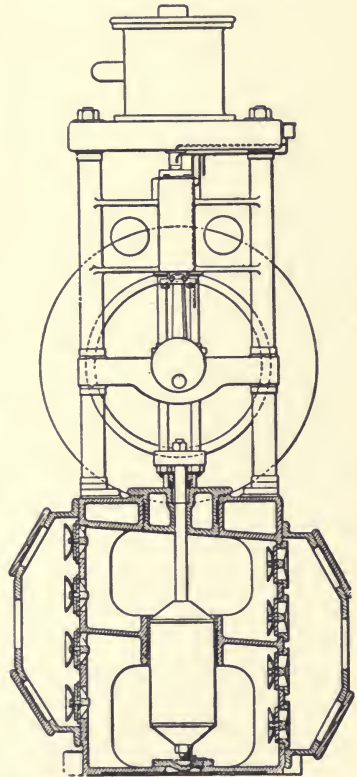

FIG. 68. DISPLACEMENT CIRCULATING PUMP (The Pulsometer Co.).

from a vertical pump, and the sloping upper boundary of the discharge chambers should be noted whereby the last particle of air can escape through the discharge valves, and any air trap is avoided.

The Pulsometer Co. make the vertical displacement circulating pump Fig. 68, the points to be noted being the

## WATER SOFTENING AND TREATMENT

pointed ends of the plunger and the sloping upper boundaries of the two chambers, so made to facilitate free escape of air to the discharge valves.

### Coefficient of Contraction.

Experience has proved that the amount of water flowing out of an orifice under a given head is not to be found simply by multiplying the velocity due to the head by the area.

A deduction has to be made from this theoretical duty owing to the peculiar contraction of area of a jet. A corrective coefficient is required to allow for this "*vena contracta*."

This coefficient varies with the head and with the form of the orifice. Navier gives the co-efficient =  $C = 0.636$  for orifices in thin plates and  $0.62$  for circular orifices of which the diameter lies between  $0.02$  m. and  $0.16$  m., or say  $\frac{4}{5}$  to  $6\frac{1}{4}$  inches where the head does not exceed  $6.80$  m. or about  $22$  feet  $4$  inches.  $C = 0.62$  for a rectangular orifice of which the minimum length is between  $0.2$  and  $0.16$  m. and the breadth is more than twenty times less. For a very short conical orifice if  $2\phi$  is the angle of the cone,  $C$  is given by Castel as follows.

$2\phi$	C.	$2\phi$	C.
0.0°	.829	13.24°	.946
1.36	.866	14.28	.941
3.10	.895	16.36	.938
4.10	.912	19.28	.924
5.26	.924	21.00	.918
7.52	.929	23.00	.913
8.58	.934	29.58	.896
10.20	.938	40.20	.869
12.04	.942	48.50	.847

Navier gives  $C = 1.00$  for  $2\phi = 20^\circ$  and  $C = 0.93$  for  $2\phi = 50^\circ$ .



Section III

---

FEED HEATERS  
STAGE HEATING



## CHAPTER XXIV

### FEED HEATING

**T**HE object of heating the feed water of a steam boiler is five-fold. First, it effects a saving of heat that would otherwise go to waste in exhaust steam or exhaust gases ; secondly, it enables a given boiler to produce more steam, and may thus obviate the necessity of adding to plant ; thirdly, it saves a boiler from certain stresses and certain forms of corrosion to feed in the water hot ; fourthly, the heating of feed water assists it to deposit some of its salts prior to entering the boiler, and if a temperature of boiling is reached, the  $\text{CO}_2$  gas which holds lime carbonate in suspension is driven off and temporary hardness is removed thereby. And finally, there is reason to believe that the heat transference from a fire to water on the other side of a fire-heated plate is facilitated when fully hot water alone is allowed to enter a boiler. On this point there are strong differences of opinion, and no final test determinations.

#### Fire-Heated or Flue-Feed Heaters.

Practically, the fire-heated flue-feed heater is confined to that type which makes use of heat in the waste gases of a furnace, and this type has become practically reduced to a single form, which has become known as the Green's Economizer. This apparatus consists of a number of cast-iron pipes 9 feet long and  $4\frac{9}{10}$  inches external diameter, with their ends turned true and pressed into cast-iron end or header boxes bored out to receive them. These headers vary in length from that sufficient to hold 4 pipes up to

# WATER SOFTENING AND TREATMENT

as many as 12, the sections thus built up always extending across the flue, which is usually enlarged so that the net

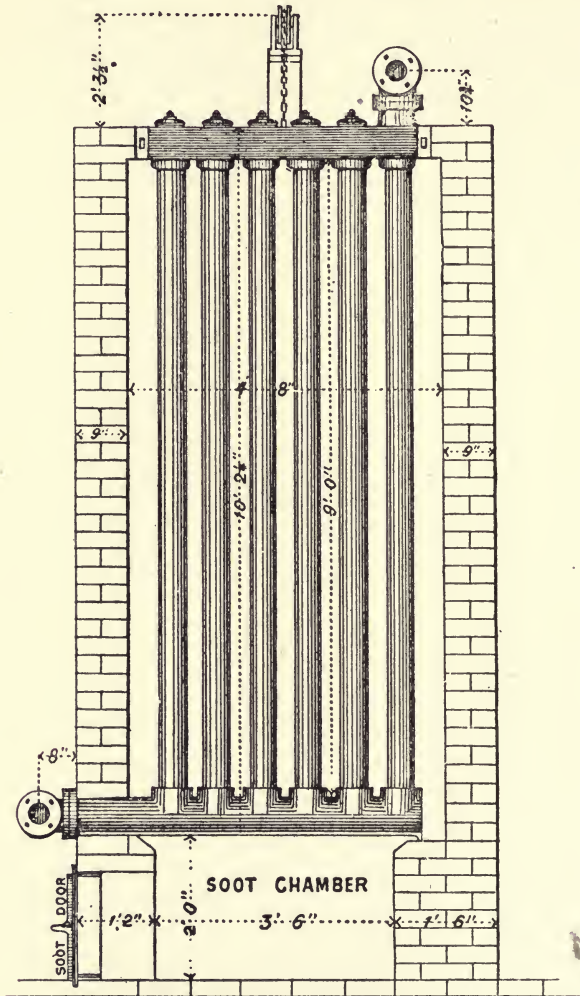

FIG. 69. CROSS SECTION OF ECONOMIZER.

area between the tubes shall be the equivalent of the cross section of the flue leading to the economizer.

These sections are built in the widened flue in multiples



## FEED HEATING

of four. Thus, the smallest economizer of 6 pipes (Fig. 69) in width must contain a total of 24, 48, 72, or 96 pipes and so on, the reason for this being that scrapers are made to move up and down the pipes, and each two rows of scrapers are carried by a chain over a wheel, and on the other end of the chain are the scrapers of two other rows of pipe. Where the width of an economizer is considerable, there are two lines of suspension wheels. These wheels carry also a worm wheel and they are all driven by worms on a lay shaft, which is automatically reversed in rotation by an automatic tumbler clutch connected to the driver of a double pair of bevel wheels. In this way the scrapers constantly travel up and down the length of the pipes and remove soot and dust, which falls into the chamber below the lower boxes. Ordinarily the pipes are set  $7\frac{1}{4}$  inches apart, C to C, along the headers, and the headers are 8 inches centre to centre along the flues.

A very usual allowance of economizer is 3 square feet of pipe area for each square foot of grate surface. This about doubles the heating surface of the Lancashire boiler, and represents from 960 to 1,200 square feet per boiler of economizer surface, or 96 to 120 pipes, according to the size of the boiler. In cotton factories it is very usual to allow 4 pipes for each ton of coal burned per week.

All the headers, top and bottom, are connected to a multiple flanged pipe, through which water is fed in or taken off. On these inlet and outlet pipes are pockets to hold thermometers and blow-out and safety valves respectively. The scraper gear is driven by a small engine, by a belt from some adjacent shaft, or by an electric motor. The top boxes have a capped opening opposite each tube, with caps and centre bolts and cross bars.

Economizers are put in the full run of the main flue, but there is a by-pass flue to pass the gas in case of repair or cleaning of the economizer. When more than twelve sections are joined together, the connecting pipes are fitted with spring bends projecting horizontally to allow of differential expansion of parts. In large economizers there may be two divisions in series, one after another, the water

## WATER SOFTENING AND TREATMENT

first entering that division nearer to the chimney. As water enters an economizer equally freely at each section box, the pipes most highly heated will have the best circulation and do most work. All the pipes are in parallel, so that the average water movement is very slow, and the resistance to flow is practically nil, and the placing of one

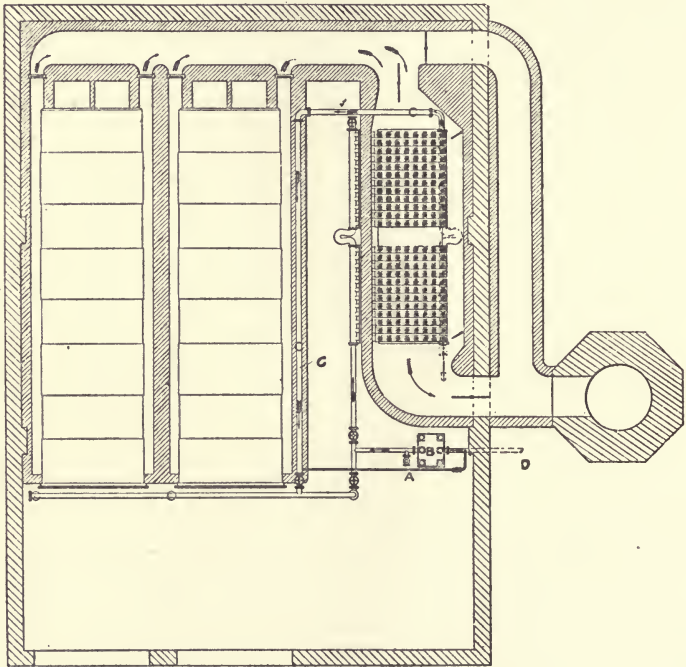

FIG. 70. GREEN'S ECONOMIZER, SHOWING PARTIAL RETURN TO PUMP.

apparatus in series with another adds very little more to the resistance.

Economizers must not be fed with water at less than  $90^{\circ}$  to  $100^{\circ}$  F., since this will cause some of the moisture to condense on the lower boxes and lower sixth or thereabouts of the pipe length. To avoid this effect, which will speedily destroy an economizer, a part of the discharged hot water is returned by a small pipe to the feed pump suction, and serves to heat the feed to  $100^{\circ}$  F. and stop

## FEED HEATING

further condensation. Otherwise the discharge of a condenser will usually be hot enough to serve these ends.

This is seen in Fig. 70, which shows a Green's Economizer and its by-pass flue as arranged in a very usual way with

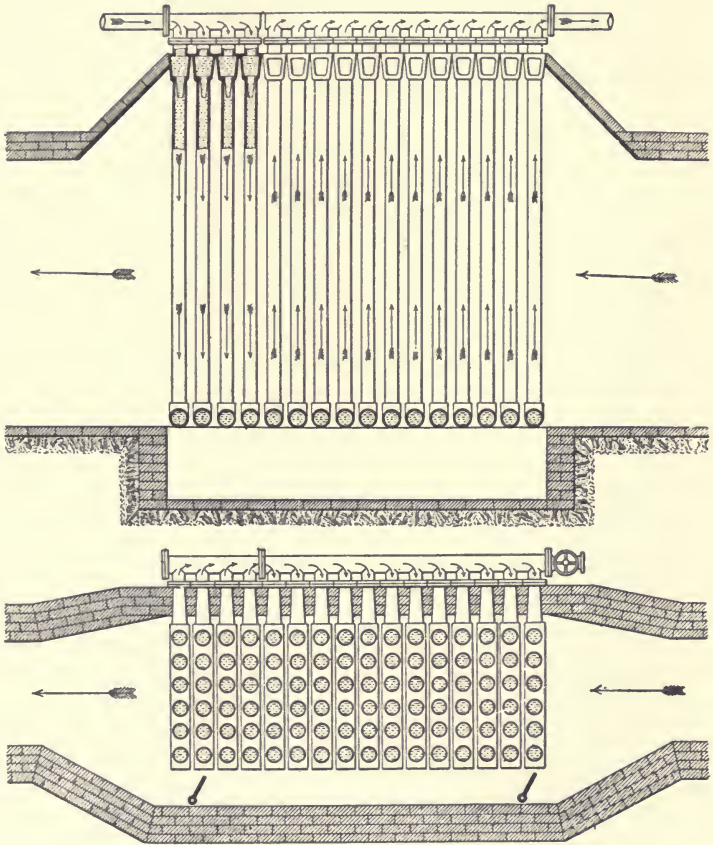

FIG. 71. GREEN'S ECONOMIZER, SHOWING INITIAL WARMING SECTION.

Lancashire boilers. Messrs. Green also employ the method of Fig. 71, which shows a general plan and elevation of the pipes and side or soot doors for inspecting purposes. The four sections of pipes next the chimney are independent of the remainder, being fed with water in their top boxes.

## WATER SOFTENING AND TREATMENT

The course of the water is downwards, and from the bottom boxes it passes to the other pipes in the usual way.

Even if fed with cold water only the four first sections would suffer any corrosion, and in this way the whole of a few pipes may be rusted away instead of a sixth part of all the pipes, which would be as surely useless as if wholly corroded. Only four pipes would be renewed where perhaps twenty-four would otherwise require renewal. It is,

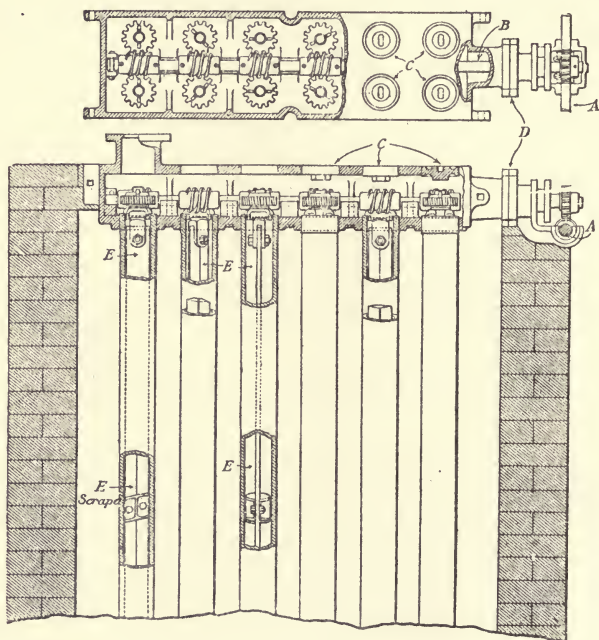

FIG. 72. ECONOMIZER WITH INTERNAL SCRAPERS.

however, a simple matter with cold feed to adopt the method of Fig. 70, and return some of the hot water to the feed pump.

Thus B is the pump drawing its supply by the pipe D and delivering as shown by the arrows to the economizer, whence the heated water travels by the pipe C to the boilers. A small pipe A abstracts a portion of the water from C and redelivers it to the pump section D, by which



## FEED HEATING

means the whole of the feed water is delivered to the economizer at a temperature above 90° or 100° F., the amount of returned water being arranged to give this temperature.

If hard water is used the pipes of an economizer will gradually choke with scale. They are then bored out by a special portable set of multiple boring bars.

In Roberts' economizer (Fig. 72) each tube has an internal revolving scraper in constant rotation to remove scale as rapidly as it is formed. This is shown in Fig. 72. The scrapers are driven by worm wheels with shafts in each top header entering through stuffing boxes. A standard economizer has 10 square feet of surface per pipe, weighs 280 lb. per pipe, and holds 6½ gallons per pipe. Experiment has shown that there is no difference in the efficiency of an economizer whether it be arranged for the pipes to be all in series with each other or all in parallel, but when in series the resistance to flow may be much increased. The following table (XVIII.) shows the approximate saving due to each degree of temperature increase at different temperatures, the differences down the columns arising from the difference of specific heat of water, which is greater at the higher temperatures, and a degree of temperature represents more heat per lb. of water.

In the annexed table (XVIII.) the percentage of saving due to feed heating is shown for a steam pressure of 60 lb.

In general the gases are not to be cooled below 350° F., for the sake of the chimney draught, but there is no limit to the cooling that may be allowed for fan draughts. The economy of feed heating is measured by the ratio of the heat added to the feed-water, and the total heat in the steam above initial feed water temperature.

Thus the total heat in a pound of steam will be about 1,100 B.Th.U., and if 140° F. of temperature is added to the feed, this is very nearly equal to 140 B.Th.U. Then

$$\frac{1,100 - 140}{1,100} = \frac{96}{110} = 0.873, \text{ showing an economy of } 100 - 87.3 = 12.7 \text{ per cent.}$$

The following table (XIX.) is calculated on this basis for a pressure of 60 lb.

TABLE XVIII.

PERCENTAGE OF SAVING FOR EACH DEGREE OF INCREASE IN TEMPERATURE OF FEED WATER HEATED.  
 Pressure of Steam in Boiler, lb. per sq. in. above Atmosphere.

Initial Temp. of Feed.	0	20	40	60	80	100	120	140	160	180	200	Initial Temp.
32°	.0872	.0861	.0855	.0851	.0847	.0844	.0841	.0839	.0837	.0835	.0833	32°
40	.0878	.0867	.0861	.0856	.0853	.0850	.0847	.0845	.0843	.0841	.0839	40
50	.0886	.0875	.0868	.0864	.0860	.0857	.0854	.0852	.0850	.0848	.0846	50
60	.0894	.0883	.0876	.0872	.0867	.0864	.0862	.0859	.0856	.0855	.0853	60
70	.0902	.0890	.0884	.0879	.0875	.0872	.0869	.0867	.0864	.0862	.0860	70
80	.0910	.0898	.0891	.0887	.0883	.0879	.0877	.0874	.0772	.0870	.0868	80
90	.0919	.0907	.0900	.0895	.0888	.0887	.0884	.0883	.0879	.0877	.0875	90
100	.0927	.0915	.0908	.0903	.0899	.0895	.0892	.0890	.0887	.0885	.0883	100
110	.0936	.0923	.0916	.0911	.0907	.0903	.0900	.0898	.0895	.0893	.0891	110
120	.0945	.0932	.0925	.0919	.0915	.0911	.0908	.0906	.0903	.0901	.0899	120
130	.0954	.0941	.0934	.0928	.0924	.0920	.0917	.0914	.0912	.0909	.0907	130
140	.0963	.0950	.0943	.0937	.0932	.0929	.0925	.0923	.0920	.0918	.0916	140
150	.0973	.0959	.0951	.0946	.0941	.0937	.0934	.0931	.0929	.0926	.0924	150
160	.0982	.0968	.0961	.0955	.0950	.0946	.0943	.0940	.0937	.0935	.0933	160
170	.0992	.0978	.0970	.0964	.0959	.0955	.0952	.0949	.0946	.0944	.0941	170
180	.1002	.0988	.0981	.0973	.0969	.0965	.0961	.0958	.0955	.0953	.0951	180
190	.1012	.0998	.0989	.0983	.0978	.0974	.0971	.0968	.0964	.0962	.0960	190
200	.1022	.1008	.0999	.0993	.0988	.0984	.0980	.0977	.0974	.0972	.0969	200
210	.1033	.1018	.1009	.1003	.0998	.0994	.0990	.0987	.0984	.0981	.0979	210
220	.1039	.1029	.1019	.1013	.1008	.1004	.1000	.0997	.0994	.0991	.0989	220
230	.1049	.1039	.1031	.1024	.1018	.1012	.1010	.1007	.1003	.1001	.0999	230
240	.1050	.1041	.1041	.1034	.1029	.1024	.1020	.1017	.1014	.1011	.1009	240
250	.1062	.1052	.1052	.1045	.1040	.1035	.1031	.1027	.1025	.1022	.1019	250

TABLE XIX.  
 PERCENTAGE OF SAVING FUEL BY HEATING FEED WATER.  
 Steam at 60 lb.

Final Temperature.	INITIAL TEMPERATURE OF WATER.												
	32°	40°	50°	60°	70°	80°	90°	100°	120°	140°	160°	180°	200°
60	2.39	1.71	0.86	0									
80	4.09	3.43	2.59	1.74	0.88	0							
100	5.79	5.14	4.32	3.49	2.64	1.77	0.90	0					
120	7.50	6.85	6.05	5.23	4.40	3.55	2.68	1.80	0				
140	9.20	8.57	7.77	6.97	6.15	5.32	4.47	3.61	1.84	0			
160	10.90	10.28	9.50	8.72	7.91	7.09	6.26	5.42	3.67	1.87	0		
180	12.60	12.00	11.23	10.46	9.68	8.87	8.06	7.23	5.52	3.75	1.91	0	
200	14.30	13.71	13.00	12.20	11.43	10.65	9.85	9.03	7.36	5.62	3.82	1.96	0
220	16.00	15.42	14.70	14.00	13.19	12.33	11.64	10.84	9.20	7.50	5.73	3.93	1.98
240	17.79	17.13	16.42	15.69	14.96	14.20	13.43	12.65	11.05	9.37	7.64	5.90	3.97
260	19.40	18.85	18.15	17.44	16.71	15.97	15.22	14.45	11.88	11.24	9.56	7.86	5.96
280	21.10	20.56	19.87	19.18	18.47	17.75	17.01	16.26	14.72	13.02	11.40	9.73	7.94
300	22.88	22.27	21.61	20.92	20.23	19.52	18.81	18.07	16.49	14.99	13.37	11.70	9.93

## WATER SOFTENING AND TREATMENT

The following table (XX.) shows figures obtained by the Author and other observers of the performances of economizers :—

TABLE XX.

No. of Pipes per Boiler.	Gas Temperature.			Water Temperature			Total Number of Pipes.
	Inlet.	Outlet.	Fall.	Inlet.	Outlet.	Rise.	
32	600	480	120	96	240	144	64
80	580	290	290	98	215	117	320
72	630	520	110	93	217	124	144
75	640	460	180	90	225	135	224
52	570	388	182	107	170	63	208
72	560	360	200	54	204	150	72
Average of a large number of economizers, including those above :—							
	557	381	176	93	202	109	

The maximum recorded rise of feed temperature noted in one year's inspections of economizers by the Manchester Steam Users' Association, was 187° F., but higher figures are no doubt often obtained where boilers are more severely worked.

Mr. M. Longridge has shown that the weight of feed water per hour multiplied by the temperature rise and divided by the square feet of economizer area, gave an average rate of heat transmission of 876 to 1,095 B.Th.U. per square foot per hour, whence he deduced that with an economizer surface equal to the boiler heating surface an average heat transmission of 1,000 to 1,300 B.Th.U. per hour per square foot may be looked for when  $\frac{3}{4}$  to 1 lb. of coal per hour is burned per square foot of boiler heating surface.

The following table (XXI.) shows the general dimensions of the chamber space of economizers 6 to 10 pipes in width and up to 48 sections in length. The chamber below the bottom boxes should be 30 to 36 inches deep for soot and dust accumulation. One side of the economizer chamber



## FEED HEATING

is made with a passage for the inspector. This passage must be closed at each end by deflectors or dampers, to prevent short circuit of the draught. No scrapers are needed if combustion is perfect, but ordinary furnaces produce much smoke, and soot rapidly settles on the pipes, and these sometimes become covered with a tenacious sticky tarry deposit. This can only be removed by burning off. To do this the economizer is run dry and the hot gases are passed through for several hours. This operation requires very careful carrying out, or the economizer may be overheated or injured. As with boilers, the dampers of an economizer are best of swivel type, thus preventing the large air leakage through the slot of slide dampers.

TABLE XXI.  
ECONOMIZER CHAMBER SPACE.

		<i>Width of Chamber.</i>		
For 4 pipes	. . . . .	3 ft. 4 in.		} If with side Deflectors, add 9 inches.
„ 6 „	. . . . .	4 „ 8 „		
„ 8 „	. . . . .	6 „ 0 „		
„ 10 „	. . . . .	7 „ 4 „		

*Lengths.*

No. of Sections or Rows	8	12	16	20	24
Length of Economizer .	ft. in. 4 10	ft. in. 7 3	ft. in. 9 8	ft. in. 12 1	ft. in. 14 6
No. of Sections or Rows	28	32	36	40	48
Length of Economizer .	ft. in. 16 11	ft. in. 19 4	ft. in. 21 9	ft. in. 24 2	ft. in. 29 0

The presence of hard water in an economizer prevents the use of pipes other than straight in length or circular in section. No other pipes are rationally practicable. The rate of flow of water through the pipes only averages in usual conditions  $\frac{1}{4}$  inch per minute. When driven by electric motor, this should be enclosed. It is best to drive through a steel worm and phosphor bronze wheel in an oil bath. The speed of the shaft supplied with the economizer is intended to be 55 per minute.

# WATER SOFTENING AND TREATMENT

## The Pure Water Economizer.

In order to surmount the scale difficulty, it has been proposed to supply pure soft water to a closed cycle

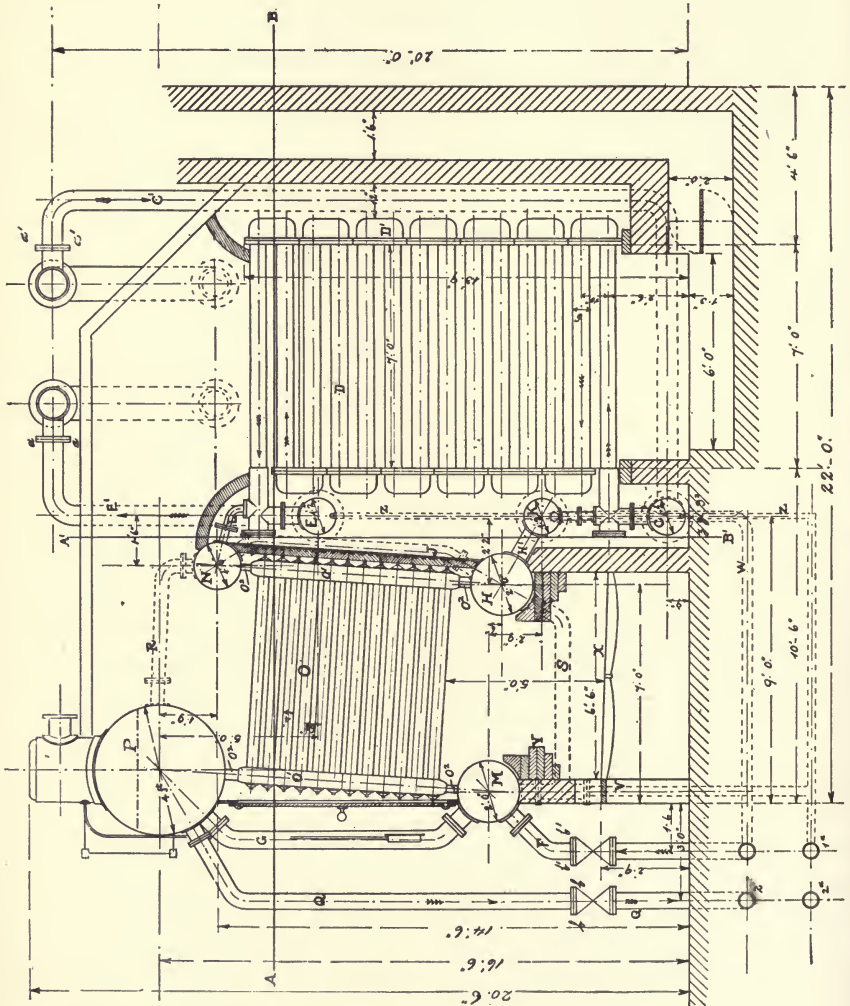

FIG. 73. ELEVATION.

economizer, the water being kept in movement by a pump and passed through a counter-current cooler, which is a

## FEED HEATING

heater to the real feed. Thus water-heated, the feed water will deposit its lime salts in a soft condition, and the economizer will always be free from scale and at full efficiency.

### Fully Heated Feed Water.

Within recent years the advantages of fully heated feed have been better recognized, and in connexion with the Cruse system of superheat control a system of feed heating to boiler temperature has been evolved.

In the Cruse flue-fired superheaters, for example, the feed water together with water from the boiler itself is circulated through a copper tube, which is carried in series through the tubes of the superheater placed behind a Lancashire boiler.

When the superheater is of the sepa-

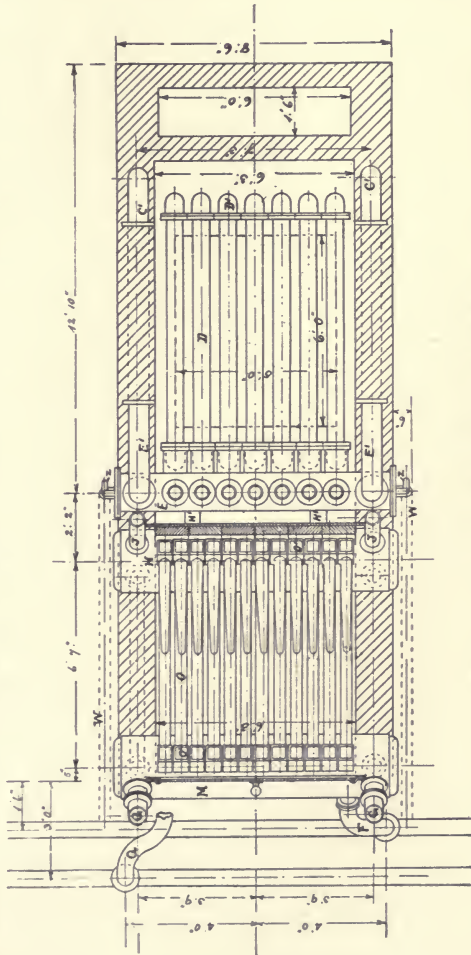

LONGITUDINAL SECTION AT A-B.  
 INDEPENDENTLY FIRED CONTROLLABLE SUPERHEATER WITH CIRCULATION FOR FULLY HEATED FEED WATER (Cruse).

## WATER SOFTENING AND TREATMENT

rately fired order (Figs. 73, 74, 75) the same through controlling pipe of hot water is employed, but the water does not come in this case from the boiler, but from the drums of a feed heater which is placed between the furnace and the superheater tubes to temper the excessive heat of the

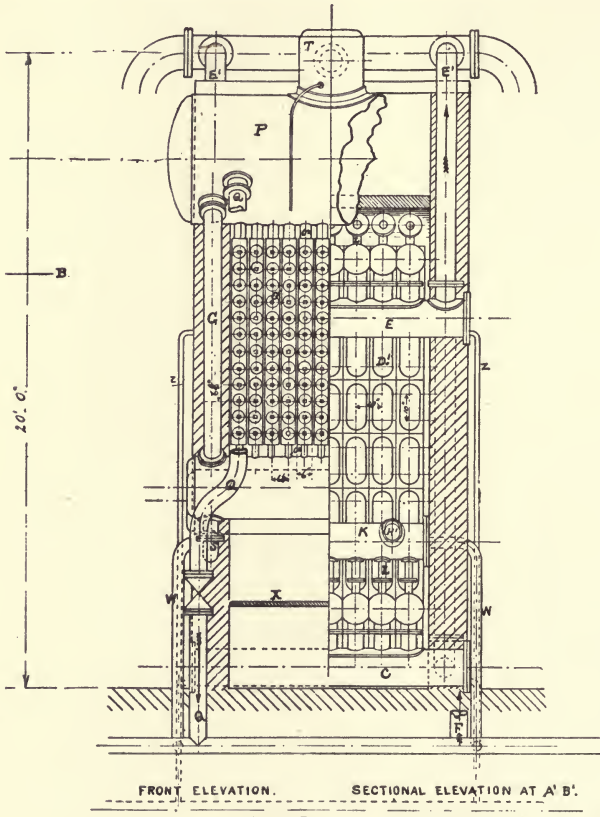

FIG. 75. CROSS SECTION AND END VIEW.

furnace gases to a safe temperature for the superheater tubes. The fresh feed in this case is also mixed with the circulating water. In this way the water already hot is heated fully to boiler temperature, and it is found that very much larger boiler output can be secured. The propelling agent which keeps the water in movement through



## FEED HEATING

the tubes is superheated steam, which when it comes into contact with the water becomes at once saturated only, and, shrinking in bulk, gives a work effect as a result of the condensation of volume.

### Stage Heating.

Correctly and best to utilize practical conditions, the generation of steam must, like its use, be conducted in stages. Thus feed water is first heated by the exhaust steam from an engine either at atmospheric pressure or in a condenser at a lower temperature. Next it acquires further heat from the waste gases, and finally in the case of the Cruse superheater it is heated fully up to the temperature of the boiler in the process of regulating the superheat of the steam.

Even where this stage is not present it is well to heat the feed by steam from the boiler, so that the full temperature of the boiler may be attained by the water before this is passed into the boiler.

The advantage of this was first claimed by M. Normand, a French engineer. He claims an economy of 10 to 15 per cent. as the result of using steam from a boiler to heat the water going into that boiler.

It is not as a rule worth while, when making steam engineering calculations, to take into consideration the variation of specific heat. One pound of water raised through  $1^{\circ}$  F. represents very closely 1 thermal unit = 1 B.Th.U., and 1 kilogramme heated  $1^{\circ}$  C. is closely equal to 1 calorie = 1 cal. But for those who wish a closer figure the table XXII. of Regnault's values of the specific heat of water will be useful. Rowland considers water to have a specific heat = 1 at  $15^{\circ}$  C. below which temperature it rises and attains to 1.0056 at  $5^{\circ}$  C., and falls to a minimum of 0.9956 at  $29^{\circ}$  C., when it rises slowly again above that temperature. Bartoli, and also Ludin, assume unity at  $15^{\circ}$  C., and show a rise at lower temperatures, a minimum of 0.9993 and 0.9988 at  $22^{\circ}$  C. and  $29^{\circ}$  C. respectively. Mr. James Weir has heated feed water in the apparatus (Fig. 76) by means of steam

## WATER SOFTENING AND TREATMENT

taken from the intermediate receiver of a compound engine after the steam has done some work in the h.p. cylinder. Mr. Weir aimed not merely at economy, but also at the thorough elimination of gases from the water. These gases are what produce corrosion in boilers. In the Weir heater they are drawn off at the top of the apparatus. Gases freshly occluded from water appear to have a peculiar effect in corrosion, owing probably to an active condition due to their nascent condition in the atomic form before molecular

cohesion has taken place. Only by gas elimination can thin tube boilers be maintained sound at sea.

In Fig. 76 the Weir heater is shown to have a float which regulates the supply pump by means of a throttle valve, thus supplying water as the boiler feed pump draws off the store.

The cold water enters as a spray, and meets the steam entering round the perforated casing. Auxiliary engines at sea may supply the steam, and the temperature of feed

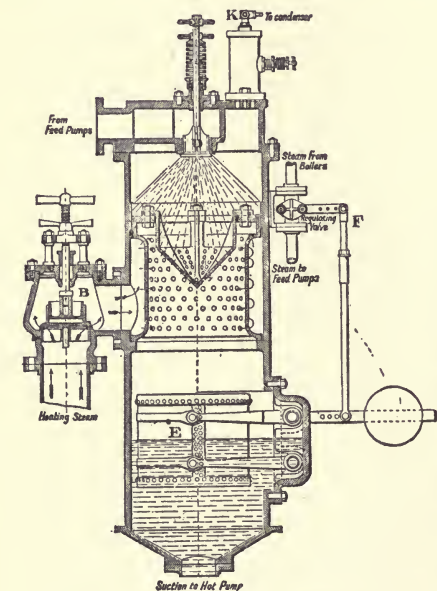

FIG. 76. WEIR FEED HEATER.

may be 212° F. in a closed heater. Thus, in an example cited where steam was taken from the receiver at a gauge pressure of 16.7 lb., the temperature being 218° F., water taken at 100° F. from the hot well was raised to 218° F. Since steam at the receiver pressure contains 1,080 B.Th.U., measured from 100° F., and the water acquires 118° of temperature, this represents nearly 11 per cent. of the total available heat of the steam. Thus the first cylinder of an engine is improved in efficiency, or the first two cylinders

## FEED HEATING

if there is a third, for they have taken work out of the steam. Where there is no waste gas heater, there can be no question as to the economy of the Weir system, apart from its benefit in respect of corrosion.

If auxiliary plant were always near to the main engines, and only required to run when these run, it is probable that greater economy would be secured by using in them throttled receiver steam and coupling them up to the main condenser. But they are often too far away for this, and must use boiler steam, in which case their exhausts can often be used in tubular feed heaters. Very much in the way of feed heating cannot be done by exhaust steam on its way to the condenser, simply because it so rapidly acquires condenser temperature. Only about  $100^{\circ}$  to  $120^{\circ}$  F. can be secured, whereas, as already seen, upwards of  $218^{\circ}$  F. has been acquired by feed water heated from the receiver. In most cases the engineer will find he has more heat than he can utilize. There are both waste steam and waste gas, and it is of no use employing boiler steam to heat the feed water until after the economizer, if present, has done all that is possible.

### Surface or Tubular Feed Heaters.

These, of course, find their principal employment where non-condensing engines are at work. They all consist of tubes variously arranged and exposed on the inner surfaces to exhaust steam or vice versâ, or, when necessary, to boiler steam more or less throttled if so required.

In the Row heater (Fig. 77) the tubes are indented as though rolled two ways through a cogged roller. The obstructed irregular passage through the tubes compels turbulent movement of the water, and it is claimed that in a test with steam at 62 lb. pressure, a Row tube raised 11 gallons of water to  $212^{\circ}$  F. in  $5\frac{1}{2}$  minutes, whereas a similar but plain tube required twice that time. Similarly  $2\frac{1}{2}$  gallons were evaporated in  $11\frac{3}{4}$  and 24 minutes respectively. Apparently the indented surface is doubly as efficient as plain surface.

## WATER SOFTENING AND TREATMENT

This form of tube is also advocated for condenser purposes and for cooling surface likewise.

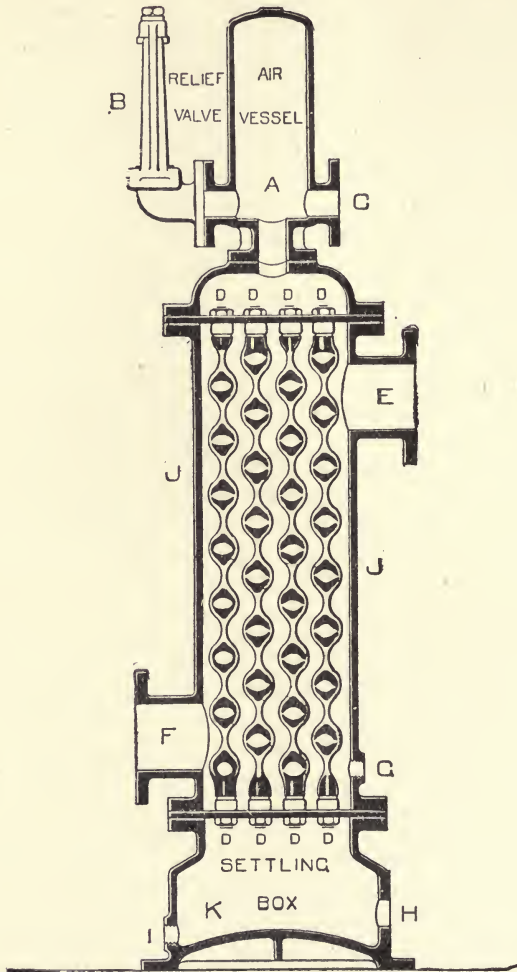

FIG. 77. ROW FEED HEATER.

### The Berryman Heater.

This heater (Fig. 78) is a long-established form of heater with inverted  $\cup$  tubes of various lengths suitably expanded



## FEED HEATING

into a double chamber base. Steam passes through the tubes and water rises from below and is taken off below the scum and air trap, which should have an escape or blow-off tap. The tubes are free to expand without stress, and the crown can be taken off and the tubes cleared of scale. The heating power of exhaust steam is very great. One pound contains 967 B.Th.U. above 212° F., so that it will heat to 212° F. 6 lb. of water supplied at 51° F. Obviously, therefore, a non-condensing engine will heat the feed of many times its own power of engines to 212° under ordinary conditions, and a wasteful direct steam pump will heat feed water for quite large main engines from the usual hot well temperature to a good high-feed temperature.

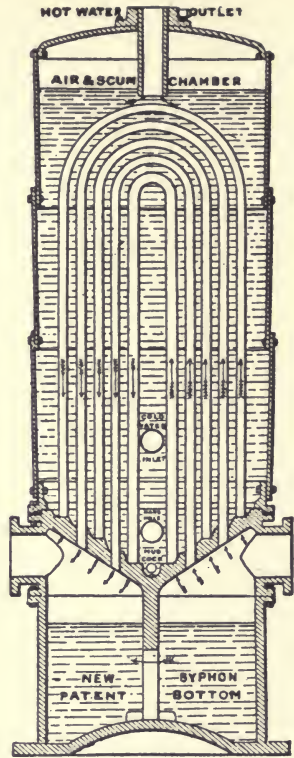

FIG. 78. BERRYMAN HEATER.

TABLE XXII.  
SPECIFIC HEAT OF WATER (REGNAULT).

Temp.	Sp. Heat.	Temp.	Sp. Heat.
0°C = 32°F	1.0000	110°C = 230°F	1.0153
10° = 50°	1.0005	120° = 248°	1.0177
20° = 68°	1.0012	130° = 266°	1.0204
30° = 86°	1.0020	140° = 284°	1.0232
40° = 104°	1.0030	150° = 302°	1.0262
50° = 122°	1.0042	160° = 320°	1.0294
60° = 140°	1.0056	170° = 338°	1.0328
70° = 158°	1.0072	180° = 356°	1.0364
80° = 176°	1.0098	190° = 374°	1.0401
90° = 194°	1.0109	200° = 392°	1.0440
100° = 212°	1.0130		

## WATER SOFTENING AND TREATMENT

The specific heat of water is taken as 1.00 at 0° C. = 32° F. The table XXII. gives Regnault's figures, which are probably not far wrong. Some observers, however, give figures less than unity above 0° C. In either case the variation in the specific heat is of no consequence to the engineer.

Similarly water does not vary very much in bulk with variation of temperature, as shown by the following table (XXIII.) of weight per cubic foot in lb.

TABLE XXIII.  
EXPANSION OF WATER.

Temp.	Weight.	Temp.	Weight.	Temp.	Weight.
212°F	59.71	350°F	55.52	500°F	49.61
250°	58.81	400°	53.64	500°	47.52
300°	57.26	450	50.66	62°	62.2786
102°	62.00	158°	61.00	203°	60.00

Up to boiling point in the open air, therefore, the expansion is under 5 per cent. of the bulk at 62° F.

The maximum density of water is at 4° C. = 39.1° F. To melt 1 lb. of ice at 32° F. to water at 32° F. requires 142 B.Th.U. = 35.78 calories per pound or 78.86 calories per kilogramme. To evaporate 1 lb. of water at 212° F. into steam at 212° F. requires 965.7 B.Th.U.

The imperial gallon of pure distilled water at 62° F. weighs 10 lb. by law, and measures 277.479 cubic inches. The American gallon is the old wine gallon of 8¼ lb., and measures 231 cubic inches. It is important to remember this, for on one occasion known to the Author a smart American salesman sold locomotives to a colonial Government on the strength of the greater capacity of their tender tanks, whereas the rival English engines were of considerably greater capacity.

### Tray Feed Heaters.

Under the head of "Water Softening," reference has already been made to the Chevalet-Boby heater detartarizer.

## FEED HEATING

Similar effects in softening are obtained by allowing the feed water to enter a boiler by way of a number of shallow overflow trays. By this means feed heating and scale deposit are effected in the trays, and this is better than direct flow of cold water into a boiler. The trays catch the lime salts as they are caused to separate by heat and adhere to them. The trays should be in duplicate and easily removable. As soon as removed, and while still wet and soft, the scale can be easily knocked off. To throw down sulphate of lime a little carbonate of soda is used in the feed.

The Cochrane heater is also a combination heater and purifier, steam from an engine entering through an oil separator and passing upwards between the trays, over which the water is trickled. The heated water passes through a coke filter below, and this arrests the last of the deposit. It is claimed for all these various purifier heaters that the oil not removed by the mechanical separator is absorbed by the scale deposit which adheres to the trays.

Needless to say, these contact heaters are far more efficient per unit of space occupied than are surface heaters.

## CHAPTER XXV

### THE PRACTICAL APPLICATION OF STAGE HEATING IN THE GENERATION OF STEAM

**I**N order more fully to illustrate what the Author considers to be the correct principles of steam engineering and the particular relation of the feed-heating stages to the general scheme of the heating of the working fluid of the steam engine, he has selected the accompanying illustrations of the "Cruse" or "Quad" boiler because they show as much as it is possible in one combined apparatus each stage into which practical considerations make it economically necessary to divide the whole operation of steam making.

The illustrations represent a "Cruse" straight-tube three drums boiler, combined with a double-tube economizer, a feed reheater and purifier, and a controllable superheater.

The feed water, already heated to 90° F. or 100° F., whether because it comes from a surface condenser, or has been heated by an injector, is passed into the inter-circulating double-tube economizer, which is placed in the path of the waste gases from the boiler. The practical necessity of feeding an economizer with warmed water has been explained when dealing with economizers. In this economizer the water acquires what heat it can obtain from the nominally waste gases; it is fed into the bottom and rises from the top box to the upper side of the feed-reheating drums, which it enters through the inlet valve and falls in jets or in broken sheets from a perforated pipe upon the series of perforated plates forming a shed, the perforations being in the vertical parts of the plates. Inside the space enclosed by these plates, steam is admitted from the boiler to act upon the broken sheets, or the spray of falling water, and



## PRACTICAL APPLICATION OF STAGE HEATING

the feed water is thus raised to the full temperature of the boiler. The steam space in this feed-heater drum is in free communication with the steam space of the drums of the boiler, and is, therefore, continuously supplied with all the steam necessary to make up that which disappears by the condensation resulting from contact with the feed water; the water space of this drum is likewise in open communication with the water space of the drums of the boiler, and thus the boiler proper, being fed with water at the full temperature of the working pressure, is free to perform only its proper duty of evaporation.

The saturated steam generated in the boiler passes from the steam and water drums into the two saturated steam domes, whence it is led to the 15-inch collector, from which it is distributed to the various sections of the superheater. This superheater should theoretically be next to the furnace, but the limited endurance of steel compels here a departure from mere theory, and the superheater tubes are therefore placed behind the first bank of the heating tubes in a zone of temperature which they can endure. This superheater internally is fitted with water-control tubes, through which a stream of water is propelled by a superheated steam inspirator. The water is drawn from the front drum of the boiler and delivered through the control tubes to the back drum, acquiring heat on its way from the heating gases and through the steam which is being superheated. This control system not only governs the temperature of superheat within a narrow range, but serves to protect the superheater tubes also, and this more especially when steam ceases to be drawn through the superheater for power, for then the flowing water continues to absorb and carry off heat, abstracting it from and through the superheating tube shells, while it also compels some steam to flow through the superheater tubes and uses this flow to maintain its own active circulation, the two effects combining to avert overheating of the superheater tube metals.

By the combination of the four distinct sections or elements which go to make up this "Quadriennial" boiler, the stage production of steam is carried out as nearly upon

## WATER SOFTENING AND TREATMENT

correctly scientific lines as practical considerations enable it to be done ; that is to say, the furnace heat at maximum temperature is applied to the working fluid at maximum temperature, and this maximum temperature is first acquired by the water as far as possible from heat that would otherwise be wasted.

Large downcomer pipes, external to the boiler casing, ensure perfect and regular circulation, and large equalizer pipes, also external to the boiler casing, maintain the water level of the two drums equal throughout.

Any section of the superheater can be cut out and its four connexions blank flanged ; if necessary, the whole superheater can be lifted out between the top saturated steam domes and, the four main connexions having been blank flanged, the boiler can be worked without the superheater.

The boiler as illustrated is the first complete and self-contained combination of apparatus for the production and superheating of steam on the lines of stage heating recognized as correct, each stage taking place in a separate vessel. This boiler therefore represents the most perfect practice in steam generation hitherto evolved. The only departures from strict theory are in such points as the limitation of the capacity of endurance of materials renders necessary.

A notable feature in the boiler proper is that all the downward circulation of the water takes place in large downcomer pipes outside the external casing and the upward circulation takes place entirely by the small heated tubes which are all at right angles to the furnace and face the direction of flow of the gases from the furnace.

The following is abstracted from Mr. Cruse's own account of the combination patented by him and embracing the four main stages of steam generation in one seating or enclosed space.

The "Quad" superheated steam generator combines in one compact enclosure the four integrants of the process of steam generation.

# PRACTICAL APPLICATION OF STAGE HEATING

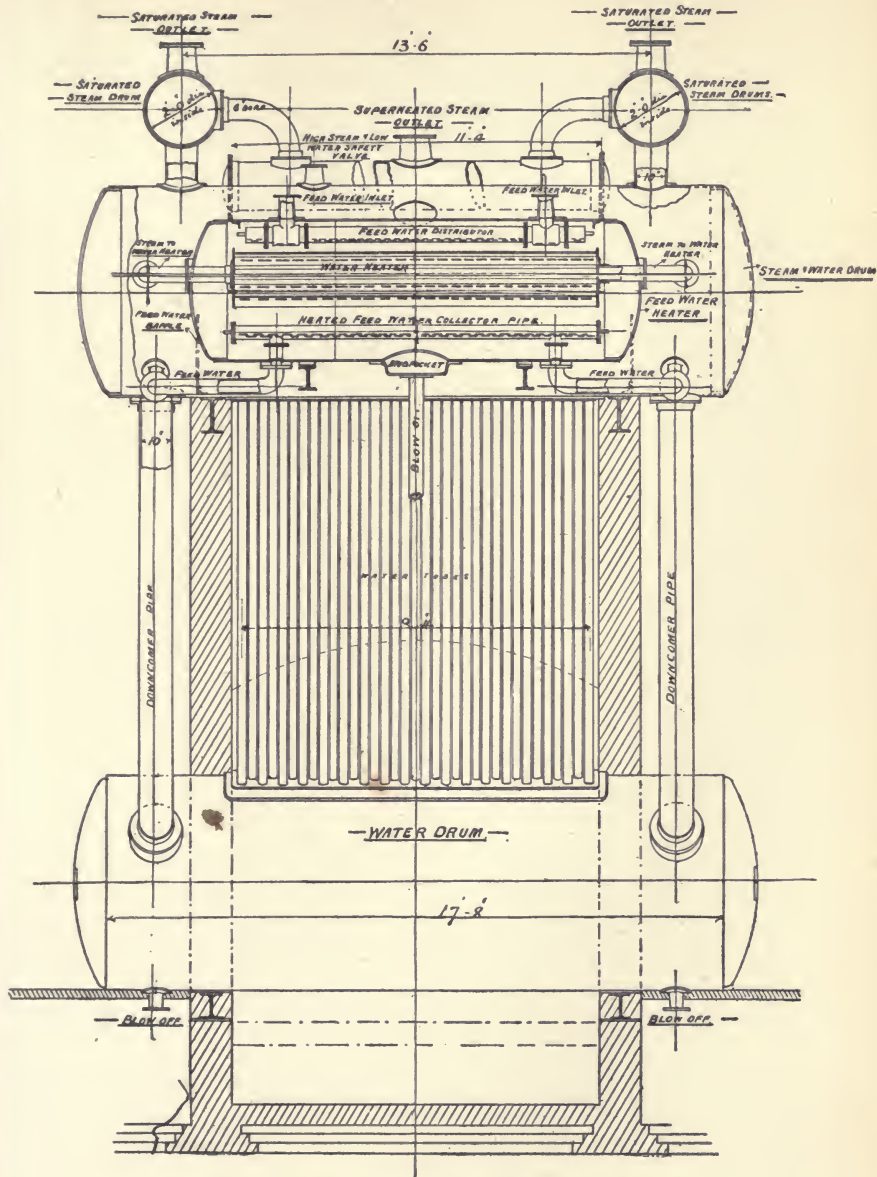

FIG. 79. CROSS SECTION (Enlarged Scale).

## WATER SOFTENING AND TREATMENT

1. An inter-circulating tubular feed-water heater or "Economizer."
2. A cylindrical steam-heated feed-water re-heater and purifier or "Hypertherm."
3. A vertical straight tube boiler or "Evaporator."
4. A water-tube-controlled steam superheater.

These units form the four progressive stages into which practical steam raising is divided, and each unit works independently of, although correlatively with, the others.

The "Economizer" is constructed of seamless steel tubes, each containing a smaller internal tube, open top and bottom; this allows of a rapid and constant internal circulation in each tube, combined with the general forward movement of the mass. The tube plates and dishes forming the top and bottom boxes are of wrought steel. The inter-circulating action adds to the efficiency of this class of apparatus and minimizes corrosion. The feed from the condensers is fed into the bottom boxes, and leaves the top boxes much raised in temperature and travels to the re-heater drum above.

The re-heater or "Hypertherm" is a rivetted steel drum, provided with a cast-iron perforated water-distributor pipe and shed in the steam space, and with a perforated water-collector pipe in the water space. It has a large mud pocket and blow-off pipe, and steel steam-inlet blocks and pipes and steel water-outlet blocks and pipes, connecting it respectively to the steam and water spaces of the boiler drums. The feed water from the economizer enters through the valve at top at economizer temperature, and leaves for the boiler drum by the pipes at bottom at boiler-pressure temperature.

The boiler proper or "Evaporator" is composed of two top, or steam and water, drums and one large, or two small, bottom water drums. The drums are interconnected by small seamless steel heating tubes and by large seamless steel downcomer and equalizer pipes. The large downcomer and water-level equalizer pipes are all outside the boiler casing, and are connected to the drums by rivetted blocks. The small heating tubes are straight and are simply





## WATER SOFTENING AND TREATMENT

drum shell, but the corresponding holes in the drum shell are bored to a larger diameter to allow the tube ends to be bell-mouthed over the counter-sunk shoulder formed on the butt strap. These tube plates are exceptionally strong, and in addition to permitting the use of straight tubes entering non-radial to the drum, without the necessity of departing from the cylindrical form of the shell, they strengthen the shell plate at its weakest section, i.e. where it is drilled for the admission of the tube ends.

The top drums are, for water-tube boilers, exceptionally large; the containing capacity of the combined steam spaces equals, approximately, 600 cubic feet; while the water spaces, from working level to above the line of the tube ends, give a water-storage capacity equal to one and a half hour's evaporative duty—30,000 lb.

The top drums are surmounted by two longitudinal rivetted steam drums or domes, with safety valves and outlet branches to the superheater collector; the steam is drawn at mid height of the domes, and thus an ample steam-separating or anti-priming chamber is formed, the entrained water being allowed to fall and return to the main drums.

The superheater is a form of the Cruse controllable type, and is made up of a number of elements assembled fore and aft by means of the saturated or inlet steam collector and the superheated or outlet steam collector pipes. The control water system is connected to the front drum by the front-water collector and, through each element, by the back-water collector to the back drum. The control, or government of the temperature of superheat, is maintained and adjusted by means of the superheated steam inspirators at each end of the front-water collector. This water-tube controlling system may also be connected to the feed-heater drum, to the economizer, or direct to the condenser. The front or superheated steam collector carries a safety valve and necessary outlet blocks.

This boiler is provided with all necessary safety and stop valves, water-level valves and steam and water-level indicators, pressure gauges, blow-off pipes and cocks, drain

# PRACTICAL APPLICATION OF STAGE HEATING

pipes, etc. ; with stanchions and girders and with ordinary furnace bars, or with special mechanical stokers.

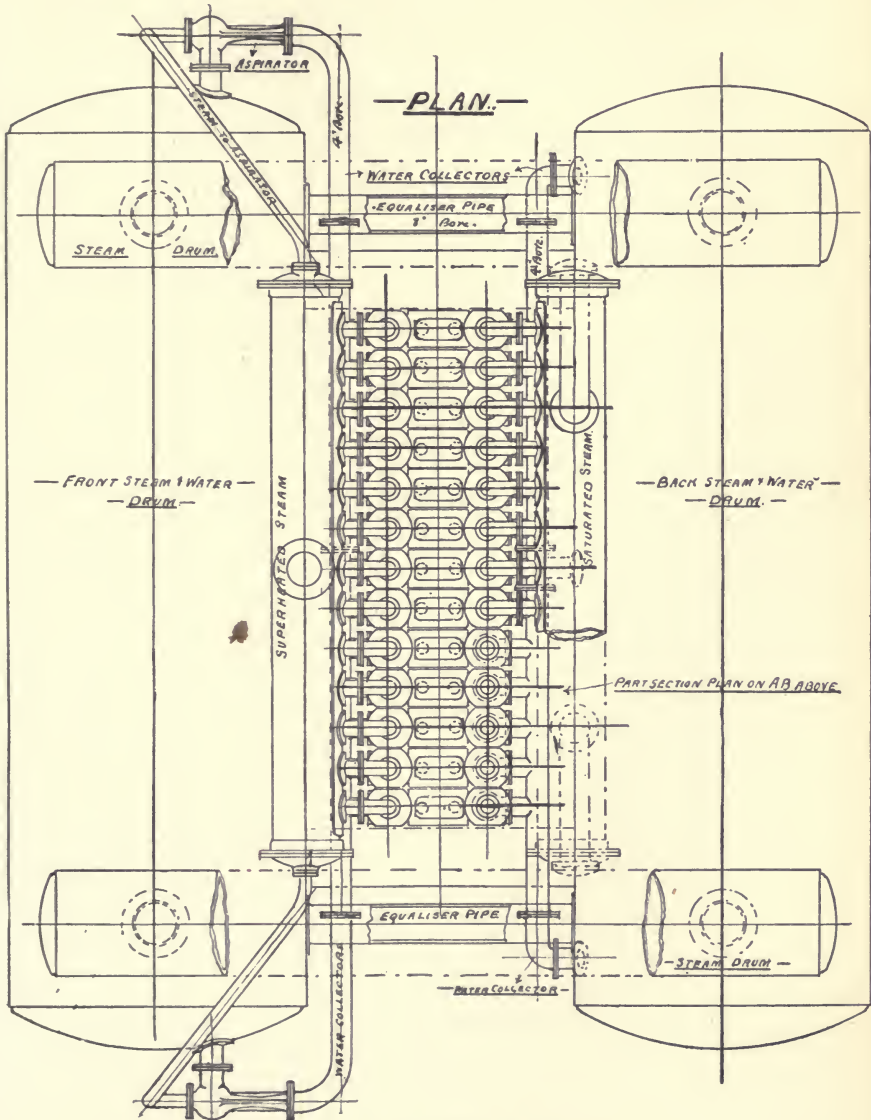

FIG. 81. PLAN (Enlarged Scale).

## WATER SOFTENING AND TREATMENT

The boiler illustrated has an evaporative capacity of 20,000 lb. of water per hour, rated from and at 212° F. ; from feed water at 100° F. into steam at 160 lb. working pressure, superheated 200° F., the fuel being North-Country coal of a calorific value equal to 14,000 B.Th.U. per pound, the guaranteed coal efficiency being 75 per cent.

Ground space covered by this generator :—

Length : from outside furnace mouth to damper at back—22 ft.

Width : over drums—19 ft.

Gangway—3 ft.

Height : 28 ft. from firing floor.

From the foregoing details and the illustrations it will be found that the process of steam manufacture on scientific lines can be carried out with an apparatus constructed within a small space, yet readily accessible. Steam raising is seen to be an operation involving a good deal of judgment in regard to the means to be employed, and no inconsidered compromise between narrow theoretical views and practical conditions. Thus the dictum of theory is that all heat ought to be applied at the top temperature ; but, in the first place, it is not practicable to employ a working fluid so hot as the source of heat ; and, secondly, it is not practical to throw away low-temperature heat. Hence the system of stage heating, as here illustrated, as a scientific compromise of many conflicting elements.



Section IV  
WATER COOLERS



## CHAPTER XXVI

### WATER COOLING

UNLESS a river, or a canal, or a large pond is available for condensing purposes artificial means must be employed to reduce the temperature of condensing water to a point sufficiently low for efficient use in condensing apparatus.

The ordinary methods of cooling are four in number, viz :—

(a) The pond ; (b) the atmospheric evaporative surface ; (c) the tower ; (d) the spray apparatus.

Whatever system of cooling is employed all depend on the principle of rendering heat latent by assisting the evaporation of part of the water to be cooled by means of the absorptive power of air. Each pound of water which is carried off as vapour by a current of air bears with it 966 units of heat in latent form apart from any sensible heat acquired by the air as a result of its contact with the warm water.

In the annexed table (XXIV.) are given some figures relative to the moisture carrying properties of air.

The actual amount of water that it is possible to absorb varies with the amount of dryness of the air, and in misty weather, when most required in many cases, a cooler loses much of its efficiency from this fact.

If it be assumed, as above, that air will carry off 5 per cent. of its weight of moisture, then 100 lb. or 1,300 cubic feet of air should carry off about 5,000 heat units. Fans must be provided to supply 300 cubic feet of air or 23 lb. for each pound of steam, whence the Author's rough rule

TABLE XXIV.

HYGROMETRIC PROPERTY OF AIR.

Temperature . . . . .	100°	90°	80°	70°	60°	50°	40°	30°	20°	10°
Water in 1 cubic foot of saturated air in } grains	19.84	14.85	10.98	8.01	5.77	4.10	2.86	1.97	1.30	0.84
Percentage of water deposited for fall of 10°	25	26	27	28	29	30	31	34	35	34.5

20,000 cubic feet of saturated air at 90° contains 47 lb. of water.  
At 60° the same volume contains 17 lb. only.

The weight of vapour that can be carried off by 100 lb. of dry air is given for various temperatures as below.

Temperature . . . . .	F°	32°	41°	50°	59°	68°	77°	86°	95°	104°	113°	122°	131°	140°
Moisture . . . . .	lb.	.380	.540	.765	1.05	1.45	1.95	2.69	3.63	4.84	6.45	8.56	1.38	15.14



## WATER COOLING

that the weight of air is to be equal to the weight of circulating water under ordinary general conditions.

But it must not be assumed that the air commences dry. Possibly it starts with 2 per cent. of moisture and escapes, say, with 4 per cent. instead of 5 per cent. Then, in place of 23 lb., or say 24 lb. of air per pound of steam, the weight required would be  $24 \times \frac{5}{4} \times \frac{4}{2} = 60$  lb.

As a fact no calculation ought to be based on the amount of circulation water unless it be the general size of the tower. The essential fact is the number of thermal units in the exhaust steam, which may be assumed as 1,000 units per pound and in the long run it is this heat that has to be carried off by the air. If always thermal units alone are considered, it will greatly simplify calculations and place each calculated item of air, cooling water, etc., by itself, independent of the other variables. Practically one might say that the air passed through a cooling tower must carry off half the heat of the coal burned in the furnaces.

After a calculation has been made on the estimated capacity of the plant with a given weight of air, something like 10 per cent. should be allowed as a margin for imperfect saturation of the air and there should be a margin of fan speed available in case of poor conditions. Thus, in round numbers, 25 lb. of air may be provided per pound of feed water and the power to lift this air to the top of the cooler will be double that necessary to lift the water, except that actually the air is expanded and lifted by the heat of the descending water and the fan power provides what is necessary to add to the natural velocity and to overcome the downward tendency induced in the air by the down-flowing water.

For practical purposes, 13 cubic feet of air may be taken as weighing 1 lb. at the ordinary mean temperature in this country.

Only by a counter-current system can the full effect of the hygroscopic quality of air be utilized, but under cooling-tower conditions it should be possible to discharge the cooling air fully saturated at the temperature of the entering water.

## WATER SOFTENING AND TREATMENT

### The Pond.

The essentials of a pond are such a capacity and such an area as will suffice to cool the water to a sufficiently low temperature before the whole mass of water has made a complete circuit of the pond and condenser. Preferably, the pond must be below the condenser so as not to call for too heavy a lift on the air pump if this is part of a jet condenser. With a surface condenser the circulating pump should be part of a closed circuit with the condenser, the indraught and discharge pipes both extending below the water surface, so that the work of the pump is merely frictional. A good jet condenser will lift its own injection water 17 or 20 feet from the pond by the "vacuum" only.

Mr. Barker<sup>1</sup> found that with the most unfavourable conditions of atmosphere and location the cooling of water in a pond may be as low as 190 B.Th.U. per square foot per hour, even with high-surface temperature of the water, but with better exposure and the same atmospheric conditions as many as 290 B.Th.U. will be dissipated. Under favourable conditions the dissipation of heat will reach 600 B.Th.U. per square foot per hour.

Hence it is concluded that a reservoir should have 18 square feet of surface per 10,000 thermal units per hour. Thus, an engine of 1,000 h.p., using 12 lb. of steam per hour per h.p., will reject about  $1,000 \times 12 \times 1,100$  heat units per hour = 13,200,000 units, requiring an area of 23,760 square feet of cooling-pond surface, equivalent to a pond about 50 yards square. Obviously, the area of a pond must be thus calculated from the weight of feed water and not from the engine horse-power, since so much depends on the economy of the engine.

The above is a minimum value. For margin it would be well to allow 2 square feet per 1,000 B.Th.U. to be dispersed.

Nor should the capacity be less than 10 cubic feet for the same 1,000 thermal units. This implies a pond about 5 feet deep, but there is no higher limit of depth so long as the surface is maintained.

<sup>1</sup> *Mins. of Proc. I.C.E.*, vol. cxxxii. pt. 2.

## WATER COOLING

In order that there shall be no short circuit of the hot water, baffle walls are built, round or over and under which the water must travel on its path back again to the condenser.

The temperature of the water has a great effect on the rate of cooling and an increase of mean temperature by 17° F. has been observed to increase the rate of cooling by 41 per cent.

In still air the evaporation being called unity, was found by Dr. Dalton to become 1.28 for a gentle wind and 1.57 for a brisk wind. The water-laden character of the air will affect cooling and a dry though warm air will readily produce a better cooling effect than a cold but moist atmosphere.

Obviously by the law of mixed vapours moisture will rise from a water surface and permeate the space above it to just such proportion as is due to the temperature of the water surface and to the amount by which the air above is wanting in moisture.

Cooling is a double effect of radiation and evaporation or air absorption. The air also abstracts heat by actual conduction. Not much heat is lost through the earth bottom of a pond.

A puddled reservoir, says Mr. Barker, will cost from 1½*d.* to 2*d.* per cubic foot capacity, an average of four costing 1.71*d.* The cost will be less where excavated material is run into banks, for this saves half the excavation and probably three-fourths of the spoil wheeling for an equal capacity.

A reservoir of 19,143 square feet area and a capacity of 127,000 cubic feet cost £920.

Concreted reservoirs cost from 2.2*d.* to 4.2*d.*, or an average of 3.2*d.* per cubic foot.

The cheapest pond is, of course, that dug entirely in clay and banked with the excavated material. The bank should preferably be pitched with stone pitching on edge or brick on edge, and the top and outer slope grass sown.

The capacity of the bank should be calculated exactly to absorb the material excavated.

The inner slope should be flat—about two to one. The

## WATER SOFTENING AND TREATMENT

top of the bank need not be wider than necessary for a path and the sodded outer slope may be one in one for so unimportant a pond as a shallow reservoir, especially where half dug out of the solid.

### The Atmospheric Evaporator.

Next to the pond comes the atmospheric evaporator. Primitive examples of these have existed for a long time in the shape of stacks of branches over which the water to be cooled was discharged and cooled by the wind before entering a perhaps too small pond. Similarly it is customary to compel the hot water to make a circuit of the pond in shallow wooden troughs before it re-enters the pond. The rapid rippling assists cooling.

The modern evaporative cooler is built up of clusters of thin pine boards, nailed vertically and suspended from cross-pieces and fed on their upper edges from a system of troughs, which again took the drippings from an upper set of vertical boards similarly suspended but turned 90° in plan from those below, so as to give an equal exposure on the average to every wind. Each of the sets of boards is about 9 feet in height, the total height of an apparatus being about 25 feet above the surface of the collecting tank below. With ample surface the water may be cooled below the temperature of the passing air. An outside open wall of louvre boards is sometimes arranged to prevent spray being blown away. The ground space for such an apparatus capable of cooling 30,000 gallons per hour is 1,200 square feet and a height of 13 feet would be sufficient.

Mr. Koppel allows an area of 208 feet for 2,000 gallons, 738 feet for 20,000 gallons and 2,520 feet for 100,000 gallons per hour, but in his apparatus the drizzling boards are horizontal.

### Tower Coolers.

The next development of artificial cooling is the tower, built to act as an up-cast chimney around the foregoing apparatus.



## WATER COOLING

The chimney effect depends on temperature, and is thus more efficient as temperature rises and needs better cooling. The closed-in wooden tower above the cooling stacks in Fig. 82 provides the chimney effect and the capacity is stated to be 2,000 gallons per hour cooled above a floor space 8 feet  $\times$  8 feet, with a total height of 46 feet.

It should be remembered in regard to cooling towers that though their object is to cool water, the immediate object to be aimed at is the saturation of air with moisture, so that the aim should be to split up the air in its passage and introduce it to the maximum area of wet surface. Obviously cooling can only occur where sufficient weight of air is provided to carry off heat, and the hotter the air is made the more heat it will carry off. Hence the propriety of the air leaving at the entry of the water, so as to attain a maximum temperature and absorb a maximum of moisture.

In the tower of Doherty & Donat of Manchester, wooden-inclined horizontally laid battens are employed, the water dripping from layer to layer of these through the up-current of air. Tests made at Birkenhead with this tower showed a vacuum of 26.9 inches, and cooling from 95.6° F. to 66.6° F. The air which passed through attained a humidity of 92.6 per cent. of saturation, the air having an initial temperature of 44.7°.

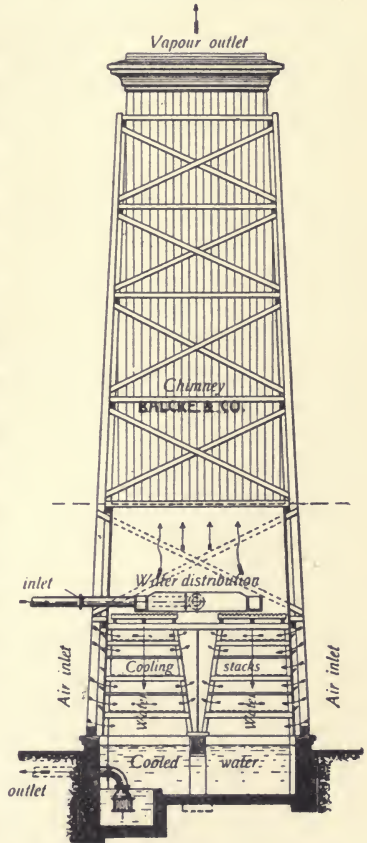

FIG. 82. CHIMNEY COOLING TOWER.

## WATER SOFTENING AND TREATMENT

Generally any construction of tower can be obtained, either fan-cooled or chimney-cooled.

In the chimney cooler, as shown in Fig. 82, the hotter the water the greater will be the up-draught, and so far a sort of automatic regulation is provided, but since the draught depends on difference of temperature, the cooling effect cannot be so great as in an open apparatus freely exposed to a horizontal breeze. Nevertheless, the tower is more generally good for all conditions.

The dimensions of these towers for four capacities are as follows :—

2,000 gallons per hour.	Height, 46 ft.	Floor Space, 8 ft. × 8ft.
20,000     "     "	"     57 "	"     "     19 ft. × 19ft.
100,000   "     "	"     65 "	"     "     58 ft. × 24ft.
300,000   "     "	"     80 "	"     "     164 ft. × 24ft.

These tower coolers are large and heavy affairs and must have good foundations and be calculated to stand a wind pressure, if exposed, of 30 lb. per square foot.

They throw off huge volumes of steam and wet air and ought to be well away from buildings, which will be seriously damaged by the discharge.

Though wooden towers are cheaper, those of iron are more durable.

A natural draught tower standing on a total floor space 30 feet square, will cool the water necessary to condense 30,000 lb. of steam per hour if provided with earthenware-pipe filling. A fan tower of equal capacity would occupy a space 25 ft. 6 in. × 24 ft. With a filling of split-metal tubes the floor space for these two towers would be reduced to 26 ft. × 26 ft. and 18 ft. × 16 ft. 6 in. respectively. As stated later, English practice may require more liberal design.

### Fan Cooling Towers.

To ensure greater certainty of effect towers are often made lower and air is forced through them by fans. They do not depend on temperature for their effect, but of course they require power to drive the fans. Apart from the fan

## WATER COOLING

draught they can be filled with the same drizzling boards as some of the wooden towers. They are, however, often filled with galvanized woven steel mats, with short drain tiles on end or with short lengths of interlaced split-steel pipes. The object is to divide and turn over the descending water repeatedly and continually in its descent through the rising air.

Mr. Koppel's figures for ground space occupied by a fan tower are 11 ft.  $\times$  13 ft. for 20,000 gallons per hour and 18 ft.  $\times$  24 ft. for 100,000 gallons. He gives the brake horse-power of the fan motors as 2 for a capacity of 5,000 gallons of water cooled per hour; 5 b.h.p. for 20,000 gallons and 25 b.h.p. for 100,000 gallons. Towers of concrete have been built, one at Nuremberg being named which cools 77,000 gallons per hour.

Figs. 83 and 84 show two forms of fan tower: the "Barnard" (Fig. 83) with wire-mat filling, and the "Worthington" (Fig. 84) with drain tiles, over which the water is distributed by a Barker's mill.

It will not usually pay to use fan towers where there is room for natural draught towers to stand.

*The Barnard Tower.*—In the Barnard tower wire mats are slung inside. This tower may be either of the chimney or fan type. The chimney type is made as high as 70 or 100 feet, in iron, and circular in plan or rectangular. The fan cooler, of course, may be of more moderate total height. The chimney cooler will reduce temperature from, say, 130° to 85° or 90°. The fan cooler will do more. The inside

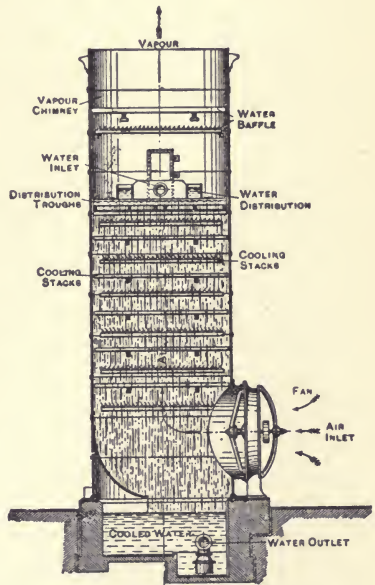

FIG. 83. BARNARD TOWER.

## WATER SOFTENING AND TREATMENT

dimensions of Barnard fan-cooled towers are such as to allow about 350 cubic feet capacity per 1,000 gallons per hour, a 2,000 lb. tower measuring 4 ft. 3 in.  $\times$  5 ft. 2 in.  $\times$  31 ft. 3 in.; one of 10,000 gallons 9 ft. 3 in.  $\times$  10 ft. 11 in.  $\times$  36 ft. 3 in., and one of 30,000 gallons 16 ft. 3 in.  $\times$  14 ft. 2 in.  $\times$  41 ft. 4 in. Fanless towers are of course of greater

capacity, a circular tower for 2,000 lb. steam per hour being 8 ft. diameter  $\times$  21 ft. 2 in. high from water-inlet level to top of foundation; a 10,000-gallon tower measuring 15 ft. diameter  $\times$  26 ft. 5 in. high, and one of 25,000 gallons 21 ft. 3 in. diameter  $\times$  31 ft. 7 in. high; dimensions representing from 500 cubic feet for the smaller sizes, to 450 cubic feet for the larger sizes. The fanless towers have of course their chimney height in addition to the above heights, which are all measured from the water inlet, and show the capacity occupied by the steel mats.

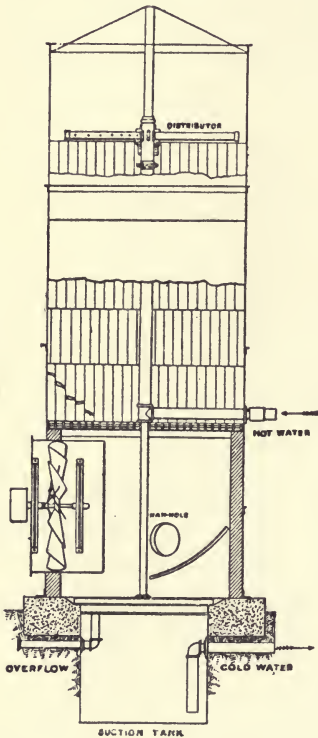

FIG. 84. WORTHINGTON TOWER.

As regards all forms of coolers, it may be assumed that the power necessary to pump the water over the tower is double in brake horse-power the actual foot pounds of work done in lifting the water through the height of the water distribution above the pump. The power to drive the fans, as previously explained, is about the same as is required to lift the circulating water, for the amount of air to be moved is very large.

From experiments made by Mr. J. H. Vail,<sup>1</sup> it appears that in a given case, where non-condensing engines used

<sup>1</sup> *Trans. Am. Soc. M.E.*, vol. xx.



## WATER COOLING

115,587 lb. of water per hour, it was decided to add a condenser and tower. The tower selected was a twin Barnard tower, each half 12 ft. 3 in.  $\times$  18 ft.  $\times$  29 ft. 6 in. high, with two fans. The steel plating was  $\frac{3}{16}$  in. and  $\frac{1}{4}$  in. with angle stiffeners. Water was delivered by a 10-inch pipe, extending full length of the apparatus, slotted and provided with 96 distributing pipes. There were 42 mats of No. 19 galvanized wire woven to No. 5 mesh and each mat was 15 ft. 6 in.  $\times$  12 ft., and hung vertically. The surface is called 8,064 feet. It appears to be  $7,812 \times 2 = 15,624$  as mere surface, not measuring it on the wires themselves.

The four fans were 8 feet diameter, each equal at 150 revs. to delivering 90,000 cubic feet per minute, or say, 7,000 lb. = 28,000 lb. in all.

The rated capacity of each chamber per hour is 12,500 lb. of steam from 132° F. to 80° F. when the atmospheric temperature was not over 75° F. and the humidity not over 85 per cent. Under these circumstances 28,000 lb. of air per minute is provided for 25,000 lb. of steam per hour, so that approximately 1 lb. of air is provided per minute for each pound of steam per hour. Put another way, the 25,000 lb. of steam bring about 25,000,000 thermal units, or say 400,000 units per minute. This shows 1 lb. of air per 14 heat units, or say 1 cubic foot of air per heat unit.

Previous figures show that 1 cubic foot of air may carry off as many as 4 heat units.

Cooling is not a matter of heating air merely, for 1 lb. of air heated 100° F. will only absorb about 24 heat units, or say 2 units per cubic foot. It is the power of carrying off heat in a latent form as vapour that adds to the cooling effect of air. Thus, where 1 lb. of air carries off  $\frac{1}{20}$  lb. of vapour, the heat absorbed is  $\frac{1}{20}$  of 1,000, or roughly 50 units. That is to say, 1 cubic foot carries off about 4 units besides the extra 1 to 2 units due and carried off by it in rise of temperature.

Mr. Vail's test figures are as follows :—

## WATER SOFTENING AND TREATMENT

	Jan. 31.	Feb.	June 20.	July.	Aug. 26.	Nov. 4.
Time . . . . .	9 p.m.	8 p.m.	8 p.m.	8 p.m.	8 p.m.	5.35
Atmospheric temperature . . . . .	30°	36°	78°	96°	65°	59°
Condenser discharge . . . . .	110°	110°	120°	130°	118°	129°
Condenser suction . . . . .	65°	84°	84°	93°	88°	92°
Temperature reduction . . . . .	45°	26°	36°	37°	30°	37°
Fan-speed revs. per min. . . . .	36	0	145	162	150	148
Condenser vacuum . . . . .	25½	26	25	24½	25½	25
Strokes of air pump . . . . .	30	30	37	44	43	28

On one occasion the plant was worked fourteen hours in an atmospheric temperature between 83° F. and 103° F. The condenser discharge varied between 106° and 128°, the suction from 91° to 98° F. The average fan speed was 150 r.p.m. and the vacuum varied between 20 in. and 26 in., with the air pump running 38 to 50 strokes.

The power developed varied between 400 and 900 i.h.p.

In the month of November a 25-inch vacuum gave out of a total of 643.3 h.p., no less than 185 i.h.p. below the atmospheric line, so that allowing for previous back pressure at least 200 h.p. must have come from the condenser. It required 13.75 h.p. to drive the air pump; 13.5 h.p. to drive the fan, showing a balance of 173 h.p. from the plant to pay for interest and depreciation, etc.

It may be added that since cooling towers have been rated largely on American experience with air considerably dryer and therefore more refrigerative than is the case in England they will not, for a given size, give equal results in moister climates, and engineers should calculate them not on what has been done elsewhere, but on the basis of the conditions under which they will have to work and on a basis of thermal unit capacity throughout.

It is open to be assumed that in foggy weather, the air being sometimes fully saturated with moisture, there can be little cooling effect by the air upon warm water, either in a tower or otherwise. This superficial view, however, ignores the facts in the above table. Far more moisture is

## WATER COOLING

required to saturate air when warm than when cold, and the mere fact of raising the temperature of the air in its passage by so much hot water is enough largely to increase its capacity for moisture.

Further, periods of fog, more especially perhaps in the south-east of England, are periods of low temperature. A London fog is very usually accompanied by frost. The atmosphere, it is true, is saturated with moisture at such times, but it is also true that not very much moisture is sufficient to do this. There is therefore no need to fear the serious failure of a cooling tower during fog. It is, however, desirable, in the case of large towers, to divide the fan equipment into two, three, or even more separate items, in order that the amount of air blown may be regulated. The fans are merely air propellers, serving to move a large volume of air against a low resistance.

### Spraying Nozzles.

Spraying nozzles are small gun-metal nozzles fitted inside with little loose spirals of flat sheet brass or with a screw of the form shown in Fig. 85, which is that of Ledward & Co.

These nozzles are fitted in large numbers on a length or lengths of pipe at any height above ground. The air-pump or circulating-pump discharge escapes through them and is flung into the air with a whirling motion which causes it to break up into spray. The pressure must not be too great, or too much resistance will be thrown on the pump. A head of 10 feet is considered suitable, and the annexed table (XXV.) gives the output at that pressure. Sprayers must be used with judgment and cannot be placed high when near other property, as the wind carries the spray and causes a public nuisance. In such cases they must be placed low and may be arranged over an area of concreted floor sloped to drain the water back to the suction point. It is not necessary

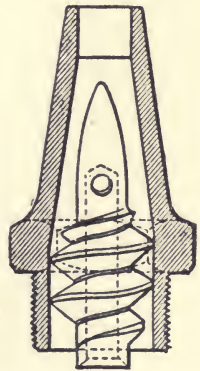

FIG. 85. SPRAY NOZZLE.

## WATER SOFTENING AND TREATMENT

to work them by the air pump. They can of course be worked by their own special pump, and where water is scarce and space insufficient sprayers may be run by a small electrically driven pump to keep water in circulation constantly, cooling it down during hours of light load.

TABLE XXV.  
SPRAYER OUTPUT.

No.	Diameter of Orifice.	Diameter of Supply Pipe.	Approximate Discharge per hour under 10 ft head gallons.
1	$\frac{1}{4}$ in.	$\frac{1}{2}$ in.	90
2	$\frac{1}{2}$ in.	1 in.	350
3	$\frac{3}{4}$ in.	$1\frac{1}{2}$ in.	800
4	1 in.	2 in.	1400



Section V

---

FEEED PUMPS  
INJECTORS



## CHAPTER XXVII

### FEED PUMPS

IT is impossible to include descriptions of more than a fraction of the feed pumps on the market. A few only can be described in the limited space available. Feed pumps exist as direct acting, steam driven, with steam and water cylinders tandem fashion on the one rod. as crank-shaft pumps also steam driven, electrically driven pumps, belt-driven pumps, etc.

In dealing with the subject generally engineers should be cautious how they use the tables of horse-power and pump duty which appear in American catalogues, many of which are widely scattered in this country. These tables are often based on a gallon of only  $8\frac{1}{2}$  lb. and not on the imperial gallon of 10 lb., and the effect when this is not recognized is unfair to the English pump maker, for the tables convey a false idea of what is done by other pumps.

A pump is really a simple matter to calculate, for it is merely a machine for raising weights, or for moving a piston against a pressure that can be translated into the equivalent of a raised weight. Large masses of water are often put into movement by small pumps, for supply pipes are sometimes long. It is an axiom in durable and good pump practice that speeds shall be slow where movement is of the reciprocating order, while the contrary holds good where the water moves continuously and in one direction, as in the case of the centrifugal pump and other perhaps less known forms. When reciprocating pumps do run quickly they are of special design in which provision is made for the preservation of motion of the water in one continuous flow.

Care must be taken in choosing a pump carefully to

## WATER SOFTENING AND TREATMENT

compare speeds and capacities, as pumps are very variously rated, and it is bad practice to economize by using cheap pumps at high speeds. The exhaust from steam-driven pumps should be utilized to heat feed water, and may be made specially useful where softening by the Porter-Clark process is carried on, the exhaust steam helping the process very materially.

Where a pump draws its supply from a distance there ought to be, near the pump, an air, or rather partial vacuum chamber, as a reserve to maintain constant flow in the suction pipe and avoid shock.

It is usual to have feed apparatus in duplicate as a safeguard against breakdown, and it is very convenient for testing purposes to be able to feed any one, or more, boilers from one source, so that the water supply to those particular boilers can be separately measured; but an undue duplication of feed pipes should be avoided, breakdown being guarded against rather by wise expenditure on good pipes, flanges and joint rings, than by a prolific use of inferior material.

When hot water is to be pumped it should either flow by gravity to the pump, or the height of lift should be considerably less than that represented by 25 feet —  $h$ , where  $h$  is the height in feet of a column of water equivalent to the pressure of steam at the given temperature.

Thus at a temperature of 162° F. the head in feet is about 12. Then  $25 - 12 = 13$  feet would be the maximum lift that should be attempted.

The actual net work done by a feed pump is represented by the product of the weight of water pumped in a given time, and the height in feet equivalent to the boiler pressure against which the feed is pumped. Pump efficiency may be assumed at 50 per cent., or say at 40 per cent. overall efficiency for pump and electric motor, as ascertained by the writer in case of a treble ram pump electrically driven by worm gearing. Where worm gear is employed the thrust bearing should be long and run in an oil bath, and the thrust collar should not be placed in too narrow a part of the casing or it will fail to get sufficient lubrication.



## FEED PUMPS

In the following tables (XXVI. and XXVII.) are given a few particulars as to the lift practically advisable for pumps drawing hot water. The table is worked out for barometric pressures at different altitudes, but in place of the barometric pressure may be placed 14.7 less the vapour tension of water at any given temperature, as shown in Table XIII.

It is also useful to remember that the square of the diameter in inches of a cylindrical pipe gives approximately the weight of water it contains per yard in pounds.

TABLE XXVI.

FOR CONVERTING FEET HEAD OF WATER INTO PRESSURE PER SQUARE INCH.

Feet Head.	Pounds per Square Inch.	Feet Head.	Pounds per Square Inch.	Feet Head.	Pounds per Square Inch.
1	·43	55	23.82	190	82.29
2	·87	60	25.99	200	86.62
3	1.30	65	28.15	225	97.45
4	1.73	70	30.32	250	108.27
5	2.17	75	32.48	275	119.10
6	2.60	80	34.65	300	129.93
7	3.03	85	36.81	325	140.75
8	3.46	90	38.98	350	151.58
9	3.90	95	41.14	375	162.41
10	4.33	100	43.31	400	173.24
15	6.50	100	47.64	500	216.55
20	8.66	120	51.97	600	259.85
25	10.83	130	56.30	700	303.16
30	12.99	140	60.63	800	346.47
35	15.16	150	64.96	900	389.78
40	17.32	160	69.29	1000	433.09
45	19.49	170	73.63	—	—
50	21.65	180	77.96	—	—

Thus a 4-inch pipe contains 1.6 gallons = 16 lb. = (4 × 4).

To find the pressure in pounds to the square inch of a column of water, multiply the height of the column in feet by .434. Approximately, every foot elevation is equal to one-half pound pressure to the square inch; this allows for ordinary friction.

The mean pressure of the atmosphere is usually estimated at 14.7

## WATER SOFTENING AND TREATMENT

pounds to the square inch, so that with a perfect vacuum it will sustain a column of mercury 29.9 inches, or a column of water 33.9 feet high.

Doubling the diameter of a pipe increases its capacity four times. Friction of liquids in pipes increases as the square of the velocity.

**TABLE XXVII.**  
FOR CONVERTING PRESSURE PER SQUARE INCH INTO FEET HEAD OF WATER.

Pounds per Square Inch.	Feet Head.	Pounds per Square Inch.	Feet Head.	Pounds per Square Inch.	Feet Head.
1	2.31	55	126.99	180	415.61
2	4.62	60	138.54	190	438.90
3	6.93	65	150.08	200	461.78
4	9.24	70	161.63	225	519.51
5	11.54	75	173.17	250	577.24
6	13.85	80	184.72	275	643.03
7	16.16	85	196.26	300	692.69
8	18.47	90	207.81	325	750.41
9	20.78	95	219.35	350	808.13
10	23.09	100	230.90	375	865.89
15	34.63	110	253.98	400	922.58
20	46.18	120	277.07	500	1154.48
25	57.72	125	288.62	—	—
30	69.27	130	300.16	—	—
35	80.81	140	323.25	—	—
40	92.36	150	346.34	—	—
45	103.90	160	369.43	—	—
50	115.45	170	392.52	—	—

**WEIGHT AND CAPACITY OF DIFFERENT STANDARD GALLONS OF WATER.**

	Cubic Inches in a Gallon.	Weight of a Gallon in Pounds.	Gallons in a Cubic Foot.	Weight of a cubic foot of water, English standard
Imperial or English	277.274	10.00	6.232102	62.321 lb.
United States	231.	8.33111	7.480519	Avoirdupois.

## FEED PUMPS

TABLE XXVIII.  
AREAS OF CIRCLES.

Diam.	Area.	Diam.	Area.	Diam.	Area.	Diam.	Area.
$\frac{1}{8}$	.012	4 inches	12.56	13 inches	132.73	22 inches	380.13
$\frac{1}{4}$	.049	$\frac{1}{2}$	15.90	$\frac{1}{2}$	143.13	$\frac{1}{2}$	397.60
$\frac{3}{8}$	.110	5 inches	19.63	14 inches	153.94	23 inches	415.47
$\frac{1}{2}$	.196	$\frac{1}{2}$	23.75	$\frac{1}{2}$	165.13	$\frac{1}{2}$	433.73
$\frac{5}{8}$	.441	6 inches	28.27	15 inches	176.71	24 inches	452.39
1 inch	.785	$\frac{1}{2}$	33.18	$\frac{1}{2}$	188.69	$\frac{1}{2}$	471.43
$\frac{1}{8}$	.994	7 inches	38.48	16 inches	201.06	25 inches	490.8
$\frac{1}{4}$	1.227	$\frac{1}{2}$	44.17	$\frac{1}{2}$	213.82	$\frac{1}{2}$	510.7
$\frac{3}{8}$	1.767	8 inches	50.26	17 inches	226.98	26 inches	530.9
$\frac{1}{2}$	2.405	$\frac{1}{2}$	56.74	$\frac{1}{2}$	240.52	$\frac{1}{2}$	551.5
$\frac{5}{8}$	3.141	9 inches	63.61	18 inches	254.46	27 inches	572.5
2 inches	3.976	$\frac{1}{2}$	70.88	$\frac{1}{2}$	268.80	$\frac{1}{2}$	593.9
$\frac{1}{8}$	4.908	10 inches	78.54	19 inches	283.53	28 inches	615.7
$\frac{1}{4}$	5.939	$\frac{1}{2}$	86.59	$\frac{1}{2}$	298.64	$\frac{1}{2}$	637.9
$\frac{3}{8}$	7.06	11 inches	95.03	20 inches	314.16	29 inches	660.5
3 inches	8.29	$\frac{1}{2}$	103.87	$\frac{1}{2}$	330.06	$\frac{1}{2}$	683.4
$\frac{1}{8}$	9.62	12 inches	113.10	21 inches	346.36	30 inches	706.8
$\frac{1}{4}$	11.04	$\frac{1}{2}$	122.71	$\frac{1}{2}$	363.05	$\frac{1}{2}$	730.6

# WATER SOFTENING AND TREATMENT

## TABLE XXIX.

BAROMETRIC PRESSURES AT DIFFERENT ALTITUDES, WITH EQUIVALENT HEAD OF WATER AND THE VERTICAL SUCTION LIFT OF PUMPS.

Altitude.		Barometric Pressure		Equivalent Head of Water.	Practical Suction Lift of Pumps.
Sea Level	. . . . .	14.70	pounds per square inch	33.95 feet	25 feet
1 mile (1320 feet) above sea level	. . . . .	14.02	" "	32.38 "	24 "
1 1/2 "	" "	13.33	" "	30.79 "	23 "
2 "	" "	12.66	" "	29.24 "	21 "
3 "	" "	12.02	" "	27.76 "	20 "
4 "	" "	11.42	" "	26.38 "	19 "
1 1/4 "	" "	10.88	" "	25.13 "	18 "
1 1/2 "	" "	9.88	" "	22.82 "	17 "
2 "	" "	"	" "	"	"



## FEED PUMPS

*Flow of water in pipes.*—It is not desirable to give too rapid a velocity to water flowing in a pipe. About 3 feet per second is considered a sufficient velocity.

Darcy's formula for the loss of head due to friction in pipes is :—

$$h = \left( 0.017379 + \frac{0.0015965}{d} + \frac{0.0040723 + \frac{0.000020816}{d^2}}{v} \right) \times \frac{l v^2}{d 2g} \quad (1) \quad \text{and}$$

$$h = \left( 0.0198920 + \frac{0.00166573}{d} \right) \frac{l v^2}{d 2g} \quad (2); \quad \text{where}$$

$h$  = loss of head in feet due to friction.

$d$  = internal diameter of pipe in feet.

$v$  = velocity per second in feet.

$l$  = length of pipe in feet.

$2g = 64.324.$

The formula (1) is used for velocities less than 0.33 feet per second, and should fit feed-pipe work if very liberally proportioned.

Formula (2) is for  $v =$  more than 0.33 feet per second.

The rules are applicable to pipes of 4 in. and upwards, and represent about 10 feet loss of head per 1,000 feet for 4-inch pipes at 3 feet per second.

For smooth inside pipes of small diameter Weston's formula is :—

$$h = \left( 0.0126 + \frac{0.0315 - d 0.06}{\sqrt{v}} \right) \frac{l v^2}{d 2g}$$

By this rule a 1-inch pipe will lose about 5 feet of head per 100 feet for a velocity of 3 feet per second, whereas a 2-inch pipe will only lose about  $2\frac{1}{4}$  feet of head per 100 feet. Loss of head increases with the square of the velocity, and the influence of length is serious. Velocity may be increased for short distances in larger sizes of pipes up to 6 feet per second.

Long pipes laid horizontally to pumps should have a suction air vessel near the pump to assist in preserving

## WATER SOFTENING AND TREATMENT

the motion of the water uniform in the pipe, and every pump should have an air vessel on its delivery side.

In fixing on feed-pump arrangements, it is always desirable that there should be at least two feed pumps to a plant. Where a large plant is divided into a number of independent sections, it is a doubtfully good practice to provide each set or section with so much provision in the way of feed pumps. In such a case a moderate supply of spares should suffice, all the pumps discharging into one feed main, which may have cut-out valves to divide off the various sections. By this means the failure of the pump or pumps of any section can be made good by a supply through the common main. Speaking generally, the same may be said of feed pipes as of steam pipes,<sup>1</sup> that an excellence of materials and construction should be preferred to an excessive duplication of mains.

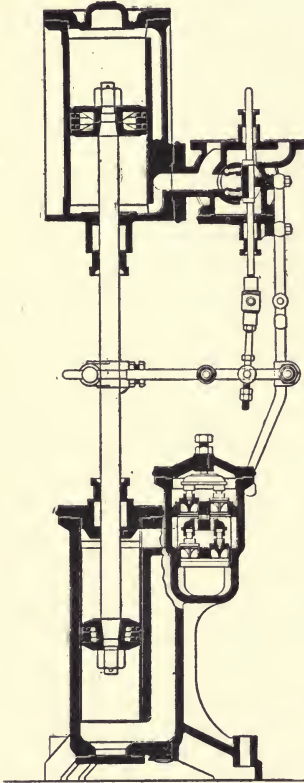

FIG. 86. WEIR FEED PUMP.

The Weir Feed Pump, of which a simple form is shown in Fig. 86, is one of the slow and long-stroke variety, built for economy, durability and reliability.

From the annexed table it will be seen that at the normal speed of practically 16 double strokes per minute, the stroke being 15 in., the piston velocity is only 40 ft. per minute. The pump tested had 6-in. pump cylinder and 8-in. steam cylinder, a stroke of 15 in., and a steam pressure of 110 and 107 lb. In the course of twelve tests the efficiency never

<sup>1</sup> See *Steam Pipes*, by the same Author, Constable & Co.

## FEED PUMPS

fell below 95 per cent., even at so slow a speed as three double strokes per minute. Pumps like these have a margin very considerable, when it is considered that a bucket velocity of 80 to 100 ft. per minute is considered quite ordinary.

	Normal Speed.	Slow Speed.
Steam pressure at pump . . . . .	110 lb.	107 lb.
Water       "       " . . . . .	164 lb.	164 lb.
Double strokes per minute . . . . .	15.9	6.0
Efficiency of pump . . . . .	97.25%	96.6%
Pounds of water per pound of steam . . . . .	84.6	55.3
Pounds of steam per net h.p. . . . .	63.1	95.3
Foot-pounds work per B.Th.U. to 212° . . . . .	31.1	21.0

The exhaust from a Weir or any other steam-driven pump may be turned through the intermediate receiver of a compound engine or used in a feed heater. The former use is preferable as a rule. The valve of the Weir pump is a D valve, on the back of which works a small auxiliary valve, and the design is such that when steam is turned on the pump will always work. The barrel is of gun metal, the rod of bronze, and so are the valves and seats, water piston and mountings. These pumps work up against pressures of 200 lb., and have been made even to work at 600 lb.

The makers publish the annexed table of quantities and floor-space allowances as a guide in making provision for pumps. The quantities in Table XXX. may be reduced by 5 per cent., as an allowance for slip or other loss.

The advantage of a direct-acting steam pump is, of course, that the application of the moving force to the water is elastic, and there can be no excess of mechanical stress exerted in any part of the pump, all stresses in which are limited to the maximum static steam stress on the steam piston.

# WATER SOFTENING AND TREATMENT

## TABLE XXX.

STANDARD SIZES AND CAPACITY OF WEIR DIRECT-ACTING PUMP  
FOR LAND INSTALLATIONS.

Dia- meter of Pump.	Cylin- der of Pump.	Length of Stroke.	Gallons Discharged per Double Stroke.	<sup>1</sup> Gallons Discharged per Hour at 12 Double Strokes per Min.	Floor Space.				Height.	
					ft.	in.	ft.	in.	ft.	in.
5½	7½	15	2.49	1792.8	1	5½ × 1	7	6	4½	
6	8	15	2.94	2206.8	1	9½ × 1	10	6	10	
6	8	18	3.53	2541.6	1	9½ × 1	10	7	7	
7	9½	18	4.86	3499.2	1	10 × 2	0	7	7	
7	9½	21	5.67	4082.4	1	10 × 2	0	8	4	
8	10½	18	6.352	4573.4	1	2 × 2	3	8	0	
8	10½	21	7.43	5349.6	2	2 × 2	3	8	9	
8	10½	24	8.49	6113.8	2	2 × 2	3	9	6	
9	12	21	9.34	6724.8	2	4 × 2	6	8	9	
9	12	24	10.67	7682.4	2	4 × 2	6	9	6	
9½	12½	24	11.83	8521.2	2	4 × 2	6	9	6	

### Directing-Acting Steam Pumps.

There is a large class of direct-acting steam pumps of the duplex and other varieties, which have perhaps the advantage of small initial cost, but are not always very strongly built. They are often found with excessively light valve spindles, and are not, when of foreign origin, usually up to the standard looked for in an English-made pump. In the duplex type the valve gear of the one side is driven from the piston rod of the other side, and vice versâ. In purchasing these pumps they are sometimes found to have a catalogue rating on so many gallons per hour, and the gallon is very much less than the English imperial gallon of 10 lb. of water. Errors are apt to arise from this cause.

### Worthington Vertical Duplex Feed Pump.

This pump of the long-stroke variety (Fig. 84) has steam cylinders 14 in. diameter, pump plungers 9½ in. diameter,

<sup>1</sup> This is the best speed for boiler feeding.



## FEED PUMPS

and 18 in. stroke. Continuity of action is secured by driving each steam valve from the rod of the other cylinder, as customary in duplex pumps.

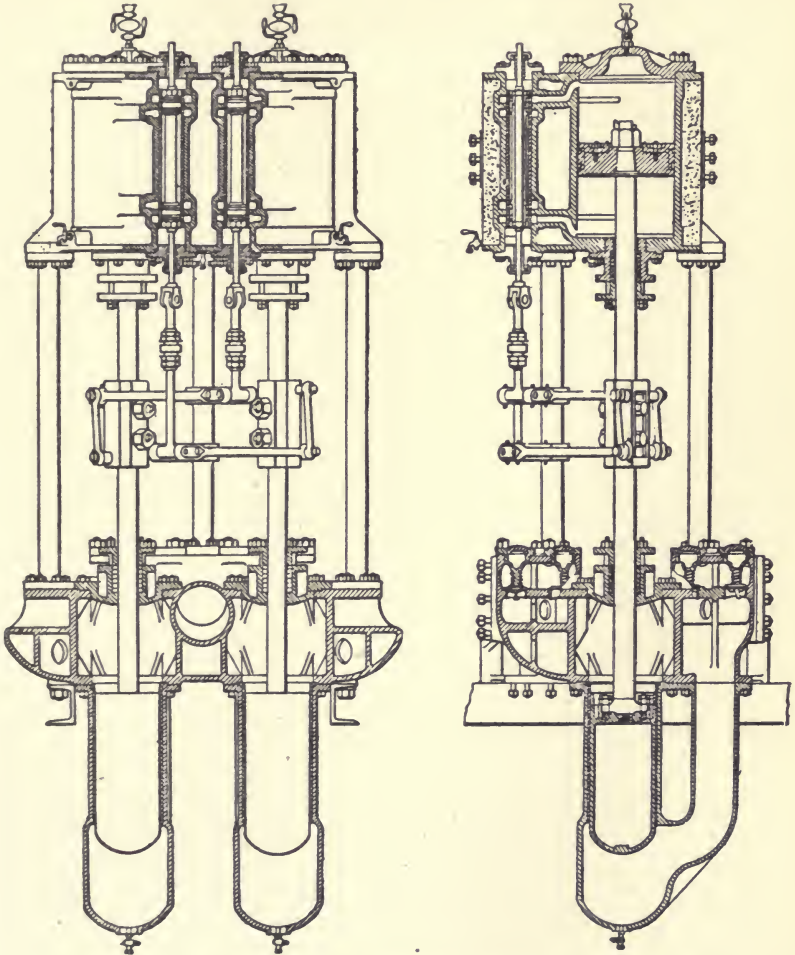

FIG. 87. WORTHINGTON LONG-STROKE DUPLEX FEED PUMP.

### Flywheel Pumps.

The "Cameron" class of pumps, steam-driven and with ram pump, is still a favourite pump with many steam users,

## WATER SOFTENING AND TREATMENT

and is largely employed in the textile mills for both boiler-feed and fire purposes. Above 80 lb. pressure, double-ram pumps are employed for steadiness. These pumps are very durable. An air vessel is necessary, and this is amply provided for by the cast-iron columns of the framing, which are hollow. Fig. 88 shows one of these pumps as made by

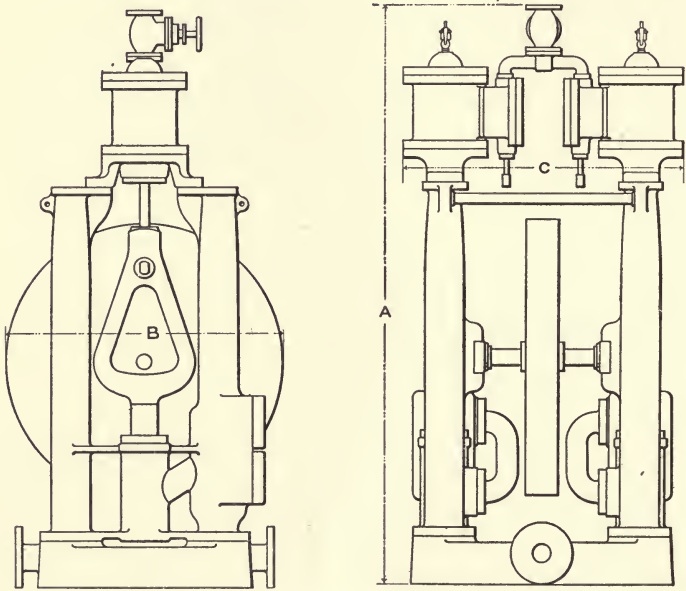

FIG. 88. CAMERON OR FLYWHEEL PUMP (Pearn).

Frank Pearn & Co., and the following table gives some particulars of their capacity when double. The single-ram pumps, with single steam cylinder, have a capacity one-half that of the double-ram pumps of equal ram diameter.

When carefully packed these pumps run easily, and have a good volumetric efficiency.

# FEED PUMPS

## TABLE XXXI.

DIMENSION AND CAPACITY OF DOUBLE-RAM CAMERON PUMPS.

Diam. of Rams . . in.	2	2½	3	3½	4	4½	5
Diam. of Cylinders . . . in.	4	5	6	6	7	7	7
Length of Stroke in.	3	4	5	5	6	6	6
Strokes per Minute	130	100	90	90	80	80	80
Gals. per Hour .	520	800	1340	1800	2560	3200	4000
Diam. of Suct. and Del. . . . in.	1¼	1½	2	2	3	3	3
Diam. of Steam Pipe . . . in.	¾	1	1	1¼	1½	1½	1½
Diam. of Exhaust Pipes . . . in.	¾	1	1	1	1½	1½	1½
Diam. of Rams in.	6	7	8	10	12	15	
Diam. of Cylinders . . in.	8½	10	12	14	16	18	
Length of Stroke in.	8	9	10	12½	15	15	
Strokes per Minute	70	60	54	47	40	35	
Galls. per Hour .	6400	8800	11500	20000	28800	40000	
Diam. of Suct. and Del. . . . in.	4	4	5	6	8	—	
Diam. of Steam Pipe . . . in.	2	2	2½	3	4	—	
Diam. of Exhaust Pipes . . . in.	2	2	2½	3	4	—	

### The Fromentin Boiler Feeder.

Though rarely seen, this apparatus has been found to work well, and it should do so with clean water, though there may be a reasonable doubt of its action when water contains carbonate of lime and is already heated to depositing point. The apparatus consists of two iron bottles on a balance beam, so arranged that each bottle in turn is open to the water supply and the boiler alternately. A bottle full of water cannot run out into the boiler until the end of the discharge pipe in the boiler has become exposed by lowering of the water level.

# WATER SOFTENING AND TREATMENT

## The Injector.

The Injector is not an efficient machine as a heat engine, but it serves the double purpose of a feed pump and a feed heater, and returns the heat it does not utilize to the boiler, though not at maximum boiler temperature, and thus at a loss of efficiency.

Injectors will drive water into the boiler from which their supply of steam is taken. They will even work against higher pressures.

The exhaust steam injector using steam at atmospheric pressure will even deliver water, if supplied cold, into a boiler at possibly 100 lb. pressure.

The action of the injector is simple, and resolves itself into a question of momentum.

One pound of steam cooled to 180° F. will part with about 1,000 B.Th.U. If water be supplied at 60° F. and heated to 180° F., it will gain 120° F., so that 8 lb. of water would in such a case condense 1 lb. of steam to water at 180° F.; and if the velocity of flow of the steam were 900 feet

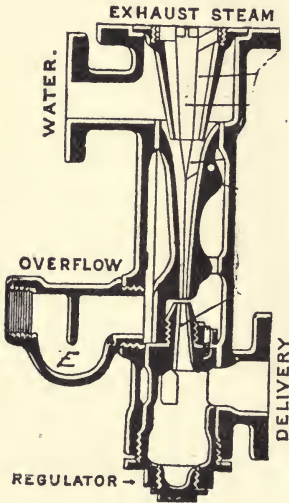

FIG. 89. EXHAUST STEAM INJECTOR.

per second, the velocity of the combined jet would be  $900 \div (8 + 1) = 100$  feet per second. Now, a velocity of 100 feet per second will result from a head of  $H$  feet of water by the customary formula:  $V = 8 H$ , whence  $H =$  about 150 feet or  $64\frac{1}{2}$  lb. The above figures are illustrative merely, for it is generally understood that the exhaust injector will save more than an eighth of the exhaust steam, an economy of 15 to 20 per cent. being claimed. Makers of these instruments state that they will heat the feed to 190° F., and inject it into a boiler up to 75 lb. pressure. The action of this injector is secured by splitting the combining nozzle



## FEED PUMPS

in half longitudinally, and hinging the loose half so that the injector standing vertically the flap can freely swing open and as easily close when a vacuum is again made within it.

The construction is clear in Fig. 89.

For pressures above 75 lb. the jet from the exhaust injector, at say 70 lb., passes on to a live steam injector, as in Fig. 90.

Water at 190° F. will condense more steam at a high pressure which heats the feed now to 270° F., at which temperature it enters the boiler.

Fig. 90 shows the form of combined injector suited for locomotive work.

Both portions are fitted with the split nozzle, which gives automatic re-starting.

The size of an injector is always the smallest diameter of the cones in millimetres.

The number of gallons per hour that can

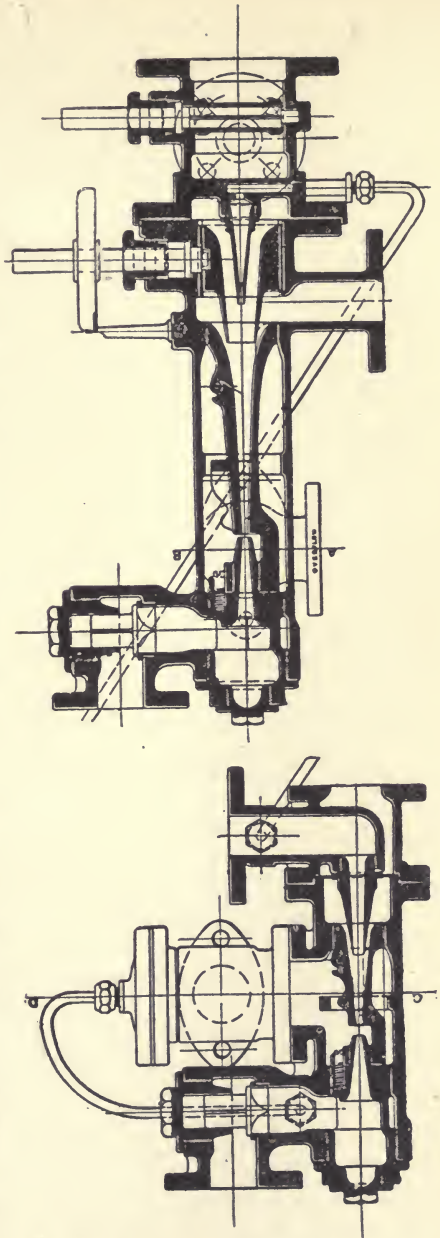

FIG. 90. COMBINED INJECTOR.

## WATER SOFTENING AND TREATMENT

be fed by an ordinary live-steam injector varies with the square of the diameter of throat in millimetres, and with the square root of the steam pressure, if published tables are to be relied on. The apparent formula is  $G = D^2 \times 2\sqrt{P}$ , where  $G$  = gallons per hour and  $P$  = gauge pressure of steam.

Thus a No. 2 is rated at 25 gallons for 10-lb. and 100 gallons for 160-lb. pressure. A No. 20 is rated at 2,513 and 10,048 gallons respectively for the same two pressures. Other sizes and other pressures all are consistent.

All injectors fixed "lifting" give a less delivery according to the height of the lift. A slight lift, such as 3 feet, makes very little difference; but with higher lifts the reduction is about as follows:—

A lift of 6 feet	reduces the delivery	about	10%.
" 12 feet	" "	" "	25%.
" 18 feet	" "	" "	35%.

There are an almost infinite variety of injectors, many of them of apparently unnecessary complication of parts.

Every information as to fitting and capacity will be found in makers' catalogues.

It may be added that injectors should always draw their supply of water through a carefully made fine wire-gauze strainer, and that when the internal parts become coated with scale they can be cleansed by soaking in a 10 per cent. solution of hydrochloric acid. When fitted to lift their supply, the capacity of injectors is reduced.

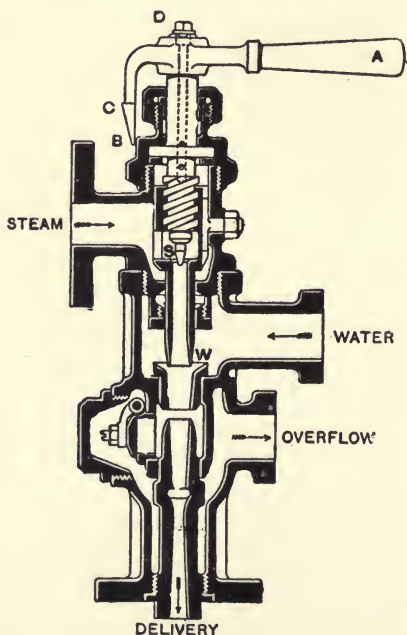

FIG. 91. EXHAUST STEAM INJECTOR (Holden & Brooke).

## FEED PUMPS

The reduction of capacity is nearly 2 per cent. per foot of lift, and the maximum lift is about 18 feet, and the suction pipe should have a foot retaining valve.

The steam-supply pipe to all injectors, and especially to exhaust-steam injectors, should be taken off the steam pipe by a square bend, in order that moisture and oil may be separated out of the steam. Where non-condensing engines are employed, an exhaust injector offers a means of heating the feed-water tank and assisting the softening process. Considering the absence of serious or perhaps any pressure against which it may have to work, it is probable that such an injector could even be employed to draw its steam from the exhaust pipe of a condensing engine for warming up a feed tank. In such a case possibly it would be found necessary to connect the overflow of the injector to the condenser, with, of course, a non-return valve in circuit.

A rule sometimes used for finding the velocity of flow of steam is :—

$$V = 8\sqrt{\frac{n P}{(n + 1) R}} \quad \text{where } V = \text{feet per second velocity.}$$

$P$  = pressure per square foot and  $R$  = weight of a cubic foot of steam at the pressure  $P$  ; or

$$V = 8\sqrt{\frac{n}{n + 1} P W} \quad \text{where } W \text{ is the volume of one pound of steam in cubic feet,}$$

$n = 1 \text{ to } 1.4$ , according to dryness.

$$\text{Approximately } V = 6\sqrt{\frac{P}{R}} \quad \text{the true value of } V \text{ being}$$

some 5 per cent. less for wet steam and 2 per cent. greater for dry steam.

The following table gives the capacity and sizes of some plain exhaust injectors.

# WATER SOFTENING AND TREATMENT

## TABLE XXXII.

SIZES AND CAPACITIES OF EXHAUST STEAM INJECTORS.

Size of Injector. mm.	Delivery in gallons per hour.	Inside Diameter of Pipes.		
		Branch from Exhaust.	Water Pipes.	Overflow.
3	150	1½ in.	¾ in.	½ in.
4	270	2 in.	1 in.	¾ in.
5	420	2 in.	1 in.	1 in.
6	600	2½ in.	1¼ in.	1¼ in.
7	830	3 in.	1¼ in.	1¼ in.
8	1080	3½ in.	1½ in.	1½ in.
9	1370	4 in.	1½ in.	1½ in.
10	1700	4½ in.	2 in.	2 in.
11	2050	5 in.	2 in.	2 in.
12	2450	5½ in.	2½ in.	2 in.

## TABLE XXXIII.

TEMPERATURE OF FEED WATER, HEIGHT OF LIFT, ETC., FOR "SIRIUS"  
SELF-ACTING INJECTORS.

Boiler Pressure.	Height Injector will lift its feed water.	2 Temperature at which Injector will take feed water (fixed non-lifting).
<sup>1</sup> 25 lb. 30 " 35 " 80 " 100 " 150 "	} 5 to 12 feet. (See Dimension A, Fig. 146.) } 12 to 20 feet.	150° F. 150° " 135° " 125° " 105° "

<sup>1</sup> With pressures below 25 lb. there should be no lift, and at all low pressures, the pipes (steam especially) should be short, free from bends, and of full area throughout.

<sup>2</sup> The Table of Temperatures as it stands applies only to a special injector. For other patterns the maximum temperature at which feed water can be taken is about 10° lower.



## Appendix No. 5.

### TABLE XXXIV.

SOLUBILITY OF AIR IN WATER AT .760 MILLIMETRE PRESSURE  
(1 ATMOSPHERE) AND VARIOUS TEMPERATURES CENTIGRADE.

0° C	0.02471	10° C	0.01953
1	.02406	11	.01916
2	.02345	12	.01882
3	.02287	13	.01851
4	.02237	14	.01822
5	.02179	15	.01795
6	.02128	16	.01771
7	.02080	17	.01750
8	.02034	18	.01732
9	.01992	19	.01717

$$\text{Temp. F.} = \text{Temp. C.} \times \frac{9}{5} + 32$$

### TABLE XXXV.

TENSION IN MILLIMETRES OF MERCURY OF WATER VAPOUR BETWEEN  
-5° AND + 35° C. OR 23° TO 95° F.

-5	3.131	5°	6.534	15°	12.669	25°	23.550
-4	3.387	6	6.998	16	13.536	26	24.998
-3	3.664	7	7.492	17	14.241	27	26.505
-2	3.955	8	8.017	18	15.357	28	28.101
-1	4.267	9	8.574	19	16.346	29	29.782
0	4.600	10	9.165	20	17.391	30	31.548
1	4.940	11	9.792	21	18.495	31	33.405
2	5.302	12	10.457	22	19.659	32	35.359
3	5.687	13	11.162	23	20.888	33	37.410
4	6.097	14	11.908	24	22.184	34	39.565

# WATER SOFTENING AND TREATMENT

## TABLE XXXVI.

VOLUME, SPECIFIC GRAVITY AND TENSION OF WATER VAPOUR FROM  
0° C. TO 180° C.

T° C.	Atmospheres Pressure.	Pressure kilos. per Cm <sup>2</sup>	Volume of 1 Kilo. of Vapour M <sup>3</sup>	Weight of 1 M <sup>3</sup> of Vapour.
0°	$\frac{1}{16.6}$	0.006	205.222	0.005
18	$\frac{1}{5.0}$	0.021	66.145	0.015
33	$\frac{1}{2.0}$	0.051	27.852	0.036
46	$\frac{1}{1.0}$	0.103	14.516	0.069
60	$\frac{1}{.5}$	0.206	7.583	0.032
65	$\frac{1}{.4}$	0.258	6.157	0.162
82	$\frac{1}{.2}$	0.516	3.227	0.310
92	$\frac{3}{4}$	0.775	2.215	0.451
100	1	1.033	1.696	0.591
112	$1\frac{1}{2}$	1.549	1.167	0.857
121	2	2.066	0.895	1.116
128	$2\frac{1}{2}$	2.582	0.729	1.371
134	3	3.099	0.617	1.620
140	$3\frac{1}{2}$	3.615	0.534	1.866
144	4	4.131	0.474	2.108
148	$4\frac{1}{2}$	4.648	0.426	2.347
152	5	5.164	0.387	2.584
156	$5\frac{1}{2}$	5.681	0.355	2.812
159	6	6.197	0.328	3.051
165	7	7.230	0.285	3.509
171	8	8.263	0.252	3.971
176	9	9.300	0.227	4.408
180	10	10.330	0.206	4.848

According to Resal the specific weight and the pressure of water vapour are satisfactorily co-related by the formula  $R = Mp^m$ , where R is the specific weight of saturated water vapour  $p$  = pressure in millimetres of mercury,  
 $M = 0.001164$ ,  
 $m = 0.943$ .

# APPENDIX

## TABLE XXXVII.

OF THE RELATIVE EQUIVALENCE OF PRESSURES IN MILLIMETRES  
(OR OTHER UNITS) OF WATER AND OF MERCURY.

Water.	Mercury.	Water.	Mercury.	Water.	Mercury.	Water.	Mercury.
1	0.07	16	1.18	35	2.58	200	14.76
2	0.15	17	1.26	40	2.95	250	18.45
3	0.22	18	1.33	45	3.32	300	22.14
4	0.30	19	1.40	50	3.69	350	25.83
5	0.37	20	1.48	55	4.06	400	29.52
6	0.44	21	1.55	60	4.43	450	33.21
7	0.52	22	1.62	65	4.80	500	36.90
8	0.59	23	1.70	70	5.17	550	40.59
9	0.66	24	1.77	75	5.54	600	44.28
10	0.74	25	1.84	80	5.90	650	47.97
11	0.81	26	1.92	85	6.27	700	51.66
12	0.89	27	1.98	90	6.64	800	59.04
13	0.96	28	2.07	95	7.01	900	66.42
14	1.03	29	2.14	100	7.38	1000	73.80
15	1.12	30	2.21	150	11.07		

The specific weight of mercury is 13.5501 times that of water.

# WATER SOFTENING AND TREATMENT

## TABLE XXXVIII.

TEMPERATURE AND PRESSURE OF STEAM FOR EACH HALF-INCH OF VACUUM.

Inches of Vacuum. Mercury Column.	Absolute Pressure. Lb. per square inch.	Temperature Degrees F.	Inches of Vacuum. Mercury Column.	Absolute Pressure. Lb. per square inch.	Temperature. Degrees F.
0	14.697	212.00	15	7.329	178.96
$\frac{1}{2}$	14.451	211.15	$15\frac{1}{2}$	7.084	177.44
1	14.206	210.29	16	6.838	175.87
$1\frac{1}{2}$	13.960	209.42	$16\frac{1}{2}$	6.592	174.26
2	13.715	208.54	17	6.347	172.59
$2\frac{1}{2}$	13.469	207.64	$17\frac{1}{2}$	6.101	170.86
3	13.223	206.73	18	5.856	169.07
$3\frac{1}{2}$	12.978	205.80	$18\frac{1}{2}$	5.610	167.23
4	12.732	204.86	19	5.364	165.31
$4\frac{1}{2}$	12.487	203.91	$19\frac{1}{2}$	5.119	163.32
5	12.241	202.94	20	4.873	161.25
$5\frac{1}{2}$	11.995	201.95	$20\frac{1}{2}$	4.628	159.09
6	11.750	200.95	21	4.382	156.83
$6\frac{1}{2}$	11.504	199.93	$21\frac{1}{2}$	4.136	154.46
7	11.259	198.89	22	3.891	151.97
$7\frac{1}{2}$	11.013	197.83	$22\frac{1}{2}$	3.755	149.34
8	10.767	196.75	23	3.410	146.55
$8\frac{1}{2}$	10.522	195.65	$23\frac{1}{2}$	3.164	143.59
9	10.276	194.53	24	2.918	140.42
$9\frac{1}{2}$	10.031	193.39	$24\frac{1}{2}$	2.673	137.01
10	9.785	192.23	25	2.427	133.32
$10\frac{1}{2}$	9.539	191.03	$25\frac{1}{2}$	2.172	129.31
11	9.294	189.81	26	1.926	124.89
$11\frac{1}{2}$	9.048	188.57	$26\frac{1}{2}$	1.680	119.94
12	8.803	187.30	27	1.435	114.34
$12\frac{1}{2}$	8.557	186.00	$27\frac{1}{2}$	1.189	107.84
13	8.311	184.66	28	0.944	100.05
$13\frac{1}{2}$	8.066	183.29	$28\frac{1}{2}$	0.698	90.24
14	7.820	181.88	29	0.453	76.80
$14\frac{1}{2}$	7.575	180.44	$29\frac{1}{2}$	0.207	54.21



# APPENDIX

## TABLE XXXIX.

FACTORS OF EVAPORATION FOR SATURATED STEAM.

Tem- pera- ture of Feed Water Deg. F.	BOILER PRESSURE IN POUNDS PER SQUARE INCH.												
	30	40	50	60	70	80	90	100	110	120	130	140	150
32	1.207	1.211	1.214	1.217	1.220	1.223	1.225	1.227	1.228	1.231	1.233	1.234	1.236
40	1.199	1.203	1.206	1.209	1.212	1.214	1.217	1.219	1.221	1.223	1.224	1.226	1.228
50	1.188	1.192	1.196	1.199	1.201	1.204	1.206	1.208	1.210	1.212	1.214	1.216	1.217
60	1.178	1.182	1.185	1.188	1.191	1.194	1.196	1.198	1.200	1.202	1.204	1.205	1.207
70	1.167	1.171	1.175	1.178	1.181	1.183	1.185	1.188	1.190	1.191	1.193	1.195	1.196
80	1.157	1.161	1.165	1.168	1.170	1.173	1.175	1.177	1.179	1.181	1.183	1.185	1.186
90	1.147	1.151	1.154	1.157	1.160	1.162	1.165	1.167	1.169	1.171	1.172	1.174	1.176
100	1.136	1.140	1.144	1.147	1.150	1.152	1.151	1.156	1.158	1.160	1.162	1.164	1.165
110	1.126	1.130	1.133	1.136	1.139	1.142	1.144	1.146	1.148	1.150	1.152	1.153	1.155
120	1.116	1.120	1.123	1.126	1.129	1.131	1.134	1.136	1.138	1.140	1.141	1.143	1.145
130	1.105	1.109	1.113	1.116	1.118	1.121	1.123	1.125	1.127	1.129	1.131	1.133	1.134
140	1.095	1.099	1.102	1.105	1.108	1.110	1.113	1.115	1.117	1.119	1.120	1.122	1.124
150	1.085	1.088	1.092	1.095	1.098	1.100	1.102	1.104	1.106	1.108	1.110	1.112	1.113
160	1.074	1.078	1.081	1.084	1.087	1.090	1.092	1.094	1.096	1.089	1.100	1.101	1.103
170	1.064	1.067	1.071	1.074	1.077	1.079	1.081	1.084	1.086	1.087	1.089	1.091	1.092
180	1.053	1.057	1.064	1.069	1.066	1.069	1.071	1.073	1.075	1.077	1.079	1.080	1.082
190	1.043	1.047	1.050	1.053	1.056	1.058	1.061	1.063	1.065	1.067	1.068	1.070	1.072
200	1.032	1.036	1.040	1.043	1.045	1.048	1.050	1.052	1.054	1.056	1.058	1.059	1.061
210	1.022	1.026	1.029	1.032	1.035	1.037	1.040	1.042	1.044	1.046	1.047	1.049	1.051

# WATER SOFTENING AND TREATMENT

TABLE XL.  
PERCENTAGE OF SAVING OF FUEL BY HEATING FEED WATER.

Temperature of Water after Heating.	(Steam at 60 lb. boiler pressure.)																
	INITIAL TEMPERATURE OF WATER.																
	40°	45°	50°	55°	60°	65°	70°	75°	80°	85°	90°	95°	100°	110°	120°	130°	140°
100°	5.11	4.70	4.30	3.88	3.47	3.05	2.63	2.20	1.77	1.33	0.89	0.45	—	—	—	—	—
110	5.96	5.56	5.15	4.74	4.33	3.92	3.50	3.07	2.65	2.22	1.78	1.34	0.90	—	—	—	—
120	6.81	6.41	6.01	5.60	5.20	4.79	4.37	3.95	3.53	3.10	2.66	2.23	1.79	0.90	—	—	—
130	7.67	7.27	6.88	6.47	6.07	5.66	5.25	4.84	4.42	4.00	3.56	3.13	2.70	1.82	0.92	—	—
140	8.52	8.13	7.73	7.33	6.93	6.53	6.12	5.71	5.30	4.88	4.45	4.02	3.59	2.72	1.83	0.92	—
150	9.38	8.99	8.60	8.20	7.81	7.41	7.00	6.60	6.19	5.77	5.34	4.92	4.50	3.63	2.75	1.85	0.94
160	10.23	9.85	9.46	9.07	8.68	8.29	7.89	7.48	7.07	6.66	6.24	5.82	5.40	4.55	3.68	2.78	1.88
170	11.08	10.70	10.32	9.93	9.55	9.15	8.76	8.36	7.95	7.55	7.13	6.71	6.30	5.45	4.59	3.70	2.01
180	11.94	11.57	11.19	10.80	10.42	10.03	9.64	9.24	8.84	8.44	8.02	7.62	7.20	6.36	5.51	4.63	3.74
190	12.80	12.43	12.05	11.67	11.29	10.91	10.52	10.13	9.73	9.33	8.92	8.52	8.11	7.28	6.43	5.56	4.68
200	13.66	13.29	12.92	12.54	12.17	11.79	11.40	11.01	10.62	10.23	9.82	9.42	9.01	8.19	7.35	6.49	5.62
210	14.53	14.16	13.79	13.42	13.05	12.67	12.29	11.91	11.52	11.13	10.72	10.32	9.93	9.11	8.28	7.43	6.57
212	14.69	14.33	13.96	13.59	13.22	12.85	12.47	12.08	11.69	11.30	10.90	10.51	10.10	9.29	8.46	7.61	6.75
220	15.38	15.02	14.66	14.29	13.92	13.55	13.17	12.79	12.41	12.02	11.62	11.23	10.83	10.02	9.20	8.36	7.51
230	16.24	15.89	15.52	15.16	14.79	14.43	14.05	13.68	13.30	12.91	12.52	12.13	11.74	10.99	10.12	9.29	8.44
240	17.10	16.75	16.39	16.03	15.67	15.30	14.93	14.56	14.18	13.81	13.42	13.03	12.64	11.85	11.04	10.22	9.38
250	17.97	17.62	17.26	16.91	16.55	16.19	15.82	15.45	15.08	14.71	14.32	13.94	13.55	12.77	11.97	11.16	10.33
260	18.83	18.49	18.14	17.78	17.43	17.07	16.71	16.35	15.98	15.61	15.22	14.85	14.47	13.69	12.91	12.10	11.28
270	19.69	19.35	19.01	18.66	18.31	17.95	17.59	17.23	16.87	16.50	16.12	15.75	15.37	14.61	13.83	13.03	12.22
280	20.55	20.21	19.87	19.52	19.18	18.83	18.47	18.12	17.76	17.39	17.02	16.65	16.12	15.52	14.75	13.96	13.16
290	21.42	21.08	20.75	20.40	20.06	19.71	19.36	19.01	18.65	18.30	17.92	17.56	17.19	16.44	15.68	14.90	14.10
300	22.28	21.95	21.61	21.27	20.93	20.59	20.25	19.90	19.54	19.19	18.82	18.46	18.09	17.36	16.60	15.82	15.04
310	23.14	22.82	22.49	22.15	21.82	21.48	21.14	20.79	20.44	20.09	19.73	19.37	19.01	18.28	17.53	16.76	15.99
320	24.00	23.68	23.35	23.02	22.69	22.35	22.02	21.67	21.33	20.98	20.62	20.27	19.91	19.19	18.45	17.6	16.93

# APPENDIX

## TABLE XLI.

SATURATED STEAM : TEMPERATURE PRESSURE TABLE.

Temp. F.	Absolute Pressure in lb. per sq. in.	Temp. F.	Absolute Pressure in lb. per sq. in.	Temp. F.	Absolute Pressure in lb. per sq. in.
60	•26	87	•63	114	1•42
61	•26	88	•65	115	1•46
62	•27	89	•67	116	1•50
63	•28	90	•69	117	1•55
64	•29	91	•71	118	1•59
65	•30	92	•74	119	1•64
66	•31	93	•76	120	1•68
67	•32	94	•78	121	1•73
68	•33	95	•81	122	1•78
69	•35	96	•83	123	1•83
70	•36	97	•86	124	1•88
71	•37	98	•89	125	1•93
72	•38	99	•91	126	1•98
73	•40	100	•94	127	2•04
74	•41	101	•97	128	2•10
75	•42	102	1•00	129	2•15
76	•44	103	1•03	130	2•21
77	•45	104	1•06	131	2•27
78	•47	105	1•09	132	2•33
79	•49	106	1•13	133	2•40
80	•50	107	1•16	134	2•46
81	•52	108	1•19	135	2•52
82	•53	109	1•23	136	2•59
83	•55	110	1•27	137	2•66
84	•57	111	1•30	138	2•73
85	•59	112	1•34	139	2•80
86	•61	113	1•38	140	2•88

### UNITS, DEFINITIONS AND EQUIVALENTS.

*The British Unit of Work* is the *foot pound* which represents the work done in raising one pound one foot high.

*The Metric Unit of Work* is the *kilogrammetre*.

*Power* is the amount of work performed in a unit of time.

*The Horse-Power* is the unit of power used by British engineers and is equal to 33,000 foot pounds of work per minute.

*The French Horse-Power* is the equivalent of 75 kilogrammetres per second.

1 British Horse-Power = 1•0139 French Horse-Power.

\* Tables and Data. Pullen. Scientific Publishing Co.

## WATER SOFTENING AND TREATMENT

*Indicated Horse-Power* (or pump horse-power) is the measure of work done by the steam in the engine cylinder (or water in the pump cylinder) and is calculated by the aid of the indicator diagram, the data necessary being :—the mean effective pressure in the cylinder, the area and the speed of the piston or bucket. The method of calculation is as follows :—

Let P = The mean effective pressure of steam or water in pounds on the square inch.  
 A = Area of piston in square inches.  
 L = Length of stroke in feet.  
 N = Number of strokes per minute, in double-acting engines or pumps = revs.  $\times$  2.

Then P  $\times$  A = the total mean effective pressure on the piston in pounds,  
 L  $\times$  N = the distance in feet through which the piston moves in one minute (or piston speed),  
 and PA  $\times$  LN = the number of foot-pounds of work done per minute which, divided by one horse-power, or 33,000 foot-pounds.

$$\frac{PA \times LN}{33,000}$$

gives the indicated Horse-Power developed by the engine or absorbed by a pump as shown on the Indicator diagram.

*Indicated Horse-Power* is the external or useful work done by the engine, plus the power to overcome the frictional resistances of the engine itself.

*Brake Horse-Power* represents the external or useful work done by the engine, or the *Indicated Horse-Power* less the power absorbed to drive the engine itself.

*Thermal Efficiency*.—The thermal efficiency of an engine is the ratio of the amount of heat energy used in doing work, to the total amount of heat energy received by the engine.

*The Mechanical Efficiency* of the engine is the ratio of the useful work to the total work done and equals  $\frac{\text{BHP.}}{\text{IHP.}}$

“Heat is a form of molecular energy, and it may be converted into mechanical work by means of the change of volume which it produces in bodies acted upon by it.”—(*Ripper*.)

“Heat, given to a substance and warming it, is said to be ‘sensible’ in the substance. Heat, given to a substance and not warming it, is said to become latent.”—(*Sir W. Thomson*.)

“*Latent Heat*, is the quantity of heat which must be communicated to a body in a given state, in order to convert it into another state without changing its temperature.”—(*Maxwell*, “*Theory of Heat*.”)



## APPENDIX

*Units of Heat.*—The *British Thermal Unit* (B.Th.U.) is the standard unit adopted in this country, and is the heat required to raise one pound of water through one degree Fahrenheit, measured by some at the standard temperature of 60° F. but Rankine says at or near 39·1° F. = 4° C. or the temperature of maximum density.

The mechanical equivalent of the B.Th.U., as determined by Rowlands, after Joule, is 778 foot pounds or units of work, at 60° F.

The *Metric Thermal Unit* is the *Calorie* and represents the heat required to raise one kilogram of water one degree Celsius or Centigrade.

1 B.Th.U. = 0·252 Calorie.

1 Calorie = 3·968 B.Th.U.

1 Calorie = 3087 foot pounds,

*Specific Heat*, or capacity for heat, is the ratio of the quantity of heat required to raise one pound weight of a given substance through one degree Fahrenheit, water, at the standard temperature of 60° F., being the standard of comparison.

TABLE OF SPECIFIC HEATS.

		Constant Pressure	Constant Volume.
Water at 60° F. = 1·000.	Steam at 212° F. = 0·480	= 0·346.	
Ice at 32° F. = 0·504.	Air . . . = 0·217	= 0·168.	
Iron, cast . . = 0·130.	Hydrogen . . = 3·410	= 2·410.	
Iron, wrought = 0·113.	Oxygen . . . = 0·217	= 0·155.	
Steel . . . . = 0·116.	Nitrogen. . . = 0·244	= 0·173.	
Copper . . . . = 0·095.			

*Temperature.*—“The temperature of a body is its thermal state considered with reference to its power of communicating heat to other bodies.” (*Maxwell.*) Temperature determines the intensity of heat in bodies.

*First Law of Thermodynamics.*—“Heat and Mechanical energy are mutually convertible, and heat requires for its production and produces by its disappearance, a definite number of units of work for each thermal unit.”

*Second Law of Thermodynamics.*—“Heat cannot pass from a cold body to a hot one by a purely self-acting process.”—(*Clausius.*)

The operation of this law is shown by the action of the steam in the cylinder. The steam at admission is hotter than the metals and gives up heat to equalize the temperatures, at exhaust the metals are hotter than the steam and return heat to it.

*Evaporation* represents the total weight of water evaporated into steam at any given pressure, divided by the net weight of

## WATER SOFTENING AND TREATMENT

dry fuel required to do the work and is expressed :— $x$  lb. steam per lb. fuel.

*Equivalent evaporation from and at 212° F.*—For purposes of comparison, evaporation results in trials of boilers are reduced to one common standard, which is the number of pounds of water which the same expenditure of heat-units would evaporate into steam at 212° F., from water at 212° F. The amount of heat-units required to evaporate one pound of water at 212° F. into steam at 212° F., is 966 B.Th.U. The total heat of evaporation at a given pressure is  $H$ —(the heat of the feed—32), and therefore :

$$\frac{H - (\text{temp. feed} - 32)}{966} =$$

equivalent evaporation from and at 212° F.

For superheated steam, add the heat units required to raise the temperature from that normal to the pressure to the temperature of superheat, or  $(T_s - T_l) \times 0.48$ .

*Coal* is composed of Carbon, Hydrogen, Oxygen, Nitrogen, Sulphur, Ash and Water in various proportions. M. Mahler in his work, *Contributions à l'Etudes des Combustibles*, gives the following formula for ascertaining the heating value of the fuel :  
 $14,500 C + 62,100 H - 5,400 (O + N) = \text{heating value in B.Th.U.}$

*Efficiency* of the steam generating plant is the ratio of the heat units usefully employed in the generation of steam, as shown by the evaporative result, to the total heat units supplied in the fuel thrown on the furnaces.

The heating value of the coal having been ascertained in B.Th.U., is divided by 966 B.Th.U., and this gives the number of pounds, which the total heat of the fuel would evaporate from and at 212° F.

*Absolute* pressure is reckoned from Zero or Vacuum. On the vacuum gauge this is represented by 30 inches of mercury, or 14.7 lb. below atmospheric pressure.

*Boiler* or gauge pressure is that above the pressure of the atmosphere which is 14.7 lb. on the square inch.

Absolute pressure — 14.7 = boiler pressure.

Boiler pressure + 14.7 = absolute pressure.

### THERMOMETER SCALES.

32° Fahrenheit = 0° Centigrade = 0° Réaumur.

212°           "           = 100°           "           = 80°           "

(Degrees Fahr. — 32)  $\times \frac{5}{9}$  = Degrees Centigrade.

(Degrees Fahr. — 32)  $\times \frac{5}{9}$  = Degrees Réaumur.

(Degrees Centig.  $\times \frac{9}{5}$ ) + 32 = Degrees Fahr.

(Degrees Réaum.  $\times \frac{9}{4}$ ) + 32 = Degrees Fahr.

## APPENDIX

### “ECONOMIZERS.”

To ascertain the gain effected by the use of “economizers,” i.e., feed-water-heaters, wherein the increase in temperature is obtained from the waste gases, after leaving the boiler; or from exhaust steam; the following rule will serve:—

$$100 \times \left\{ \frac{\left\{ \begin{array}{l} \text{Temperature of feed} \\ \text{leaving the} \\ \text{“economizers”} \end{array} \right\} - \left\{ \begin{array}{l} \text{Temperature of feed} \\ \text{entering the} \\ \text{“economizers”} \end{array} \right\}}{\left\{ \begin{array}{l} \text{Total heat of steam at} \\ \text{boiler pressure reckoned} \\ \text{from } 0^{\circ} \text{ Fahr.} \end{array} \right\}} - \left\{ \begin{array}{l} \text{Temperature of feed} \\ \text{entering the} \\ \text{“economizers”} \end{array} \right\} \right\} = \text{gain per cent.} \\ \text{effected.}$$

### PROPERTIES OF SATURATED STEAM.

Rankine gives the relation between temperature and pressure of dry saturated steam with great accuracy, as follows:—

$$\log p = A - \frac{B}{T} - \frac{C}{T^2}$$

where  $p$  represents the absolute pressure in pounds per square inch,

$$\begin{aligned} A &= 6.1007 \\ \log B &= 3.43642 \\ \log C &= 5.59873 \end{aligned}$$

$T$  = absolute temperature on the Fahrenheit scale, or  $t + 461.2$ .

If  $T$  be the Centigrade scale,

$$\begin{aligned} \text{then} \quad A &= 6.1007 \\ \log B &= 3.1812 \\ \log C &= 5.0871 \end{aligned}$$

The following table (XLII.) by Professor Peabody shows the accuracy of Rankine's equation as compared with Regnault's experiments.

TABLE XLII.

Temperature F.	Pressure in lb. per sq. in.	
	Experiment.	Rankine's Equation.
32	.089	.083
77	.455	.452
122	1.779	1.78
167	5.579	5.58
212	14.697	14.7
302	69.27	69.21
392	225.56	225.9
428	336.26	336.3

## WATER SOFTENING AND TREATMENT

*Specific Heat.*—*Specific heat* is the heat required to raise 1 lb. water from freezing point to the given temperature. The specific heat of water is not constant. The value of the specific heat  $S$  is given with fair accuracy by the equation

$$S = t + \cdot 00002 t^2 + \cdot 0000003 t^3$$

when  $t$  is the temperature Centigrade.

Or 
$$S = t - 32 + \cdot 000000103 (t - 39)^3$$

for the Fahrenheit scale.

The specific heat at any temperature  $t^\circ$  is  $\frac{dS}{dt} = 1 + 2at + 3\beta t^2$ ,

where  $S = t + at^2 + \beta t^3$  = the specific heat at the temperature  $t^\circ$ . Or consider any two temperatures  $t_1$  and  $t_2$ ; then heat added between these temperatures =  $S_2 - S_1 = t_2 - t_1 + a(t_2^2 - t_1^2) + \beta(t_2^3 - t_1^3)$  and the mean specific heat

$$= \frac{S_2 - S_1}{t_2 - t_1} = 1 + a(t_2 + t_1) + \beta(t_2^2 + t_1 t_2 + t_1^2).$$

On the Fahrenheit scale it is,  $1\cdot 00047 + \cdot 000000103$

$$[t_2^2 + t_1 t_2 + t_1^2 - 117(t_2 + t_1)].$$

Reasoning from Rowland's recent results on the mechanical equivalent of heat, Professor Peabody has shown the above to be not quite accurate.

*Latent Heat* is the number of British thermal units required to convert 1 lb. water into dry saturated steam without change of temperature. Latent heat consists of two parts: the external work done during evaporation and the actual intrinsic heat possessed by the steam in virtue of its conversion into steam, and equal to latent heat *minus* the heat equivalent of the external work done by the steam during evaporation; or,

$$L - \frac{Pu}{J}$$

where  $P$  is the pressure per square foot under which the steam was formed;  $u$  the increase in volume of water and steam in cubic feet during evaporation, and  $J$ , Joule's mechanical equivalent of heat, which is now taken as 778 foot pounds, or 426·9 calories.

Approximate expression for internal latent heat is

$$575\cdot 4 - \cdot 791 t$$

where  $t$  is the temperature of evaporation on the Centigrade scale; and

$$1062 - \cdot 79 t$$

on the Fahrenheit scale.

An empirical equation for latent heat  $L$  is

$$L = 1115 - \cdot 7 t \text{ on the Fahr. scale.}$$

or 
$$L = 607 - \cdot 7 t \text{ on the Cent. scale.}$$



## APPENDIX



Professor Unwin's equation for the latent heat on the Centigrade scale is

$$L = 779 - \frac{894}{(7.503 - \log p)^3}$$

which is very accurate where  $p$  is the corresponding pressure of evaporation in pounds per square inch.

*Total Heat.*—The total heat  $H$  required to raise the temperature of 1 lb. of water from  $32^\circ$  Fahr. to a given temperature, and evaporate it at that temperature is the sum of the sensible heat, the internal latent heat, and the external latent heat :

$$H = S + L$$

or

$$H = 1082 + .305 t$$

when  $t$  the temperature of evaporation Fahrenheit or

$$H = 606.5 + .305 t$$

for  $t$  on the Centigrade scale.

*External Work.*—The work done by the steam during formation, is called the *external latent heat*. It is approximately  $52 + .091 t$  thermal units or on the Centigrade scale  $30.6 + .091 t$  thermal units.

*Specific Volume.*—The specific volume or volume of 1 lb. of dry saturated steam at different pressures can be calculated thus—

$$\frac{dP}{dT} = \frac{L}{T u} = \frac{L}{T(v - \delta)}$$

where  $v$  = specific volume of 1 lb. steam and  $\delta$  = volume of 1 lb. water = .016 cubic feet.

For rough purposes the equation  $p u^{1.0646} = 479$  can be used, when  $u = v - \delta$  and  $p$  = pounds per square inch of pressure.

For a fuller treatment of these matters see Tables and Data by Pullen. Scientific Publishing Co.

# Appendix No. 6.

## ELECTRICAL OIL SEPARATION

THE accompanying illustration shows how the problem of oil separation from greasy water has been electrically attacked by the Davis-Perrett system. The air pump discharge, as hot

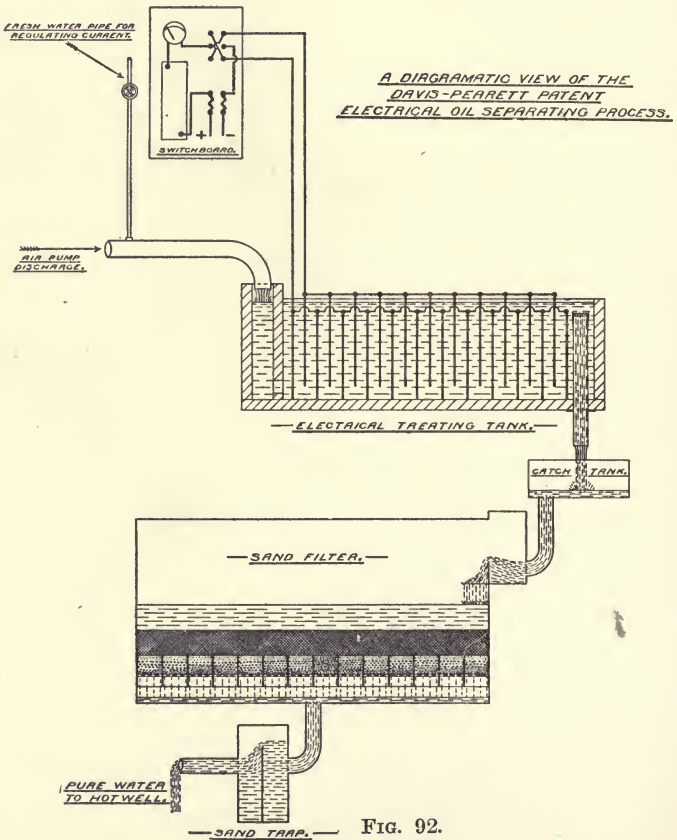

FIG. 92.

## APPENDIX

as it can be obtained, is passed through a tank divided up into sections, each section being again divided by iron plates. The plates are then connected so that the potential is about 40 to 50 volts across each element. At the Leicester Corporation Tramway station there are five plates in parallel and ten in series across a 500 volt circuit; this plant will deal with 6,000 gallons per hour and consumes about 12 amperes or 6 units. The plates last it is said two or three years and when covered with deposit they are cleaned by reversing the current when the deposit rises and can be removed. Grooves are cut into the partitions dividing off the compartments and, the plates being inserted in these grooves, are rigidly supported. Iron rods, screwed their entire length, are used for connecting the plates together electrically. The whole apparatus is supported on insulators, and the liquid to be treated is divided into two streams at one end of the tanks; it then passes into the tanks and through each set of compartments in five parallel streams. Alternate plates are cut as shown by the drawing so that the liquid passes under one plate and over the next alternately and circulation is so ensured over the full surface of the plates. It is said that the air-pump discharge has a high ohmic resistance but that the addition of a small quantity of fresh water at once enables the liquid to conduct current and this additional water may of course be added in the form of make-up water. The action of the electric current is to cause the emulsified oil to coalesce so that it will separate out by gravity, but, to save space, it is mechanically filtered. Sand (or in some cases wood shavings tightly packed between perforated iron plates, and oak sawdust) is used for filtering. The iron plates are gradually destroyed, a brown oxide being formed and this, which is a hydrated peroxide, is collected with the oil and forms with it a flocculent substance. Whether the oxide is essential to the process is not certain, but the result of the process is a clean and bright water free from oil. The space occupied varies from 100 square feet per 1000 gallons per hour up to 290 square feet for 8,000 gallons or approximately it would appear  $S = 100\sqrt{N}$ , where  $S$  = square feet of space and  $N$  = number of thousands of gallons per hour. The head room is 15 to 20 feet.





# INDEX

## A

Acid, 101, 105  
— water, 139  
Air, hygrometry of, 256  
Air and circulating pumps, 211, 213  
Air pump, 149, 194  
— — bucket, 199  
— — combined, with circulating pump, 211, 213  
— — compound, 213  
— — Davy Paxman, 204  
— — diagrams, 208  
— — direct steam-driven, 212  
— — Edwards, 201  
— — ejector, 206  
— — forms of, 200  
— — Hick Hargreaves, 207  
— — horizontal, 209  
— — Mirrlees Watson, 203  
— — rotative, 216  
— — Storey & Sons, 203  
— — tail rod, 210  
— — two-stage jet augmentor, 215  
— — types of, 201  
— — working of, 195  
Air, solubility of, in water, 289  
Alum, 28, 34, 94  
Analysis of water, 35, 43  
Angus Smith, Dr., 22, 107, 123  
Apparatus, commercial, 44, 48  
Archbutt-Deeley system, 48  
Areas of circles, 275  
Atmospheric evaporator, 260  
— valve, 190  
Augmentor, 214

## B

Baker softener, 63  
Barium aluminate, 26

Barium carbonate, 30  
— hydrate, 30  
Barometer, 153, 198, 276  
Boiler cleaners, 119  
— cleaning, 5, 100  
— compounds, 96, 98  
— — French, 97  
— cooling, 5  
Boiling point of salt solutions, 142  
Borings, deep, 10  
Brackett's, condenser, 187  
Bruun Lowener softener, 68  
Bucket, air pump, 199  
Buxton lime, 22

## C

Capacity of condensers, 160  
Carbonate of lime, 13, 19  
— magnesia, 15, 20  
— soda, 23  
Carrod softener, 78  
Caustic lime, 18, 19  
— soda, 24, 25, 126  
Centrifugal pump, 218  
Chalk lime, 22  
— water, 10, 123  
Chemicals, 103  
Chemical oil separation, 113  
Chevalet Boby detartariser, 83  
Circles, areas of, 275  
Circulating pump, 211, 213, 218  
— — Hick Hargreaves, 219  
— — Pulsometer Co.'s, 219  
— water, 25, 177  
Clarke's process, 17, 125  
Cleaners, mechanical boiler, 119  
Coagulation, 94  
Coefficient of contraction, 220  
Cooling surface, 168  
— pond, 258  
— towers, 260

## INDEX

- Cooling water, 255, 259  
 Condenser, 154, 170, 173  
 — atmospheric, 163  
 — Brackett's, 187  
 — calculations, 164  
 — capacity of, 160  
 — counter-current, 186, 187  
 — ejector, 162  
 — evaporative, 186  
 — Ledward, 175, 184  
 — plant design, 164  
 — Storey, 176  
 — surface, 189  
 — varieties of, 160  
 — vertical, 176  
 — Wheeler, 174  
 — Worthington, 173  
 Counter-current condenser, 186, 187  
 Cruse feed heater, 235
- D
- Definitions, 295  
 Desrumeaux softener, 70  
 Design of condensing plant, 164  
 Detartarisers, 83  
 Displacement pump, 219  
 Doctor Angus Smith, 22  
 Dorking lime, 22  
 Doulton softener, 57
- E
- Economizers, 223, 229  
 — pure water, 234  
 Economy, 6  
 — of condensing, 71  
 — feed heating, 294  
 Edward's air pump, 195, 201  
 Ejector condenser, 162  
 Electrical oil separator, 302  
 Equivalence of water and mercury, 291  
 Equivalent, 295  
 Evaporator, atmospheric, 260  
 Evaporation temperature of salt solutions, 142  
 — factors of, 293  
 — from ponds, 259  
 Examples of condensers, 173  
 Exhaust injector, 284, 286  
 — pipes, 166
- F
- Factors of evaporation, 293  
 Fan cooling tower, 262  
 Fan heating, 223  
 Feed heater, Paterson, 86  
 — — Tray, 242  
 — — Weir, 84  
 — heating in stages, 237, 244  
 — pumps, 271, 278, 280, 281, 282  
 Flow of water in pipes, 277  
 Floury deposit, 21  
 Flue feed heater, 223  
 Filters, 88, 90, 93  
 — rapid, 93  
 — Reisert, 95  
 Filtering media, 85  
 Filtration, 4  
 Fromentin boiler feeder, 283  
 Fully-heated feed, 235
- G
- Gallon, standard, 274  
 Galvanic action, 105  
 Gases, solubility of, 172  
 General design, 164  
 Geological considerations, 8  
 Grease, 21, 33, 105  
 — separation, 109, 113  
 Guttman's softener, 60  
 Gypsum water, 123
- H
- Hard water, 37, 39  
 Heat, 149, 151, 295  
 — effect, 4, 29  
 — latent, 150  
 — specific, 149  
 — unit of, 151  
 High vacuum, 177  
 Hotchkiss cleaner, 119  
 Hygrometry of air, 256
- I
- Incrustation in condensers, 171  
 — pipes, 107  
 Injector, 284  
 — capacity of, 288  
 — combined, 285  
 — exhaust, 284, 286

# INDEX

## L

- Latent heat, 150, 300
- Law of mixed vapours, 155
- Lead pipes, 108
- Lime carbonate, 13, 19
  - caustic, 18, 19
  - fat, 22
  - milk of, 23
  - solubility of, 46
  - sulphate, 15, 34
  - unsuitable, 22
  - water, 23
- Low pressure steam, 155

## M

- Magnesia, 24
  - carbonate of, 15, 20
  - sulphate of, 16
- Mechanical boiler cleaners, 119
- Mixed vapour, 155

## N

- Nozzles, spray, 267

## O

- Oil separation, 109, 113, 302
- Organic matter, 33
- Oxalate of soda, 27

## P

- Paterson feed heater, 86
  - oil separator, 114
  - softener, 79
- Pipes, exhaust, 166
  - flow in, 277
  - incrustation in, 107
  - silted, 165
- Pond, cooling, 258
- Position of condensing plant, 217
- Potash, 25, 108
- Pressure and head of water, 273
- Properties of water, 144
- Pure water, 121
- Pump, air. *See* Air Pump.
- Pump, capacity of, 280, 283
  - circulating, 218
  - direct-acting, 280
  - feed, 271
  - flywheel, 282

- Pump, suction lift of, 276
  - Weir, 278
  - Worthington, 280

## R

- Reagents, 19, 27
- Recarbonization, 21
- Reisert filter, 95
  - softener, 65
- Reservoirs, 258
- Retaining wall, 91

## S

- Salts in water, 13, 142, 144
  - reactions of, 19
  - solutions, boil, 142
- Sand, 93
  - filters, 90
- Saturated steam table, 295, 299
- Scale effects, 32, 34
- Settling ponds, 90
- Softened water tests, 50, 63
- Softening by soap, 5
  - systems, 17
- Soap softening, 5
  - solutions, 36
- Soda, 23, 27
- Sodium chloride, 17
- Silicate of soda, 27
- Silt in pipes, 165
- Smith, Dr. Angus, 22
- Solubility of air, 289
  - gases, 41, 140, 172
  - lime, 46
  - salts, 142, 144
- Space occupied by apparatus, 75
- Specific heat, 49
  - — of water, 241, 300
- Spray nozzles, 267
- Stage feed heating, 237, 244
- Standard hard water, 37
- Stanhope softener, 73
- Steam, properties of, 155
  - table, 295
  - velocity of, 167
- Stromeyer on softening, 24
- Suction lift of pumps, 276
- Sulphate of lime, 15, 34
  - magnesia, 16
- Surface condenser, 189

## INDEX

- T  
Temperature, 149  
— of evaporation, 142  
Tension of water vapour, 281  
Tests of softened water, 50, 63  
Thermometer scales, 298  
Towers, cooling, 260  
Tubular feed heaters, 239  
Turbulent flow, 161
- U  
Units, 295  
— of heat, 151  
— work, 151
- V  
Vacuum, high, 177  
— steam table, 292  
Vapours, mixed, 155  
— pressure, 292  
— specific gravity of, 290  
— tension of, 289, 290  
— volume of, 290  
Velocity of steam, 167
- W  
Walls, retaining, 91  
Water acid, 139  
Water and mercury, equivalent of, 291  
— as affected by geological chalk, 123  
— corrections, 8  
Water, circulating, 177, 257  
— cooling, 255  
— effects of pure, 4  
— flow in pipes of, 277  
— for condensation, 158  
— hard, 37, 39  
— its sources, 7  
— pressure and head, 273  
— properties of, 17, 144  
— pure, 121  
— river, 9  
— salts in, 13  
— sea, 145  
— soft, 9  
— soluble powers of, 41  
— specific gravity of, 290  
— — heat of, 241  
— tension of vapour, 289, 290  
— vapour density, 290  
— weight per cubic foot, 144  
Weir feed heater, 84  
Wollaston softener, 76  
Work, unit of, 151





*Catalogue of Scientific Publications*  
*and Importations of the D. Van Nostrand Company,*  
*23 Murray Street and 27 Warren Street, New York.*

---

A B C CODE. (See Clausen-Thue.)

ABBOT, H. L., Gen'l. The Defence of the Seacoast of the United States. Lectures delivered before the U. S. Naval War College. 8vo, red cloth. . . . . \$2.00

ABBOTT, A. V. The Electrical Transmission of Energy. A Manual for the Design of Electrical Circuits. *New edition, revised, and entirely rewritten.* Fully illustrated. 8vo, cloth, *net*, \$5.00

ADAM, P. Practical Bookbinding. With illustrations and figures. Translated from the German by Thomas E. Maw. 8vo, cloth, illustrated. . . . . *net*, \$2.50

ADAMS, J. W. Sewers and Drains for Populous Districts. Embracing Rules and Formulas for the dimensions and construction of works of Sanitary Engineers. 8vo, cloth. . . . \$2.50

ADDYMAN, F. T. Practical X-Ray Work. Part I, Historical. Part II, Apparatus and its Management. Part III, Practical X-Ray Work. Illustrated with twelve plates from photographs. 8vo, cloth, illustrated. . . . . *net*, \$4.00

A 1 CODE. (See Clausen-Thue.)

AIKMAN, C. M., Prof. Manures and the Principles of Manuring. 8vo, cloth. . . . . \$2.50

ALEXANDER, J. H. Universal Dictionary of Weights and Measures, Ancient and Modern, reduced to the Standards of the United States of America. *New Edition, enlarged.* 8vo, cloth. . . . . \$3.50

ALEXANDER, S. A. Broke Down: What Should I Do? A Ready Reference and Key to Locomotive Engineers and Firemen, Round-house Machinists, Conductors, Train Hands and Inspectors. With 5 folding plates. 12mo, cloth. . . . . \$1.50

**ANDERSON, G. L., A.M. (Captain of U. S. Artillery).**

Handbook for the use of Electricians in the operation and care of Electrical Machinery and Apparatus of the United States Seacoast Defenses. Prepared under the direction of the Lieutenant-General Commanding the Army. With tables, diagrams and illustrations. 8vo, cloth, illustrated. . . . . \$3.00

**ANDERSON, J. W. Prospector's Handbook. A Guide**

for the Prospector and Traveller in search of Metal-bearing or other Valuable Minerals. *Eighth Edition, revised.* 8vo, cloth. . . . \$1.50

**ANDERSON, W. On the Conversion of Heat into Work.**

A Practical Handbook on Heat-engines. *Third Edition.* Illustrated. 12mo, cloth. . . . . \$2.25

**ANDÉS, L. Vegetable Fats and Oils: Their Practical**

Preparation, Purification and Employment for Various Purposes. Their Properties, Adulteration and Examination. A Handbook for Oil Manufacturers and Refiners, Candle, Soap and Lubricating-oil Manufacturers, and the Oil and Fat Industry in general. Translated from the German. With 94 illus. 8vo, cloth. . . . net, \$4.00

**— Animal Fats and Oils. Their Practical Production,**

Purification and Uses for a great variety of purposes; their Properties, Falsification and Examination. A Handbook for Manufacturers of Oil and Fat Products, Soap and Candle Makers, Agriculturists, Tanners, etc. Translated by Charles Salter. With 62 illustrations. 8vo, cloth. . . . . net, \$4.00

**— Drying Oils, Boiled Oil, and Solid and Liquid Driers.**

A practical work for manufacturers of Oils, Varnishes, Printing Inks, Oilcloth and Linoleum, Oil-cakes, Paints, etc. 8vo, cloth, illustrated. . . . . net, \$5.00

**— Iron Corrosion, Anti-fouling and Anti-corrosive**

Paints. Translated from the German by Charles Salter. Illustrated with engravings and half-tone cuts. 8vo, cloth. . net, \$4.00

**— Oil Colors, and Printers' Ink. A Practical Hand-**

book treating of Linseed-oil, Boiled Oil, Paints, Artists' Colors, Lampblack, and Printers' Inks (black and colored). Translated from the German by Arthur Morris and Herbert Robson. With 56 figures and diagrams. 8vo, cloth, 212 pages. . . . net, \$2.50

**ANNUAL REPORTS on the Progress of Chemistry for 1904.**

Vol. I. Issued by the Chemical Society. 8vo, cloth. . net, \$2.00

Vol. II (1905). 8vo, cloth. . . . . net, \$2.00

- ARNOLD, E.** Armature Windings of Direct-Current Dynamos. Extension and Application of a General Winding Rule. Translated from the original German by Francis B. DeGress, M.E. With numerous illustrations. 8vo, cloth... \$2.00
- ARNOLD, R., Dr.** Ammonia and Ammonium Compounds. A Practical Manual for Manufacturers, Chemists, Gas Engineers and Drysalters. *Second Edition.* 12mo, cloth.... \$2.00
- Art of Dyeing Wool, Silk and Cotton.** Translated from the French of M. Hellott, M. Macquer and M. Le Pileur D'Apligny. First published in English in 1789. 8vo, cloth, illustrated, *net*, \$2.00
- ASHE, S. W., and KEILEY, J. D.** Electric Railways, Theoretically and Practically Treated; Rolling Stock. With numerous figures, diagrams, and folding plates. 12mo, cloth, illustrated. .... *net*, \$2.50  
— Vol. 2. Sub-stations and the Distributing System..... *In Press.*
- ATKINSON, A. A., Prof. (Ohio University).** Electrical and Magnetic Calculations, for the use of Electrical Engineers and Artisans, Teachers, Students and all others interested in the Theory and Application of Electricity and Magnetism. *Second Edition, revised.* 8vo, cloth, illustrated. .... *net*, \$1.50
- ATKINSON, P.** The Elements of Electric Lighting, including Electric Generation, Measurement, Storage and Distribution. *Tenth Edition, fully revised and new matter added.* Illustrated. 12mo, cloth..... \$1.50  
— The Elements of Dynamic Electricity and Magnetism. *Fourth Edition.* 120 illustrations. 12mo, cloth. . \$2.00  
— Power Transmitted by Electricity and its Application by the Electric Motor, including Electric Railway Construction. *Fourth Edition, fully revised, new matter added.* 12mo, cloth, illustrated..... \$2.00
- AUCHINCLOSS, W. S.** Link and Valve Motions Simplified. Illustrated with 29 woodcuts and 20 lithographic plates, together with a Travel Scale, and numerous useful tables. *Fourteenth Edition, revised.* 8vo, cloth. .... \$2.00
- AYRTON, H.** The Electrical Arc. With numerous figures, diagrams and plates. 8vo, cloth, illustrated. .... \$5.00
- AYRTON, W. E., M.I.C.E.** Practical Electricity. A Laboratory and Lecture Course for the first-year students of Electrical Engineering, based on the International Definitions of the Electrical Units. Vol. I, Current, Pressure, Resistance, Energy, Power, and Cells. Completely rewritten and containing many figures and diagrams. 12mo, cloth. .... \$2.00

- BACON, F. W.** A Treatise on the Richards Steam-engine Indicator, with directions for its use. By Charles T. Porter. Revised, with notes and large additions as developed by American practice; with an appendix containing useful formulæ and rules for engineers. Illustrated. *Fourth Edition.* 12mo, cloth. \$1.00
- BAKER, Arthur L., Prof. (Univ. of Rochester).** Quaternions . . . . . *In Press.*
- BAKER, M. N.** Potable Water and Methods of Detecting Impurities. *New Edition, revised and largely rewritten.* 16mo, cloth. (*Van Nostrand's Science Series*) . . . . . \$0.50
- BALCH, G. T., Col.** Methods of Teaching Patriotism in the Public Schools. 8vo, cloth. . . . . \$1.00
- BALE, M. P.** Pumps and Pumping. A Handbook for Pump Users. 12mo, cloth. . . . . \$1.50
- BALL, S. R.** Popular Guide to the Heavens. A series of eighty-three plates, many of which are colored and lithographed, with explanatory text and index. Small 4to, cloth, illustrated. *net*, \$4.50
- BARBA, J.** The Use of Steel for Constructive Purposes. Method of Working, Applying and Testing Plates and Bars. With a Preface by A. L. Holley, C.E. 12mo, cloth. . . . . \$1.50
- BARKER, A. H.** Graphic Methods of Engine Design. Including a Graphical Treatment of the Balancing of Engines. 12mo, cloth. . . . . \$1.50
- BARNARD, F. A. P.** Report on Machinery and Processes of the Industrial Arts and Apparatus of the Exact Sciences at the Paris Universal Exposition, 1867. 152 illustrations and 8 folding plates. 8vo, cloth. . . . . \$5.00
- BARNARD, J. H.** The Naval Militiaman's Guide. Full leather, pocket size . . . . . \$1.25
- BARRUS, G. H.** Boiler Tests: Embracing the Results of one hundred and thirty-seven evaporative tests, made on seventy-one boilers, conducted by the author. 8vo, cloth. \$3.00
- **Engine Tests: Embracing the Results of over one hundred feed-water tests and other investigations of various kinds of steam-engines, conducted by the author. With numerous figures, tables, and diagrams.** 8vo, cloth, illustrated. . \$4.00  
The above two purchased together. . . . . \$6.00



- BARWISE, S., M.D. (London).** *The Purification of Sewage.* Being a brief account of the Scientific Principles of Sewage Purification and their Practical Application. 12mo, cloth, illustrated. *New Edition*.....net, \$3.50
- BEAUMONT, R.** *Color in Woven Design.* With 32 colored plates and numerous original illustrations. Large, 12mo..... \$7.50
- **W. W.** *Practical Treatise on the Steam-engine Indicator, and Indicator Diagrams.* With notes on Engine Performances, Expansion of Steam, Behavior of Steam in Steam-engine Cylinders, and on Gas- and Oil-engine Diagrams. *Second Edition, revised and enlarged.* 8vo, cloth, illustrated...net, \$2.50
- BEECH, F.** *Dyeing of Cotton Fabrics. A Practical Handbook for the Dyer and Student.* Containing numerous recipes for the production of Cotton Fabrics of all kinds, of a great range of colors, thus making it of great service in the dye-house, while to the student it is of value in that the scientific principles which underlie the operations of dyeing are clearly laid down. With 44 illustrations of Bleaching and Dyeing Machinery. 8vo, cloth, illustrated.....net, \$3.00
- *Dyeing of Woolen Fabrics.* With diagrams and figures. 8vo, cloth, illustrated.....net, \$3.50
- BECKWITH, A.** *Pottery. Observations on the Materials and Manufacture of Terra-cotta, Stoneware, Firebrick, Porcelain, Earthenware, Brick, Majolica, and Encaustic Tiles.* *Second Edition.* 8vo, paper..... .60
- BEGTRUP, J., M.E.** *The Slide Valve and its Functions.* With Special Reference to Modern Practice in the United States. With numerous diagrams and figures. 8vo, cloth..... \$2.00
- BERNTHASEN, A.** *A Text-book of Organic Chemistry.* Translated by George M'Gowan, Ph.D. *Fifth English Edition,* revised and extended by author and translator. Illustrated. 12mo, cloth..... *In Press.*
- BERRY, W. J.** *Differential Equations of the First Species.* 12mo, cloth, illustrated..... *In Press.*

- BERSCH, J., Dr.** **Manufacture of Mineral and Lake Pigments.** Containing directions for the manufacture of all artificial artists' and painters' colors, enamel colors, soot and metallic pigments. A text-book for Manufacturers, Merchants, Artists and Painters. *Translated from the second revised edition* by Arthur C. Wright, M.A. 8vo, cloth, illustrated. . . . *net*, \$5.00
- BERTIN, L. E.** **Marine Boilers: Their Construction and Working,** dealing more especially with Tubulous Boilers. Translated by Leslie S. Robertson, Assoc. M. Inst. C. E., M. I. Mech. E., M.I.N.A., containing upward of 250 illustrations. Preface by Sir William White, K.C.B., F.R.S., Director of Naval Construction to the Admiralty, and Assistant Controller of the Navy. *Second Edition, revised and enlarged.* 8vo, cloth, illustrated. *net*, \$5.00
- BIGGS, C. H. W.** **First Principles of Electricity and Magnetism.** A book for beginners in practical work, containing a good deal of useful information not usually to be found in similar books. With numerous tables and 343 diagrams and figures. 12mo, cloth, illustrated. . . . \$2.00
- BINNS, C. F.** **Ceramic Technology. Being Some Aspects of Technical Science as applied to Pottery Manufacture.** 8vo, cloth. . . . *net*, \$5.00
- **Manual of Practical Potting. Compiled by Experts.** *Third Edition, revised and enlarged.* 8vo, cloth. . . . *net*, \$7.50
- BIRCHMORE, W. H., Dr.** **How to Use a Gas Analysis.** 12mo, cloth, illustrated. . . . *net*, \$1.25
- BLAKE, W. H.** **Brewer's Vade Mecum. With Tables and marginal reference notes.** 8vo, cloth. . . . *net*, \$4.00
- **W. P. Report upon the Precious Metals. Being Statistical Notices of the Principal Gold and Silver producing regions of the world, represented at the Paris Universal Exposition.** 8vo, cloth. . . . \$2.00
- BLAKESLEY, T. H.** **Alternating Currents of Electricity.** For the use of Students and Engineers. *Third Edition, enlarged.* 12mo, cloth. . . . \$1.50
- BLYTH, A. W., M.R.C.S., F.C.S.** **Foods: Their Composition and Analysis.** A Manual for the use of Analytical Chemists, with an Introductory Essay on the History of Adulterations. With numerous tables and illustrations. *Fifth Edition, thoroughly revised, enlarged and rewritten.* 8vo, cloth. . . . \$7.50

- BLYTH, A. W., M.R.C.S., F.C.S.,** *Poisons: Their Effects and Detection.* A Manual for the use of Analytical Chemists and Experts, with an Introductory Essay on the Growth of Modern Toxicology. *New Edition*..... *In Press.*
- BODMER, G. R.** *Hydraulic Motors and Turbines.* For the use of Engineers, Manufacturers and Students. *Third Edition, revised and enlarged.* With 192 illustrations. 12mo. cloth. .... \$5.00
- BOILEAU, J. T.** *A New and Complete Set of Traverse Tables,* showing the Difference of Latitude and Departure of every minute of the Quadrant and to five places of decimals. 8vo, cloth. .... \$5.00
- BONNEY, G. E.** *The Electro-platers' Handbook.* A Manual for Amateurs and Young Students of Electro-metallurgy. 60 illustrations. 12mo, cloth. .... \$1.20
- BOOTH, W. H.** *Water Softening and Treatment, Condensing Plant, Feed Pumps, and Heaters for Steam Users and Manufacturers.* 8vo, cloth, illustrated..... *net, \$2.50*
- BOURRY, E.** *Treatise on Ceramic Industries. A Complete Manual for Pottery, Tile and Brick Works.* Translated from the French by Wilton P. Rix. With 323 figures and illustrations. 8vo, cloth, illustrated. .... *net, \$8.50*
- BOW, R. H.** *A Treatise on Bracing.* With its application to Bridges and other Structures of Wood or Iron. 156 illustrations. 8vo, cloth. .... \$1.50
- BOWIE, AUG. J., Jr., M.E.** *A Practical Treatise on Hydraulic Mining in California.* With Description of the Use and Construction of Ditches, Flumes, Wrought-iron Pipes and Dams; Flow of Water on Heavy Grades, and its Applicability, under High Pressure, to Mining. *Ninth Edition.* Small quarto, cloth. Illustrated. .... \$5.00
- BOWKER, Wm. R.** *Dynamo, Motor and Switchboard Circuits.* For Electrical Engineers. A practical book, dealing with the subject of Direct, Alternating, and Polyphase Currents. With over 100 diagrams and engravings. 8vo, cloth.. *net, \$2.25*
- BOWSER, E. A., Prof.** *An Elementary Treatise on Analytic Geometry.* Embracing Plane Geometry, and an Introduction to Geometry of three Dimensions. *Twenty-first Edition.* 12mo, cloth. .... *net, \$1.75*

**BOWSER, E. A., Prof.** *An Elementary Treatise on the Differential and Integral Calculus.* With numerous examples. *Twenty-first Edition.* Enlarged by 640 additional examples. 12mo, cloth.....net, \$2.25

— *An Elementary Treatise on Analytic Mechanics.* With numerous examples. *Sixteenth Edition.* 12mo, cloth.....net, \$3.00

— *An Elementary Treatise on Hydro-mechanics.* With numerous examples. *Fifth Edition.* 12mo, cloth.....net, \$2.50

— *A Treatise on Roofs and Bridges.* With Numerous Exercises, especially adapted for school use. 12mo, cloth. Illustrated.....net, \$2.25

**BRASSEY'S Naval Annual for 1905.** Edited by T. A. Brassey. With numerous full-page diagrams, half-tone illustrations and tables. Nineteenth year of publication. 8vo, cloth, illustrated.....net, \$6.00

**BRAUN, E.** *The Baker's Book: A Practical Handbook of the Baking Industry in all Countries.* Profusely illustrated with diagrams, engravings, and full-page colored plates. Translated into English and edited by Emil Braun. Vol. I., 8vo, cloth, illustrated, 308 pages..... \$2.50  
Vol. II. 363 pages, illustrated..... \$2.50

**British Standard Sections.** Issued by the Engineering Standards Committee, Supported by The Institution of Civil Engineers, The Institution of Mechanical Engineers, The Institution of Naval Architects, The Iron and Steel Institute, and The Institution of Electrical Engineers. Comprising 9 plates of diagrams, with letter-press and tables. Oblong pamphlet, 8 $\frac{1}{4}$  × 15..... \$1.00

**BROWN, WM. N.** *The Art of Enamelling on Metal.* With figures and illustrations. 12mo, cloth, illustrated. ....net, \$1.00

— *Handbook on Japanning and Enamelling, for Cycles, Bedsteads, Tinware, etc.* 12mo, cloth, illustrated. ....net, \$1.50

— *House Decorating and Painting.* With Numerous illustrations. 12mo, cloth.....net, \$1.50

— *History of Decorative Art.* With Designs and Illustrations. 12mo, cloth.....net, \$1.25



**BROWN, WM. N.** Principle and Practice of Dipping, Burnishing, Lacquering and Bronzing Brass Ware. 12mo, cloth. net, \$1.00

— Workshop Wrinkles for Decorators, Painters, Paper-Hangers and Others. 8vo, cloth. . . . . net, \$1.00

**BUCHANAN, E. E.** Tables of Squares. Containing the square of every foot, inch, and sixteenth of an inch, between one sixteenth of an inch and fifty feet. For Engineers and Calculators. 16mo, oblong, cloth. . . . . \$1.00

**BULMAN, H. F., and REDMAYNE, R. S. A.** Colliery Working and Management; comprising the duties of a colliery manager, the superintendence and arrangement of labor and wages, and the different systems of working coal-seams. With engravings, diagrams, and tables. *Second Edition, revised and enlarged.* 8vo, cloth, illustrated. . . . . net, \$6.00

**BURGH, N. P.** Modern Marine Engineering, Applied to Paddle and Screw Propulsion. Consisting of 36 colored plates, 259 practical woodcut illustrations and 403 pages of descriptive matter. The whole being an exposition of the present practice of James Watt & Co., J. & G. Rennie, R. Napier & Sons, and other celebrated firms. Thick quarto, half morocco. . . . . \$10.00

**BURT, W. A.** Key to the Solar Compass, and Surveyor's Companion. Comprising all the rules necessary for use in the field; also description of the Linear Surveys and Public Land System of the United States, Notes on the Barometer, Suggestions for an Outfit for a Survey of Four Months, etc. *Seventh Edition.* Pocket size, full leather. . . . . \$2.50

**BUSKETT, E. W.** Fire Assaying. 12mo, cloth, illustrated. . . . . *In Press.*

**CAIN, W., Prof.** Brief Course in the Calculus. With figures and diagrams. 8vo, cloth, illustrated. . . . . net, \$1.75

— Theory of Steel-concrete Arches and of Vaulted Structures. *New Edition, revised and enlarged.* 16mo, cloth, illustrated. (*Van Nostrand Science Series*). . . . . \$0.50

**CAMPIN, F.** On the Construction of Iron Roofs. A Theoretical and Practical Treatise, with woodcuts and plates of roofs recently executed. 8vo, cloth. . . . . \$2.00

- CARPENTER, Prof. R. C., and DIEDERICHS, Prof. H.** Internal Combustion Motors. With figures and diagrams. 8vo. cloth, illustrated..... *In Press*,
- CARTER, E. T.** Motive Power and Gearing for Electrical Machinery. A treatise on the Theory and Practice of the Mechanical Equipment of Power Stations for Electrical Supply and for Electric Traction. *Second Edition*, revised in part by G. Thomas-Davies. 8vo, cloth, illustrated..... \$5.00
- CATHCART, WM. L., Prof.** Machine Design. Part I. Fastenings. 8vo, cloth, illustrated..... *net*, \$3.00
- **Machine Elements; Shrinkage and Pressure Joints.** With tables and diagrams..... *In Press*.
- **Marine-Engine Design**..... *In Press*.
- **and CHAFFEE, J. I.** Course of Graphic Statics Applied to Mechanical Engineering..... *In Press*
- CHAMBER'S MATHEMATICAL TABLES**, consisting of Logarithms of Numbers 1 to 108,000, Trigonometrical, Nautical and other Tables. *New Edition*. 8vo, cloth..... \$1.75
- CHARPENTIER, P.** Timber. A Comprehensive Study of Wood in all its Aspects, Commercial and Botanical. Showing the Different Applications and Uses of Timber in Various Trades, etc. Translated into English. 8vo, cloth, illus... *net*, \$6.00
- CHAUVENET, W., Prof.** New Method of Correcting Lunar Distances, and Improved Method of Finding the Error and Rate of a Chronometer, by Equal Altitudes. 8vo, cloth. \$2.00
- CHILD, C. T.** The How and Why of Electricity. A Book of Information for non-technical readers, treating of the Properties of Electricity, and how it is generated, handled, controlled, measured and set to work. Also explaining the operation of Electrical Apparatus. 8vo, cloth, illustrated. . . . . \$1.00
- CHRISTIE, W. W.** Boiler-waters, Scale, Corrosion, Foaming. 8vo, cloth, illustrated. . . . . *net*, \$3.00
- **Chimney Design and Theory.** A Book for Engineers and Architects, with numerous half-tone illustrations and plates of famous chimneys. *Second Edition, revised*. 8vo, cloth. \$3.00

- CHRISTIE, W. W.** **Furnace Draft: its Production by Mechanical Methods.** A Handy Reference Book, with figures and tables. 16mo, cloth, illustrated. (*Van Nostrand's Science Series*). \$0.50
- CLAPPERTON, G.** **Practical Paper-making.** A Manual for Paper-makers and Owners and Managers of Paper Mills, to which is appended useful tables, calculations, data, etc., with illustrations reproduced from micro-photographs. 12mo, cloth, illustrated. . . . . \$2.50
- CLARK, D. K., C.E.** **A Manual of Rules, Tables and Data for Mechanical Engineers.** Based on the most recent investigations. Illustrated with numerous diagrams. 1012 pages. 8vo, cloth. *Sixth Edition.* . . . . . \$5.00
- **Fuel: its Combustion and Economy; consisting of** abridgments of Treatise on the Combustion of Coal. By C. W. Williams, and the Economy of Fuel, by T. S. Prideaux. With extensive additions in recent practice in the Combustion and Economy of Fuel, Coal, Coke, Wood, Peat, Petroleum, etc. *Fourth Edition.* 12mo, cloth. . . . . \$1.50
- **The Mechanical Engineer's Pocket-book of Tables, Formulæ, Rules and Data.** A Handy Book of Reference for Daily Use in Engineering Practice. 16mo, morocco. *Fifth Edition, carefully revised throughout.* . . . . . \$3.00
- **Tramways: Their Construction and Working.** Embracing a comprehensive history of the system, with accounts of the various modes of traction, a description of the varieties of rolling stock, and ample details of Cost and Working Expenses. *Second Edition, rewritten and greatly enlarged, with upwards of 400 illustrations.* Thick 8vo, cloth. . . . . \$89.00
- CLARK, J. M.** **New System of Laying Out Railway Turn-outs instantly, by inspection from tables.** 12mo, cloth. . . \$1.00
- CLAUSEN-THUE, W.** **The A B C Universal Commercial Electric Telegraphic Code; specially adapted for the use of Financiers, Merchants, Ship-owners, Brokers, Agents, etc.** *Fourth Edition.* 8vo, cloth. . . . . \$5.00  
*Fifth Edition of same.* . . . . . \$7.00
- **The A 1 Universal Commercial Electric Telegraphic Code.** Over 1240 pages and nearly 90,000 variations. 8vo, cloth. . . . . \$7.50

- CLEEMANN, T. M.** *The Railroad Engineer's Practice.* Being a Short but Complete Description of the Duties of the Young Engineer in Preliminary and Location Surveys and in Construction. *Fourth Edition, revised and enlarged.* Illustrated. 12mo, cloth. . . . . \$1.50
- CLEVENGER, S. R.** *A Treatise on the Method of Government Surveying* as prescribed by the U. S. Congress and Commissioner of the General Land Office, with complete Mathematical, Astronomical, and Practical Instructions for the use of the United States Surveyors in the field. 16mo, morocco. . . . . \$2.50
- CLOUTH, F.** *Rubber, Gutta-Percha, and Balata.* First English Translation with Additions and Emendations by the Author. With numerous figures, tables, diagrams, and folding plates. 8vo, cloth, illustrated. . . . . *net*, \$5.00
- COFFIN, J. H. C., Prof.** *Navigation and Nautical Astronomy.* Prepared for the use of the U. S. Naval Academy. *New Edition.* Revised by Commander Charles Belknap. 52 woodcut illustrations. 12mo, cloth. . . . . *net*, \$3.50
- COLE, R. S., M.A.** *A Treatise on Photographic Optics.* Being an account of the Principles of Optics, so far as they apply to photography. 12mo, cloth, 103 illus. and folding plates. . \$2.50
- COLLINS, J. E.** *The Private Book of Useful Alloys and Memoranda for Goldsmiths, Jewelers, etc.* 18mo, cloth. . . . £0.50
- COLLINS, T. B.** *The Steam Turbine, or the New Engine.* 8vo, cloth, illustrated. . . . . *In Press.*
- COOPER, W. R., M.A.** *Primary Batteries: Their Construction and Use.* With numerous figures and diagrams. 8vo, cloth, illustrated. . . . . *net*, \$4.00
- COPPERTHWAIT, WM. C.** *Tunnel Shields, and the Use of Compressed Air in Subaqueous Works.* With numerous diagrams and figures. 4to, cloth, illustrated. . . . . *net*, \$9.00
- COREY, H. T.** *Water-supply Engineering.* Fully illustrated. *In Press.*
- CORNWALL, H. B., Prof.** *Manual of Blow-pipe Analysis, Qualitative and Quantitative.* With a Complete System of Determinative Mineralogy. 8vo, cloth, with many illustrations. . . . . \$2.50



- COWELL, W. B.** *Pure Air, Ozone and Water.* A Practical Treatise of their Utilization and Value in Oil, Grease, Soap, Paint, Glue and other Industries. With tables and figures. 12mo, cloth, illustrated. . . . . net, \$2.00
- CRAIG, B. F.** *Weights and Measures.* An Account of the Decimal System, with Tables of Conversion for Commercial and Scientific Uses. Square 32mo, limp cloth. . . . . 50
- CROCKER, F. B., Prof.** *Electric Lighting.* A Practical Exposition of the Art. For use of Engineers, Students, and others interested in the Installation or Operation of Electrical Plants. Vol. I. The Generating Plant. *New Edition, thoroughly revised and rewritten.* 8vo, cloth, illustrated. . . . . \$3.00  
Vol. II. Distributing Systems and Lamps. *Fifth Edition.* 8vo, cloth, illustrated. . . . . \$3.00
- and **WHEELER, S. S.** *The Management of Electrical Machinery.* Being a *thoroughly revised and rewritten edition* of the authors' "Practical Management of Dynamos and Motors." With a special chapter by H. A. Foster. 12mo, cloth, illustrated. . . . . net, \$1.00
- CROSSKEY, L. R.** *Elementary Perspective: Arranged to meet the requirements of Architects and Draughtsmen, and of Art Students preparing for the elementary examination of the Science and Art Department, South Kensington.* With numerous full-page plates and diagrams. 8vo, cloth, illustrated . . \$1.00
- and **THAW, J.** *Advanced Perspective, involving the Drawing of Objects when placed in Oblique Positions, Shadows and Reflections.* Arranged to meet the requirements of Architects, Draughtsmen, and Students preparing for the Perspective Examination of the Education Department. With numerous full-page plates and diagrams. 8vo. cloth, illustrated. . . . . \$1.50
- DAVIES, E. H.** *Machinery for Metalliferous Mines.* A Practical Treatise for Mining Engineers, Metallurgists and Managers of Mines. With upwards of 400 illustrations. *Second Edition, rewritten and enlarged.* 8vo, cloth . . . . . net, \$8.00
- DAVIES, D. C.** *A Treatise on Metalliferous Minerals and Mining.* *Sixth Edition, thoroughly revised and much enlarged* by his son. 8vo, cloth. . . . . net, \$5.00
- *Mining Machinery*. . . . . *In Press.*
- DAVISON, G. C., Lieut.** *Water-tube Boilers.* . . . . *In Press.*

- DAY, C.** *The Indicator and its Diagrams.* With Chapters on Engine and Boiler Testing; including a Table of Piston Constants compiled by W. H. Fowler. 12mo, cloth. 125 illustrations..... \$2.00
- DEITE, Dr. C.** *Manual of Soapmaking, including medicated soaps, stain-removing soaps, metal polishing soaps, soap powders and detergents.* With a treatise on perfumes for scented soaps, and their production and tests for purity and strength. Edited from the text of numerous experts. Translated from the original by S. I. King, F.C.S. With figures. 4to, cloth, illustrated. net, \$5.00
- DE LA COUX, H.** *The Industrial Uses of Water.* With numerous tables, figures, and diagrams. Translated from the French and revised by Arthur Morris. 8vo, cloth.....net, \$4.50
- DENNY, G. A.** *Deep-level Mines of the Rand, and their future development, considered from the commercial point of view.* With folding plates, diagrams, and tables. 4to, cloth, illustrated. .... net, \$10.00
- DERR, W. L.** *Block Signal Operation. A Practical Manual.* Pocket Size. Oblong, cloth. *Second Edition*....\$1.50
- DIBDIN, W. J.** *Public Lighting by Gas and Electricity.* With tables, diagrams, engravings and full-page plates. 8vo, cloth, illustrated..... net, \$8.00
- *Purification of Sewage and Water.* With tables, engravings, and folding plates. *Third Edition, revised and enlarged.* 8vo, cloth, illus. and numerous folding plates.... \$6.50
- DIETERICH, K.** *Analysis of Resins, Balsams, and Gum Resins: their Chemistry and Pharmacognosis.* For the use of the Scientific and Technical Research Chemist. With a Bibliography. Translated from the German, by Chas. Salter. 8vo. cloth..... net, \$3.00
- DIXON, D. B.** *The Machinist's and Steam Engineer's Practical Calculator.* A Compilation of Useful Rules and Problems arithmetically solved, together with General Information applicable to Shop-tools, Mill-gearing, Pulleys and Shafts, Steam-boilers and Engines. Embracing valuable Tables and Instruction in Screw-cutting, Valve and Link Motion, etc. *Third Edition.* 16mo, full morocco, pocket form..... \$1.25
- DOBLE, W. A.** *Power Plant Construction on the Pacific Coast*..... *In Press.*

**DODD, GEO.** Dictionary of Manufactures, Mining, Machinery, and the Industrial Arts. 12mo, cloth. . . . . \$1.50

**DORR, B. F.** The Surveyor's Guide and Pocket Table-book. *Fifth Edition, thoroughly revised and greatly extended.* With a second appendix up to date. 16mo, morocco flaps. . \$2.00

**DRAPER, C. H.** An Elementary Text-book of Light, Heat and Sound, with Numerous Examples. *Fourth Edition.* 12mo, cloth, illustrated. . . . . \$1.00

— Heat and the Principles of Thermo-dynamics. With many illustrations and numerical examples. 12mo, cloth. . . \$1.50

**DYSON, S. S.** Practical Testing of Raw Materials. A Concise Handbook for Manufacturers, Merchants, and Users of Chemicals, Oils, Fuels, Gas Residuals and By-products, and Paper-making Materials, with Chapters on Water Analysis and the Testing of Trade Effluents. 8vo, cloth, illustrations, 177 pages. . . . . *net*, \$5.00

**ECCLES, R. G. (Dr.), and DUCKWALL, E. W.** Food Preservatives: their Advantages and Proper Use; The Practical *versus* the Theoretical Side of the Pure Food Problem. 8vo, paper. . . . . \$0.50  
Cloth. . . . . 1.00

**EDDY, H. T., Prof.** Researches in Graphical Statics. Embracing New Constructions in Graphical Statics, a New General Method in Graphical Statics, and the Theory of Internal Stress in Graphical Statics. 8vo, cloth. . . . . \$1.50

— Maximum Stresses under Concentrated Loads. Treated graphically. Illustrated. 8vo, cloth. . . . . \$1.50

**EISSLER, M.** The Metallurgy of Gold. A Practical Treatise on the Metallurgical Treatment of Gold-bearing Ores, including the Processes of Concentration and Chlorination, and the Assaying, Melting and Refining of Gold. *Fifth Edition, revised and greatly enlarged.* Over 300 illustrations and numerous folding plates. 8vo, cloth. . . . . \$7.50

— The Hydro-Metallurgy of Copper. Being an Account of processes adopted in the Hydro-metallurgical Treatment of Cupriferous Ores, including the Manufacture of Copper Vitriol. With chapters on the sources of supply of Copper and the Roasting of Copper Ores. With numerous diagrams and figures. 8vo, cloth, illustrated. . . . . *net*, \$4.50

- EISSLER, M.** **The Metallurgy of Silver.** A Practical Treatise on the Amalgamation, Roasting and Lixiviation of Silver Ores, including the Assaying, Melting and Refining of Silver Bullion. 124 illustrations. *Second Edition, enlarged.* 8vo, cloth. \$4.00
- **The Metallurgy of Argentiferous Lead.** A Practical Treatise on the Smelting of Silver-Lead Ores and the Refining of Lead Bullion. Including Reports on Various Smelting Establishments and Descriptions of Modern Smelting Furnaces and Plants in Europe and America. With 183 illustrations. 8vo, cloth, \$5.00
- **Cyanide Process for the Extraction of Gold and its Practical Application** on the Witwatersrand Gold Fields in South Africa. *Third Edition, revised and enlarged.* Illustrations and folding plates. 8vo, cloth..... \$3.00
- **A Handbook on Modern Explosives.** Being a Practical Treatise on the Manufacture and Use of Dynamite, Gun-cotton, Nitroglycerine, and other Explosive Compounds, including the manufacture of Collodion-cotton, with chapters on Explosives in Practical Application. *Second Edition, enlarged with 150 illustrations.* 12mo, cloth..... \$5.00
- ELIOT, C. W., and STORER, F. H.** **A Compendious Manual of Qualitative Chemical Analysis.** Revised with the co-operation of the authors, by Prof. William R. Nichols. Illustrated. *Twentieth Edition, newly revised by Prof. W. B. Lindsay.* 12mo, cloth..... net, \$1.25
- ELLIOT, G. H., Maj.** **European Light-house Systems.** Being a Report of a Tour of Inspection made in 1873. 51 engravings and 21 woodcuts. 8vo, cloth..... \$5.00
- ERFURT, J.** **Dyeing of Paper Pulp.** A Practical Treatise for the use of paper-makers, paper-stainers, students and others, With illustrations and 157 patterns of paper dyed in the pulp, with formulas for each. Translated into English and edited, with additions, by Julius Hübner, F.C.S. 8vo, cloth, illustrated..... net, \$7.50
- EVERETT, J. D.** **Elementary Text-book of Physics.** Illustrated. *Seventh Edition.* 12mo, cloth..... \$1.50
- EWING, A. J., Prof.** **The Magnetic Induction in Iron and other metals.** *Third Edition, revised.* 159 illustrations 8vo, cloth..... \$4.00



- FAIRIE, J., F.G.S.** Notes on Lead Ores: Their Distribution and Properties. 12mo, cloth. . . . . \$1.00
- Notes on Pottery Clays: The Distribution, Properties, Uses and Analysis of Ball Clays, China Clays and China Stone. With tables and formulæ. 12mo, cloth. . . . . \$1.50
- FANNING, J. T.** A Practical Treatise on Hydraulic and Water-supply Engineering. Relating to the Hydrology, Hydrodynamics and Practical Construction of Water-works in North America. 180 illus. 8vo, cloth. *Sixteenth Edition, revised, enlarged, and new tables and illustrations added.* 650 pp. . . . . \$5.00
- FAY, I. W.** The Coal-tar Colors: Their Origin and Chemistry. 8vo, cloth, illustrated. . . . . *In Press.*
- FERNBACH, R. L.** Glue and Gelatine; a Practical Treatise on the Methods of Testing and Use. 12mo, cloth. . *In Press.*
- FISH, J. C. L.** Lettering of Working Drawings. Thirteen plates, with descriptive text. Oblong, 9×12½, boards. \$1.00
- FISHER, H. K. C., and DARBY, W. C.** Students' Guide to Submarine Cable Testing. *Third (new and enlarged) Edition.* 8vo, cloth, illustrated. . . . . \$3.50
- FISHER, W. C.** The Potentiometer and its Adjuncts. 8vo, cloth. . . . . \$2.25
- FISKE, B. A., Lieut., U.S.N.** Electricity in Theory and Practice; or, The Elements of Electrical Engineering. *Eighth Edition.* 8vo, cloth. . . . . \$2.50
- FLEISCHMANN, W.** The Book of the Dairy. A Manual of the Science and Practice of Dairy Work. Translated from the German, by C. M. Aikman and R. Patrick Wright. 8vo, cloth. . . . . \$4.00
- FLEMING, J. A., Prof.** The Alternate-current Transformer in Theory and Practice. Vol. I., The Induction of Electric Currents; 611 pages. *New Edition, illustrated.* 8vo, cloth, \$5.00  
Vol. II., The Utilization of Induced Currents. Illustrated. 8vo, cloth. . . . . \$5.00
- Centenary of the Electrical Current, 1799-1899. 8vo, paper, illustrated. . . . . \$0.50

- FLEMING, J. A., Prof.** **Electric Lamps and Electric Lighting.** Being a course of four lectures delivered at the Royal Institution, April-May, 1894. 8vo, cloth, fully illustrated. . . . \$3.00
- **Electrical Laboratory Notes and Forms, Elementary and Advanced.** 4to, cloth, illustrated. . . . \$5.00
- **A Handbook for the Electrical Laboratory and Testing Room.** 2 volumes. 8vo, cloth. . . . each \$5.00
- FLEURY, H.** **The Calculus Without Limits or Infinitesimals.** Translated by C. O. Mailloux. . . . *In Press*
- FOLEY, N., and PRAY, THOS., Jr.** **The Mechanical Engineers' Reference Book for Machine and Boiler Construction,** in two parts. Part 1—General Engineering Data. Part 2—Boiler Construction. With 51 plates and numerous illustrations, specially drawn for this work. Folio, half morocco. *New Edition.* . . . . *In Press.*
- FORNEY, M. N.** **Catechism of the Locomotive.** **Second Edition, revised and enlarged.** 46th thousand. 8vo, cloth. . \$3.50
- FOSTER, H. A.** **Electrical Engineers' Pocket-book.** With the Collaboration of Eminent Specialists. A handbook of useful data for Electricians and Electrical Engineers. With innumerable tables, diagrams, and figures. *Third Edition, revised* Pocket size, full leather, 1000 pp. . . . \$5.00
- FOSTER, J. G., Gen., U.S.A.** **Submarine Blasting in Boston Harbor, Massachusetts.** Removal of Tower and Corwin Rocks. Illustrated with 7 plates. 4to, cloth. . . . \$3.50
- FOSTER, J.** **Treatise on the Evaporation of Saccharine,** Chemical and other Liquids by the Multiple System in Vacuum and Open Air. *Third Edition.* Diagrams and large plates. 8vo, cloth. . . . \$7.50
- FOX, WM., and THOMAS, C. W., M.E.** **A Practical Course in Mechanical Drawing.** *Second Edition, revised.* 12mo, cloth, with plates. . . . \$1.25
- FRANCIS, J. B., C.E.** **Lowell Hydraulic Experiments.** Being a selection from experiments on Hydraulic Motors on the Flow of Water over Weirs, in Open Canals of uniform rectangular section, and through submerged Orifices and diverging Tubes. Made at Lowell, Mass. *Fourth Edition, revised and enlarged,* with many new experiments, and illustrated with 23 copper-plate engravings 4to, cloth. . . . \$15.00

- FRASER, R. H., and CLARK, C. H.** *Marine Engineering.*  
*In Press.*
- FULLER, G. W.** *Report on the Investigations into the Purification of the Ohio River Water at Louisville, Kentucky, made to the President and Directors of the Louisville Water Company. Published under agreement with the Directors. 3 full-page plates. 4to, cloth. . . . . net, \$10.00*
- FURNELL, J.** *Students' Manual of Paints, Colors, Oils and Varnishes. 8vo, cloth, illustrated. . . . . net, \$1.00*
- GARCKE, E., and FELS, J. M.** *Factory Accounts: their principles and practice. A handbook for accountants and manufacturers, with appendices on the nomenclature of machine details, the rating of factories, fire and boiler insurance, the factory and workshop acts, etc., including also a large number of specimen rulings. Fifth Edition, revised and extended. 8vo, cloth, illustrated. . . . . \$3.00*
- GEIKIE, J.** *Structural and Field Geology, for Students of Pure and Applied Science. With figures, diagrams, and half-tone plates. 8vo, cloth, illustrated. . . . . net, \$4.00*
- GERBER, N.** *Chemical and Physical Analysis of Milk, Condensed Milk, and Infants' Milk-food. 8vo, cloth. . . . \$1.25*
- GERHARD, WM. P.** *Sanitary Engineering. 12mo, cloth. . . . . \$1.25*
- GESCHWIND, L.** *Manufacture of Alum and Sulphates, and other Salts of Alumina and Iron; their uses and applications as mordants in dyeing and calico printing, and their other applications in the Arts, Manufactures, Sanitary Engineering, Agriculture and Horticulture. Translated from the French by Charles Salter. With tables, figures and diagrams. 8vo, cloth, illustrated. . . . . net, \$5.00*
- GIBBS, W. E.** *Lighting by Acetylene, Generators, Burners and Electric Furnaces. With 66 illustrations. Second Edition; revised. 12mo, cloth. . . . . \$1.50*
- GILLMORE, Q. A., Gen.** *Treatise on Limes, Hydraulic Cements and Mortars. Papers on Practical Engineering, United States Engineer Department, No. 9, containing Reports of numerous Experiments conducted in New York City during the years 1858 to 1861, inclusive. With numerous illustrations. 8vo, cloth. . . . . \$4.00*

**GILLMORE, Q. A., Gen.** Practical Treatise on the Construction of Roads, Streets and Pavements. *Tenth Edition.* With 70 illustrations. 12mo, cloth. . . . . \$2.00

— **Report on Strength of the Building Stones in the United States, etc.** 8vo, illustrated, cloth. . . . . \$1.00

**GOLDING, H. A.** The Theta-Phi Diagram. Practically Applied to Steam, Gas, Oil and Air Engines. 12mo, cloth, illustrated. . . . . *net*, \$1.25

**GOODEVE, T. M.** A Text-book on the Steam-engine. With a Supplement on Gas-engines. *Twelfth Edition, enlarged.* 143 illustrations. 12mo, cloth. . . . . \$2.00

**GORE, G., F.R.S.** The Art of Electrolytic Separation of Metals, etc. (Theoretical and Practical.) Illustrated. 8vo, cloth. . . . . \$3.50

**GOULD, E. S.** The Arithmetic of the Steam-engine. 8vo, cloth. . . . . \$1.00

— **Practical Hydrostatics and Hydrostatic Formulas.** With numerous figures and diagrams. (*Van Nostrand's Science Series.*) 16mo, cloth, illustrated, 114 pp. . . . . \$0.50

**GRAY, J., B.Sc.** Electrical Influence Machines: Their Historical Development, and Modern Forms, with instructions for making them. With numerous figures and diagrams. *Second Edition, revised and enlarged.* 12mo, cloth, illus., 296 pp. . . . \$2.00

**GREENWOOD, E.** Classified Guide to Technical and Commercial Books. Subject List of Principal British and American Works in print. 8vo, cloth. . . . . *net*, \$3.00

**GRIFFITHS, A. B., Ph.D.** A Treatise on Manures, or the Philosophy of Manuring. A Practical Handbook for the Agriculturist, Manufacturer, and Student. 12mo, cloth. . . \$3.00

— **Dental Metallurgy. A Manual for Students and Dentists.** 8vo, cloth, illustrated, 208 pp. . . . . *net*, \$3.50

**GROSS, E.** Hops, in their Botanical, Agricultural and Technical Aspect, and as an article of Commerce. Translated from the German by Charles Salter. With tables, diagrams, and illustrations. 8vo, cloth, illustrated. . . . . *net*, \$4.50



- GROVER, F.** *Practical Treatise on Modern Gas and Oil Engines.* 8vo, cloth, illustrated. . . . . *net*, \$2.00
- GRUNER, A.** *Power-loom Weaving and Yarn Numbering, according to various systems, with conversion tables. An auxiliary and text-book for pupils of weaving schools, as well as for self-instruction, and for general use by those engaged in the weaving industry. Illustrated with colored diagrams.* 8vo, cloth. . . . . *net*, \$3.00
- GURDEN, R. L.** *Traverse Tables: Computed to Four-place Decimals for every single minute of angle up to 100 of Distance. For the use of Surveyors and Engineers. New Edition.* Folio, half morocco. . . . . \$7.50
- GUY, A. E.** *Experiments on the Flexure of Beams, resulting in the Discovery of New Laws of Failure by Buckling. Reprinted from the "American Machinist." With diagrams and folding plates.* 8vo, cloth, illustrated, 122 pages. . . . *net*, \$1.25
- **A. F.** *Electric Light and Power: Giving the Result of Practical Experience in Central-station Work.* 8vo, cloth, illustrated. . . . . \$2.50
- HAEDER, H., C.E.** *A Handbook on the Steam-engine.* With especial reference to small and medium-sized engines. For the use of Engine-makers, Mechanical Draughtsmen, Engineering Students and Users of Steam Power. Translated from the German, with considerable additions and alterations, by H. H. P. Powles. *Third English Edition, revised.* 8vo, cloth, illustrated, 458 pages . . . . . \$3.00
- HALL, C. H.** *Chemistry of Paints and Paint Vehicles.* 8vo, cloth. . . . . *net*, \$2.00
- **W. S., Prof.** *Elements of the Differential and Integral Calculus. Sixth Edition, revised.* 8vo, cloth, illustrated. . . . . *net*, \$2.25
- *Descriptive Geometry, with Numerous Problems and Practical Applications.* Comprising an 8vo volume of 76 pages of text and a 4to atlas of 31 plates. 2 vols., cloth. . . . *net*, \$3.50

- HALSEY, F. A.** Slide-valve Gears. An Explanation of the Action and Construction of Plain and Cut-off Slide Valves. Illustrated. *Seventh Edition*. 12mo, cloth ..... \$1.50
- The Use of the Slide Rule. With illustrations and folding plates. *Second Edition*. 16mo, boards. (*Van Nostrand's Science Series*, No. 114.) ..... 50
- The Locomotive Link Motion, with Diagrams and Tables. 8vo, cloth, illustrated ..... \$1.00
- Worm and Spiral Gearing. Revised and Enlarged Edition. 16mo, cloth (*Van Nostrand's Science Series*, No. 116.) Illustrated ..... 50
- The Metric Fallacy, and "The Metric Failure in the Textile Industry," by Samuel S. Dale. 8vo, cloth, illustrated ..... \$1.00
- HAMILTON, W. G.** Useful Information for Railway Men. *Tenth Edition, revised and enlarged*. 562 pages, pocket form. Morocco, gilt ..... \$2.00
- HAMMER, W. J.** Radium, and Other Radio-active Substances; Polonium, Actinium and Thorium. With a consideration of Phosphorescent and Fluorescent Substances, the Properties and Applications of Selenium, and the treatment of disease by the Ultra-Violet Light. *Second Edition*. With engravings and photographic plates. 8vo, cloth, illustrated, 72 pp... \$1.00
- HANCOCK, H.** Text-book of Mechanics and Hydrostatics, with over 500 diagrams. 8vo, cloth ..... net, \$1.50
- HARDY, E.** Elementary Principles of Graphic Statics. Containing 192 diagrams. 8vo, cloth, illustrated ..... \$1.50
- HARRISON, W. B.** The Mechanics' Tool-book. With Practical Rules and Suggestions for use of Machinists, Ironworkers and others. With 44 engravings. 12mo, cloth.... \$1.50
- HART, J. W.** External Plumbing Work. A Treatise on Lead Work for Roofs. With numerous figures and diagrams. 8vo, cloth, illustrated ..... net, \$3.00
- Hints to Plumbers on Joint Wiping, Pipe Bending, and Lead Burning. Containing 184 figures and diagrams. 8vo, cloth, illustrated ..... net, \$3.00

- HART, J. W.** Principles of Hot-water Supply. With numerous illustrations. 8vo, cloth. . . . . *net*, \$3.00
- Sanitary Plumbing and Drainage. With numerous diagrams and figures. 8vo, cloth, illustrated . . . . . *net*, \$3.00
- HASKINS, C. H.** The Galvanometer and its Uses. A Manual for Electricians and Students. *Fourth Edition.* 12mo. cloth. . . . . \$1.50
- HAUFF, W. A.** American Multiplier: Multiplications and Divisions of the largest numbers rapidly performed. With index giving the results instantly of all numbers to  $1000 \times 1000 = 1,000,000$ ; also tables of circumferences and areas of circles. Cloth,  $6\frac{1}{2} \times 15\frac{1}{2}$ . . . . . \$5.00
- HAUSBRAND, E.** Drying by Means of Air and Steam. With explanations, formulas, and tables, for use in practice. Translated from the German by A. C. Wright, M.A. 12mo, cloth, illustrated. . . . . *net*, \$2.00
- Evaporating, Condensing and Cooling Apparatus: Explanations, Formulæ, and Tables for Use in Practice. Translated from the Second Revised German Edition by A. C. Wright, M.A. With numerous figures, tables and diagrams. 8vo, cloth, illustrated, 400 pages. . . . . *net*, \$5.00
- HAUSNER, A.** Manufacture of Preserved Foods and Sweetmeats. A Handbook of all the Processes for the Preservation of Flesh, Fruit, and Vegetables, and for the Preparation of Dried Fruit, Dried Vegetables, Marmalades, Fruit-syrups, and Fermented Beverages, and of all kinds of Candies, Candied Fruit Sweetmeats, Rocks, Drops, Dragees, Pralines, etc. Translated from the Third Enlarged German Edition, 'by Arthur Morris and Herbert Robson, B.Sc. 8vo, cloth, illustrated. . . . . *net*, \$3.00
- HAWKE, W. H.** The Premier Cipher Telegraphic Code, containing 100,000 Words and Phrases. The most complete and most useful general code yet published. 4to, cloth. . . . . \$5.00
- 100,000 Words Supplement to the Premier Code. All the words are selected from the official vocabulary. Oblong quarto, cloth. . . . . \$5.00
- HAWKESWORTH, J.** Graphical Handbook for Reinforced Concrete Design. A series of plates, showing graphically, by means of plotted curves, the required design for slabs, beams, and columns under various conditions of external loading, together with practical examples showing the method of using each plate. 8vo, cloth. . . . . *In Press.*

- HAWKINS, C. C., and WALLIS, F.** *The Dynamo: its Theory, Design, and Manufacture.* 190 illustrations. 12mo, cloth.....net, \$3.00
- HAY, A.** *Alternating Currents; Their Theory, Generation, and Transformation.* 8vo, cloth, illustrated.....net, \$2.50
- *Principles of Alternate-current Working.* 12mo, cloth, illustrated..... \$2.00
- HEAP, D. P., Major, U.S.A.** *Electrical Appliances of the Present Day.* Report of the Paris Electrical Exposition of 1881. 250 illustrations. 8vo, cloth..... \$2.00
- HEAVISIDE, O.** *Electromagnetic Theory.* 8vo, cloth. two volumes.....each, \$5.00
- HECK, R. C. H.** *Steam-Engine and Other Steam Motors.* A text-book for engineering colleges and a treatise for engineers. Vol. I. *The Thermodynamics and the Mechanics of the Engine.* With numerous figures, diagrams, and tables. 8vo, cloth, illustrated.....net, \$3.50  
Vol. II. *Form, Construction, and Working of the Engine: The Steam Turbine.* 8vo, cloth, illustrated.....net, \$3.50
- HEDGES, K.** *Modern Lightning Conductors.* An Illustrated Supplement to the Report of the Lightning Research Committee of 1905, with Notes as to Methods of Protection and Specifications. With figures, half-tones, and folding tables. 8vo, cloth, illustrated.....net, \$3.00
- HEERMANN, P.** *Dyers' Materials.* An Introduction to the Examination, Valuation, and Application of the most important substances used in Dyeing, Printing, Bleaching and Finishing. Translated by Arthur C. Wright, M.A. 12mo, cloth, illustrated.....net, \$2.50
- HENRICI, O.** *Skeleton Structures, Applied to the Building of Steel and Iron Bridges.* 8vo, cloth, illustrated..... \$1.50
- HERMANN, F.** *Painting on Glass and Porcelain and Enamel Painting.* On the basis of Personal Practical Experience of the Condition of the Art up to date. Translated by Charles Salter. *Second greatly enlarged edition.* 8vo, cloth, illustrated, net, \$3.50
- HERRMANN, G.** *The Graphical Statics of Mechanism.* A Guide for the Use of Machinists, Architects and Engineers; and also a Text-book for Technical Schools. Translated and annotated by A. P. Smith, M.E. *Fourth Edition.* 12mo, cloth, 7 folding plates..... \$2.00



- HERZFELD, J., Dr.** The Technical Testing of Yarns and Textile Fabrics, with reference to official specifications. Translated by Chas. Salter. With 69 illustrations. 8vo, cloth *net*, \$3.50
- HEWSON, W.** Principles and Practice of Embanking Lands from River Floods, as applied to the Levees of the Mississippi. 8vo, cloth. . . . . \$2.00
- HILL, J. W.** The Purification of Public Water Supplies. Illustrated with valuable tables, diagrams, and cuts. 8vo, cloth. . . . . \$3.00
- HIROI, I.** Statically-Indeterminate Stresses in Frames Commonly Used for Bridges. With figures, diagrams, and examples. 12mo, cloth, illustrated. . . . . *net*, \$2.00
- HOBBS, W. R. P.** The Arithmetic of Electrical Measurements, with numerous examples, fully worked. Revised by Richard Wormell, M.A. *Ninth Edition*. 12mo, cloth. . . . . .50
- HOFF, J. N.** Paint and Varnish Facts and Formulas. A hand-book for the maker, dealer, and user of paints and varnishes. Containing over 600 recipes. 8vo, cloth. . . . . *net*, \$3.00
- HOFF, WM. B., Com., U.S.N.** The Avoidance of Collisions at Sea. 18mo, morocco. . . . . .75
- HOLLEY, A. L.** Railway Practice. American and European Railway Practice in the Economical Generation of Steam, including the Materials and Construction of Coal-burning Boilers, Combustion, the Variable Blast, Vaporization, Circulation, Superheating, Supplying and Heating Feed Water, etc., and the Adaptation of Wood and Coke-burning Engines to Coal-burning; and in Permanent Way, including Road-bed, Sleepers, Rails, Joint Fastenings, Street Railways, etc. With 77 lithographed plates. Folio, cloth. . . . . \$12.00
- HOLMES, A. B.** The Electric Light Popularly Explained. *Fifth Edition*. Illustrated. 12mo, paper. . . . . .40
- HOPKINS, N. M.** Experimental Electrochemistry: Theoretically and Practically Treated. With 132 figures and diagrams. 8vo, cloth, illustrated. . . . . *net*, \$3.00
- **Model Engines and Small Boats.** New Methods of Engine and Boiler Making, with a chapter on Elementary Ship Design and Construction. 12mo, cloth. . . . . \$1.25

- HORNER, J.** *Engineers' Turning, in Principle and Practice.* A Handbook for Working Engineers, Technical Students, and Amateurs. With 488 figures and diagrams. 8vo, cloth, illustrated. . . . . *net*, \$3.50
- HOUSTON, E. J., and KENNELLY, A. E.** *Algebra Made Easy.* Being a clear explanation of the Mathematical Formulæ found in Prof. Thompson's "Dynamo-electric Machinery and Polyphase Electric Currents." With figures and examples. 8vo, cloth, illustrated. . . . . .75
- **The Interpretation of Mathematical Formulæ.** With figures and examples. 8vo, cloth, illustrated. . . . . \$1.25
- HOWARD, C. R.** *Earthwork Mensuration on the Basis of the Prismoidal Formulæ.* Containing Simple and Labor-saving Methods of obtaining Prismoidal Contents directly from End Areas. Illustrated by Examples and accompanied by Plain Rules for Practical Use. Illustrated. 8vo, cloth. . . . . \$1.50
- HOWORTH, J.** *Art of Repairing and Riveting Glass, China and Earthenware. Second Edition.* 8vo, pamphlet, illustrated. . . . . *net*, \$0.50
- HUBBARD, E.** *The Utilization of Wood-waste.* A Complete Account of the Most Advantageous Methods of Working Up Wood Refuse, especially Sawdust, Exhausted Dye Woods and Tan as Fuel, as a Source of Chemical Products for Artificial Wood Compositions, Explosives, Manures, and many other Technical Purposes. Translated from the German of the *second revised and enlarged edition.* 8vo, cloth, illustrated, 192 pages. . *net*, \$2.50
- HUMBER, W., C.E.** *A Handy Book for the Calculation of Strains in Girders, and Similar Structures, and their Strength; consisting of Formulæ and Corresponding Diagrams, with numerous details for practical application, etc. Fourth Edition.* 12mo, cloth. . . . . \$2.50
- HUMPHREYS, A. C. (Stevens Institute).** *Lecture Notes on some of the Business Features of Engineering Practice.* 8vo, cloth, with supplement. . . . . *net*, \$1.25
- HURST, G. H., F.C.S.** *Color. A Handbook of the Theory of Color.* A practical work for the Artist, Art Student, Painter, Dyer and Calico Printer, and Others. Illustrated with 10 colored plates and 72 illustrations. 8vo, cloth. . . . . *net*, \$2.50
- **Dictionary of Chemicals and Raw Products Used in the Manufacture of Paints, Colors, Varnishes and Allied Preparations.** 8vo, cloth. . . . . *net*, \$3.00

- HURST, G.H., F.C.S.** Lubricating Oils, Fats and Greases: Their Origin, Preparation, Properties, Uses and Analysis. 313 pages, with 65 illustrations. 8vo, cloth. . . . . net, \$3.00
- **Soaps. A Practical Manual of the Manufacture of Domestic, Toilet and other Soaps.** Illustrated with 66 engravings. 8vo, cloth. . . . . net, \$5.00
- **Textile Soaps and Oils: A Handbook on the Preparation, Properties, and Analysis of the Soaps and Oils Used in Textile Manufacturing, Dyeing and Printing.** With tables and illustrations. 8vo, cloth. . . . . net, \$2.50
- HUTCHINSON, R. W., Jr.** Long Distance Electric Power Transmission: being a Treatise on the Hydro-electric Generation of Energy; its Transformation, Transmission, and Distribution. 12mo, cloth, illustrated. . . . . *In Press.*
- **and IHLENG, M. C.** Electricity in Mining; being a Theoretical and Practical Treatise on the Construction, Operation, and Maintenance of Electrical Mining Machinery. 12mo, cloth, illustrated. . . . . *In Press.*
- **W. B.** Patents and How to Make Money out of Them. 12mo, cloth. . . . . \$1.25
- HUTTON, W. S.** Steam-boiler Construction. A Practical Handbook for Engineers, Boiler-makers and Steam-users. Containing a large collection of rules and data relating to recent practice in the design, construction and working of all kinds of stationary, locomotive and marine steam-boilers. With upwards of 540 illustrations. *Fourth Edition, carefully revised and much enlarged.* 8vo, cloth. . . . . \$6.00
- **Practical Engineer's Handbook, comprising a Treatise on Modern Engines and Boilers, Marine, Locomotive and Stationary.** *Fourth Edition, carefully revised, with additions.* With upwards of 570 illustrations. 8vo, cloth. . . . . \$7.00
- **The Works' Manager's Handbook of Modern Rules, Tables and Data for Civil and Mechanical Engineers, Millwrights and Boiler-makers, etc., etc.** With upwards of 150 illustrations. *Fifth Edition, carefully revised, with additions.* 8vo, cloth. . . . . \$6.00
- INGLE, H.** Manual of Agricultural Chemistry. 8vo, cloth, illustrated, 388 pages. . . . . net, \$3.00

- INNES, C. H.** **Problems in Machine Design.** For the use of Students, Draughtsmen and others. *Second Edition*, 12mo, cloth. . . . . *net*, \$2.00
- **Centrifugal Pumps, Turbines and Water Motors.** Including the Theory and Practice of Hydraulics. *Fourth and enlarged edition.* 12mo, cloth. . . . . *net*, \$2.00
- ISHERWOOD, B. F.** **Engineering Precedents for Steam Machinery.** Arranged in the most practical and useful manner for Engineers. With illustrations. Two volumes in one. 8vo, cloth. . . . . \$2.50
- JAMIESON, A., C.E.** **A Text-book on Steam and Steam-engines.** Specially arranged for the use of Science and Art, City and Guilds of London Institute, and other Engineering Students. *Thirteenth Edition.* Illustrated. 12mo, cloth. . . . . \$3.00
- **Elementary Manual on Steam and the Steam-engine.** Specially arranged for the use of First-year Science and Art, City and Guilds of London Institute, and other Elementary Engineering Students. *Third Edition.* 12mo, cloth. . . . . \$1.50
- JANNETTAZ, E.** **A Guide to the Determination of Rocks:** being an Introduction to Lithology. Translated from the French by G. W. Plympton, Professor of Physical Science at Brooklyn Polytechnic Institute. 12mo, cloth. . . . . \$1.50
- JEHL, F., Mem. A.I.E.E.** **The Manufacture of Carbons** for Electric Lighting and Other Purposes. A Practical Handbook, giving a complete description of the art of making carbons, electros, etc. The various gas generators and furnaces used in carbonizing, with a plan for a model factory. Illustrated with numerous diagrams, tables, and folding plates. 8vo, cloth, illustrated. *net*, \$4.00
- JENNISON, F. H.** **The Manufacture of Lake Pigments** from Artificial Colors. A useful handbook for color manufacturers, dyers, color chemists, paint manufacturers, drysalters, wallpaper-makers, enamel and surface-paper makers. With 15 plates illustrating the various methods and errors that arise in the different processes of production. 8vo, cloth. . . . *net*, \$3.00
- JEPSON, G.** **Cams, and the Principles of their Construction.** With figures, half-tones, full-page and folding plates. 8vo, cloth, illustrated. . . . . *net*, \$1.50
- JOCKIN, WM.** **Arithmetic of the Gold and Silversmith.** Prepared for the use of Jewelers, Founders, Merchants, etc., especially for those engaged in the conversion and alloying of gold or other metals, the mixing of various substances, etc. With numerous examples. 12mo, cloth. . . . . \$1.25



- JOHNSON, W. McA. "The Metallurgy of Nickel." *In Press.*
- JOHNSTON, J. F. W., Prof., and CAMERON, Sir Chas.  
Elements of Agricultural Chemistry and Geology. *Seventeenth Edition.* 12mo, cloth. . . . . \$2.60
- JONES, H. C. Outlines of Electrochemistry. With tables and diagrams. 4to, cloth, illustrated. . . . . \$1.50
- Electrical Nature of Matter and Radioactivity. 12mo, cloth. . . . . *net*, \$2.00
- JONES, M. W. The Testing and Valuation of Raw Materials used in Paint and Color Manufacture. 12mo, cloth, *net*, \$2.00
- JOYNSON, F. H. The Metals Used in Construction. Iron, Steel, Bessemer Metal, etc. Illustrated. 12mo, cloth. . . . . 75
- Designing and Construction of Machine Gearing. Illustrated. 8vo, cloth. . . . . \$2.00
- JÜPTNER, H. F. V. Siderology: The Science of Iron. (The Constitution of Iron Alloys and Iron.) Translated from the German. 8vo, cloth, 345 pages, illustrated. . . . . *net*, \$5.00
- KANSAS CITY BRIDGE, THE. With an Account of the Regimen of the Missouri River and a Description of the Methods used for Founding in that River, by O. Chanute, Chief Engineer, and George Morison, Assistant Engineer. Illustrated with 5 lithographic views and 12 plates of plans. 4to, cloth. \$6.00
- KAPP, G., C.E. Electric Transmission of Energy and its Transformation, Subdivision and Distribution. A practical handbook. *Fourth Edition, revised.* 12mo, cloth. . . . . \$3.50
- Dynamos, Motors, Alternators and Rotary Converters. Translated from the *third German edition*, by Harold H. Simmons, A.M.I.E.E. With numerous diagrams and figures. 8vo, cloth, 507 pages. . . . . \$4.00
- KEIM, A. W. Prevention of Dampness in Buildings. With Remarks on the Causes, Nature and Effects of Saline Efflorescences and Dry Rot. For Architects, Builders, Overseers, Plasterers, Painters and House Owners. Translated from the *second revised, German edition.* With colored plates and diagrams. 8vo, cloth, illustrated, 115 pages. . . . . *net*, \$2.00
- KELSEY, W. R. Continuous-current Dynamos and Motors, and their Control: being a series of articles reprinted from *The Practical Engineer*, and completed by W. R. Kelsey. With many figures and diagrams. 8vo, cloth, illustrated. . . \$2.50

- KEMP, J. F., A.B., E.M. (Columbia Univ.).** A Handbook of Rocks. For use without the microscope. With a glossary of the names of rocks and of other lithological terms. *Third Edition, revised.* 8vo, cloth, illustrated..... \$1.50
- KEMPE, H. R.** The Electrical Engineer's Pocket-book of Modern Rules, Formulæ, Tables and Data. Illustrated. 32mo, morocco, gilt..... \$1.75
- KENNEDY, R.** Modern Engines and Power Generators. A Practical Work on Prime Movers and the Transmission of Power: Steam, Electric, Water, and Hot-air. With tables, figures, and full-page engravings. 6 vols. 8vo, cloth, illustrated.  
\$15.00  
Single volumes, each..... \$3.00
- **Electrical Installations of Electric Light, Power, Traction, and Industrial Electrical Machinery.** With numerous diagrams and engravings.
- **Vol. I. The Electrical Circuit, Measurement, Elements of Motors, Dynamos, Electrolysis.** 8vo, cloth, illus.. \$3.50
- **Vol. II. Instruments, Transformers, Installation Wiring, Switches and Switchboards.** 8vo, cloth, illustrated.... \$3.50
- **Vol. III. Production of Electrical Energy, Prime Movers, Generators and Motors.** 8vo, cloth, illustrated... \$3.50
- **Vol. IV. Mechanical Gearing; Complete Electric Installations; Electrolytic, Mining and Heating Apparatus; Electric Traction; Special Applications of Electric Motors.** 8vo, cloth, illustrated..... \$3.50
- KENNEDY, R.** Vol. V. Apparatus and Machinery used in Telegraphs, Telephones, Signals, Wireless Telegraph, X-Rays, and Medical Science. 8vo, cloth, illustrated.....\$3.50  
Complete sets of the five volumes..... \$15.00
- KENNELLY, A. E.** Theoretical Elements of Electrodynamic Machinery. 8vo, cloth..... \$1.50
- KINGDON, J. A.** Applied Magnetism. An Introduction to the Design of Electromagnetic Apparatus. 8vo, cloth.. \$3.00

**KINZBRUNNER, C.** **Alternate Current Windings; Their Theory and Construction.** A Handbook for Students, Designers, and all Practical Men. 8vo, cloth, illustrated.....net, \$1.50

— **Continuous Current Armatures; Their Winding and Construction.** A Handbook for Students, Designers, and all Practical Men. 8vo, cloth, illustrated.....net, \$1.50

**KIRKALDY, W. G.** **Illustrations of David Kirkaldy's System of Mechanical Testing,** as Originated and Carried on by him during a Quarter of a Century. Comprising a Large Selection of Tabulated Results, showing the Strength and other Properties of Materials used in Construction, with Explanatory Text and Historical Sketch. Numerous engravings and 25 lithographed plates. 4to, cloth..... \$10.00

**KIRKBRIDE, J.** **Engraving for Illustration: Historical and Practical Notes,** with illustrations and 2 plates by ink photo process. 8vo, cloth, illustrated..... net, \$1.50

**KIRKWOOD, J. P.** **Report on the Filtration of River Waters for the Supply of Cities,** as practised in Europe, made to the Board of Water Commissioners of the City of St. Louis. Illustrated by 30 double-page engravings. 4to, cloth.... \$7.50

**KLEIN, J. F.** **Design of a High-speed Steam-engine.** With notes, diagrams, formulas and tables. *Second Edition, revised and enlarged.* 8vo, cloth, illustrated. ....net, \$5.00

**KLEINHANS, F. B.** **Boiler Construction.** A Practical explanation of the best modern methods of Boiler Construction, from the laying out of sheets to the completed Boiler. With diagrams and full-page engravings. 8vo, cloth, illustrated..\$3.00

**KNIGHT, A. M., Lieut.-Com. U.S.N.** **Modern Seaman-ship.** Illustrated with 136 full-page plates and diagrams. 8vo, cloth, illustrated. *Second Edition, revised.* .... net, \$6.00  
Half morocco..... \$7.50

**KNOTT, C. G., and MACKAY, J. S.** **Practical Mathematics.** With numerous examples, figures and diagrams. *New Edition.* 8vo, cloth, illustrated. .... \$2.00

**KOLLER, T.** **The Utilization of Waste Products.** A Treatise on the Rational Utilization, Recovery and Treatment of Waste Products of all kinds. Translated from the German *second revised edition.* With numerous diagrams. 8vo, cloth, illustrated..... net, \$3.50

- KOLLER, T. Cosmetics. A Handbook of the Manufacture,**  
Employment and Testing of all Cosmetic Materials and Cosmetic  
Specialties. Translated from the German by Chas. Salter. 8vo.  
cloth. .... net, \$2.50
- KRAUCH, C., Dr. Testing of Chemical Reagents for**  
Purity. Authorized translation of the *Third Edition*, by J. A.  
Williamson and L. W. Dupre. With additions and emendations  
by the author. 8vo, cloth. .... net, \$4.50
- LAMBERT, T. Lead, and its Compounds. With tables,**  
diagrams and folding plates. 8vo, cloth. .... net, \$3.50
- **Bone Products and Manures. An Account of**  
the most recent improvements in the manufacture of Fat, Glue,  
Animal Charcoal, Size, Gelatine and Manures. With plans and  
diagrams. 8vo, cloth, illustrated. .... net, \$3.00
- LAMBORN, L. L. Cottonseed Products: A Manual of the**  
Treatment of Cottonseed for its Products and Their Utilization  
in the Arts. With Tables, figures, full-page plates, and a large  
folding map. 8vo, cloth, illustrated. .... net, \$3.00
- **Modern Soaps, Candles, and Glycerin. A practical**  
manual of modern methods of utilization of Fats and Oils in the  
manufacture of Soaps and Candles, and the recovery of Glycerin.  
8vo, cloth, illustrated. .... net, \$7.50
- LAMPRECHT, R. Recovery Work after Pit Fires. A**  
description of the principal methods pursued, especially in fiery  
mines, and of the various appliances employed, such as respira-  
tory and rescue apparatus, dams, etc. With folding plates and  
diagrams. Translated from the German by Charles Salter. 8vo,  
cloth, illustrated. .... net, \$4.00
- LARRABEE, C. S. Cipher and Secret Letter and Tele-**  
graphic Code, with Hog's Improvements. The most perfect  
Secret Code ever invented or discovered. Impossible to read  
without the key. 18mo, cloth. .... .60
- LASSAR-COHN, Dr. An Introduction to Modern Scien-**  
tific Chemistry, in the form of popular lectures suited to University  
Extension Students and general readers. Translated from the  
author's corrected proofs for the *second German edition*, by  
M. M. Pattison Muir, M.A. 12mo, cloth, illustrated. .... \$2.00



- LATTA, M. N.** Gas Engineering Practice. With figures, diagrams and tables. 8vo, cloth, illustrated.....*in Press.*
- LEASK, A. R.** Breakdowns at Sea and How to Repair Them. With 89 illustrations. *Second Edition.* 8vo, cloth. \$2.00
- Triple and Quadruple Expansion Engines and Boilers and their Management. With 59 illustrations. *Third Edition, revised.* 12mo, cloth..... \$2.00
- Refrigerating Machinery: Its Principles and Management. With 64 illustrations. 12mo, cloth..... \$2.00
- LECKY, S. T. S.** "Wrinkles" in Practical Navigation. With 130 illustrations. 8vo, cloth. *Fourteenth Edition, revised and enlarged.* ..... \$8.00
- LEFÉVRE, L.** Architectural Pottery: Bricks, Tiles, Pipes, Enameled Terra-Cottas, Ordinary and Incrusted Quarries, Stone-ware Mosaics, Faiences and Architectural Stoneware. With tables, plates and 950 cuts and illustrations. With a preface by M. J.-C. Formigé. Translated from the French, by K. H. Bird, M.A., and W. Moore Binns. 4to, cloth, illustrated..... *net*, \$7.50
- LEHNER, S.** Ink Manufacture: including Writing, Copying, Lithographic, Marking, Stamping and Laundry Inks. Translated from the *fifth German edition*, by Arthur Morris and Herbert Robson, B.Sc. 8vo, cloth, illustrated..... *net*, \$2.50
- LEMSTROM, Dr.** Electricity in Agriculture and Horticulture. Illustrated. .... *net*, \$1.50
- LEVY, C. L.** Electric-light Primer. A simple and comprehensive digest of all the most important facts connected with the running of the dynamo, and electric lights, with precautions for safety. For the use of persons whose duty it is to look after the plant. 8vo, paper..... .50
- LIVERMORE, V. P., and WILLIAMS, J.** How to Become a Competent Motorman. Being a Practical Treatise on the Proper Method of Operating a Street Railway Motor Car; also giving details how to overcome certain defects. 16mo, cloth, illustrated, 132 pages..... \$1.00

- LOBBEN, P., M.E.** *Machinists' and Draftsmen's Handbook*, containing Tables, Rules, and Formulas, with numerous examples, explaining the principles of mathematics and mechanics, as applied to the mechanical trades. Intended as a reference book for all interested in Mechanical work. Illustrated with many cuts and diagrams. 8vo, cloth. . . . . \$2.50
- LOCKE, A. G. and C. G.** *A Practical Treatise on the Manufacture of Sulphuric Acid*. With 77 constructive plates, drawn to scale measurements, and other illustrations. Royal 8vo, cloth. . . . . \$10.00
- LOCKERT, L.** *Petroleum Motor-cars*. 12mo, cloth, \$1.50
- LOCKWOOD, T. D.** *Electricity, Magnetism, and Electro-telegraphy*. A Practical Guide for Students, Operators, and Inspectors. 8vo, cloth. *Third Edition*. . . . . \$2.50
- *Electrical Measurement and the Galvanometer: its Construction and Uses*. *Second Edition*. 32 illustrations. 12mo, cloth. . . . . \$1.50
- LODGE, O. J.** *Elementary Mechanics, including Hydrostatics and Pneumatics*. *Revised Edition*. 12mo, cloth . . . \$1.50
- *Signalling Across Space, Without Wires: being a description of the work of Hertz and his successors*. With numerous diagrams and half-tone cuts, and additional remarks concerning the application to Telegraphy and later developments. *Third Edition*. 8vo, cloth, illustrated. . . . . *net*, \$2.00
- LORD, R. T.** *Decorative and Fancy Fabrics*. A Valuable Book with designs and illustrations for manufacturers and designers of Carpets, Damask, Dress and all Textile Fabrics. 8vo, cloth, illustrated. . . . . *net*, \$3.50
- LORING, A. E.** *A Handbook of the Electro-magnetic Telegraph*. 16mo, cloth, boards. *New and enlarged edition*. . . . . \$1.50
- LUCE, S. B. (Com., U. S. N.)**. *Text-book of Seamanship*. The Equipping and Handling of Vessels under Sail or Steam. For the use of the U. S. Naval Academy. *Revised and enlarged edition*, by Lieut. Wm. S. Benson. 8vo, cloth, illustrated. \$10.00
- LUCKE, C. E.** *Gas Engine Design*. With figures and diagrams. *Second Edition, revised*. 8vo, cloth, illustrated. *net*, \$3.00
- *Power, Cost and Plant Designs and Construction*.  
*In Press.*

- LUCKE, C. E.** Power Plant Papers. Form I. The Steam Power Plant. Pamphlet (8×13).....net, \$1.50
- LUNGE, G., Ph.D.** Coal-tar and Ammonia: being the third and enlarged edition of "A Treatise on the Distillation of Coal-tar and Ammoniacal Liquor," with numerous tables, figures and diagrams. Thick 8vo, cloth, illustrated. .... net, \$15.00
- A Theoretical and Practical Treatise on the Manufacture of Sulphuric Acid and Alkali with the Collateral Branches.
- Vol. I. Sulphuric Acid. In two parts, not sold separately. *Second Edition, revised and enlarged.* 342 illus. 8vo, cloth.. \$15.00
- Vol. II. Salt Cake, Hydrochloric Acid and Leblanc Soda. *Second Edition, revised and enlarged.* 8vo, cloth... \$15.00
- Vol. III. Ammonia Soda, and various other processes of Alkali-making, and the preparation of Alkalis, Chlorine and Chlorates, by Electrolysis. 8vo, cloth. *New Edition, 1896.* \$15.00
- and **HURTER, F.** The Alkali Maker's Handbook. Tables and Analytical Methods for Manufacturers of Sulphuric Acid, Nitric Acid, Soda, Potash and Ammonia. *Second Edition.* 12mo, cloth. .... \$3.00
- LUPTON, A., PARR, G. D. A., and PERKIN, H.** Electricity as Applied to Mining. With tables, diagrams and folding plates. *Second Edition, revised and enlarged.* 8vo, cloth, illustrated .....net, \$4.50
- LUQUER, L. M., Ph.D. (Columbia Univ.).** Minerals in Rock Sections. The Practical Method of Identifying Minerals in Rock Sections with the Microscope. Especially arranged for Students in Technical and Scientific Schools. *Revised Edition.* 8vo, cloth, illustrated.....net, \$1.50
- MACKIE, JOHN.** How to Make a Woolen Mill Pay. 8vo, cloth..... net, \$2.00
- MACKROW, C.** The Naval Architect's and Ship-builder's Pocket-book of Formulæ, Rules, and Tables; and Engineers' and Surveyors' Handy Book of Reference. *Eighth Edition, revised and enlarged.* 16mo, limp leather, illustrated. .... \$5.00
- MAGUIRE, E., Capt., U.S.A.** The Attack and Defence of Coast Fortifications. With maps and numerous illustrations, 8vo, cloth..... \$2.50

- MAGUIRE, WM. R.** Domestic Sanitary Drainage and Plumbing Lectures on Practical Sanitation. 332 illustrations. 8vo. . . . . \$4.00
- MAILLOUX, C. O.** Electro-traction Machinery. 8vo, cloth, illustrated. . . . . *In Press.*
- MARKS, E. C. R.** Notes on the Construction of Cranes and Lifting Machinery. With numerous diagrams and figures. *New and enlarged edition.* 12mo, cloth. . . . . *net*, \$1.50
- Notes on the Construction and Working of Pumps. With figures, diagrams and engravings. 12mo, cloth, illustrated. . . . . *net*, \$1.50
- **G. C.** Hydraulic Power Engineering. A Practical Manual on the Concentration and Transmission of Power by Hydraulic Machinery. With over 200 diagrams and tables 8vo, cloth, illustrated. . . . . \$3.50
- MARSH, C. F.** Reinforced Concrete. With full-page and folding plates, and 512 figures and diagrams. 4to, cloth, illustrated. . . . . *net*, \$7.00
- MAVER, W.** American Telegraphy: Systems, Apparatus, Operation. 450 illustrations. 8vo, cloth. . . . . \$5.00
- MAYER, A. M., Prof.** Lecture Notes on Physics. 8vo, cloth. . . . . \$2.00
- McCULLOCH, R. S., Prof.** Elementary Treatise on the Mechanical Theory of Heat, and its application to Air and Steam-engines. 8vo, cloth. . . . . \$3.50
- McINTOSH, J. G.** Technology of Sugar. A Practical Treatise on the Manufacture of Sugar from the Sugar-cane and Sugar-beet. With diagrams and tables. 8vo, cloth, illustrated. *net*, \$4.50
- **Manufacture of Varnishes and Kindred Industries.** Based on and including the "Drying Oils and Varnishes," of Ach. Livache. Volume I. Oil Crushing, Refining and Boiling, Manufacture of Linoleum, Printing and Lithographic Inks, and India-rubber Substitutes. *Second greatly enlarged English Edition.* 8vo, cloth, illustrated. . . . . *net*, \$3.50  
(To be complete in three volumes.)



- McNEILL, B.** *McNeill's Code. Arranged to meet the requirements of Mining, Metallurgical and Civil Engineers, Directors of Mining, Smelting and other Companies, Bankers, Stock and Share Brokers, Solicitors, Accountants, Financiers and General Merchants. Safety and Secrecy.* 8vo, cloth. . . . \$6.00
- McPHERSON, J. A., A. M.** *Inst. C. E. Waterworks Distribution. A practical guide to the laying out of systems of distributing mains for the supply of water to cities and towns With tables, folding plates and numerous full-page diagrams* 8vo, cloth, illustrated. . . . . \$2.50
- MERCK, E.** *Chemical Reagents: Their Purity and Tests.*  
*In Press.*
- MERRITT, WM. H.** *Field Testing for Gold and Silver. A Practical Manual for Prospectors and Miners. With numerous half-tone cuts, figures and tables.* 16mo, limp leather, illustrated. . . . . \$1.50
- METAL TURNING.** *By a Foreman Pattern-maker. Illustrated with 81 engravings.* 12mo, cloth. . . . . \$1.50
- MICHELL, S.** *Mine Drainage: being a Complete Practical Treatise on Direct-acting Underground Steam Pumping Machinery. Containing many folding plates, diagrams and tables. Second Edition, rewritten and enlarged.* Thick 8vo, cloth, illustrated. . . . . \$10.00
- MIERZINSKI, S., Dr.** *Waterproofing of Fabrics. Translated from the German by Arthur Morris and Herbert Robson. With diagrams and figures.* 8vo, cloth, illustrated. . . . *net*, \$2.50
- MILLER, E. H. (Columbia Univ.).** *Quantitative Analysis for Mining Engineers.* 8vo, cloth. . . . . *net*, \$1.50
- MINIFIE, W.** *Mechanical Drawing. A Text-book of Geometrical Drawing for the use of Mechanics and Schools, in which the Definitions and Rules of Geometry are familiarly explained; the Practical Problems are arranged from the most simple to the more complex, and in their description technicalities are avoided as much as possible. With illustrations for drawing Plans, Sections, and Elevations of Railways and Machinery; an Introduction to Isometrical Drawing, and an Essay on Linear Perspective and Shadows. Illustrated with over 200 diagrams engraved on steel. Tenth Thousand, revised. With an Appendix on the Theory and Application of Colors.* 8vo, cloth. . \$4.00

- MINIFIE, W.** Geometrical Drawing. Abridged from the octavo edition, for the use of schools. Illustrated with 48 steel plates. *Ninth Edition.* 12mo, cloth..... \$2.00
- MODERN METEOROLOGY.** A Series of Six Lectures, delivered under the auspices of the Meteorological Society in 1870. Illustrated. 12mo, cloth..... \$1.50
- MOORE, E. C. S.** New Tables for the Complete Solution of Ganguillet and Kutter's Formula for the flow of liquids in open channels, pipes, sewers and conduits. In two parts. Part I, arranged for 1080 inclinations from 1 over 1 to 1 over 21,120 for fifteen different values of (*n*). Part II, for use with all other values of (*n*). With large folding diagram. 8vo, cloth, illustrated..... net, \$5.00
- MOREING, C. A., and NEAL, T.** New General and Mining Telegraph Code. 676 pages, alphabetically arranged. For the use of mining companies, mining engineers, stock brokers, financial agents, and trust and finance companies. *Eighth Edition.* 8vo, cloth..... \$5.00
- MOSES, A. J.** The Characters of Crystals. An Introduction to Physical Crystallography, containing 321 illustrations and diagrams. 8vo..... net, \$2.00
- and **PARSONS, C. L.** Elements of Mineralogy, Crystallography and Blowpipe Analysis from a Practical Standpoint. *Third Enlarged Edition.* 8vo, cloth, 336 illustrations, net, \$2.50
- MOSS, S. A.** Elements of Gas Engine Design. Reprint of a Set of Notes accompanying a Course of Lectures delivered at Cornell University in 1902. 16mo, cloth, illustrated. (Van Nostrand's Science Series)..... \$0.50
- MOSS, S. A.** The Lay-out of Corliss Valve Gears. (*Van Nostrand's Science Series.*) 16mo, cloth, illustrated..... \$0.50
- MULLIN, J. P., M.E.** Modern Moulding and Pattern-making. A Practical Treatise upon Pattern-shop and Foundry Work: embracing the Moulding of Pulleys, Spur Gears, Worm Gears, Balance-wheels, Stationary Engine and Locomotive Cylinders, Globe Valves, Tool Work, Mining Machinery, Screw Propellers, Pattern-shop Machinery, and the latest improvements in English and American Cupolas; together with a large collection of original and carefully selected Rules and Tables for every-day use in the Drawing Office, Pattern-shop and Foundry. 12mo, cloth, illustrated..... \$2.50

- MUNRO, J., C.E., and JAMIESON, A., C.E.** A Pocket-book of Electrical Rules and Tables for the use of Electricians and Engineers. *Fifteenth Edition, revised and enlarged.* With numerous diagrams. Pocket size. Leather. . . . . \$2.50
- MURPHY, J. G., M.E.** Practical Mining. A Field Manual for Mining Engineers. With Hints for Investors in Mining Properties. 16mo, cloth. . . . . \$1.00
- NAQUET, A.** Legal Chemistry. A Guide to the Detection of Poisons, Falsification of Writings, Adulteration of Alimentary and Pharmaceutical Substances, Analysis of Ashes, and Examination of Hair, Coins, Arms and Stains, as applied to Chemical Jurisprudence, for the use of Chemists, Physicians, Lawyers, Pharmacists and Experts. Translated, with additions, including a list of books and memoirs on Toxicology, etc., from the French, by J. P. Battershall, Ph.D., with a Preface by C. F. Chandler, Ph.D., M.D., LL.D. 12mo, cloth. . . . . \$2.00
- NASMITH, J.** The Student's Cotton Spinning. Third Edition, revised and enlarged. 8vo, cloth, 622 pages, 250 illustrations. . . . . \$3.00
- NEUBURGER, H., and NOALHAT, H.** Technology of Petroleum. The Oil Fields of the World: their History, Geography and Geology. Annual Production, Prospection and Development; Oil-well Drilling; Transportation of Petroleum by Land and Sea. Storage of Petroleum. With 153 illustrations and 25 plates. Translated from the French, by John Geddes McIntosh. 8vo, cloth, illustrated. . . . . net, \$10.00
- NEWALL, J. W.** Plain Practical Directions for Drawing, Sizing and Cutting Bevel-gears, showing how the Teeth may be cut in a Plain Milling Machine or Gear Cutter so as to give them a correct shape from end to end; and showing how to get out all particulars for the Workshop without making any Drawings. Including a Full Set of Tables of Reference. Folding plates. 8vo, cloth. . . . . \$1.50
- NEWLANDS, J.** The Carpenters' and Joiners' Assistant: being a Comprehensive Treatise on the Selection, Preparation and Strength of Materials, and the Mechanical Principles of Framing, with their application in Carpentry, Joinery and Hand-railing; also, a Complete Treatise on Sines; and an Illustrated Glossary of Terms used in Architecture and Building. Illustrated. Folio, half morocco. . . . . \$15.00

- NIPHER, F. E., A.M.** *Theory of Magnetic Measurements*, with an Appendix on the Method of Least Squares. 12mo, cloth. . . . . \$1.00
- NOLL, AUGUSTUS.** *How to Wire Buildings: A Manual of the Art of Interior Wiring.* With many illustrations. *Fourth Edition.* 8vo, cloth, illustrated. . . . . \$1.50
- NUGENT, E.** *Treatise on Optics; or, Light and Sight Theoretically and Practically Treated, with the Application to Fine Art and Industrial Pursuits.* With 103 illustrations. 12mo, cloth. . . . . \$1.50
- O'CONNOR, H.** *The Gas Engineer's Pocket-book.* Comprising Tables, Notes and Memoranda relating to the Manufacture, Distribution and Use of Coal-gas and the Construction of Gas-works. *Second Edition, revised.* 12mo, full leather, gilt edges. . . . . \$3.50
- OLSEN, J. C., Prof.** *Text-book of Quantitative Chemical Analysis* by Gravimetric, Electrolytic, Volumetric and Gasometric Methods. With Seventy-two Laboratory Exercises giving the Analysis of Pure Salts, Alloys, Minerals and Technical Products. With numerous figures and diagrams. *Second Edition, revised.* 8vo, cloth. . . . . *net*, \$4.00
- OSBORN, F. C.** *Tables of Moments of Inertia, and Squares of Radii of Gyration; supplemented by others on the Ultimate and Safe Strength of Wrought-iron Columns, Safe Strength of Timber Beams, and Constants for readily obtaining the Shearing Stresses, Reactions and Bending Moments in Swing Bridges.* *Fifth Edition.* 12mo, leather. . . . . *net*, \$3.00
- LOUDIN, M. A.** *Standard Polyphase Apparatus and Systems.* With many diagrams and figures. *Third Edition, thoroughly revised.* Fully illustrated. . . . . \$3.00
- PALAZ, A., Sc.D.** *A Treatise on Industrial Photometry,* with special application to Electric Lighting. Authorized translation from the French by George W. Patterson, Jr. *Second Edition, revised.* 8vo, cloth, illustrated. . . . . \$4.00
- PAMELY, C.** *Colliery Manager's Handbook.* A Comprehensive treatise on the Laying-out and Working of Collieries. Designed as a book of reference for colliery managers and for the use of coal-mining students preparing for first-class certificates. *Fifth Edition, revised and enlarged.* Containing over 1,000 diagrams, plans, and engravings. 8vo, cloth, illustrated. . . . . *net*, \$10.00



- PARR, G. D. A.** **Electrical Engineering Measuring Instruments**, for Commercial and Laboratory Purposes. With 370 diagrams and engravings. 8vo, cloth, illustrated. . . . .*net*, \$3.50
- PARRY, E. J., B.Sc.** **The Chemistry of Essential Oils and Artificial Perfumes.** Being an attempt to group together the more important of the published facts connected with the subject; also giving an outline of the principles involved in the preparation and analysis of Essential Oils. With numerous diagrams and tables. 8vo, cloth, illustrated. . . . .*net*, \$5.00
- and **COSTE, J. H.** **Chemistry of Pigments.** With tables and figures. 8vo, cloth. . . . .*net*, \$4.50
- PARRY, L. A., M.D.** **The Risks and Dangers of Various Occupations and their Prevention.** A book that should be in the hands of manufacturers, the medical profession, sanitary inspectors, medical officers of health, managers of works, foremen and workmen. 8vo, cloth. . . . .*net*, \$3.00
- PARSHALL, H. F., and HOBART, H. M.** **Armature Windings of Electric Machines.** With 140 full-page plates, 65 tables and 165 pages of descriptive letter-press. 4to, cloth. \$7.50
- and **PARRY, E.** **Electrical Equipment of Tramways.**  
*In Press.*
- PASSMORE, A. C.** **Handbook of Technical Terms used in Architecture and Building, and their Allied Trades and Subjects.** 8vo, cloth. . . . .*net*, \$3.50
- PATERSON, D., F.C.S.** **The Color Printing of Carpet Yarns.** A useful manual for color chemists and textile printers. With numerous illustrations. 8vo, cloth, illustrated. . . . .*net*, \$3.50
- **Color Matching on Textiles.** A Manual intended for the use of Dyers, Calico Printers, and Textile Color Chemists. Containing colored frontispiece and 9 illustrations, and 14 dyed patterns in appendix. 8vo, cloth, illustrated. . . . .*net*, \$3.00
- **The Science of Color Mixing.** A Manual intended for the use of Dyers, Calico Printers, and Color Chemists. With figures, tables, and colored plate. 8vo, cloth, illustrated. *net*, \$3.00
- PATTEN, J.** **A Plan for Increasing the Humidity of the Arid Region and the Utilization of Some of the Great Rivers of the United States for Power and other Purposes.** A paper communicated to the National Irrigation Congress, Ogden, Utah. Sept. 12, 1903. 4to, pamphlet, 20 pages, with 7 maps. . . \$1.00

- PATTON, H. B.** **Lecture Notes on Crystallography**  
*Revised Edition, largely rewritten.* Prepared for use of the students at the Colorado School of Mines. With blank pages for note-taking. 8vo, cloth. . . . .net \$1.25
- PAULDING, C. P.** **Practical Laws and Data on the Condensation of Steam in Covered and Bare Pipes;** to which is added a translation of Pécelet's "Theory and Experiments on the Transmission of Heat Through Insulating Materials." 8vo, cloth, illustrated, 102 pages. . . . .net, \$2.00
- **Transmission of Heat through Cold-storage Insulation:** Formulas, Principles, and Data Relating to Insulation of Every Kind. A Manual for refrigerating engineers. With tables and diagrams. 12mo, cloth, illustrated. . . . .net, \$1.00
- PEIRCE, B.** **System of Analytic Mechanics.** 4to, cloth. . . . . \$10.00
- PERRINE, F. A. C., A.M., D.Sc.** **Conductors for Electrical Distribution:** their Manufacture and Materials, the Calculation of Circuits, Pole Line Construction, Underground Working and other Uses. With numerous diagrams and engravings. 8vo, cloth, illustrated, 287 pages. . . . .net, \$3.50
- PERRY, J.** **Applied Mechanics.** A Treatise for the Use of students who have time to work experimental, numerical, and graphical exercises illustrating the subject. 8vo, cloth, 650 pages. . . . .net, \$2.50
- PHILLIPS, J.** **Engineering Chemistry.** A Practical Treatise for the use of Analytical Chemists, Engineers, Iron Masters, Iron Founders, students and others. Comprising methods of Analysis and Valuation of the principal materials used in Engineering works, with numerous Analyses, Examples, and Suggestions. Illustrated. *Third Edition, revised and enlarged.* 8vo, cloth. . . . .net, \$4.50
- **Gold Assaying.** A Practical Handbook giving the Modus Operandi for the Accurate Assay of Auriferous Ores and Bullion, and the Chemical Tests required in the Processes of Extraction by Amalgamation, Cyanidation, and Chlorination. With an appendix of tables and statistics and numerous diagrams and engravings. 8vo, cloth, illustrated. . . . .net, \$2.50
- PHIN, J.** **Seven Follies of Science.** A Popular Account of the most famous scientific impossibilities and the attempts which have been made to solve them; to which is added a small Budget of Interesting Paradoxes, Illusions, and Marvels. With numerous illustrations. 8vo, cloth, illustrated. . . . .net, \$1.25

- PICKWORTH, C. N.** *The Indicator Handbook. A Practical Manual for Engineers. Part I. The Indicator: its Construction and Application.* 81 illustrations. 12mo, cloth. \$1.50
- *The Indicator Handbook. Part II. The Indicator Diagram: its Analysis and Calculation.* With tables and figures. 12mo, cloth, illustrated. . . . . \$1.50
- *Logarithms for Beginners.* 8vo, boards. . . . . \$0.50
- *The Slide Rule. A Practical Manual of Instruction for all Users of the Modern Type of Slide Rule, containing Succinct Explanation of the Principle of Slide-rule Computation, together with Numerous Rules and Practical Illustrations, exhibiting the Application of the Instrument to the Every-day Work of the Engineer—Civil, Mechanical and Electrical. Seventh Edition.* 12mo, flexible cloth. . . . . \$1.00
- Plane Table, The.** *Its Uses in Topographical Surveying.* From the Papers of the United States Coast Survey. Illustrated. 8vo, cloth. . . . . \$2.00  
 "This work gives a description of the Plane Table employed at the United States Coast Survey office, and the manner of using it."
- PLATTNER'S Manual of Qualitative and Quantitative Analysis with the Blow-pipe.** *Eighth Edition, revised.* Translated by Henry B. Cornwall, E.M., Ph.D., assisted by John H. Caswell, A.M. From the sixth German edition, by Prof. Friederich Kolbeck. With 87 woodcuts. 463 pages. 8vo, cloth. . . . . \$4.00
- PLYMPTON, GEO. W., Prof.** *The Aneroid Barometer: its Construction and Use.* Compiled from several sources. *Eighth Edition, revised and enlarged.* 16mo, boards, illustrated. . . . . \$0.50
- POCKET LOGARITHMS, to Four Places of Decimals,** including Logarithms of Numbers, and Logarithmic Sines and Tangents to Single Minutes. To which is added a Table of Natural Sines, Tangents, and Co-tangents. 16mo, boards. \$0.50
- POPE, F. L.** *Modern Practice of the Electric Telegraph.* A Technical Handbook for Electricians, Managers and Operators. *Fifteenth Edition, rewritten and enlarged, and fully illustrated.* 8vo, cloth. . . . . \$1.50
- POPPLEWELL, W. C.** *Elementary Treatise on Heat and Heat Engines.* Specially adapted for engineers and students of engineering. 12mo, cloth, illustrated. . . . . \$3.00

**POPPLEWELL, W. C.** Prevention of Smoke, combined with the Economical Combustion of Fuel. With diagrams, figures and tables. 8vo, cloth illustrated..... *net*, \$3.50

**Practical Compounding of Oils, Tallow and Grease, for Lubrication, etc.** By an Expert Oil Refiner. 8vo, cloth. *net*, \$3.50

**Practical Iron Founding.** By the Author of "Pattern Making," etc. Illustrated with over 100 engravings. *Third Edition.* 12mo, cloth..... \$1.50

**PRAY, T., Jr.** Twenty Years with the Indicator: being a Practical Text-book for the Engineer or the Student, with no complex Formulæ. Illustrated. 8vo, cloth..... \$2.50

— **Steam Tables and Engine Constant.** Compiled from Regnault, Rankine and Dixon directly, making use of the exact records. 8vo, cloth..... \$2.00

**PREECE, W. H.** Electric Lamps..... *In Press.*

— and **STUBBS, A. T.** Manual of Telephony. Illustrations and plates. 12mo, cloth..... \$4.50

**PRELINI, C., C.E.** Earth and Rock Excavation. A Manual for Engineers, Contractors, and Engineering Students. With tables and many diagrams and engravings. 8vo, cloth, illustrated. *net*, \$3.00

— **Retaining Walls and Dams.** 8vo, cloth, illustrated. *In Press.*

— **Tunneling.** A Practical Treatise containing 149 Working Drawings and Figures. With additions by Charles S. Hill, C.E., Associate Editor "Engineering News." 311 pages. *Second Edition, revised.* 8vo, cloth, illustrated..... \$3.00

**PREMIER CODE.** (See Hawke, Wm. H.)

**PRESCOTT, A. B., Prof.** Organic Analysis. A Manual of the Descriptive and Analytical Chemistry of certain Carbon Compounds in Common Use; a Guide in the Qualitative and Quantitative Analysis of Organic Materials in Commercial and Pharmaceutical Assays, in the Estimation of Impurities under Authorized Standards, and in Forensic Examinations for Poisons, with Directions for Elementary Organic Analysis. *Fifth Edition.* 8vo, cloth..... \$5.00



- PRESCOTT, A. B., Prof.** **Outlines of Proximate Organic Analysis**, for the Identification, Separation and Quantitative Determination of the more 'commonly occurring Organic Compounds. *Fourth Edition*. 12mo, cloth..... \$1.75
- and **JOHNSON, O. C.** **Qualitative Chemical Analysis.** A Guide in Qualitative Work, with Data for Analytical Operations, and Laboratory Methods in Inorganic Chemistry. *Sixth revised and enlarged Edition, entirely rewritten*, with an appendix by H. H. Willard, containing a few improved methods of analysis. 8vo, cloth.....net, \$3.50
- and **SULLIVAN, E. C.** (University of Michigan). **First Book in Qualitative Chemistry.** For Studies of Water Solution and Mass Action. *Twelfth Edition, entirely rewritten*. 12mo, cloth.....net, \$1.50
- PRITCHARD, O. G.** **The Manufacture of Electric-light Carbons.** Illustrated. 8vo, paper..... \$0.60
- PROST, E.** **Manual of Chemical Analysis as Applied to the Assay of Fuels, Ores, Metals, Alloys, Salts, and other Mineral Products.** Translated from the original by J. C. Smith. Part I, Fuels, Waters, Ores, Salts, and other mineral industrial products; Part II, Metals; Part III, Alloys. 8vo, cloth...net, \$4.50
- PULLEN, W. W. F.** **Application of Graphic Methods to the Design of Structures.** Specially prepared for the use of Engineers. A Treatment by Graphic Methods of the Forces and Principles necessary for consideration in the Design of Engineering Structures, Roofs, Bridges, Trusses, Framed Structures, Wells, Dams, Chimneys, and Masonry Structures. 12mo, cloth, profusely illustrated.....net, \$2.50
- PULSIFER, W. H.** **Notes for a History of Lead.** 8vo, cloth, gilt top..... \$4.00
- PUTSCH, A.** **Gas and Coal-dust Firing. A Critical Review of the Various Appliances Patented in Germany for this Purpose since 1885.** With diagrams and figures. Translated from the German by Charles Salter. 8vo, cloth, illustrated.....net, \$3.00
- PYNCHON, T. R., Prof.** **Introduction to Chemical Physics,** designed for the use of Academies, Colleges and High Schools. Illustrated with numerous engravings, and containing copious experiments, with directions for preparing them. *New Edition, revised and enlarged*, and illustrated by 269 wood engravings. 8vo, cloth..... \$3.00

**RADFORD, C. S., Lieut. Handbook on Naval Gunnery.**

Prepared by Authority of the Navy Department. For the use of U. S. Navy, U. S. Marine Corps, and U. S. Naval Reserves. Revised and enlarged, with the assistance of Stokely Morgan, Lieut. U. S. N. *Third Edition, revised and enlarged.* 12mo, flexible leather. . . . . net, \$2.00

**RAFTER, G. W. Treatment of Septic Sewage** (*Van Nostrand's Science Series, No. 118*). 16mo, cloth. . . . . \$0.50

— **Tables for Sewerage and Hydraulic Engineers.** *In Press.*

— and **BAKER, M. N. Sewage Disposal in the United States.** Illustrations and folding plates. *Third Edition.* 8vo, cloth. . . . . \$6.00

**RAM, G. S. The Incandescent Lamp and its Manufacture.** 8vo, cloth. . . . . net, \$3.00

**RAMP, H. M. Foundry Practice** . . . . . *In Press.*

**RANDALL, J. E. A Practical Treatise on the Incandescent Lamp.** 16mo, cloth, illustrated. . . . . \$0.50**RANDALL, P. M. Quartz Operator's Handbook.** *New Edition, revised and enlarged, fully illustrated.* 12mo, cloth, \$2.00

**RANDAU, P. Enamels and Enamelling.** An introduction to the preparation and application of all kinds of enamels for technical and artistic purposes. For enamel-makers, workers in gold and silver, and manufacturers of objects of art. *Third German Edition.* Translated by Charles Salter. With figures, diagrams and tables. 8vo, cloth, illustrated. . . . . net, \$4.00

**RANKINE, W. J. M. Applied Mechanics.** Comprising the Principles of Statics and Cinematics, and Theory of Structures, Mechanism, and Machines. With numerous diagrams. *Seventeenth Edition,* thoroughly revised by W. J. Millar. 8vo, cloth. . . . . \$5.00

— **Civil Engineering.** Comprising Engineering Surveys, Earthwork, Foundations, Masonry, Carpentry, Metal-work, Roads, Railways, Canals, Rivers, Water-works, Harbors, etc. With numerous tables and illustrations. *Twenty-first Edition,* thoroughly revised by W. J. Millar. 8vo, cloth. . . . \$6.50

- RANKINE, W. J. M.** *Machinery and Millwork.* Comprising the Geometry, Motions, Work, Strength, Construction, and Objects of Machines, etc. Illustrated with nearly 300 woodcuts. *Seventh Edition*, thoroughly revised by W. J. Millar. 8vo, cloth. \$5.00
- *The Steam-engine and Other Prime Movers.* With diagram of the Mechanical Properties of Steam. Folding plates, numerous tables and illustrations. *Fifteenth Edition*, thoroughly revised by W. J. Millar. 8vo, cloth. . . . . \$5.00
- *Useful Rules and Tables for Engineers and Others.* With Appendix, Tables, Tests and Formulæ for the use of Electrical Engineers. Comprising Submarine Electrical Engineering, Electric Lighting and Transmission of Power. By Andrew Jamieson, C.E., F.R.S.E. *Seventh Edition*, thoroughly revised by W. J. Millar. 8vo, cloth. . . . . \$4.00
- and **BAMBER, E. F., C.E.** *A Mechanical Text-book.* With numerous illustrations. *Fifth Edition.* 8vo, cloth. . \$3.50
- RAPHAEL, F. C.** *Localization of Faults in Electric Light and Power Mains*, with chapters on Insulation Testing. With figures and diagrams. *Second Edition, revised.* 8vo, cloth, illustrated. . . . . net, \$3.00
- RATEAU, A.** *Experimental Researches on the Flow of Steam through Nozzles and Orifices*, to which is added a note on the Flow of Hot Water. (Extrait des Annales des Mines, January, 1902.) Authorized translation by H. Boyd Brydon. With figures, tables, and folding plates. 8vo, cloth, illustrated. net, \$1.50
- RAUTENSTRAUCH, Prof. W.** *Syllabus of Lectures and Notes on the Elements of Machine Design.* With blank pages for note-taking. 8vo, cloth, illustrated. . . . . net, \$1.50
- RAYMOND, E. B.** *Alternating-current Engineering Practically Treated.* With numerous diagrams and figures. *Second Edition.* 12mo, cloth. . . . . net, \$2.50
- RAYNER, H.** *Silk Throwing and Waste Silk Spinning.* With numerous diagrams and figures. 8vo, cloth, illustrated, net, \$2.50
- RECIPES for the Color, Paint, Varnish, Oil, Soap and Drysaltery Trades.** Compiled by an Analytical Chemist. 8vo, cloth. . . . . \$3.50

**RECIPES FOR FLINT GLASS MAKING.** Being Leaves

from the mixing-book of several experts in the Flint Glass Trade. Containing up-to-date recipes and valuable information as to Crystal, Demi-crystal, and Colored Glass in its many varieties. It contains the recipes for cheap metal suited to pressing, blowing, etc., as well as the most costly Crystal and Ruby. British manufacturers have kept up the quality of this glass from the arrival of the Venetians to Hungry Hill, Stourbridge, up to the present time. The book also contains remarks as to the result of the metal as it left the pots by the respective metal mixers, taken from their own memoranda upon the originals. Compiled by a British Glass Master and Mixer. 12mo, cloth..... net, \$4.50

**REED'S ENGINEERS' HANDBOOK to the Local Marine**

Board Examinations for Certificates of Competency as First and Second Class Engineers. By W. H. Thorn. With the answers to the Elementary Questions. Illustrated by 358 diagrams and 37 large plates. *Seventeenth Edition, revised and enlarged.* 8vo, cloth..... \$5.00

— **Key to the Seventeenth Edition of Reed's Engineers'**

Handbook to the Board of Trade Examination for First and Second Class Engineers, and containing the workings of all the questions given in the examination papers. By W. H. Thorn. 8vo, cloth..... \$3.00

**REED. Useful Hints to Sea-going Engineers, and How to**

Repair and Avoid "Breakdowns"; also appendices containing Boiler Explosions, Useful Formulæ, etc. With 42 diagrams and 8 plates. *Third Edition, revised and enlarged.* 12mo, cloth..... \$1.50

— **Marine Boilers. A Treatise on the Causes and Pre-**

vention of their Priming, with Remarks on their General Management. 12mo, cloth, illustrated..... \$2.00

**REINHARDT, C. W. Lettering for Draftsmen, Engineers,**

and Students. A Practical System of Free-hand Lettering for Working Drawings. *Revised and enlarged edition. Eighteenth Thousand.* Oblong boards..... \$1.00

— **The Technic of Mechanical Drafting. A Practical**

guide to neat, correct and legible drawing, containing many illustrations, diagrams and full-page plates. 4to, cloth, illus... \$1.00

**REISER, F. Hardening and Tempering of Steel, in Theory**

and Practice. Translated from the German of the *third and enlarged edition*, by Arthur Morris and Herbert Robson. 8vo, cloth, 120 pages..... \$2.50



- REISER, N.** *Faults in the Manufacture of Woolen Goods, and their Prevention.* Translated from the *second German edition*, by Arthur Morris and Herbert Robson. 8vo, cloth, illustrated .....net, \$2.50
- *Spinning and Weaving Calculations with Special reference to Woolen Fabrics.* Translated from the German by Chas. Salter. 8vo, cloth, illustrated. ....net, \$5.00
- RICE, J. M., and JOHNSON, W. W.** *On a New Method of Obtaining the Differential of Functions, with especial reference to the Newtonian Conception of Rates or Velocities.* 12mo, paper..... \$0.50
- RIDEAL, S., D.Sc.** *Glue and Glue Testing, with figures and tables.* 8vo, cloth, illustrated.....net, \$4.00
- RIPPER, W.** *A Course of Instruction in Machine Drawing and Design for Technical Schools and Engineer Students.* With 52 plates and numerous explanatory engravings. Folio, cloth, net, \$6.00
- ROBERTSON, L. S.** *Water-tube Boilers.* Based on a short course of Lectures delivered at University College, London. With upward of 170 illustrations and diagrams. 8vo, cloth, illustrated. .... \$3.00
- ROBINSON, S. W.** *Practical Treatise on the Teeth of Wheels, with the theory and the use of Robinson's Odontograph. Third Edition, revised, with additions.* 16mo, cloth, illustrated. (Van Nostrand's Science Series.)..... \$0.50
- ROEBLING, J. A.** *Long and Short Span Railway Bridges.* Illustrated with large copper-plate engravings of plans and views. Imperial folio, cloth..... \$25.00
- ROLLINS, W.** *Notes on X-Light.* With 152 full-page plates. 8vo, cloth, illustrated.....net, \$7.50
- ROSE, J., M.E.** *The Pattern-makers' Assistant.* Embracing Lathe Work, Branch Work, Core Work, Sweep Work and Practical Gear Constructions, the Preparation and Use of Tools, together with a large collection of useful and valuable Tables. *Ninth Edition.* With 250 engravings. 8vo, cloth..... \$2.50

- ROSE, J., M.E.** **Key to Engines and Engine-running.** A Practical Treatise upon the Management of Steam-engines and Boilers for the use of those who desire to pass an examination to take charge of an engine or boiler With numerous illustrations, and Instructions upon Engineers' Calculations, Indicators, Diagrams, Engine Adjustments and other Valuable Information necessary for Engineers and Firemen 12mo. cloth Illus. \$2 50
- ROWAN, F. J.** **The Practical Physics of the Modern Steam-boiler.** With an Introduction by Prof R. H Thurston With numerous illustrations and diagrams 8vo, cloth, illustrated. \$7.50
- SABINE, R.** **History and Progress of the Electric Telegraph.** With descriptions of some of the apparatus *Second Edition, with additions* 12mo cloth .. \$1.25
- SAELTZER, A.** **Treatise on Acoustics in Connection with Ventilation.** 12mo. cloth. \$1.00
- SALOMONS, Sir D., M.A.** **Electric-light Installations.** A Practical Handbook. With numerous illustrations. Vol. I., The Management of Accumulators. *Ninth Edition, revised and mostly rewritten.* 12mo cloth. \$1.50  
Vol. II. *Seventh Edition, revised and enlarged.* Apparatus. 296 illustrations, 12mo, cloth. \$2.25  
Vol. III. *Seventh Edition, revised and enlarged.* Applications. 12mo, cloth. \$1.50
- SANFORD, P. G.** **Nitro-explosives.** A Practical Treatise concerning the Properties, Manufacture and Analysis of Nitrated Substances, including the Fulminates, Smokeless Powders and Celluloid. 8vo, cloth, 270 pages. \$3.00
- SAUNDERS, C. H.** **Handbook of Practical Mechanics** for use in the Shop and Draughting-room; containing Tables, Rules and Formulæ, and Solutions of Practical Problems by Simple and Quick Methods. 16mo, limp cloth. \$1.00
- SAUNNIER, C.** **Watchmaker's Handbook.** A Workshop Companion for those engaged in Watchmaking and allied Mechanical Arts. Translated by J. Tripplin and E. Rigg. *Second Edition, revised, with appendix.* 12mo, cloth. \$3.50
- SCHELLEN, H., Dr.** **Magneto-electric and Dynamo-electric Machines: their Construction and Practical Application to Electric Lighting, and the Transmission of Power.** Translated from the *third German edition* by N. S. Keith and Percy Neymann, Ph.D. With very large additions and notes relating to American Machines, by N. S. Keith. Vol. 1, with 353 illustrations. *Second Edition.* 8vo, cloth \$5.00

- SCHERER, R.** Casein: its Preparation and Technical Utilization. Translated from the German. 8vo, cloth, illustrated. . . . .*net*, \$3.00
- SCHMALL, C. N.** First Course in Analytical Geometry, Plane and Solid, with Numerous Examples. Containing figures and diagrams. 12mo, cloth, illustrated. . . . .*net*, \$1.75
- SCHMALL, C. N., and SHACK, S. M.** Elements of Plane Geometry. An Elementary Treatise. With many examples and diagrams. 12mo, half leather, illustrated. . . . .*net*, \$1.25
- SCHMEER, LOUIS.** Flow of Water: A New Theory of the Motion of Water under Pressure, and in Open Conduits. 8vo, cloth, illustrated. . . . .*In Press.*
- SCHUMANN, F.** A Manual of Heating and Ventilation in its Practical Application, for the use of Engineers and Architects. Embracing a Series of Tables and Formulæ for Dimensions of Heating, Flow and Return Pipes for Steam and Hot-water Boilers, Flues, etc. 12mo, illustrated, full roan. . . . . \$1.50
- SCHWEIZER, V.** Distillation of Resins, Resinate Lakes and Pigments; Carbon Pigments and Pigments for Typewriting Machines, Manifolders, etc. A description of the proper methods of distilling resin-oils, the manufacture of resinates, resin-varnishes, resin-pigments and enamel paints, the preparation of all kinds of carbon pigments, and printers' ink, lithographic inks and chalks, and also inks for typewriters, manifolders, and rubber stamps. With tables and 68 figures and diagrams. 8vo, cloth, illustrated. . . . .*net*, \$3.50
- SCIENCE SERIES, The Van Nostrand.** (Follows end of this list.)
- SCRIBNER, J. M.** Engineers' and Mechanics' Companion. Comprising United States Weights and Measures, Mensuration of Superfices and Solids, Tables of Squares and Cubes, Square and Cube Roots, Circumference and Areas of Circles, the Mechanical Powers, Centres of Gravity, Gravitation of Bodies, Pendulums, Specific Gravity of Bodies, Strength, Weight and Crush of Materials, Water-wheels, Hydrostatics, Hydraulics, Statics, Centres of Percussion and Gyration, Friction Heat, Tables of the Weight of Metals, Scantling, etc., Steam and Steam-engine. *Twenty-first Edition, revised.* 16mo, full morocco. . . . . \$1.50

- SEATON, A. E.** A Manual of Marine Engineering. Comprising the Designing, Construction and Working of Marine Machinery. With numerous tables and illustrations reduced from Working Drawings. *Fifteenth Edition*, revised throughout, with an additional chapter on Water-tube Boilers. 8vo, cloth. \$6.00
- and **ROUNTHWAITE, H. M.** A Pocket-book of Marine Engineering Rules and Tables. For the use of Marine Engineers and Naval Architects, Designers, Draughtsmen, Superintendents and all engaged in the design and construction of Marine Machinery, Naval and Mercantile. *Seventh Edition*, revised and enlarged. Pocket size. Leather, with diagrams. \$3.00
- SEIDELL, A.** Handbook of Solubilities. 12mo, cloth. *In Press.*
- SEVER, G. F., Prof.** Electrical Engineering Experiments and Tests on Direct-current Machinery. With diagrams and figures. 8vo pamphlet, illustrated. . . . . net, \$1.00
- and **TOWNSEND, F.** Laboratory and Factory Tests in Electrical Engineering. *Second Edition*. 8vo, cloth, illustrated. . . . . net, \$2.50
- SEWALL, C. H.** Wireless Telegraphy. With diagrams and engravings. *Second Edition, corrected*. 8vo, cloth, illustrated. . . . . net, \$2.00
- **Lessons in Telegraphy.** For use as a text-book in schools and colleges, or for individual students. Illustrated. 12mo, cloth. . . . . \$1.00
- SEWELL, T.** Elements of Electrical Engineering. A First Year's Course for Students. *Second Edition, revised*, with additional chapters on Alternating-current Working and Appendix of Questions and Answers. With many diagrams, tables and examples. 8vo, cloth, illustrated, 432 pages. . . . . net, \$3.00
- SEXTON, A. H.** Fuel and Refractory Materials. 8vo, cloth. . . . . \$2.00
- **Chemistry of the Materials of Engineering.** A Handbook for Engineering Students. With tables, diagrams and illustrations. 12mo, cloth, illustrated. . . . . \$2.50
- SEYMOUR, A.** Practical Lithography. With figures and engravings. 8vo, cloth, illustrated. . . . . net, \$2.50



- SHAW, S.** *The History of the Staffordshire Potteries, and the Rise and Progress of the Manufacture of Pottery and Porcelain; with references to genuine specimens, and notices of eminent potters. A re-issue of the original work published in 1829.* 8vo, cloth, illustrated. . . . . net, \$3.00
- **Chemistry of the Several Natural and Artificial Heterogeneous Compounds used in Manufacturing Porcelain, Glass and Pottery.** Re-issued in its original form, published in 1837. 8vo, cloth. . . . . net, \$5.00
- SHELDON, S., Ph.D., and MASON, H., B.S.** *Dynamo-electric Machinery: its Construction, Design and Operation, Direct-current Machines. Fifth Edition, revised.* 8vo, cloth, illustrated. . . . . net, \$2.50
- **Alternating-current Machines: being the second volume of the author's "Dynamo-electric Machinery: its Construction, Design and Operation."** With many diagrams and figures. (Binding uniform with volume I.) *Fourth Edition.* 8vo, cloth, illustrated. . . . . net, \$2.50
- SHIELDS, J. E.** *Notes on Engineering Construction.* Embracing Discussions of the Principles involved, and Descriptions of the Material employed in Tunneling, Bridging, Canal and Road Building, etc. 12mo, cloth. . . . . \$1.50
- SHOCK, W. H.** *Steam Boilers: their Design, Construction and Management.* 4to, half morocco. . . . . \$15.00
- SHREVE, S. H.** *A Treatise on the Strength of Bridges and Roofs.* Comprising the determination of algebraic formulas for strains in Horizontal, Inclined or Rafter, Triangular, Bow-string, Lenticular and other Trusses, from fixed and moving loads, with practical applications and examples, for the use of Students and Engineers. 87 woodcut illustrations. *Fourth Edition.* 8vo, cloth. . . . . \$3.50
- SHUNK, W. F.** *The Field Engineer. A Handy Book of practice in the Survey, Location and Track-work of Railroads, containing a large collection of Rules and Tables, original and selected, applicable to both the Standard and Narrow Gauge, and prepared with special reference to the wants of the young Engineer. Sixteenth Edition, revised and enlarged.* With addenda 12mo, morocco, tucks. . . . . \$2.50

**SIMMS, F. W.** **A Treatise on the Principles and Practice of Leveling.** Showing its application to purposes of Railway Engineering, and the Construction of Roads, etc. Revised and corrected, with the addition of Mr. Laws' Practical Examples for setting out Railway Curves. Illustrated. 8vo, cloth. . . . . \$2.50

— **Practical Tunneling.** Fourth Edition, Revised and greatly extended. With additional chapters illustrating recent practice by D. Kinnear Clark. With 36 plates and other illustrations. Imperial 8vo, cloth. . . . . \$8.00

**SIMPSON, G.** **The Naval Constructor. A Vade Mecum of Ship Design,** for Students, Naval Architects, Ship Builders and Owners, Marine Superintendents, Engineers and Draughtsmen. 12mo, morocco, illustrated, 500 pages. . . . . *net*, \$5.00

**SLATER, J. W.** **Sewage Treatment, Purification and Utilization.** A Practical Manual for the Use of Corporations, Local Boards, Medical Officers of Health, Inspectors of Nuisances, Chemists, Manufacturers, Riparian Owners, Engineers and Rate-payers. 12mo, cloth. . . . . \$2.25

**SMITH, F. E.** **Handbook for Mechanics.** 12mo, cloth, illustrated. . . . . *In Press.*

— **Mechanics for Practical Men.** 8vo, cloth, about 400 pp., illustrated. . . . . *In Press.*

— **I. W., C.E.** **The Theory of Deflections and of Latitudes and Departures.** With special applications to Curvilinear Surveys, for Alignments of Railway Tracks. Illustrated. 16mo, morocco, tucks. . . . . \$3.00

— **J. C.** **Manufacture of Paint. A Practical Handbook for Paint Manufacturers, Merchants and Painters** With 60 illustrations and one large diagram. 8vo, cloth. . . . . *net*, \$3.00

**SNELL, A. T.** **Electric Motive Power: The Transmission and Distribution of Electric Power by Continuous and Alternate Currents.** With a Section on the Applications of Electricity to Mining Work. *Second Edition.* 8vo, cloth, illustrated. . . . . *net*, \$4.00

**SNOW, W. G., and NOLAN, T.** **Ventilation of Buildings.** 16mo, cloth. (Van Nostrand's Science Series.) . . . . . \$0.50

**SODDY, F.** **Radio-Activity: An elementary treatise from the standpoint of the disintegration theory.** With 40 figures and diagrams. 8vo, cloth, illustrated. . . . . *net*, \$3.00

- SOXHLET, D. H.** Art of Dyeing and Staining Marble, Artificial Stone, Bone, Horn, Ivory and Wood, and of imitating all sorts of Wood. A practical Handbook for the use of Joiners, Turners, Manufacturers of Fancy Goods, Stick and Umbrella Makers, Comb Makers, etc. Translated from the German by Arthur Morris and Herbert Robson, B.Sc. 8vo, cloth, 170 pages. . . . . *net*, \$2.50
- SPANG, H. W.** A Practical Treatise on Lightning Protection. With figures and diagrams. 12mo, cloth. . . . . \$1.00
- SPEYERS, C. L.** Text-book of Physical Chemistry. 8vo, cloth. . . . . \$2.25
- STAHL, A. W., and WOODS, A. T.** Elementary Mechanism. A Text-book for Students of Mechanical Engineering. *Fifteenth Edition.* 12mo, cloth. . . . . \$2.00
- STALEY, C., and PIERSON, G. S.** The Separate System of Sewerage: its Theory and Construction. *Third Edition, revised and enlarged.* With chapter on Sewage Disposal. With maps, plates and illustrations. 8vo, cloth. . . . . \$3.00
- STANDAGE, H. C.** Leatherworkers' Manual: being a Compendium of Practical Recipes and Working Formulæ for Curriers, Boot-makers, Leather Dressers, Blacking Manufacturers, Saddlers, Fancy Leather Workers, and all persons engaged in the manipulation of leather. 8vo, cloth. . . . . *net*, \$3.50
- Sealing Waxes, Wafers, and Other Adhesives. For the Household, Office, Workshop and Factory. 8vo, cloth, 96 pages. . . . . *net*, \$2.00
- STEWART, R. W.** Text-book of Heat. Illustrated. 8vo, cloth. . . . . \$1.00
- Text-book of Magnetism and Electricity. 160 Illustrations and numerous examples. 12mo, cloth. . . . . \$1.00
- STILES, A.** Tables for Field Engineers. Designed for Use in the Field. Tables containing all the Functions of a One Degree Curve, from which a corresponding one can be found for any required Degree. Also, Tables of Natural Sines and Tangents. 12mo, morocco, tucks. . . . . \$2.00

- STILLMAN, P.** Steam-engine Indicator and the Improved Manometer Steam and Vacuum Gauges; their Utility and Application. *New edition.* 12mo, flexible cloth..... \$1.00
- STODOLA, Dr. A.** Steam Turbines. With an appendix on Gas Turbines, and the future of Heat Engines. Authorized translation by Dr. Louis C. Loewenstein (Lehigh University). With 241 cuts and 3 lithographed tables. 8vo, cloth, illustrated. *net*, \$4.50
- STONE, R., Gen'l.** New Roads and Road Laws in the United States. 200 pages, with numerous illustrations. 12mo, cloth..... \$1.00
- STONEY, B. D.** The Theory of Stresses in Girders and Similar Structures. With Observations on the Application of Theory to Practice, and Tables of Strength and other Properties of Materials. *New revised edition*, with numerous additions on Graphic Statics, Pillars, Steel, Wind Pressure, Oscillating Stresses, Working Loads, Riveting, Strength and Tests of Materials. 777 pages, 143 illus. and 5 folding-plates. 8vo, cloth... \$12.50
- SUFFLING, E. R.** Treatise on the Art of Glass Painting. Prefaced with a Review of Ancient Glass. With engravings and colored plates. 8vo, cloth..... *net*, \$3.50
- SWEET, S. H.** Special Report on Coal, Showing its Distribution, Classification, and Costs delivered over Different Routes to Various Points in the State of New York and the Principal Cities on the Atlantic Coast. With maps. 8vo, cloth... \$3.00
- SWOOPE, C. W.** Practical Lessons in Electricity: Principles, Experiments, and Arithmetical Problems. An Elementary Text-book. With numerous tables, formulæ, and two large instruction plates. 8vo, cloth, illustrated. *Seventh Edition.* *net*, \$2.00
- TAILFER, L.** Practical Treatise on the Bleaching of Linen and Cotton Yarn and Fabrics. With tables and diagrams. Translated from the French by John Geddes McIntosh. 8vo, cloth, illustrated..... *net*, \$5.00
- TEMPLETON, W.** The Practical Mechanic's Workshop Companion. Comprising a great variety of the most useful rules and formulæ in Mechanical Science, with numerous tables of practical data and calculated results facilitating mechanical operations. Revised and enlarged by W. S. Hutton. 12mo, morocco..... \$2.00



- THOM, C., and JONES, W. H.** Telegraphic Connections: embracing Recent Methods in Quadruplex Telegraphy. 20 full-page plates, some colored. Oblong, 8vo, cloth..... \$1.50
- THOMAS, C. W.** Paper-makers' Handbook. A Practical Treatise. Illustrated. . . . . *In Press.*
- THOMPSON, A. B.** Oil Fields of Russia and the Russian Petroleum Industry. A Practical Handbook on the Exploration, Exploitation, and Management of Russian Oil Properties, including Notes on the Origin of Petroleum in Russia, a Description of the Theory and Practice of Liquid Fuel, and a Translation of the Rules and Regulations concerning Russian Oil Properties. With numerous illustrations and photographic plates and a map of the Balakhany-Saboontchy-Romany Oil Field. 8vo, cloth, illustrated . . . . . *net*, \$7.50
- THOMPSON, E. P., M.E.** How to Make Inventions; or, Inventing as a Science and an Art. A Practical Guide for Inventors. *Second Edition.* 8vo, boards..... \$0.50
- **Roentgen Rays and Phenomena of the Anode and Cathode.** Principles, Applications, and Theories. For Students, Teachers, Physicians, Photographers, Electricians and others. Assisted by Louis M. Pignolet, N. D. C. Hodges and Ludwig Gutmann, E.E. With a chapter on Generalizations, Arguments, Theories, Kindred Radiations and Phenomena. By Professor Wm. Anthony. 50 diagrams, 40 half-tones. 8vo, cloth..... \$1.00
- THOMPSON, W. P.** Handbook of Patent Law of All Countries. *Thirteenth Edition, completely revised, March, 1905.* 16mo, cloth. . . . . \$1.50
- THORNLEY, T.** Cotton Combing Machines. With Numerous tables, engravings and diagrams. 8vo, cloth, illustrated. 343 pages. . . . . *net*, \$3.00
- THURSO, J. W.** Modern Turbine Practice and Water-Power Plants. With eighty-eight figures and diagrams. 8vo, cloth, illustrated. . . . . *net*, \$4.00
- TOCH, M.** Chemistry and Technology of Mixed Paints. 8vo, cloth. . . . . *In Press.*

- TODD, J., and WHALL, W. B.** *Practical Seamanship for Use in the Merchant Service: including all ordinary subjects; also Steam Seamanship, Wreck Lifting, Avoiding Collision, Wire Splicing, Displacement and everything necessary to be known by seamen of the present day. Fifth Edition, with 247 illustrations and diagrams.* 8vo, cloth..... net, \$7.50
- TOMPKINS, A. E.** *Text-book of Marine Engineering. Second Edition, entirely rewritten, rearranged, and enlarged. With over 250 figures, diagrams, and full-page plates.* 8vo, cloth, illustrated. .... net, \$6.00
- TOOTHED GEARING.** *A Practical Handbook for Offices and Workshops. By a Foreman Patternmaker.* 184 illustrations. 12mo, cloth..... \$2.25
- TRATMAN, E. E. R.** *Railway Track and Track-work. With over 200 illustrations.* 8vo, cloth..... \$3.00
- TRAVERSE TABLE, Showing Latitude and Departure** for each Quarter Degree of the Quadrant, and for Distances from 1 to 100, to which is appended a Table of Natural Sines and Tangents for each five minutes of the Quadrant. (Reprinted from Scribner's Pocket Table Book.) *Van Nostrand's Science Series.* 16mo, cloth..... \$0.50  
Morocco..... \$1.00
- TRINKS, W., and HOUSUM, C.** *Shaft Governors.* 16mo, cloth, illustrated. (Van Nostrand's Science Series.)..... \$0.50
- TUCKER, J. H., Dr.** *A Manual of Sugar Analysis, including the Applications in General of Analytical Methods to the Sugar Industry. With an Introduction on the Chemistry of Cane-sugar, Dextrose, Levulose, and Milk-sugar. Sixth Edition.* 8vo, cloth, illustrated..... \$3.50
- TUMLIRZ, O., Dr.** *Potential and its Application to the Explanation of Electrical Phenomena, Popularly Treated. Translated from the German by D. Robertson.* 12mo, cloth, ill. \$1.25
- TUNNER, P. A.** *Treatise on Roll-turning for the Manufacture of Iron. Translated and adapted by John B. Pearse, of the Pennsylvania Steel Works, with numerous engravings, woodcuts.* 8vo, cloth, with folio atlas of plates..... \$10.00
- TURBAYNE, A. A.** *Alphabets and Numerals. With 27 plates.* 4to, boards..... \$2.00

- UNDERHILL, C. R.** *The Electro-magnet. New and revised edition.* 8vo, cloth, illustrated. . . . . *net*, \$1.50
- URQUHART, J. W.** *Electric Light Fitting. Embodying Practical Notes on Installation Management. A Handbook for Working Electrical Engineers. With numerous illustrations.* 12mo, cloth. . . . . \$2.00
- **Electro-plating.** *A Practical Handbook on the Deposition of Copper, Silver, Nickel, Gold, Brass, Aluminium, Platinum, etc. Fourth Edition.* 12mo. . . . . \$2.00
- **Electrotyping.** *A Practical Manual Forming a New and Systematic Guide to the Reproduction and Multiplication of Printing Surfaces, etc.* 12mo. . . . . \$2.00
- **Electric Ship Lighting.** *A Handbook on the Practical Fitting and Running of Ship's Electrical Plant. For the Use of Ship Owners and Builders, Marine Electricians and Sea-going Engineers-in-Charge. Illustrated.* 12mo, cloth. . . . . \$3.00
- UNIVERSAL TELEGRAPH CIPHER CODE.** *Arranged for General Correspondence.* 12mo, cloth. . . . . \$1.00
- VAN NOSTRAND'S Chemical Annual,** based on Biedermann's "Chemiker Kalender." Edited by Prof. J. C. Olsen, with the co-operation of Eminent Chemists. First year of issue 1906. 12mo, cloth, illustrated. . . . . *In Press.*
- **Engineering Magazine.** *Complete Sets, 1869 to 1886 inclusive.* 35 vols., in cloth. . . . . \$60.00  
     " " in half morocco. . . . . \$100.00
- **Year Book of Mechanical Engineering Data.** *With many tables and diagrams. (First Year of issue 1906.) In Press.*
- VAN WAGENEN, T. F.** *Manual of Hydraulic Mining. For the Use of the Practical Miner. Revised and enlarged edition.* 18mo, cloth. . . . . \$1.00
- VILLON, A. M.** *Practical Treatise on the Leather Industry. With many tables and illustrations and a copious index. A translation of Villon's "Traite Pratique de la Fabrication des Cuirs et du Travail des Peaux," by Frank T. Addyman, B.Sc.* 8vo, cloth, illustrated. . . . . *net*, \$10.00

**VINCENT, C.** *Ammonia and its Compounds: their Manufacture and Uses.* Translated from the French by M. J. Salter. 8vo, cloth, illustrated. . . . . *net*, \$2.00

**VOLK, C.** *Haulage and Winding Appliances Used in Mines.* With plates and engravings. Translated from the German. 8vo, cloth, illustrated. . . . . *net*, \$4.00

**VON GEORGIEVICS, G.** *Chemical Technology of Textile Fibres: their Origin, Structure, Preparation, Washing, Bleaching, Dyeing, Printing, and Dressing.* Translated from the German by Charles Salter. With many diagrams and figures. 8vo, cloth, illustrated. 306 pages. . . . . *net*, \$4.50  
*Contents.*—The Textile Fibres; Washing, Bleaching, and Carbonizing; Mordants and Mordanting; Dyeing, Printing, Dressing and Finishing; Index.

— *Chemistry of Dyestuffs.* Translated from the Second German edition by Chas. Salter. 8vo, cloth, 412 pages. . . . . *net*, \$4.50

**WABNER, R.** *Ventilation in Mines.* Translated from the German by Charles Salter. With plates and engravings. 8vo, cloth, illustrated, 240 pages. . . . . *net*, \$4.50

**WADE, E. J.** *Secondary Batteries: their Theory, Construction and Use.* With innumerable diagrams and figures. 8vo, cloth, illustrated, 492 pages. . . . . *net*, \$4.00

**WALKER, F., C.E.** *Aërial Navigation. A Practical Handbook on the Construction of Dirigible Balloons, Aërostats, Aëroplanes and Aëromotors.* With diagrams, tables and illustrations. 8vo, cloth, illustrated, 151 pages. . . . . *net*, \$3.00

**WALKER, S. F.** *Electrical Engineering in Our Homes and Workshops. A Practical Treatise on Auxiliary Electrical Apparatus. Third Edition, revised, with numerous illustrations.* 8vo, cloth . . . . . \$2.00

— *Electric Lighting for Marine Engineers, or How to Light a Ship by the Electric Light and How to Keep the Apparatus in Order. Second Edition.* 103 illus., 8vo, cloth. . . . . \$2.00

**WALKER, W. H.** *Screw Propulsion. Notes on Screw Propulsion; its Rise and History.* 8vo, cloth. . . . . \$0.75

**WALLING, B. T., Lieut. Com. U.S.N., and MARTIN, JULIUS.** *Electrical Installations of the United States Navy.* With many diagrams and engravings. 8vo, cloth, illustrated. . . . . *In Press.*



- WALLIS TAYLER, A. J.** **Bearings and Lubrication.** A Handbook for Every user of Machinery. Fully illustrated. 8vo, cloth. . . . . \$1.50
- **Modern Cycles, a Practical Handbook on Their Construction and Repair.** With 300 illustrations. 8vo, cloth. \$4.00
- **Motor Cars, or Power Carriages for Common Roads.** With numerous illustrations. 8vo, cloth. . . . . \$1.80
- **Motor Vehicles for Business Purposes.** 8vo, cloth, illustrated. . . . . *net*, \$3.50.
- **Refrigerating and Ice-making Machinery.** A Descriptive Treatise for the use of persons employing refrigerating and ice-making installations, and others. 8vo, cloth, illustrated. \$3.00
- **Refrigeration and Cold Storage: being a Complete practical treatise on the art and science of refrigeration.** 600 pages, 361 diagrams and figures. 8vo, cloth . . . . . *net*, \$4.50
- **Sugar Machinery.** A Descriptive Treatise, devoted to the Machinery and Apparatus used in the Manufacture of Cane and Beet Sugars. 12mo, cloth, illustrated. . . . . \$2.00
- WANKLYN, J. A.** **A Practical Treatise on the Examination of Milk and its Derivatives, Cream, Butter and Cheese.** 12mo, cloth. . . . . \$1.00
- **Water Analysis.** A Practical Treatise on the Examination of Potable Water. *Tenth Edition.* 12mo, cloth. . . . \$2.00
- WANSBROUGH, W. D.** **The A B C of the Differential Calculus.** 12mo, cloth. . . . . \$1.50
- WARD, J. H.** **Steam for the Million.** A Popular Treatise on Steam, and its application to the Useful Arts, especially to Navigation. 8vo, cloth. . . . . \$1.00
- WARING, G. E., Jr.** **Sewerage and Land Drainage.** Illustrated with woodcuts in the text, and full-page and folding plates. *New Edition.* . . . . . *In Press.*
- **Modern Methods of Sewage Disposals for Towns, Public Institutions and Isolated Houses.** *Second Edition, revised and enlarged.* 260 pages. Illustrated. Cloth. . . . . \$2.00

- WARING, G. E., Jr.** How to Drain a House. Practical Information for Householders. *Third Edition, enlarged.* 12mo, cloth..... \$1.25
- WARREN, F. D.** Handbook on Reinforced Concrete. 16mo, cloth, illustrated.....*net*, \$2.50
- WATSON, E. P.** Small Engines and Boilers. A Manual of Concise and Specific Directions for the Construction of Small Steam-engines and Boilers of Modern Types from five Horse-power down to model sizes. Illustrated with Numerous Diagrams and Half-tone Cuts. 12mo, cloth..... \$1.25
- WATT, A.** Electro-plating and Electro-refining of Metals: being a new edition of Alexander Watts' "Electro-Deposition." *Revised and largely rewritten* by Arnold Philip, B.Sc. With numerous figures and engravings. 8vo, cloth, illustrated, 680 pages..... *net*, \$4.50
- **Electro-metallurgy Practically Treated.** Eleventh Edition, *considerably enlarged.* 12mo, cloth..... \$1.00
- **The Art of Soap-making.** A Practical Handbook of the Manufacture of Hard and Soft Soaps, Toilet Soaps, etc. Including many New Processes, and a Chapter on the Recovery of Glycerine from Waste Lyes. With illustrations. *Fifth Edition, revised and enlarged.* 8vo, cloth..... \$3.00
- **The Art of Leather Manufacture:** being a Practical Handbook, in which the Operations of Tanning, Currying and Leather Dressing are Fully Described, and the Principles of Tanning Explained, and many Recent Processes Introduced. With numerous illustrations. *New Edition.* ..... *In Press.*
- WEALE, J.** A Dictionary of Terms Used in Architecture, Building, Engineering, Mining, Metallurgy, Archaeology, the Fine Arts, etc., with explanatory observations connected with applied Science and Art. *Fifth Edition, revised and corrected.* 12mo, cloth..... \$2.50
- WEBB, H. L.** A Practical Guide to the Testing of Insulated Wires and Cables. Illustrated. 12mo, cloth..... \$1.00
- **The Telephone Handbook.** 128 Illustrations. 146 pages. 16mo, cloth..... \$1.00

- WEEKES, R. W.** The Design of Alternate Current Transformers. Illustrated. 12mo, cloth. . . . . \$1.00
- WEISBACH, J.** A Manual of Theoretical Mechanics. *Ninth American edition.* Translated from the fourth augmented and improved German edition, with an Introduction to the Calculus by Eckley B. Coxe, A.M., Mining Engineer. 1,100 pages and 902 woodcut illustrations. 8vo, cloth. . . . . \$6.00  
Sheep. . . . . \$7.50
- and **HERRMANN, G.** Mechanics of Air Machinery. Authorized translation, with an appendix on American practice by A. Trowbridge. With figures, diagrams, and folding plates. 8vo, cloth, illustrated. . . . . *net*, \$3.75
- WESTON, E. B.** Tables Showing Loss of Head Due to Friction of Water in Pipes. *Second Edition.* 12mo, cloth. . \$1.50
- WEYMOUTH, F. M.** Drum Armatures and Commutators. (Theory and Practice.) A complete Treatise on the Theory and Construction of Drum Winding, and of commutators for closed-coil armatures, together with a full résumé of some of the principal points involved in their design, and an exposition of armature reactions and sparking. 8vo, cloth. . . . . \$3.00
- WHEELER, J. B., Prof.** Art of War. A Course of Instruction in the Elements of the Art and Science of War, for the Use of the Cadets of the United States Military Academy, West Point, N. Y. 12mo, cloth. . . . . \$1.75
- **Field Fortifications.** The Elements of Field Fortifications, for the Use of the Cadets of the United States Military Academy, West Point, N. Y. 12mo, cloth. . . . . \$1.75
- WHIPPLE, S., C.E.** An Elementary and Practical Treatise on Bridge Building. 8vo, cloth. . . . . \$3.00
- WHITE, W. H., K.C.B.** A Manual of Naval Architecture, for use of Officers of the Royal Navy, Officers of the Mercantile Marine, Yachtsmen, Shipowners and Shipbuilders. Containing many figures, diagrams and tables. Thick, 8vo, cloth, illustrated. . . . . \$9.00
- WILKINSON, H. D.** Submarine Cable-laying, Repairing, and Testing. 8vo, cloth. *New Edition.* . . . . . *In Press.*

**WILLIAMSON, R. S.** On the Use of the Barometer on Surveys and Reconnoissances. Part I. Meteorology in its Connection with Hypsometry. Part II. Barometric Hypsometry. With illustrative tables and engravings. 4to, cloth.... \$15.00

— **Practical Tables in Meteorology and Hypsometry, in connection with the use of the Barometer.** 4to, cloth..... \$2.50

**WILSON, G.** Inorganic Chemistry, with New Notation. Revised and enlarged by H. G. Madan. *New edition.* 12mo, cloth..... \$2.00

**WILLSON, F. N.** Theoretical and Practical Graphics. An Educational Course on the Theory and Practical Applications of Descriptive Geometry and Mechanical Drawing. Prepared for students in General Science, Engraving, or Architecture. *Third Edition, revised.* 4to, cloth, illustrated. .... net, \$4.00

— **Note-taking, Dimensioning and Lettering.** 4to, Cloth, illustrated. .... net, \$1.25

— **Third Angle Method of Making Working Drawings.** 4to, cloth, illustrated. .... net, \$1.25

— **Some Mathematical Curves, and Their Graphical Construction.** 4to, cloth, illustrated. .... net, \$1.50

— **Practical Engineering, Drawing, and Third Angle Projection.** 4to, cloth, illustrated. .... net, \$2.80

— **Shades, Shadows, and Linear Perspective.** 4to, Cloth, illustrated. .... net, \$1.00

— **Descriptive Geometry — Pure and Applied, with a chapter on Higher Plane Curves, and the Helix.** 4to, cloth illustrated. .... net, \$3.00

**WINKLER, C., and LUNGE, G.** Handbook of Technical Gas-Analysis. With figures and diagrams. *Second English edition.* Translated from the third greatly enlarged German edition, with some additions by George Lunge, Ph.D. 8vo, cloth, illustrated, 190 pages. .... \$4.00



- WOODBURY, D. V.** Treatise on the Various Elements of Stability in the Well-proportioned Arch. With numerous tables of the Ultimate and Actual Thrust. 8vo, half morocco. Illustrated. . . . . \$4.00
- WRIGHT, A. C.** Analysis of Oils and Allied Substances. 8vo, cloth, illustrated, 241 pages. . . . . *net*, \$3.50
- Simple Method for Testing Painters' Materials. 8vo, cloth, 160 pages. . . . . *net*, \$2.50
- WRIGHT, T. W., Prof. (Union College.)** Elements of Mechanics; including Kinematics, Kinetics and Statics. With applications. *Third Edition, revised and enlarged.* 8vo, cloth. . \$2.50
- and **HAYFORD, J. F.** Adjustment of Observations by the Method of Least Squares, with applications to Geodetic Work. *Second Edition, rewritten.* 8vo, cloth, illustrated. *net*, \$3.00
- YOUNG, J. E.** Electrical Testing for Telegraph Engineers. With Appendices consisting of Tables. 8vo, cloth, illus. . . \$4.00
- YOUNG SEAMAN'S MANUAL.** Compiled from Various Authorities, and Illustrated with Numerous Original and Select Designs, for the Use of the United States Training Ships and the Marine Schools. 8vo, half roan. . . . . \$3.00
- ZEUNER, A., Dr.** Technical Thermodynamics. Translated from the German, by Prof. J. F. Klein, Lehigh University. 8vo, cloth, illustrated. . . . . *In Press.*
- ZIMMER, G. F.** Mechanical Handling of Material. Being a treatise on the handling of material, such as coal, ore, timber, etc., by automatic and semi-automatic machinery, together with the various accessories used in the manipulation of such plant, also dealing fully with the handling, storing, and warehousing of grain. With 542 figures, diagrams, full-page and folding plates. Royal 8vo, cloth, illustrated. . . . . *net*, \$10.00
- ZIPSER, J.** Textile Raw Materials, and Their Conversion into Yarns. The study of the Raw Materials and the Technology of the Spinning Process. A Text-book for Textile, Trade and higher Technical Schools, as also for self-instruction. Based upon the ordinary syllabus and curriculum of the Imperial and Royal Weaving Schools. Translated from the German by Chas. Salter. 8vo, cloth, illustrated. . . . . *net*, \$5.00

# Catalogue of the Van Nostrand Science Series.

---

*THEY* are put up in a uniform, neat, and attractive form. 18mo, boards. Price 50 cents per volume. The subjects are of an eminently scientific character and embrace a wide range of topics, and are amply illustrated when the subject demands.

- No. 1. CHIMNEYS FOR FURNACES AND STEAM BOILERS. By R. Armstrong, C.E. Third American Edition. Revised and partly rewritten, with an Appendix on "Theory of Chimney Draught," by F. E. Idell, M.E.
- No. 2. STEAM-BOILER EXPLOSIONS. By Zerah Colburn. New Edition, revised by Prof. R. H. Thurston.
- No. 3. PRACTICAL DESIGNING OF RETAINING-WALLS. Fourth edition, by Prof. W. Cain.
- No. 4. PROPORTIONS OF PINS USED IN BRIDGES. By Charles E. Bender, C.E. Second edition, with Appendix.
- No. 5. VENTILATION OF BUILDINGS. By Wm. G. Snow, S.B., and Thos. Nolan, A.M.
- No. 6. ON THE DESIGNING AND CONSTRUCTION OF STORAGE Reservoirs. By Arthur Jacob, B.A. Third American edition, revised, with additions by E. Sherman Gould.
- No. 7. SURCHARGED AND DIFFERENT FORMS OF RETAINING-walls. By James S. Tate, C.E.
- No. 8. A TREATISE ON THE COMPOUND STEAM-ENGINE. By John Turnbull, Jr. 2nd edition, revised by Prof. S. W. Robinson.
- No. 9. A TREATISE ON FUEL. By Arthur V. Abbott, C.E. Founded on the original treatise of C. William Siemens, D.C.L. Third ed.
- No. 10. COMPOUND ENGINES. Translated from the French of A. Mallet. Second edition, revised with results of American Practice, by Richard H. Buel, C.E.
- No. 11. THEORY OF ARCHES. By Prof. W. Allan.
- No. 12. THEORY OF VOUSOIR ARCHES. By Prof. Wm. Cain. Third edition, revised and enlarged.
- No. 13. GASES MET WITH IN COAL MINES. By J. J. Atkinson. Third edition, revised and enlarged, to which is added The Action of Coal Dusts by Edward H. Williams, Jr.

D. VAN NOSTRAND CO.'S SCIENTIFIC PUBLICATIONS

- No. 14. FRICTION OF AIR IN MINES. By J. J. Atkinson. Second American edition.
- No. 15. SKEW ARCHES. By Prof. E. W. Hyde, C.E. Illustrated. Second edition.
- No. 16. GRAPHIC METHOD FOR SOLVING CERTAIN QUESTIONS in Arithmetic or Algebra. By Prof. G. L. Vose. Second edition.
- No. 17. WATER AND WATER-SUPPLY. By Prof. W. H. Corfield, of the University College, London. Second American edition.
- No. 18. SEWERAGE AND SEWAGE PURIFICATION. By M. N. Baker, Associate Editor "Engineering News." Second edition, revised and enlarged.
- No. 19. STRENGTH OF BEAMS UNDER TRANSVERSE LOADS. By Prof. W. Allan, author of "Theory of Arches." Second edition, revised.
- No. 20. BRIDGE AND TUNNEL CENTRES. By John B. McMaster, C.E. Second edition.
- No. 21. SAFETY VALVES. By Richard H. Buel, C.E. Third edition.
- No. 22. HIGH MASONRY DAMS. By E. Sherman Gould, M. Am. Soc. C. E.
- No. 23. THE FATIGUE OF METALS UNDER REPEATED STRAINS. With various Tables of Results and Experiments. From the German of Prof. Ludwig Spangenburg, with a Preface by S. H. Shreve, A.M.
- No. 24. A PRACTICAL TREATISE ON THE TEETH OF WHEELS. By Prof. S. W. Robinson. 2nd edition, revised, with additions.
- No. 25. THEORY AND CALCULATION OF CANTILEVER BRIDGES. By R. M. Wilcox.
- No. 26. PRACTICAL TREATISE ON THE PROPERTIES OF CONTINUOUS BRIDGES. By Charles Bender, C.E.
- No. 27. BOILER INCrustation AND CORROSION. By F. J. Rowan. New edition. Revised and partly rewritten by F. E. Idell.
- No. 28. TRANSMISSION OF POWER BY WIRE ROPES. By Albert W. Stahl, U.S.N. Second edition, revised.
- No. 29. STEAM INJECTORS, THEIR THEORY AND USE. Translated from the French of M. Leon Pochet.
- No. 30. MAGNETISM OF IRON VESSELS AND TERRESTRIAL Magnetism. By Prof. Fairman Rogers.

D. VAN NOSTRAND COMPANY'S

- No. 31. **THE SANITARY CONDITION OF CITY AND COUNTRY** Dwelling-houses. By George E. Waring, Jr. Second edition, revised.
- No. 32. **CABLE-MAKING FOR SUSPENSION BRIDGES.** By W. Hildenbrand, C.E.
- No. 33. **MECHANICS OF VENTILATION.** By George W. Rafter, C.E. Second edition, revised.
- No. 34. **FOUNDATIONS.** By Prof. Jules Gaudard, C.E. Translated from the French. Second edition.
- No. 35. **THE ANEROID BAROMETER: ITS CONSTRUCTION AND Use.** Compiled by George W. Plympton. Ninth edition, revised and enlarged.
- No. 36. **MATTER AND MOTION.** By J. Clerk Maxwell, M.A. Second American edition.
- No. 37. **GEOGRAPHICAL SURVEYING: ITS USES, METHODS, and Results.** By Frank De Yeaux Carpenter, C.E.
- No. 38. **MAXIMUM STRESSES IN FRAMED BRIDGES.** By Prof. William Cain, A.M., C.E. New and revised edition.
- No. 39. **A HANDBOOK OF THE ELECTRO-MAGNETIC TELE-graph.** By A. E. Loring. Fourth edition, revised.
- No. 40. **TRANSMISSION OF POWER BY COMPRESSED AIR.** By Robert Zahner, M.E. New edition, in press.
- No. 41. **STRENGTH OF MATERIALS.** By William Kent, C.E., Assoc. Editor "Engineering News." Second edition.
- No. 42. **THEORY OF STEEL-CONCRETE ARCHES, AND OF Vaulted Structures.** By Prof. Wm. Cain. Third edition, thoroughly revised.
- No. 43. **WAVE AND VORTEX MOTION.** By Dr. Thomas Craig, of Johns Hopkins University.
- No. 44. **TURBINE WHEELS.** By Prof. W. P. Trowbridge, Columbia College. Second edition. Revised.
- No. 45. **THERMO-DYNAMICS.** By Prof. H. T. Eddy, University of Cincinnati. New edition, in press.
- No. 46. **ICE-MAKING MACHINES.** From the French of M. Le Doux. Revised by Prof. J. E. Denton, D. S. Jacobus, and A. Riesenberger. Fifth edition, revised.
- No. 47. **LINKAGES: THE DIFFERENT FORMS AND USES OF Articulated Links.** By J. D. C. De Roos.
- No. 48. **THEORY OF SOLID AND BRACED ELASTIC ARCS** By William Cain, C.E.
- No. 49. **MOTION OF A SOLID IN A FLUID.** By Thomas Craig, Ph.D.



## SCIENTIFIC PUBLICATIONS.

- No. 50. DWELLING-HOUSES: THEIR SANITARY CONSTRUCTION and Arrangements. By Prof. W. H. Corfield.
- No. 51. THE TELESCOPE: OPTICAL PRINCIPLES INVOLVED IN the Construction of Refracting and Reflecting Telescopes, with a new chapter on the Evolution of the Modern Telescope, and a Bibliography to date. With diagrams and folding plates. By Thomas Nolan. Second edition, revised and enlarged.
- No. 52. IMAGINARY QUANTITIES: THEIR GEOMETRICAL INTERPRETATION. Translated from the French of M. Argand by Prof. A. S. Hardy.
- No. 53. INDUCTION COILS: HOW MADE AND HOW USED. Eleventh American edition.
- No. 54. KINEMATICS OF MACHINERY. By Prof. Alex. B. W. Kennedy. With an introduction by Prof. R. H. Thurston.
- No. 55. SEWER GASES: THEIR NATURE AND ORIGIN. By A. de Varona. Second edition, revised and enlarged.
- No. 56. THE ACTUAL LATERAL PRESSURE OF EARTHWORK. By Benj. Baker, M. Inst., C.E.
- No. 57. INCANDESCENT ELECTRIC LIGHTING. A Practical Description of the Edison System. By L. H. Latimer. To which is added the Design and Operation of Incandescent Stations, by C. J. Field; and the Maximum Efficiency of Incandescent Lamps, by John W. Howell.
- No. 58. VENTILATION OF COAL MINES. By W. Fairley, M.E., and Geo. J. André.
- No. 59. RAILROAD ECONOMICS; OR, NOTES WITH COMMENTS. By S. W. Robinson, C.E.
- No. 60. STRENGTH OF WROUGHT-IRON BRIDGE MEMBERS. By S. W. Robinson, C.E.
- No. 61. POTABLE WATER, AND METHODS OF DETECTING Impurities. By M. N. Baker. Second ed., revised and enlarged.
- No. 62. THEORY OF THE GAS-ENGINE. By Dougald Clerk. Third edition. With additional matter. Edited by F. E. Idell, M.E.
- No. 63. HOUSE-DRAINAGE AND SANITARY PLUMBING. By W. P. Gerhard. Tenth edition.
- No. 64. ELECTRO-MAGNETS. By A. N. Mansfield.
- No. 65. POCKET LOGARITHMS TO FOUR PLACES OF DECIMALS. Including Logarithms of Numbers, etc.
- No. 66. DYNAMO-ELECTRIC MACHINERY. By S. P. Thompson. With an Introduction by F. L. Pope. Third edition, revised.
- No. 67. HYDRAULIC TABLES FOR THE CALCULATION OF THE Discharge through Sewers, Pipes, and Conduits. Based on "Kutter's Formula." By P. J. Flynn.

D. VAN NOSTRAND COMPANY'S

- No. 68. STEAM-HEATING. By Robert Briggs. Third edition, revised, with additions by A. R. Wolff.
- No. 69. CHEMICAL PROBLEMS. By Prof. J. C. Foye. Fourth edition, revised and enlarged.
- No. 70. EXPLOSIVE MATERIALS. By Lieut. John P. Wisser.
- No. 71. DYNAMIC ELECTRICITY. By John Hopkinson, J. A. Shoolbred, and R. E. Day.
- No. 72. TOPOGRAPHICAL SURVEYING. By George J. Specht. Prof. A. S. Hardy, John B. McMaster, and H. F. Walling. Third edition, revised.
- No. 73. SYMBOLIC ALGEBRA; OR, THE ALGEBRA OF ALGEBRAIC NUMBERS. By Prof. William Cain.
- No. 74. TESTING MACHINES: THEIR HISTORY, CONSTRUCTION and Use. By Arthur V. Abbott.
- No. 75. RECENT PROGRESS IN DYNAMO-ELECTRIC MACHINES. Being a Supplement to "Dynamo-electric Machinery." By Prof. Sylvanus P. Thompson.
- No. 76. MODERN REPRODUCTIVE GRAPHIC PROCESSES. By Lieut. James S. Pettit, U.S.A.
- No. 77. STADIA SURVEYING. The Theory of Stadia Measurements. By Arthur Winslow. Sixth edition.
- No. 78. THE STEAM-ENGINE INDICATOR AND ITS USE. By W. B. Le Van.
- No. 79. THE FIGURE OF THE EARTH. By Frank C. Roberts, C.E.
- No. 80. HEALTHY FOUNDATIONS FOR HOUSES. By Glenn Brown.
- No. 81. WATER METERS: COMPARATIVE TESTS OF ACCURACY, Delivery, etc. Distinctive features of the Worthington, Kennedy, Siemens, and Hesse meters. By Ross E. Browne.
- No. 82. THE PRESERVATION OF TIMBER BY THE USE OF ANTI-SEPTICS. By Samuel Bagster Boulton, C.E.
- No. 83. MECHANICAL INTEGRATORS. By Prof. Henry S. H. Shaw, C.E.
- No. 84. FLOW OF WATER IN OPEN CHANNELS, PIPES, CONDUITS, Sewers, etc. With Tables. By P. J. Flynn, C.E.
- No. 85. THE LUMINIFEROUS ÆTHER. By Prof. De Volson Wood.
- No. 86. HANDBOOK OF MINERALOGY: DETERMINATION, DESCRIPTION, and Classification of Minerals Found in the United States. By Prof. J. C. Foye. Fifth edition, revised.

## SCIENTIFIC PUBLICATIONS.

- No. 87. **TREATISE ON THE THEORY OF THE CONSTRUCTION of Helicoidal Oblique Arches.** By John L. Culley, C.E.
- No. 88. **BEAMS AND GIRDERS.** Practical Formulas for their Resistance. By P. H. Philbrick.
- No. 89. **MODERN GUN COTTON: ITS MANUFACTURE, PROPERTIES, and Analyses.** By Lieut. John P. Wissler, U.S.A.
- No. 90. **ROTARY MOTION AS APPLIED TO THE GYROSCOPE.** By Major J. G. Barnard.
- No. 91. **LEVELING: BAROMETRIC, TRIGONOMETRIC, AND Spirit.** By Prof. I. O. Baker. Second edition.
- No. 92. **PETROLEUM: ITS PRODUCTION AND USE.** By Boverton Redwood, F.I.C., F.C.S.
- No. 93. **RECENT PRACTICE IN THE SANITARY DRAINAGE OF Buildings.** With Memoranda on the Cost of Plumbing Work. Second edition, revised and enlarged. By William Paul Gerhard, C.E.
- No. 94. **THE TREATMENT OF SEWAGE.** By Dr. C. Meymott Tidy.
- No. 95. **PLATE-GIRDER CONSTRUCTION.** By Isami Hiroi, C.E. Fourth edition, revised.
- No. 96. **ALTERNATE CURRENT MACHINERY.** By Gisbert Kapp, Assoc. M. Inst., C.E.
- No. 97. **THE DISPOSAL OF HOUSEHOLD WASTES.** By W. Paul Gerhard, Sanitary Engineer.
- No. 98. **PRACTICAL DYNAMO-BUILDING FOR AMATEURS. HOW to Wind for Any Output.** By Frederick Walker. Fully illustrated. Third edition.
- No. 99. **TRIPLE-EXPANSION ENGINES AND ENGINE TRIALS.** By Prof. Osborne Reynolds. Edited with notes, etc., by F. E. Idell, M.E.
- No. 100. **HOW TO BECOME AN ENGINEER; or, The Theoretical and Practical Training necessary in Fitting for the Duties of the Civil Engineer.** By Prof. Geo. W. Plympton.
- No. 101. **THE SEXTANT, and Other Reflecting Mathematical Instruments.** With Practical Hints for their Adjustment and Use. By F. R. Brainard, U. S. Navy.
- No. 102. **THE GALVANIC CIRCUIT INVESTIGATED MATHEMATICALLY.** By Dr. G. S. Ohm, Berlin, 1827. Translated by William Francis. With Preface and Notes by the Editor, Thomas D. Lockwood, M.I.E.E.

D. VAN NOSTRAND COMPANY'S

- No. 103. **THE MICROSCOPICAL EXAMINATION OF POTABLE Water.** With Diagrams. By Geo. W. Rafter. Second edition.
- No. 104. **VAN NOSTRAND'S TABLE-BOOK FOR CIVIL AND MECHANICAL ENGINEERS.** Compiled by Prof. Geo. W. Plympton.
- No. 105. **DETERMINANTS.** An Introduction to the Study of, with Examples and Applications. By Prof. G. A. Miller.
- No. 106. **COMPRESSED AIR.** Experiments upon the Transmission of Power by Compressed Air in Paris. (Popp's System.) By Prof. A. B. W. Kennedy. The Transmission and Distribution of Power from Central Stations by Compressed Air. By Prof. W. C. Unwin. Edited by F. E. Idell. Third edition.
- No. 107. **A GRAPHICAL METHOD FOR SWING BRIDGES.** A Rational and Easy Graphical Analysis of the Stresses in Ordinary Swing Bridges. With an Introduction on the General Theory of Graphical Statics, with Folding Plates. By Benjamin F. La Rue.
- No. 108. **SLIDE-VALVE DIAGRAMS.** A French Method for Constructing Slide-valve Diagrams. By Lloyd Bankson, B.S., Assistant Naval Constructor, U. S. Navy. 8 Folding Plates.
- No. 109. **THE MEASUREMENT OF ELECTRIC CURRENTS.** Electrical Measuring Instruments. By James Swinburne. Meters for Electrical Energy. By C. H. Wordingham. Edited, with Preface, by T. Commerford Martin. With Folding Plate and Numerous Illustrations.
- No. 110. **TRANSITION CURVES.** A Field-book for Engineers, Containing Rules and Tables for Laying out Transition Curves. By Walter G. Fox, C.E.
- No. 111. **GAS-LIGHTING AND GAS-FITTING.** Specifications and Rules for Gas-piping. Notes on the Advantages of Gas for Cooking and Heating, and Useful Hints to Gas Consumers. Third edition. By Wm. Paul Gerhard, C.E.
- No. 112. **A PRIMER ON THE CALCULUS.** By E. Sherman Gould, M. Am. Soc. C. E. Third edition, revised and enlarged.
- No. 113. **PHYSICAL PROBLEMS and Their Solution.** By A. Bourgonnon, formerly Assistant at Bellevue Hospital. Second ed.
- No. 114. **MANUAL OF THE SLIDE RULE.** By F. A. Halsey, of the "American Machinist." Third edition, corrected.
- No. 115. **TRAVERSE TABLE.** Showing the Difference of Latitude and Departure for Distances Between 1 and 100 and for Angles to Quarter Degrees Between 1 Degree and 90 Degrees. (Reprinted from Scribner's Pocket Table Book.)



## SCIENTIFIC PUBLICATIONS.

- No. 116. WORM AND SPIRAL GEARING. Reprinted from "American Machinist." By F. A. Halsey. Second revised and enlarged edition.
- No. 117. PRACTICAL HYDROSTATICS, AND HYDROSTATIC FORMULAS. With Numerous Illustrative Figures and Numerical Examples. By E. Sherman Gould.
- No. 118. TREATMENT OF SEPTIC SEWAGE, with Diagrams and Figures. By Geo. W. Rafter.
- No. 119. LAY-OUT OF CORLISS VALVE GEARS. With Folding Plates and Diagrams. By Sanford A. Moss, M.S., Ph.D Reprinted from "The American Machinist," with revisions and additions. Second edition.
- No. 120. ART OF GENERATING GEAR TEETH. By Howard A. Coombs. With Figures, Diagrams and Folding Plates. Reprinted from the "American Machinist."
- No. 121. ELEMENTS OF GAS ENGINE DESIGN. Reprint of a Set of Notes accompanying a Course of Lectures delivered at Cornell University in 1902. By Sanford A. Moss. Illustrated.
- No. 122. SHAFT GOVERNORS. By W. Trinks and C. Housum. Illustrated.
- No. 123. FURNACE DRAFT; ITS PRODUCTION BY MECHANICAL Methods. A Handy Reference Book, with figures and tables. By William Wallace Christie. Illustrated.





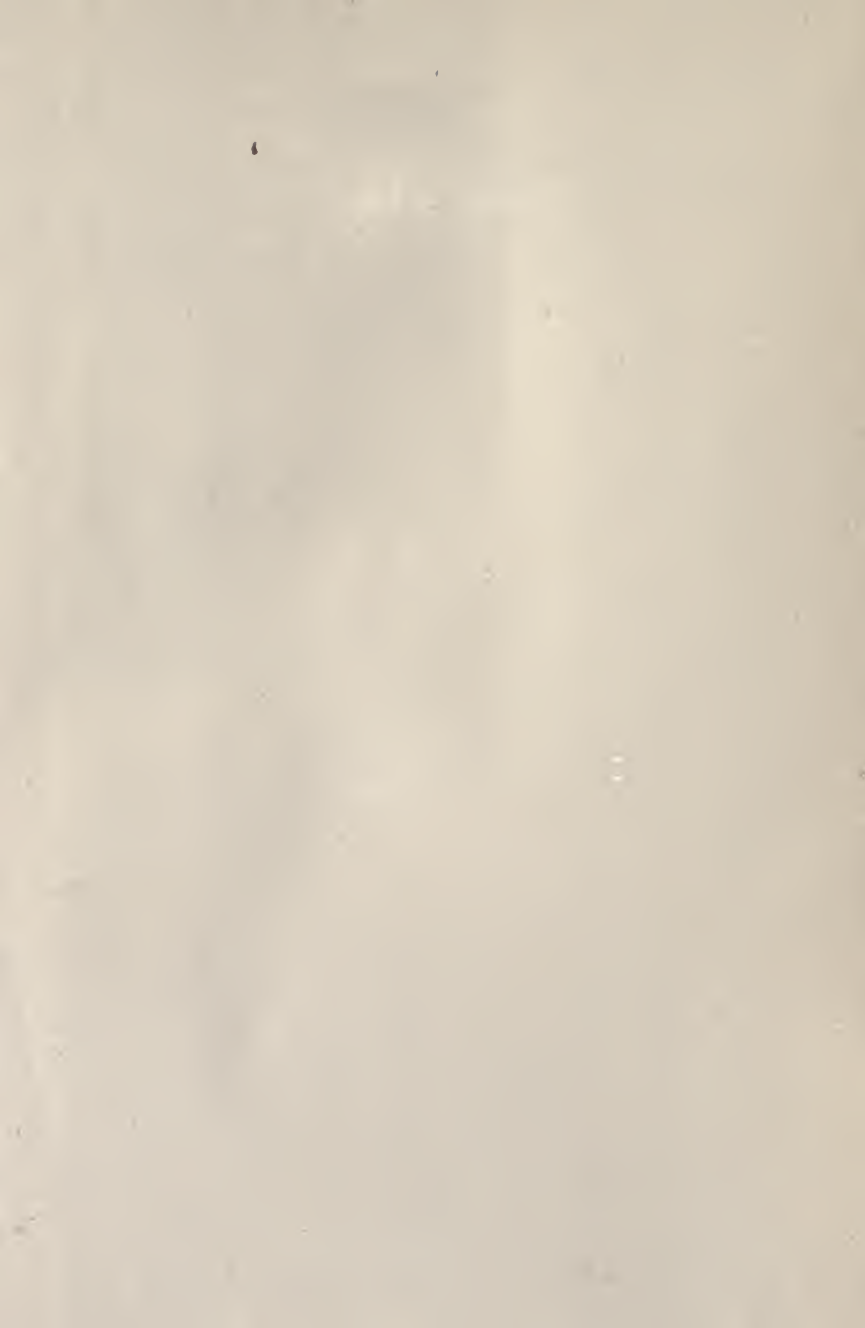

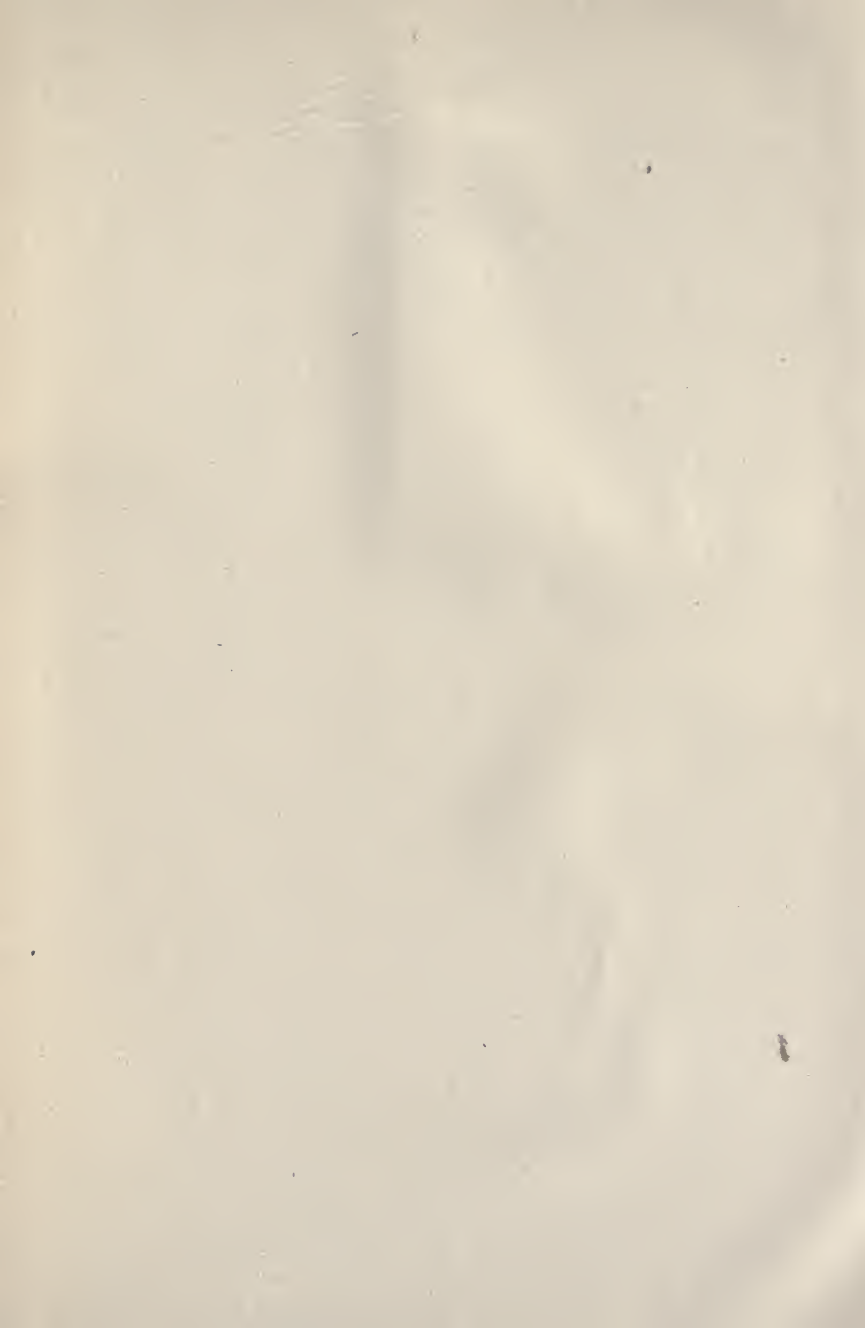





THIS BOOK IS DUE ON THE LAST DATE  
STAMPED BELOW

**AN INITIAL FINE OF 25 CENTS**

WILL BE ASSESSED FOR FAILURE TO RETURN  
THIS BOOK ON THE DATE DUE. THE PENALTY  
WILL INCREASE TO 50 CENTS ON THE FOURTH  
DAY AND TO \$1.00 ON THE SEVENTH DAY  
OVERDUE.

DEC 24 1934

JUN 17 1937

July 1  
15

27 APR 5 1 HB  
19 APR 5 1 LU

NOV 27 1992

AUTO DISCIRC NOV 17 '92

YC 66956

jsrl  
jsrl

U. C. BERKELEY LIBRARIES



C042451541

15020  
315  
B7

