

WELL-BORING

FOR WATER BRINE AND OIL

C. ISLER

LIBRARY -
OF THE
UNIVERSITY OF CALIFORNIA.

Class

WELL-BORING

FOR WATER, BRINE AND OIL



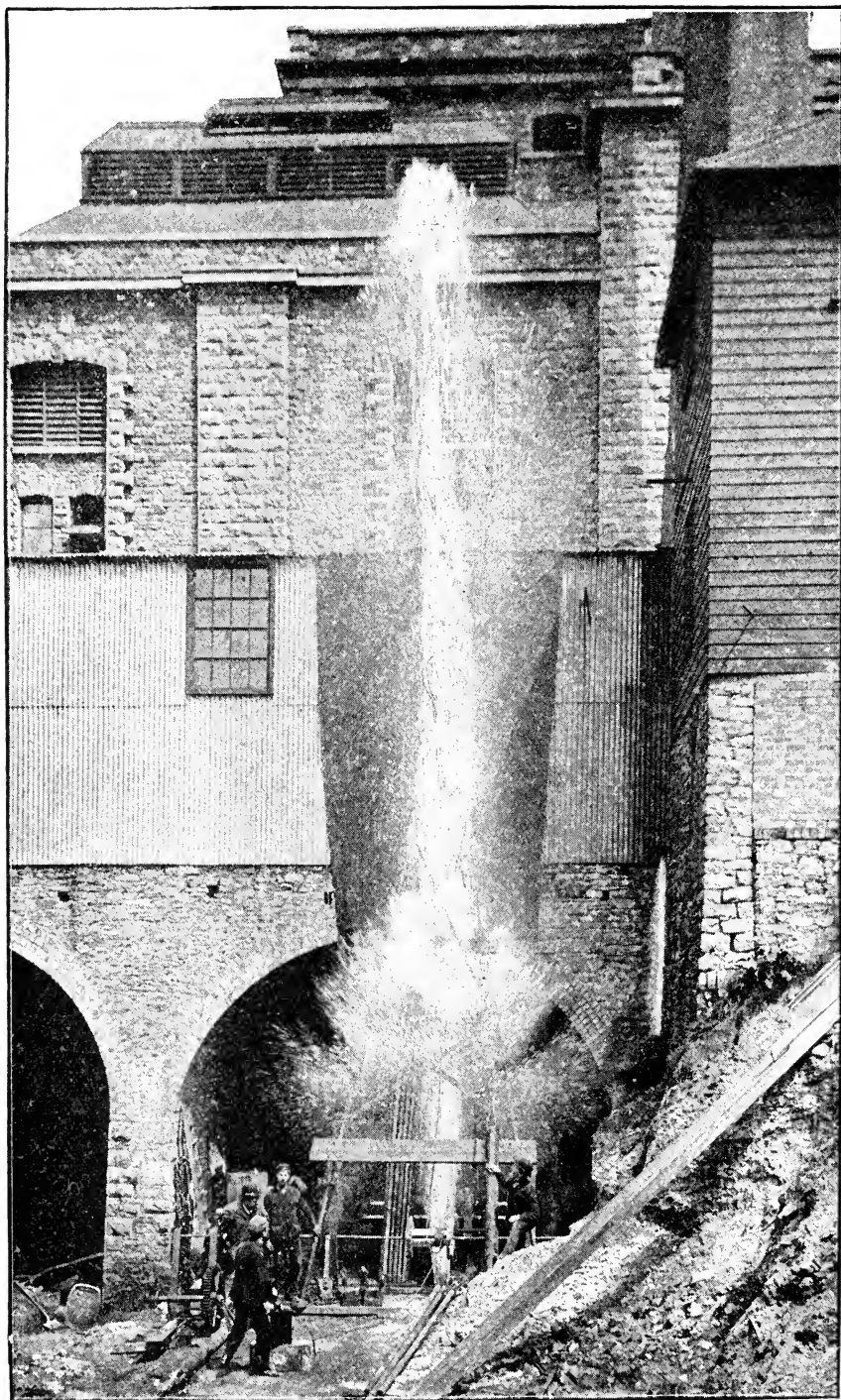

EFFECT OF A SHOT FIRED IN HARD ROCKS AT THE DEPTH OF 363 FEET FROM THE SURFACE IN A 7 $\frac{1}{2}$ -INCH INTERNAL DIAMETER ARTESIAN BORED TUBE WELL, FIXED FOR MESSRS. ARNOLD, PERRETT & CO., THE BREWERY, WICKWAR, GLOUCESTER.

WELL-BORING

FOR

WATER, BRINE AND OIL

*A MANUAL
OF CURRENT PRACTICE*

BY

C. ISLER

HYDRAULIC ENGINEER.



London

E. & F. N. SPON, LTD., 125 STRAND

New York

SPON AND CHAMBERLAIN, 12 CORTLANDT STREET

1902.

TR 12
I 8

GENERAL

P R E F A C E.



WITH the dissemination of knowledge bearing upon sanitation, and a general recognition of the terrible risks of pollution in wells supplied by surface drainage, it is to be hoped that the days of the shallow dug well are closed for ever.

No price would be too high to pay for absolute security against contamination of the most essential and most largely consumed article of our daily food ; and no matter how costly the deep bored well might be in comparison with the shallow dug well, its advantages would outweigh the initial expense.

But to such a high state of efficiency has well-boring now been brought by the most advanced firms who make a speciality of this branch of engineering, that the outlay based on even a five or seven years' supply only is much less in a deep tube well than in a shallow dug well.

Moreover, while the one is *never-failing* both in quantity and in quality, the shortcomings of the other are sure to be emphasised during periods of extreme drought when our needs are most urgent.

In districts where superficial streams are few or entirely wanting, such as in the more tropical portions of our great Australian and South African Colonies, the deep well is absolutely essential to occupation of the land for any pur-

pose, and the sinking of water bores commands the attention of a Government department. But a vast field yet remains neglected, and there are countless opportunities for private enterprise which would in a few years return immense fortunes. The average annual value of horses, cattle and sheep lost by thirst in the countries named must amount to millions sterling, and a deal of human sickness arises from pollution of air and water by their putrefying carcasses,—all which is remediable by deep wells.

Here in England, with generally more than an abundance of surface water, domestic drainage and factory effluents combine to taint all such supplies. To the brewer, the mineral-water manufacturer, the dyer, the paper-maker, and in many other industries, a constant and pure water-supply is of the first moment; hence the deep well with its reliable and unsullied flow is fast becoming a recognised indispensable at all factories and works of any pretensions, and many hundreds of such wells, ranging in depth from 150 to 500 feet and in capacity from 2000 to 35,000 gallons per hour, have been bored all over the country in the last few years.

Finally the large domestic consumer has commenced to realise the folly and cost of dependence on the shallow well or the water company, and not only have many country mansions recently been equipped with a deep tube-well and pumping or other water-lifting mechanism, furnishing an abundant supply independent of the weather, and affording increased protection against fire, but the same thing has been done in a great many of the big hotels and other establishments in London and the provinces. Besides the inestimable advantages of such an unrestricted regular and

pure supply, the financial gain is not inconsiderable, the cost of pumping being only about $1\frac{1}{2}d.$ per 1000 gallons, and the initial outlay on the boring and equipment being recouped in the first year by the saving on water-rates.

It has been computed by reliable authorities that the water in the chalk strata of the London basin is much more than sufficient to meet all the demands of the same superficial area. Here surely is a "London water scheme" better than any piping from lakes, with its contingent risks of polluted sources, and of a complete famine in case of accident to the conduit.

While water is the fluid most often sought by boring, precisely similar methods are applied to other liquid minerals, such as brine and petroleum, and most of the matter contained in these pages may be regarded as referring indiscriminately to all of them. Chapter VIII. deals more particularly with American oil wells.

C. ISLER.

ARTESIAN WORKS, BEAR LANE,
SOUTHWARK, LONDON, S.E.

CONTENTS.



CHAPTER	PAGE
I. GEOLOGICAL CONSIDERATIONS	1
II. DUG WELLS	23
III. DRIVEN TUBE WELLS	28
IV. BORED TUBE WELLS	41
V. KIND-CHAUDRON DEEP-BORING SYSTEM	73
VI. DRU DEEP-BORING SYSTEM	92
VII. MATHER & PLATT DEEP-BORING SYSTEM	106
VIII. AMERICAN ROPE-BORING SYSTEM	131
IX. DEEP BORING WITH DIAMOND DRILLS	157
X. RAISING WATER	174
INDEX	193





WELL-BORING.

CHAPTER I.

GEOLOGICAL CONSIDERATIONS.

Soakage.—Porous soils, such as sand and gravel, absorb water with rapidity, and consequently their surface soon dries up after showers. A well sunk in these soils may penetrate to considerable depths before meeting with water ; but water, nevertheless, is usually found on approaching some lower part of the porous formation where it rests on an impervious bed, for here the water, unable to make its way downwards in a direct line, accumulates as in a reservoir, and is ready to ooze out into any opening which may be made, in the same manner as sea-water will filter into and fill any hollow dug in the sands of the shore at low tide. A spring, then, is the lowest overflow-point or lip of an underground reservoir of water in the stratification. A well sunk in such strata will most probably furnish, besides the volume flowing from the spring, an additional supply of water, inasmuch as it may give access to the main contents of the reservoir.

Transmission of water through a porous medium being so rapid, it may easily be understood why springs are thrown out on the side of a hill, where the upper set of

strata consist of chalk, sand and other absorptive substances, whilst those lying beneath are composed of clay or other non-absorptive soils. The principal reasons why the water does not ooze out everywhere along the line of junction of the two formations, so as to form one continuous land-soak instead of creating a few springs only, and these oftentimes far distant from each other, are, firstly, the concentration of the water at a few points due to existence of inequalities in the upper surface of the impermeable stratum, which lead the water, as valleys do on the external surface, into certain low levels and channels, and secondly, the frequency of rents and fissures acting as natural drains.

That the generality of springs owe their supply to atmospheric sources is evident from this, that they vary in the different seasons of the year, becoming languid or entirely ceasing to flow after long droughts, and being again replenished after a continuance of rain. Many of them are probably indebted for the constancy and uniformity of their volume to the great extent of subterranean reservoirs with which they communicate, and the time required for these to empty themselves by percolation. Such a gradual and regulated discharge is exhibited, though in a less perfect degree, in all great lakes, for these are not sensibly affected in their levels by a sudden shower, but are only slightly raised, and their channels of efflux, instead of being swollen suddenly like the bed of a torrent, carry off the surplus water gradually.

An "artesian" well—so called from the province of Artois, in France—is a shaft sunk or bored through non-absorptive strata until a water-bearing stratum is tapped, when the water is forced upwards by the hydrostatic pressure due to the superior level at which the rain-water was received. The term artesian was originally only

applied to wells which overflowed, but nearly all deep wells are so called, without reference to their water-level, if they have bore-holes.

Among the causes of failure of artesian wells, may be mentioned the numerous rents and faults which occur in some rocks, and the deep ravines and valleys by which many countries are traversed; for when these natural lines of drainage exist, there remains only a small quantity of water to escape by artificial issues. The well-borer is also liable to be baffled by the great thickness either of absorp-

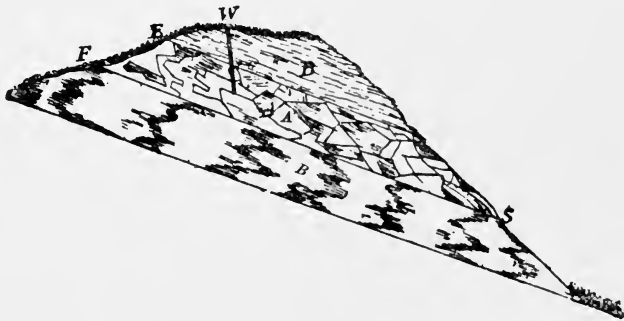

FIG. 1.—LIMITED OUTCROP OF ABSORPTIVE STRATUM.

tive or non-absorptive strata; or by the dip of the beds, which may carry off the waters from adjoining high lands to some trough in an opposite direction—as when the borings are made at the foot of an escarpment where the strata incline inwards, i.e. in a direction opposite to the face of the cliffs.

As instances of the way in which the character of the strata may influence the water-bearing capacity of any given locality, the following examples are cited from Latham.

Fig. 1 illustrates the causes which sometimes conduce to

a limited supply of water in artesian wells. Rain descending on the outcrop E F of the absorptive stratum A, which lies between the non-absorptive strata B B, will make its appearance in the form of a spring at S ; but such spring will not yield any great quantity of water, as the area E F, which receives the rainfall, is limited in its extent ; and the well bored at W into the absorptive stratum A would not be likely to furnish a large supply of water—if, indeed, it afforded any.

The effect of a fault is shown in Fig. 2. A spring will in all probability make its appearance at the point S, and

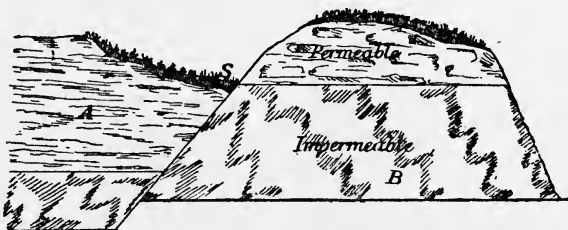

FIG. 2.—EFFECT OF FAULTING.

will give large quantities of water, the whole body of water flowing through the absorptive stratum A being intercepted by being thrown against the non-absorptive stratum B.

Absorptive rock intersected by a dyke, and overlying a non-absorptive stratum, is seen in Fig. 3. The water flowing through A, if interrupted by a dyke D, will appear at S in the form of a spring ; and if the area of A is very great, then the spring S will be very copious.

As to the depth necessary to bore certain wells in cases similar to that shown in Fig. 4. Owing to the fault, a well at A would require to be bored deeper than the well B, although both wells derive their supply from the same

description of strata. If there were any inclination in the water-bearing strata, or if there were a current of water

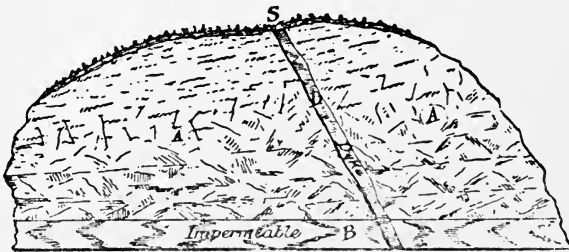

FIG. 3.—EFFECT OF DYKE.

only in one direction then one of the wells would prove a failure, owing to the proximity of the fault, while the other would furnish an abundant supply of water.

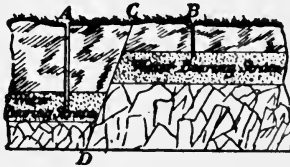

FIG. 4.—DEPTHS.

Volume.—It should be borne in mind that there are two primary geological conditions upon which the quantity of water that may be supplied to the water-bearing strata depends: these are—the extent of superficial area presented, by which the quantity of rain-water received on their surface in any given time is determined; and the character and thickness of the strata, as by this the proportion of water that can be absorbed, and the volume which the whole mass of the absorptive strata can transmit, are regulated. The operation of these general principles will constantly vary in accordance with local phenomena,

all of which must, in each separate case, be taken into consideration.

Mere remoteness from hills or mountains need not discourage the making of trials, for the waters which fall on these higher lands readily penetrate to great depths through highly-inclined and vertical strata, or through the fissures of shattered rocks ; and, after flowing for a great distance, they often reascend by way of other fissures, so as to approach the surface in the lower country. Here they may be concealed beneath a covering of undisturbed horizontal beds, which it may be necessary to pierce in order to reach them. The course of water flowing underground is not strictly analogous to that of rivers on the surface, there being, in the one case, a constant descent from a higher to a lower level, from the source of the stream to the sea ; whereas, in the other, the water may at one time sink far below the level of the ocean, and afterwards rise again high above it.

It is evident that a series of permeable strata, encased between two impermeable formations, can receive a supply of water at those points only where they crop out and are exposed on the surface of the land. The primary condition affecting their usefulness depends upon the fall of rain in the district where the outcrop takes place, the quantity of rain-water which any absorptive strata can gather being in the same ratio as their respective areas. Each inch of mean annual fall in any district represents a daily average of practically 40,000 gallons of rain-water per square mile. It is therefore a matter of essential importance to ascertain, with as much accuracy as possible, the area of exposed surface of any water-bearing deposit, so as to determine the maximum quantity of rain-water it is capable of receiving.

Whatever may be the absorbent power of the strata, the

yield of water will be more or less diminished whenever the channels of communication have suffered break or fracture. If the strata remained continuous and unbroken, it would only be necessary to ascertain their dimensions and lithological character in order to determine their actual water value. But where the strata are broken, the interference with subterranean transmission of water will be proportionate to the extent of the disturbance.

Every permeable stratum may afford water, and its ability to do this and the quantity it can yield depend upon its position and extent. When underlaid by an impervious stratum, it constitutes a reservoir of water from which a supply may be drawn by means of a sinking or a bore-hole. If the permeable stratum be also overlaid by an impervious stratum, the water will be under pressure, and will ascend in the bore-hole to a height depending on the height of the points of infiltration above the bottom of the bore-hole. The quantity to be obtained in such a case, as already pointed out, will depend upon the extent of surface possessed by the outcrop of the permeable stratum.

In searching for water under such conditions, a careful examination of the geological features of the district must be made. Frequently an extended view of the surface of the district, such as may be obtained from an eminence, and a consideration of the particular configuration of that surface, will be sufficient to enable the practical eye to discover the various routes which are followed by the subterranean water, and to predicate with some degree of certainty that at a given point water will be found in abundance, or that no water at all exists at that point. To do this, it is sufficient to note the dip and the surfaces of the strata which are exposed to the rains. When these strata are nearly horizontal, water can penetrate them only

through their fissures or pores ; when, on the contrary, they lie at right angles, they absorb the larger portion of the water that falls upon their outcrop. When such strata are intercepted by valleys, numerous springs will exist. But if, instead of being intercepted, the strata rise around a common point, they form a kind of irregular basin, in the centre of which the water will accumulate. In this case the surface springs will be less numerous than when the strata are broken. But it is possible to obtain water under pressure in the lower portions of the basin, if the point at which the trial is made is situated below the outcrop.

If the strata consist of sand, water will pass through them with facility, and they will also hold a considerable quantity in the interstices between their component grains ; whereas a bed of pure clay will not allow of the passage of water. These are the two extremes of the case. The intermixture of these materials in the same bed will, of course, modify the transmission of water according to the relative proportions. Sand of ordinary character will hold on an average rather more than one-third of its bulk of water, or 2 to $2\frac{1}{2}$ gallons per cubic foot. In strata so composed the water may be termed free, as it passes easily in all directions ; and under the pressure of a column of water, it is comparatively but little impeded by capillary attraction. These are the conditions of a true permeable stratum. Where the strata are more compact and solid, as in sandstone, limestone and oolite, although all such rocks imbibe more or less water, yet the water so absorbed does not pass freely through the mass, but is held in the pores of the rock by capillary attraction, and parted with very slowly ; so that in such deposits water can be freely transmitted only in the planes of bedding and in fissures.

If the water-bearing deposit is of uniform lithological character over a large area, then the proposition is reduced to its simplest form ; but when the strata consist of variable mineral ingredients, it becomes essential to estimate the extent of these variations.

Rainfall.—Rain is most capricious, both as regards its frequency and the amount which falls in a given time. In some places it rarely or never falls, whilst in others it rains almost every day ; and there does not yet exist any theory from which a probable estimate of the rainfall in a given district can be deduced, independently of direct observation. But a workable average of the quantity of rain to be expected in any particular place may be judged from careful and continued observations with a rain-gauge. The mouth of the gauge must be set quite level, and so fixed that it will remain so ; it should never be less than 6 inches nor more than 12 inches above the ground, except when a greater elevation is absolutely necessary to obtain a proper exposure. It must be placed on level ground, unshaded and unsheltered, and away from all structures and growths of every kind, at least as many feet from their base as they are in height.

For snow, three methods may be adopted : (*a*) melt what is caught in the funnel, and measure that as rain ; (*b*) select a place where the snow has not drifted, invert the funnel, and turning it round, lift and melt what is enclosed ; (*c*) measure with a rule the average depth of snow, and take one-twelfth as the equivalent of water. Some observers use a cylinder of the same diameter as the rain-gauge, and of considerable depth ; if the wind is at all rough, all the snow is blown out of a flat-funnelled rain-gauge.

A "drainage area" is almost always a district of country

enclosed by a ridge or watershed line, continuous except at the place where the waters of the basin find an outlet. It may be, and generally is, divided by branch ridge-lines into a number of lesser basins, each drained by its own stream into the main one.

When a catchment basin is very extensive, it is advisable to measure the smaller basins of which it consists, as the depths of rainfall in them may be different; sometimes, also, for the same reason, those basins may be divided into portions at different distances from the mountain chains, where rain-clouds are chiefly formed.

The exceptional cases, in which the boundary of a drainage area is not a ridge-line on the surface of the country, are those in which the rain-water sinks into a porous stratum until its descent is stopped by an impervious stratum, and in which, consequently, one boundary at least of the drainage area depends on the figure of the impervious stratum, being, in fact, a ridge-line on the upper surface of that stratum, instead of on the ground, and very often marking the upper edge of the outcrop of that stratum. If the porous stratum is partly covered by a second impervious stratum, the nearest ridge-line on the latter stratum to the point where the porous stratum crops out will be another boundary of the drainage area. In order to determine a drainage area under these circumstances, it is necessary to have a geological map and sections of the district.

The most important data respecting depth of rainfall, for practical purposes, are: least annual rainfall; mean annual rainfall; greatest annual rainfall; distribution of rainfall at different seasons, especially the longest continuous drought; and greatest flood rainfall, or continuous fall of rain in a short period.

The available rainfall is that part of the total which remains to be stored in reservoirs, or carried away by streams, after deducting loss through evaporation, through permanent absorption by plants and by the ground, and other causes.

The proportion borne by available to total rainfall varies very much : it is affected by the rapidity of the rainfall, the compactness or porosity of the soil, the steepness or flatness of the ground, the nature and quality of the vegetation upon it, the temperature and moisture of the air (regulating the rate of evaporation), the existence of artificial drains, and other circumstances. The following are examples :—

Ground.	Available Rainfall + Total Rainfall.
Steep surfaces of granite, gneiss, and slate	nearly 1
Moorland and hilly pasture	·8 to ·6
Flat cultivated country	·5 to ·6
Chalk	0

Deep-seated springs and wells give ·3 to ·4 of the total rainfall. In chalk districts it has been found that evaporation is about 34%, and the quantity carried off by streams 23%, leaving 43% which sinks below the surface to form springs.

In formations less absorbent than the chalk, it is calculated by some authorities that streams carry off one-third, that another third evaporates, and that the remaining third of the total rainfall sinks into the earth. But if they are correct in allowing one-third for evaporation in the cool and humid climate of England, 100% would not be too much in such arid districts as the interiors of Australia and Africa.

The following table gives the mean annual rainfall in various parts of the world :—

TABLE OF RAINFALL. Collected by G. J. Symons.

Country and Station.	Period of Observations.	Latitude.	Mean Annual Fall.
EUROPE.			
	years.	° ' N.	in.
AUSTRIA—Cracow	5	50 4	33·1
Prague	47	50 5	15·1
Vienna	10	48 12	19·6
BELGIUM—Brussels	20	50 51	28·6
Ghent	13	51 4	30·6
Louvain	12	50 33	28·6
DENMARK—Copenhagen	12	55 41	22·3
FRANCE—Bayonne	10	43 29	56·2
Bordeaux	32	44 50	32·4
Brest	30	48 23	38·8
Dijon	20	47 14	31·1
Lyons	45 46	37·0
Marseilles	60	43 17	19·0
Montpelier	51	43 36	30·3
Nice	20	43 43	55·2
Paris	44	48 50	22·9
Pau	12	43 19	37·1
Rouen	10	49 27	33·7
Toulon	43 4	19·7
Toulouse	52	43 36	24·9
GREAT BRITAIN—			
England, Exeter	40	50 44	33·0
„ Lincoln	40	53 15	20·0
„ London	40	51 31	24·0
„ Manchester	40	53 29	36·0
Wales, Cardiff	40	51 28	43·0
„ Llandudno	40	53 19	30·0
Scotland, Aberdeen	40	57 8	31·0
„ Edinburgh	40	55 57	24·0
„ Glasgow	40	55 52	39·0

TABLE OF RAINFALL—*continued.*

Country and Station.	Period of Observations.	Latitude.	Mean Annual Fall.
<i>GREAT BRITAIN—continued.</i>			
Ireland, Cork	40	51 54 N.	40°0
„ Dublin	40	53 23	30°0
„ Galway	40	53 15	50°0
HOLLAND—Rotterdam	51 55	22°0
ICELAND—Reykjavik	5	64 8	28°0
IONIAN ISLES—Corfu	22	39 37	42°4
ITALY—Florence	8	43 46	35°9
Milan	68	45 29	38°0
Naples	8	40 52	39°3
Rome	40	41 53	30°9
Turin	4	45 5	38°6
Venice.	19	45 25	34°1
MALTA	35 54	15°0
NORWAY—Bergen	10	60 24	84°8
Christiania	59 54	26°7
PORTUGAL—Coimbra (in Vale of Mondego)	2	40 13	224°0 ?
Lisbon	20	38 42	23°0
PRUSSIA—Berlin	6	52 30	23°6
Cologne	10	50 55	24°0
Hanover	3	52 24	22°4
Potsdam	10	52 24	20°3
RUSSIA—Archangel	14	64 32	14°5
Astrakan	1	46 24	6°1
Finland, Uleaborg	4	65 0	13°5
St. Petersburg	59 56	16°2
SICILY—Palermo	24	38 8	22°8
SPAIN—Madrid	40 24	9°0
Oviedo	1	43 22	111°1
SWEDEN—Stockholm	8	59 20	19°7
SWITZERLAND—Geneva	72	46 12	31°8
Great St. Bernard	43	45 50	58°5
Lausanne.	8	46 30	38°5

WELL-BORING.

TABLE OF RAINFALL—*continued.*

Country and Station.	Period of Observations.	Latitude.	Mean Annual Fall.
ASIA.			
	years.	° ' in.	in.
CEYLON—Adam's Peak	6 50 N.	100·0
Colombo	6 56	91·7
Kandy.	7 18	84·0
CHINA—Canton	14	23 6	69·3
Macao	22 24	68·3
Pekin	7	39 54	26·9
INDIA—Bombay	33	18 56	84·7
Calcutta	20	22 35	66·9
Cherrapongee.	25 16	610·3?
Darjeeling.	27 3	127·3
Madras	22	13 4	44·6
Mahabuleshwur	15	17 56	254·0
Malabar, Tellicherry	11 44	116·0
Palamcotta	5	8 30	21·1
Patna	25 40	36·7
Poonah	4	18 30	23·4
MALAYSIA—Pulo Penang	5 25	100·5
Singapore	1 17	190·0
PERSIA—Lencoran	3	38 44	42·8
Ooroomiah	1	37 28	21·5
RUSSIA—Barnaoul	15	53 20	11·8
Nertchinsk	12	51 18	17·5
Okhotsk	2	59 13	35·2
Tifis	6	41 42	19·3
Tobolsk	2	58 12	23·0
TURKEY—Palestine, Jerusalem	{ 14	31 47	65·0?
	{ 3	31 47	16·3
Smyrna	38 26	27·6

TABLE OF RAINFALL—*continued.*

Country and Station.	Period of Observations.	Latitude.	Mean Annual Fall.
AFRICA.			
	years	° ' "	in.
ABYSSINIA—Gondar	12 36 N.	37°3
ALGERIA—Algiers	10	36 47	37°0
Constantina	36 24	30°8
Mostaganem	1	35 50	22°0
Oran	2	35 50	22°1
ASCENSION	2	8 8 S	11°5
CAPE COLONY—Cape Town	20	33 52	24°3
GUINEA—Christiansborg	5 30 N.	19°2
MADEIRA	4	33 30	30°9
MAURITIUS—Port Louis	20 3 S	35°2
NATAL—Maritzburg	29 36	27°6
ST. HELENA	3	15 55	18°8
SIERRA LEONE	8 30 N.	86°0
TENERIFFE	2	28 28	22°3
NORTH AMERICA.			
BRITISH COLUMBIA—New Westminster	3	49 12 N.	54°1
CANADA—Montreal, St. Martin's	2	45 31	47°3
Toronto	16	43 39	31°4
HONDURAS—Belize	1	17 29	153°0
MEXICO—Vera Cruz	19 12	66°1
RUSSIAN AMERICA—Sitka	7	57 3	89°9
UNITED STATES—Arkansas, Fort Smith	15	35 23	42°1
California, San Francisco	9	37 48	23°4
Nebraska, Fort Kearney	6	40 38	28°8
New Mexico, Socorro	2	34 10	7°9
New York, West Point	12	41 23	46°5
Ohio, Cincinnati	20	39 6	46°9
Pennsylvania, Philadelphia	19	39 57	43°6
South Carolina, Charlestown	15	32 46	48°3
Texas, Matamoras	6	25 54	35°2

TABLE OF RAINFALL—*continued.*

Country and Station.	Period of Observations.	Latitude.	Mean Annual Fall.
NORTH AMERICA— <i>continued.</i>			
	years	° ' N.	in.
WEST INDIES—Antigua	17 3 N.	39·5
Barbadoes	10	13 12	75·0
„ St. Philip.	20	13 13	56·1
Cuba, Havana	2	23 9	50·2
„ Matanzas	1	23 2	55·3
Grenada	12 8	126·0
Guadeloupe, Basseterre	16 5	126·9
„ Matonba	16 5	285·8
Jamaica, Caraib	18 3	97·0
„ Kingstown	17 58	83·0
St. Domingo, Cape Haitien	19 43	127·9
„ Tivoli	19 0	106·7
Trinidad	10 40	62·9
Virgin Isles, St. Thomas	18 17	60·6
„ Tortola	18 27	65·1
SOUTH AMERICA.			
BRAZIL—Rio Janeiro	22 54 S.	58·7
S. Luis de Maranhao	3 0	276·0
COLOMBIA—La Baja	6	7 22 N.	54·1
Marmato	15	5 29	90·0
Santa Fé de Bogota	6	4 36	43·8
GUIANA—Cayenne	6	4 56	138·3
Demerara, George Town	5	6 50	87·9
Paramaribo	6 0	229·2
VENEZUELA—Cumana	10 27	7·5
Curaçao	12 15	26·6

TABLE OF RAINFALL—*continued.*

Country and Station.	Period of Observations.	Latitude.	Mean Annual Fall.
AUSTRALASIA.			
	years.	° ' .	in.
NEW SOUTH WALES—Bathurst	3	33 24 S.	22·7
Deniliquin	2	35 32	13·8
Newcastle	3	32 57	55·3
Port Macquarie	12	31 29	70·8
Sydney	6	33 52	46·2
NEW ZEALAND—Auckland	2	36 50	31·2
Christchurch	3	43 45	31·7
Nelson	2	41 18	38·4
Taranaki	2	39 3	52·7
Wellington	2	41 17	37·8
SOUTH AUSTRALIA—Adelaide	6	34 55	19·2
TASMANIA—Hobart	12	42 54	20·3
VICTORIA—Melbourne	6	37 49	30·9
Port Philip	11	38 30	29·2
WEST AUSTRALIA—Albany	35 0	32·1
York	1	31 55	25·4
POLYNESIA.			
SOCIETY ISLANDS—Tahiti Papiete	5	17 32 S.	45·7

Water-bearing Strata.—Among absorptive beds, mention may first be made of the "Drift." This superficial formation consists mainly of beds of sand and gravel. Having been formed by the action of flowing water, it is very irregular in thickness, and exists frequently in detached masses; this irregularity is due to inequalities of the surface at the period when the drift was brought down.

Hollows then existing would be filled up, while on level surfaces no detritus would be deposited, or, if deposited, would be subsequently removed by denudation. Hence it is not safe to infer, when boring through deposits of this character, that the same, or nearly the same, thickness will be found at even a few yards' distance. In basins and in broad valleys, this deposit may exist to great depth. The absorptiveness of the beds will depend, of course, wholly upon the nature of the deposit. Some rocks produce deposits through the whole of which water percolates readily, while others allow a passage only through such fissures as may exist. Sand and gravel constitute an extremely absorbent medium, while an argillaceous (clay) bed may be wholly impervious. In mountainous districts, springs may often be found in the drift, but their existence will then depend upon the position and character of the rock strata. Thus, if the drift cover an elevated and extensive slope of a nature similar to that of the rocks by which it is formed, springs due to infiltration through this covering will certainly exist near the foot of the slope. Upon the opposite slope, the small spaces existing between the different beds of rock receive these infiltrations directly, and serve to completely drain the deposit. If, however, the foliations or the joints of the rocks afford no issue to the water, whether such circumstance be due to the character of their formation, or to the stopping up of the issues by the drift itself, these results will not be produced.

Another superficial formation, termed "Alluvium" or "alluvion," and often (ungrammatically) "alluvial," is similarly composed of fragments of various strata carried away and re-deposited by flowing water; it differs, in fact, from drift only in being more extensive and regular, and, generally, in being composed of elements brought from a greater

distance and having no analogy to the strata with which it is now found in contact. It embraces sand, gravel, rolled pebbles, marls and clays. The older deposits often occupy very elevated districts, which they overlies throughout a large extent of surface. The permeability of alluvial beds allows the water to flow away subterraneously to great distances from the points at which it enters. Springs are common. As the surface covered by the deposit is extensive, the water circulates from a distance through permeable strata often overlaid by others that are non-absorptive. If at a considerable distance from the points of infiltration, and a lower level, a boring be put down, the water will ascend in the bore-hole in virtue of its tendency to place itself in equilibrium.

The sedimentary beds of Secondary and Tertiary geological ages, lying beneath the more recent formations just described, are far more extensive than they and yield much larger quantities of water.

The Chalk is the great water-bearing stratum for the larger portion of the South of England, and here water circulates through fissures. A rule sometimes given for the level at which water may be found in this stratum is, "Take the level of the highest source of supply, and that of the lowest to be found. The mean level will be the depth at which water will be found at any intermediate point, after allowing an inclination of at least 10 feet per mile." This rule will also apply to the Greensand formation, which contains large quantities of water, and more evenly distributed than in the Chalk. The Gault Clay is interposed between the Upper and the Lower Greensand, the latter of which also furnishes good supplies. In boring into the Upper Greensand, caution should be observed so as not to pierce the Gault Clay, because water which permeates

through that layer becomes contaminated with various saline, ferruginous and other impurities.

Water is found in the Upper and Lower Oolites, between which are certain clays, separated by the "coral rag." Instances occur in England where the so-called Oxford Clay is met with immediately below another bed named the Kimmeridge, rendering useless any attempt at boring, because the water in the Oxford Clay is generally so impure as to be unfit for use. With regard to finding water in the Oolitic Limestone, it is impossible to determine with any amount of precision the depth at which it may be reached, owing to the numerous faults which occur in the formation. The Oolitic rocks are very porous, absorbing and holding enormous volumes of water. In this respect they are equal if not superior to the Chalk itself; and selected analyses indicate that they are not inferior to the New Red Sandstone in the energy with which they oxidise and destroy organic matter present in waters percolating through them. Though their waters are generally hard, the hardness is chiefly of a temporary character, capable of being softened by Clark's process, so as to average $6^{\circ}\cdot 8$ instead of $20^{\circ}\cdot 6$; the supply is bright, sparkling, and palatable, excellent for drinking and all domestic purposes except washing, for which the addition of lime renders it fit.

Lower in the sequence of formations are the Lias beds (Upper Lias, Marlstone, and Lower Lias). In the Marlstone, between the upper and lower beds of the Lias, may be found a large supply of water; but the level of this is as a rule so low that it will not rise to the surface through a boring.

In the New Red Sandstone, also, to find water, borings must be made to considerable depth; but where this formation exists, a copious supply can be confidently anticipated. It may be looked upon as almost equally permeable

in all directions, and the whole mass may be regarded as a reservoir up to a certain level. Its water is clear, wholesome, and pleasant to drink, also well adapted for the purposes of bleaching, dyeing, and brewing ; at the same time it must be admitted that its hardness, in other words the proportions of carbonates of lime and magnesia it contains, is subject to considerable variation. As a general rule, it may be considered as occupying a position intermediate between the hard water of the Chalk and the soft water derived from superficial sources. Having but a small proportion of saline ingredients, and being absolutely free from artificial contaminations (such as sewage and manufacturing effluents), it possesses incalculable advantages over water from rivers and surface drainage. Many large towns are now partially or entirely supplied with water pumped from deep bores in this Sandstone ; and many millions of acres in central Australia have only ceased to be waterless since numbers of bores have been sunk to reach similar beds.

The primary rocks afford but little water. Having been subjected to violent convulsions, they are thrown into every possible position, and broken by numerous fissures ; and no permeable stratum being interposed, as in the more recent formations, no reservoir of water exists. In the unstratified rocks, the water circulates in all directions through the fissures that traverse them, and thus occupies no fixed level. It is also impossible to discover by surface examination where the fissures may be struck by boring. For purposes of water supply, therefore, these rocks are of little importance. It must be remarked here, however, that large quantities of water are frequently met with in the Magnesian Limestone and the Lower Red Sandstone, which form the upper portion of the primary series.

It is hardly necessary to say that rocks of igneous origin are devoid of water-bearing strata, and though the extraordinary anomaly may be seen in Australia of borings for water put down in solid granite, this is due to pernicious political influences and in spite of the protests of professional advisers.

CHAPTER II.

DUG WELLS.

SLOWLY but surely the "sunk" well, with its huge excavation and brick curbing, is going out of existence, and no regret need follow it. From its very nature, it is absurdly expensive and adapted only to shallow sinking; but much worse than this is the fact that its sources of water supply are almost invariably tainted. Very few pages will suffice for this chapter.

Marking-off.—Sinking is commenced by marking off upon the ground a circle 12 or 18 in. greater than the intended internal diameter of the well. Its centre must be carefully preserved, and everything must be true to it, the plumb-line being frequently used to test the vertical position of the sides.

Under-pinning.—To sink by under-pinning, an excavation is first made to such depth as the strata will allow without falling in. At the bottom is laid a "curb" or flat ring; its internal diameter equals the intended clear diameter of the well, and its breadth the thickness of the brickwork. It is made of oak or elm planks 3 to 4 in. thick, either in one layer fished at the joints with iron, or in two layers breaking joint and spiked or screwed together. On this, to line the first division of the well, a cylinder of brickwork, technically called "steining," is built in mortar or cement. In the centre of the floor is dug a pit, at the bottom of which is laid a small platform of boards; then,

by cutting notches in the side of the pit, several raking props are inserted, their lower ends abutting against a foot-block, and their upper ends against the lowest setting, so as to give temporary support to the curb with its load of brickwork. The pit is enlarged to the diameter of the well ; on the bottom of the excavation is laid a new curb, on which is built a new division of the brickwork, giving permanent support to the upper curb ; the raking props and their foot-blocks are removed ; a new pit is dug ; and so on as before. The earth must be firmly packed behind the steining.

In a common modification of this method, a wooden curb is laid at the bottom of the excavation ; the brick steining is built upon it and carried to the surface ; the earth is excavated flush with the interior sides of the well, so that the earth beneath the curb supports the brickwork above ; when the excavation has been carried as far as convenient, recesses are made in the earth under the previous steining, and in these recesses the steining is carried up to the previous work ; when thus supported, the intermediate portions of earth between the sections of brickwork carried up are cut away, and the steining is completed.

Drum-curbing.—A “drum-curb,” which may be either of wood or iron, consists of a flat ring for supporting the steining, and of a vertical hollow cylinder or drum of the same outside diameter as the steining, supporting the ring within it and bevelled to a sharp edge below. The rings or ribs of a wooden curb are formed of two thicknesses of elm plank 9 by $1\frac{1}{2}$ in., giving a total thickness of 3 in. The outside cylinder or lagging is made from $1\frac{1}{2}$ -in. yellow pine planks. It may be strengthened by additional rings and by brackets. In large curbs, the rings are placed about 3 ft. 6 in. apart. ; When the well has been sunk as far as the

earth will stand vertical, the drum curb is lowered into it, and the building of the brick cylinder is commenced, each course of bricks being completed before laying another, in order that the curb may be loaded equally all round. The earth is dug away from the interior of the drum, and this, together with the gradually increasing load, causes the sharp lower edge of the drum to sink into the earth: thus the digging of the well bottom, the sinking of the drum-curb and its brick lining, and the building of the steining at the top, go on together. Care must be taken to so regulate the digging that the well shall sink vertically. Should the friction of the earth against the outside of the drum become so great as to stop its descent before the requisite depth is attained, a smaller well may be sunk in the interior of the first: a well so stopped is said to be "earth-fast." This plan is successful only in sandy soils and to moderate depths.

The curbs are often supported by iron rods (with screws and nuts) from cross-timbers over the mouth of the well; as the excavation proceeds, brickwork is piled on above, and the weight of the steining carries down the curb until it becomes earth-bound.

Materials for Steining.—The materials that have been successfully used in lining or steining are brick, stone, timber, and iron.

Brickwork is universally used in England, but not unfrequently it fails, through admitting impure water (when under great pressure), or through becoming disjointed (from settlement due to draining a running sand-bed), or the collapse of the well.

Brick steining is either laid dry or in cement, 9-in. work being used for large wells and 4½-in. for small wells. Figs. 5 and 6 show the method of laying for 9-in. work, and Fig. 7

for $4\frac{1}{2}$ -in. The bricks are laid flat, breaking joint. To keep out moderate land-springs, clay-puddle or concrete is introduced at the back of the steining; for most purposes,

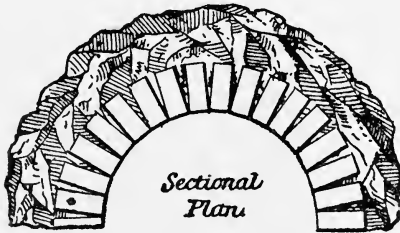

FIG. 5.—BRICK STEINING.

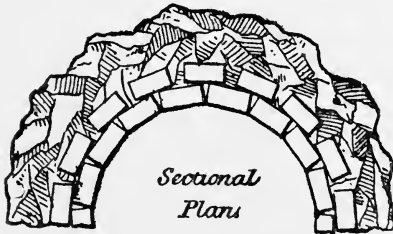

FIG. 6.—BRICK STEINING.

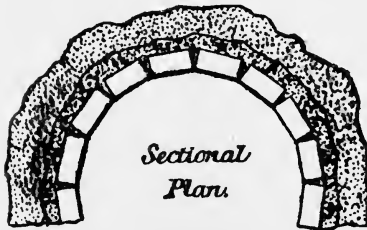

FIG. 7.—BRICK STEINING.

concrete is the better, as, in addition to its impervious character, it adds greatly to the strength of the steining. A ring or two of brickwork in cement is often introduced

at intervals varying from 5 to 12 ft., to strengthen the shaft and facilitate construction.

Stone of fair quality, capable of withstanding compressive strains, is good in its way ; but inasmuch as it requires a great deal of labour to fit it for its place, it cannot often successfully compete with brickwork. In selecting a stone, attention must be paid not only to its durability but also to freedom from soluble ingredients which might impair the purity of the water.

Timber is objectionable on account of its liability to decay, when it not only endangers the structure, but also to some extent fouls the water. It is very largely used in the preliminary operations of sinking most wells ; and in lining the shafts of the salt wells of Cheshire it endures for a great number of years, the brine acting as a preservative.

Iron is of modern application, and is extensively employed, it being capable of bearing great compressive strains and of effectually excluding the influx of such waters as it may be desirable to keep out, and not liable to decay under ordinary circumstances. Baldwin Latham mentions instances in his practice of successful recourse to iron cylinders where 4 or 5 rings of brickwork set in the best cement failed to keep out brackish waters.

CHAPTER III.

DRIVEN TUBE WELLS.

Scope.—For limited depths and supplies, and in strata which, though, perhaps, hard and compact, are not composed of actual rock, the driven tube forms a most useful well, capable of being sunk at great speed, and drawing its water from a horizon below most risks of contamination by surface drainage. Since the driven tube well has been in use the Author has introduced many improvements.

Before locating one of these wells, it is advisable to ascertain the depth at which water is found in the district, when possible, either by reference to a geological map or by sounding existing dug wells. Thus may be gained an approximate idea of the depth to which the tube well must be driven; but variations of the strata occur in very short distances, and no guide is infallible.

If beds of stiff clay or true rock are encountered, it is best to abandon the spot and try elsewhere.

Tubes.—The well consists of a hollow wrought-iron tube about $1\frac{1}{4}$ to 6 in. diam., composed of any number of lengths, each of 3 to 10 ft., according to the depth required. The water is admitted into the tube through a series of holes, which extend up the lowermost length to a height of $2\frac{1}{2}$ ft. from the bottom. Specially tough lap-welded tubes are necessary, to withstand the hammering and vibration to which they are subjected; gas-pipe and other common brands are quite useless for this purpose.

The essential part of the tube is the "point" *a* (Fig. 8), measuring about 3 ft. long, and perforated as already described. This is furnished at top with a socket *b* which receives the driving-cap *c*. Rigidly attached to this cap is

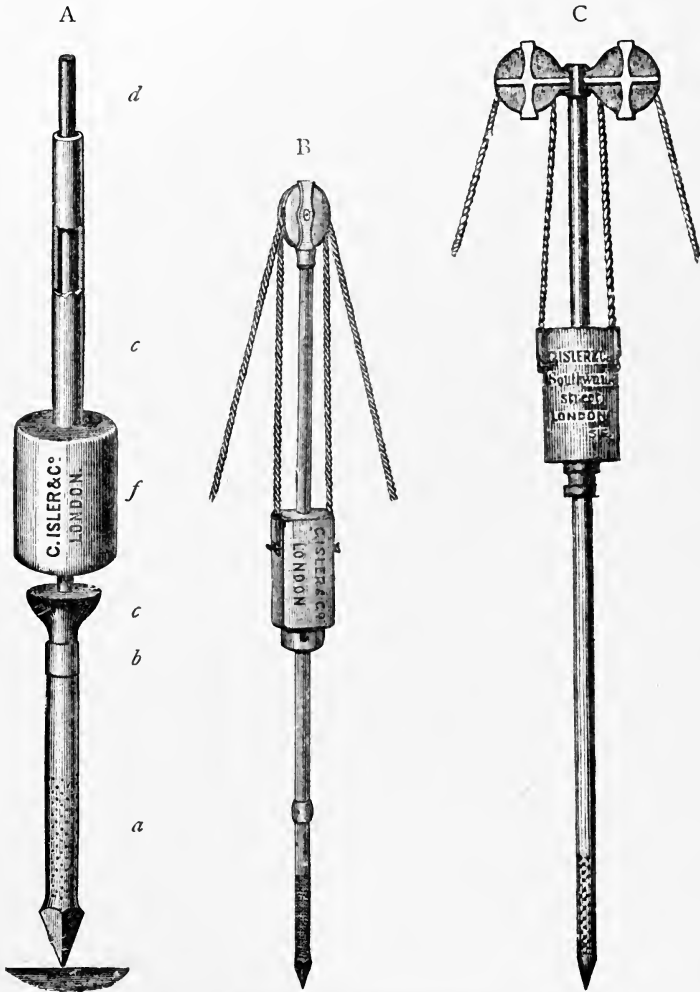

FIG. 8.—DRIVING TUBES.

a spindle or guide *d*, enveloped by the runner or sleeve *e* of the monkey or driver *f*. This method of applying the driving force to the tube is vastly superior to the old-fashioned system of a clamp fixed to the tube; the latter nearly always resulted in more or less indentation of the tube, sometimes causing much difficulty in adding new lengths. The monkey may be raised by hand, as in A, or by ropes and pulleys as in B C; B is the pattern used very extensively by the War Office.

Driving.—The spot for sinking having been chosen, a truly vertical hole is first made in the ground with a crow-bar, and in this the properly rigged tube is inserted, all joints having been first made quite tight. When in position, 2 men raise the monkey either by hand (A) or by ropes (B C). In the latter case, they should stand exactly opposite each other and equidistant from the tube, pulling the ropes at identical angles, and moving in time together, so that the tube may maintain a vertical position and follow a straight course. Should it deviate at all, gentle pressure must be used to bring it gradually back, the pressure being applied to the tube itself, and not on any account to the spindle or guide-bar.

The driving-cap must be tightened after every few blows.

Though 2 men suffice for driving a 1½-in. tube, an extra hand will make a great difference to the speed, as he can give undivided attention to the perpendicularity of the tube and add some impulse to the fall of the monkey.

It is most essential to see that the first length is driven quite vertically; the driving should therefore be conducted with the greatest care for the first 2 or 3 ft. The driving-cap is withdrawn when a few inches off the ground, and a fresh length of pipe is added. The pulley-bar and monkey must be removed to allow the driving-cap to be unscrewed.

As each joint on the tubes has to be water- and air-tight, it must be oiled and white-leaded before fixing the pipe on the length previously driven.

The socket is removed from one end of the pipe whilst on the ground, by gripping the pipe with barrel-tongs, the foot being lightly placed on the handles, and the socket unscrewed by means of socket-tongs. The driving-cap is screwed to this length of pipe, the monkey and pulley-bar are slipped through it in the same manner as with the first length, and the whole is bodily raised and screwed to the tube driven. It is most particularly to be noted that the smaller or barrel-tongs are to be used on the tube in all instances, whether to screw or unscrew joints, otherwise joints that have been made may get disturbed, and ruin the work. The socket-tongs are placed on the socket, and the pipe is then screwed up tightly so that the joints butt against one another; length after length is in this manner added until the required depth is attained.

Clearing.—The tube well should be sounded by means of the plumb-bob from time to time during the driving, to detect the presence either of water or of soil inside the tube. A certain amount of soil is sure to find its way in, and should be cleared at intervals; otherwise, if the accumulation be allowed to increase, springs may be passed, and remain undiscovered.

The "clearing-out tubes" are to be used for this purpose. Length after length is screwed together by means of $\frac{1}{2}$ -in. barrel- and socket-tongs, and suspended by $\frac{1}{2}$ -in. clips 2 or 3 in. above the debris, so that they will not choke. Previous to lowering the $\frac{1}{2}$ -in. tubes, the funnel (Fig. 9) should be screwed to the well-tube, and by this means water is poured into the well whilst it is being cleared. A pump and reducing socket are attached to the $\frac{1}{2}$ -in. tubes,

and these are gradually lowered until the whole of the debris has been removed from the pipe, when the clearing-out tubes are withdrawn.

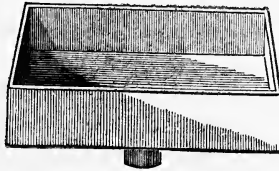

FIG. 9.—FUNNEL.

When it is found impracticable to clear the well with the ordinary point, recourse is had to a "sand-tube" (Fig. 10), made according to the fineness of the sand to be dealt with. Its action is in every way similar to that of the ordinary well point; but it is protected by a perforated brass sheath fixed over the drilled part of the tube, and the holes in the pointed pipe are drilled very much larger than in the ordinary well-tube, to allow for the fine perforated brass. The tube well is driven and cleared in the usual manner by means of the $\frac{1}{2}$ -in. tubes, etc.



FIG. 10.
SAND-TUBE.

It will be found that, even in gravelly soils, tube wells will be made in much less time, both as regards clearing and pumping, if protected with a strainer.

Tilting.—As soon as the presence of water has shown itself to the extent of a few feet in the tube, the pump should be attached directly to the well-tube, care being taken to white-lead all the threads. The pump is started by pouring water into the top, to force the air from the pipe; if a supply exists, the water will soon

follow. It will be more or less muddy, according to the nature of the soil through which it is obtained.

The handle of the pump should be raised as high as practicable, to allow the valves to open. This will suddenly release the column of water held in the well-tube, which will instantly drop to its level, forcing its way through the perforations in the bottom length, and so disturbing the surroundings of the well. This action should be repeated over and over again, causing the water to be played in and out of the perforations, and thus allowing the finer particles to be pumped out and the larger to be gradually drawn around the well-tube, forming a natural filter; the operation is called "tilting," and should be discontinued when the water is practically free from grit. Disconnection is effected by loosening the studs which hold the ring to the pump-barrel, and giving the handle a quarter-turn; steady pumping should then take place for a short time, when it will be found that the water will become quite clear and free from sandy particles.

The whole secret of making successful tube wells lies in the proper use of the pump. It is therefore necessary that the above instructions should be accurately followed—if neglected, the tube well may become choked, resulting in a total stoppage of the supply.

In close and compact soils, such as sand, gravel, chalk, etc., much patience and perseverance are required in developing supplies of water. The yield is at first scanty, but rapidly increases by the tilting of the pump, which helps to disintegrate the surrounding soil, and forms a free passage for the water.

Drawing.—It often occurs in driving that impervious or solid strata, such as thick beds of clay, rock, etc., are met with. In these cases, it is necessary to withdraw

the tube, which is accomplished in the following manner. The monkey is slipped over the well-pipe, the driving-cap is screwed above it to the well-tube, and the pulley-bar is again slipped into position, allowing the men to strike the monkey upwards against the driving-cap; thus the tubes are forced out of the ground. Other means are also adopted, such as bottle-jacks, or a hollow jack specially designed for this purpose. The tubes, previous to being re-driven, should be carefully examined, and, if found bent, must be discarded, unless they can be straightened at a forge or by striking them with the side of the monkey.

Depth.—The depth to which tube wells may be driven is entirely governed by the nature of the soil; they commonly reach 60 to 70 ft., and sometimes even 100 ft. or more. Yet in many cases an ordinary lift-pump may be employed on them, the water rising to within 28 ft. of the surface, and often higher.

When it happens that an objectionable spring is tapped the tube is driven deeper in search of other springs. It is to be noted that the upper springs will not affect the lower ones when the latter are tapped.

Deeper Wells.—When the water is below lifting reach of the ordinary lift-pump, viz. 28 ft. from the surface, it is advisable to drive a larger tube well, as illustrated and described below.

Knowing the exact depth at which the water comes in, the proper length of tube is driven, and the working barrel (either made of steel or phosphor-bronze) is screwed to it, taking care to slip the valve-seat (*a*, Fig. 11) into position, so as to rest next to the well-pipe. The working barrel is so placed as to be within lifting reach of the water. All the joints must butt as in the case of the smaller well.

The ring *b* (Fig. 11) is placed on the top of the working

barrel when the next length of well-tube is butted to it ; the driving is then continued to the depth required.

To remove the soil which has found its way into the tube well, a small shell with a valve is provided : this is attached to the $\frac{1}{2}$ -in. tubes, and is lowered until it has reached the debris, when the whole is lifted up and down to allow all the soil to pass into the $\frac{1}{2}$ -in. pipes, and to effectually clear the tube. The $\frac{1}{2}$ -in. tubes are then with-

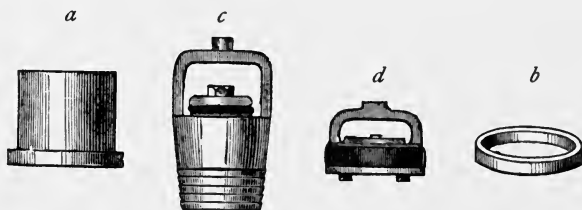

FIG. 11.—DEEP WELL FITTINGS.

drawn in 12-ft. lengths. This mode of clearing also applies to the ordinary tube well, and will be found far more expeditious than clearing it with the funnel (see page 13), which latter cannot be used for deep wells.

The taper end of the valve *c* (Fig. 11), is wound with tow, a little tallow and white-lead mixed being added to make it adhere. This will make a water-tight joint when fixed in the seating. The valve is lowered into its position by means of a hook or screw attached to the pump-rods, and, to ensure a water-tight joint, a few gentle blows are given on the top of the valve by means of the rods and hook. The rods are then withdrawn, the hook is disconnected, and the bucket *d* (Fig. 11) is screwed in place. The rods are lowered until the bucket has fairly entered the working barrel, when it is connected to the pump-rod, the whole being then ready to commence pumping. The pump-rods

are united by means of triangular couplings, secured by split pins.

Previous to working, the pump will need to be "primed" as usual by pouring water through the top, when a yield will soon follow. It is advisable to work the pump rather sharply at first to enable the finer particles to be drawn up.



FIG. 12.
WORKING BARREL.

The arrangement of this deep-well pump is extremely simple; and should the pump require seeing to, through either the bucket or the valve getting out of order, the whole is withdrawn for examination in the same manner as it was fixed, without the necessity for disturbing the rising main or tube well.

Fig. 12 illustrates the working barrel completely fitted with all its parts; and Fig. 13, the tube well with its deep-well pump in position.

It is to be observed that the instructions given for smaller wells are applicable also to deeper wells.

Another method of dealing with deep wells when it is found that the water-level is below lifting reach, is to sink a hole so as to meet the water-level, and thus allow the ordinary pump to be fixed on the top of the tube well at the bottom of the sunken pit, and to be cleared by means of the $\frac{1}{2}$ -in. tubes, and "tilted" in the ordinary way to develop a supply, previous to fixing the deep-well pump. In this case (Fig. 14) the tube well is smaller than the rising main of the pump, which may be of wrought- or cast-iron flanged pipe. For example, suppose the tube well to be 70 ft. from the surface with 30 ft. of

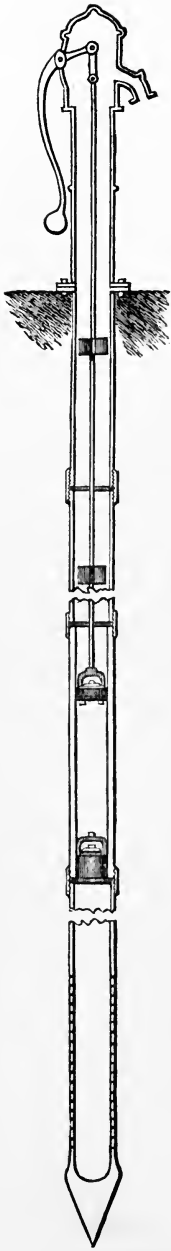

FIG. 13.—TUBE WELL AND PUMP.

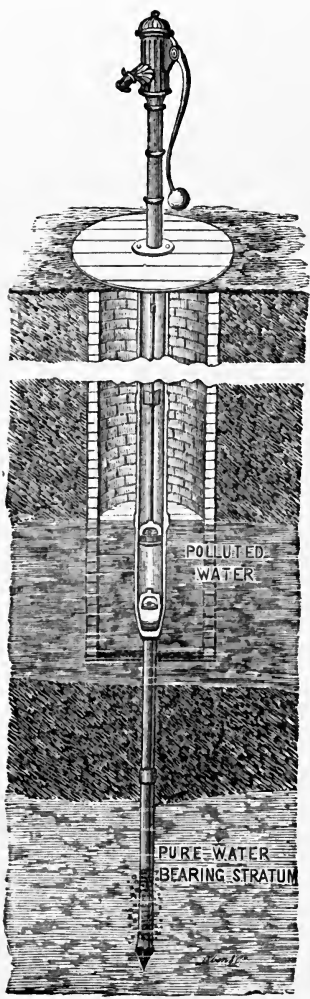

FIG. 14.—TUBE WELL FROM DUG WELL.

water in the well, the pit is sunk 15 ft., bringing the water-level from the bottom of the pit to 25 ft. When the permanent pump is fixed, the hole may be re-filled, but it is more advisable to "stein" it.

By this means, dug wells can easily be deepened at a trifling outlay, and polluted sources be at the same time avoided.

Connecting Wells.—It frequently occurs that large supplies are required for towns, manufactories, irrigation, etc.

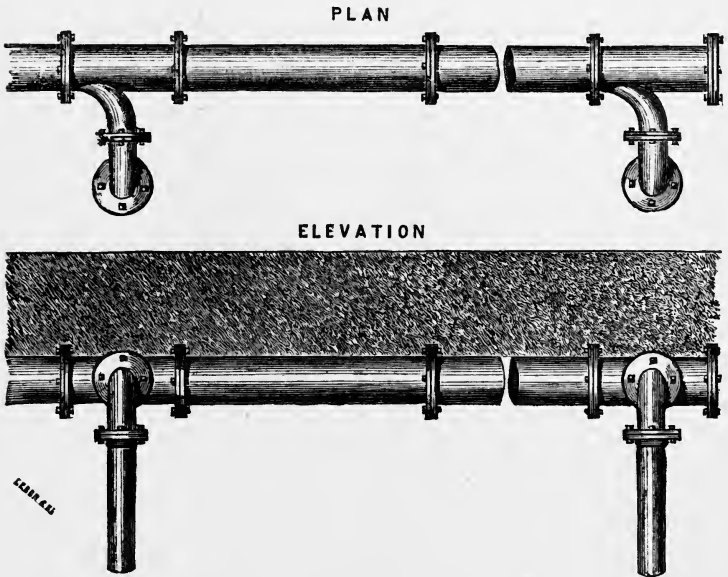

FIG. 15.—CONNECTED WELLS.

To accomplish this, as many wells as necessary are connected, as illustrated in Fig. 15. In such cases it will be found far more economical to test each spot with the smallest well previous to fixing the permanent one, as the probable yield will thus be approximately ascertained, and

this will govern the number and size of wells required to furnish the supply wanted. Results obtained by this means will be found far more satisfactory and economical than by drawing from one point as with dug wells. Yields vary greatly with the nature of the strata, and it often occurs that a larger tube well will not increase the yield in proportion to a smaller one.

The average quantities obtained from tube wells are as follows: 1½-in., 500; 2-in., 1000; 3-in., 2000 gall. per hour.

For transport purposes, the smallest well will be found in every way the least expensive. Tube wells can be coupled either by cast-iron flanged pipes with rubber joints or by wrought-iron socketted pipes, fitted with T-pieces and bends in the same manner as cast-iron. The whole of the rising main is laid in a trench 18 in. to 2 ft. under ground. The distance which the wells should be placed apart generally varies from 15 to 18 ft., being to a great extent governed by the water-bearing stratum; there are cases where they may be nearer to one another without affecting the draught, but the figures given are a reliable average.

Costs.—The following details of prices for materials and work in sinking driven tube wells are taken from C. Isler & Co.'s estimates:—

MATERIALS ONLY.

1½-in. well-tubing, 1s. per ft.	2-in. tube-well apparatus (Fig. 8)
„ 3-ft. points, 10s. each.	6l. 6s.
„ 3-ft. sand-tubes, 20s. each.	„ ditto, with tools complete, 16l.
„ tube-well apparatus (Fig. 8),	„ tube-well apparatus (tripod pat-
5l. 5s.	tern), 7l. 7s.
„ ditto, with tools complete, 11l.	„ ditto, with tools complete, 17l.
„ tube-well apparatus (tripod	3-in. well-tubing, 3s. 6d. per ft.
pattern), 6l.	„ 3-ft. points, 38s. each.
„ ditto, with tools complete, 12l.	„ 3-ft. sand-tubes, 58s. each.
2-in. well-tubing, 2s. per ft.	„ tube-well apparatus, complete
„ 3-ft. points, 20s. each.	with all tools and sheer-legs,
„ 3-ft. sand-tubes, 28s. each.	31l.

HAND-PUMPS FOR TUBE WELLS.

Common Pitcher Spout.	Strong Pitcher Spout.	Standard, with Valve Door.
3-in. barrel, 18s.	3-in. barrel, 28s.	3-in. barrel, 55s.
4 „ „ 22s.	4 „ „ 33s.	4 „ „ 75s.
6 „ „ 68s.		

MATERIALS AND WELL-DRIVER'S TIME.

		£	s.	d.			£	s.	d.
1½-in. . .	12 ft. deep	2	3	6	1½-in. . .	27 ft. deep	4	6	0
„ . .	15 „	2	12	0	„ . .	30 „	4	14	6
„ . .	18 „	3	0	6	„ . .	33 „	5	3	0
„ . .	21 „	3	9	0	„ . .	36 „	5	11	6
„ . .	24 „	3	17	6	„ . .	39 „	6	0	0

Beyond this depth, 2s. 10d. per ft. ; 3-ft. galvanised points (18s.), sand-strainer (15s.), and pumps extra.

		£	s.			£	s.
2-in. . .	12 ft. deep	4	0	2-in. . .	27 ft. deep	7	15
„ . .	15 „	4	15	„ . .	30 „	8	10
„ . .	18 „	5	10	„ . .	33 „	9	5
„ . .	21 „	6	5	„ . .	36 „	10	0
„ . .	24 „	7	0	„ . .	39 „	10	15

Beyond this depth, 5s. per ft. ; 3-ft. galvanised points (35s.), sand-strainer (25s.), and pumps extra.

		£	s.			£	s.
3-in. . .	12 ft. deep	7	10	3-in. . .	27 ft. deep	15	0
„ . .	15 „	9	0	„ . .	30 „	16	10
„ . .	18 „	10	10	„ . .	33 „	18	0
„ . .	21 „	12	0	„ . .	36 „	19	10
„ . .	24 „	13	10	„ . .	39 „	21	0

Beyond this depth, 10s. per ft. ; 3-ft. galvanised points (3l.), sand-strainer (35s.), and pumps extra.

Testing localities, 20s. per diem.

CHAPTER IV.

BORED TUBE WELLS.

Scope.—When hard ground or solid rock is encountered, through which the cutting point or edge of tube cannot be forced with reasonable facility and speed, a way must be made for the tube by boring a hole and removing the debris in advance of the tube, either by percussion (which churns up the rock to powder or mud) or by diamond or calyx drilling (which cuts out a solid core).

Early Methods.—The first method of well-boring known in Europe was that called the Chinese, in which a chisel, suspended by a rope and surrounded by a tube a few feet long, is worked up and down by means of a spring-pole or lever at the surface. The twisting and untwisting of the rope prevents the chisel from always striking in the same place; and by its continued blows the rock is pounded and broken. The chisel is withdrawn occasionally, and in its place is lowered a bucket or shell-pump, having a hinged valve at the bottom opening upwards, so that a quantity of the debris becomes enclosed in the bucket, and is drawn up by it to the surface. The lowering of the bucket is repeated until the hole is cleared, and the chisel is then put to work again.

In Fig. 16 is shown an apparatus on the Chinese system; it may be used for either hemp-rope or wire-rope, and was originally made for hoop-iron. At A is a log of oak, set perpendicularly so deep in the ground as to pene-

trate the loose gravel and pass a little into the rock, standing firmly in its place; it is well rammed with gravel, and the ground is levelled so that the butt of the log is flush with the surface of the ground or a little below it. Through this log, which, according to the depth of loose ground, may be 5 to 30 ft. long, a vertical hole is bored by an

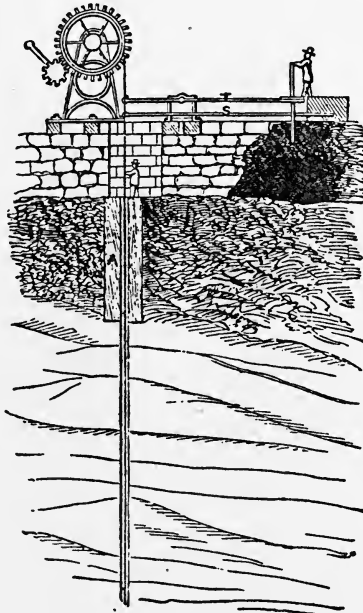

FIG. 16.—CHINESE BORING.

auger of a diameter equal to that of the intended boring in the rock. On top of the ground, at one side of the hole, is a windlass whose drum is 5 ft. diam.; the cog-wheel which drives it is 6 ft., and the pinion on the crank-axle is 6 in. This windlass serves for hoisting the spindle or drill, and is of large diameter to prevent short bends in the iron (which would soon become brittle) and to prevent permanent bends.

On the opposite side of the windlass is a lever of unequal leverage, about one-third at the side of the hole, and two-thirds at the opposite side, where it ends in a cross or broad end when men do the work. The workmen, with one foot on a bench or platform, rest their hands on a railing, and work with the other foot the long end of the lever. In this way the whole weight of the men is made use of. The lift of the bore-bit is 10 to 12 in., which causes the men to work the treadle 20 to 24 in. high. Below the treadle T is a spring-pole S, fastened under the platform on which the men stand; the end of this spring-pole is connected by a link to the working end of the lever, or to the rope directly, and pulls the treadle down. When the bore-spindle is raised by means of the treadle, the spring-pole imparts to it a sudden return, and increases by these means the velocity of the bit, and consequently that of the downward stroke.

Modern Methods.—This rudimentary system, adapted to out-of-the-way localities, and where human labour is cheaper than machinery, is now seldom seen, having given place to much improved percussive mechanism, and to a most ingeniously-contrived variety of tools for coping with the constant changes of strata.

Tools.—In Figs. 17, 18 and 19 are exhibited a selection of up-to-date well-boring tools; *a* is an auger for clays and stiff soils; *b*, a worm-auger for loosening gravelly and sandy soils; *c*, flat-bladed chisel; *d*, flat V chisel; *e*, flat T chisel; *f*, T V chisel; *g*, X chisel, all these chisels being for cutting through solid strata; *h*, circular chisel for trimming bore-hole true and vertical; *i*, spring chisel for enlarging bore-hole below pipes; *j*, “shell” for removing debris cut by the chisels; *k*, worm-nose shell for loose soils; *l*, water shell for testing supply preparatory to doing so by means

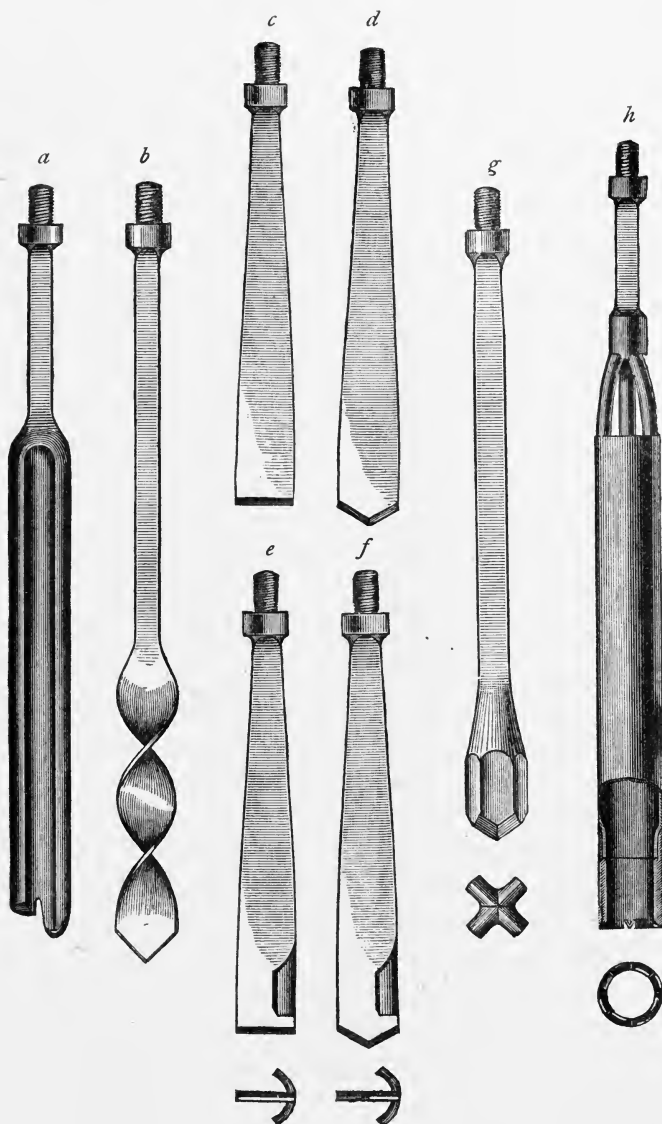

FIG. 17.—WELL-BORING TOOLS.

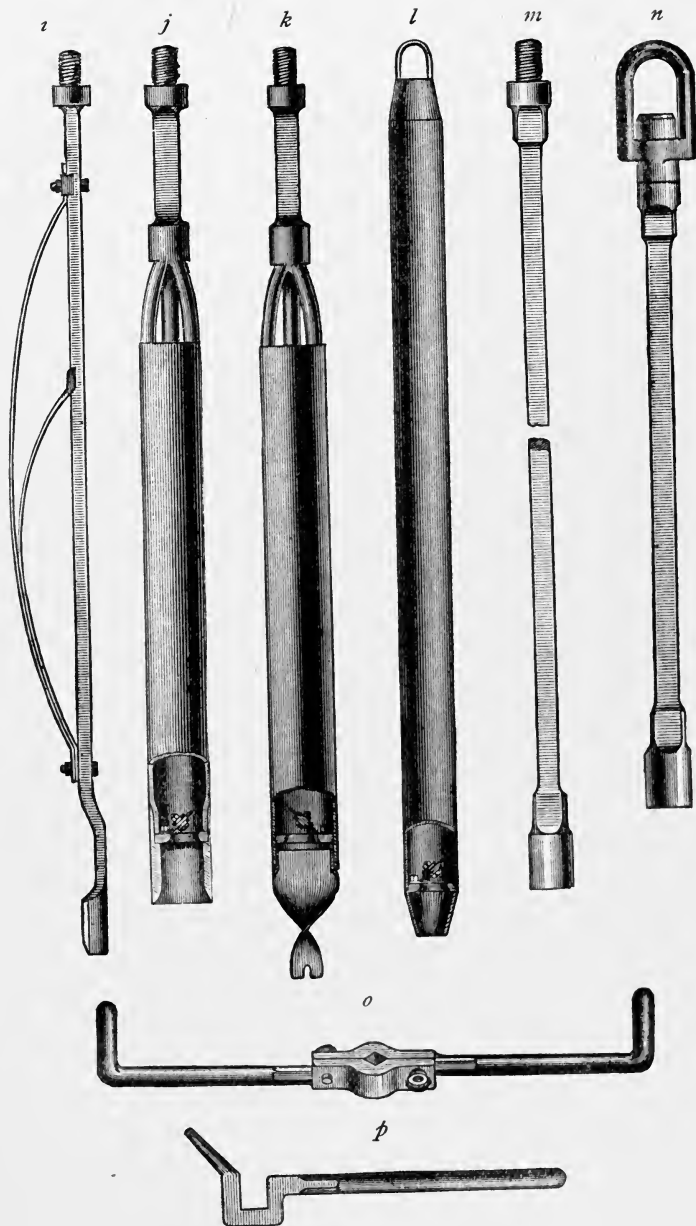

FIG. 18.—WELL-BORING TOOLS.

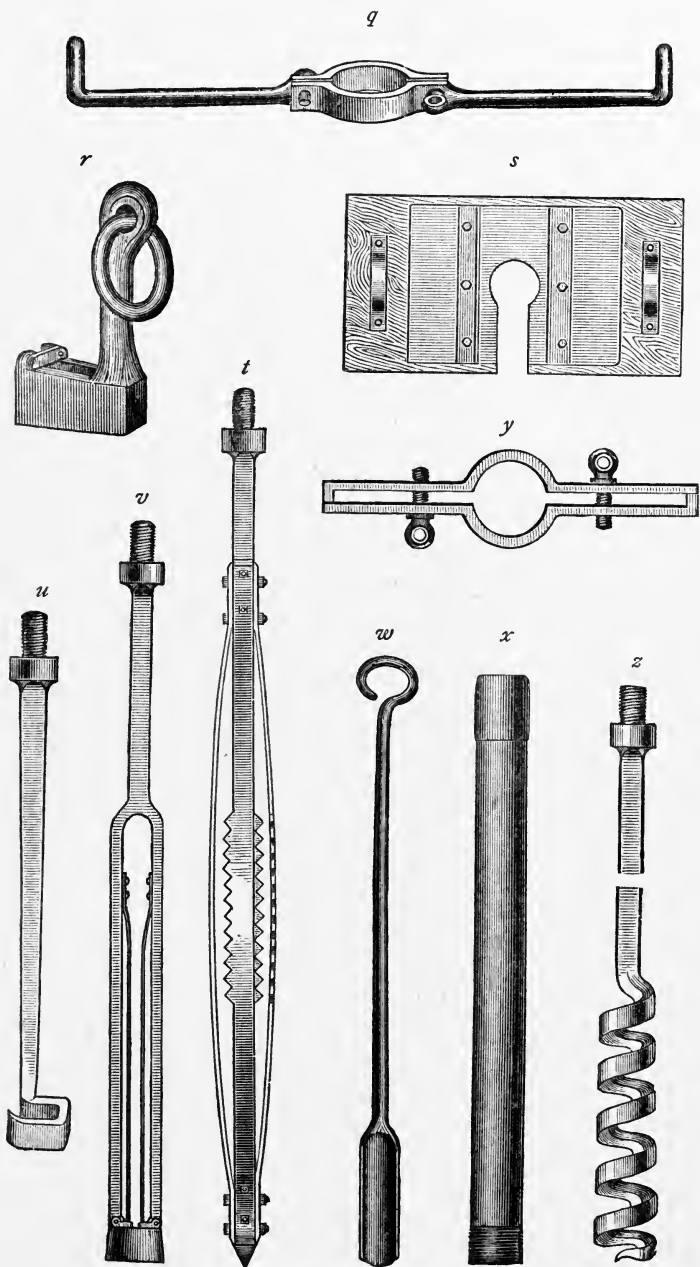

FIG. 19.—WELL-BORING TOOLS.

of a pump, when the water-level is below 30 ft. from surface; *m*, boring-rod; *n*, swivel-rod; *o*, tillers for turning rods; *p*, hand-dog for screwing rods, with taper end for tightening tiller-screws; *q*, tillers for screwing and turning pipes; *r*, dog for lowering and withdrawing rods; *s*, auger-board for holding lifting-dogs while screwing and unscrewing rods; *t*, spring rimer for enlarging bore-hole below pipes; *u*, crow's-foot for recovering broken rods; *v*, bell-box for recovering broken rods when the top joint is left on; *w*, cleaner for augers and shells; *x*, steel socketted tube; *y*, clamps for screwing tubes together and suspending them from pipe stage; *z*, worm for recovering broken tools.

Chisels are made from wrought iron or mild steel, and when small are usually 18 in. long by $2\frac{1}{2}$ in. extreme breadth, and weigh some $24\frac{1}{2}$ lb.; the cutting edge is faced with best steel. Whilst in operation they need careful watching, that they may be removed and fresh tools substituted when their edges are sufficiently worn to diminish their breadth. If this is not attended to, the size of the hole decreases, so that, when a new chisel of the proper size is introduced, it will not pass down to the bottom of the hole, and much delay is occasioned in enlarging it. In working with the chisel, the borer keeps the tiller or handles in both hands, one upon each, and moves slowly round the bore, in order to prevent the chisel from falling twice successively in the same place; this helps to preserve the bore circular. Every time a fresh chisel is lowered to the bottom, it should be worked round in the hole, to test whether the proper size and shape have been maintained; if this is not the case, the chisel must be raised at once, and be worked gradually and carefully until the hole is as it should be. The description of strata being cut by the chisel can be detected

with considerable accuracy by a skilful workman from the character of the shock transmitted to the rods. Should the stratum be very hard, the chisel may be worn and

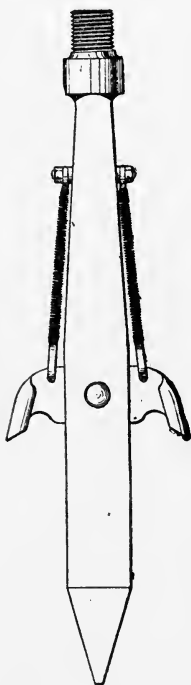

FIG. 19A.—EXPANDING TOOL FOR TRIMMING BORE-HOLE BELOW TUBES.

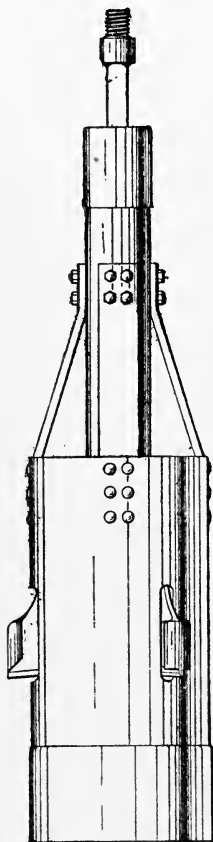

FIG. 19B.—EXPANDING TOOL WITH CENTRAL ROD FOR ADJUSTING CUTTERS.

blunted before cutting $\frac{3}{4}$ in., hence it must be frequently raised and examined; but 7 or 8 in. may be bored without examination when the nature of the stratum allows.

Augers are often 10 ft. long, 3 to 3½ ft. of which is shell.

Boring-rods are in 3-, 6-, 10-, 15-, or 20-ft. lengths of wrought iron or mild steel, preferably Low Moor or mild steel, and generally 1 in. to 3 in. square in section ; at one end is a male and at the other end a female screw for the purpose of connecting them together. The screw should not have fewer than 6 threads, as the female screw frequently splits, and the screw may have its thread so worn as to become liable to slip. Rods should be carefully examined every time they are drawn out of the bore-hole, as an unobserved failure may occasion much inconvenience, and even the loss of the hole. In addition to the ordinary lengths of rod, short pieces varying from 6 in. to 2 ft. are required for adjusting the rods at a convenient height.

When a projection in the bore-hole obstructs the downward course of the lining tubes, the hole is enlarged below the pipes by means of the spring rimer *t*. It consists of an iron shank, to which two thin strips are bolted, bowed out in the form of a drawing-pen. The rimer is screwed on to the boring-rods, and forced down through the pipes ; when below the last length of pipe, the rimer expands, and can then be turned round, which has the effect of scraping the sides and enlarging that portion of the hole subject to its operation.

Rigs.—Some means of suspending the tackle from which the rods are hung, as also of obtaining a lift for them, must be provided. Triangle gins are sufficient for light work, whilst for that of a heavier character sheers, derricks, or massive sheer-frames are requisite.

In England, for small works, the entire boring apparatus is frequently arranged as in Fig. 20, the tool being fixed at the end of wrought-iron rods instead of at the end of a rope,

as in the Chinese method. A is the boring tool ; B, rod to which the tool is attached ; D, levers whereby men E give a rotary motion to the tool ; F, chain for attaching

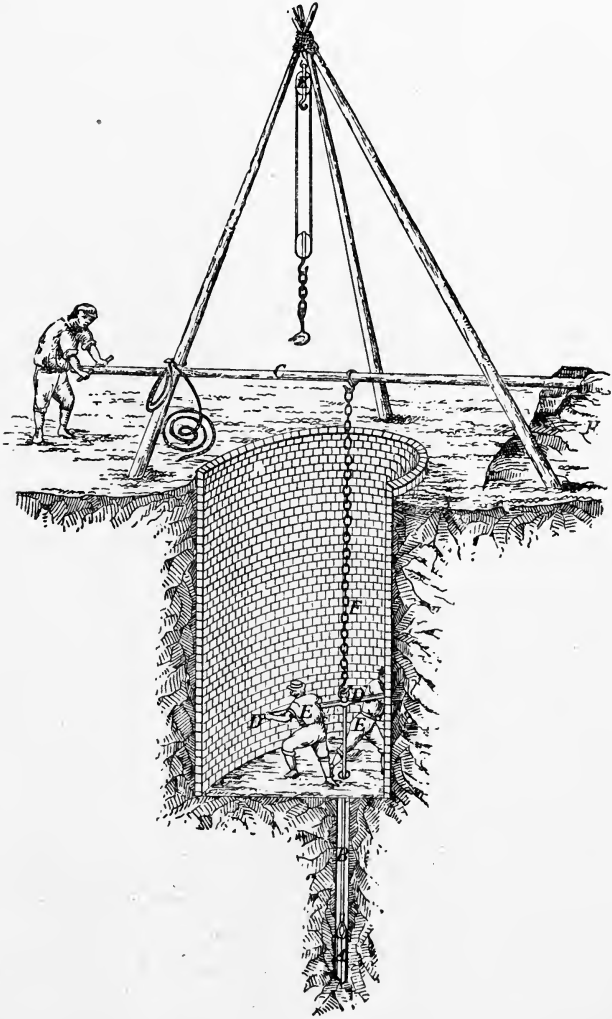

FIG. 20.—A BORING RIG.

boring apparatus to pole G, which is fixed at H, and by means whereof the man on surface transmits a vertical motion to the tool when necessary.

The sheer-legs, made of sound Norway spars not less than 8 in. diam. at the bottom, are placed over the bore-hole for the purpose of supporting the tackle for drawing the rods out of and lowering them into the hole. It is obvious that the more frequently it is necessary to break the joints in drawing and lowering the rods, the more time will be occupied in changing the tools, or in each cleaning of the hole ; and as the depth of the hole increases, the more tedious will the operation be. It therefore becomes a matter of much importance that the rods shall be drawn and lowered as quickly as possible, and to attain this end as long lengths as practicable must be drawn at each lift. The length of the lift or off-take, as it is termed, depending altogether upon the height of the lifting tackle above the top of the bore-hole, the length of the sheer-legs for a hole of any considerable depth should not be less than 30 to 40 ft. ; and they usually stand over a small pit or dug well, which may be sunk, when the ground is dry, to a depth of 20 or 30 ft. From the bottom of this pit the bore-hole may be commenced, and here will be stationed the man who has charge of the bore-hole while working the rods.

Fig. 21 shows another plan of commencing a boring. Here *a* are foot-blocks for the legs of the gyn ; *b*, rope shackle ; *c d*, staging ; *e*, guide-block. A pit lined with timber or masonry is sunk 10 or 12 ft. in the clear, and below this is a smaller pit 6 ft. square by 5 ft. deep, also lined. Above these the sheer-legs are erected so that the rope when passed round the wheel at top may hang over the centre of the pits. The top of the lower part is covered, all except a gap of 9 in. in the centre, with loose planks to

form a stage ; the two middle planks are 3 to 4 in. thick, as they may have to carry an auger-board, and sustain the whole weight of the rods.

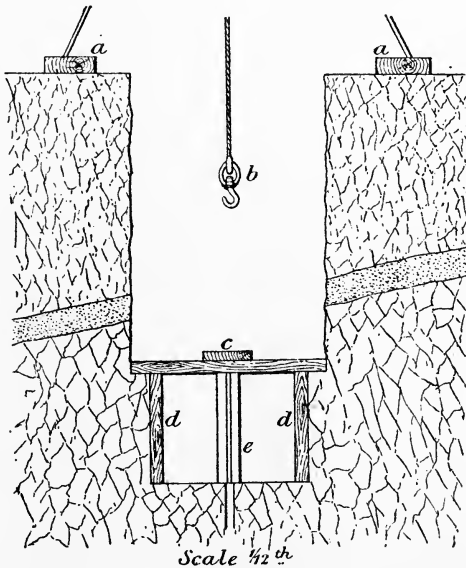

FIG. 21.—COMMENCING A BORE.

The arrangement in Fig. 22 is intended for deep or difficult boring with rods. A regular scaffolding is erected, upon which a platform is built. The boring-chisel A is, as in the last instance, joined by means of screw couplings to the boring-rods B. At each stroke, 2 men stationed at E turn the rod slightly by means of the tiller D. A rope F, which is attached to the boring-tool, is passed a few times round the drum of a windlass G, the end of the rope being held by a man at I. When the handles are turned by the men at L, the man at I pulls at the rope ; the friction between the rope and the drum of the windlass is then sufficient to raise the rods and boring-tool. As soon as the

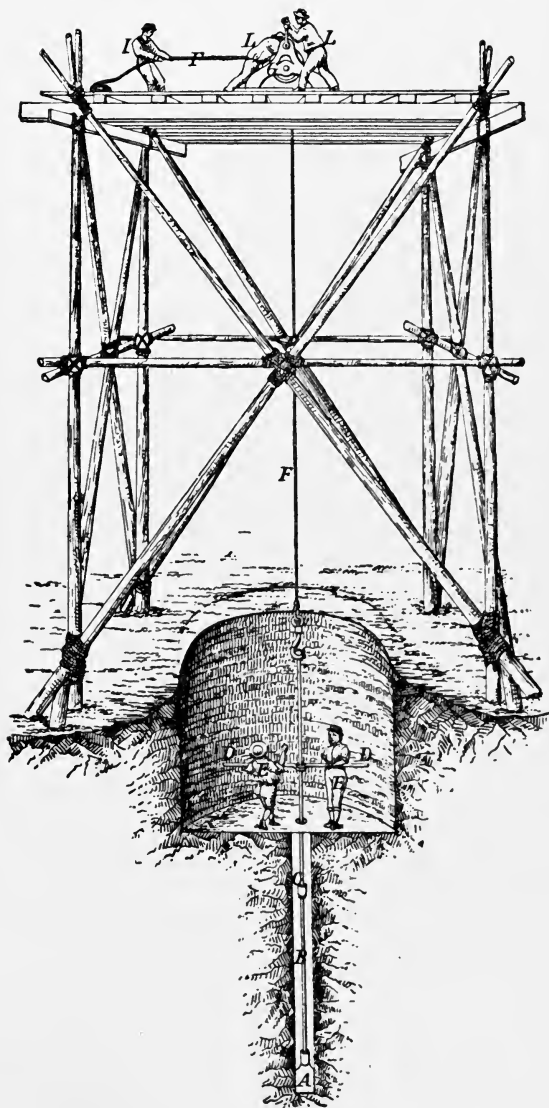

FIG. 22.—A BORING RIG.

tool has been raised to its intended height, the man at I slackens his hold upon the rope, and as there is insufficient friction on the drum to sustain the weight of the boring-tools, they fall. In due course, the tiller is unscrewed, and a lifting-dog, attached to the rope from the windlass, draws up the rods as far as the height of the scaffolding or sheer-legs will allow, when a man at E, by passing a hand-dog or key upon the top of the rod under the lowest joint drawn above the top of the hole, takes the weight of the rods at this joint, the men at L having lowered the rods for this purpose; and with another key, the rods are unscrewed at this joint, the rope is lowered again, the lifting-dog is put over the rod, another rod is screwed on, the rods are lifted, and the process is continued to completion.

Sometimes, if the hole is very dry, a little water poured down assists the work, but, if the hole is still unpipied, care is necessary not to wash away the sides.

When a deep boring is undertaken, direct from the surface, the operation had best be conducted with the aid of a boring sheer-frame such as is shown in Fig. 23. This consists of a framework of timber balks, upon which are erected 4 standards, 27 ft. high, 12 × 9 in. thick, 3 ft. 8 in. apart at the bottom and 1 ft. 2 in. at top. The standards are tied by cross-pieces, upon which are cut shoulders that fit into mortice-holes; they are fastened by wooden keys, the standards being surmounted by 2 head-pieces 5 ft. long, mortised and fitted. Upon the head-pieces 2 independent cast-iron guide-pulleys are arranged in bearings; over these pulleys are led the ends of 2 ropes coiling in opposite directions upon the barrel of a windlass; this is moved by spur gearing, and has a ratchet-stop attached to a pair of diagonal timbers, connected with the left-hand legs or standards of the sheers, near the ground. These ropes are used for raising and lowering the lengths of boring-rod.

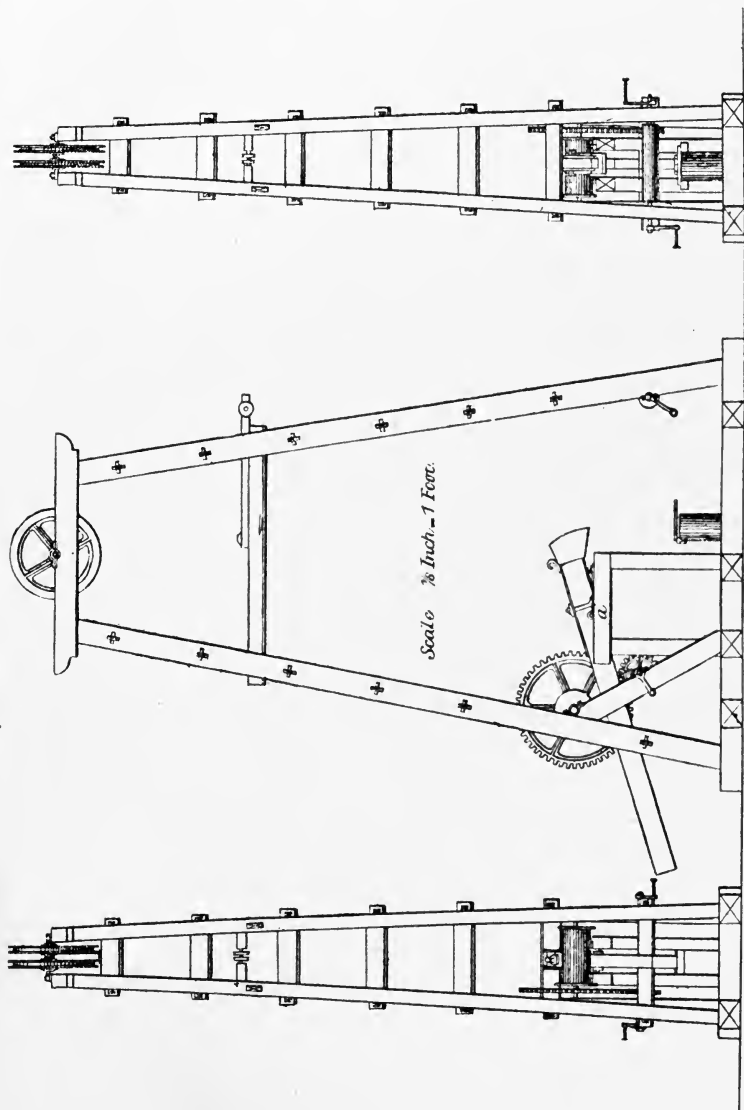

FIG. 23.—SHEER-FRAME FOR WELL-BORING.

At 8 ft. below the bearings of the top pulleys, a pair of horizontal traverses are fixed across the frame, supporting smaller pulleys, mounted on a cast-iron frame which is capable of motion between horizontal wooden slides. Over these pulleys is led a rope from a plain windlass fixed to the right-hand legs of the frame, to be used for raising and lowering the shell to extract the rubbish from the hole.

The lever, 15 ft. long and 9×6 in. in section, is supported by an independent timber frame. It has a cast-iron cap, fastened by means of two iron straps, with lugs through which bolts are passed, these being tightened with nuts in the ordinary manner. The bearing pins at *a* are $1\frac{1}{2}$ in. diam., and also form part of the lower strap. Upon the cap is an iron hook; to this is attached a chain carrying a spring-hook which bears the top shackle of the rods. The top of the bore-hole is surrounded by a wooden tube 1 ft. diam., provided with a hinged valve, whose action is similar to that of a clack-valve; this has a hole in the centre for the rods to pass up and down freely. The valve permits of the introduction and withdrawal of the tools, while preventing anything from falling into the bore-hole. The lever is applied by pressure upon its outer end; and as the relation of the long to the short arm is as 4 to 1, a depression of 2 ft. in the one case produces an elevation of 6 in. in the other: this is the minimum range of action, the maximum being 26 in.

The modern tendency is towards rigs which, while retaining all necessary strength, are much lighter and therefore more portable, as well as being more cheaply, easily, and speedily mounted and dismantled. Some examples of standard patterns used by C. Isler & Co. are shown in Figs. 24 to 27. It will be seen that reliance is placed on wrought-iron tubular structure throughout. Fig. 24 is

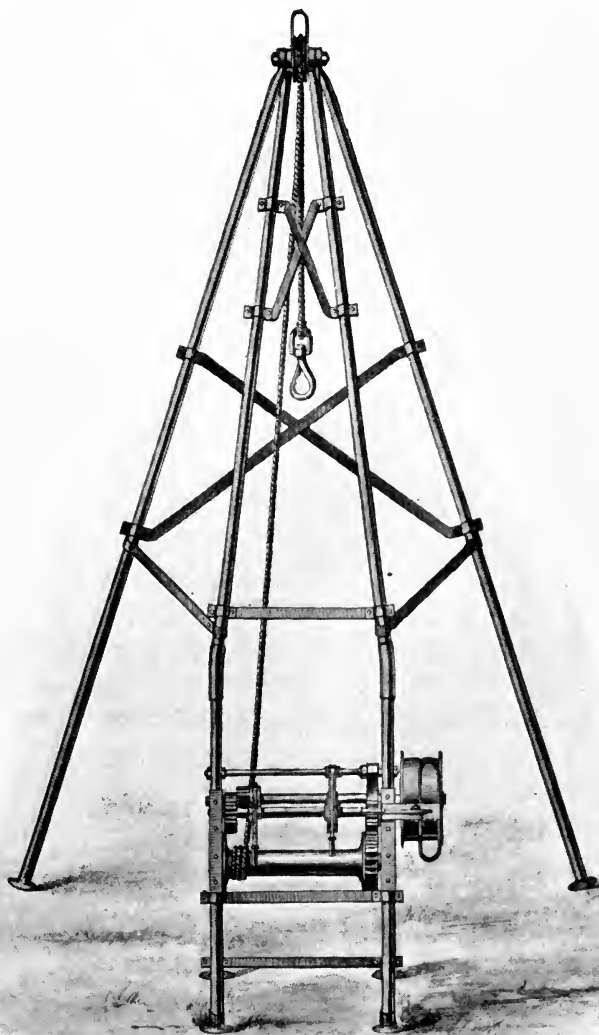

FIG. 24.—SHEER-LEGS AND WINDLASS.

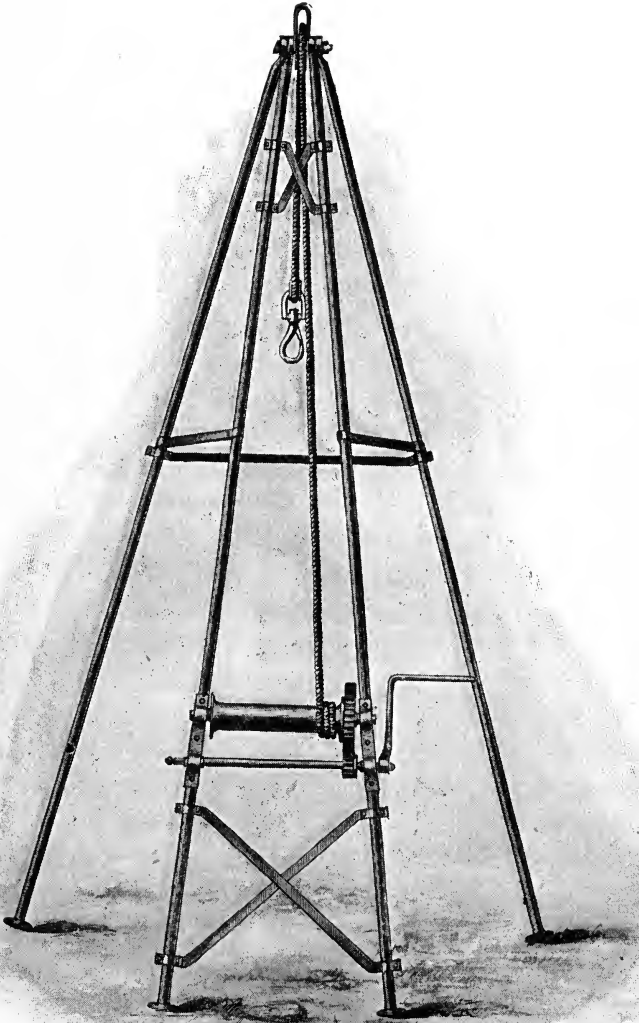

FIG. 25.—SHEER-LEGS AND WINDLASS.

double-gearred, with handles for manual operation and fast and loose pulleys for power. Fig. 25 is a lighter gear for hand-power only. In Fig. 26, a double-purchase crab-winch

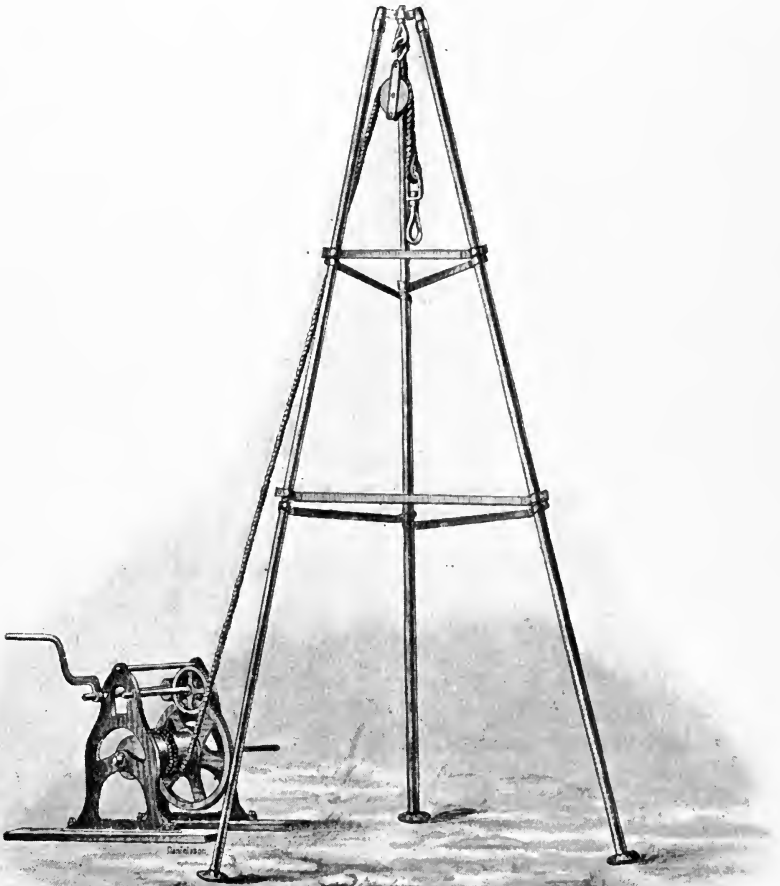

FIG. 26.—SHEER-LEGS AND CRAB-WINCH.

is mounted independently of the sheer-legs. Fig. 27 illustrates a more pretentious plant actuated by a small steam-driven winding-engine.

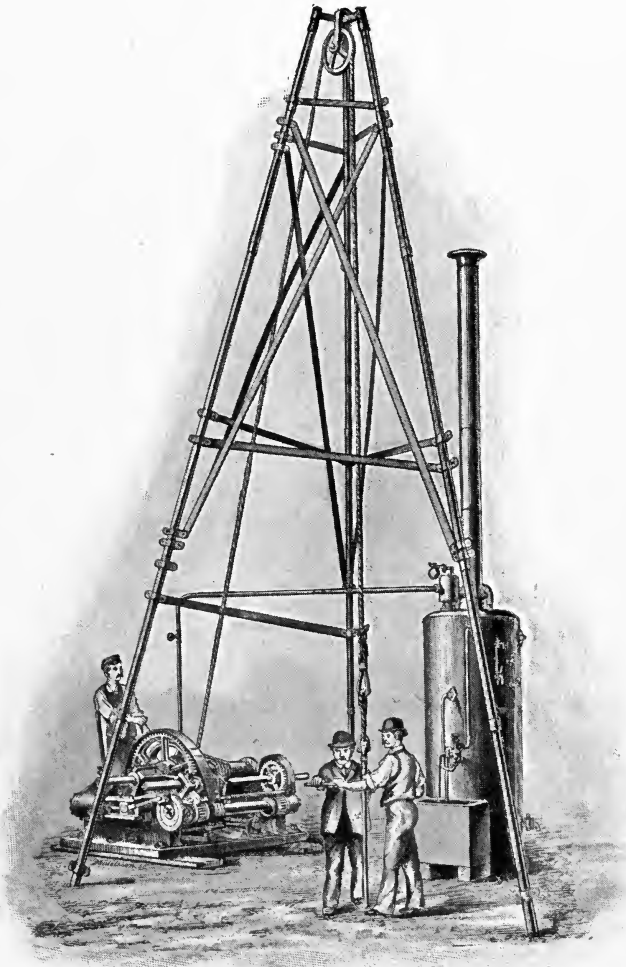

FIG. 27.—SHEER-LEGS AND STEAM-WINCH.

cylindrical and straight, and have a flush surface both outside and in. It will also appear that the thickness ought to bear a due proportion to the work required, and to the force likely to be used in screwing or driving it down. The first or bottom pipe is furnished with a steel shoe having a chisel-edge, and serves to trim the hole and cut a passage. The first length of pipe is raised by means of a pipe hanger, and lowered into the bore-hole until its top reaches about 1 ft. above the surface ; here a pair of pipe-clamps are securely fastened round it a few inches above the thread, and then the pipe is lowered until the clamps rest upon the board surrounding the top of the hole. The hanger is removed and screwed to a fresh length of tubing ; this in its turn is lowered, and screwed quite home—until the two pipes butt together. The tillers being taken off, the whole length of tubing is raised a few inches, and suspended whilst the clamps are removed from the lower part. There are now two lengths of pipe, which are allowed to descend as before ; when they are sufficiently deep, the clamps are re-applied, and the operation is repeated with each length screwed on.

Each joint should be oiled and screwed together with white or red lead ; spun yarn is not needed.

While being lowered, the pipes are turned, particularly when they begin to hang up, in order that the steel shoe may remove any projections in the bore-hole.

When the pipes have been lowered to the necessary distance, and the pipe-clamps have been screwed on to secure them from slipping, boring can be resumed with the smaller-sized tools, after lowering the shell to bring up any debris caused through lowering the tubing.

When the tubing will not go down freely, the rimer may be employed if the stratum is not too hard. It is

screwed on to the bottom rod. As the springs measure the outside diameter of the tubing, they require to be pressed so as to force them through, but when once well in the pipes, the weight of the rods should be sufficient to carry them down. As soon as the springs are below the lowest length of pipe, they expand to their full size; and by turning the rods until the springs work quite freely, and lowering the rimer a little as they are freed, the hole below the tubing is cut out. Using the rimer is an operation requiring great care and attention.

When the rimer has been withdrawn, the pipes are attached and lowered as before.

The tubing should be turned as long as it will move



FIG. 28A.—MONKEY.



FIG. 28B.—DRIVING-FLANGE.

before resorting to driving. It is advisable to use the longer lengths of pipe first, reserving the shorter lengths to the last, when the tubing will be going down more slowly. A long length standing up at a time when it becomes necessary to lower tools for clearing or enlarging below the tubing may seriously obstruct the work. Sometimes a short length of pipe may be used temporarily with advantage, a few feet of the descent being proceeded with, and then a longer length can be substituted as soon as the

boring has progressed sufficiently for a further lowering of pipes.

When it is found necessary to drive tubes, fix the driving-flange (Fig. 28B) by screwing it shoulder to shoulder to the top of the tube. The monkey (Fig. 28A) with guide-

FIG. 28C.
STEEL SOCKETTED
TUBE.



FIG. 28D.
STEEL SHOE.

bar, is lifted into position and the driving is proceeded with. This is done in the same way as "punching" with the tools as described below, with the exception that the spring hook is slipped through the rope sling on the monkey.

The success of the well-work depends on practical experience and soundness of lining tubes. The lining tubes should really be the first consideration, as employing an inferior tube means total collapse of the well—if not immediately, soon after completion.

The lining tube commonly and generally used, viz. a flush-jointed pipe, cannot stand any substantial strain such as these pipes have to bear during driving; and what occurs too often is the stripping or bursting of the joints, thereby causing utter failure, through creating a communication between the upper and lower part of the boring.

The lining tube recommended (Fig. 28C) is only of recent introduction, and supercedes all other kinds for the same purpose. It is of steel, as also is the socket which connects the pipes, allowing greater strength to be obtained in less substance; this, combined with the slight

setting in at the joints, practically renders the pipes flush outside as well as inside. When connected, they butt, leaving no space whatever between; by this means they form a solid joint, and it is therefore impossible for any of the joints to be otherwise than air and water-tight, and is a secure preventive against any percolation from surface or objectionable springs.

PRICES OF WROUGHT-IRON LAP-WELDED STEEL-SOCKETTED TUBES.

3 in. internal diameter, $\frac{1}{4}$ in. thick	4s. per foot.
4 " "	5s. "
5 " "	7s. "
6 " $\frac{5}{16}$ "	10s. "
$7\frac{1}{4}$ " "	13s. "
$8\frac{1}{2}$ " "	17s. "
10 " $\frac{3}{8}$ "	20s. "
$11\frac{1}{2}$ " "	25s. "

To withdraw broken or defective tubing quickly, two hooks attached to ropes are lowered down from opposite sides of the bore-hole, and caught on the rim of the lowermost tube; power is applied to haul the tubing up bodily.

Another most effective method for withdrawing broken or defective tubes is by a special expanding wedge tool, which enables pipes to be withdrawn by means of either the hydraulic or screw jack, as illustrated. It may, however, be said that during our thirty years' experience we have met with practically no mishaps with broken or defective tubes. Accidents happen mostly with flush-jointed or rivetted tubes.

An effective method of cutting out lining-tubes practised in the United States consists in lowering into the bore-hole an expanding cutter-head, in which the circular cutters are first tightened, and then put into action by turning the boring-rods at surface.

To reduce stoppages for withdrawal of debris the Fauvelle system was introduced, whereby the injection of a current of water through a central tube washes out the debris created by the cutting tool at the bottom. It has

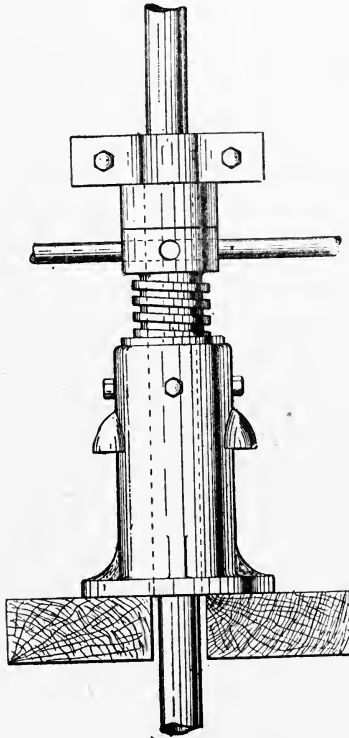

FIG. 28E.—HOLLOW JACK FOR WITHDRAWING TUBES.

answered tolerably well when applied to shallow borings ; but the quantity of water required to keep the boring-tool clear is a great objection, especially as in the majority of cases wells are bored in places lacking a large supply.

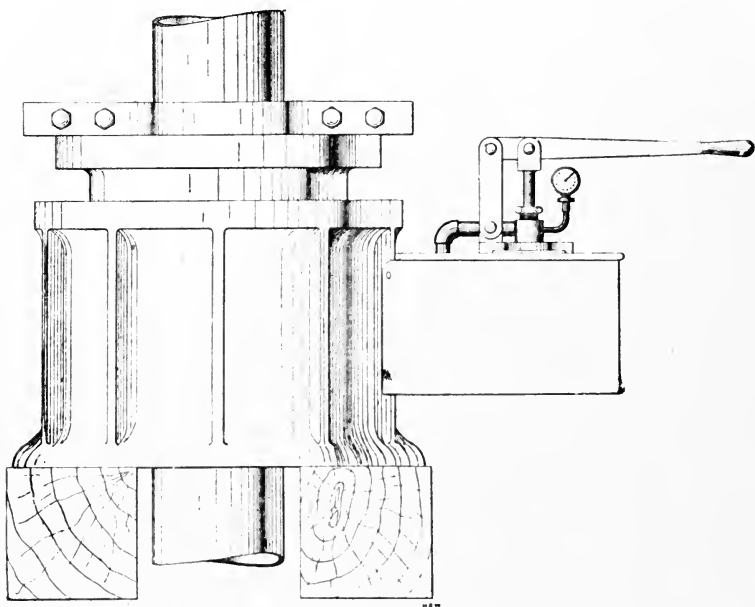

FIG. 28F.—C. ISLER & CO.'S IMPROVED HOLLOW HYDRAULIC JACK FOR WITHDRAWING LARGE TUBES.

Following are approximate prices for borings from the surface from 3 to 12 in. diam., exclusive of lining tubes and including all labour and necessary plant.

BORING IN GRAVEL, CLAY, SAND, CHALK OR OTHER SOFT STRATA.

Not exceeding 100 ft.	8s. to 20s. per ft.
" 200	" " " " " "	13s. ,, 30s. ,,
" 300	" " " " " "	18s. ,, 40s. ,,
" 400	" " " " " "	23s. ,, 50s. ,,
" 500	" " " " " "	28s. ,, 60s. ,,

BORING IN ROCK OR STONE, ACCORDING TO SIZE AND NATURE OF STRATA.

Not exceeding 100 ft.	20s. to 40s. per ft.
And not less than 200 ft.	25s. ,, 50s. ,,
" 300	" " " " " "	30s. ,, 60s. ,,
" 400	" " " " " "	35s. ,, 70s. ,,
" 500	" " " " " "	40s. ,, 80s. ,,

This does not include the cost of tubing, conveyance of plant and tools, professional superintendence, or working in rock of unusual hardness. A clause is usually inserted in the contract, to the effect that, if any unforeseen difficulty is met with in the course of the work, it is then paid for by the day, at a rate previously determined upon, until the difficulty has been overcome.

The following estimates for sets of boring tools are supplied by C. Isler & Co.

- (a) To bore 30 ft.—Two $2\frac{1}{2}$ -in. T-chisels, one $2\frac{1}{2}$ -in. flat chisel, one 2-in. shell, one 2-in. auger, one auger-board, one pair rod-tillers, two $\frac{3}{4}$ -in. lifting-dogs, two $\frac{3}{4}$ -in. hand-dogs, one spring-hook and rope, five 5-ft. by $\frac{3}{4}$ -in. boring-rods, one 5-ft. by $\frac{3}{4}$ -in. swivel-rod 12*l.* 10*s.*
- (b) To bore 50 ft.—One each $3\frac{1}{4}$ -in. and $2\frac{1}{4}$ -in. clay augers, one each 3-in. and 2-in. shoe-nose shells, one $3\frac{3}{4}$ -in. and two $2\frac{3}{4}$ -in. T-chisels, one each $3\frac{3}{4}$ -in. and $2\frac{3}{4}$ -in. flat chisels, one pair rod-tillers, one auger-board, two 1-in. lifting-dogs, two 1-in. hand-dogs, one bell-screw, one spring-hook, 40 ft. of 3-in. rope, one auger-cleaner, four 10-ft. and one 5-ft. by 1-in. boring-rods, one 5-ft. by 1-in. swivel-rod 27*l.*
 One set light tubular iron sheer-legs 12*l.*
- (c) To bore 100 ft.—One $2\frac{1}{4}$ -in. clay auger, one each 3-in. and 2-in. shoe-nose shells, two each $3\frac{3}{4}$ -in. and $2\frac{3}{4}$ -in. T-chisels, one each $3\frac{3}{4}$ -in. and $2\frac{3}{4}$ -in. flat chisels, one pair rod-tillers, one auger-board, two 1-in. lifting-dogs, two 1-in. hand-dogs, one crow's-foot, one bell-screw, one spring-hook, 40 ft. $3\frac{1}{2}$ -in. rope, one auger-cleaner, nine 10-ft. and one 5-ft. by 1-in. boring-rods, one 5-ft. by 1-in. swivel-rod 38*l.*
 One set light tubular iron sheer-legs 12*l.*

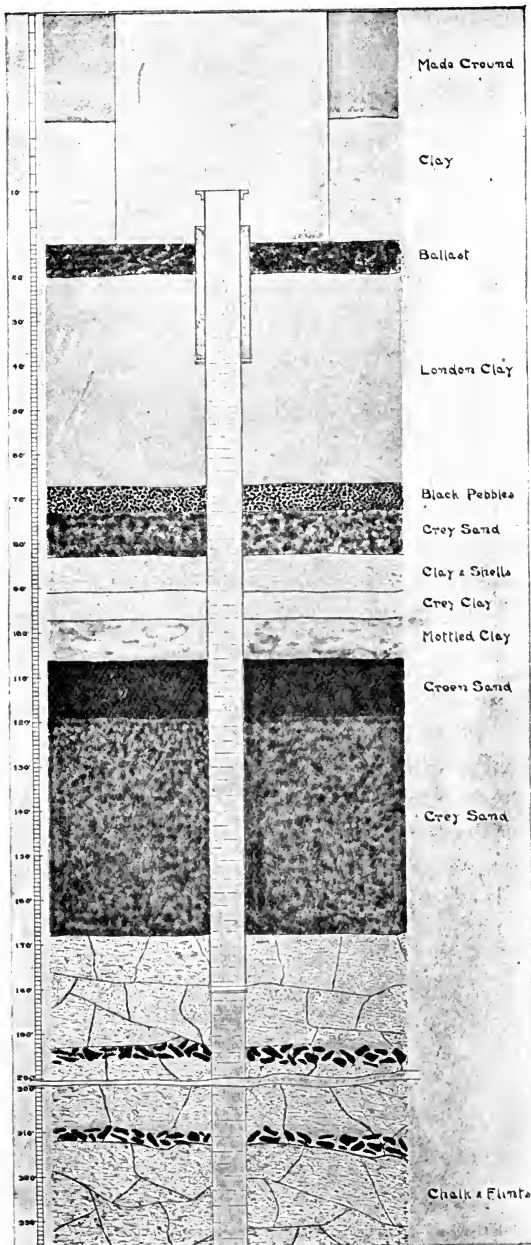

FIG. 28G.—SECTION OF AN ARTESIAN BORED TUBE WELL AT CANNING TOWN. 400 ft. deep; $11\frac{1}{2}$ in. internal diameter; minimum supply, 11,500 gals. per hour. Fixed by C. Isler & Co.

- (d) To bore 150 ft.—One each $4\frac{1}{4}$ -in. and $3\frac{1}{4}$ -in. clay augers, one each 4-in. and 3-in. shoe-nose shells fitted with latches for recovering broken tools, two each $4\frac{3}{4}$ -in. and $3\frac{3}{4}$ -in. T-chisels, one each $4\frac{3}{4}$ -in. and $3\frac{3}{4}$ -in. flat chisels, one pair rod-tillers and spare screws, one auger-board, two 1-in. lifting-dogs, two 1-in. hand-dogs, one crow's-foot, one spring-hook, 40 ft. of $4\frac{1}{2}$ -in. rope with rope slings and punching-rope, one auger-cleaner, fourteen 10-ft. and one 5-ft. by 1-in. boring-rods, one 5-ft. by 1-in. swivel-rod 45%
 One set sheer-legs and gearing 18%
 Fitted with fast and loose pulleys. 5%
- (e) To bore 200 ft.—One each $5\frac{1}{4}$ -in., $4\frac{1}{4}$ -in. and $3\frac{1}{4}$ -in. clay augers, one each 5-in., 4-in. and 3-in. shoe-nose shells fitted with latches for recovering broken tools, two each $5\frac{3}{4}$ -in., $4\frac{3}{4}$ -in. and $3\frac{3}{4}$ -in. T-chisels, one each $5\frac{3}{4}$ -in., $4\frac{3}{4}$ -in. and $3\frac{3}{4}$ -in. flat chisels, one pair rod-tillers and spare screws, one auger-board, two $1\frac{1}{4}$ -in. lifting-dogs, two $1\frac{1}{4}$ -in. hand-dogs, one crow's-foot, one spring-hook, 40 ft. of $4\frac{1}{2}$ -in. rope with rope-slings and punching-rope, one auger-cleaner, nineteen 10-ft. and one 5-ft. by $1\frac{1}{4}$ -in. boring-rods, one 5-ft. by $1\frac{1}{4}$ -in. swivel-rod 68%
 One set sheer-legs and gearing 23%
 Fitted with fast and loose pulleys. 7%
- (f) To bore 300 ft.—One each $6\frac{1}{4}$ -in., $5\frac{1}{4}$ -in. and $4\frac{1}{4}$ -in. clay augers, one each 6-in., 5-in. and 4-in. shoe-nose shells fitted with latches for recovering broken tools, two each $6\frac{3}{4}$ -in., $5\frac{3}{4}$ -in. and $4\frac{3}{4}$ -in. T-chisels, one each $6\frac{3}{4}$ -in., $5\frac{3}{4}$ -in. and $4\frac{3}{4}$ -in. flat chisels, one pair rod-tillers with spare screws, one

auger-board, two $1\frac{1}{4}$ -in. lifting-dogs, two $1\frac{1}{4}$ -in. hand-dogs, one crow's-foot, one spring-hook, 40 ft. of $5\frac{1}{2}$ -in. rope with rope-slings and punching-rope, one auger-cleaner, twenty-nine 10-ft. and one 5-ft. by $1\frac{1}{4}$ -in. boring-rods, one 5-ft. by $1\frac{1}{4}$ -in. swivel-rod 90/.

One set sheer-legs and gearing 23/.

Fitted with fast and loose pulleys. 7/.

(g) To bore 400 ft.—One each $7\frac{1}{4}$ -in., $6\frac{1}{4}$ -in., $5\frac{1}{4}$ -in. and $4\frac{1}{4}$ -in. clay augers, one each 6-in., 5-in. and 4-in. shoe-nose shells fitted with latches for recovering broken tools, two each $8\frac{1}{4}$ -in., $6\frac{3}{4}$ -in., $5\frac{3}{4}$ -in. and $4\frac{3}{4}$ -in. T-chisels, one each $8\frac{1}{4}$ -in., $6\frac{3}{4}$ -in., $5\frac{3}{4}$ -in. and $4\frac{3}{4}$ -in. flat chisels, one pair rod-tillers with spare screws, one auger-board, two each $1\frac{1}{2}$ -in. and $1\frac{1}{4}$ -in. lifting-dogs, two each $1\frac{1}{2}$ -in. and $1\frac{1}{4}$ -in. hand-dogs, one crow's-foot, one spring-hook, 40 ft. of $6\frac{1}{2}$ -in. rope with rope-slings and punching-rope, one auger-cleaner, ten 10-ft. by $1\frac{1}{2}$ -in. boring-rods, twenty-nine 10-ft. and one 5-ft. by $1\frac{1}{4}$ -in. boring-rods, one 5-ft. by $1\frac{1}{4}$ -in. swivel-rod 117/.

One set sheer-legs and gearing 30/.

Fitted with fast and loose pulleys. 7/ 10s.

(h) To bore 500 ft.—One each $9\frac{1}{4}$ -in., $7\frac{1}{4}$ -in., $6\frac{1}{4}$ -in. and $5\frac{1}{4}$ -in. clay augers, one each 7-in., 6-in. and 5-in. shoe-nose shells fitted with latches for recovering broken tools, two each $9\frac{1}{4}$ -in., $8\frac{1}{4}$ -in., $6\frac{3}{4}$ -in. and $5\frac{3}{4}$ -in. T-chisels, one each $9\frac{1}{4}$ -in., $8\frac{1}{4}$ -in., $6\frac{3}{4}$ -in. and $5\frac{3}{4}$ -in. flat chisels, one pair rod-tillers with spare screws, one auger-board, two each $1\frac{1}{2}$ -in. and $1\frac{1}{4}$ -in. lifting-dogs, two each $1\frac{1}{2}$ -in. and $1\frac{1}{4}$ -in. hand-dogs, one spring-hook, 40 ft. of $6\frac{1}{2}$ -in. rope with rope slings and punching-rope, one auger-cleaner,

twenty 10-ft. by 1½-in. boring-rods, twenty-nine
 10-ft. and one 5-ft. by 1¼-in. boring-rods, one 5-ft.
 by 1¼-in. swivel-rod 150*l*.
 One set sheer-legs and gearing 35*l*.
 Fitted with fast and loose pulleys. 10*l*.

TUBES, AND APPLIANCES FOR FIXING THEM.

Internal diameter . .	3 in.	4 in.	5 in.	6 in.	7¼ in.	8½ in.
Thickness	¼ ,,	¼ ,,	¼ ,,	$\frac{5}{16}$,,	$\frac{5}{16}$,,	$\frac{5}{16}$,,
Price of—	£ s. d.	£ s. d.	£ s. d.	£ s. d.	£ s. d.	£ s. d.
Tubes	0 4 0	0 5 0	0 6 0	0 9 0	0 11 0	0 15 0
Steel shoes	0 10 0	0 13 0	1 0 0	1 6 0	2 5 0	2 10 0
Pipe-clamps	1 5 0	1 7 6	1 10 0	2 0 0	2 10 0	3 10 0
Pipe-tillers	1 5 0	1 7 6	1 10 0	2 0 0	2 10 0	3 10 0
Driving-flanges	1 3 0	2 2 0	2 7 6	3 2 6	3 17 6	4 17 6
Pipe-hangers	0 10 0	0 13 0	0 18 0	1 0 0	1 5 0	1 17 6
Cast-iron flanges	0 3 0	0 6 0	0 10 0	0 12 0	0 18 0	1 4 0
Water-shells	1 2 0	1 10 0	1 10 0	2 0 0	2 0 0	2 15 0
Spring rimers	3 0 0	3 12 6	4 2 6	4 10 0	4 13 0	4 17 6
Spare blades for do.	1 10 0	1 12 0	2 0 0	2 2 6	2 5 0	3 10 0
Circular chisels	3 10 0	4 12 6	5 10 0	6 7 6	7 14 0	10 0 0
Caps	0 5 0	0 7 0	0 9 0	0 11 0	0 17 0	1 0 0

Price of chain pipe-wrench from 1*l*. 7*s*.

Price of driving-monkeys: 300-lb., 3*l*. 5*s*.; 500-lb., 6*l*.; 800-lb., 8*l*. 10*s*.; 1600-lb., 17*l*.

CHAPTER V.

KIND-CHAUDRON DEEP-BORING SYSTEM.

THE first really deep well was bored by Mulot, at Grenelle, for the City of Paris ; it was commenced in 1832, and after more than 8 years' incessant labour, water finally rose from the total depth of 1798 ft. Subsequently many wells have been sunk on the Continent, even deeper than the well of Grenelle, reaching in some cases to 2800 ft., but all of small diameter. German engineers introduced important modifications of the tools employed. Thus, Euyenhausen imparted a sliding movement to the striking part of the tool used for comminuting the rock, so that it always fell through a certain distance, producing a uniform action upon the rock at the bottom, and avoiding jar of the tools.

Kind, who had begun to apply his system to the sinking of large shafts for winning coal, was entrusted by the Municipal Council of Paris to bore a new well at Passy.

In sinking the Passy well, the weight of the trepan for comminuting the rock was about 36 cwt., the height through which it fell was nearly 2 ft., and its diameter was 39 in. The rods were of oak, about 8 in. on the side, and the dimensions of the cutting tool were limited to 39 in. because it worked the whole time in water ; but generally the class of borings Kind undertook justified resorting to tools of great dimensions. When sinking shafts for winning coal, his operations required to be carried on with the full diameters of 10 to 14 ft. ; and he then drove a boring

40 in. diam. in the first instance, and subsequently enlarged this. There can be no objection to executing borings of this diameter ; but opposition to Kind's plan of sinking the Passy well was founded upon the assumption that he would not get a larger supply of water from the sub-Cretaceous formations than had been met with at Grenelle, where the diameter of the boring at bottom was not more than 8 in. It has been proved that there is a direct gain in adopting the larger borings, not only as regards the quantity of water to be derived from them, but also in their execution, arising from the fact that the tools can be made more secure against the effects of torsion or of concussion against the sides of the excavation, which is the cause of the most serious accidents met with in well-boring.

Kind's trepan embraces some peculiar details, which are shown in Fig. 30. It is composed of two principal pieces—frame and arms, both of wrought iron, with the exception of the teeth of the cutting part, which are of cast steel. The frame has at the bottom a series of slightly-conical holes, into which the teeth are inserted and tightly wedged. The teeth are placed with their cutting edges on the longitudinal axis of the frame ; and at the extremity of the frame are formed two heads, forged out of the same piece with the body of the tool, which also carries two teeth, placed in the same direction as the others, but of double their width, in order to render this part of the tool more powerful. By increasing the dimensions of these end teeth, the diameter of the boring can be augmented, so as to compensate for the diminution of the clear space caused by the tube lining.

Above the lower part of the frame of the trepan, is a second piece, composed of two parts bolted together, and made to support the lower portion of the frame. This also

carries at its extremities two teeth, which serve to guide the tool in its descent, and to work off the projections left by the lower portion of the trepan. Above this, again, are the guides of the machinery, properly speaking, consisting of two pieces of wrought iron, arranged in the form of a cross, with the ends turned up, so as to preserve the machinery perfectly vertical in its movements, by pressing

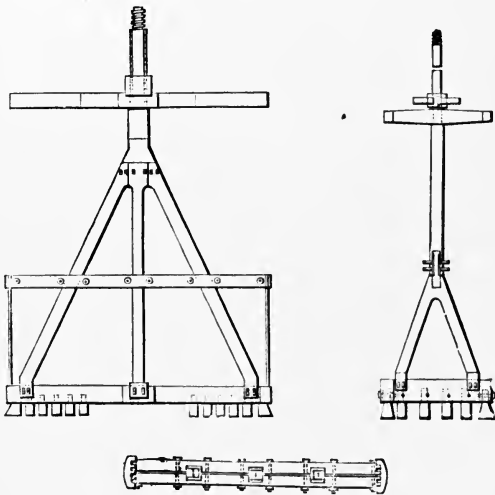

FIG. 30.—KIND TREPAN.

against the sides of the boring already executed. These pieces are independent of the blades of the trepan, and may be moved closer to or farther from it, as desired. The stem and the arms are terminated by a single piece of wrought iron, which is joined to the frame with a kind of saddle-joint, and is kept in place by keys and wedges. The whole of the trepan is finally jointed to the great rods that communicate the motion from the surface, by means of a screw-coupling, formed below the part of the tool which bears the joint ;

this arrangement permits the free fall of the cutting part, and unites the top of the arms and frame with the rod (Fig. 31). It has been proposed to substitute for this screw-coupling a keyed joint, in order to avoid the inconvenience frequently found to attend the rusting of the screw when it becomes necessary to withdraw the trepan.



FIG. 31.—
KIND ROD.

The sliding joint was adopted by Kind from Euyenhausen's invention, and is one of the peculiarities of his system. So long as his operations were confined to the small dimensions usually adopted for well borings, he contented himself with making a description of joint with a "free-fall"—a simple movement of disengagement regulating the height fixed by the machinery itself, like the fall of the monkey in a pile-driving machine; but this did not answer

when applied to large borings, and it presented certain dangers. Kind, then, for the larger class of borings, availed himself of sliding guides, so contrived as to be equally thrown out of gear when the machinery had come to the end of the stroke, and maintained in their respective positions by being made in two pieces, of which the inner worked upon slides, moving freely in the piece that communicated the motion to the striking part of the machinery. The two parts of the tool were connected by pins, and with a sliding joint, which, in the Passy well, was thrown out of gear by the reaction of the column of water above the tool unloosing the click that upheld the lower part of the trepan, Fig. 32. These departures from the usual way of releasing the tool and guiding it in its fall are condemned by some authorities, who object to the system of making the column of water act upon a disc to set the click in motion, as requiring

the presence of a column of water not always to be commanded, especially when boring in the Carboniferous strata.

The rods used for suspension of the trepan, and for transmission of the blows to it, were of oak; this in itself constitutes a characteristic difference between the style of tools introduced by Kind and those made by the majority of well-borers. The resistance which wood offers by its elasticity to the effects of any sudden jar is also a point

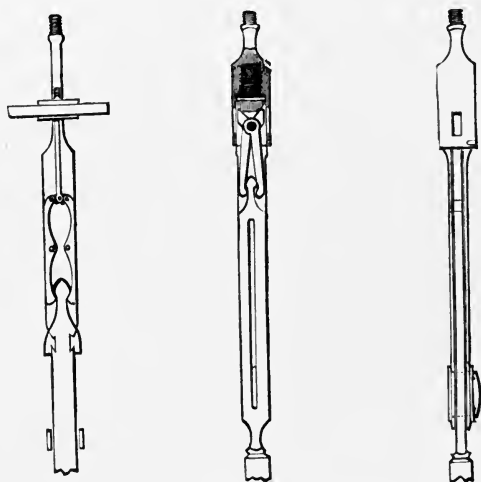

FIG. 32.—SLIDING JOINTS.

of superiority to iron, for the latter is liable to change its form under the influence of this cause. The resistance to torsion need not, however, be much dwelt on, for the turn given to the trepan is always made when the tool is lifted up from its bed. Kind recommended that straight-grown trees of the requisite diameter should be selected, rather than that rods should be made of cut timber, as there is less danger of the wood warping, and the character of the wood is more homogeneous. He generally used these trees in

lengths of about 50 ft., and connected them at the ends with wrought-iron joints, fitting one into the other. The iron-work of these joints is made with a shoulder underneath the screw-coupling, to allow the rods to be suspended by the ordinary crow's-foot during the operation of raising or lowering. In the works executed at Passy, a frame was erected over the centre of the boring, of a height to allow of the rods being withdrawn in two lengths at a time, thus securing considerable economy of time and labour.



FIG. 33.—SHELL.

As in other methods, Kind's system of removing the pounded rock involved withdrawal of the comminuting tool, in order that the "shell" might be inserted. Kind's shell, Fig. 33, consisted of a cylinder of wrought iron, suspended from the rods by a frame, and fastened to it at a little below the centre of gravity, so that the operation of upsetting it, when loaded, could be easily performed. This cylinder was lowered to the level of the last workings of the trepan, and the material already detached by that instrument was forced into the shell by the gradual movement of the latter in a vertical direction, the bottom being made to open upwards, with hinged flaps. The ball-clack, Fig. 34, a most useful appliance for clearing holes, was not used by him.

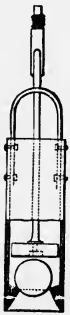

FIG. 34.
BALL-CLACK.

At Passy great strength was given to the head of the striking tool, and to the part of the machinery applied to turn the trepan, because the great weight of the latter superinduced the danger of its break-

ing off under the influence of the shock, and because the solidity of this part of the machinery necessarily regulated the whole working of the tool. The head of the boring arrangement was connected with the balance-beam of the steam-engine by a straight link-chain, with a screw-coupling, admitting of being lengthened as the trepan descended, Fig. 35. The balance-beam, in order to increase its elastic force in the upward stroke, is made of wood, in two pieces, the upper being of fir and the lower of beech. The whole of the machinery is put in motion by steam, which is admitted to the upper part of the cylinder, and presses it down, and thus raises the tool at the other end of the beam to that part in connection with the cylinder. The counterpoise to the weight of the tools is also placed upon the cylinder-end of the beam.

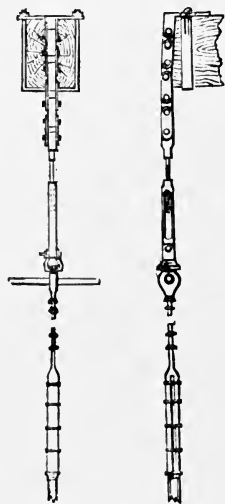

FIG. 35.—COUPLING OF ROD TO ENGINE.

The cylinder receives the steam through ports that are opened and closed by hand, like those of a steam-hammer ; so that the number and length of the strokes of the piston may be increased or diminished as occasion requires.

The balance-beam is continued beyond the point where the piston is connected with it, and goes to meet the blocks placed to check the force of the blow given by the descent of the tool. The guides of the piston-head are attached to the part of the machinery that acts in this manner ; but at Passy, Kind made the balance-beam work upon two plummer-blocks having no permanent cover, that they might be more easily moved whenever it was necessary

to displace the beam, for the purpose of taking up or letting down the rods, or for changing the tools. The balance-beam was always immediately over the centre of the tools, and had to be displaced every time the latter required to be changed. This was effected by allowing the beam to slide horizontally, so as to leave the mouth of the pit open. The counter-check, above mentioned, likewise prevented the piston from striking the cylinder-cover with too great force, when it was brought back by the weight of the tools to its original position. The operation of raising and lowering the rods, or of changing the tools, was performed at Passy by a separate steam-engine, and the shell was discharged into a special truck, moving upon a railway expressly laid for this purpose in the great tower erected over the excavation.

The cutting or comminution of the rock was usually effected at Passy at the rate of 15 to 20 strokes a minute. The rate of descent, of course, differed according to the nature of the rock operated upon ; but, generally speaking the trepan was worked for the space of about 8 hours at a time, after which it was withdrawn, and the shell was let down in order to remove the debris. The average number of men employed in the gang, besides the foreman or superintendent, was about 14 : they comprised a smith and a hammerman, to keep the tools in order ; and two shifts of men entrusted with the excavation, namely, an engine-driver and a stoker, a chief workman or sub-foreman, and 3 assistants. The total time employed in sinking shafts upon this system in the north of France, where it was applied without meeting with the accidents encountered in the historical Passy well, could be divided in the following manner : 25 to 56 % in manœuvring the trepan, 11 to 14½ % in raising and lowering tools, 19 to 21 % in removing material

detached from the rock and cleaning out the bottom of the excavation, and 8 to 10½ % in stoppage of engines, broken tools, etc. In the Passy well the long delays caused by the slips which took place in the clays, both in the basement beds of the Paris basin and in the sub-Cretaceous strata,

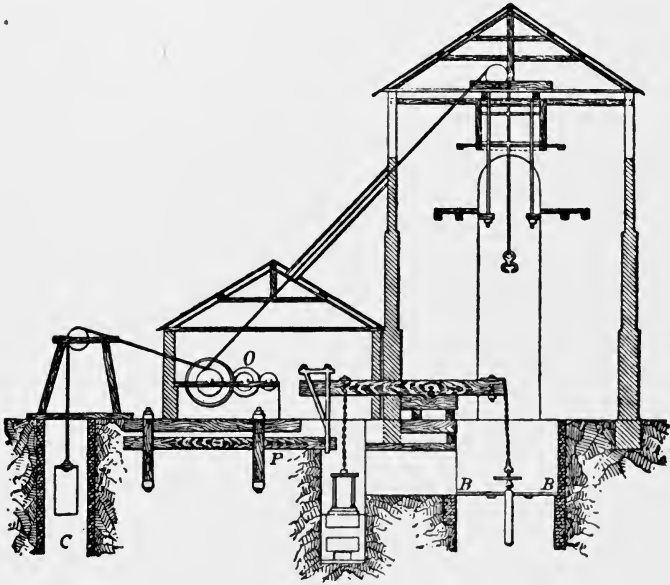

FIG. 36.—KIND-CHAUDRON PLANT.

would render any comparison derived from it of little value.

Later, Chaudron made some modifications in Kind's practice, and the system became known by the dual name.

The arrangement of the surface plant is shown in Figs. 36 to 38. The small capstan engine O has a cylinder 20 in. diam. and a stroke of 32 in., working on the third motion. Attached to this engine, and working in the small pit C, is

a counterbalance weight. The engine is used for raising and lowering boring-tools, and for lifting the debris resulting from the boring. As far as the platform, which is about 10 ft. from the surface, the pit is 19 ft. diam. or 4 ft. wider than below. At a level of about 38 ft. above this platform is a tramway on which run small trucks, carrying the "shell"

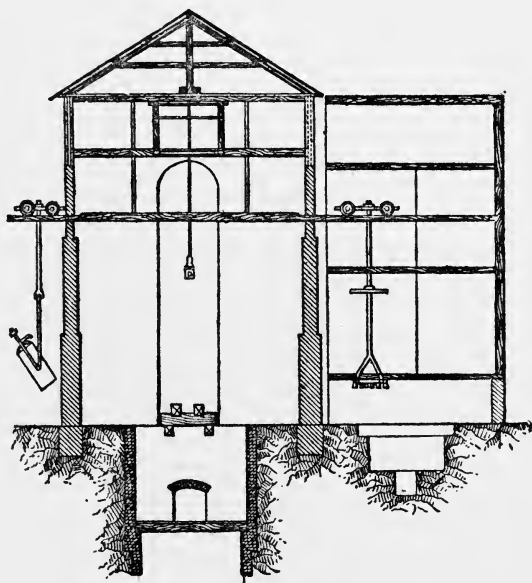

FIG. 37.—KIND-CHAUDRON PLANT.

on one side and the boring-tools on the other. At a level of 48 ft. above the platform are placed supports for the wooden spears to which the boring-tools are attached. The machinery for boring is worked by a cylinder, which has a diameter of $39\frac{1}{2}$ in. and a full stroke of $39\frac{1}{2}$ in., the usual stroke varying from 2 to 3 ft. A massive beam of wood transmits motion from this cylinder to the boring apparatus, the connection between the beam and the piston-rod and

the beam and the boring-tools being made by a chain. The engine-man sits close to the engine, and applies the steam above the piston only. The down stroke of the boring-tools is caused by the sudden opening of the exhaust, and a frame then prevents the shock of the boring-rods from

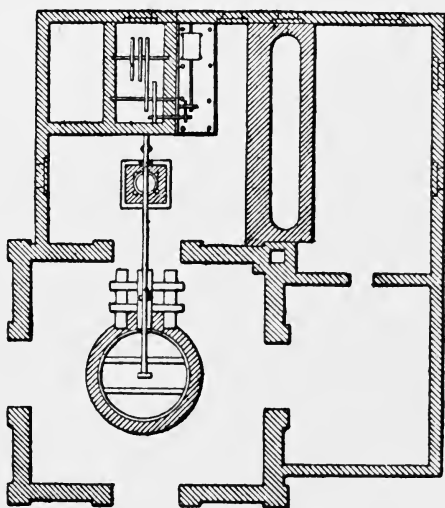

FIG. 38.—KIND-CHAUDRON PLANT.

being too severe. The engines work at speeds varying from 12 to 18 strokes a minute, according to the character of the strata passed through.

After the working platform is fixed, the first boring-tool applied is the small trepan, Fig. 39. This tool is attached to the wooden beam by the arrangement already shown in Fig. 35. The boring-tools can be lowered at pleasure by means of an adjusting screw. The handle for boring is worked by 4 men on the platform, and is turned by the aid of a swivel. Attached to the handle-piece are rods made

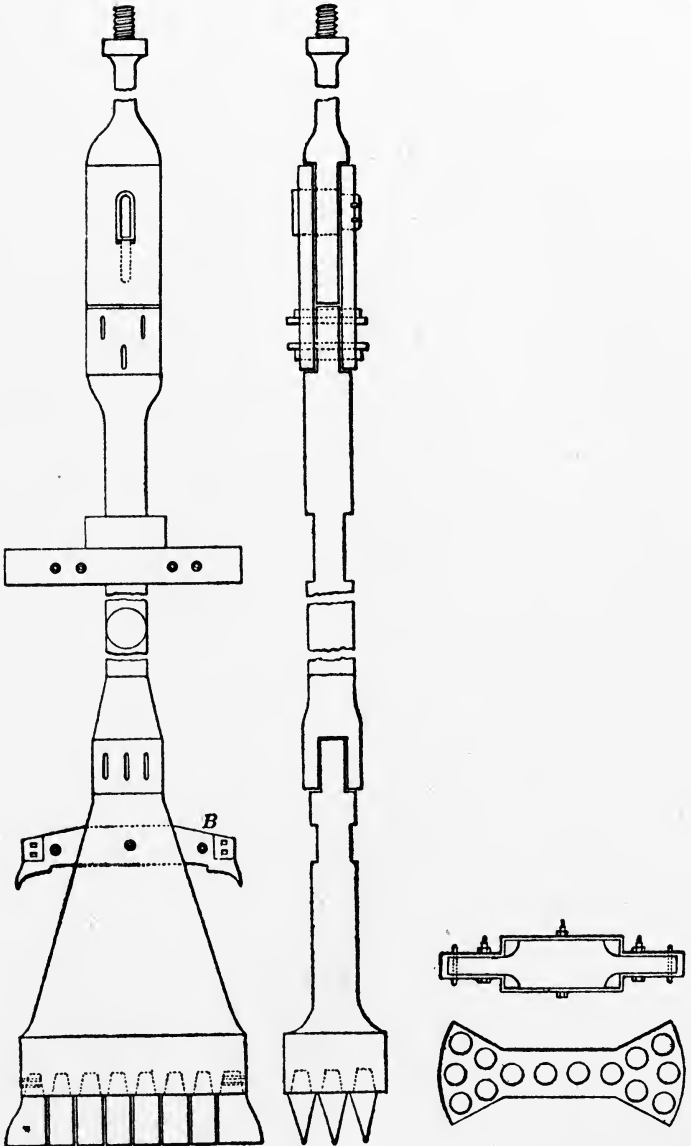

FIG. 39.—SMALL TREPAN.

from Riga pitch-pine, 59 ft. long and $7\frac{3}{4}$ in. square. A swivel-ring, Fig. 40, is attached to the rope when raising and lowering the boring-rods. The small trepan cuts a hole 4 ft. $8\frac{3}{4}$ in. diam., and has 14 teeth fitted in cylindrical holes

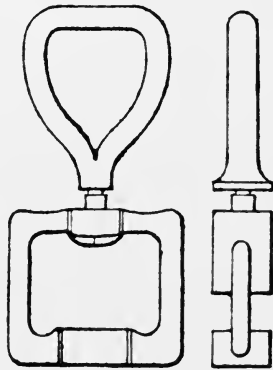

FIG. 40.—SWIVEL-RING.

and secured by pins entering through circular slots. The teeth are steeled. At a distance of 4 ft. 4 in. above the main teeth of the trepan is an arm B, with a tooth at each end. This piece answers the purpose of a guide, and at the same time removes irregularities from the sides of the hole. At a distance of 13 ft. 6 in. above the main teeth are the actual guides, consisting of two strong arms of iron fixed on the tool, and placed at right angles to each other. The hole made by the small trepan is not kept at any fixed distance in advance of the full-sized pit, but the distance generally varies from 30 to 100 ft. With the small trepan, which weighs 8 tons, progress varies from 6 to 10 ft. a day.

The large trepan, Fig. 41, weighs $16\frac{1}{2}$ tons, is forged in one solid piece, and has 28 teeth. An iron projection forms the centre of this trepan, and fits loosely into the hole made by the small trepan, acting as a guide for the tool. At a

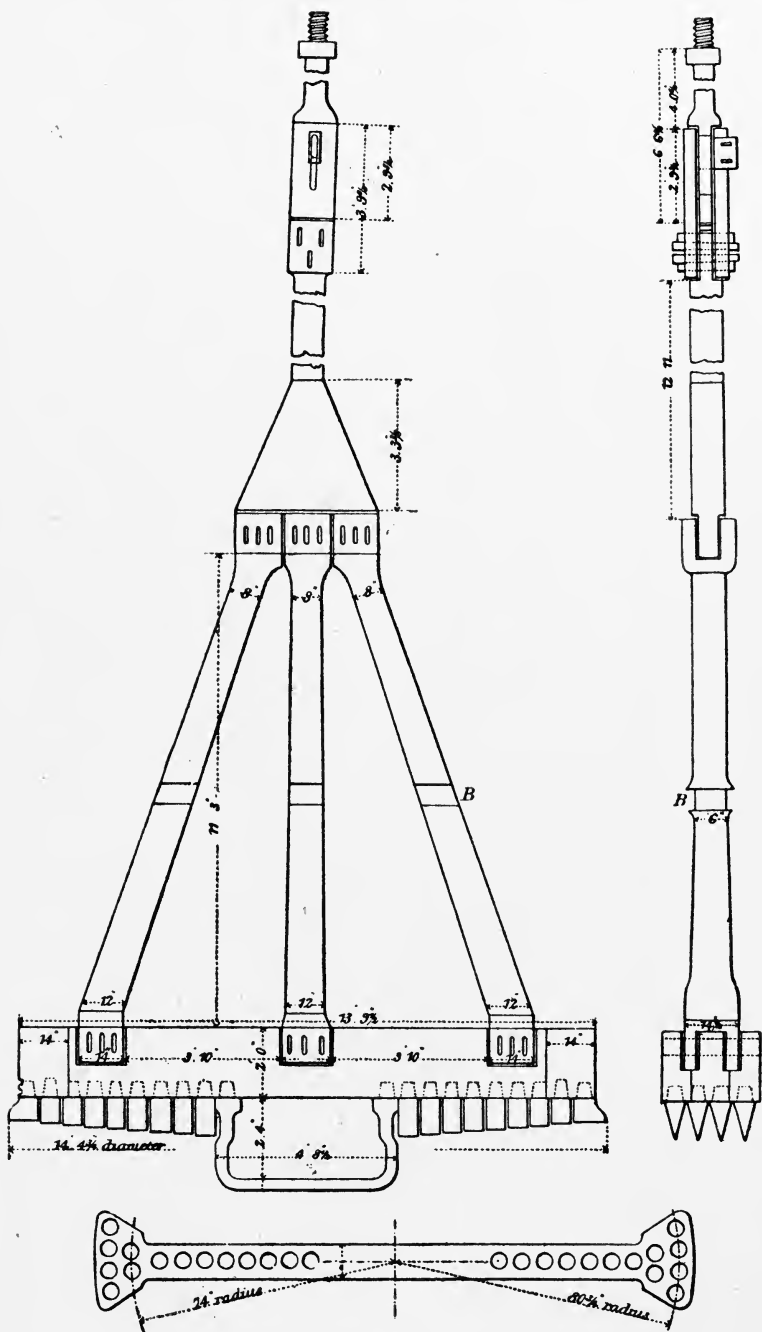

FIG. 41.—LARGE TREPAN.

distance of 7 ft. 6 in. above the teeth, a guide is sometimes fixed on the frame, but is not furnished with teeth. At a distance of 13 ft. 3 in. from the teeth are two other guides at right angles to each other. These guides are let down the pit with the boring-tool, the hinged part of the guides being raised whilst passing through the beams at the top of the pit, which are only 6 ft. 7 in. apart. When the tool is ready to work, the two arms are let down against the side of the pit, and are hung in the shaft by ropes, thus

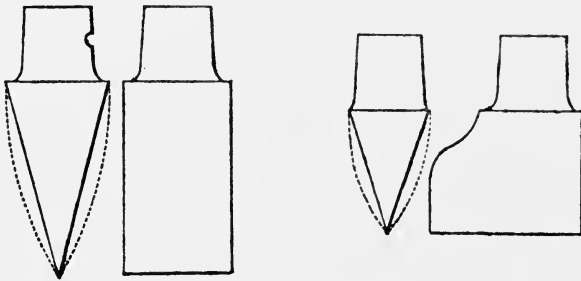

FIG. 42.—TREPAN TEETH.

acting as a guide for the trepan, which moves through them. To provide against a shock to the spears when the trepan strikes the rock on the down-stroke, at the upper part of the frame a slot motion is arranged, the play of which amounts to about $\frac{1}{2}$ in. The teeth of the large trepan are not horizontal, but are deeper towards the inside of the pit, the face of the inside tooth being $3\frac{3}{4}$ in. lower than the outside. The object of this is to cause the debris to drop at once into the small hole, by the face of the rock at the bottom of the pit being somewhat inclined. The teeth used, Fig. 42, are the same both for large and small trepan, and weigh about 72 lb. each. As a rule, only one set of teeth is kept in use, this working for 12 hours, the alternate

12 hours being employed in raising the debris. This time is divided in about the following proportions:—Boring, 12 hours; drawing rods, 1 to 5 hours, according to depth; raising debris, 2 hours; lowering rods, 1 to 5 hours. The maximum speed of the larger trepan may be taken at about 3 ft. a day. The ordinary distance sunk is not more than 2 ft. a day, and in flint and other hard rocks the boring has proceeded as slowly as 3 in. a day.

The debris in the small bore-hole contains pieces of a maximum size of about 8 cub. in. In the large boring, pieces of rock measuring 32 cub. in. have been found. As a rule, however, the material is beaten very fine, having much the appearance of mud or sand. In both the large and the small borings the debris is raised by a shell, similar to Fig. 33, and consisting of a wrought-iron cylinder 39 in. diam. by 6 ft. 9 in. long, containing two flap-valves at the bottom, through which the excavated material enters. This apparatus is passed down the shaft by the bore-rods, and is moved up and down through a distance varying from 6 to 8 in. for about $\frac{1}{4}$ hour; it is then drawn up and emptied.

In some cases where the rock is hard, three sizes of trepan are used consecutively, the sizes being 5 ft., 8 ft. and 13 ft.

Perpendicularity is ensured by the natural effect of the treble guide, which the chisels and the two sets of arms attached to the boring tools afford, and by the fact that if the least divergence is made from a vertical line the friction upon one side of the shaft is so great that the borers are unable to turn the instrument.

In tubbing, it is essential to secure a water-tight joint at the base; hence the bed on which the moss-box has to rest should be quite level and smooth. This is attained by the use of a "scraper" attached to the bore-rods.

The tubing is cast in complete cylinders. At Maurage each ring has an internal diameter of 12 ft. and is 4 ft. 9 in. high. Each ring has an inside flange at top and bottom, and a rib in the middle, the top and bottom of the ring being turned and faced. The rings of tubing are attached to each other by 28 bolts 1·1 in. diam., passed through holes bored in the flanges. The tubing is suspended in the pit by means of 6 rods, let down by capstans placed 30 ft. above the top of the pit and working upon long screws. When a new ring of tubing is added, the rods are detached at a lower level, and are hung upon chains, thus leaving an open space for passing it forward. Before each ring is put into the pit, it is tested to 50% more pressure than it is expected to be subjected to. The joints between the rings of tubing are made with sheet lead $\frac{1}{8}$ in. thick coated with red-lead. The lead is allowed to obtrude from the joint $\frac{1}{3}$ in., and is wedged up by a tool which has a face $\frac{1}{2}$ in. thick.

The mode of suspending the tubing from the rods will be understood by reference to Fig. 43. The rods are attached to a ring by the bolts connecting one ring of tubing with another. The bottom ring of tubing and the ring carrying the moss-box have their top flange turned inwards, but their bottom flange outwards. A strong iron web, forming the base of a tube $16\frac{1}{2}$ in. diam., is attached to the tubing. The object of this tube is to cause the water in the shaft to ease the suspension rods, by bearing part of the weight of the tubing. Cocks to admit water are placed at intervals up the tube, by which means the weight upon the rods can be easily regulated, so that not more than 5 to 10% of the weight of the tubing is suspended by the rods at one time. The ring holding the moss-box is hung from the bottom joint in the tubing by sliding rods.

The arrangement of the moss-box which forms the base of the tubing is one of the most important points in this system of sinking. Ordinary peat moss is enclosed in a net, which, with the aid of springs, keeps it in place during the descent of the tubing. When the moss box, which

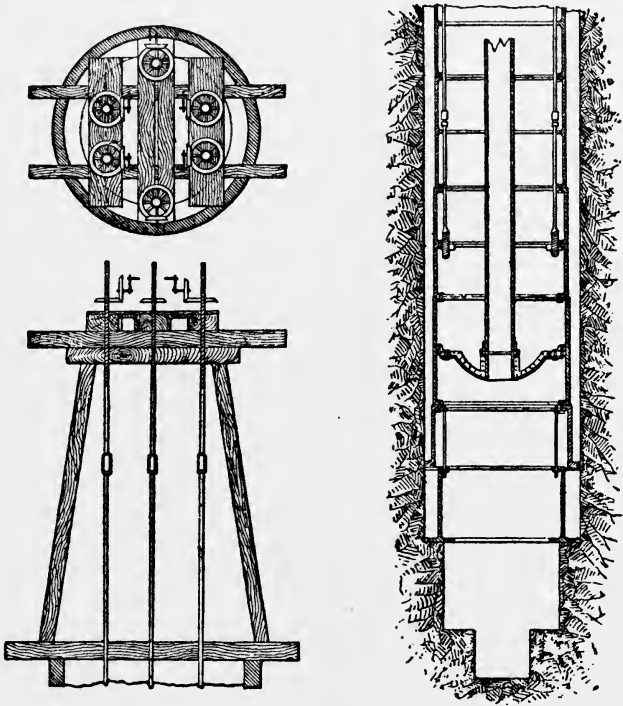

FIG. 43.—TUBBING SUSPENDED FROM RODS.

hangs on short rods fixed to the tubbing, reaches the face of rock, it is dropped gently upon it, and the whole weight of the tubing is allowed to rest upon the bed: this compresses the moss, the capacity of the chamber holding it is

diminished, and the moss is forced against the sides of the hole, forming a water-tight joint.

Up to this point, the following important differences between this and the ordinary system of tubing are to be observed. The tubing, on reaching its bed, bears the aggregate pressure of all the feeders of water which have been met with ; no wedging or other mode of consolidating it in the shaft is used ; and connection between the rings is so carefully made that the wedging of joints is rendered unnecessary.

Finally, the annular space between the tubing and the sides of the bore is filled with hydraulic cement, to render the tubing impermeable.

CHAPTER VI.

DRU DEEP-BORING SYSTEM.

THE system applied by Dru is worthy of attention, not so much on account of its novelty or of any new principle involved, as on account of the contrivances it contains for the application of the free-falling tool to wells of large diameter. It has been already explained that under Kind's arrangements the trepan was thrown out of gear by the reaction of the water which was allowed to find its way into the column of the excavation, but that it is not always possible to command the necessary supply, and that, even when possible, the clutch Kind adopted was so shaped as to be subject to much and rapid wear.

Dru, with a view to obviate both these inconveniences, made his first trepan so that the tool was gradually raised until it came in contact with the fixed part of the upper machinery, when it was thrown out of gear. The bearings of the clutch were parallel to the horizontal line, and were found in practice to be more evenly worn, so that this instrument could be worked sometimes for 8 to 14 days without intermission, whereas, in Kind's system, the trepan was frequently withdrawn after 2 or 3 days' service.

It will be seen from Figs. 44, 45, that the boring-rod A is suspended from the outer end of the working beam B, which is made of timber hooped with iron, working upon a middle bearing, and is connected at the inner end to the vertical steam-cylinder C, 10 in. diam. and 39 in. stroke.

The stroke of the boring-rod is reduced to 22 in., by the inner end of the beam being made longer than the outer

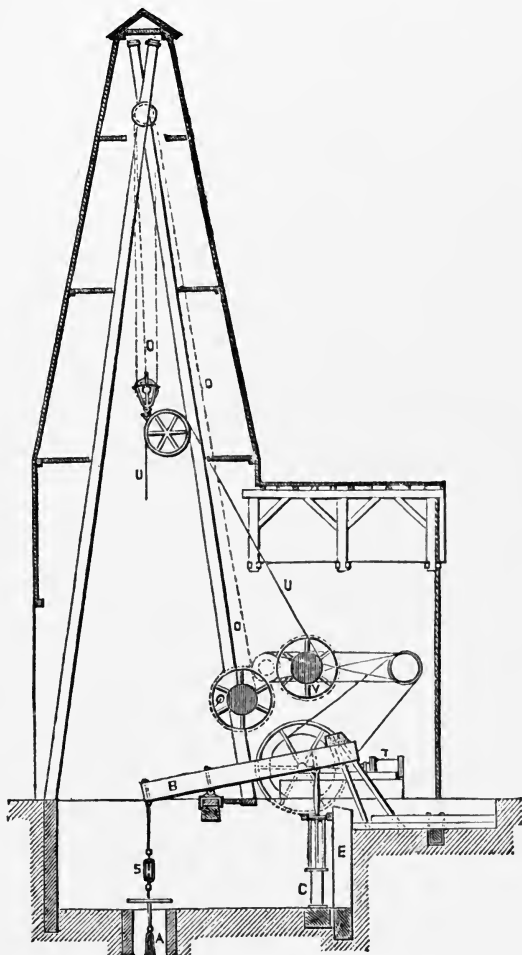

FIG. 44.—DRU BORING PLANT.

end, serving as a partial counterbalance for the weight of the boring-rod. The steam cylinder is single-acting, being

used only to lift the boring-rod at each stroke, and the rod is lowered again by releasing the steam from the top side of the piston; the stroke is limited by timber stops both below and above the end of the working beam B.

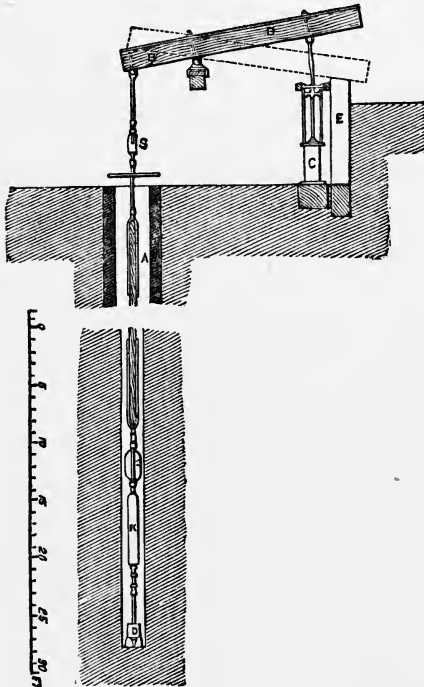

FIG. 45.—DRU BORING PLANT.

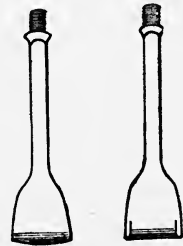

FIG. 46.—DRU CHISEL.

The boring-tool is the most important part of the apparatus, and has involved most difficulty in construction. The points to be aimed at in this are,—simplicity of construction and repairs; greatest force of blow possible for each unit of striking surface; and freedom from liability to get turned aside and choked.

The tool used in small borings is a single chisel, as shown in Fig. 46; but for the large borings it is found best

to divide the tool-face into separate chisels, each of convenient size and weight for forging. All the chisels, however, are kept in a straight line, whereby the extent of striking surface is reduced, and the tool is rendered less liable to be turned aside by meeting a hard portion of flint on a single point of the striking edge, which would diminish the effect of the blow.

The trepan, Fig. 47, is composed of a wrought-iron body D, connected by a screwed end E to the boring-rod, and

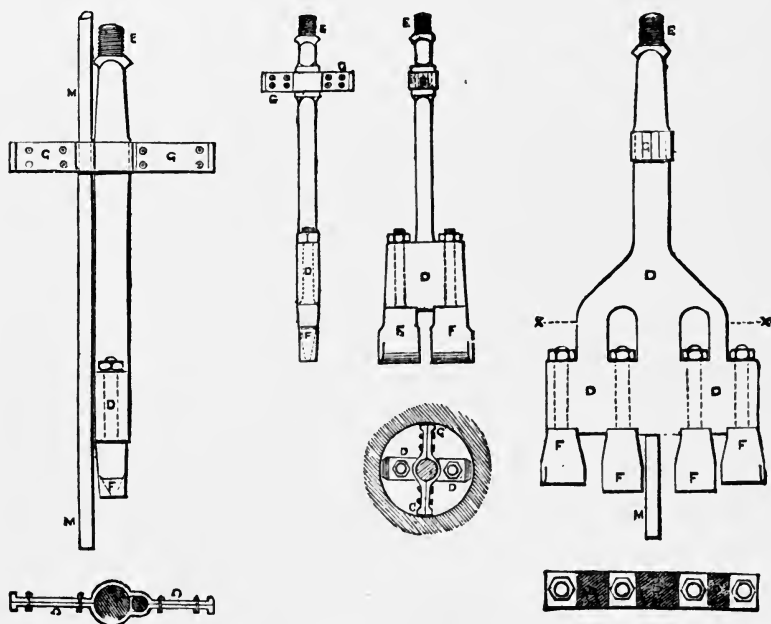

FIG. 47.—DRU TREPAN.

carrying the chisels F, fixed in separate sockets and secured by nuts above; 2 to 4 chisels are used, or sometimes even a greater number, according to the size of the hole to be bored. This construction allows of any broken chisel being

easily replaced ; also, by changing the breadth of the two outer chisels, the diameter of the hole bored can be regulated exactly. When 4 chisels are used, the 2 centre ones are made a little longer than the others, to form a leading hole as a guide to the boring-rod. A cross-bar G, of the same width as the tool, guides it in the hole in a direction at right-angles to the tool ; and in the case of the larger and longer tools, a second cross-bar higher up, at right-angles to the first and parallel to the striking edge of the tool, is also added.

If the whole length of the boring-rod were allowed to fall suddenly to the bottom of a large bore-hole at each stroke, frequent breakages would occur ; it is therefore found requisite to arrange for the tool to be detached from the boring-rod at a fixed point in each stroke, and this has led to the general adoption of free-falling tools. Dru's plan of self-acting free-falling tool, liberated by reaction, is shown in side and front view in Fig. 48. The hook H, attached to the head of the boring-tool D, slides vertically in the box K, which is screwed to the lower extremity of the boring-rod ; and the hook engages with the catch J, centred in the sides of the box K, whereby the tool is lifted as the boring-rod rises. The tail of the catch J bears against an inclined plane L, at the top of the box K ; and the two holes carrying the centre-pin I of the catch are made oval in vertical direction, so as to allow a slight vertical movement of the catch. When the boring-rod reaches the top of the stroke, it is stopped suddenly by the tail end of the beam B striking upon the wood buffer-block E (Fig. 44) ; the shock thus occasioned causes a slight jump of the catch J in the box K, the tail of the catch is thereby thrown outwards by the incline L, liberating the hook H, and the tool then falls freely to the bottom of the bore-hole. When the

boring-rod descends again after the tool, the catch J again engages with the hook H, enabling the tool to be raised for the next blow.

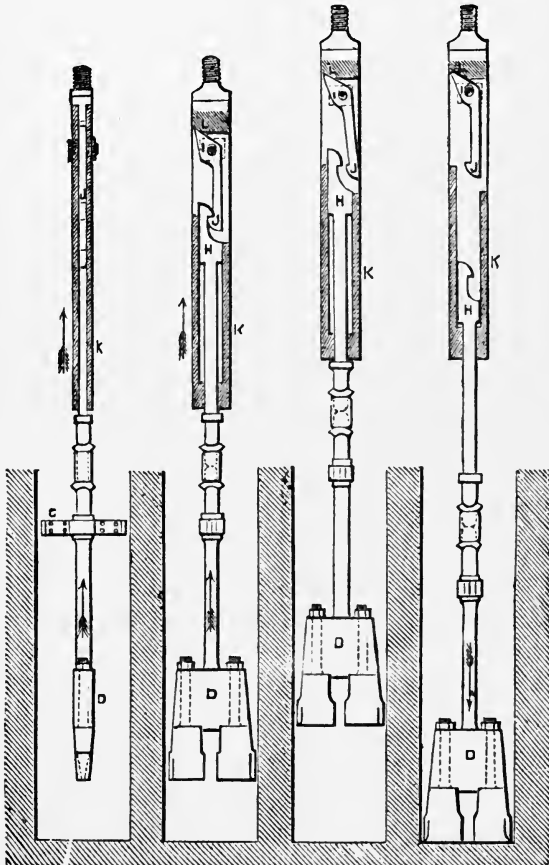

FIG. 48.—DRU FREE-FALLING DEVICE.

Another construction of the self-acting free-falling tool, liberated by a separate disengaging-rod, is shown in side and front view in Fig. 49. It consists of 4 principal pieces—

the hook H, the catch J, the pawl I, and the disengaging-rod M. The hook H, carrying the boring-tool D, slides

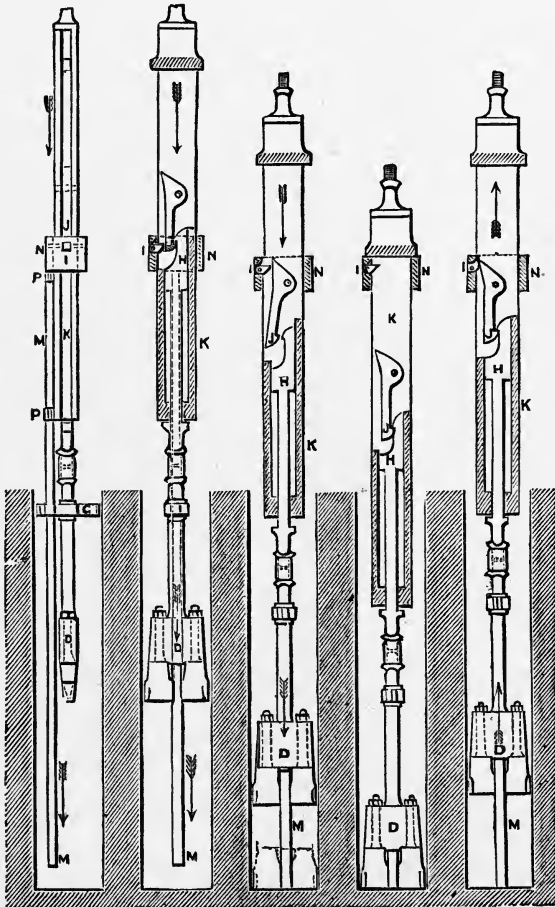

FIG. 49.—FREE-FALLING DEVICE.

between the vertical sides of the box K, screwed to the bottom of the boring-rod; and the catch J works in the same space upon a centre-pin fixed in the box, so that

the tool is carried by the rod, when hooked on the catch. At the same time, the pawl I, at the back of the catch J, secures it from getting unhooked from the tool ; but this pawl is centred in a separate sliding hoop N, forming the top of the disengaging-rod M, which slides freely up and down within a fixed distance upon the box K ; and in its lowest position the hoop N rests upon the upper of the two guides P, through which the disengaging-rod M slides outside the box K. In lowering the boring-rod, the disengaging-rod M reaches the bottom of the bore-hole first, and being then stopped, it prevents the pawl I from descending any lower ; and the inclined back of the catch J sliding down past the pawl, the latter forces the catch out of the hook H, thus allowing the tool D to fall freely and strike its blow. The height of fall of the tool is always the same, being determined only by the length of the disengaging-rod M.

The blow having been struck, and the boring-rod continuing to be lowered to the bottom of the hole, the catch J falls back into its original position, and engages again with the hook H, ready for lifting the tool in the next stroke. As the boring-rod rises, the tail of the catch J trips up the pawl I in passing, allowing the catch to pass freely ; and the pawl, before it begins to be lifted, returns to the original position, where it locks the catch J, and prevents any risk of its becoming unhooked either in raising or lowering the tool in the well.

The tool employed for boring a well 19 in. diam. weighs $\frac{3}{4}$ ton, and is liberated by the reaction arrangement shown in Fig. 48. The same mode of liberation was applied in the first instance to the larger tool employed in sinking a well 47 in. diam. : the great weight of the latter tool, however, amounting to as much as $3\frac{1}{2}$ tons, necessitated so

violent a shock for the purpose of liberating the tool by reaction, that the boring-rods and the rest of the apparatus would have been damaged, and the arrangement shown in Fig. 49 was substituted. In this case, the cross-guide G fixed upon the tool is made with an eye for the disengaging-rod M to work through freely. For borings of small diameter, however, the disengaging-rod cannot supersede the reaction system of liberation, as the latter alone is able to work in borings as small as $3\frac{1}{4}$ in. diam. ; and a bore-hole no larger than this has been successfully completed with the reaction tool to a depth of 750 ft.

The boring-rods employed are of wrought iron and of wood. Wooden rods are used for borings of large diameter, as they possess the advantage of having a larger section for stiffness without increasing the weight ; also, when immersed in water, the greater portion of their weight is floated. The wood requires to be carefully selected, and from the thick part of the tree. In France, Lorraine or Vosges deals are preferred.

The boring-rods, whether of wood or iron, are screwed together either by solid sockets or with separate collars. The latter are preferred, being easy to forge ; also because, as only one half of the collar works in coupling and uncoupling the rods, while the other half is fixed, the screw thread becomes worn only at one end, and, by changing the collar end for end, a new thread is obtained when one is worn out, the worn end being then jammed fast as the fixed end of the collar.

In raising or letting down the boring-rod, two sections of about 30 ft. each are detached or added at once, and a few shorter rods of different lengths are used to make up the exact requirement. The coupling-screw (S, Fig. 44), by which the boring-rod is connected to the working

beam B, serves to complete the adjustment of length ; this is turned by a cross-bar, and then secured by a cross-pin through the screw.

In ordinary work, breakages of the boring-rod generally take place in the iron, and more particularly at the part screwed, that being the weakest. In case of breakages, the tools usually employed for picking up the broken ends are a conical screwed socket (Fig. 50) and a crow's-foot (Fig. 51) ; the socket is made with an ordinary V-thread for cases where the breakage occurs in iron, but with a sharper thread like a wood screw when the breakage is in wood rods. To



FIG. 50.



FIG. 51.



FIG. 52.

EMERGENCY TOOLS.

ascertain the shape of the fractured end left in the bore-hole, and its position relatively to the centre line of the hole, a similar conical socket is first lowered, having its under surface filled up level with wax, so as to take an impression of the broken end, and show what size of screwed socket should be employed for getting it up. Tools with nippers are sometimes used in large borings, as it is not advisable to subject the rods to a twist.

When the boring-tool has detached a sufficient quantity of material, the boring-rod and tool are drawn up by means of the rope O (Fig. 44) winding up the drum Q, which is

driven by straps and gearing from the steam-engine T. A shell is then lowered into the bore-hole by the wire-rope U, from the other drum V, and is afterwards drawn up again with the excavated material. A friction brake is applied to the drum Q, for regulating the rate of lowering the boring-rod. The shell shown in Fig. 52 consists of a riveted iron cylinder, with a handle at the top, which can either be screwed to the boring-rod or attached to the wire-rope ; and the bottom is closed by a large valve opening inwards. Two forms are used, either a pair of flap-valves, or a single-cone valve ; and the bottom ring of the cylinder, forming the seating of the valve, is forged solid, and steeled on the lower edge. In lowering this cylinder to the bottom of the bore-hole, the valve opens, and the loose material enters the cylinder, where it is retained by the closing of the valve, whilst the shell is drawn up again to the surface. In boring through chalk, as in the case of the deep wells in the Paris basin, the hole is first made of about half the final diameter for 60 to 90 ft., and is then enlarged to the full diameter by using a larger tool. This is done for convenience of working : if the whole area were acted upon at once, it would involve crushing all the flints in the chalk ; but, by putting a shell in the advanced hole, the flints that are detached during the working of the second larger tool are received in the shell and removed by it, without getting broken by the tool.

The resistance experienced in boring through different strata is various ; and some rocks passed through are so hard that with 12,000 blows a day of a boring-tool weighing nearly 10 cwt., with 19 in. height of fall, the bore-hole was advanced only 3 to 4 in. a day. As an opposite case, strata of running sand have been met with so wet that a slight movement of the rod at the bottom of the hole was sufficient

to make the sand rise 30 to 40 ft. in the bore-hole. In these cases, Dru adopted the Chinese method of effecting a speedy clearance, by means of a shell closed by a large ball-clack at the bottom (Fig. 52), suspended by a rope, to which a vertical movement is given; each time the shell falls upon the sand, a portion of this is forced up into the cylinder, and retained there by the ball-valve.

Dru states that the reaction tool has been successfully employed for borings up to about 4 ft. diam., witness the case of the well at Butte-aux-Cailles of 47 in. diam.; but beyond that size he considers the shock requisite to liberate the larger and heavier tool would probably be so excessive as to injure the boring-rods and the rest of the attachments, and he designed the arrangement of the disengaging-rod for liberating the tool in borings of large diameter, whereby all shock upon the boring-rods is avoided, and the tool is liberated with complete certainty.

In practice it is necessary, as with the common chisel, to turn the boring-tool partly round after each stroke, so as to prevent it from falling every time into the same position at the bottom of the well; this was effected in the well at Butte-aux-Cailles by manual power at the top of the well, a long hand-lever fixed to the boring-rod by a clip bolted on being turned round by a couple of men through part of a revolution during the time that the tool was being lifted. The turning was ordinarily done in the right-hand direction only, so as to avoid the risk of unscrewing any of the screwed couplings of the boring-rods; and care was taken to give the boring-rod half a turn when the tool was at the bottom, so as to tighten the screw-couplings, which otherwise might shake loose. In the event of a fracture, however, leaving a considerable length of boring-rod in the hole, it was sometimes necessary to have the means of unscrew-

ing the couplings of the portion left in the hole, so as to raise it in parts instead of all at once. In that case, a locking-clip was added at each screwed joint above, and secured by bolts, at the time of putting the rods together for lowering them down the well to recover the broken portion ; and by this means the ends of the rods were prevented from becoming unscrewed in the coupling-sockets, when the rods were turned round backwards for unscrewing the joints in the broken length at the bottom of the bore-hole.

When running sands are met with, the plan adopted is to use the Chinese ball-scoop or shell, Fig. 52 ; where there is too much sand for it to be got rid of in this way, a tube has to be sent down from the surface to shut off the sand. This, of course, necessitates diminishing the diameter of the hole in passing through the sand ; but on reaching the solid rock below the running sand, an expanding tool is used for continuing the bore-hole below the tubing with the same diameter as above it, so as to allow the tubing to go down with the hole.

In case of meeting with a surface of very hard rock at a considerable inclination to the bore-hole, Dru employs a tool with cutters fixed in a circle all round the edge, instead of in a single diameter line ; the length of the tool is also considerably increased, so that it is guided for a length of 20 ft. He uses this tool in all cases where from any cause the hole is found to be going crooked, and has even succeeded thereby in straightening a hole that had previously been bored crooked. The cutting action of this tool is all round its edge ; therefore on meeting with an inclined hard surface, as there is nothing to cut on the lower side, the force of the blow is brought to bear on the upper side alone, until an entrance is effected into the hard rock in a true straight line with the upper part of the hole.

Although as regards diameter, depth, and flow of water in favourable localities, extraordinary results have been obtained with this system of boring by rods worked by steam power, yet, as Dru himself observes, in some instances, "owing to the difficulties attending the operation, the occurrence of delays from accidents is the rule, while the regular working of the machinery is the exception." A further disadvantage to be noticed is that, owing to the time and labour involved in raising and lowering heavy rods in borings of 10 in. diam. and upwards, there is a strong inducement to keep the boring tool at work for a much longer period than is actually necessary for breaking-up fresh material at each stroke. The fact is that after 100 to 200 blows have been given, the boring-tool merely falls into the accumulated debris and pounds this into dust, without touching the surface of the solid rock. It may therefore be easily understood how much time is totally lost out of the periods of 5 to 8 hours during which, with the rod system, the tool is allowed to continue working.

CHAPTER VII.

MATHER & PLATT DEEP-BORING SYSTEM.

IN Mather & Platt's method of boring adopted in England, rope has been reverted to in place of the iron or wooden rods used on the Continent. A flexible rope admits of being handled with greater facility than iron rods, but lacks the advantage of their rigidity; in the Chinese method (p. 41) it admitted of withdrawing the chisel or bucket very rapidly, but gave no certainty to the operation of the chisel at the bottom of the hole. Rods, on the other hand, enable a very effective blow to be given, with a definite turning or screwing motion between the blows, according to the requirements of the strata; but the time and trouble of raising heavy rods from great depths on each occasion of changing from boring to clearing out the hole form a serious drawback, which makes the stoppages occupy really a longer time than the actual working of the machinery.

The method introduced by Mather & Platt, of Oldham, has been largely employed for deep boring, and seems to combine many of the advantages of other systems without their disadvantages. Its distinctive features, as illustrated in Figs. 53 to 57, are the mode of giving the percussive action to the boring-tool, and the construction of the tool itself and of the shell-pump for clearing out the hole. Instead of these implements being attached to rods, they are suspended by a flat hemp rope, about $\frac{1}{2}$ in. thick and $4\frac{1}{2}$ in. broad, such as is commonly used at collieries; and

the boring-tool and shell-pump are raised and lowered as quickly in the bore-hole as the bucket and cages in a colliery shaft.

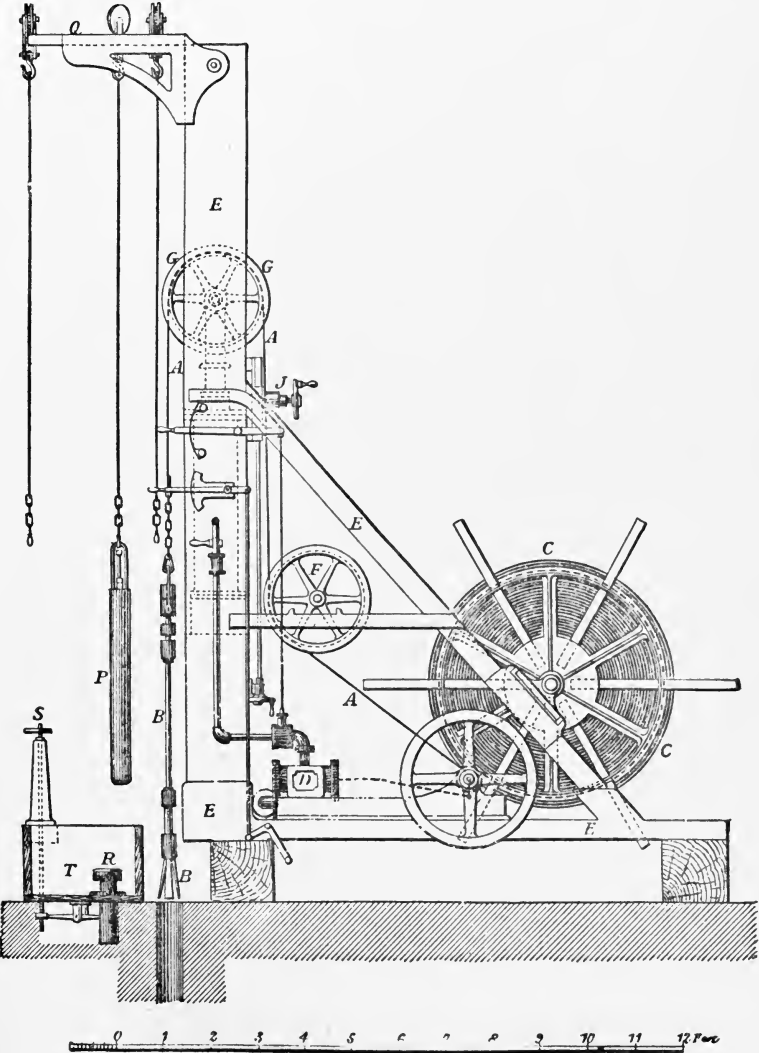

FIG. 53.—MATHER & PLATT BORING PLANT.

The flat rope A, Fig. 53, from which the boring-head B is suspended, is wound upon a large drum C driven by a

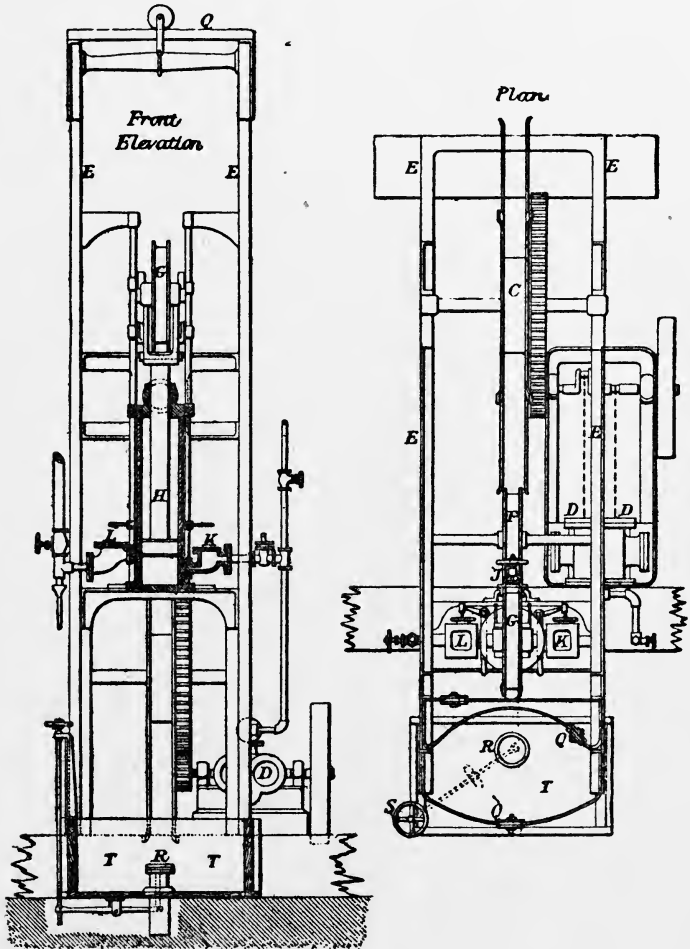

FIG. 54.—MATHER & PLATT SMALL BORING MACHINE.

steam-engine D with a reversing motion, so that one man can regulate the operation with the greatest ease. All the

working parts are fitted into a wooden or iron framing E, rendering the whole a compact and complete machine. On leaving the drum C, the rope passes under a guide-pulley F, and then over a large pulley G carried in a fork at the top of the piston-rod of a vertical single-acting steam-cylinder.

This cylinder, by which the percussive action of the boring-head is produced, is shown to a larger scale in the vertical sections, Figs. 55, 56; and in this larger machine the cylinder is fitted with a piston 15 in. diam. having a heavy cast-iron rod 7 in. square, which is made with a fork at the top, carrying the flanged pulley G of about 3 ft. diam. and sufficient breadth for the flat rope A to pass over it. The boring-head having been lowered by the winding-drum to the bottom of the bore-hole, the rope is fixed secure at that length by the clamp J; steam is then admitted underneath the piston in the cylinder H by the steam-valve K, and the boring-tool is lifted by the ascent of the piston-rod and pulley G; on arriving at the top of the stroke, the exhaust-valve L is opened for the steam to escape, allowing the piston-rod and carrying-pulley to fall freely with the boring-tool, which descends with its full weight to the bottom of the bore-hole. The exhaust-port is 6 in. above the bottom of the cylinder, while the steam-port is situated at the bottom; there is thus always an elastic cushion of steam of that thickness retained in the cylinder for the piston to fall upon, preventing the piston from striking the bottom of the cylinder. The steam- and exhaust-valves are worked with a self-acting motion by the tappets M, which are actuated by the movement of the piston-rod; and a rapid succession of blows is thus given by the boring-tool on the bottom of the bore-hole. As it is necessary that motion should be given to the piston before the valves can be acted upon, a small jet of steam N is allowed to be con-

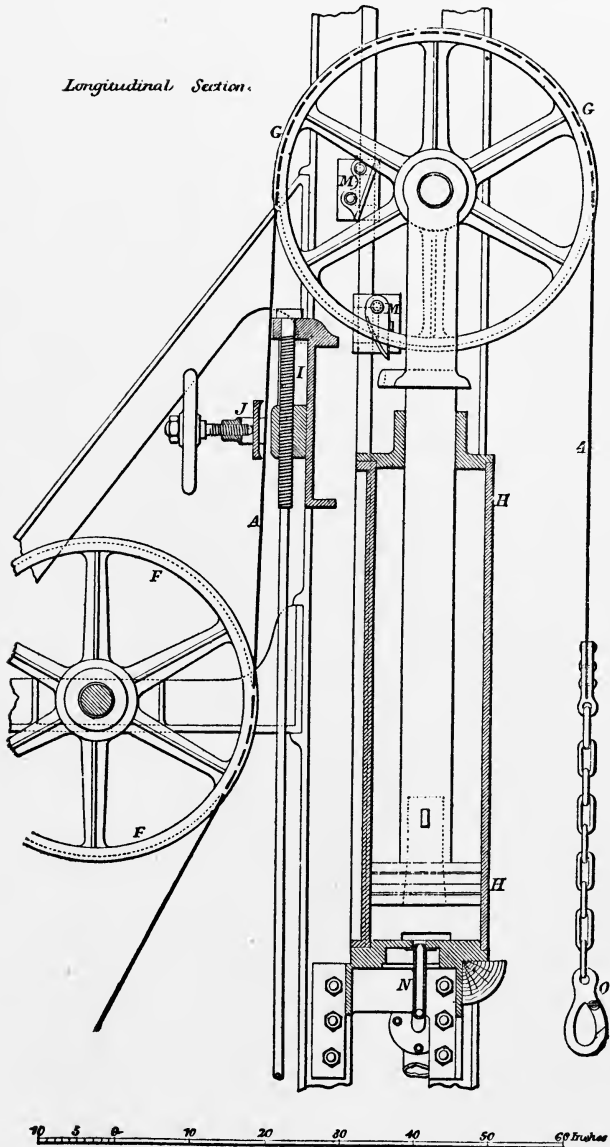

FIG. 55.—MATHER & PLATT LARGE BORING MACHINE.

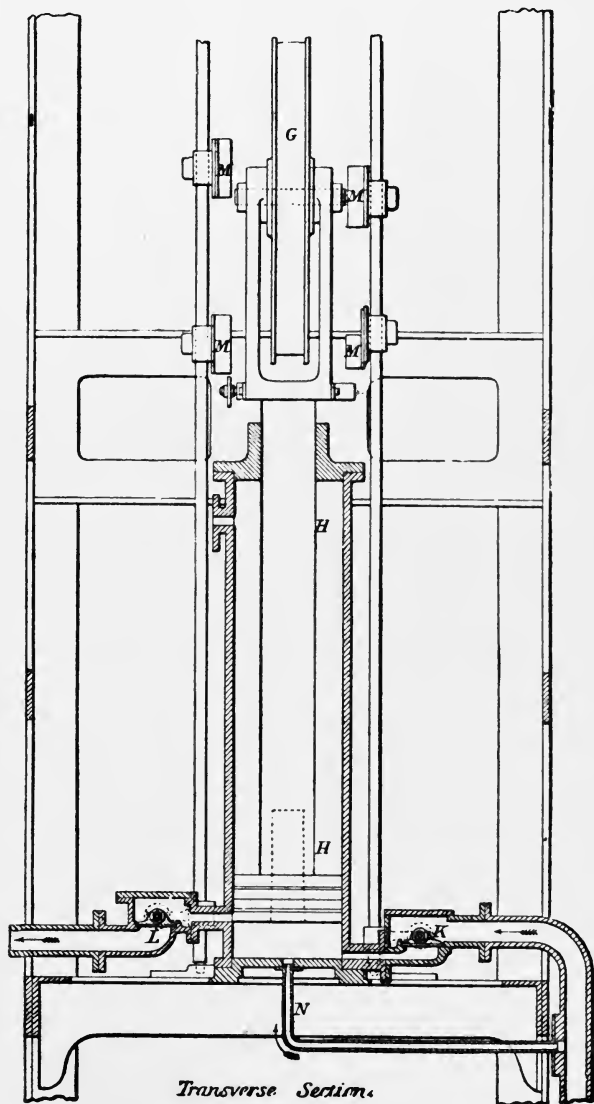

FIG. 56.—MATHER & PLATT LARGE BORING MACHINE.

stantly blowing into the bottom of the cylinder ; this causes the piston to move slowly at first, so as to take up the slack of the rope, and allow it to receive the weight of the boring-head gradually and without a jerk. An arm attached to the piston-rod then comes in contact with a tappet which opens the steam-valve K, and the piston rises quickly to the top of the stroke ; another tappet worked by the same arm then shuts off the steam, and the exhaust-valve L is opened by a corresponding arrangement on the opposite side of the piston-rod, as shown in Fig. 56. By shifting these tappets, the length of stroke of the piston can be varied from 1 ft. to 8 ft. in the large machine, according to the material to be bored through ; and the height of fall of the boring-head at the bottom of the bore-hole is double the length of stroke of the piston. The fall of the boring-head and piston can also be regulated by a weighted valve on the exhaust-pipe, checking the escape of steam, so as to cause the descent to take place slowly or quickly, as may be desired.

The boring head B, Fig. 53, is shown to a larger scale in Fig. 57. It consists of a wrought-iron bar about 4 in. diam. and 8 ft. long, to the bottom of which is secured a cast-iron cylindrical block C. This block has numerous square holes through it, into which are inserted the chisels or cutters D, with taper shanks, so as to be very firm when working, but to be readily taken out for repairing and sharpening. Two different arrangements of the cutters are shown in the elevation and the plan. A little above the block C, another cylindrical casting E is fixed upon the bar B, and acts simply as a guide to keep the bar perpendicular. Higher still is fixed a second guide F, but on the circumference of this are secured cast-iron plates made with ribs of a saw-tooth or ratchet shape, catching only in one

direction ; these ribs are placed at an inclination like segments of a screw-thread of very long pitch, so that, as the guide bears against the rough sides of the bore-hole when the bar is raised or lowered, they assist in turning it, and thus cause the cutters to strike in a fresh place at each stroke. Alternate plates have the projecting ribs inclined in opposite directions, so that one half of the ribs are acting to turn the bar round in rising, and the other half to turn it in the same direction in falling. These projecting spiral ribs simply assist in turning the bar, and immediately above the upper guide F is the arrangement by which the definite rotation is secured. To effect this object two cast-iron collars G H are cottered fast to the top of the bar B, and placed about 12 in. apart ; the upper face of the lower collar G is formed with deep ratchet-teeth of about 2 in. pitch, and the under face of the top collar H is formed with similar ratchet-teeth, set exactly in line with those on the lower collar. Between these collars, and sliding freely on the neck of the boring-bar B, is a deep bush J, which is also formed with corresponding ratchet-teeth on both its upper and lower faces ; but the teeth on the upper face are set half a tooth in advance of those on the lower face, so that the perpendicular side of each tooth on the upper face of the bush is directly above the centre of the inclined side of a tooth on the lower face. To this bush is attached the wrought-iron bow K, by which the whole boring-bar is suspended from a hook and shackle O, Fig. 55, at the end of the flat rope A.

The rotary motion of the bar is obtained as follows : When the boring-tool falls and strikes the blow, the lifting-bush J, which during the lifting has been engaged with the ratchet-teeth of the top collar H, falls upon those of the bottom collar G, and thereby receives a twist backwards

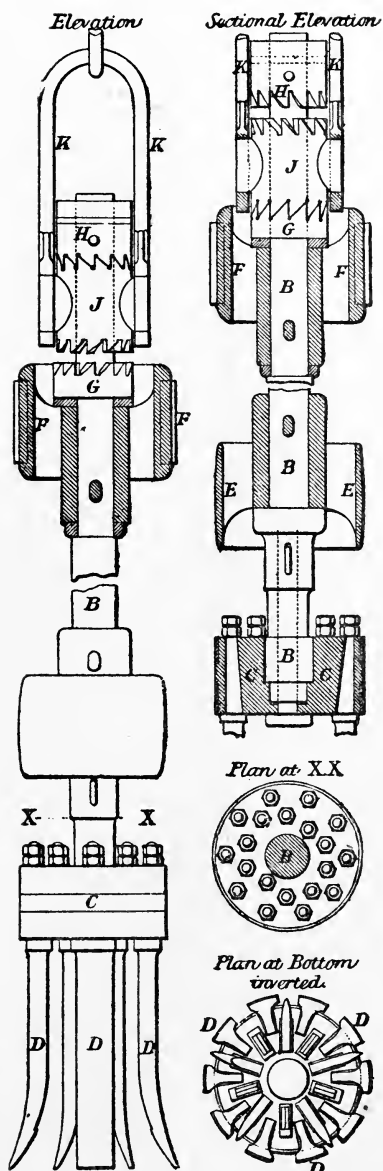

FIG. 57.—MATHER & PLATT BORING-HEAD.

through the space of half a tooth ; and on commencing to lift again, the bush rising up against the ratchet-teeth of the top collar H, receives a further twist backwards through half a tooth. The flat rope is thus twisted backwards to the extent of one tooth of the ratchet ; and during the lifting of the tool it untwists itself again, thereby rotating the boring tool forwards through that extent of twist at each successive blow of the tool. The amount of the rotation may be varied by making the ratchet-teeth of coarser or finer pitch. The motion is entirely self-acting, and the rotary movement of the boring-tool is ensured with mechanical accuracy. This simple and most effective action, taking place at every blow of the tool, produces a constant change in the position of the cutters, thus increasing their effect in breaking the rock.

The shell-pump, for raising the material broken by the boring-head, is shown in Fig. 58, and consists of a cylindrical cast-iron shell or barrel P, about 8 ft. long and a little smaller in diameter than the size of the bore-hole. At the bottom is a clack A opening upwards, somewhat similar to that in ordinary pumps, but its seating, instead of being fastened to the cylinder P, is in an annular frame C, which is held up against the bottom of the cylinder by a rod D passing up to a wrought-iron guide E at the top, where it is secured by a cotter F. Inside the cylinder works a bucket B, similar to that of a common lift-pump, having a rubber disc-valve on the top side ; and the rod D of the bottom clack passes freely through the bucket. The rod G of the bucket itself is formed like a long link in a chain, and by this link the pump is suspended from the shackle O at the end of the flat rope, the guide E, Fig. 58, preventing the bucket from being drawn out of the cylinder. The bottom clack A is made with a rubber disc, which opens

rock may be brought up as large as possible, the entire clack is free to rise bodily about 6 in. from the annular frame C, Fig. 58, thereby affording ample space for large pieces of rock to enter the cylinder, when drawn in by the up stroke of the bucket.

The general working of the boring-machine is as follows. The winding drum C, Fig. 53, is 10 ft. diam. in the large machine, and is capable of holding 3000 ft. of rope $4\frac{1}{2}$ in. broad and $1\frac{1}{2}$ in. thick. When the boring-head B is hooked on the shackle at the end of the rope A, its weight pulls round the drum and winding-engine, and, by means of a brake, it is lowered steadily to the bottom of the bore-hole; the rope is then secured at that length by screwing-up tight the clamp J. The small steam-jet N, Figs. 55, 56, is next turned on, for starting the working of the percussion-cylinder H; and the boring-head is then kept continually at work, until it has broken up a sufficient quantity of material at the bottom of the bore-hole. The clamp J which grips the rope is made with a slide and screw I, Fig. 55, whereby more rope can be gradually given out as the boring-head penetrates deeper. In order to increase the lift of the boring-head and to compensate for the elastic stretching of the rope, which is found to amount to 1 in. per 100 ft., it is simply necessary to raise the top pair of tappets on the tappet-rods whilst the percussive-motion is in operation. When the boring-head has been kept at work long enough, steam is shut off from the percussion-cylinder, the rope is unclamped, the winding-engine is put in motion, and the boring-head is wound up to the surface, where it is then slung from an overhead suspension-bar Q, Fig. 53, by means of a hook mounted on a roller for running the boring-head away to one side, clear of the bore-hole.

The shell-pump is next lowered into the bore-hole by

the rope, and the debris is pumped into it by lowering and raising the bucket about 3 times at the bottom of the hole ; this is readily effected by means of the reversing-motion of the winding-engine. The pump is then brought to the surface and emptied by the following very simple arrangement : it is slung by a traversing-hook from the overhead suspension-bar Q, Fig. 53, and is brought perpendicularly over a small table R in the waste-tank T, the table being raised by the screw S until it receives the weight of the pump. The cotter F, Fig. 58, which holds up the clack-seating C at the bottom of the pump, is then knocked out, and the table being lowered by the screw, the whole clack-seating C descends with it, and the contents of the pump are washed out by the rush of water contained in the pump-cylinder. The table is then raised again by the screw, replacing the clack-seating in its proper position, where it is secured by driving the cotter F into the slot at the top ; the pump is then ready to be lowered into the bore-hole as before. It is sometimes necessary for the pump to be emptied and lowered 3 or 4 times in order to remove all the material that has been broken up by the boring-head at one operation.

The rapidity with which these operations may be carried on is found by experience to be as follows. The boring-head is lowered at the rate of 500 ft. a minute. The percussive-motion gives 24 blows a minute ; this rate of working continued for about 10 minutes in red sandstone and similar strata is sufficient for enabling the cutters to penetrate about 6 in., when the boring-head is wound up again at the rate of 300 ft. a minute. The shell-pump is lowered and raised at the same speeds, but only remains down about 2 minutes ; and the emptying of the pump when drawn up occupies about 2 or 3 minutes.

In the construction of the machine it will be seen that the great desideratum of all earth boring has been well kept in view ; namely, to bore holes of large diameter to great depths with rapidity and safety. The main objects are to keep either the boring-head or the shell-pump constantly at work at the bottom of the bore-hole, where the actual work has to be done ; to lose as little time as possible in raising, lowering, and changing the tools ; to expedite all the operations at the surface ; and to economise manual labour in every particular. With this machine, one man standing on a platform at the side of the percussion-cylinder performs all the operations of raising and lowering by the winding-engine, changing the boring-head and shell-pump, regulating the percussive action, and clamping or unclamping the rope ; all the handles for the various steam-valves are close to his hand, and the brake for lowering is worked by his foot. Two labourers attend to changing the cutters and clearing the pump. Duplicate boring-heads and pumps are slung to the overhead suspension-bar Q, Fig. 53, ready for use, thus avoiding all delay when any change is requisite.

In all well-boring innumerable accidents and stoppages are certain to occur from causes which cannot be prevented, with however much vigilance and skill the operations may be conducted. Hard and soft strata intermingled, highly inclined rocks, running sands, fissures and dislocations are fruitful sources of annoyance and delay, and sometimes of complete failure ; and it will therefore be interesting to notice a few of the ordinary difficulties arising out of these conditions. The various special instruments used under such circumstances are shown in Figs. 59, 60.

The boring-head while at work may suddenly be jammed fast, either by breaking into a fissure, or in con-

Grapple for Tubes.

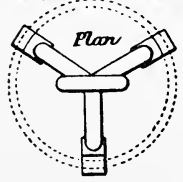

Breaking-up Bar.

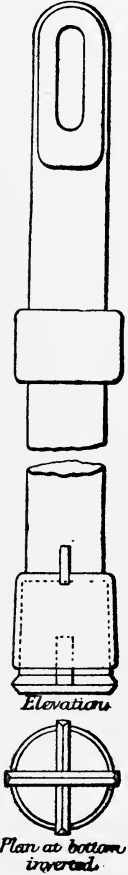

Claw Grapple

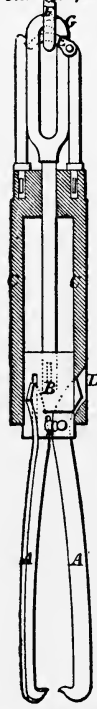

Cutting Grapple



Screw Grapple



Step Ladder

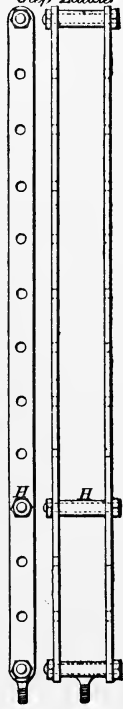

12 14 16 18 20 30 Inches

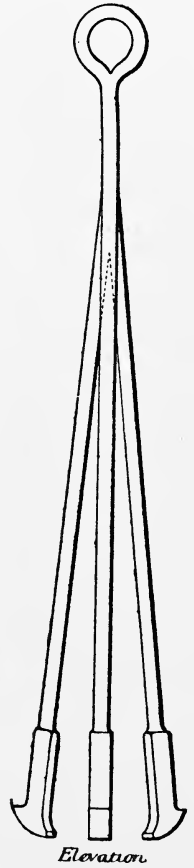

FIG. 59.—MATHER & PLATT EMERGENCY TOOL

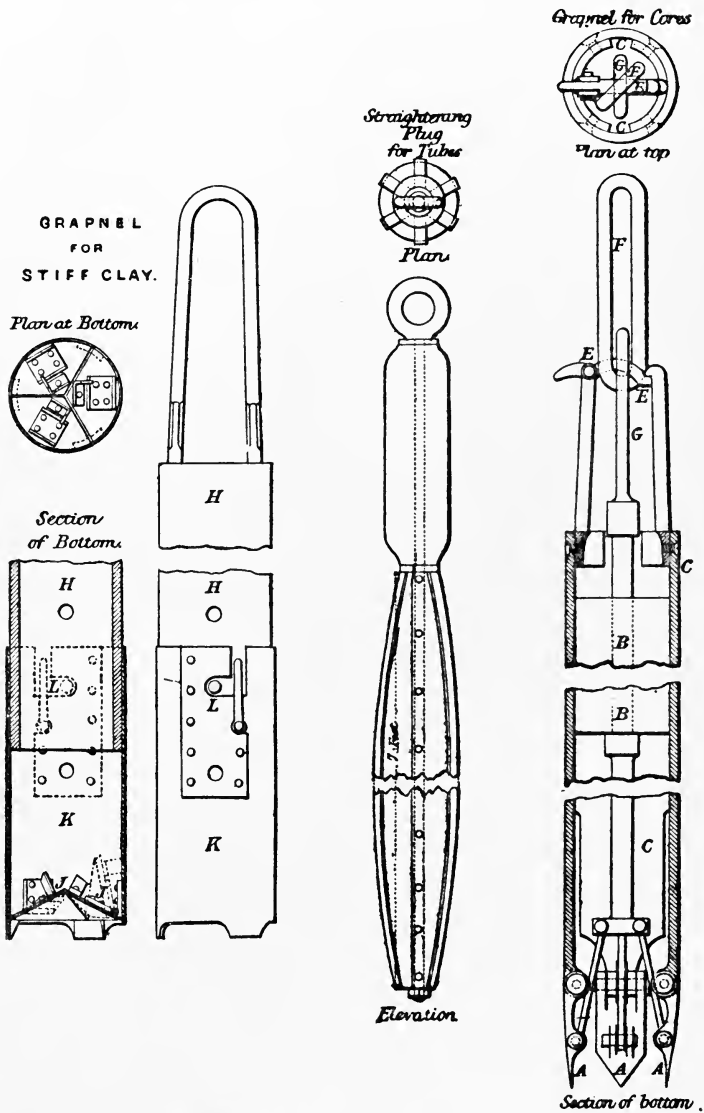

FIG. 60.—MATHER & PLATT EMERGENCY TOOLS.

sequence of broken rock falling upon it from loose strata above. All the strain possible is then put upon the rope, either by the percussion-cylinder or by the winding-engine : if the rope is old or rotten, it breaks, leaving perhaps a long length in the hole. The claw grapnel is then attached to the rope remaining on the winding-drum, and is lowered until it rests upon the slack broken rope in the bore-hole. The grapnel is made with three claws A centred in a cylindrical block B, which slides vertically within the casing C, the tail ends of the claws fitting into inclined slots D in the casing. During the lowering of the grapnel, the claws are kept open, in consequence of the trigger E being held up by the long link F, which suspends the grapnel from the top rope. But as soon as the grapnel rests upon the broken rope below, the suspending-link F continuing to descend allows the trigger E to fall out of it, and then, in hauling up again, the grapnel is lifted only by the bow G of the internal block B, and the entire weight of the external casing C bears upon the inclined tail ends of the claws A, causing them to close in tight upon the broken rope and lay hold of it securely. The claws are made either hooked at the extremity or serrated. The grapnel is then hauled up sufficiently to pull the broken rope tight, and wrought-iron rods 1 in. square, with hooks attached at the bottom, are let down to catch the bow of the boring-head, which is readily accomplished. Powerful screw-jacks are applied to the rods at the surface, by means of the step-ladder shown in Fig. 59, in which the cross-pin H is inserted at any pair of the holes, so as to suit the height of the screw-jacks.

If the boring-head does not yield quickly to these efforts, the attempt to recover it is abandoned, and it is got out of the way by being broken into pieces. For this purpose, the broken rope in the bore-hole has first to be

removed; it is therefore caught hold of with a sharp hook and pulled tight in the hole, while the cutting-grapnel is slipped over it and lowered by the rods to the bottom. This tool is made with a pair of sharp cutting jaws or knives I opening upwards, which, in lowering, pass down freely over the rope; but when the rods are pulled up with considerable force, the jaws nipping the rope between them cut it through, and it is thus removed altogether from the bore-hole.

The solid wrought-iron breaking-up bar, which weighs about a ton, is then lowered, and by means of the percussion-cylinder it is made to pound away at the boring-head until the latter is either driven out of the way into one side of the bore-hole, or broken up into such fragments as enable, partly by the shell-pump and partly by the grapnels, the whole obstacle to be removed. The boring is then proceeded with, as before the accident.

The same mishap may arise from the shell-pump getting jammed fast in the bore-hole, as illustrated in Fig. 61; the same means of removing

the obstacle are then adopted. Experience has shown the danger of putting any greater strain upon the rope than the percussion-cylinder can exert; it is therefore usual to lower the grapnel-rods at once, if the boring-head or pump gets fast, thus avoiding risk of breaking the rope.

The breaking of a cutter in the boring-head is not an uncommon occurrence. If, however, the bucket-grapnel K

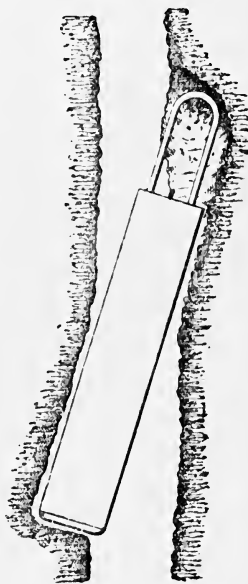

FIG. 61.—SHELL-PUMP FAST.

or the small screw-grapnel be employed for its recovery, the hole is usually cleared without any important delay. The screw-grapnel is applied by means of the iron grappling-rods, so that by turning the rods the screw works itself round the cutter or other article in the bore-hole, and securely holds it while the rods are drawn to the surface. The bucket-grapnel, Fig. 60, is also employed for raising clay, as well as for the purpose of bringing up cores out of the bore-hole, where these are not raised by the boring-head itself in the manner already described. The action of this grapnel is similar to that of the claw-grapnel, Fig. 59. Where clay or similar material is at the bottom of the bore-hole, the weight of the heavy block B in the grapnel causes the sharp edges of the pointed jaws to penetrate to some depth into the material, a quantity of which is thus enclosed within them and brought up.

Another grapnel also used where a bore-hole passes through a bed of very stiff clay is shown in Fig. 60, and consists of a long cast-iron cylinder H fitted with a sheet-iron mouthpiece K at the bottom, in which are hinged 3 conical steel jaws J opening upwards. The weight of the tool forces it down into the clay with the jaws open; on raising it, the jaws, having a tendency to fall, cut into the clay and enclose a quantity of it inside the mouthpiece, which, on being brought to the surface, is detached from the cylinder H and cleaned out. A second mouthpiece is put on, and sent down for working in the bore-hole while the first is being emptied, the attachment of the mouthpiece to the cylinder being made by a common bayonet-joint D so as to admit of ready connection and disconnection.

Running sand in soft clay is the most serious difficulty met with in well-boring. Under such circumstances, the bore-hole has to be tubed from top to bottom, which greatly

increases the expense of the undertaking, not only by the cost of the tubes, but also by the time and labour expended on inserting them. When a permanent water supply is the main object of the boring, the additional expense of tubing the bore-hole is not of much consequence : it is, in fact, of distinct advantage, and should in all cases be provided for, as the tubed hole is more durable, and the surface water is thereby excluded ; but in exploring for mineral, it is a serious matter, as the final result of the bore-hole is then by no means certain. The mode of inserting tubes has become a question of great importance in connection with this system of boring, and much time and thought having been spent in perfecting the method now adopted, its value has been proved by the repeated success with which it has been carried out.

The tubes used by Mather & Platt are of cast iron varying in thickness from $\frac{5}{8}$ to 1 in., according to their diameter, and 9 ft. in length. Successive lengths are connected by means of wrought-iron covering-hoops 9 in. long, made of the same outside diameter as the tube, so as to be flush with it. These hoops are $\frac{1}{4}$ to $\frac{3}{8}$ in. thick, and the ends of each tube are reduced in diameter by turning down for $4\frac{1}{2}$ in. from the end, to fit inside the hoops. A hoop is shrunk fast on one end of each tube, leaving $4\frac{1}{2}$ in. of socket projecting to receive the end of the next tube to be connected ; 4 or 6 rows of screws with countersunk heads, placed at equal distances round the hoop, are screwed through into the tubes to couple the two lengths securely together. Thus a flush joint is obtained both inside and outside. The lowest tube is provided at bottom with a steel shoe having a sharp edge for penetrating the ground more readily. The whole arrangement is, however, most cumbersome and unreliable, and compares very unfavourably with Isler's system described on a subsequent page.

In small borings 6 to 12 in. diam., the tubes are inserted by means of screw-jacks, as shown in Fig. 62. The boring-machine foundation *A*, which is of timber, is weighted at

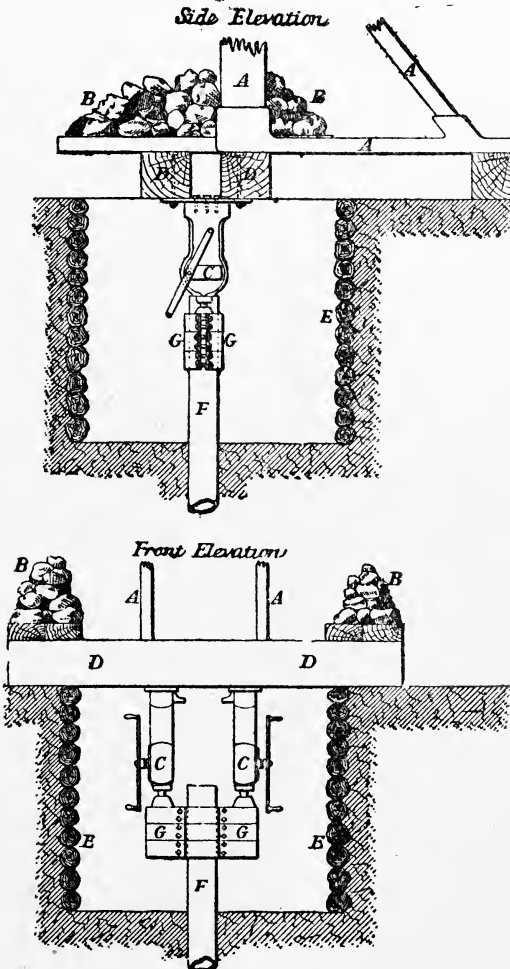

FIG. 62.—TUBE-FORCING BY SCREW-JACKS.

B by stones, pig-iron, or any available material, and 2 screw-jacks C, each of about 10 tons power, are secured with the screws downwards, underneath the beams D crossing the shallow well E excavated at the top of the bore-hole. A tube F having been lowered into the mouth of the bore-hole by the winding-engine, a pair of deep clamps G are screwed tightly round it, and the screw-jacks acting upon these clamps force the tube down into the ground. The boring is then resumed, and as it proceeds the jacks are occasionally worked, so as to force the tube if possible even ahead of the boring-tool. The clamps are slackened and shifted up the tubes, to suit the length of the screws of the jacks; 2 men work the jacks, and couple the lengths of tubes as they are successively added. The actual boring is carried on simultaneously within the tubes, and is not in the least impeded by their insertion.

A more powerful apparatus is adopted where tubes of 18 to 24 in. diam. have to be inserted to a great depth, an example of which is afforded by the boring at Horse Fort, Gosport. To supply the garrison with fresh water, a bore-hole is sunk into the chalk. A cast-iron well, consisting of cylinders 6 ft. diam. and 5 ft. long, has been sunk 90 ft., and from the bottom of this well is an 18-in. bore-hole lined with cast-iron tubes 1 in. thick, coupled as before described. The method of inserting these tubes is shown in Fig. 63: 2 wrought-iron columns C, 6 in. diam., are firmly secured in the position shown, by castings bolted to the flanges of the cylinders A forming the well, so that the columns are perfectly rigid and parallel to each other. A casting D, carrying on its under-side two 5-in. hydraulic rams I, 4 ft. long, is formed so as to slide freely between the columns, which act as guides; the hole in the centre of this casting is large enough to admit freely a bore-tube, and by means

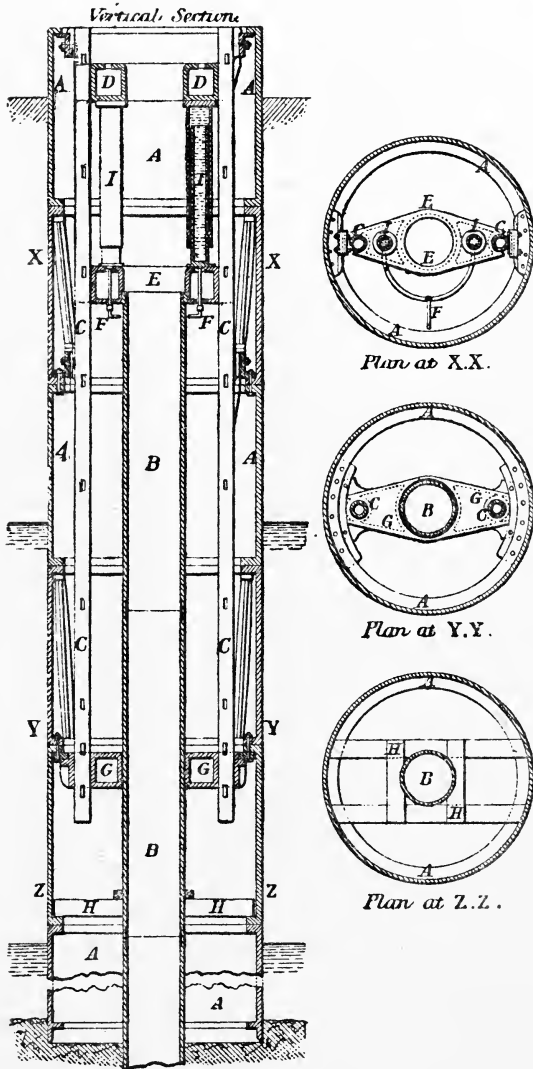

FIG. 63.—TUBE-FORCING BY HYDRAULIC PRESS.

of cotters passed through the slots in the columns the casting is securely fixed at any height. A second casting E, exactly the same shape as the top one, is placed upon the top of the tubes B to be forced down, a loose wrought-iron hoop being first put upon the shoulder at the top of the tube, large enough to prevent the casting E from sliding down the outside of the tubes ; this casting or crosshead rests unsecured on the top of the tube and is free to move with it. The hydraulic cylinders I, with their rams pushed home, are lowered upon the crosshead E, and the top casting D to which they are attached is then secured firmly to the columns C by cottering through the slots. A small pipe F, having a long telescope-joint, connects the cylinders I with the pumps at surface which supply the hydraulic pressure.

By this arrangement, a force of 3 tons per sq. in., or about 120 tons total upon the two rams, has frequently been exerted to force down the tubes at the Horse Fort. After the rams have made their full stroke of about 3 ft. 6 in., the pressure is let off, and the hydraulic cylinders I with the top casting D slide down the rams, resting on the cross-head E until the rams are again pushed home. The top casting D is then fixed in its new position upon the columns C, by cottering fast as before, and the hydraulic pressure is again applied ; and this is repeated until the length of 2 tubes, making 18 ft., has been forced down. The whole hydraulic apparatus is then drawn up again to the top, another 18 ft. of tubing is added, and the operation of forcing down is resumed. The tubes are steadied by guides at G and H.

The boring operations are carried on uninterruptedly during the process of tubing, excepting only for a few minutes when fresh tubes are being added. It will be seen that the cast-iron well is in this case the ultimate abutment

against which the pressure is exerted in forcing the tubes down, instead of the weight of the boring-machine with stones and pig-iron added, as in the case where screw-jacks are used.

In the event of any accident occurring to the tubes while they are being forced down the bore-hole, such as requires them to be drawn up again, the core- or prong-grapnel, Fig. 60, is employed for the purpose; having 3 expanding hooked prongs, which slide readily down inside the tube, and spring open on reaching the bottom, the hooks project underneath the edge of the tube, which is thus raised on hauling up the grapnel. In case the tubes become crooked or indented, the long straightening-plug, Fig. 60, consisting of a stout piece of timber faced with wrought-iron strips, is lowered inside them; above this is a heavy cast-iron block, the weight of which forces the plug past the irregularity and thereby straightens them again.

CHAPTER VIII.

AMERICAN ROPE-BORING SYSTEM.

THE method of boring with a rope has received great development in the petroleum industry of the United States.

The derrick or sheer-frame employed is a tall framework of timber, 10 to 16 ft. square at bottom and 30 to 80 ft. high. On the top is a strong framework for the reception of a pulley over which the drill-rope passes. The floor of the derrick is made firm by cross sleepers or "mud-sills" covered with planks. A roof for the protection of the workmen is arranged at 10 to 12 ft. above the floor, and in cold weather the sides are boarded up. On one side of the derrick is arranged a windlass of peculiar construction called the "bull-wheel," and on the other is a steam-engine giving motion both to a connecting-rod which rocks the lever or working-beam, and (by means of a belt) to the bull-wheel. The arrangement very much resembles that of the boring sheer-frame shown in Fig. 23 (p. 55), if the windlass were detached, and the lever were arranged to be worked by power.

A form of rig which is readily put up and taken down, and is adapted for transportation from place to place, is shown in Figs. 64 to 69, the illustrations being respectively a side elevation, a front elevation and a ground plan of the rig as a whole, a plan of the friction-wheels and brake-

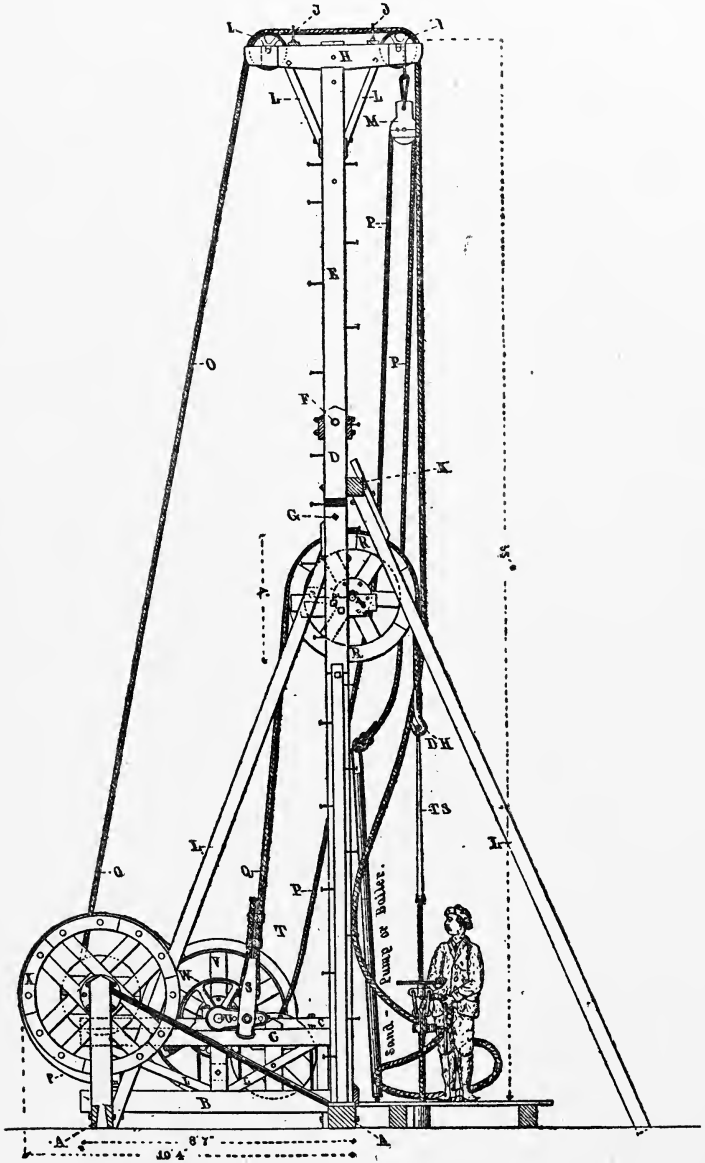

FIG. 64.—PORTABLE ROPE-BORING PLANT.

levers, a view of the rig arranged for pipe-driving, and a view of it arranged for pumping. This arrangement, by the Oil Well Supply Co. of Bradford and Oil City, Pennsylvania, U.S.A., is highly recommended for wells of a less depth than 600 ft., and can be operated by either steam or horse power. It will swing a set of boring tools 31 ft. long and weighing 950 lb.; occupies a space of only 12 by 20 ft.; weighs complete but 2 tons (4000 lb.); and, when the mast is folded, is 25 ft. high.

The 2 mud-sills A, one 10 in. square and 11 ft. 5 in. long and the other 10 by 8 in. and 10 ft. long, rest upon the ground and sustain 2 beams B, 8 by 6 in. in section and 8 ft. 7 in. long, which support on proper posts the framework C. The double samson-post D is fastened to the principal mud-sill A, and the mast E is hinged therein at F by a piece of tube passed through both posts and mast. A bolt with large washers is put through the pipe, and a nut and large washer are added. At the point G another bolt traverses both samson-posts and mast after the latter is raised into position.

On the top of the mast is a pulley-frame H carrying the crown-pulleys I and the guide-hooks J which keep the drilling-cable O in place. At K is a cross-bar which ties the tops of the samson-posts D together. Braces L are put where needed, and all parts are secured by bolts and nuts, no nails being used.

The sand-pump or shell-pump block M is hung on the crown-beam H; and a guide-pulley N for the sand-pump line P is attached to the cross-bar K.

The working-line Q passes over the drilling-wheel R and is firmly fastened to the pitman-block S by being doubled through an aperture therein; the two ends of the rope are made fast together by the clamps T. The other

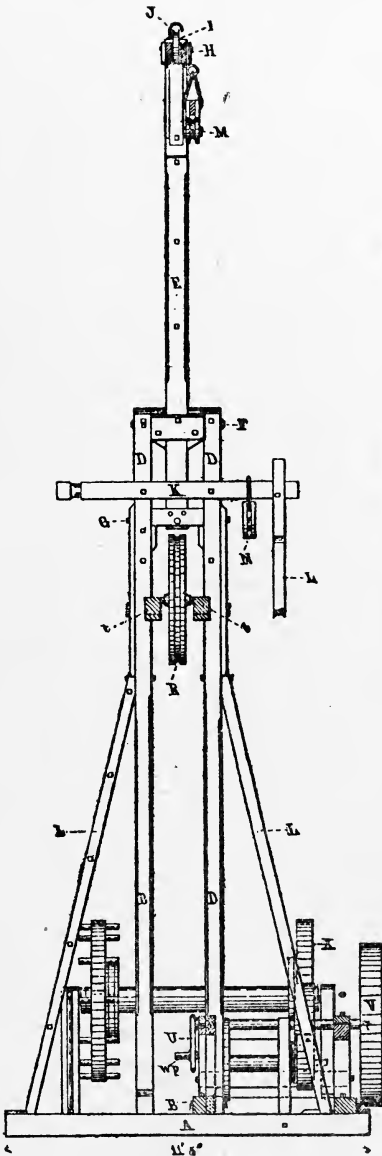

FIG. 65.

PORTABLE ROPE-BORING PLANT.

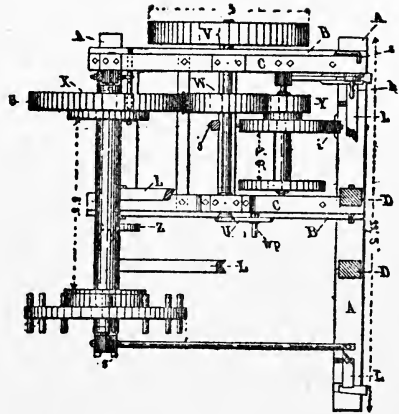

FIG. 66.

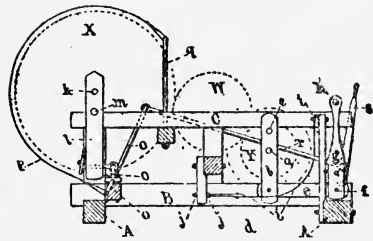

FIG. 67.

end of the working-cable is terminated by a drilling-hook D H, on which is hung the temper-screw T S.

The pitman-block S fits in the wrist-pin w p of the crank U, and rotation of the crank causes a reciprocating vertical motion of the tools.

Power is communicated from engine or horse-gear to the band-wheel V, on the shaft of which is keyed the friction-wheel W. Either the bull-wheel X or the sand-reel pulley Y is brought against the friction-wheel W as required.

The sand-reel is hung at a on the swinging-beam b , which is pivoted at c to the frame C, and is joined at d by the draw-bar e , united at f to the lever g . A pull upon the lever-handle h will throw the pulley Y of the sand-reel against the friction-pulley, and this will cause it to rotate and wind-up the sand-line P; while a push upon the lever will cause the wheel of the sand-reel to press against the brake i , which is an iron band fitted to encircle a fourth of that wheel. Provision is made for tightening that band by nuts at j , so as to take up any slack.

One end of the bull-wheel X is pivoted at k on the swinging-bar l , which again is pivoted at m to the frame C. A T-bolt unites the swing-bar l to the iron lever o . This lever has one long arm and two equal short arms with two bearings, the short arms being nearly opposite each other, one projecting above the beam B and the other extending an equal distance below its surface. The swinging-bar l is joined to one short arm and the brake-band p to the other. A draw-bar r connects the long arm of the lever o with the hand-lever. The brake-band p encircles nearly $\frac{3}{4}$ of the bull-wheel, and is firmly fastened to the rod q , which is bolted to the frame C. A pull upon the hand-lever loosens the brake-band p , and forces the bull-wheel X against the

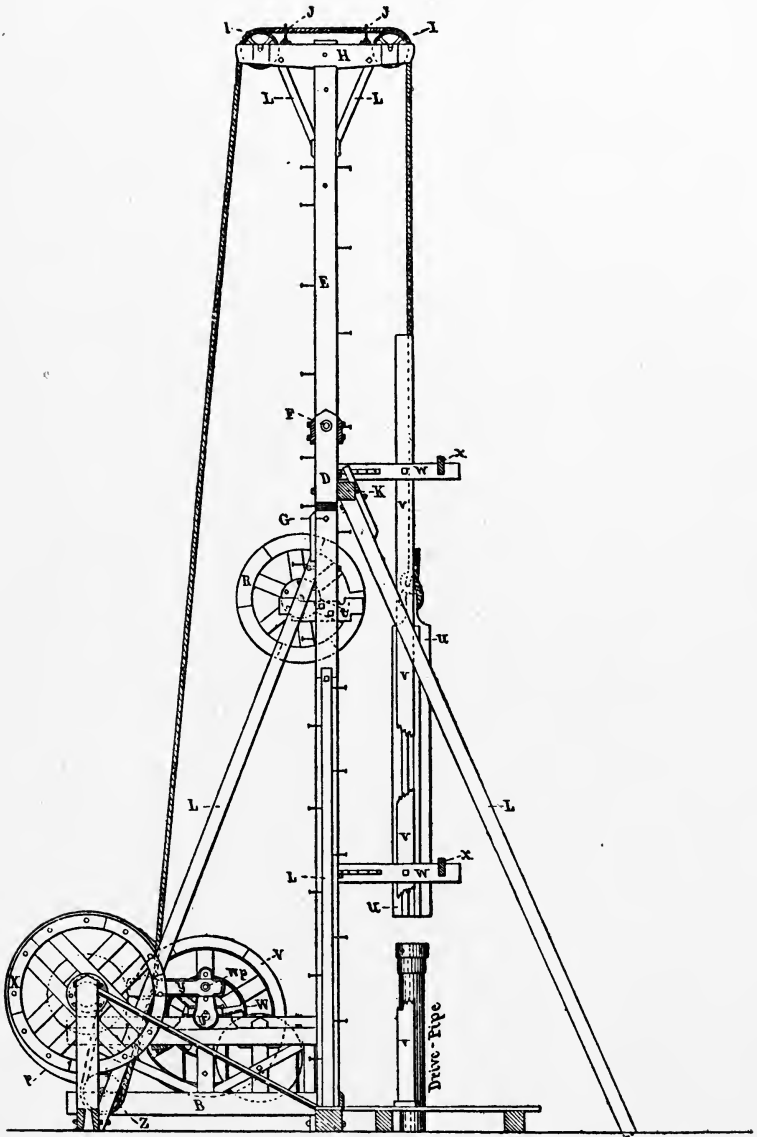

FIG. 68.—ROPE PLANT DRIVING PIPE.

friction-wheel W. A push upon the handle *s* forces the bull-wheel away from the friction-wheel W, and clasps the brake-band *p* firmly around the wheel.

The action of the hand-levers *h* and *s* in controlling the motions of the sand-reel and bull-wheel respectively is quick and effective. The bearing surfaces are wide, and the wheels are truly made, so that motion is immediately communicated without the least slip, and the brakes can be applied so as to stop the wheels instantly while at their swiftest speed. When the levers stand straight, both bull-wheels and sand-pump reel revolve freely.

The drilling-wheel R rests in grooves in the supports *t*, of which there are two sets, one in front of and the other behind the samson-posts D. When the drilling-wheel R is in use, it rests in the front grooves as shown in Fig. 64; when not in use, it is put in the back grooves.

When driving pipes or using a cutting tool, a small grooved wheel Z is fixed in the centre line of the samson-posts, below the bull-wheel. The cable O is carried downward around the wheel Z and upward over the crown-pulleys I, and is united to the maul *u* which plays in the guides *v* supported by bars *w* hinged to the samson-posts D, the front ends of the hinged bars being kept in position by cross-ties *x*.

A short bar *y* with a grooved wheel at one end, inside of which plays the cable O, is fastened to the wrist-pin *w p*, so as to allow the wrist-pin to turn freely. Rotation of the crank causes alternate tension and loosening of the cable O, and thus the maul *u* is elevated and dropped, much in the same manner as piles are driven.

When the well is pumped, the polished rod has clamped upon it at two points a wire rope which encircles the working-wheel R, and a projecting arm is fastened to that wheel

and connected with a pitman which is attached to the wrist-pin. The mast may be left erect, or folded down as in Fig. 69. The pumping motion is very even and steady,

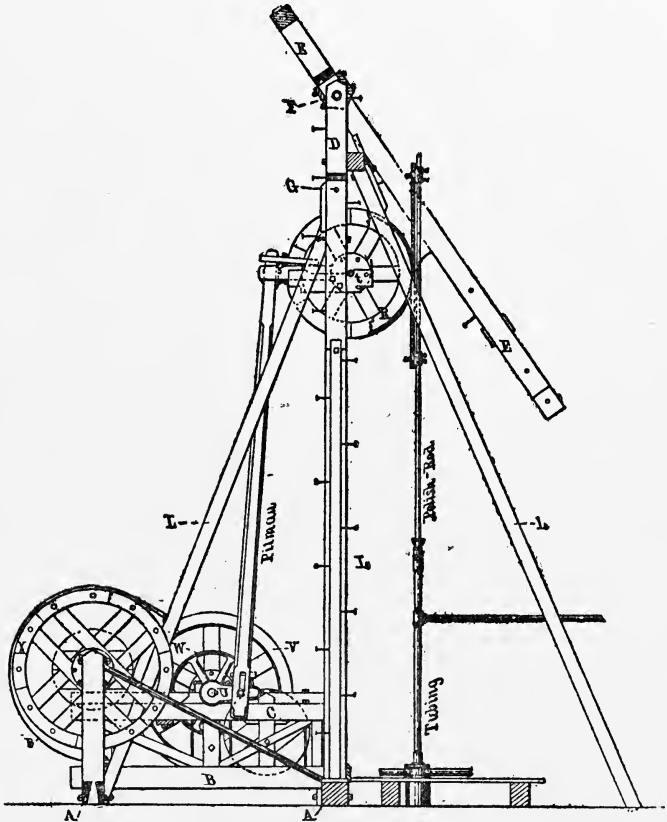

FIG. 69.—ROPE PLANT PUMPING.

as the polished rod moves in a perpendicular line, and saves the tubing from any jar or vibration.

Strong bolts inserted in each side of a brace to one of

the samson-posts D and the mast E form a ladder giving easy access to the top.

The replacing of any wooden part of the rig that may become injured can be effected by an ordinary carpenter.

With fair usage, the rig is reckoned capable of boring hundreds of wells.

The first step in the operations is to sink the iron driving-pipe to a depth ranging from 6 to 75 ft. and generally between 20 and 50 ft. This pipe acts as a guide, and prevents earth or stones from falling into the hole while the drilling is going on. The driving-pipe in general use is of cast-iron, 6 to 8 in. diam. and 1 in. thick, in lengths of 9 or 10 ft. The driving of this pipe is a work of difficulty, requiring the utmost skill, since the pipe must be forced down through all obstructions to a great depth, while it is kept perfectly vertical. The slightest deflection from a straight line ruins the well, as the pipe exerts control over the drilling-tools.

The process of driving is simple but effective. Two slideways made of plank are erected in the centre of the derrick to a height of 20 ft. or more, 12 to 14 in. apart, with edges in toward each other; the whole is made secure and plumb. Two wooden clamps or followers are made to fit round the pipe, and slide up and down on the edges of the ways. The pipe is erected on end between the ways, and is held perpendicular by these clamps; a driving-cap of iron is fitted to the top. A ram is then suspended between the ways, so arranged as to drop perpendicularly upon the end of the pipe. The ram is of timber, 6 to 8 ft. long and 12 to 14 in. square, banded with iron at the lower or battering end, and furnished with a hook in the upper end to receive a rope. When the whole is in position, a rope is attached to the hook in the upper end, passed over the pulley

of the derrick, down to and round the shaft of the bull-wheel. Everything is then in readiness to drive the pipe. The belt connecting the engine and band-wheel being adjusted, and the same having been done to the rope connecting the band-wheel and bull-wheel, called the bull-wheel rope, the machinery is put in motion; a man, standing behind the bull-wheel shaft, grasps the rope which is attached to the ram and coiled round the bull-wheel shaft, holds it fast, and takes up the slack in his hands, thus raising the ram to its required elevation; it is let fall repeatedly upon the pipe, which is thereby driven to the requisite depth. When one joint of pipe is driven, another is placed upon it, the two ends are secured by a strong iron band, and the process is continued as before. The pipe has to be cleared out frequently, both by drilling and by sand-pumping or working the shell-pump. Where obstacles such as boulders are met with, the centre-bit is put into requisition, and a hole, two-thirds the diameter of the pipe, is drilled. The pipe is then driven down, the edges of the obstacle being broken by the force applied, and the fragments falling into the hollow created by the passage of the bit. When this cannot be done, the whole machinery and derrick is moved sufficiently to admit of driving a new set of pipes, or the hole is abandoned. It sometimes happens that the pipe is broken, or diverted from its vertical course by some obstacle. The whole string of pipe driven has then to be drawn up again or cut out in the manner already described, and the work is commenced anew. If this is not possible, a new location is sought.

After the pipe is driven, the work of drilling is commenced. The drilling-rope, which is generally $1\frac{1}{4}$ -in. hawser-laid cable of the required length (500 to 1000 ft.), is coiled round the shaft of the bull-wheel, the outer end

passing over the pulley on the top of the derrick, down to the tools, and is attached to them by a rope socket, of which various forms are in use. The tools consist of the centre-bit or chisel, auger-stem or drill-bar, jars, sinker-bars and rope-socket, which are shown arranged for work in the order detailed, Fig. 70. When connected, these are 30 to 40 ft. long and sometimes more, weighing 800 to 1600 lb., according to depth required. The process of drilling, until the whole length of the tools is on and is suspended by the cable, is slow. When the depth required for hanging the tools is attained, the attachment between the working-beam (or "walking"-beam, as it is often called) and the drilling cable is made by means of a temper-screw depending from the end of the working-beam and secured to the rope by a clamp and set-screw.

The temper-screw *a*, Fig. 71, is 5 to 6 ft. long and $1\frac{1}{2}$ in. diam., with a square thread 2 to the inch. The wrought-iron rims are $1\frac{1}{2} \times \frac{5}{8}$ in. and $5\frac{1}{2}$ ft. long. The nut of the lower end of the rims is cut in two; a band with a set-screw encircles this divided nut, and is riveted to one half, the set-screw pressing against

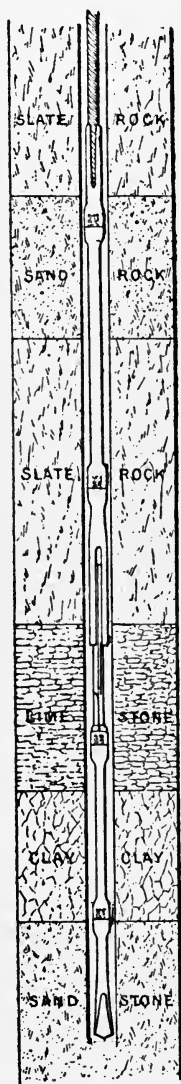

FIG. 70.—SECTION SHOWING AMERICAN ROPE-BORING TOOLS.

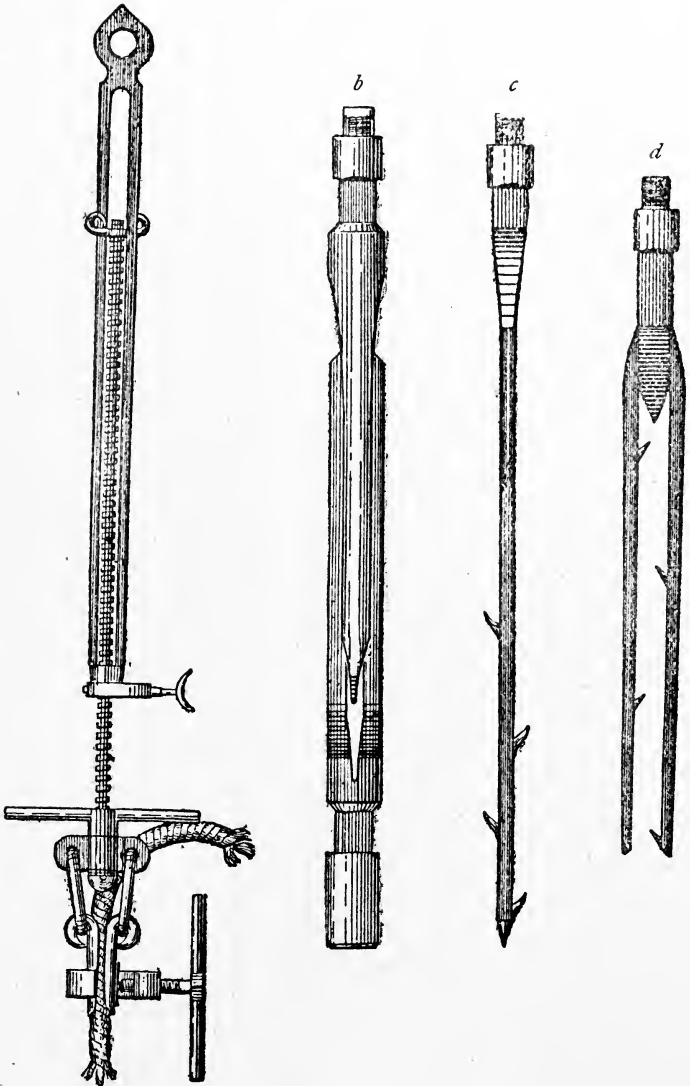

FIG. 71.—AMERICAN ROPE-BORING TOOLS.

the other half. The rims are constructed so as to spring apart and free the nut. When the driller wishes to pay-out the temper-screw, he loosens the set-screw and revolves the temper-screw, again tightening the set-screw to maintain it in position. When the screw is all run out and disconnected from the cable, the set-screw is loosened so that the nut flies open and leaves the long screw free ; it can then be pushed up, and the nut can be tightened. This adjustment is aided by a counterpoise equal in weight to the screw and clamps, hung on two cords passing over pulleys on the working-beam and attached to the bows of the swivel at the upper end of the screw. One of the pulleys is above the samson-post and the other two are on each side of the drilling-hook. The counterpoise moves along the samson-post, and the cords have separate pulleys above the temper-screw, but both go over the same pulley as the samson-post.

The "jars" *b* are made in two parts and are like long links of a chain. Both parts are slotted, and the cross-head of one passes through the slot of the other. When extended, the jars are 6 ft. long ; when closed, 5 ft. 3 in. : the difference, 9 in., is the play of the jars, the function of which is to give an upward blow having the effect of loosening the auger and preventing it from "sticking" in the rock.

The rope-spear *c* and the two-wing rope-grab *d* are for taking hold of the end of the rope when it has parted in the bore-hole. At *a*, Fig. 72, is seen a rope-knife in operation, severing the rope in the well.

The combination bit and mud-socket or shell-pump shown in *b* is a most useful tool for clearing out old wells, the bit loosening the dirt so that it can be drawn into the tube for removal. Another form of shell-pump or sand-

pump is represented at *e*, and is known as Moody's; the bailer is driven into the mud by jarring, and the mud is forced into the tube by hydrostatic pressure.

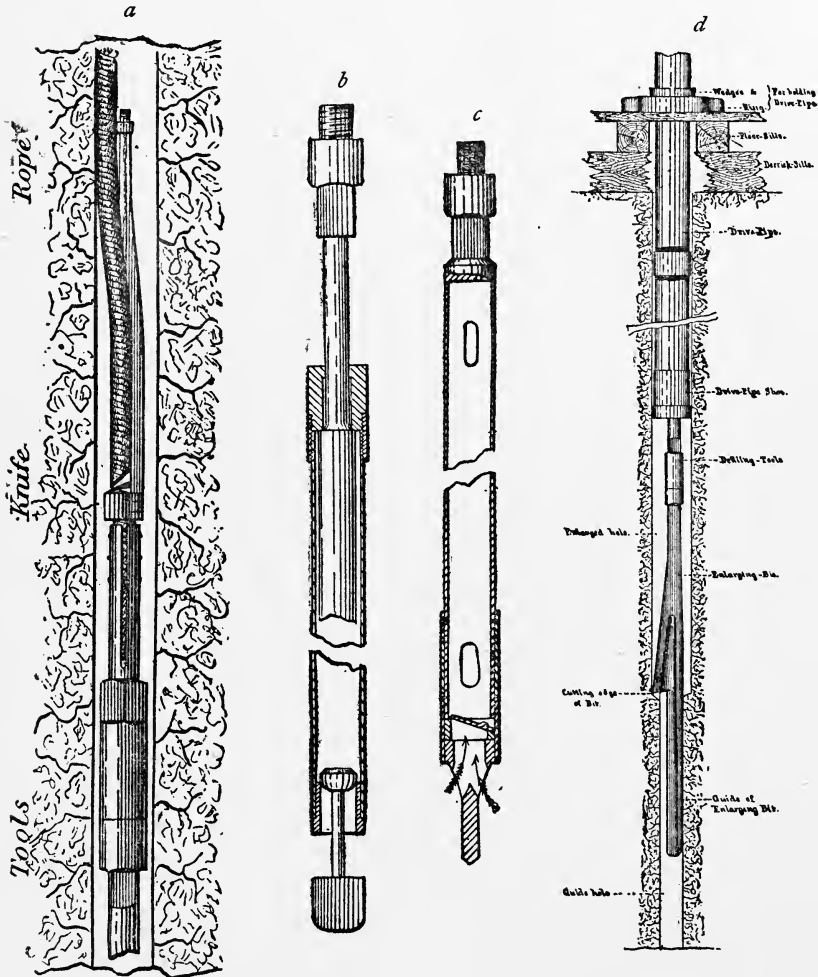

FIG. 72.—AMERICAN ROPE-BORING TOOLS.

The working of Clary's enlarging-bit or rimer (reamer) is shown at *d*. This bit cuts ahead of the drive-pipe, and prepares a hole for it in passing through hard ground. A hole about 4 in. less than the outside diameter of the drill-pipe is drilled in advance for reception of the guide-stem of the enlarging-bit. It is a highly effective arrangement.

In drilling, the tools are alternately lifted and dropped by the action of the working-beam on its rocking-motion. One man is required constantly in the derrick, to turn the tools as they rise and fall, to prevent them from becoming wedged fast, and to let out the temper-screw as required. This is one of the most important duties of the work, requiring constant attention to keep the hole round and smooth. The centre-bit or chisel is run down the full length of the temper-screw; it is about $3\frac{1}{2}$ ft. long, with a shaft $2\frac{1}{2}$ in. diam., a steel cutting edge $3\frac{1}{2}$ to 4 in. wide, and a thread on the upper end by which it is screwed on the end of the auger-stem. The reamer is about $2\frac{1}{2}$ ft. long, and has a blunt instead of a cutting edge, with a shank $2\frac{1}{2}$ in. diam. terminating in a blunt extremity $3\frac{1}{2}$ to $4\frac{1}{2}$ in. wide by 2 in. thick, faced with steel. The weight of heavy centre-bits and reamers averages 50 to 75 lb.

The centre-bit is followed by the reamer, to enlarge the hole and make it smooth and round. The debris or pounded rock is taken out after each centre-bit, and again after every reamer, by means of a sand-pump or shell-pump. The sand-pump is a cylinder of wrought iron, 6 to 8 ft. long, with a valve at bottom and a strap at top; to it is attached a $\frac{1}{2}$ -in. rope, passing over a pulley suspended in the derrick some 20 ft. above the floor, back to the sand-pump reel attached to the jack-frame, and coiled upon the reel-shaft.

This shaft is propelled by means of a friction-pulley,

controlled by the driller in the derrick, by a rope attached. The sand-pump is usually about 3 in. diam. Some drillers use two—one after the centre-bit, and a larger one after the reamer: this is preferable. When the sand-pump is lowered to the requisite depth, it is filled by a churning process of the rope in the hands of the driller, and is then drawn up and emptied. This operation is repeated each time the tools are withdrawn from the well, the pump being let down a sufficient number of times to remove the drillings. The fall of the tools is 2 to 3 ft. This alternation goes on, first tools and then sand-pump, until the well is drilled to the required depth. As a rule, abundance of water is found in the wells, both for rope and tools, from the commencement.

In practical operations, the driller takes his seat on a high stool above the chosen spot, adjusts the drill with great care through the conductor-pipe, and starts striking 30 to 40 blows a minute.

Between the strokes, the tools require to be moved round. With this also a slight downward motion is given at every few strokes, by a turn of the temper-screw.

The drill is kept moving up and down, cutting 1 to 6 and even 12 in. of rock and shale per hour, according to hardness. At intervals the centre-bit is drawn up, badly worn and battered, and a reamer is let down to enlarge the hole and make it smooth and round; these are followed by the sand-pump.

The first few hundred feet are generally gone through without difficulty, provided all the arrangements have been made with care at the beginning, and the drillers are skilful. Difficulties occur farther down that test the most persistent energy.

Sometimes they are attributable to want of caution on

the part of the driller, to imperfection in the material or improper dressing or tempering of the drill, but more often to circumstances unforeseen and unavoidable. In its passage, the drill not unfrequently dislodges gravel or fragments of hard rock, that have a tendency to wedge it fast in the hole, from which it is released only by most persistent "jarring."

The reamer is also subject to the same mishap, or a sand-pump may break loose from its rope, and have to be fished up. When the bit or reamer becomes so firmly imbedded as to render its removal impossible by jarring or by breaking it in pieces, the well is abandoned.

Sometimes a bit or reamer breaks, leaving a piece of hard steel securely in the rock several hundred feet below the surface. Where the fragment is small, it is pounded into the sides of the well, and causes no further annoyance. When it is larger, the difficulty is greater, and not unfrequently insurmountable. The bit or reamer sometimes becomes detached from the auger-stem, by the loosening of the screw from its socket. This difficulty is often greatly heightened by the fact that the workman may not be aware of its displacement, and for an hour or two be pounding on the top of it with the heavy auger-stem. Various plans are resorted to for extracting the fastened tool, and a large number of implements have been devised for fishing it up. The first is an iron with a thin cutting edge, straight, circular or semicircular, acting as a spear, or to cut loose the accumulations round the top and along the sides of the refractory bit or reamer, so as to admit a spring-socket, that is lowered by means of the auger-stem over the top of it, and lays hold upon the protuberance just below the thread.

If the socket can be made fast, the power of the bull-

wheel and engine is requisitioned, and in a great number of cases the tool is brought to the surface. In the jarring and other operations rendered necessary in cases of this kind, the entire set of tools, 40 to 60 ft. in length, may become fastened, and cases are of frequent occurrence where two and even three sets of tools have become fastened in a well, as they were successively let down to extricate the first ones. This is liable to occur at any stage of the work, and its frequency increases with the depth.

In addition to the difficulties mentioned, there is yet another, far more dreaded by the driller. This is what is called a "mud-vein." It is a stratum of mud or clay, up to several inches in thickness, generally met with at a depth of 400 to 900 ft. Mud-veins abound in most of the oil-producing localities, and not a few operators regard them as invariably indicating an abundant supply. The mud or clay is of a most tenacious character, and while not deemed of much importance as an obstacle in the beginning of the development, may exhibit new features in different localities. The mud suddenly flows into the well while the process of drilling is going on, settling round the drill, bedding it almost as firmly as the rock itself. Its presence is often indicated to the driller by the sudden downward pressure on his rope. If drilling on or below it, the workman, when about to withdraw his drill, will get assistance from the bull-wheel, and the instant the working-beam ceases its motion, a few turns will be taken on the wheel, so as to raise the bit above the mud, as it sets almost as quickly as plaster of Paris. Sometimes this mud will flow into the hole for a depth of 20 ft. or more, burying the entire drilling-tools and attachments. This renders the jars useless. By attaching a cutting instrument to rods, the rope above the sinker-bar is cut, and then is sub-

stituted a spear-pointed instrument, with which, by means of a light set of tools, the substance round the tools is forced from them; an extra pair of jars is lowered, and efforts are made to jar the tools loose.

The spear is sometimes shaped like a common wedge, faced with steel at the cutting edge, made thin. A half-circular instrument, made in like fashion, is also used. The mud-socket, circular shaped with thin edge, terminating on the inside with an abrupt shoulder, corresponds with the ordinary clay-auger, and is similarly used.

A large number of appliances have been invented for the dislodgment of fastened tools, many of them very complicated. The main thing sought is an instrument that in the first place will remove the material round the top of the fastened implements, to be followed by others acting on the principle of a clamp, sufficiently powerful to retain its hold and allow the jarring of the tools loose or the drawing of them up.

One most effective instrument for the dislodgment of tools consists of a number of heavy iron rods or bars, similar to an auger-stem, and weighing 10 to 11 tons. It can be made of any desired length or weight. It is lowered over the head of the tools, and these are screwed fast into a suitable socket arranged at the ends of the rods, and worked from the top. When a set of tools are fast, each separate piece is unscrewed, the apparatus acting as a left-handed screw. Each piece, as loosened, is brought to the surface. By applying the full force of the engine, these 2½-in. iron rods are frequently twisted like an auger. They are lowered and raised from the top by jack-screws.

It will be seen that the system has many features in common with European practice. The centre-bit and reamers are but other names for variously shaped chisels

whilst the jars serve a similar purpose to that of sliding joints. As a cheap method of putting down deep bore-holes through shales, limestones and soft rocks, it is very useful ; but it must certainly be supplemented by others when hard or troublesome beds are met with.

ELASTIC SUSPENSION FOR DRILLING-RODS.

M. Petit writes to 'Naphtha' that in the course of drilling a hole with a Canadian rig, he recommended the employment of a spring temper-screw attached to the walking beam, as shown in Fig. 72A. The screw 1, 80 in. long, was passed through the tapped hub 2, of a horizontal wheel resting on the bearing 3, which was fitted with trunnions 4, 5, engaging in slots cut in the bearing blocks 6, 7, bolted on to the walking beam 8. By means of the wheel the screw could be adjusted vertically to any desired length, the wheel being kept in position by strong pegs ; and this simple arrangement gave very satisfactory results.

The owner of the mine where this boring was carried on (M. Laporte) conceived the idea of interposing flat springs between the bearing 3 and the walking beam, in order to diminish the shock to which the string of tools is exposed at each stroke ; an arrangement at once enabling the rate of speed and efficiency of the rig to be considerably increased, and at the same time reducing the resistance to be overcome by the engine.

This trial boring, conducted on the water-flush principle, although effected with a Canadian crane, which is little suited to this class of work, nevertheless shows decisively that drilling with rigid hollow rods, through which a strong

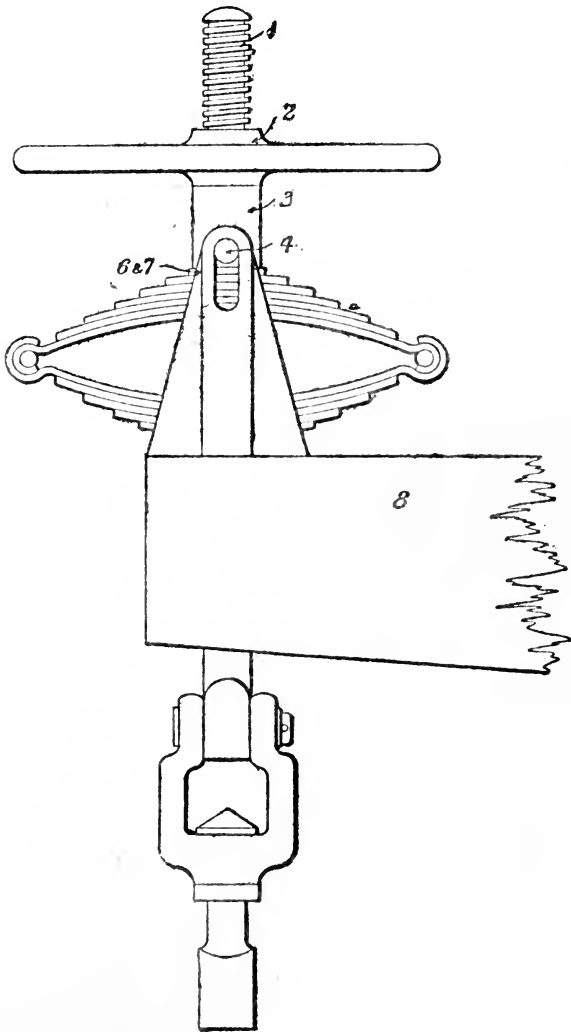

FIG. 72A.—SPRING DRILL-HEAD.

current of water is injected to the bottom of the bore hole, is far superior to the ordinary method of drilling with solid rods and jars without a water flush.

It might have been anticipated that in the oligocene formation at Kobylanka, consisting mainly of compact sandstone, often extremely hard, and rarely interspersed with thin layers of hard shale, the method of drilling with short (3-in.) strokes at high speed (140 strokes per minute) would be surpassed by the method of drilling with long (20-in.) strokes at a maximum speed of 60 per minute. Nevertheless, the contrary was found to be the case. In the sandstone strata, where a rate of progression of not more than 64 in. could be attained in 12 hours by the Canadian method, fitted with the best tools, the rate with the water-flush system was 0·4 in. per minute, 24 in. per hour, or 224 in. in 7 hours, nearly three times as great. In compact formations as well as in those of the oligocene epoch, the use of the temper screw with spring, as shown in Fig. 72A, enables one to drill as fast with the Canadian crane as by the water-flush method. A trial boring with this arrangement and jars showed that by using a 16-ft. sinking bar, 5½ in. in diameter, with jars of 80-in. stroke, 1-in. rods attached to the temper screw by a swivel connection, and by working at the rate of 50 strokes per minute, a regular free-fall method of boring can be produced.

At each stroke of the bit the shock of the jars compressed the spring by several centimetres. At the moment when the walking-beam has completed its upward movement a sudden stop occurs. The whole string of tools tends to jump upward, being assisted in that tendency by the springs, which suddenly expand; as, however, the rods are closely attached to the screw, and this in turn to the

walking-beam, the bit and sinker bar alone continue this movement, the rods beginning to descend. In the instant that the walking-beam has completed its down stroke the bit falls freely on to the bottom of the bore hole.

At the speed of 50 strokes per minute the bit works with a 40-in. stroke, half of which is due to the movement of the walking-beam and the remainder to the rebound produced by the sudden relaxation of the spring. Notwithstanding that the jars have a stroke of over 40 in., it often happened that the lower link came in contact with the upper one.

The force of the blow delivered by the bit on the bottom of the hole was surprising, and a rapid rate of progression was maintained, 20 to 23 ft. being drilled in 12 hours through strata where the rate under the ordinary method did not exceed 80 in. Owing to the use of a light sinker bar and the reduction of vibration by the springs, no breakage of rods occurred; the strain on the engine was reduced by one-half, while the rate of drilling was increased two and even threefold, the new method thus affording solid advantages.

The *Hydraulic Washing System* is very efficient and expeditious, it enables drilling through sand, gravel, clay, soft rock, etc., to be carried out very rapidly. It is one of the most efficacious methods as yet introduced.

The boring rods are hollow, so is the borer or chisel; water is forced through the above by means of a steam pump or any other kind available. The rods and chisel are lifted and dropped in a similar way as the ordinary percussion system; as the water is forced through them, the result will be that all the débris are washed to the surface. The great advantage of this system is, that the tools need not be removed from the hole from time to

time—consequently the ease and rapidity with which they work.

The deeper the boring the greater the weight and the

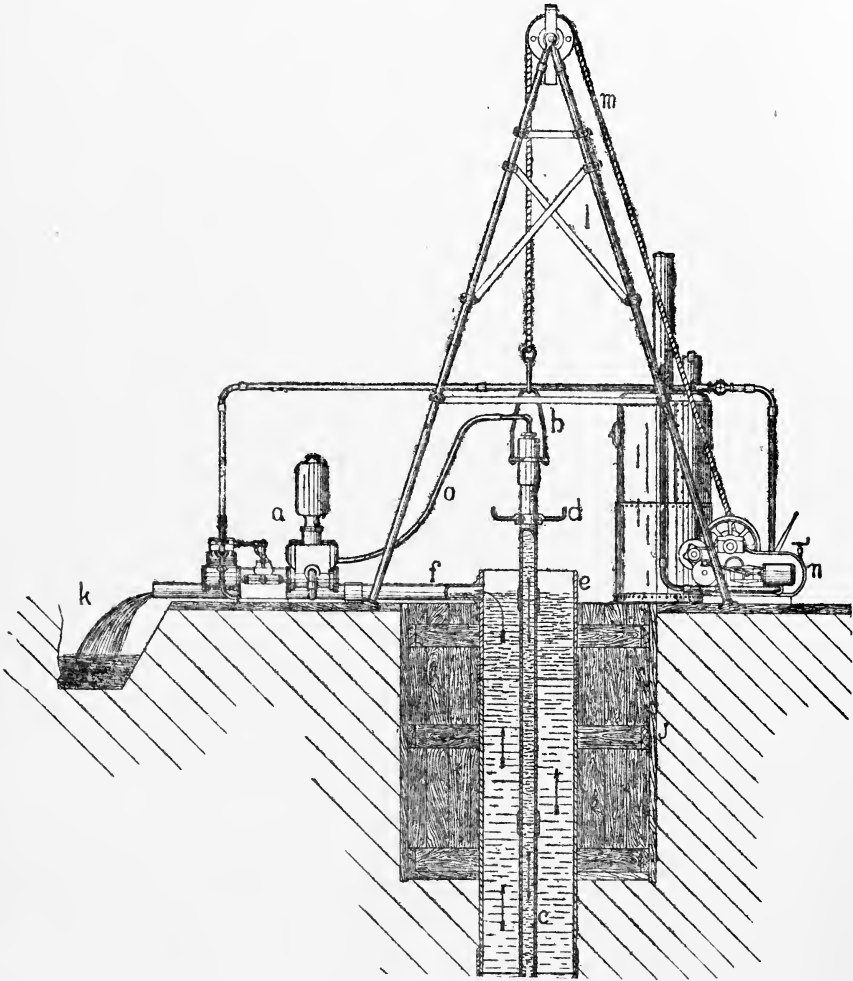

FIG. 72B.

better the work, as the heavier they are the quicker they drop and the faster is the slurry forced up.

It is advisable to sink three or four settling tanks 6 ft. by 6 ft. and 4 ft. deep, to allow the water and slurry pumped

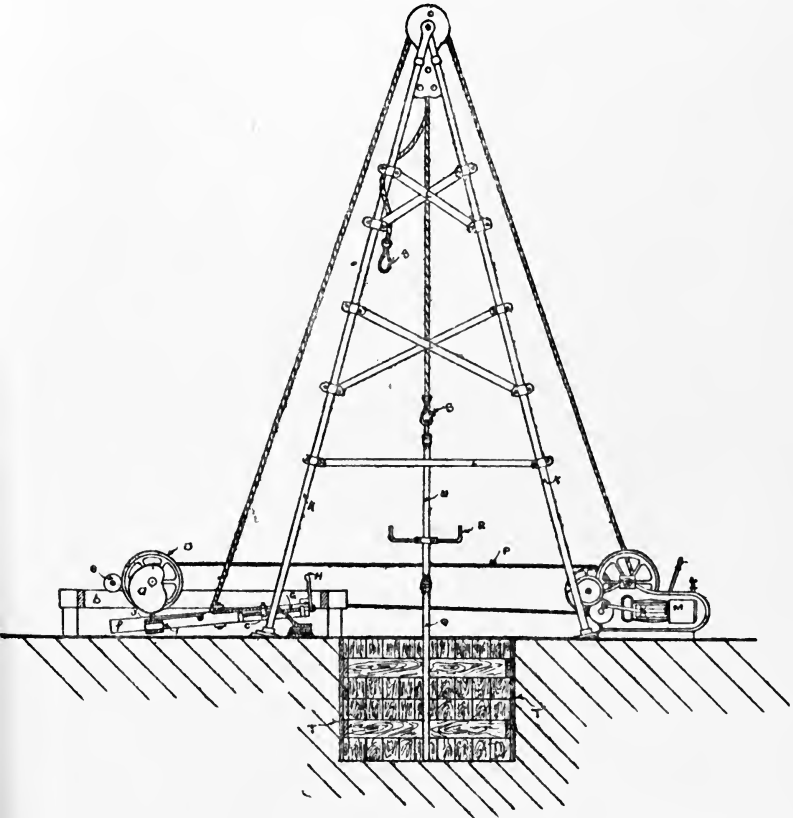

FIG. 72C.

to flow first in one and then the other, the mud will settle and the water can be pumped over again.

The machines illustrated in Figs. 72B and 72C are improved ones; Fig. 72C is an arrangement patented by the author.

With this arrangement the suspension rope supporting the boring rods is attached, through the medium of a screw adjustment, to a lever, which is maintained, by the weight of the rods, in contact with a cam rotated at a constant speed from any convenient source of power, such as a steam-winch. The cam is of such form that the lever is alternately vibrated, with a relatively slow movement, in a direction to raise the boring rods by hauling on the suspension rope, and allowed to return with a quick movement in the opposite direction, so as to permit the boring rods to fall; the depth of the descent being determined by the length of the rope, which is adjusted by varying the position of a nut to which the rope is made fast, the nut working upon a leading screw mounted in bearings on the lever, and rotated by a hand-wheel, ratchet gear, or other convenient means, so as to pay out the rope when a fresh cut requires to be taken. In ordinary hand-punching arrangements, especially in deep borings where the weight of the rods is considerable, great skill and constant watchfulness is required, to prevent the tool from striking the bottom of the bore with the full force due to the acquired momentum of the entire boring rods, and so causing them to become bent.

With this machine the length of the suspension rope can be accurately adjusted, so that the tool falls to exactly the same distance on each stroke, so preventing the rods getting the whole of their own weight and bending; and, at the same time, the cut can be put on with the feed-screw at exactly the required rate, according to the nature of the ground. This can easily be determined by simply watching the punching rope, and taking care not to feed it forward fast enough to ever allow it to become slack.

CHAPTER IX.

DEEP BORING WITH DIAMOND DRILLS.

ALL the methods of executing a bore-hole to any considerable depth, which have so far been discussed in these pages, involve the complete grinding-up of the removed rock, that it may be discharged from the hole in a condition of sand or mud. While this may be a commendable practice so long as the ground passed through is not of extreme hardness, and neither the depth nor the diameter of the hole is of great magnitude, the converse is the case when those conditions are not present.

It is becoming a matter of serious consideration by advanced mining engineers whether—even in the case of holes only 5 or 6 ft. deep and $1\frac{1}{2}$ in. diam. or even less, when the rock is exceptionally hard and resisting to the boring-tool—the principle of pounding to dust the entire contents of the hole can be regarded as comparable in economy with that of merely cutting a thin ring of rock from the circumference of the hole, and extracting the remainder in the form of a solid core.

From a purely scientific standpoint, the general smashing principle is obviously inferior to the ring-cutting principle, for it involves an enormously increased amount of work. But whereas in the former case the work is done by percussion, with a very simple tool, the latter method depends on abrasion, and the mechanism employed is somewhat complicated and decidedly costly. Even so, with improve-

ments in steel alloys for the necessary tools, rotary core-drills are destined in time to largely replace the ordinary miners' percussive drill of to-day. How much more applicable the rotary drill must become in the case of the deep and large bore-holes required in seeking water-supplies from strata lying hundreds of feet beneath the surface, need hardly be emphasised.

In another branch of mining, where the desideratum is not so much a hole as the extraction of a solid specimen of the ground traversed, for prospecting purposes, the core-drill is already an indispensable and recognised implement, and in this direction it has gained a wide-spread application. In deep-well boring through hard strata it has been extensively used, and is quite unequalled in efficiency. The deeper the bore and the greater its diameter—in other words, the larger the volume of rock to be removed—the more marked becomes the superiority of the core-drill, but the rock to be penetrated *must be hard*. Herein lies one of the difficulties encountered in core-drilling. A bore of any considerable depth will necessarily pass through various alternations of strata: some, hard, dense and homogeneous; others, of mixed character, such as gravels, conglomerates, and flinty chalk-beds; and again others, uniformly soft, as sandstones and clays. The ordinary core-drill is useless in two out of the three categories, and must then be replaced by the percussive drill. The great losses of time and increased expense thus involved have militated against the adoption of the core-drill in well-boring in many cases where sections of the strata absolutely demanded its application. But this drawback has now been entirely overcome by a most ingenious combination machine capable of operating either drill as required, and incurring merely nominal delay in changing from the one to the other; it will be fully described on a subsequent page.

In its usual form, the core-drilling machine is known as the "diamond drill," because the abrasion is performed by an amorphous variety of that gem. They are of two kinds, termed "borts" and "carbonados," which are alike in this that they possess no merit as precious stones and are valuable simply for their hardness. The former occur mostly in the S. African deposits; the latter, of Brazilian origin and black in colour (hence their name), are preferred as being more massive and less disposed to splinter. In the trade they are called "carbons." A series of these stones are set in a tubular steel "crown" or "bit" attached to hollow rods for rotation at great speed, their number varying with the diameter of the hole to be bored. Water forced down from the surface removes the material ground away by the stones, and at the same time keeps them cool. The cylindrical core of solid rock is broken off by a special contrivance, and hoisted with the "bit" from time to time. The smallest diamond drills on the market are operated by hand-power, and will take cores of small diameter (about 1 in.) from holes up to 400 ft. deep. The largest stock size produces a 4-in. core, and is capable of successful and satisfactory manipulation at a depth of a mile.

The setting of carbons in the bit (Fig. 73) is a matter demanding no little skill and care.

After screwing the blank bit into the setting block, the first step is to divide the bit into as many equal parts as the number of diamonds to be used (varying from about a dozen to fifty, according to size of hole), and mark with centre punch, as at *a*, where they are to be placed. Breast-drill and twist-bits are then used to bore a horizontal hole *b* in the side of the bit; each diamond should be studied separately, and a hole be bored in proportion to its size. As the outside diamonds can be more conveniently set than those on the inside rim, the largest should be selected for

this purpose, and set first. Horizontal holes are used for the outside diamonds, and vertical holes for those on the inside of the bit. After boring, the hole is chipped out by small chisels until the diamond fits very snugly in the metal as at *c d*, and projects $\frac{1}{8}$ in. above the face, and the same distance from the outside and inside rim of the bit.

When the diamond is fitted in place, and the proper

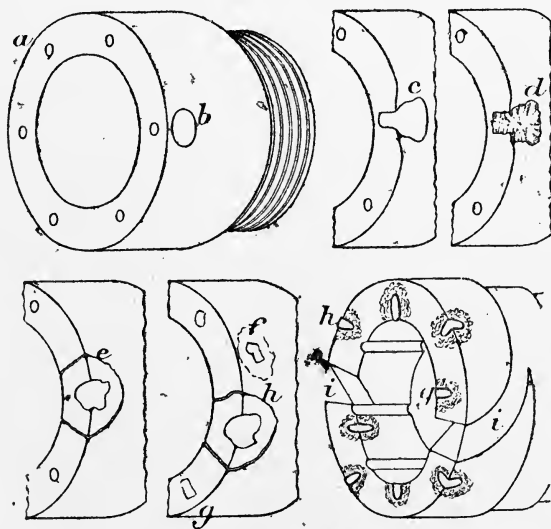

FIG. 73.—SETTING DIAMONDS IN BIT.

measurement is obtained, the metal is drawn up or closed round it as at *e*; this is done by first making a cut, with a blunt-edged chisel, across the face of the bit, about $\frac{1}{8}$ in. from each side of the diamond, and all around it on the outer surface; then, by using a dull-pointed chisel or caulking-tool, the metal is gradually driven towards the diamond.

In order to get the diamond placed to the best advan-

tage, it is often necessary to cut away more metal than it is possible to replace by driving up the original metal on the bit ; in such cases, thin wedges made of horse-shoe nails or copper wire, hammered flat or wedge-shape, should be used to fill up the space around the diamond before the caulking takes place ; many operators prefer to make a bed of copper-foil for seating the carbon in any case. The setter should endeavour to place the diamond in such a position that it will have a sharp cutting edge on the face of the bit, and at the same time leave a broad strong side or surface for the clearance on the outside of the bit, as at *d*, which will obviate much reduction in size of the bit.

The diamond should be held in place by the third finger of the left hand, and the chisel or caulking-tool be held between the thumb and the first and second fingers. First drive up the metal on the face of the bit until it holds the diamond in its proper position ; then the caulking on the sides can be done. Care should be taken that the diamond does not move from its proper position, thereby destroying the gauge or measurement. When the metal begins to bear on the diamond, a finer-pointed tool should be used ; light blows are struck, and the metal is closed in carefully. It is possible to break the diamond by caulking the metal too tightly, and also by driving the metal to fill an opening near the corner of the diamond while the metal may be pressing hard on it at another point ; it is, therefore, necessary to drive the metal so that it will be brought to press uniformly all around.

When the rock is extremely hard, extra diamonds are set on the outside of the bit, as at *f* ; these assist those on the outer edge of the face in maintaining the true diameter or size. All bits should be set so as to be of the same outside and inside diameter as the first one used.

The diamonds are set alternately, inside and outside, as at *g h*: those on the outside cover the outer half of the face, and cut the outside clearance; while those on the inside cover the inner half of the face, and cut the inside clearance for the core to pass up freely.

Some makers fancy a bit with channels cut as at *k*, which are intended to give greater freedom of exit for the mud produced by the machine in operation.

In some important borings executed by Gulland in 1883, the largest crown used was 23 in. diam. (external), and contained 50 carbons having an aggregate weight of over 300 carats. The crown was screwed to the core-tube (see Fig. 74), and the first tube was $22\frac{1}{2}$ in. ext. diam., 30 ft. long, and of wrought iron; above it, with a plate between, was a 5-ft. length of tube intended for receiving the coarser particles brought up with the clearing-water. The boring-rods were drawn-steel tubes $3\frac{1}{2}$ in. outside diam., $\frac{3}{8}$ in. thick, and in 5-ft. lengths, united by steel collars. The consumption of water in this case was 3500 gal. per hour, but it was mostly clarified by settling and used over and over again. The power required was 20 to 40 h.p.

Whenever the drill is withdrawn from the hole, the bit should be carefully examined; if any of the diamonds is found to be loose, or the die is worn away so as to leave some of them unprotected, the metal should be recaulked around them. When the bit is so badly worn that the diamonds are greatly exposed, they should be cut out and reset in a new blank.

If, while drilling, some of the outside diamonds are chipped, so that the size of the hole becomes reduced, when the next bit is introduced that portion of the hole bored after the diamonds were broken should be re-bored, so as to be the full size of the standard bit, as any attempt to

force the new bit down into the reduced hole, by trying to turn the rods with tongs or otherwise, will surely destroy the outside diamonds.

To remove diamonds from an old bit, file a cut across the face of the bit, about $\frac{1}{8}$ in. from each side of the diamond; then chisel the metal back and chip it away until the diamond can be forced out by light taps of the hammer on a small copper rod.

Sometimes carbons are dislodged from their setting, generally through applying too much pressure when passing through hard broken rock. This should be detected by an experienced drill-hand from the sound produced. The dislodged carbon must be recovered as soon as possible, because not only does it impede the work of the drill, and in itself constitute a serious loss, but it may easily cause unseating of the remaining diamonds. To recover lost carbons, a wad of wax or tenacious clay is placed on the end of the drill-rod; this is gently forced into the hole to its extreme limit, and as gently withdrawn.

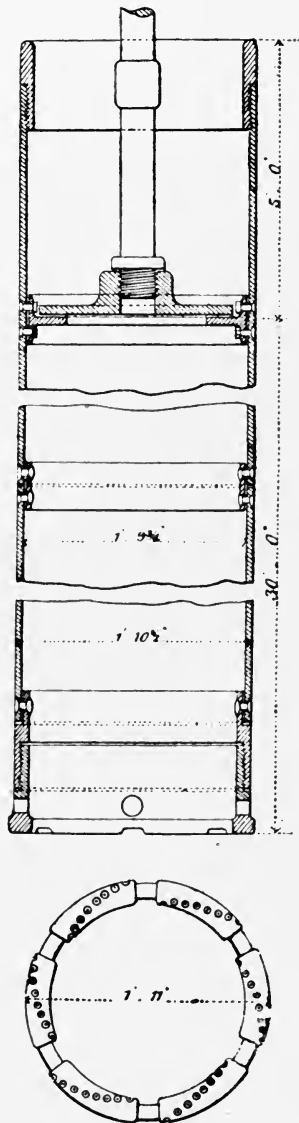

FIG. 74.—GULLAND'S BIT AND TUBE.

The best diamonds are the black amorphous "carbonados" of Brazil, especially those of compact form with well-marked corners. Next to them rank the borts or imperfect gem stones of South Africa. Size may vary between 1 and $3\frac{1}{2}$ carats, according to the bit in use; perhaps the most common is 2 to $2\frac{1}{2}$ carats. Sometimes pieces of corundum, and sapphires which are valueless as gems owing to opacity and bad colour, are coated with graphite and sold as carbons; they accomplish a double fraud, being both heavier (sp. gr. 4 against 3.5) and less hard.

Occasionally delays are caused by breakage of rods, either a fracture of the collar or a stripping of the thread. The remedy is to affix to the upper length a "tap," either in bell form for putting on an external thread, or in plug form for cutting an internal thread, and thus to draw the broken part to surface and replace it.

In deep drilling, it is of great importance to have the core-barrel of sufficient length to avoid frequent lifting as it fills. Height of derrick also influences rate of progress, and should not be less than 50 ft., in order that 40-ft. rods may be unscrewed at a time, this being a maximum convenient length with rods of 2 in. diam. Area of brake surface must be ample, or much delay will be caused by heating.

Electric motors present special advantages for working diamond drills, and have been largely used for that purpose both at surface and underground. A drill working a 2-in. hole, and bringing up a $1\frac{3}{8}$ -in. core, capable of drilling easily to a depth of 600 ft., can be driven by a $2\frac{3}{4}$ -hp. motor, the whole arrangement being compact in the extreme, and suitable for underground or awkward situations where steam could hardly be used. The rapid rotation of the

diamond drill adapts it particularly to electric driving. But the great majority operating in well-boring are run by steam.

Owing to the increasing cost of carbons for boring, the "calyx" drill (which has revolving steel cutters) is coming much into favour. A contrivance for adjusting the driving mechanism of the diamond drill to suit the calyx cutter, so as to make the one machine interchangeable and save enormously in first cost of plant, has been invented by Mr. E. Williams, superintendent of diamond drills in Victoria, and adopted by the Victorian Government. It consists of a simple intermediate gear for reducing the speed in a ratio of 19 to 1, and can be thrown in or out as required.

The combination machine for both percussive and core-drilling is shown in Fig. 75. It is the invention of Mr. C. Isler, and its use is monopolised by his firm. Mounted on wheels and made to take apart, it is exceedingly portable and can be applied in almost any situation. Its consumption of water is ordinarily about 700 gal. per hour for clearing-out purposes; but in traversing non-absorptive strata this is much reduced. Moreover, by settling, the water is rendered fit for repeated use. The machine once placed, it remains a fixture until the hole is finished or abandoned, no matter how many alternations of hard and soft ground may call for change of tools. These changes are made in the space of a minute or so without any derangement of the gear.

The special tubing described on p. 64 is always to be recommended for lining the bore-hole.

Various conditions govern the supply furnished by a well. It may be delivered under such hydrostatic pressure that it will flow readily from the top of the bore, and even

in some instances will be forcibly ejected considerably above it ; and it may require to be pumped, notwithstanding that the volume suffers no diminution by that operation. But cases sometimes occur where no supply appears to be available, despite the fact that the bore is known (from

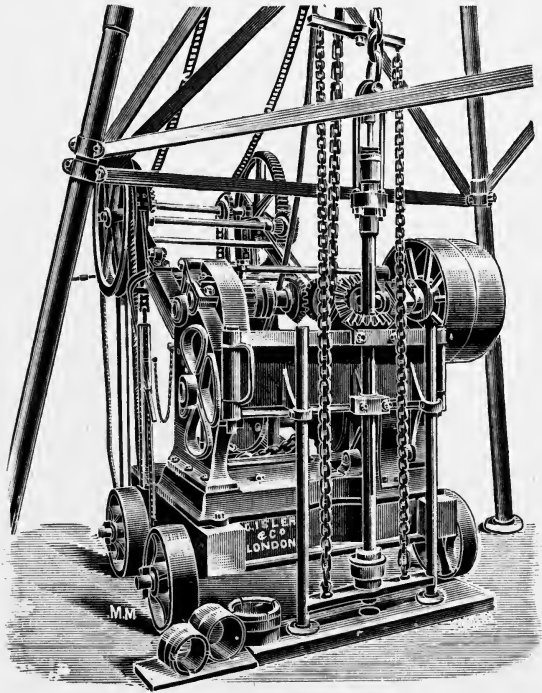

FIG. 75.—COMBINATION MACHINE FOR PERCUSSIVE AND CORE DRILLING.

examination of the core or *débris*) to have entered a water-bearing stratum. In this event, it would be premature to regard the hole as dry. When boring for petroleum, it is indeed a somewhat common experience, and is due to lack of such fissures and joints in the rock as will afford a suffi-

ciently free passage of the fluid from surrounding territory towards the bore-hole.

This failing is remedied by the explosion of a "torpedo" at the bottom of the hole. It consists of a tin canister of suitable dimensions—sometimes the longer the better—filled with a nitro-glycerine compound, such as Nobel's blasting gelatine, primed with a detonator, lowered to the point at which it is to be fired, and discharged by a conductor leading from a small electro-magnet machine. The effect of the very forcible explosion is to thoroughly disturb the adjacent rock and to very much extend any existing line of fissure. Some remarkable results have followed from torpedoing. At a well near Rochester, 15 in. diam. and 300 ft. deep, in compact rocks of the Lower Greensand formation, which refused to yield any water at all when finished, after explosion of an 18-lb. torpedo a flow of 20,160 gal. per hour was started, and this has been constantly maintained ever since. Another example may be quoted of a 7 $\frac{1}{4}$ -in. well, 363 ft. deep, at Gloucester; the effect of firing a single shot may be seen in the frontispiece.

Of the hundreds of wells bored in England, perhaps the most remarkable is that at Bourn, Lincolnshire, which supplies the town of Spalding. It was sunk by C. Isler & Co., in the Oolitic beds, and at 100 ft. it furnished a flow of 1800 gal. per minute at a pressure of 10 lb. to the sq. in., reaching the surface with a rush as depicted in Fig. 76; on continuing the bore for an additional 34 ft., the flow was increased to 3480 gal. per minute, and has permanently remained at this figure. The well is 13 in. diam. At about 66 ft. from surface, springs of chalybeate water were encountered, but these were successfully and completely excluded by the lining-tubes. These last are in three series: first, 10 ft. of 22-in. pipe passing through clay and

entering the limestone ; inside them, commencing a little higher above the surface, 32 ft. of 18-in. tubes, reaching to

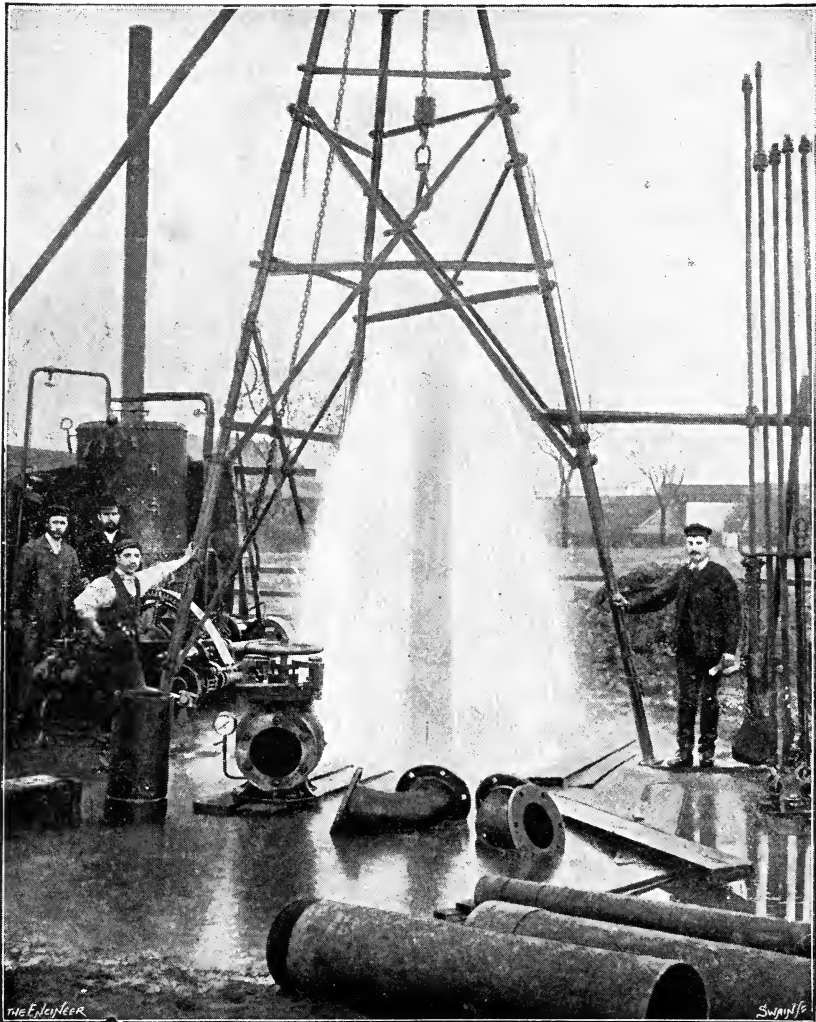

FIG. 76.—THE BOURN WELL.

the hard blue rock of the Oolite ; and finally, again inside and standing somewhat more out of ground, 73 ft. of 13-in., just penetrating into the absorbent stratum, below which point the bore is not lined. The annular spaces between the respective series of pipes are closely filled with a specially-prepared cement, to effectively resist the pressure of (and thereby exclude) the springs of undesirable water from the upper strata.

Another remarkable well bored by the same firm is at Keighley, Yorkshire. It is 250 ft. deep, in the upper beds of the millstone grit, and at 243 ft. it tapped a supply of 15,000 gal. per hour, rising to 40 ft. above the surface. It is lined with 60 ft. of 6-in. tube starting from 1 ft. above ground, and 40 ft. of 5-in. perforated tube commencing at 60 ft. below the surface ; beyond that it is not lined.

In Tables I. and II. are given some details of earlier wells, at Northampton.

TABLE I.

BORING AT KETTERING ROAD, NORTHAMPTON.

Diam. of Crown.	Depth Drilled.	Number of Days Drilling and Extracting.	Average Depth per Day.	Nature of Strata.	Diam. of Core.	Ratio of Core Extracted.
in.	ft.		ft. in.		in.	%
23	77	17	4 6½	Lias clay	19¼	..
20½	97	15	6 5½	„	16¾	..
18	106	16	6 7½	„	14½	..
15¾	55	11	5 0	„	12¼	..
„	68	10	6 9	{ Sandstones and marls }	„	95
„	25	15	1 8	Quartzite	„	100
„	20	5	4 0	{ Limestone and shale }	„	98

TABLE II.

BORING AT GAYTON, SOUTH-WEST OF NORTHAMPTON.

Diam. of Crown.	Depth Drilled.	Number of Days Drilling and Extracting.	Number of Hours Drilling.	Average Depth.		Nature of Strata.	Diam. of Core.	Ratio of Core Extracted.
				Per Day.	Per Hour.			
in.	ft.			ft.	in.		in.	%
18	125	11	104	11 4	1 3	Lias clay	14½	88
15¾	148	13	127	11 4½	1 2	„	12¼	90
13⅝	182	17	183	10 8½	1 0	„	10¾	92
11⅞	117	10	100	11 8	1 2	„	9¼	88
„	63	8	60	8 0	1 0½	{ Red marl and sandstone }	„	64
10¾	215	25	213	8 7	1 0	{ Lower Carboniferous Limestones and shale Sandstones }	7¾	84
							„	68

Of wells recently bored in the London basin by the author, 12 have a depth of less than 300 ft., 22 range from 300 to 350 ft., 18 from 350 to 400 ft., 9 from 400 to 450 ft., and 2 exceed 450 ft. The flow is not less than 1000 gal. per hour in any instance, whilst in 2 cases it amounts to 2000 gal., in 11 to 3000, in 14 to 4000, in 7 to 5000, in 2 to 6000, in 5 to 7000, in 5 to 8000, in 7 to 10,000, in 4 to 12,000, in 1 to 14,000, in 1 to 20,000, and in 1 to 35,000 gal. per hour.

The working costs of diamond-drill bores are subject to very wide variation, dependent upon hardness of rock, delays through accidents, rates of wages, prices of carbons, and so on. The following exemplifications are quoted from Warnford Lock's *Miners' Pocket Book*,* and though they

* Published by E. and F. N. Spon, Limited.

refer in all cases but that of New South Wales to prospecting bores for mineral deposits, and in no instance embrace the item of lining-tubes, they are most instructive as referring to our Australian and South African colonies where the need of water is severely felt and where deep wells must be largely resorted to in the near future.

“Official reports on diamond drilling in New South Wales state the cost at 30s. 4d. per ft. in 1895, and only 11s. 5d. in 1896, the difference being due to shallower work and easier ground. The cost of carbons per ft. bored has varied remarkably, thus:—1883, 3s. 8d.; 1884, 2s. 1d.; 1885, 1s. 5½d.; 1886, 8¾d.; 1887, 1s. 7d.; 1888, 1s.; 1889, 1s. 3d.; 1890, 7¾d.; 1891, 1s. 10d.; 1892, 2s. 2d.; 1893, 3s. 3¾d.; 1894, 9d.; 1895, 3s. 9½d.; 1896, 2s. 1¼d. The actual working cost per ft. in 1895 for a 4-in. bore 299 ft. deep in porphyry was 15s. 2d.; the rate of progress was 9·34 in. per hour; and the core obtained was 87·6 %.

“South African figures are quoted by several authors. Denny states the average at 18s. per ft., on an assumption of 100 ft. a week, and paying drill hands 20s. a day, labourers 2s. 6d., fuel at 20s. a ton, and carbons at 150s. a carat. He says contractors charge 25s. per ft. for first 100 ft., rising 5s. per ft. for each 50 ft.

“Truscott put down 8 holes, of an aggregate depth of 2686 ft., at a cost of 36s. 6d. per ft. One of these holes, having a depth of 597 ft., averaged 19·9 ft. a day, 1¾ in. core, and used 8 h.p. motive force and 1440 gal. water daily; the contractor was paid 30s. a ft. for 500 ft., and 35s. for 97 ft., and the cost of water supply (74l. 18s. 6d.), core watcher (40l. 12s. 6d.), hire of drill (50l.), and sundries (29l. 5s.), was equal to 6s. 6d. a ft.

“The Bezindenville bore, sunk by Chalmers, occupied

212 days, with an average of 17·58 ft. per diem, external delays accounting for 12 days. For the first 2000 ft. the crown was $2\frac{3}{4}$ in. and core $1\frac{7}{8}$ in. diam., and for final 1728 ft., 2 in. and $1\frac{3}{8}$ in. Delays incidental to drilling, repairs, loose carbons, etc., totalled 55 days, or 27 % on 200 days. On 145 days' straightforward drilling, the rate was 25·7 ft. per diem. The time lost in raising and lowering rods was over $\frac{1}{3}$ of the whole. There were used 360 carats of carbons, or between 8 and 9 carats per 100 ft., which at 80s. per carat = 7s. per ft.; wages, including overseer, came to 7s. 7d. per ft.; coal, 260 t., at 20s. = 1s. 1d.; and sundries came to 9d.; or a total of 16s. 5d. per ft., plus interest on 3000*l.* worth of plant.

“According to Wybergh, contract prices vary from 22s. 6d. to 40s. a foot, being usually constant for first 100 ft., and rising 5s. per ft. for each 500 ft. Carbons range from 7*l.* to 13*l.* per carat. On 14 bore-holes put down by contractors, aggregating 7962 ft., the mean cost was 31s. per ft., the range being from 25s. 6d. to 40s.; in addition, water cost nil to 15s., average 5s.; superintendence, 6d. to 7s. 6d., average 2s. 6d.; and sundries, 4d. to 1s. 1d., average $9\frac{3}{4}$ d.; making the total 28s. 3d. to 51s. $10\frac{1}{2}$ d., average 39s. $3\frac{3}{4}$ d. per ft. The water consumption fluctuated between 1300 and 3200 gal. per diem. The rate of boring was 6·38 to 55·27 ft. per diem, and averaged 16·25 ft. per diem, or 0·89 ft. per hour. With contractors the wear of carbons cannot be ascertained; but in another bore of 1328 ft. in quartzite, somewhat more difficult than the average ground, the consumption was 6·92 carats per 100 ft. In this instance the detailed cost was:—carbons, 9s. $9\frac{1}{2}$ d.; hire of drill, 3s. $1\frac{1}{2}$ d.; labour, 11s. $5\frac{1}{2}$ d.; coal, 1s. $5\frac{1}{2}$ d.; stores, 11*l.* $\frac{1}{2}$ d.; superintendence, 1s. 3d.; sundries, 6d.; total, 28s. $6\frac{1}{2}$ d. per ft. In 3 holes put down by a

hand drill, aggregating $318\frac{1}{2}$ ft., through quartzite and diabase, the average rate was 2·03 ft. per diem, or ·309 ft. per hour, and the cost was:—Hire of drill and wages of superintendent, 11s. 3*d.*; wear of carbons, $10\frac{3}{4}$ *d.*; labour, 4s. 10*d.*; sundries, $1\frac{1}{2}$ *d.*; total, 17s. $1\frac{1}{4}$ *d.* per ft.”

CHAPTER X.

RAISING WATER.

THOUGH cases have been cited where deep bores have resulted in a constant stream of water being ejected to and even above the surface of the ground, in the great majority of instances this does not occur, and after the water-bearing strata have been pierced, the level to which the water will rise is at some depth below the surface. For example, the general rule in the London basin is that in tube-wells 400 ft. deep, the water level is 100 to 200 ft. from the top. Some form of pump or lift must therefore be employed to raise a supply. But inasmuch as the water level is dependent upon the horizon at which the intake of rain-water occurs, it remains constant, notwithstanding the rate at which supplies are withdrawn from the well. In fact, it much more commonly happens that the water level is raised than lowered by pumping, as the operation tends to reduce the pressure upon the underground reservoir and to render the conduits more free.

While it would be inconvenient and out of place in this volume to attempt a description of, or even to catalogue, the multifarious forms of pump, from the common domestic article costing a few shillings to the highly complex pumping-engine installed at an outlay of several hundred pounds, a few paragraphs may properly be devoted to that branch of the subject which embraces more particularly the most

modern and approved appliances connected with deep tube-wells.

In country districts, whether the supply be needed for irrigation of crops or for watering stock, too much attention cannot be given to the utilisation of the wind as a motive power for actuating the pump. There are practically no places where a certain amount of wind cannot be counted on at all seasons of the year, and no source of power is so cheaply applied; and the fact that an elevated site for the well is often desirable, so as to secure distribution of the water by gravitation, makes the application of the windmill all the more convenient and satisfactory.

In towns, the employment of the "air-lift" system has much to commend it. Though comparatively unknown in England, it is most extensively used in the United States, where it was invented, and its merits are being rapidly recognised in Continental Europe. Its advantages lie in its simplicity and in the entire absence of working-rods in the bore-hole, thus avoiding all possibility of derangement and hindrance to supply, as well as the jar and noise incidental to pumps. The water is made to flow in a gentle stream, free from pulsation, by the force of a column of air under great compression.

A recent example of the installation of the author's system, at Hyde Park Court Mansions, Knightsbridge is worthy of illustrated description. The well is 10 in. internal diameter, and is bored to a depth of 450 ft. through the London clay and various sand-beds into the chalk and flints, which are reached at a depth of 284 ft. from surface. The depth which the well descends into the chalk is therefore 166 ft. All the upper part of the boring is lined with a 10-in. internal diameter steel tube, which is

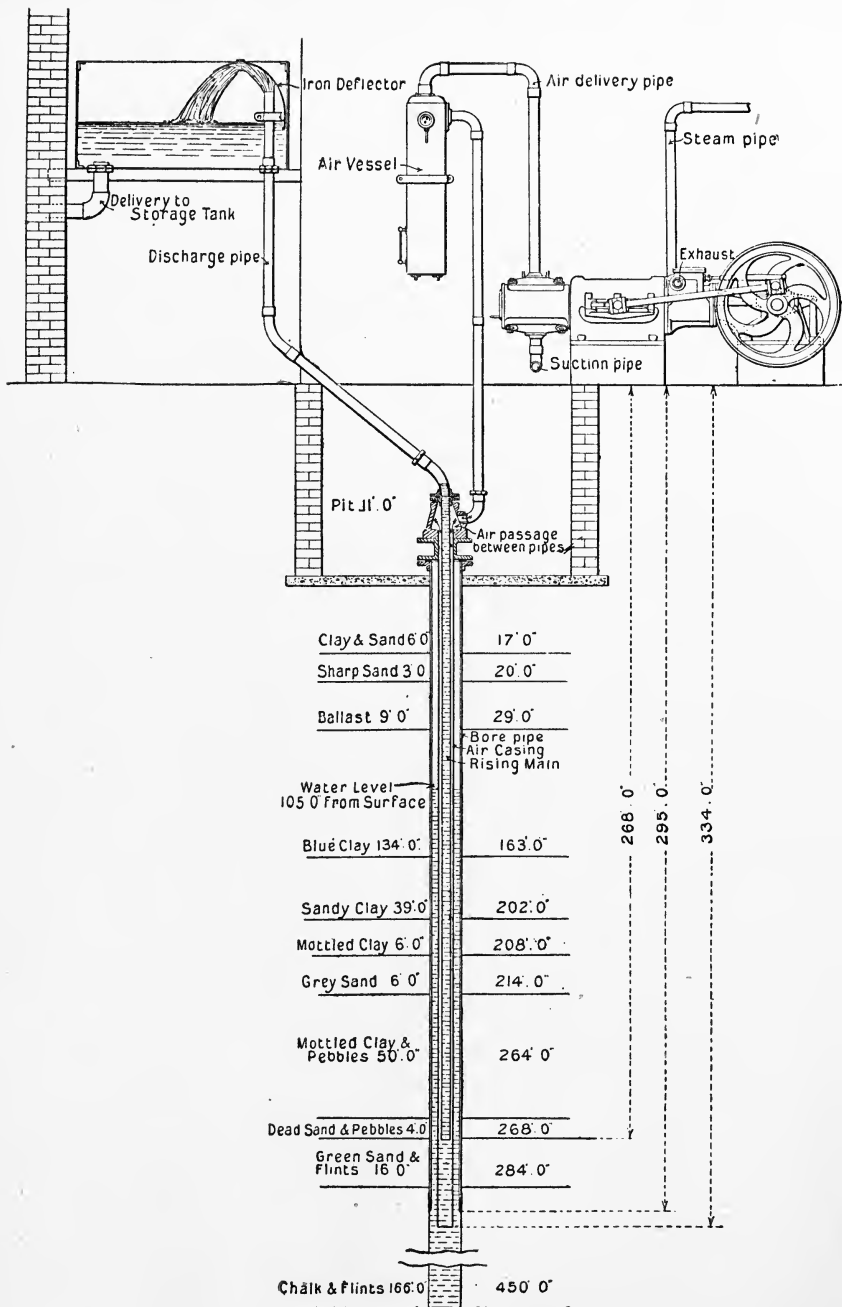

FIG. 77—INSTALLATION OF THE AIR-LIFT SYSTEM.

driven tightly 11 ft. into the chalk. When the well was first sunk, the water-level was found to be 110 ft. from the ground ; but as soon as pumping commenced, it rose 5 ft., and stood at 105 ft., at which level it has since remained. Even when pumping at the rate of 8000 gal. per hour is being carried on, the water-level is unaffected.

The arrangement is shown in Fig. 77. By means of a compressor—actuated by steam in this instance, but just as easily driven by gas or oil engine or an electric motor—air is forced into a receiver, and then conveyed to an annular space between an inner 3-in. pipe which forms the rising main for the water, and an outer 5-in. pipe which is still within the lining-tube of the well. The effect of this pressure is to make the water rise in the central pipe, and this continues till the water-level in the outer pipe has descended to the level of the bottom of this tube. The air then escapes up this tube, taking the water with it and lifting it to the desired height. The size of the central pipe, and the depth to which it must be taken down, are points which have to be carefully arranged to suit each particular case. It must be, for instance, of the right diameter, having regard to the quantity of water to be raised ; and the amount of submergence found necessary determines the air pressure required. If this pipe is too small, the quantity of water lifted will fall off ; if too large, air will be lost. It must also be put down to a certain depth below the level to which the water falls when pumping is going on.

The machinery used consists of a horizontal air-compressor, having a diameter of 10 in. and a stroke of 12 in. With a steam pressure of 60 lb., and when running at 90 revolutions, this compressor is capable of delivering air into the 5-in. tube at a pressure of 70 lb. per square

inch, and of raising 7600 gal. an hour to a height of some 120 ft. At Hyde Park Court the water is first delivered into a receiving tank, whence it flows by gravitation into a further tank situated in another part of the building. When pumping first begins, the water is ejected with some force from the rising main, which is hence surrounded by

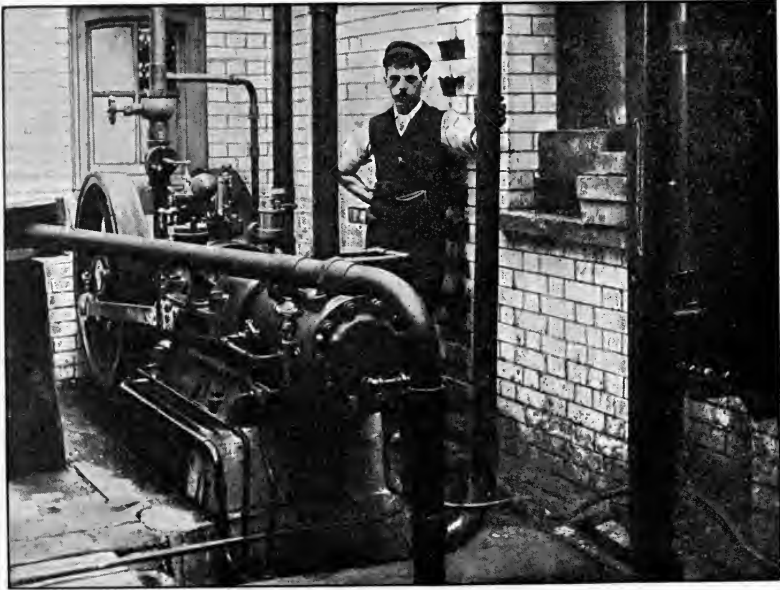

FIG. 78.—AIR-COMPRESSOR FIXED IN ENGINE-ROOM.

a baffle. Very shortly, however, the violence of the discharge abates, and though slight pulsations are noticed, the delivery is practically continuous and regular.

A view of the compressor as fixed in the engine-room is given in Fig. 78, and another of the flow from the outlet of the "lift" in Fig. 79.

Whenever the conditions are suitable the air-lift pump is a very valuable arrangement for pumping from a bore-hole and is not limited to this but is equally useful for a dug



FIG. 79.—FLOW FROM "LIFT."

well or a sump or other situation, the only essential condition being sufficient depth of water to submerge the air and delivery pipe for about half their total length or rather

more according to the lift. Thus, in the case of a bore-hole in which the pumping level stood at 100 feet from the surface the pipes should be submerged about 120 feet below the level, making a total length of 220 feet of pipe, and if the water is required to be delivered above surface a corresponding length of pipe must be submerged. This depth of water required to work in is the only limitation of the system, although it is not recommended for more than about 250 feet total lift; this, however, is an ample lift for most borings for water-supply, and in the greatest number of cases the depth of water is sufficient. On low lifts of only about 40 feet or so a less proportion of submergence is sufficient, but on a greater lift than this, although the pump will work with much less submergence than mentioned, it is only at the cost of pumping an excessive quantity of air and so spoiling the economy. On the other hand, if the submergence employed is greatly in excess, although a less volume of air is necessary, the increased pressure at which it has to be delivered to overcome the head of water above the end of the pipe, causes a greater loss of power than is compensated for by the less volume of air delivered, and the result is again a loss of economy.

The system claims several advantages over all others, and perhaps the chief of these is that there are no valves or any moving parts below surface, the whole arrangement consisting of straight open-ended pipes which cannot by any possibility go wrong or require taking out, the only machinery being the air-compressor which is on the surface and readily accessible. Another point is, that even if a considerable quantity of sand comes in with the water it will not clog the pump, which will easily throw large quantities of sand or mud with the water without

being injured in the least. Also, it is the only system whereby duplicate pumping machinery can be applied to a single bore-hole, a second air-compressor being all that is necessary, thus saving the expense of a duplicate bore-hole.

Another very useful application of this system is for temporary test-pumping plants where it is valuable on account of the ease with which it can be fixed, the self-contained compressor being very simple to put down compared to the heavy gear and engine required for an ordinary deep-well pump.

Another important point is, that it enables larger volumes of water to be lifted from smaller bore-holes than can possibly be lifted by any other kind of pump. Whatever the bore-hole yields it can be obtained by the air-lift pump. For oil wells it should prove indispensable and of the greatest economy and reliance, also for mining purposes.

The cost of pumping at Hyde Park Court is about $1\frac{1}{2}d.$ per 1000 gallons, as against $4d.$ to $6d.$ per 1000 gallons charged by water companies, in addition to which the supply is *certain at all seasons and absolutely pure and cool.*

It will be readily seen that no difficulties are experienced in raising small or large supplies from any depth. It should be borne in mind that one of the most important points to study is the proper submergence of the pump-barrel. It should never be less than 50 ft., and if 100 ft. are available, by all means fix it at the deeper level. Taking this step ensures obtaining a continuous supply, and one not likely to be affected by drought or neighbouring wells. In most instances, the head of water is also likely to be lowered a few feet beyond original level by

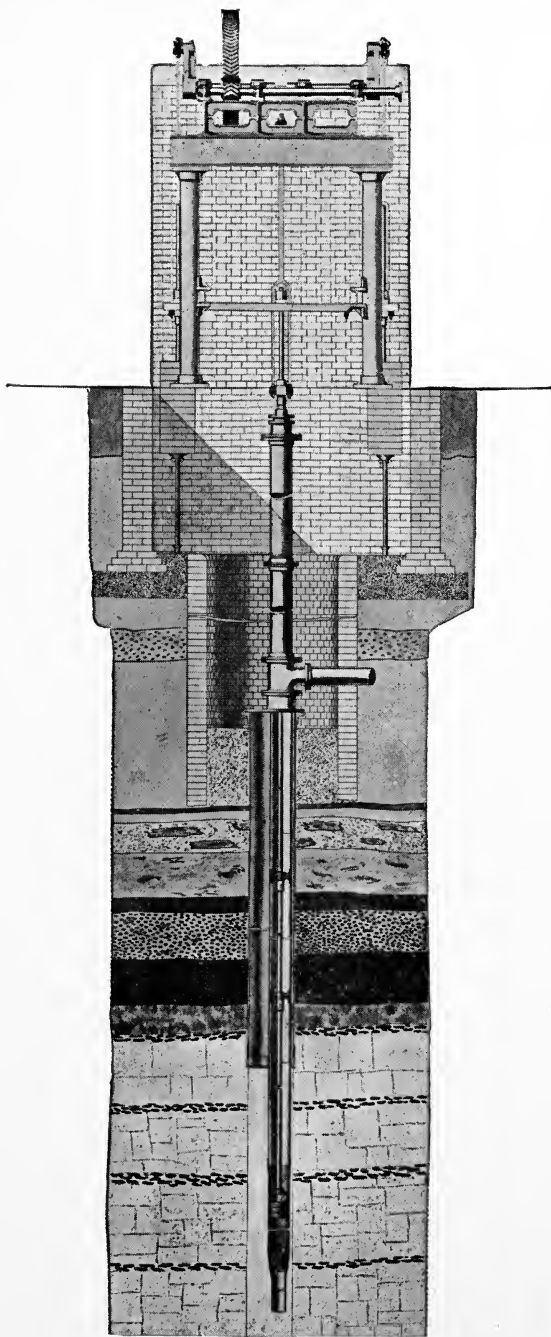

FIG. 80.—DEEP-WELL PUMP PARTLY FIXED IN AN EXISTING DUG WELL.

pumping. Taking the above precaution prevents the pump being in any way affected. See following illustrations.

Fig. 80 illustrates an improved deep well pump fixed in an existing dug well, 400 ft. deep, at Barclay, Perkins & Co.'s Brewery, Southwark, London. The pump reaches 300 ft. from the surface.

Fig. 81 shows a similar pump, at 233½ ft. from surface, in the Idris Co.'s well.

A representation of the author's improved deep well pumps connected to an electric motor is given in Figs. 82 and 83, which represent an artesian bored tube-well, fixed at Showell's Brewery, Langley, near Birmingham. The depth of the bore hole is 600 ft. The pump reaches the depth of 330 ft. from the surface.

In Fig. 84 is an improved deep-well pump for heavy lifts, which can be driven by any power. It represents a bore hole 400 ft. deep, 20 in. diam., with a 16-in. deep-well pump, raising 25,000 gal. per hour, at the pumping station of the East Worcestershire Water-works, Burcot, near Bromsgrove.

A section of the author's improved deep-well pump barrel, with bucket, valve, etc., is seen in Fig. 85. The pump barrels are made of a tough yellow metal, solid drawn, which ensures a sound article and not liable to have blowholes, as is often the case with a cast pump barrel. It will be observed that no loose parts exist in the bucket and valve.

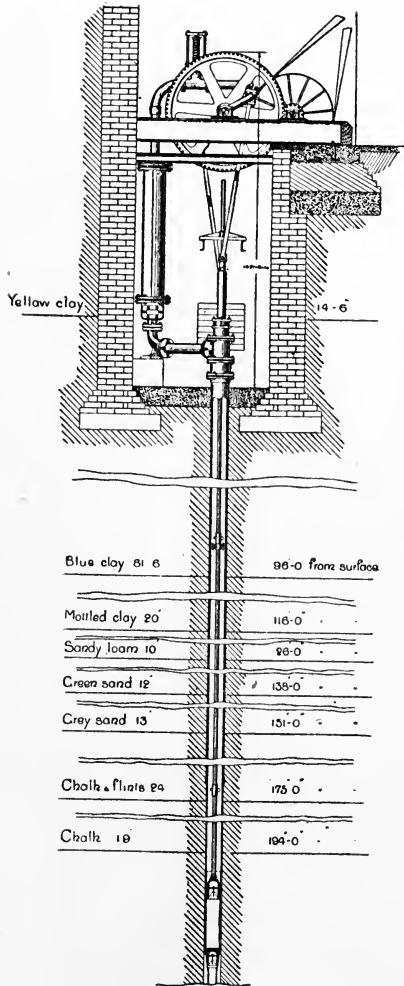

FIG. 81.—IMPROVED DEEP-WELL PUMP FIXED IN BORE-HOLE.

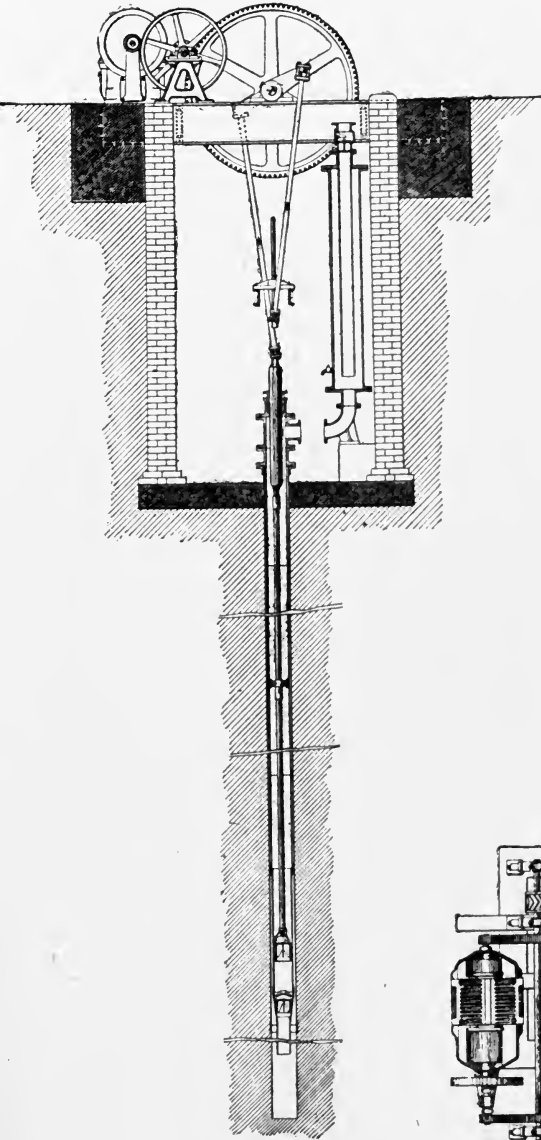

FIG. 82.

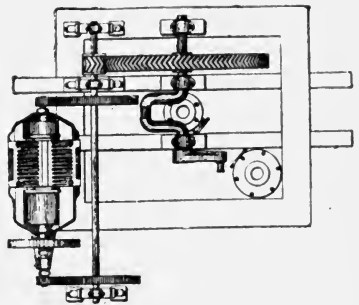
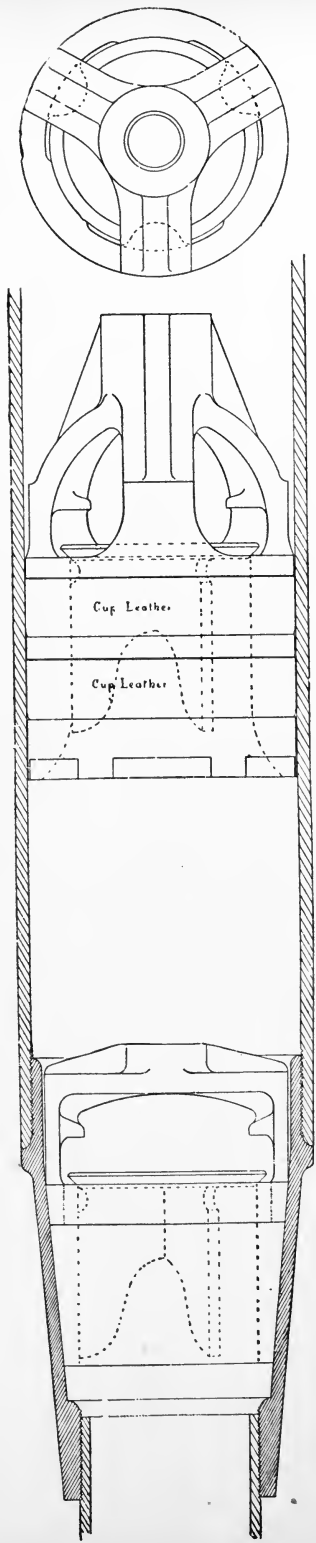
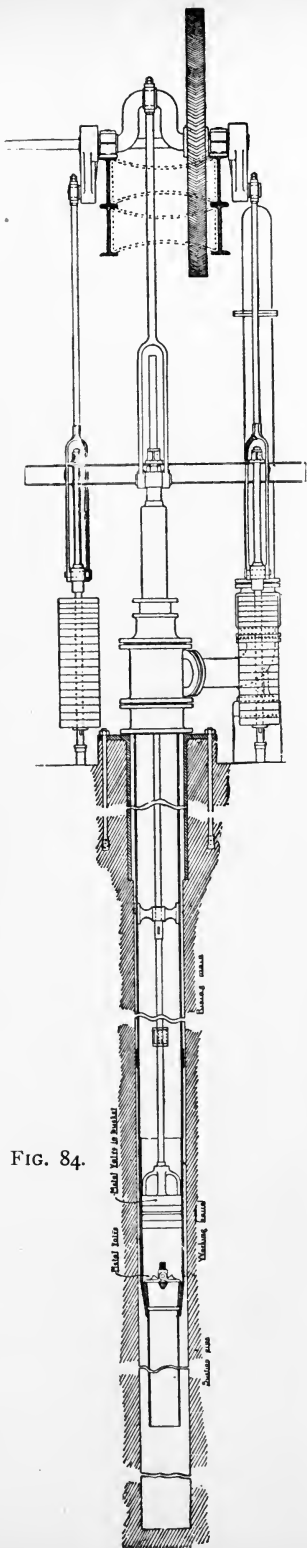

FIG. 83.



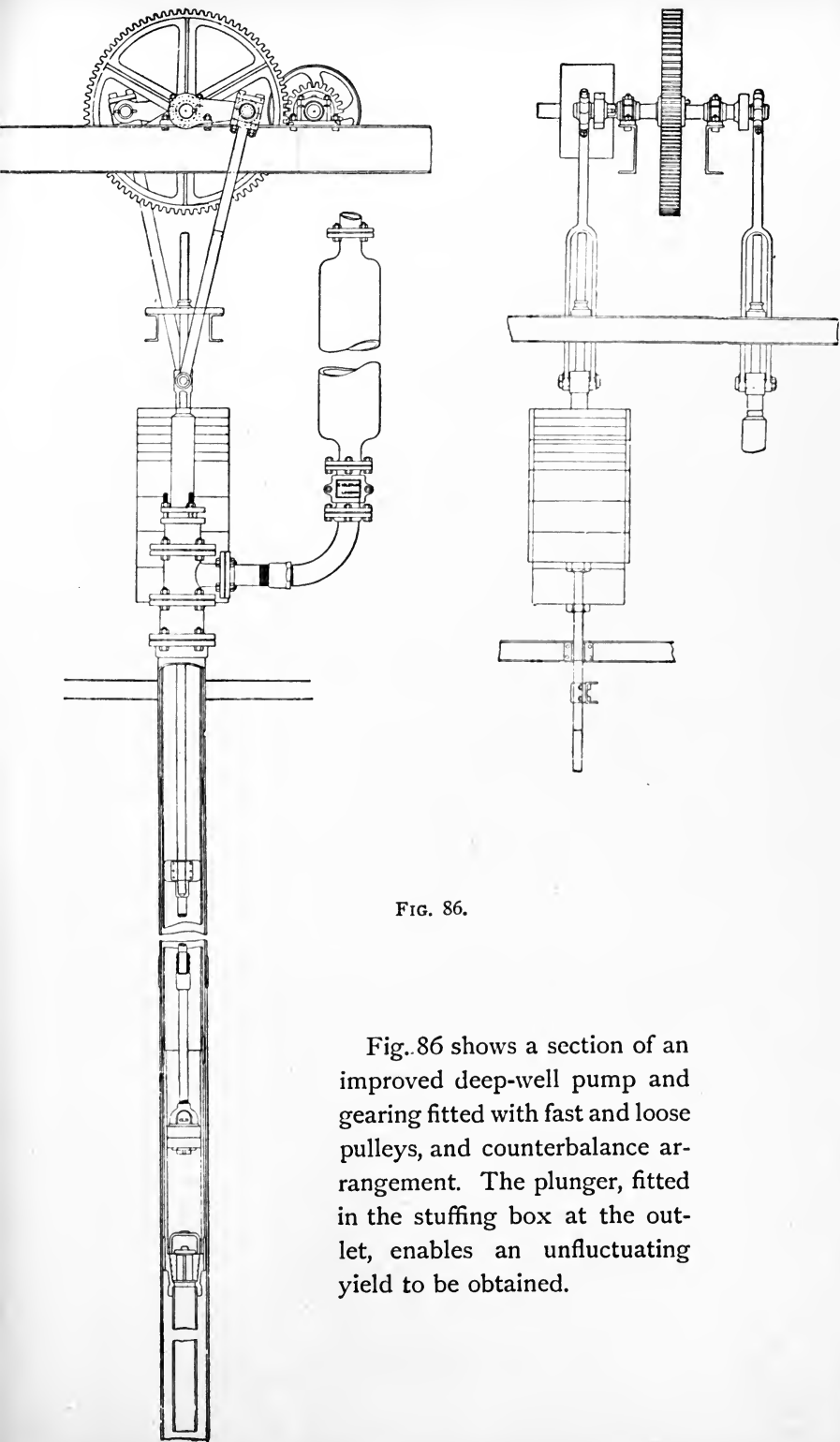

FIG. 86.

Fig. 86 shows a section of an improved deep-well pump and gearing fitted with fast and loose pulleys, and counterbalance arrangement. The plunger, fitted in the stuffing box at the outlet, enables an unfluctuating yield to be obtained.

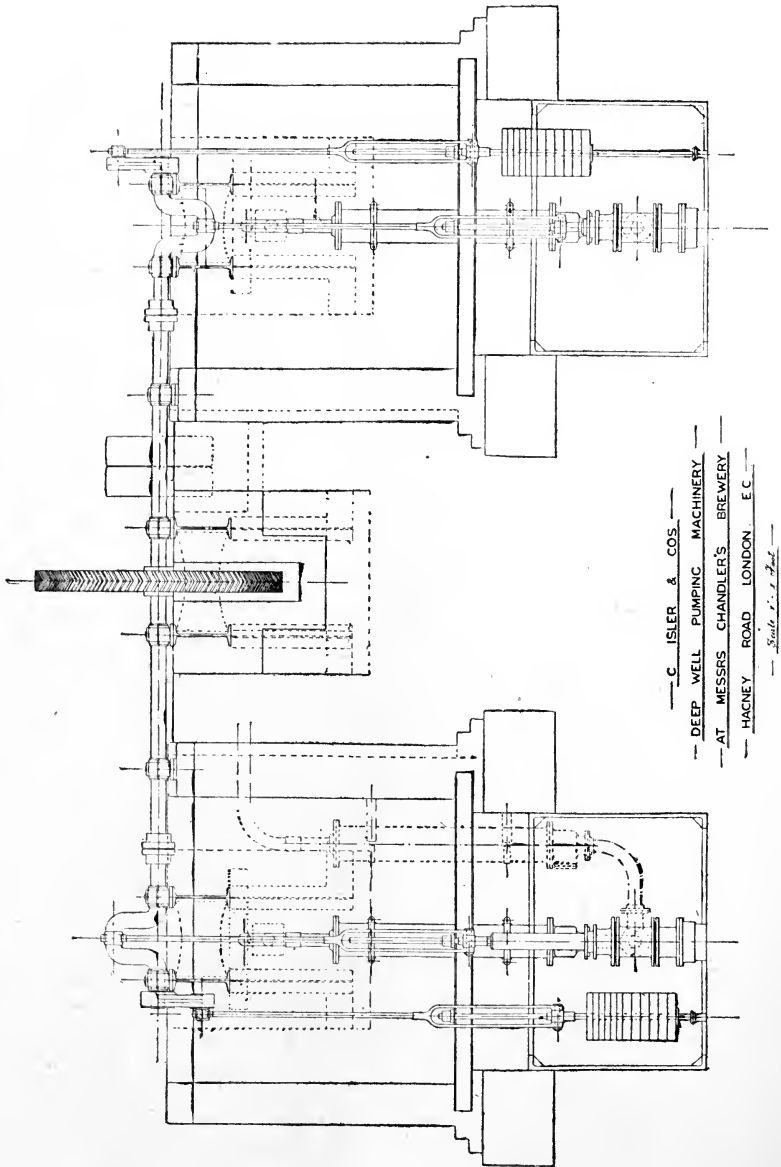

FIG. 87.

Fig. 87 illustrates an improved arrangement showing how large supplies of water can be obtained by coupling two or more wells together, although the water level may be much below 30 ft. from the surface. The deep-well pumps are placed in position and connected; when coupled, there is no occasion to utilise the counterbalance weight,

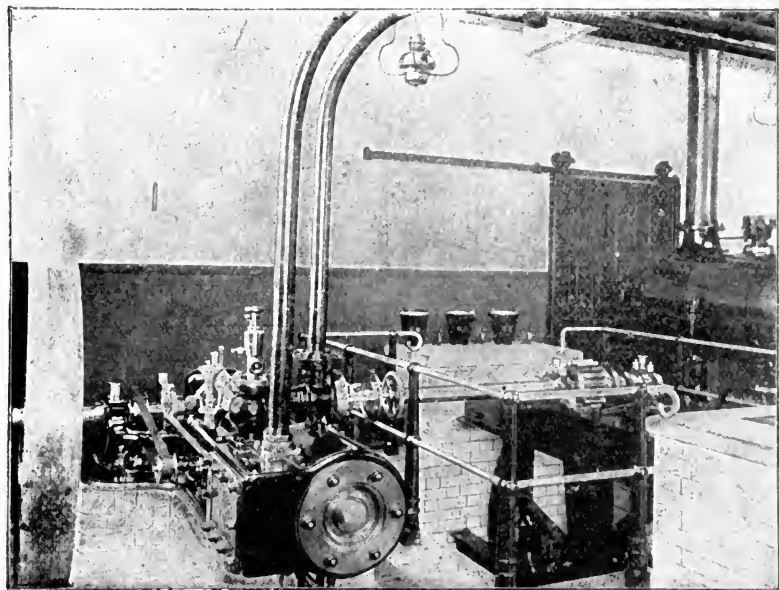

FIG. 88.

as one pump works against the other, equalising the load. The counterbalance arrangement is employed when only one pump is required to work.

Fig. 88 represents the engine-room, deep-well pump gear, etc., fixed to supply the town of Hatfield. It is an 1887 Jubilee gift of the Marquis of Salisbury. The con-

sumption having since considerably increased, another installation of treble the capacity has been put down. Each bore hole is 300 ft. deep, with a deep-well pump fixed in each. The yield of two is at present over 10,000 gal. per hour.

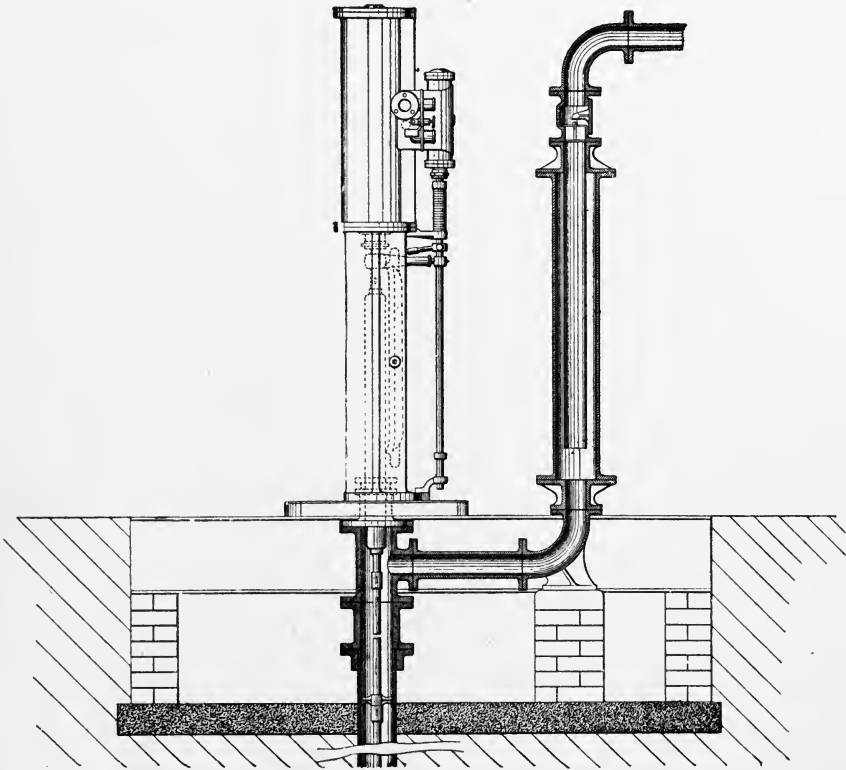

FIG. 89.

Fig. 89 illustrates a type of steam cylinder most adaptable where the space available is limited. It dispenses with gearing and is expeditiously fixed, and can be bolted to timbers.

STANDARD SIZES OF TUBES AND PUMPS IN INCHES.

Bore pipes . . .	3	4	5	6	7 $\frac{1}{4}$	8 $\frac{1}{2}$	10	11 $\frac{1}{2}$	13 $\frac{1}{2}$	15 $\frac{1}{2}$	18	20
Pump mains . . .	2	3	4	5	6	7 $\frac{1}{4}$	8 $\frac{1}{2}$	10	11 $\frac{1}{2}$	13 $\frac{1}{2}$	15 $\frac{1}{2}$	18
Pump barrels . . .	1 $\frac{3}{4}$	2 $\frac{3}{4}$	3 $\frac{3}{4}$	4 $\frac{3}{4}$	5 $\frac{3}{4}$	6 $\frac{3}{4}$	8	9 $\frac{1}{2}$	11	13	15	16

TABLES OF YIELD OF DEEP-WELL PUMPS.

Size of barrel . . .	1 $\frac{3}{4}$ "				2 $\frac{3}{4}$ "			
	9"		1' 3"		9"		1' 3"	
Length of stroke . .	9"		1' 3"		9"		1' 3"	
Number of revolutions } per minute . . . }	18	22	18	22	18	22	18	22
Gallons per hour . .	80	96	131	160	194	240	328	400
Size of barrel . . .	3 $\frac{3}{4}$ "				4 $\frac{3}{4}$ "			
	9"		1' 3"		1' 6"		2' 0"	
Length of stroke . .	9"		1' 3"		1' 6"		2' 0"	
Number of revolutions } per minute . . . }	18	22	18	22	16	20	16	20
Gallons per hour . .	366	447	595	741	1044	1305	1368	1710
Size of barrel . . .	5 $\frac{3}{4}$ "				6 $\frac{3}{4}$ "			
	2' 0"		2' 6"		2' 6"		3' 0"	
Length of stroke . .	2' 0"		2' 6"		2' 6"		3' 0"	
Number of revolutions } per minute . . . }	16	20	16	20	14	18	14	18
Gallons per hour . .	2043	2554	2554	3211	2993	3848	3691	4617
Size of barrel . . .	8"				9 $\frac{1}{2}$ "			
	2' 6"		3' 0"		3' 0"		3' 6"	
Length of stroke . .	2' 6"		3' 0"		3' 0"		3' 6"	
Number of revolutions } per minute . . . }	14	18	14	18	14	18	14	18
Gallons per hour . .	4323	5558	5175	6679	7326	9419	8547	10,988

TABLES OF YIELD OF DEEP-WELL PUMPS—
continued.

Size of barrel . . .	11"				13"			
	3' 0"		3' 6"		3' 0"		3' 6"	
Length of stroke . . .								
Number of revolutions } per minute }	14	18	14	18	13	17	13	17
Gallons per hour . . .	9816	12,624	11,452	14,724	12,738	16,657	14,820	19,380
Size of barrel . . .	15"				16"			
	3' 0"		3' 6"		3' 6"		4' 0"	
Length of stroke . . .								
Number of revolutions } per minute }	13	17	13	17	12	16	12	16
Gallons per hour . . .	16,964	22,180	19,783	25,873	20,726	27,634	23,735	31,647



INDEX.



- ACCIDENT tools, 101
Advantage of steel tubes, 64, 65
Air-lift installation, 176
— — pump, description, 177, 179, 181
— — — electrically driven, 177
— — — for mines, 181
— — — for oil wells, 181
— — — illustrated, 178, 179
— — — worked by gas or any other engine, 177
— — steam pump, 177
— — system for pumping, 175
American boring instructions, 139
— — plant, 132
— — rope-boring tools, 142-144
— — driving plant, 136-150
— — plant pumping, 138
— — system, 131
— section rope-boring tools, 141
Artesian well section, 69
- BORED well, 61
Boring, bucket grapnel, 124
— cost of, 67, 68
— coupling of rod to engine, 79
— emergency tools, 120, 121
— enlarging, 49
— Kind-Chaudron system, 73-83
— head, Mather and Platt, 114
— machine, working instructions, 117, 118
— plant, Mather and Platt, 106-111
— progress, 80, 118, 152
— rods, making of, 49
- Boring shell ball-clack, 78
— — (Kind), 78
— sliding joints, 77
— rod (Kind), 76
— rigs, 49, 50, 51, 53
— showing plan of commencing, 51, 52
— tools, 43-49
— — cost of, 68-72
Bored tube wells, 41
Bourn bored well, 168
- CALY cutter, 165
Chinese system of boring, 41-43
Chisels, making of, 47
Clary's enlarging rimer, 145
Clearing pipes of tube-well, 31, 32, 35
Connecting tube-wells, 38, 39
- DEEPER wells, 34
Deep well pump fittings, 34-36
— — — for heavy lifts, 183
— — — illustrated, 186
— — — improved system, 187
— — — in bore-hole, 182
— — — in well, 181
— — — tables of yield, 191, 192
— — — tubes, 191
— — — with steam cylinder, 190
— — — worked by electric motor, 185
— — — working barrel, 186
Depth of tube well, 34
Description of enlarging hole, 145
Diamonds, 164

- Diamond boring by Gulland, 162
 — — combined machine, 158, 165, 166
 — — cost, 170-173
 — — instructions, 162
 — — Gulland's bit and tube, 163
 — — removal of diamonds, 163
 — — setting carbons, 159-162
 — — system, 157
 — — use of "borts," 159
 — — use of "carbonados," 159
 — — use of electric motors, 164
 — core drilling, 158
 Drawing tube-well in case of failure,
 33, 34
 Drilling with working beam, 145
 Driven tube-wells, 281
 — — well and pump, 37
 — — — in dug well, 37
 — — — prices, 40
 Driving flange for pipes, 63
 Dru boring plant, 93
 — deep boring system, 92
 — free falling device, 97, 98
 — trepan, 95
 Drum curbing, 24, 25
 Dug wells, 23
- ELASTIC suspension for drilling, 150
 Expanding tools, 48
 Explosives, 167
- GAYTON boring, 170
 Geological considerations, 1, 2
 — faults, 4, 5
- HOLLOW hydraulic jack, 67
 — screw jack, 66
 Hyde Park Court well, 175
 Hydraulic washing system, 153-155
- INSERTING bore tubes, 61
 sler's rope percussion arrangement,
 155, 156
- KEIGHLEY bored well, 169
 Kettering boring, 169
- LONDON bored wells, 170
 — — — water level, 174
- MARKING off dug wells, 23
 Marquis of Salisbury's installation, 189
 Materials for driven tube-wells, 39
 — for steining, 25, 26
 Method of boring, 41, 47, 48
 Monkey for driving pipes, 63
- PARIS well, 73
 Percolations through sand-beds, 8, 9
 Petroleum boring, 166, 167
 Pumping (deep well pumps), cost of, 180
 Pumps, prices of wells, 40
- RAINFALL, 9-11
 — Tables, 12-17
 Raising water from any depth, 181
 — — means of, 174
 Riming under tubes, 62, 63
- SAND, running, 124, 125
 — tube for sandy soils, 32
 Sheer frame for deep boring, 54-56
 — legs and steam winch, 60
 — — and windlasses, 57-59
 Shell pump-fast, 123
 — pump, Mather and Platt, 115-117
 — — Mordy's, 144
 Spring drill head, 151
 — — speed, 153
 Steel shoe, 64
 — tubes and appliances, cost of, 72
 — — cutting, 65
 — — means of withdrawing, 65-67
 — — prices, 65
 — socketed tube, 64
 Submergence of deep well pump, 181-
 183
 Swivel ring, 85

- TILTING pump, 32, 33
Trepan at Passy, 75
— (Kind's), 84, 86
— teeth (Kind's), 87
Tubbing suspended from rods, 90, 91
Tubes, cast iron, 125
— forcing by screw jacks, 126-130
Tube-well driving apparatus, 29
— — — instructions, 30-31
Tubes for driven tube-wells, 28, 29
- UNDERPINNING dug wells, 23
- VOLUME of water, 5-7
- WATER, quantity obtained from tube wells, 39
— bearing strata, 17-22
Well, artesian, causes of failure, 3-4
— — definition, 2, 3



JUNE, 1901

A SHORT LIST

OF THE

PUBLICATIONS

OF

E. & F. N. SPON, Ltd.,

125, STRAND, LONDON, W.C.

Full particulars post free on application.

All books are bound in cloth unless otherwise stated.

AGRICULTURE.

- Brooks, C. P.** Cotton : its uses, varieties, Fibre Structure, Cultivation and Preparation for the Market, and as an Article of Commerce, 8vo *net* 7 6
- Lock, C. G. W.** Coffee : its Culture and Commerce in all Countries. Crown 8vo ... 12 6
- Tobacco Growing, Curing and Manufacturing. Crown 8vo 6 0
- Lock, C. G. W., & Newlands Bros.** Sugar : a Handbook for Planters and Refiners, 8vo ... 1 10 0
- Simmonds, P. L.** Hops : their Cultivation, Commerce and Uses. Crown 8vo ... 4 6
- Tropical Agriculture. New edition, 8vo 1 1 0

ARCHITECTURE AND BUILDING.

Allsop, R. O.	The Hydropathic Establishment and its Baths. Demy 8vo	5	0
—————	The Turkish Bath, its Design and Con- struction. Demy 8vo	6	0
—————	Public Baths and Wash Houses. Demy 8vo	6	0
Bales, T.	The Builder's Clerk. Second edition. fcap. 8vo	1	6
Burns, G. J.	Glossary of Technical Terms used in Architecture and the Building Trades. Crown 8vo	3	6
Christie, W. W.	Chimney Design and Theory. Crown 8vo <i>net</i>	12	6
Coleman, T. E.	Stable Sanitation and Con- struction. Crown 8vo	6	0
—————	Architect's Price Book. 32mo, roan, gilt edges		
Fullerton, W.	Architectural Examples in Brick, Stone, Wood and Iron. Second edition, demy 4to	15	0
Hoskins, G. G.	The Clerk of Works' Vade Mecum. Seventh edition, fcap. 8vo	1	6
Hurst, J. T.	A Handbook of Formulæ, Tables and Memoranda for Architectural Surveyors, and others engaged in Building. Fifteenth edition, royal 32mo, roan	5	0
Laxton.	Builders' and Contractors' Tables. Excavator, Earth, Land, Water and Gas. 4to		5	0
Leaning, J.	A complete set of Contract Documents for a Country Lodge. Printed in facsimile of the original. fcap., in case	5	0
—————	Quantity Surveying. Fourth edition, 8vo		15	0
Macey, F. W.	Specifications in Detail. Medium 8vo	1	1

Piranesi. Roman Architecture, Sculpture and Ornament. 200 plates, reproduced in facsimile from the original. Imperial folio, half morocco	5	5	0
Sharpe, E. The Seven Periods of English Architecture, defined and illustrated. Third edition, royal 8vo	12	6	
Spons' Architects' and Builders' Price Book. By W. YOUNG. Edited by CLYDE YOUNG. 8vo, published annually	3	6	
Thwaite, B. H. Our Factories, Workshops and Warehouses, their Sanitary and Fire-Resisting Arrangements. Crown 8vo ,.. ..	9	0	
Tredgold, T., & Hurst, J. T. Elementary Principles of Carpentry. Tenth edition, crown 8vo	12	6	
Wood, W. H. Practical Stair Building and Handrailing. Crown 4to	10	6	
Young, W. The Municipal Buildings, Glasgow. Folio	7	6	

BRIDGES, ROOFS, ETC.

Adams, Hy. Strains in Ironwork. Third edition, crown 8vo	5	0	
———— The Practical Designing of Structural Ironwork. 8vo	8	6	
Bell, G. J. A Practical Treatise on Segmental and Elliptical Oblique or Skew Arches. Royal 8vo <i>net</i>	I	I	0
Bow, R. H. Economics of Construction in relation to Framed Structures. Third thousand. 8vo.	5	0	
Donaldson, W. The Art of Constructing Oblique Arches with Spiral Courses. 8vo	4	0	
———— New Formulæ for the Loads and Deflections of Solid Beams and Girders. Second edition, 8vo	4	6	

Fitzmaurice, M.	Plate Girder Railway Bridges. 8vo	6 0
George, E. M.	Pocket Book of Calculations in Stresses. Royal 32mo, half roan ...	3 6
Grover, J. W.	Estimates and Diagrams of Railway Bridges for Turnpike, Public and Occupation Roads, with Form for Calculating Quantities in Skew Structures, etc. Second edition, folio	1 11 6
————	Iron and Timber Railway Superstruc- tures and General Works. Folio ...	2 2 0
Heaford, A. S.	Strains on Braced Iron Arches and Arched Iron Bridges. 8vo	6 0
Johnson, F. R.	Stresses in Girder and Roof Frames for both dead and live loads by simple Multiplication, etc. Crown 8vo	6 0
Newman, J.	Notes on Cylinder Bridge Piers and the Well System of Foundations, 8vo ...	6 0
Olander, E.	A New Method of Graphic Statics applied in the Construction of Wrought Iron Girders. Small folio	10 6
Ritter, A.	Elementary Theory and Calculation of Iron Bridges and Roofs. Translated from the Third German Edition by H. R. SANKEY. 8vo	15 0
Stoney, B. B.	The Strength and Proportion of Rivetted Joints. 8vo	5 0
Walmisley, A. T.	Examples of Iron Roofs. Small folio, half Morocco. <i>Third Edition in preparation</i>	

CHEMISTRY, *see* INDUSTRIAL CHEMISTRY.

CIVIL ENGINEERING.

IRRIGATION, SURVEYING, WATERWORKS.

Allen, J. R.	Theory and Practice in the Design and Construction of Dock Walls. Crown 4to	6 0
---------------------	--	-----

Bligh, W. G. Notes on Instruments best suited for Engineering Field Work in India and the Colonies. 8vo	7	6
Buckley, R. B. Irrigation Works in India and Egypt. Imperial 8vo	3	3 0
Codd, W. Land Area Tables. Square 16mo, on a sheet mounted on linen and bound in cloth	3	6
Codrington, T. The Maintenance of Macadamised Roads. Second Edition, 8vo	7	6
Cordeiro, F. J. B. The Barometrical Determination of Heights. Crown 8vo, limp leather	4	6
Coventry, W. B. On Curved Masonry Dams. 8vo sewed	2	0
————— A Practical Method of Determining the Profile of a Masonry Dam. 8vo, sewed...	2	0
————— The Stresses on Masonry Dams (oblique sections), 8vo, sewed	2	6
Cunningham, D. Tables for facilitating the Calculation of Earthworks in the construction of Railways, Roads, Canals, Dams, etc. Royal 8vo	10	6
Cutler, H. A., & Edge, F. J. Tables for Setting out Curves from 101 to 5000 feet radius. Royal 32mo	2	6
De Salis, H. R. A Chronology of Inland Navigation in Great Britain. Crown 8vo	4	6
Gripper, C. Railway Tunnelling in Heavy Ground. Royal 8vo	7	6
Holloway, T. Levelling and its General Application. Second Edition, 8vo	5	0
Jeans, J. S. Waterways and Water Transport in different Countries. 8vo	14	0
Matheson, E. Aid Book to Engineering Enterprise. Third edition, medium 8vo, buckram	1	4 0

Matheson & Grants' Handbook for Engineers. Second edition, royal 32mo, sewed, gilt edges	2 0
Merrett, H. S. Practical Treatise on the Science of Land and Engineering Surveying. Fifth edition, revised by G. W. USILL. Royal 8vo	12 6
Middleton, R. E., & Chadwick, O. A Treatise on Surveying. Two vols., royal 8vo, <i>each</i> ...	10 6
Molesworth, Sir G. L., & H. B. A Pocket Book of Useful Formulæ and Memoranda for Civil and Mechanical Engineers. Twenty- fourth edition, 32mo, roan, gilt edges ...	6 0
Molesworth & Hurst. The Pocket Books of SIR G. L. MOLESWORTH & J. T. HURST, printed on India paper and bound in one Vol. Royal 32mo, Russia, gilt edges	12 6
Newman, J. Metallic Structures; Corrosion and Fouling and their Prevention. Crown 8vo	9 0
———— Earthwork Slips and Subsidences on Public Works. Crown 8vo... ..	7 6
———— Scamping Tricks and Odd Knowledge occasionally practised upon Public Works. Crown 8vo	2 6
Penman, W. Land Surveying on the Meridian and Perpendicular System. 8vo ...	8 6
Roberts, A. H. Diagrams for the Graphic Calculation of Earthwork Quantities. Ten cards, fcap., in cloth case <i>net</i>	10 6
Spons' Dictionary of Engineering, Civil, Me- chanical, Military & Naval. Eight divisions, super-royal 8vo	5 8 0
Complete in 4 Vols. with supplement ...	7 5 0
Ditto ditto half Mor., top edge gilt ...	9 0 0
Stanley, W. F. Surveying and Levelling Instruments, theoretically and practically described. Third edition, crown 8vo ...	7 6
Tate, J. S. Surcharged and different Forms of Retaining Walls. 8vo, sewed	2 0

Tudsberry, J. H. S. & Brightmore, A. W.	The Principles of Waterworks Engineering. Second edition, medium 8vo	1 5 0
Wells, W. H.	Hints on Levelling Operations. Second edition, 8vo sewed	1 0
Wheeler, W. H.	The Drainage of Fens and Low Lands by Gravitation and Steam Power. 8vo	12 6
Willcocks, W.	Egyptian Irrigation. Second edition, royal 8vo	1 10 0

DRAWING.

GEOMETRY—GRAPHIC STATICS.

Alexander, B.	The Ornamental Penman's Engraver's, Sign Writer's, and Stonecutter's Pocket Book of Alphabets. Oblong 12mo, sewed	6
Andre, G. G.	The Draughtsman's Handbook of Plan and Map Drawing. Crown 4to	9 0
Atkinson, E. H. de V.	A Text Book of Practical Solid Geometry. 8vo	7 6
Binns, W.	Elementary Treatise on Orthographic Projection. Twelfth edition, 8vo	9 0
————	Second Course of Orthographic Projec- tion. Fourth edition, 8vo	10 6
Clarke, G. S.	The principles of Graphic Statics Third edition, 4to	12 6
Cromwell, J. H.	A System of Easy Lettering. Fourth thousand, oblong 8vo	2 6
Halliday, G.	A First Course of Mechanical Drawing (Tracing), oblong 4to, sewed	2 0
Ott, K. Von.	The Elements of Graphic Statics translated by G. S. CLARKE. Crown 8vo	5 0
Stanley, W. F.	A Descriptive Treatise on Mathematical Drawing Instruments. Seventh edition, crown 8vo	5 0

ELECTRICAL ENGINEERING.

Allsop, F. C. Electric Bell Construction. Second edition, crown 8vo	3	6
———— Induction Coils and Coil Making. Third edition, crown 8vo	3	6
———— Practical Electric Bell Fitting. Ninth edition. Crown 8vo	3	6
———— Telephones: their Construction and Fitting. Sixth edition, crown 8vo	3	6
Andrews, T. Thermo-electric Reactions and Currents between Metals in Fused Salts. 8vo, sewed	1	0
Crocker, F. B. Electric Lighting: A Practical Exposition of the Art.		
Vol. I. The Generating Plant. Royal 8vo		12	6
Vol. II. Distributing Systems & Lamps. Royal 8vo	12	6
Cushing, Jr., H. C. Standard Wiring for Electric Light and Power. New edition, crown 8vo, limp leather <i>net</i>	4	6
Fahie, J. J. A History of Electric Telegraphy to the year 1837. Crown 8vo	9	0
Fleming, J. A. Magnets and Electric Currents. Crown 8vo	7	6
Halliday, Geo. Notes on design of Small Dynamo. Second edition, 8vo	2	6
Haskins, C. D. Transformers: their Theory, Construction, and Application simplified. Crown 8vo	4	6
Heaphy, M. The Phoenix Fire Office Rules for Electric Light Installation and Electrical Power Installation. Twenty-sixth edition, 8vo, sewed		6
Hedges, K. American Electric Street Railways: their Construction and Equipment. Post 4to		12	6

Hoskiær, Col. V. Testing Telegraph Cables. Third edition, crown 8vo	4	6
Hughes, N. The Magneto-Hand Telephone. Square 16mo	3	6
Inst. of Electrical Engrs. General Rules recommended for Wiring for the Supply of Electrical Energy. 8vo, sewed		6
Kempe, H. R. A Handbook of Electrical Test- ing. Sixth edition, demy 8vo	18	0
Langdon, W. E. The Application of Electricity to Railway Working. 8vo	10	6
Lintern, W. The Motor Engineer's & Electrical Worker's Handy-book. 12mo <i>net</i>	2	0
Maycock, W. P. Practical Electrical Notes and Definitions. Second edition, royal 32mo	2	0
Ditto ditto French morocco, gilt edges		3	0
Nichols, E. L. The Galvanometer. Royal 8vo, sewed	4	6
Norrie, H. T. Induction Coils. Second edition, crown 8vo <i>net</i>	4	6
Parker, H. C. A Systematic Treatise on Elec- trical Measurements. 8vo	4	6
Practical Electricians. A Universal Handybook on Every Day Electrical Matters. Sixth edition, 8vo	3	6
Reagan, H. C. Electrical Engineers' & Students' Chart and Handbook of the Brush Arc Light System. 8vo	4	6
Reed's Electric Lighting for Steamers and its Management. Crown 8vo, <i>net</i>	2	6
Sprague, J. T. Electricity: its Theory, Sources and Applications. Third edition, crown 8vo		15	0
Thom, C., & Jones, W. H. Telegraphic Connections. Oblong 8vo	7	6
Thompson, E. P., & Anthony, W. A. Röntgen Rays and Phenomena of the Anode and Cathode. 8vo	7	6

Thompson, S. P.	Dynamo Electric Machinery. <i>Seventh Edition in preparation</i>		
————	Latest Dynamo Electric Machines. Demy 8vo	4	6
————	The Electro-Magnet and Electro Mag- netic Mechanism. <i>Third Edition in the Press</i>		
————	PHILIPP REIS, Inventor of the Tele- phone: a Biographical Sketch. 8vo, cloth	7	6
————	Polyphase Electric Currents and Altern- ate Current Motors. Second edition, demy 8vo	I	I 0
Thompson, S. P., & Thomas, E.	Electrical Tables and Memoranda. 64mo, roan, gilt edges	I	0
	Ditto ditto, in celluloid case	I	6

HOROLOGY

Britten, F. J.	The Watch and Clock Maker's Handbook, Dictionary and Guide. Ninth Edition. Crown 8vo <i>net</i>	5	0
————	Former Watch and Clock Makers and their Work. Crown 8vo <i>net</i>	5	0
————	Old Clocks & Watches & their Makers. Demy 8vo <i>net</i>	10	0
————	The Springing & Adjusting of Watches. Crown 8vo <i>net</i>	3	0
Immisch, M.	Prize Essay on the Balance Spring and its Isochronal Adjustments. Crown 8vo	2	6
Nelthropp, H. L.	Treatise on Watchwork, Past and Present. Crown 8vo	6	6

HYDRAULICS.

PUMPS, WATER WHEELS.

Bjorling, P. R.	Pumps: Historically, Theor- etically and Practically Considered. Second edition, crown 8vo	7	6
------------------------	---	---	---

Bjorling, P. R.	Pump Details. Crown 8vo ...	7	6
————	Practical Handbook on Direct-Acting Pumping Engine and Steam Pump Construction. Crown 8vo... ..	5	0
————	Pumps and Pump Motors: A Manual for the use of Hydraulic Engineers. Two vols. royal 4to	3	3 0
————	Practical Handbook on Pump Construction. Second edition, crown 8vo ...	5	0
————	Water or Hydraulic Motors. Crown 8vo	9	0
Blaine, R. G.	Hydraulic Machinery, with an Introduction to Hydraulics. Demy 8vo ...	14	0
Box, T.	Practical Hydraulics. Twelfth edition, crown 8vo	5	0
Colyer, F.	Hydraulic, Steam, and Hand Power Lifting and Pressing Machinery. Second edition, imperial 8vo	1	8 0
————	Pumps and Pumping Machinery—		
	Vol I. Second edition, 8vo	1	8 0
	Vol II. Second edition, 8vo	1	5 0
Cullen, W.	Practical Treatise on the Construction of Horizontal and Vertical Waterwheels. Second edition, small 4to	5	0
Davey, H.	Description of the Differential Expansive Pumping Engine. 8vo ...	2	0
De Salis, R.	Tables giving Hydraulic Mean Depth & Area of Circular Sewers. 8vo, sewed	1	0
Donaldson, W.	Donaldson's Poncelet Turbine and Water Pressure Engine and Pump. 4to	5	0
————	Principles of Construction and Efficiency of Waterwheels. 8vo ...	5	0
Hennell, T.	Hydraulic and other Tables for purposes of Sewage & Water Supply. Crown 8vo	5	0

Hick, J. Experiments on the Friction of the Leather Collar in Hydraulic Presses. 8vo, sewed.	1 0
Higham, T. Hydraulic Tables for Finding the Mean Velocity and Discharge in Open Channels. Second edition, super-royal, 8vo	7 6
Silk, A. E. Tables for Calculating the Discharge of Water in Pipes for Water & Power Supplies. Indexed at side for ready reference. Crown 8vo	5 0
Stone, T. W. Simple Hydraulic Formulæ. Crown 8vo	4 0

INDUSTRIAL CHEMISTRY AND MANUFACTURES.

Bater, C. H. Brewing Calculations, Gauging & Tabulation. 64mo, roan, gilt edges ...	1 6
Bayley, T. A Pocket Book for Chemists, Chemical Manufacturers, Metallurgists, Dyers, Distillers, etc. Seventh edition, Royal 32mo, roan, gilt edges	5 0
———— A Pocket Book for Pharmacists, Medical Practitioners, Students, etc., Royal 32mo, roan, gilt edges	5 0
Brooks, C. P. Cotton Manufacturing. Crown 8vo, cloth <i>net</i>	2 6
Brooks, C. P. Weaving Calculations. Crown 8vo, cloth	2 6
Burns, W. Illuminating and Heating Gas. A Manual of Manufacture of Gas from Tar, Oil etc., etc. Crown 8vo	5 0
Carpenter, W. L., & Leask, H. A Treatise on the Manufacture of Soap and Candles, Lubricants and Glycerine. Second edition, crown 8vo	12 6
Cross, C. F., & Bevan, E. J. A Text Book of Paper Making. Second edition, crown 8vo	12 6

Deerr, N. Sugar House Notes and Tables. 8vo <i>net</i>	10 6
Dubelle, G. H. The "non plus ultra" Soda Fountain Requisites of Modern Times. A Practical Receipt Book for Druggists, Chemists, etc. Crown 8vo <i>net</i>	4 6
Foster, J. Treatise on the Evaporation of Saccharine, Chemical & other Liquids by the Multiple System in Vacuum and Open Air. Second edition, 8vo	1 1 0
Graham, D. A. A Treatise on the Comparative Commercial Values of Gas Coals and Cannels. 8vo	4 6
Graham, M. Practical Hints on the Working and Construction of Regenerator Furnaces. fcap. 8vo., leather	3 0
Hansen, E. C. Practical Studies in Fermentation, translated from the German by A. K. MILLER. Ph. D. 8vo	12 6
Hanssen, C. J. T. Reform in Chemical and Physical Calculations. Demy 4to <i>net</i>	6 6
Hodgetts, E. A. B. Liquid Fuel for Mechanical and Industrial Purposes. 8vo	5 0
Hornby, J. The Gas Engineer's Laboratory Handbook. Crown 8vo	6 0
Ingle, H. & H. The Chemistry of Fire and Fire Prevention. Crown 8vo	9 0
Lee, D. Manual for Gas Engineering Students. 18mo	1 0
Lovibond, T. W. Brewing with Raw Grain. Crown 8vo	5 0
Procter, H. R. Leather Industries: Laboratory Book on Analytical & Experimental Methods. Demy 8vo	9 0
Redwood, I. I. Theoretical and Practical Ammonia Refrigeration. Third edition, square 16mo	4 6

Richards, W. Practical Treatise on the Manufacture and Distribution of Coal Gas. Demy 4to	1 8 0
Scammell, G., & Collyer, F. Breweries and Maltings. Second edition, 8vo	...	12 6
Speyers, C. L. Text Book of Organic Chemistry. Demy 8vo	9 0
Spons' Encyclopædia of the Industrial Arts, Manufactures and Commercial Products. Super-royal 8vo	
In 2 Vols., cloth	3 10 0
,, 5 Divisions, cloth	3 11 6
,, 2 Vols. half Morocco, top edge gilt	4 10 0
Standage, H. C. The Practical Polish and Varnish Maker. Crown 8vo	6 0
Streatfield, F. W. Practical Work in Organic Chemistry. Crown 8vo	3 0
Terry, G. Pigments, Paints and Painting. Crown 8vo	7 6
Van Eijndhoven, A. J. A Comparison of the English and French Methods of Ascertaining the Illuminating Power of Coal Gas. Crown 8vo	4 0
Wein, E., & Frew, W. Tables for the Quantitative Estimation of the Sugars. Crown 8vo	6 0
Workshop Receipts. For the use of Manufacturers, Mechanics and Scientific Amateurs. Crown 8vo, 5 Vols each	5 0
First Series. Miscellaneous.	...	
Second Series. Chemical Manufactures.		
Third ,, Electrical & Metallurgical		
Fourth ,, Handicrafts and Mechanical Subjects.	...	
Fifth ,, Miscellaneous.	...	

MARINE ENGINEERING AND NAVAL ARCHITECTURE.

Barnaby, S. W. Marine Propellers. Fourth edition, demy 8vo	<i>net</i>	10 6
Bartley, B. C. The Marine Engineer's Record Book : Engines. 8vo, roan	<i>net</i>	5 0
The Engineer's and Draughtsman's Data Book for Workshop and Office use. Third edition, crown 8vo, roan	3 0
Franklin, A. C. Yachting Hints, Tables and Memoranda. Waistcoat pocket size, 64mo, roan, gilt edges	1 0
Ditto ditto in celluloid case			1 6
Haldane, J. W. C. Steamships and their Machinery from first to last. 8vo	15 0
Hogg, A. Tables for Constructing Ships' Lines. Second edition, 8vo	7 0
Hovgaard, G. W. Submarine Boats. Crown 8vo	5 0
Jordan, C. H. Tabulated Weights of Angle, Tee, Bulb, Round, Square, and Flat Iron and Steel for the use of Naval Architects, Ship-builders, &c. Fifth edition, French morocco, gilt edges			7 6
Jordan, C. H. Particulars of Dry Docks on the river Thames. On a sheet folded in cloth. 18mo	2 6
Little, H. The Marine Transport of Petroleum. Crown 8vo	10 6
Main, J. The Progress of Marine Engineering from the time of Watt to the present day. Crown 8vo	7 6
Reed's Engineers' Handbook to the Board of Trade Examinations for certificates of Competency as First and Second Class Engineers. Seventeenth edition, 8vo	<i>net</i>	14 0

Reed.	The key to the Seventeenth edition of REED'S ENGINEERS' HANDBOOK, 8vo	<i>net</i>	7	6
—	Examination Papers for Extra First Class Engineers. Third edition, 8vo	<i>net</i>	14	0
—	Polyglot Guide to the Marine Engine in English, French, German and Norsk. Oblong 8vo <i>net</i>	10	0
—	Marine Boilers. Second edition, crown 8vo <i>net</i>	4	6
—	Useful Hints to sea-going Engineers. Third edition, crown 8vo <i>net</i>	3	6
—	Drawing of the Triple Expansion Engine and the Pipe Arrangements. On 2 sheets in case <i>net</i>	3	6
—	Drawing of a Compound Engine in case <i>net</i>	1	6

MATERIALS.

Box, T.	Practical Treatise on the Strength of Materials. Third edition, crown 8vo	...	18	0
Britton, T. A.	Treatise on the Origin, Progress, Prevention and Cure of Dry Rot in Timber. Crown 8vo	7	6
Butler, D. B.	Portland Cement: its Manufacture, Testing and Use. 8vo	18	0
Calcare.	Cement Users' and Buyers' Guide. 32mo, leather <i>net</i>	2	6
Delano, W. H.	Twenty years' practical ex- perience of Natural Asphalt and Mineral Bitumen. Crown 8vo, parchment	...	2	0
Grant, J.	Experiments on the Strength of Cement. 8vo	10	6
Heath, A. H.	A Manual of Lime and Cement. Crown 8vo	6	0
Luard, C. E.	Stone: how to get it and how to use it. 8vo	2	0
Newman, J.	Notes on Concrete and Works in Concrete. Second edition, crown 8vo	...	6	0

Paterson, M. M.	The Testing of Pipes and Pipe-joints in the open trenches.	8vo, sewed	2	0
Redwood, I. I.	Lubricants. Oils and Greases.	8vo	4	6
————	A Practical Treatise on Mineral Oils and their By-Products.	Demy 8vo	15	0
Stoffler, E.	Silico-Calcareous Sandstones.	8vo, sewed	4	0

MATHEMATICS.

Blaine, R. G.	Quick and Easy Methods of Calculating.	16mo, leather	2	6
Byrne, O.	General Method of Solving Equations of all Degrees.	8vo, sewed	1	0
Graham, J.	Elementary Treatise on the Calculus for Engineering Students.	Second edition, crown 8vo	7	6
Higgs, P.	Algebra, Self-Taught.	Third edition, crown 8vo	2	6
Ormsby, M. T.	Elementary Practical Mathe- matics.	Demy 8vo	7	6
Sloane, T. O'c.	The Arithmetic of Electricity.	Crown 8vo	4	6

MECHANICAL ENGINEERING.

STEAM ENGINES, STEAM BOILERS, GAS ENGINES, ETC.

Adams, Hy.	Handbook for Mechanical Engi- neers.	Fourth edition, crown 8vo	7	6
Applebys'	Handbooks of Machinery.	In six sections, 8vo, each	3	6

Section 1.—Prime Movers, Steam, Gas and Air Engines, Boilers, Tur-
bines, &c.

Section 2.—Hoisting Machinery, Winding Engines and Lifting
Appliances.

Section 3.—Pumping Machinery, Pumping Engines, Centrifugal, Steam,
Electrical and Hand Pumps.

Section 4.—Machine Tools and Accessories.

Section 5.—Contractors' Plant and Railway Materials. (*In the Press.*)

Section 6.—Mining, Colonial and Manufacturing Machinery.

The portion of Section 6, dealing with Mining Machinery, is to be had separately, price 2s. 6d.

Barber, T. W. Engineers' Sketch Book of Mechanical Movements. Third edition, 8vo	10	6
———The Repair & Maintenance of Machinery. 8vo	10	6
Box, T. Practical Treatise on Mill Gearing. Fifth edition, crown 8vo	7	6
Byrne, O. The Essential Elements of Practical Mechanics. Fourth edition, post 8vo	7	6
Campin, F. The Practice of Hand Turning. Third edition, crown 8vo	3	6
Colyer, F. The Working and Management of Steam Boilers and Engines. Second edition, crown 8vo	3	6
———Treatise on Modern Steam Engines and Boilers. 4to	12	6
Cooper, J. H. Treatise on the use of Belting for the Transmission of Power. Fourth edition, demy 8vo	15	0
Cotterill, J. H. The Steam Engine considered as a Thermodynamic Machine. Third edition 8vo	15	0
Dahlstrom, K. P. The Fireman's Guide, a Handbook on the Care of Boilers. Eighth edition, fcap. 8vo	2	0
Diesel, R. Theory & Construction of a Rational Heat Motor. 8vo	6	0
Donaldson, W. Transmission of Power by Fluid Pressure, Air and Water. 8vo	6	0
Fletcher, W. History and Development of Steam Locomotion on Common Roads. 8vo	5	0
Foden, J. The Boiler Makers' and Iron Ship-builders' Companion. Fourth edition, fcap. 8vo	5	0

Fuller, J. Art of Copper Smithing. Royal 8vo	12	6
Goldingham, A. H. The Design & Construction of Oil Engines. Crown 8vo... <i>net</i>	6	0
Graham, J. C. Elementary Treatise on Steam and the Use of the Indicator. 8vo ...	9	0
Halliday, G. Belt Driving. 8vo ...	3	6
Hanssen, A. The Commercial Efficiency of Steam Boilers. Large 8vo, sewed ...	6	
Henthorn, J. T. The Corliss Engine. Third edition, square 16mo ...	3	6
Hett, C. L. Table of the Power of Leather Belting and Shafts. On folding card ...	1	0
Hiscox, J. D. Gas, Gasoline and Oil Vapour Engines. Fourth edition, 8vo ... <i>net</i>	10	6
Kinealy, J. H. Elementary Text-book on Steam Engines and Boilers. Third edition, 8vo ...	10	6
Knight, C. The Mechanician : a Treatise on the Construction and Manipulation of Tools. Fifth edition, 4to ...	18	0
Lieckfeld, G. Practical Handbook on the Care and Management of Gas Engines. Square 16mo ...	3	6
Low, P. A. Valve Setting Record Book. 8vo boards ...	1	6
Millis, C. T. Metal Plate Work, its Patterns and their Geometry. Third edition, crown 8vo	9	0
Peattie, J. Steam Boilers, their Management and Working. Fourth edition, crown 8vo ...	5	0
Porter, C. T. Treatise on the Richards Steam Engine Indicator. Fifth edition, 8vo ...	9	0
Richards, J. The Arrangement, Care and Operation of Wood Working Factories and Machinery. Second edition, crown 8vo ...	5	0

Rigg, A. Practical Treatise on the Steam Engine. Second edition, demy 4to	1	5	0
Sexton, M. J. Pocket Book for Boiler Makers and Steam Users. Fourth edition, royal 32mo, roan, gilt edges		5	0
Spencer, A. Roll Turning for Sections in Steel and Iron. Second edition, 4to	1	10	0
Uhland, W. H. Slide and Piston-Valve Geared Steam Engines. Two Vols., half Morocco	1	16	0
Watson, E. P. How to run Engines and Boilers. Fourth edition		3	6
Welch, E. J. Practical method of Designing Slide Valve Gearing. Crown 8vo		6	0
Wright, T. W. Elements of Mechanics. 8vo				10	6
Zeuner, G. Treatise on Valve Gears, translated from the fourth German edition by J. F. KLEIN. 8vo		12	6

METALLURGY.

Andrews, T. The Life of Railway Axles. 8vo, sewed	1	0
———— Microscopic Internal Flaws in Steel Rails and Propellor Shafts. 8vo, sewed				1	0
———— Microscopic Internal Flaws, Inducing Fracture in Steel. 8vo, sewed		...		2	0
Davies, J. Galvanized Iron: its Manufacture and Uses. 8vo	<i>net</i>	5	0
Ede, G. Guns and Gun Making Material. Crown 8vo	6	0
———— The Management of Steel. Seventh edition, crown 8vo		5	0
Kirk, E. The Cupola Furnace. Demy 8vo	...			14	0
Macfarlane, J. W. Practical Notes on Pipe Founding. 8vo	12	6
Sharp, J. Modern Foundry Practice. 8vo <i>net</i>			1	1	0

West, T. D. The Metallurgy of Cast Iron. Second edition. 8vo	12 6
Wyllie, C. Treatise on Iron & Steel Founding. Second edition, crown 8vo	5 0

MINERALOGY AND MINING.

Andre, G. G. Rock Blasting. 8vo	5 0
————— Practical Treatise on Coal Mining. Two Vols., royal 4to	3 12 0
Brown, W. L. Manual of Assaying Gold, Silver, Copper and Lead Ores. Ninth edition, crown 8vo	12 6
Charleton, A. G. Tin: Describing the Chief Methods of Mining, Dressing, etc. Crown 8vo	12 6
Daw, A. W., & Z. W. The Blasting of Rock in Mines, Quarries and Tunnels, etc. Demy 8vo	15 0
Hopton, W. Conversations on Mines. Ninth edition, crown 8vo	4 6
Hull, E. Our Coal Resources at the End of the Nineteenth Century. Demy 8vo	6 0
Kirkpatrick, T. S. G. Simple Rules for the Discrimination of Gems	2 0
————— The Hydraulic Gold Miners' Manual. Second edition, crown 8vo	4 0
Lock, C. G. W. Economic Mining. 8vo	1 1 0
————— Gold Milling: Principles and Practice. Demy 8vo <i>net</i>	1 10 0
————— Mining and Ore-Dressing Machinery. Super-royal 4to	1 5 0
————— Miner's Pocket Book. Fourth edition, fcap. 8vo, roan <i>net</i>	12 6
Longridge, C. C. The Holloway Longridge Process for Extracting Gold. 8vo, sewed	1 6
Miller, J. A. The Practical Handbook for the Working Miner and Prospector, and the Mining Investor. Crown 8vo	7 6

Murgue, D. The Theory and Practice of Centrifugal Ventilation Machines. 8vo	...	5	0
Povey-Harper, J. Examples of Coal Mining Plant. Second edition, in portfolio	...	4	4 0
Suttie, T. R. The Miner's and Prospector's Pocket Guide. Square 16mo	... net	2	0

ORGANIZATION AND MANAGEMENT

Brown, N. The Organization of Gold Mining Business. Fcap. folio...	... net	1	5 0
Foster, H. A. Central Station Management and Finance. 8vo	7	6
———— Central Station Book Keeping. 8vo	...	12	6
Lewis, J. S. The Commercial Organization of Factories. Royal 8vo. <i>New Edition in the Press.</i>			
Matheson, E. Depreciation of Factories. 2nd edition, 8vo	7	6
———— Aid Book to Engineering Enterprise. Third edition, 8vo	1	4 0
Parry, W. Kaye. Office Management. A handbook for Architects and Civil Engineers. net		10	0
Williams, R. R. The American Hardware Store. Royal 8vo	12	6

RAILWAY ENGINEERING.

Allen, C. F. Railroad Curves and Earthwork. 12mo, leather, gilt edges	... net	8	6
Allen, G. T. Tables of Parabolic Curves for the use of Railway Engineers and others. Fcap. 16mo	4	0
Blackall, R. H. Up to date Air Brake Catechism. Crown 8vo net	6	0
Briggs, C. Simple and Automatic Vacuum Brakes. 8vo	4	0
Cole, W. H. Notes on Permanent-way Material, Plate-laying, and Points and Crossings. Third edition, crown 8vo	7	6

Derr, W. L.	Block Signal Operation. Oblong crown 8vo	7	6
Glover, J.	Formulae for Railway Crossings and Switches. Royal 32mo	2	6
Grimshaw, R.	Locomotive Catechism. Crown 8vo	7	6
Grover, J. W.	Estimates and Diagrams of Railway Bridges. Second edition, folio ...	1	11
————	Iron and Timber Railway Superstructures and General Works. Folio ...	2	2
————	Examples of Station Buildings and their Cost. Folio	10	6
Haldane, J. W. C.	Railway Engineering, Mechanical and Electrical. Demy 8vo ...	15	0
Hogg, C. P.	Tables for setting-out Railway Curves. A series of cards in neat cloth case	4	6
Hughes, G.	The Construction of the Modern Locomotive. 8vo	9	0
Johnson, J. R.	Practical Hints for Light Railways at Home and Abroad. Crown 8vo...	2	6
Jones, T. W.	Permanent Way Pocket Book. Oblong 8vo	4	6
Kennedy, A., & Hackwood, R. W.	Tables for setting out Curves for Railways, Roads, Canals, etc. 32mo	2	6
Macgregor, W.	Tables for Computing the Contents of Earthwork in the Cuttings and Embankments of Railways. Royal 8vo ...	6	0
Paterson, J.	Tables and Diagrams of Switches and Crossings. 8vo	3	6
Rapier, R. C.	Remunerative Railways for New Countries. Crown 4to	15	0
Spooner, C. E.	Narrow Gauge Railways. Second edition, 8vo	15	0

Watson, A. G. Practical Hints on setting out
Curves. 18mo 6 0

SANITATION.

Bailey-Denton, E. Sewage Purification. 8vo 5 0

Birch, R. W. P. Sewage Irrigation by Farmers.
8vo, sewed 2 6

Boulnois, H. P. Dirty Dustbins and Sloppy
Streets. Crown 8vo, sewed 1 0

———— The Municipal and Sanitary Engineer's
Handbook. Third edition, demy 8vo... 15 0

Coleman, T. E. Sanitary House Drainage, its
Principles and Practice. Crown 8vo ... 6 0

———— Stable Sanitation & Construction. Crown
8vo 6 0

Colyer, F. Public Institutions, their Engineering,
Sanitary, and other Appliances. 8vo ... 5 0

———— Treatise on the Modern Sanitary Appli-
cances for Healthy Residences. Crown
8vo 5 0

Davies, J. P. Standard Practical Plumbing.
Vol I. Fourth edition, royal 8vo ... 7 6

Vol II. Royal 8vo ... *net* 10 6

Davis, G. B., & Dye, F. A Complete and
Practical Treatise on Plumbing & Sanitation.
2 vols., 4to cloth *net* 2 15 0

Parsons, Hon. R. C. Las Obras de Salubridad
de la Ciudad de Buenos Aires. 8vo *net* 5 0

Robinson, H. Sewerage and Sewage Disposal.
Second edition, demy 8vo 5 0

Smeaton, J. Plumbing, Drainage, Water Supply
and Hot Water Fitting. 8vo 7 6

WARMING AND VENTILATION.

Box, T. Practical Treatise on Heat. Ninth
edition, crown 8vo 12 6

Drysdale, J., & Hayward, J. W. Health and Comfort in House Building, or Ventilation with warm air by self-acting suction power. Third edition, 8vo	7	6
Dye, F. Hot Water & Steam Cooking Apparatus. Second edition, 18mo	1	6
———— Hot Water Supply. Fourth edition, crown 8vo	3	0
———— A Practical Treatise upon Steam Heating Demy 8vo <i>net</i>	10	0
Eldridge, J. The Engineer's Practical Guide for Fixing Hot Water Apparatus. Second edition, crown 8vo, sewed	1	0
Hood, C. Practical Treatise upon Warming Buildings by Hot Water. Third edition, revised by F. DYE. Demy 8vo	15	0
Kinealy, J. H. Charts for Low Pressure Steam Heating. Small folio	4	6
———— Formulæ and Tables for Heating. 8vo	3	6
Rafter, G. W. Mechanics of Ventilation. 2nd edition, 18mo, boards	2	0

WATER SUPPLY.

Collet, H. Water Softening and Purification. Crown 8vo	5	0
Colyer, F. Treatise on Water Supply, Drainage & Sanitary Appliances of Residences. Crown 8vo.	5	0
Hill, J. W. Purification of Public Water Supplies. 8vo	10	6
Parry, J. Water Supply. New edition. Crown 8vo	3	6
Richert, G. On Artificial Underground Water. 8vo, sewed <i>net</i>	1	0

Spon, E. Well Sinking. *New Edition in the Press*

Stone, F. W. Notes on Water Supply. Crown

8vo 5 0

Tudsbery, J. H. T., & Brightmore, A. W.

The Principles of Waterworks' Engineering.

Second edition, 8vo I 5 0

USEFUL TABLES.

Babbage, C. Tables of Logarithms of the

Natural Numbers from 1 to 108,000. Stereo-

type edition. 8vo 7 6

Barlow's Tables of Squares, Cubes, Square

Roots, Cube Roots & Reciprocals. Crown 8vo

6 0

Brook, J. French Measures & English Equiv-

alents. Fcap. 32mo, roan

I 0

Clark, L. A Dictionary of Metric and other

useful measures. 8vo

6 0

Girder, W. J. Tables of the Weight of Iron.

On large folding card

I 0

Keerayeff, P. Tables of some of the Principal

Speeds occurring in Mechanical Engineering,

expressed in Metres per second. 18mo, sewed

6

La Nicca, J. Turner's and Fitter's Pocket Book.

18mo, sewed

6

Lindsay, Lord. Tables for Engineers and

Mechanics, giving the values of the different

trains of wheels required to produce Screws

of any pitch. Second edition, royal 8vo,

oblong

2 0

Martin, W. A. Screw-cutting Tables. Seventh

edition, royal 8vo, oblong

I 0

Molesworth, Sir G. L. Metrical Tables. Third edition, royal 32mo	2 0
Price, W. Turner's Handbook on Screw-cutting, Coning, etc. Fcap. 8vo	1 0
Reed's Screw and Worm-wheel Cutting up to date. Royal 32mo	2 6
Rownson's Iron Merchant's Tables and Memoranda, Weights and Measures. 32mo, leather	3 6
Spons' Tables and Memoranda for Engineers, by J. T. HURST, C. E. Twelfth edition, 64mo, roan, gilt edges	1 0
Ditto ditto, in celluloid case		1 6
Taylor, T. Gauges at a Glance. Second edition. Post 8vo, oblong, with tape converter	<i>net</i>	5 0
Thompson, S. P. Optical Tables and Data, for the use of Opticians. Oblong 8vo	<i>net</i>	6 0
Unwin, W. C. Short Logarithmic and other Tables. Fourth edition, small 4to	3 0
Whitelaw, H. N. Fifty-four hours' Wages Calculator. Second edition, 8vo	<i>net</i>	2 6
Woodward, C. J. A. B. C. Logarithms for general use, with lateral index for ready reference. Crown 8vo, limp leather	4 0

MISCELLANEOUS.

Boulnois, H. P. Practical Hints on Taking a House. 18mo	1 6
Boulvin, M. J. The Entropy Diagram and its Applications. Demy 8vo	5 0

Burr, S. D. V.	Bicycle Repairing. Fourth edition, 8vo	4	6
Dye, F.	The Cooking Range: its Failings and Remedies. Fcap. 8vo, sewed	6	
Gillett, W.	The Phonograph, and how to construct it. Crown 8vo	5	0
Hopkins, G. M.	Experimental Science, Elementary, Practical and Experimental Physics. 20th edition, large 8vo	16	0
Longridge, J. A.	Internal Ballistics. 8vo	18	0
————	Treatise on the Application of Wire to the Construction of Ordnance. 8vo	1	5 0
————	The Progress of Artillery: Naval Guns. 8vo, sewed	2	0
————	The Field Gun of the Future. 8vo, sewed	2	6
Philipson, W.	Prize Essay on the Suspension of Carriages. 8vo	5	0
Richards, W.	The Gas Consumer's Handy Book. 18mo, sewed	6	
Spons'	Engineer's Diary and Year Book, issued Annually. 4to	3	6
————	Mechanic's Own Book: A Manual for Handicraftsmen and Amateurs. Fifth edition, demy 8vo...	6	0
	Ditto ditto half Morocco	7	6
Vernon, A.	Estate Fences: their Choice, Construction and Cost. 8vo	15	0

A SUPPLEMENT

TO

SPONS' DICTIONARY OF ENGINEERING,
CIVIL, MECHANICAL, MILITARY, AND NAVAL.

EDITED BY ERNEST SPON,

ASSOC. MEM. INST. C.E., MEM. SOC. ENGINEERS, OF THE FRANKLIN INSTITUTE, AND
OF THE GEOLOGISTS' ASSOCIATION.

In 18 Parts, price 2s. each, post free 2s. 2d.

Bound in cloth, 3 Divisions, 13s. 6d. each.

Or, in One Vol., cloth, £2; half-morocco, £2 8s.

COMPLETE LIST OF ALL THE SUBJECTS.

	Part		Part		Part
Abacus	1	Coke Ovens	7	Machine Tools	14
Agricultural Imple- ments	1	Copper	7	Materials of Con- struction, Strength of	14, 15
Air Compressors ..	1, 2	Dock	7, 8	Mercury	15
Animal Charcoal Ma- chinery	2	Drainage	8	Meters	15
Antimony	2	Dredging	8	Ores	15
Axles & Axle-boxes	2	Dynamo-Electric and Magneto - Electric Machines	8	Piers	15
Barn Machinery ..	2	Dynamometer ..	8, 9	Pile Driving	15
Belts and Belting ..	2	Electrical Engineer- ing	9, 10	Pneumatic Transmis- sion	15
Blasting	3	Engines, Varieties of	10	Pump	15
Boilers	3	Explosives	10	Pyrometer	15
Brake	3	Fans	10	Road Locomotive	15, 16
Brick-making Ma- chine	3, 4	Founding	10, 11	Rock Drill	16
Bridges	4, 5	Gas, Manufacture of	11	Rolling Stock	16, 17
Cages	5	Hammers	11	Sanitary Engineer- ing	17, 18
Calculus	5	Heat	12	Shafts and Shaft Fit- tings	18
Canals	5	Horse Power	12	Steel	18
Carpentry	5	Hydraulics	12	Stone - working Ma- chinery	18
Cast Iron	5, 6	Hydro-geology ..	12	Tramways	18
Cement, Concrete, Limes & Mortar ..	6	Indicator	12, 13	Well Sinking and Boring	18
Chimney Shafts ..	6	Iron	13		
Coal Cleansing and Washing	6	Lifts, Hoists and Ele- vators	13		
Coal Mining	6, 7	Lights, Buoys and Beacons	13, 14		

SPONS' ENCYCLOPÆDIA

OF THE

Industrial Arts, Manufactures and Commercial Products.

EDITED BY C. G. WARNFORD LOCK, F.L.S., &c.

*In super-royal 8vo, containing 2100 pages, and Illustrated by nearly
1500 Engravings.*

Can be had in the following bindings:

In 2 Vols., cloth	£3 10 0
In 5 Divisions, cloth	3 11 6
In 2 Vols., half-morocco, top edge gilt, bound in a superior manner.. .. .	4 10 0
In 33 Parts, Sewed, at 2s. each.	

Any Part can be had separate, price 2s.; postage 2d.

COMPLETE LIST OF ALL THE SUBJECTS.

	PART		PART		PART
Acids	1, 2, 3	Dyestuffs	14	Narcotics	21, 22
Alcohol	3, 4	Electro-Metallurgy	14	Oils and Fatty Sub-	22, 23, 24
Alkalies	4, 5	Explosives	14, 15	stances	24
Alloys	5, 6	Feathers	15	Paper	24
Arsenic	6	Fibrous Substances	15, 16	Paraffin	24
Asphalte	6	Floor-cloth	16	Pearl and Coral	24
Aerated Waters	6	Food Preservation	16	Perfumes	24
Beer and Wine	6, 7	Fruit	16, 17	Photography	24, 25
Beverages	7, 8	Fur	17	Pigments and Paint	25
Bleaching Powder	8	Gas, Coal	17	Pottery	25, 26
Bleaching	8, 9	Gems	17	Printing and Engrav-	26, 27
Borax	9	Glass	17	ing	26, 27
Brushes	9	Graphite	18	Resinous and Gummy	26, 27
Buttons	9	Hair Manufacture	18	Substances	27
Camphor	9, 10	Hats	18	Rope	27
Candles	10	Ice, Artificial	18	Salt	27, 28
Carbon	10	Indiarubber Manu-	18, 19	Silk	28
Celluloid	10	factures	18, 19	Skins	28
Clays	10	Ink	19	Soap, Railway Grease	28, 29
Carbolic Acid	11	Jute Manufactures	19	and Glycerine	29
Coal-tar Products	11	Knitted Fabrics—	19	Spices	29
Cocoa	11	Hosiery	19	Starch	29
Coffee	11, 12	Lace	19	Sugar	29, 30, 31
Cork	12	Leather	19, 20	Tannin	31, 32
Cotton Manufac-		Linen Manufactures	20	Tea	32
tures	12, 13	Manures	20	Timber	32
Drugs	13	Matches	20, 21	Varnish	32
Dyeing and Calico		Mordants	21	Wool and Woollen	32, 33
Printing	13, 14			Manufactures	

Finsbury Technical Manuals.

EDITOR OF THE SERIES.

Prof. SILVANUS P. THOMPSON,

D.Sc., B.A., F.R.S., M. Inst. E.E., &c.

The Manuals in this series are written by Specialists who are, or have been, on the staff of the City and Guilds Technical College at Finsbury.

Dynamo-Electric Machinery. A Manual for Students of Electro-technics. By Professor SILVANUS P. THOMPSON, D.Sc., F.R.S., &c. (*Seventh Edition in Preparation.*)

Metal Plate Work. Its Patterns and their Geometry. By C. T. MILLIS, M.I.Mech.E. Third edition, considerably enlarged, with 216 illustrations, 406 p.p. 8vo cloth, 9s.

Gas and Petroleum Engines. By Professor WILLIAM ROBINSON, M.E., M.I.E.E., A.M.I.C.E. Illustrated. 8vo, cloth. (*Second Edition in Preparation.*)

Practical Work in Organic Chemistry. By F. W. STREATFEILD, F.I.C., &c., Illustrated. Crown 8vo, cloth, 3s.

The Electromagnet and Electromagnetic Mechanism. By Professor SILVANUS P. THOMPSON, D.Sc., F.R.S., &c. (*Third Edition in Preparation.*)

Polyphase Electric Currents & Alternate Current MOTORS. By Professor SILVANUS P. THOMPSON, D.Sc., F.R.S., &c. Second and enlarged edition. 8vo, cloth, 21s.

An Elementary Treatise on the Calculus for ENGINEERING STUDENTS. By JOHN GRAHAM, B.A., B.E. Second edition, 7s. 6d.

Hydraulic Machinery. With an introduction to Hydraulics. By ROBERT GORDON BLAINE, Assoc. M. Inst. C.E., &c. With 272 illustrations, 383 p.p. 8vo, cloth, 14s.

The Journal of the Iron and Steel Institute.Edited by BENNETT H. BROUGH, *Secretary*.Published Half-yearly, 8vo, cloth, 16s.

The Journal of the Institution of Electrical Engineers.Edited by W. G. MCMILLAN, *Secretary*.

Science Abstracts.***Physics and Electrical Engineering.***

Edited by W. R. COOPER, M.A., B.Sc.

Published Monthly, 8vo, 2s. net. Annual Subscription, 24s. net, post free, to any part of the World.

The Transactions of the Society of Engineers.Edited by PERRY F. NURSEY, *Secretary*.Published Annually, 8vo, cloth, 15s.

The Proceedings of the Incorporated Association of Municipal and County Engineers.Edited by THOMAS COLE, ASSOC. M. Inst. C.E.

The Transactions of the Incorporated Institution of Gas Engineers.

Edited by THOMAS COLE, ASSOC. M. Inst. C.E.

Published Annually, 8vo, cloth, 21s.

The Transactions of the Institution of Mining and Metallurgy.Edited by C. McDERMID, *Secretary*.Published Annually, 21s. net.

London: E. & F. N. SPON, Ltd., 125, Strand, W.C.

14 DAY USE
RETURN TO DESK FROM WHICH BORROWED

LOAN DEPT.

This book is due on the last date stamped below, or
on the date to which renewed.

Renewed books are subject to immediate recall.

13 May '60 FK

REC'D LD

MAY 5 1960

MAY 14 1971 G-8

REC'D LD MAY 17 71 -11AM 70

OCT 08 1995

Nov. 6 1995

Dec. 14, '95

Jan 20, '96

RECEIVED

JAN 25 1996

CIRCULATION DE:

LD 21A-50m-4,'60
(A9562s10)476B

General Library
University of California
Berkeley



C051409793

Isler

