

— The —
WIRELESS OPERATORS'
POCKETBOOK of
INFORMATION
AND DIAGRAMS



UC-NRLF



LB 276 723

Leon W. Bishop

BOKER PUBLISHING Co

LIBRARY
OF THE
UNIVERSITY OF CALIFORNIA.

Class

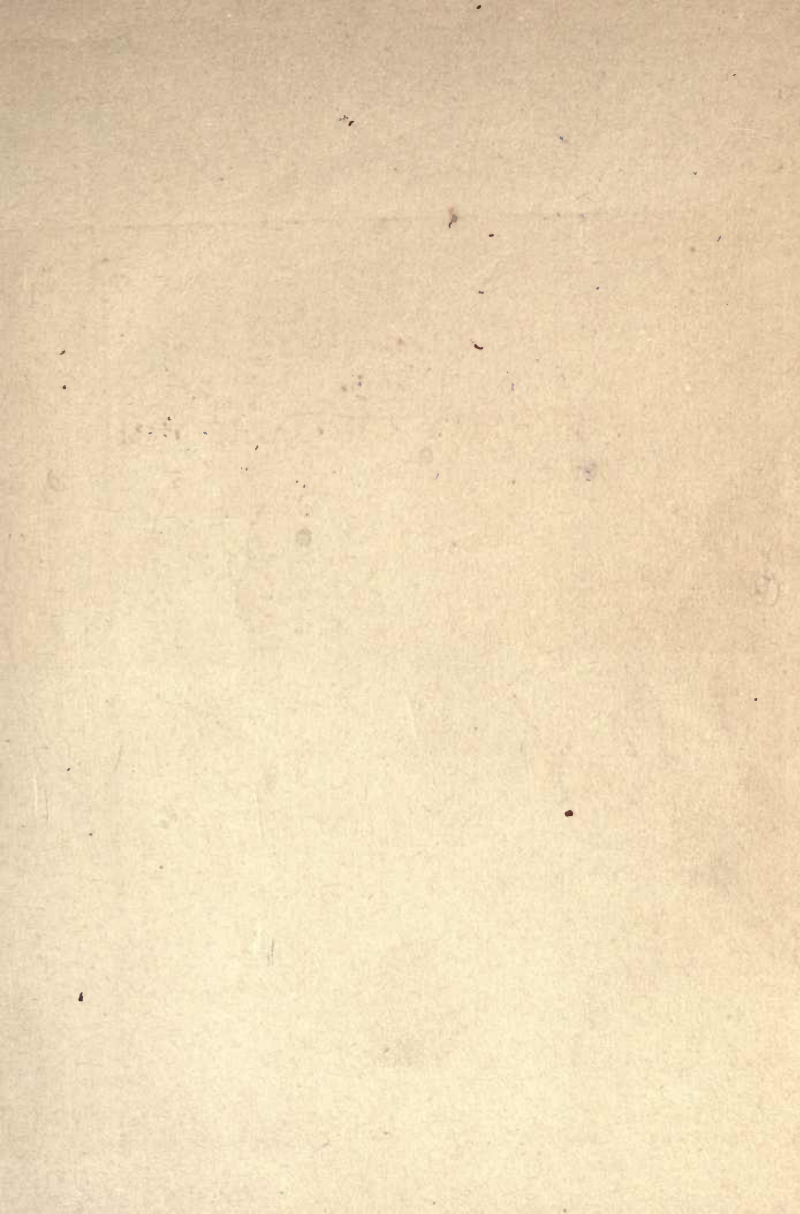

UNIVERSITY OF
CALIFORNIA

THE
MAGAZINE

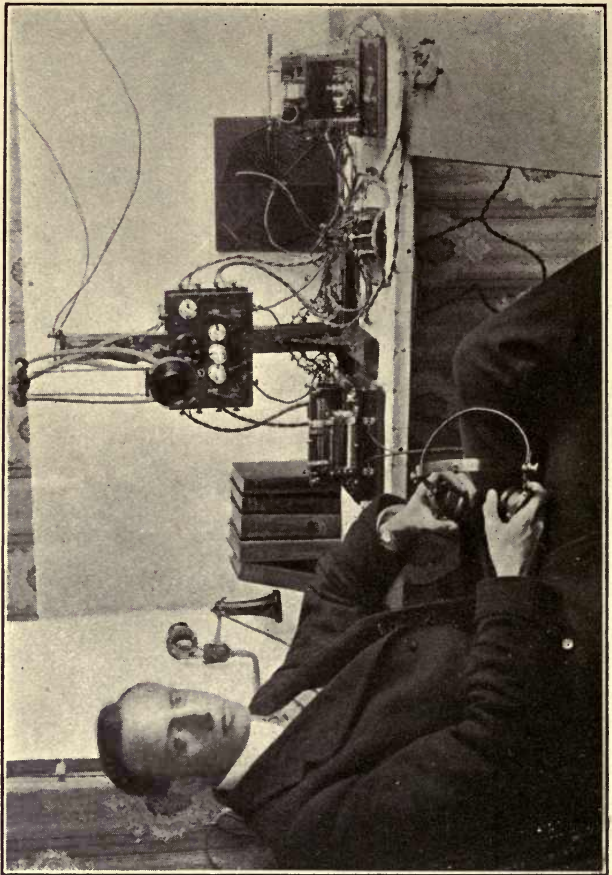

THE

Wireless Operators' Pocketbook

OF

INFORMATION AND DIAGRAMS

BY

LEON W. BISHOP



1911

BUBIER PUBLISHING COMPANY

LYNN, MASS., U. S. A.

AND

H. ALABASTER GATEHOUSE CO.

LONDON, ENG.

TO THE
ASSOCIATION

TK5743
B5

COPYRIGHTED 1911

BY

BUBIER PUBLISHING COMPANY
LYNN, MASS.

ENTERED AT STATIONERS' HALL
LONDON, ENGLAND

BY

H. ALABASTER GATEHOUSE CO.

1911

THE PLIMPTON PRESS NORWOOD MASS. U.S.A.

PREFACE

THE purpose of this little manual is to satisfy the desires of the wireless operator and of those experimenters who have already some knowledge of wireless phenomena, and who wish for a practical book more suited to their needs than the many elementary ones which deal mostly with the construction of simple apparatus, or the elaborate technical and mathematical treatises which presuppose a technical education to understand them. Although some acquaintance with wireless apparatus is expected, it has been the author's intention to give enough of the theory of the circuits and of each piece of apparatus so that anyone interested may understand it and its working.

So far as is possible it has been intended to take up the various subjects in their logical order, except perhaps where a purely logical order would not at the same time aid in the general clearness of explanation. The treatment of the transmitting and receiving instruments, the ground and the aerial connections, naturally comes before the more general chapters. The chapters descriptive of instruments are also noticeably more simple than those towards the end of the book, where a further familiarity with the author's expression is

expected. Moreover, it is to be noticed that although most of the popular forms of instruments are mentioned and described, some have been omitted. This has usually been intentional, in order to comprise within the smallest possible space the description of late types of apparatus, and that of the most approved and efficient design.

The author's knowledge of wireless is based largely on his experience in the Stone Company, and under the direction of Mr. John Stone Stone. He is also largely indebted to Mr. G. W. Pickard for information during the writing of this book. Both Mr. Stone and Mr. Pickard have freely allowed the reproduction of their circuits and theories. On telephony, he is also indebted to Mr. Lee DeForest and others. Thanks are by this means extended to those whose names are mentioned and to many others for help received, either personally or from their printed works.

CONTENTS

	PAGE
I THE TRANSMITTING CIRCUIT	1
II TRANSMITTING STATIONS: EXPERIMENTAL OR LOW- POWER APPARATUS	10
III TRANSMITTING APPARATUS: PROFESSIONAL OR HIGH-POWER STATIONS	17
IV THE RECEIVING CIRCUIT	32
V RECEIVING APPARATUS	40
VI AERIALS AND GROUNDS: TYPES AND CONSTRUCTION	68
VII PROTECTION AND INSTALLATION OF A STATION .	80
VIII OPERATION OF A STATION	90
IX BREAKING-IN SYSTEMS: METHODS OF SIMULTA- NEOUS RECEIVING AND TRANSMITTING	107
X CODES	121
XI THE ETIQUETTE OF WIRELESS AND THE SUBJECT OF INTERFERENCE	129
XII WIRELESS TELEPHONY	133
APPENDIX	149
SUPPLEMENT. LATEST CALL LETTERS	



WIRELESS OPERATORS' POCKETBOOK

CHAPTER I

THE TRANSMITTING CIRCUIT

WIRELESS communication is accomplished by means of vibrations set up in the ether by a set of special instruments used for creating and transmitting them. These vibrations, which travel in all directions away from the sending station in the form of waves, are created of a certain length and frequency by the action of a number of different instruments, each of which affects the wave-creating current in a definite manner. If, for instance, we take the following schematic diagram of the transmitting apparatus, we may understand the part played by each instrument toward the desired result of producing intelligible effect upon telephone receivers at any station.

An electric current, set up by the batteries of the primary circuit, passes through the primary winding of the spark coil. This would form a closed circuit, except for the fact that a telegraph key, connected between batteries and primary, allows the operator to make and break the flow of current at his own will. When the key is held down for an instant only, the

current flowing through the circuit makes a telegraphic "dot." If held down for a longer period, we have a telegraphic "dash." It is thus the will of the operator which controls the flow of current through this primary circuit, transferring his thoughts, by means of an established code, to the receiving station.

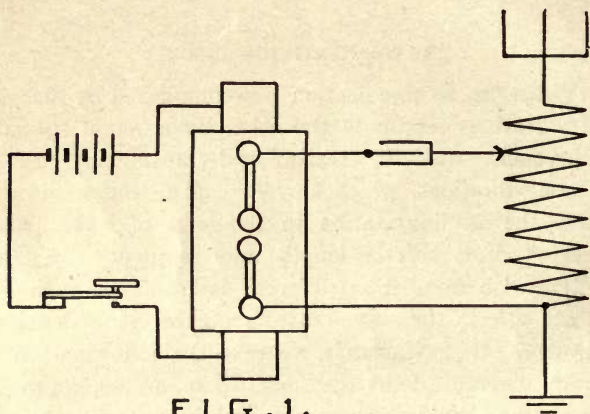

FIG. 1.

The current of our primary circuit is direct. There must, however, be alternating current for the secondary. Therefore some form of interrupter must be placed in the primary circuit in order to break the current and to give it the necessary pulsations. A mechanical vibrator connected to the primary of the spark coil is most frequently used, although an electrical interrupter on a separate battery circuit may be employed instead.

This *Vibrator* interrupts the steady current in the primary of the spark coil, varying the magnetism of the core, by constantly changing its polarity. The secondary of the coil picks up the magnetism; and because the number of turns of wire on a secondary are proportionately greater than on a primary, the

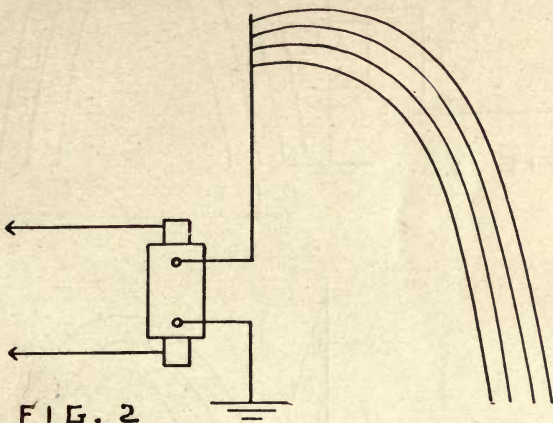
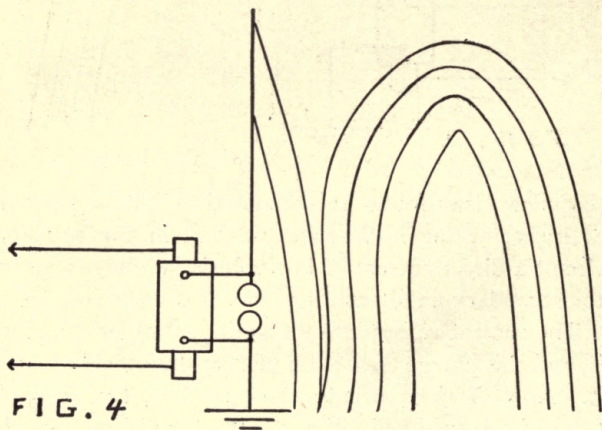
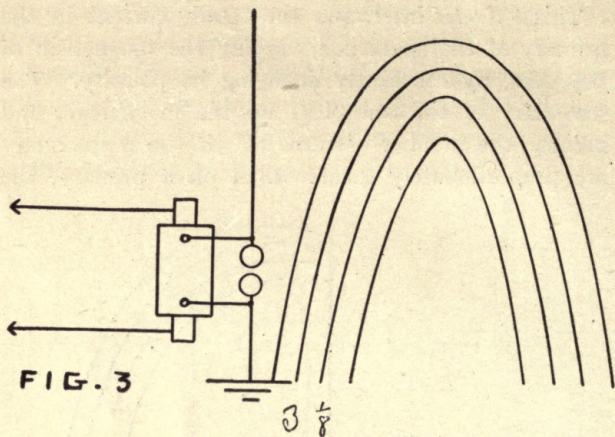

FIG. 2

secondary transforms this magnetism into a current of higher voltage. Whereas we had in the primary circuit a direct current of low voltage, we have now in the secondary an alternating current of high voltage.

The current rushes into the aerial, filling or charging it, and this charge creates an electro-static field around it. Now, if the current ceases to flow, the lines of force of this field will fall flat. We then place a spark



gap between aerial and ground. Now, when the aerial charge is great enough to overcome the resistance of air between the points of the spark gap, a spark will jump between them, thus discharging the aerial abruptly and jerking the lines of force sharply to the ground. The repeated charge of the aerial and its

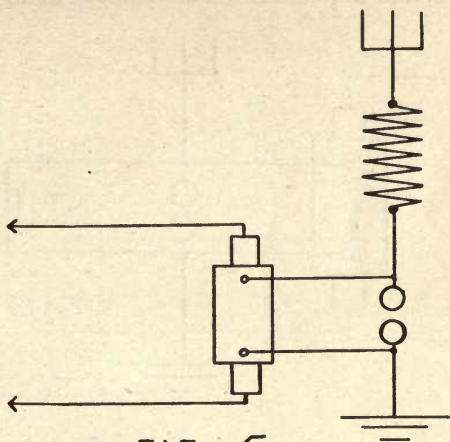

repeated discharge through the spark gap will snap off portions of the field, detach them from the aerial, and thus form electric waves. Series or trains of these detached waves follow one another with great velocity, travelling at the same speed as light (186,400 miles per second).

Instruments connected according to Figs. 3 and 4

will transmit messages into space, but our wave frequency will be very high, and therefore the wave length will be very short. Now short waves are especially liable to all influences tending to shorten their lives — to absorption by the neighboring hills and trees, to reflection and refraction, which tend to change their direction, and to polarization or complete annihilation.

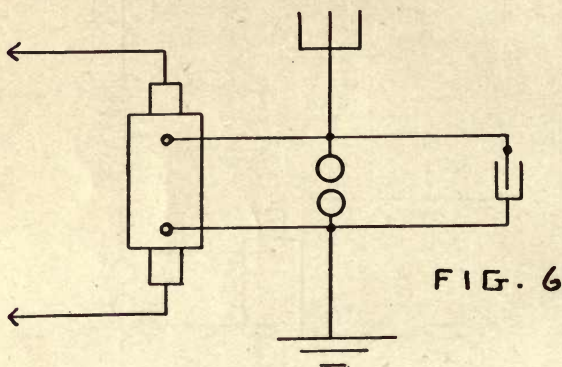

Therefore short waves are inefficient for transmission to any distance. In order to lengthen the waves, we must decrease their frequency. If a coil is placed in the aerial (between spark gap and aerial) it will produce this effect, and the waves will be lengthened. A condenser across the spark gap will produce a similar effect in lengthening the waves. By combining the two, using both coil and condenser, we will add together the two effects. Not only can we obtain

the desired long waves in the manner shown in Fig. 7, but coil and condenser may be placed in series (see Fig. 1), with the same results; or they may be connected as shown in Fig. 8. Usually it is considered best to have both devices together. Thus is formed a resonance or oscillatory circuit, in which the amount

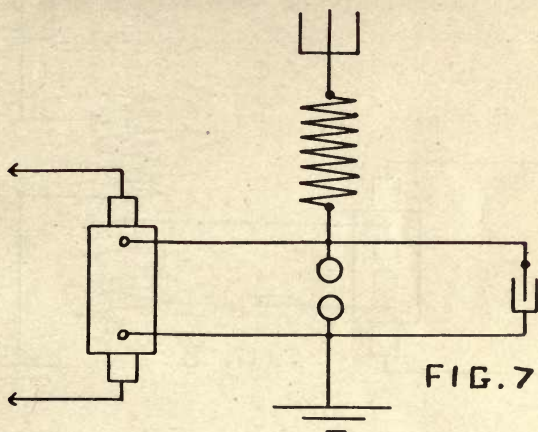

of inductance and capacity (*i.e.* of coil and condenser) offers a path for a spark discharge of a certain periodicity; that is, of a definite wave length and frequency. It is to be noted that under normal conditions the aerial acts as a condenser, aerial being one plate and ground the other.

Thus are formed the simplest forms of transmitting circuits. An oscillation transformer will give us

an additional circuit, which with coil and condenser balanced with the first circuit will again be in resonance. By substituting an oscillation transformer for a helix, we do not really change the circuit formerly used, we merely separate the primary entirely from the secondary, while both of them existed on the helix.

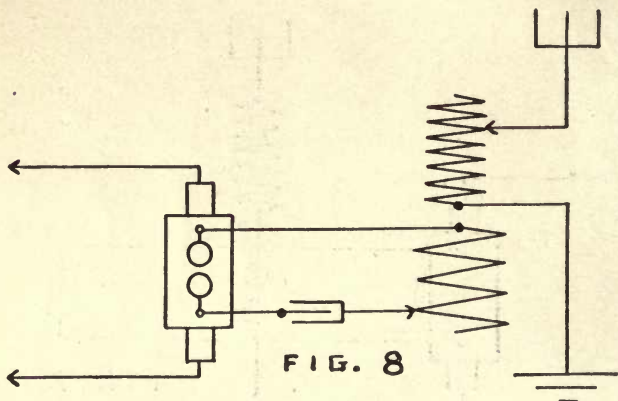

By separating them completely we gain an additional variation, that of the distance between the two coils, the *coupling*. If these coils are drawn far apart, the tuning is made very sharp, the signals can only be received when the oscillation transformer used in the receiving station has a carefully ascertained amount of primary, secondary, and coupling. Such an arrangement of the oscillation transformer at the sending station would be ideal, if it were not for the fact that

more energy is lost when the coils are at a great distance apart, and consequently the transmitting distance of the station is lessened. However, if the coils are too near together, there will be another set of waves formed, following the first, but with crests between. This second tuning point will detract from the strength of signals at the first point, and as a consequence the receiving station will get its signals less clearly.

CHAPTER II

TRANSMITTING STATIONS: EXPERIMENTAL OR LOW- POWER APPARATUS

THE experimenter's station will usually consist of the following pieces of apparatus for transmitting:

Batteries	Spark Gap
Telegraph Key	Condenser
Spark Coil	Helix

The Primary Circuit. *Batteries* are the most available source of power unless the electric light current is already installed in the house. For low-power apparatus, the dry battery is most commonly used, is fairly cheap, and requires little or no care. The Storage or Edison-Lalande cells are more efficient, and cheaper in the long run, even if somewhat more trouble to handle and keep in order. The advantage of any one of these over the ordinary wet batteries is that the amperage is higher, and high amperage is necessary to operate a spark coil.

In selecting dry batteries, the best one for wireless work will have only a moderate amount of amperage, however; say, 18 to 22; and not a high amperage of

from 30 to 35, as the latter deteriorates much more rapidly. In order to get the best and most lasting results, the cells should be connected in series multiple. Thus the amperage of the number in multiple is larger and the voltage is less than when connected in series. Only a storage cell of a known make should be used, as a poor one will prove very expensive to maintain. The storage battery has the decided advantage over the dry battery that its output is always even.

Telegraph Keys in regular use by commercial companies are adapted for wireless work. Either the leg or the legless type is well suited to all requirements. Platinum contact points are essential and are usually found on commercial types of keys. For the rest, easy action and capability of fine adjustment are all that need be looked for in buying one.

The Spark Coil increases (or technically speaking, "steps up") the voltage in order to charge the aerial, and thus to create around it an electro-static field which is to be broken down by the spark gap. A good coil is more cheaply bought than made, except in the larger sizes. Such a coil, to be thoroughly reliable, must be carefully constructed; and it is difficult for the experimenter to use all the precautions necessary to avoid loss of energy. A coil of good efficiency is built with a primary of two layers of nos. 14 to 18 single covered copper wire, wound on a core of soft drawn iron wires. The secondary is wound with a very fine wire, nos. 34 to 38, and carefully

insulated. Enamelled wire in coils, as on most pieces of wireless apparatus, is not satisfactory; the weather is apt to affect the enamel, crack it, and thus spoil its insulating qualities.

Coils are classified by the manufacturer according to the distance the spark will jump. This jump spark is long and thin, and is unsuited for wireless work. For this purpose, a short thick spark, demanding a relatively high amperage is necessary, the same names are applied, however contrary they may seem to the facts of the case. Thus, a one-inch coil, suitable for wireless, should give a one-half inch spark, sufficiently thick and hot to ignite a piece of paper placed between the sparking points. This short thick spark is called the "caterpillar spark." In buying a coil, a good test is to draw out the spark to the breaking point. If good, the discharges should then sound very sharply. This loudness of discharge, together with the hot caterpillar spark, shows the coil adapted for wireless work.

The Vibrator interrupts a current in the primary of the spark coil, thus producing magnetism on the core, which is picked up by the secondary. To give satisfactory results, a coil must have a good vibrator. Such a vibrator should have either platinum or iridium contacts, and the larger the better. The vibrator giving a high-pitched spark is much better than a vibrator giving one of low pitch. Not only does it give more current to the primary, but it causes

a spark which is more penetrating, is more easily read, and at a greater distance. Such a vibrator is by all means the one to choose, even although it consumes the battery current somewhat more rapidly than one of lower pitch.

All commercial spark coils are fitted with a *condenser* across the vibrator to stop the sparking at the vibrator contacts. By this means the current is abruptly broken, and thus the interruptions are sharper. Such a condenser is very essential, and must be carefully



FIG. 9

fitted in capacity to the vibrator by an expert. It is not well to tamper with it or to change its value.

The Spark Gap discharges the charged aerial, and thus creates a series or train of electro-magnetic waves. The electrodes of a good spark gap are of the utmost importance, both as to their form and as to the material of which they are made. The best form for the electrodes is that of a flat-faced circular rod. A sharply pointed or spherical electrode wastes energy and is less desirable. As to materials, silver is best of all, because while it is an excellent conductor when new, the oxide forming when it becomes black is almost as good a conductor as the pure silver. Moreover, silver

is less apt to allow an arc to form across the gap. Pure tin also forms a good electrode. For general use, a commercial compound known as nickel-steel may be recommended. There is no difference between the horizontal and the vertical types in efficiency, although one should always choose the Gap with the finest adjustments.

The Condenser is a unit of balance in the transmitting set. The aerial, helix, and condenser must all be brought into resonance in order to transmit the waves to greater distances. This finding a point of resonance is the important thing. Almost always the condenser is of a fixed value, although it is possible to have it variable instead of the helix, as is usual. Transmitting condensers consist generally of glass plates and tinfoil. The glass margin around the tinfoil should be wide enough to prevent sparking over the edges. The capacity of the condenser should be sufficiently large to balance with the rest of the circuit. Leyden jars are also used as transmitting condensers, although some energy may be lost in this type by a brush discharge around the upper edges of the jar.

The Helix is another unit of balance in the set. As already stated, it is oftenest the helix which is varied when bringing the helix, condenser, and aerial into resonance. A helix of soft-drawn strip copper on hard rubber posts is the best one; but if built of copper tubing or heavy wire (the soft-drawn is always best), and on insulated wooden posts, it will be satisfactory

for low-power stations. Helices for this work should have one stationary and two variable contacts.

Having completed the general description of the qualities of the instruments in a transmitting set, it will be advisable to show a selection of instruments which will work harmoniously together. The first transmitting set usually depends upon a one-inch spark coil, and so that will be our starting point.

Transmitting Set No. 1. With a one-inch spark coil, provided with a good high-pitched vibrator, there will be necessary from six to twelve dry cells. Six cells will run the coil, but of course the energy will be greater with more. A greater number than twelve, however, should not be used, as it may break down the secondary winding and burn out the primary. An ordinary telegraph key, such as can be purchased for about a dollar, will give good satisfaction. A spark gap with silver points may be mounted on the coil or on a separate base. The transmitting condenser should consist of from ten to fifteen 5 by 7 glass plates and a suitable amount of tinfoil or leadfoil, with good margins. A simple home-made helix, made either of strip copper or copper wire, wound in a spiral or on a drum, will be all that is necessary. With an aerial of fair size and a good ground connection, this set of apparatus will transmit signals to a distance of from four to seven miles over land, or a somewhat greater distance over water.

Transmitting Set No. 2. A two-inch spark coil,

with a good vibrator, should give a hot caterpillar spark which will ignite a piece of paper when the sparking points are from one inch to an inch and a quarter apart. Such a coil requires from ten to twenty-four dry cells, or a storage battery of ten to fifteen volts, sixty ampere hours. The same key used for the one-inch coil will be adequate for this set also. An adjustable spark gap, mounted on a separate base, would be best. The transmitting condenser and the helix may be the same as those described for Set No. 1. Greater pains must be taken with the insulation when a higher voltage is used. Such a set as this will send from ten to eighteen miles over land, or three times this distance over water.

After outgrowing these outfits, the experimenter will naturally wish to have a more powerful set, and for this purpose he will probably want a small transformer. Sets of that type are described in the following section.

CHAPTER III

TRANSMITTING APPARATUS: PROFESSIONAL OR HIGH-POWER STATIONS

IN large stations where high power is used, the apparatus differs from that used in smaller ones less in character than in size and capability of standing increased current. A station containing a transformer of from one-quarter to five kilowatt capacity will use the following apparatus:

Alternating Current (or Pulsating Direct)

Telegraph Key

Transformer

Spark Gap

Condenser

Helix, or better, an Oscillation Transformer

The Power is usually an electric light current of either 110 or 220 volts, and preferably alternating. The alternating current is necessary for running a transformer to its best advantage. If only direct current, however, can be obtained, a somewhat similar effect may be produced by using a chemical or mechanical interrupter with the direct current.

The *Electrolytic and the Mechanical Interrupter* produce the same effect upon the direct current and give an effect approximating the alternations of the alternating current, which is what we need. An

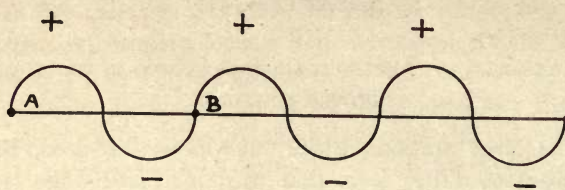

FIG. 10

ALTERNATING CURRENT

alternating current (see Fig. 10) makes complete cycles, passing from negative to positive, back again to negative, and then beginning a second revolution. The changes of polarity of this alternating current may be represented by the curve shown in Fig. 10, a



FIG. 11

PULSATING CURRENT

complete cycle being included between (A) and (B). A pulsating direct current, produced by means of an interrupter vibrates between the zero point and either negative or positive pole, but it does not change its

direction or polarity. Such a current may be represented by the curve shown in Fig. 11. There are thus no cycles, but the vibrations or pulsations have much the same effect upon a transformer as the alternations of the alternating current. An *Electrolytic or Chemical Interrupter* produces pulsations of the direct current in this manner: The positive lead goes to the anode in a glass jar containing a mixture of approximately

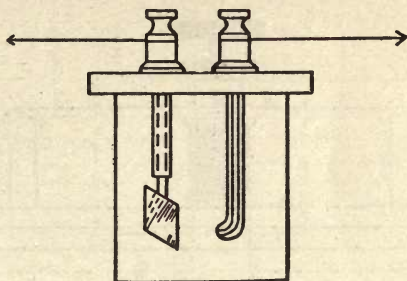

FIG. 12

nine parts water to one of sulphuric acid. When a current passes through this, bubbles are formed at the anode, and these discharging, the current from the large kathode or negative plate rushes to fill up the space and thus completes the circuit. This is done at very rapid intervals. A battery current of fifty volts is necessary to start the operation.

Mechanical Interrupters are of many types, but of nearly the same effectiveness. It is much better to buy a good instrument than to attempt to make one.

It should be of high pitch, and as simple in construction as possible. An excellent interrupter is shown in the diagram, Fig. 13. Its principle is that of the electric buzzer. It consists of a vibrating steel spring suspended tightly between two points. On one side of the spring is a magnet, and just above is a heavy platinum contact. The current, passing through the magnet, pulls down the spring and thus breaks the

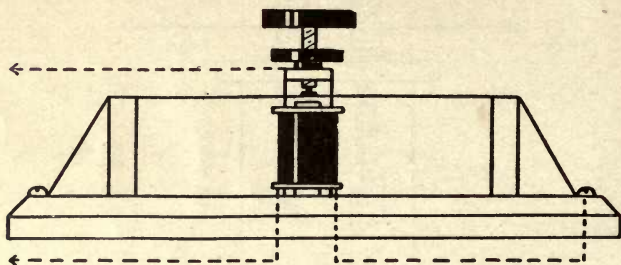

FIG. 13

MECHANICAL INTERRUPTER

circuit. At once the spring jumps back again to the contact and starts the current again. These interruptions are at a very rapid rate and at a high pitch, which may be varied by adjusting the spring. The pitch will also give a pure tone, such as is easily read at the receiving end.

The Key may be any one of the more substantial makes of commercial telegraph keys, provided there are heavy platinum contacts. Special wireless keys

suitable for use with transformers of from $\frac{1}{4}$ to 2 kilowatts are manufactured, and there are larger ones for heavier currents. The contacts may be of platinum, iridium, or silver, a compound of platinum and iridium making the best ones. A key for use with a $\frac{1}{4}$ to 2 kw. transformer should have contacts of about no. 10 wire. All keys used in high-power stations should have a one microfarad condenser strapped (or shunted)

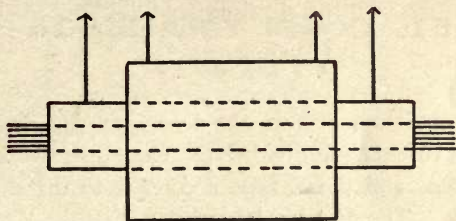

FIG. 14

OPEN CORE TRANSFORMER

across the contact points to prevent an arc from forming or the key from sticking.

The Transformer, like the spark coil, steps up the voltage of the current in order to charge the aerial. Indeed the spark coil is one form of a transformer, the so-called "open-core" type. In transmitting, both the open and closed core types may be used, but it is impossible to use the latter with pulsating direct current. The open-core type is preferable up to 5 kw. The closed-core type is less efficient, although

many prefer it even in the smaller sizes. It has the advantage that its size and output may be more closely computed. The difference between the two types

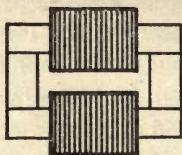

CLOSED CORE TRANSFORMER
FIG. 15

may be understood from the accompanying diagrams. Manufacturers have divided the closed-core types into the O type and the E type according to the shape of the core. The E type is perhaps slightly the more

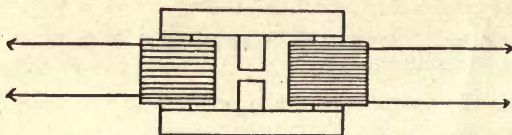

FIG. 16

CLOSED CORE TRANSFORMER
TYPE E

efficient, but both are good; and they are less expensive than the open or induction coil type.

The transformer for wireless work should have a secondary potential of from 15,000 to 30,000 volts.

The core of the closed-core transformer should be built of soft iron (laminations), matched together closely. Insulation should consist either of empire cloth or paper (the difference is slight) which is treated with a preparation containing linseed oil. Transformers are wound both for 110 and 220 volts, 60 or 120 cycles

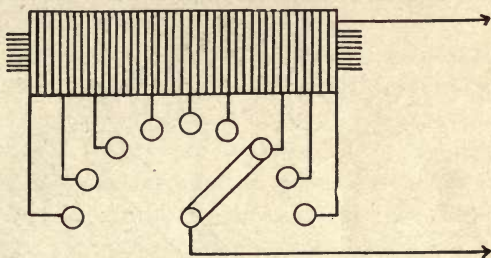

FIG. 17

REACTANCE REGULATOR

per second. Some commercial forms are so built that no impedance coil or rheostat, such as is usual, is necessary.

An impedance coil and a rheostat answer the same purpose in cutting down the primary current of the transformer, but in different ways. *An impedance coil* (usually called a Reactance Regulator) may be used only to cut down an alternating current. Fig. 17 will show this. A core of soft iron wire has wound on it several layers of single covered copper wire. An alternating current, passing through the coil, mag-

netizes the core. When the current is flowing in one direction, the poles of the core become north and south, respectively. The change of direction of the current then reverses this polarity and tends to retard the flow by *bucking* it. This lagging or *bucking* offers a resistance or impedance to the current. If, then, this coil is tapped at intervals, and the leads are connected

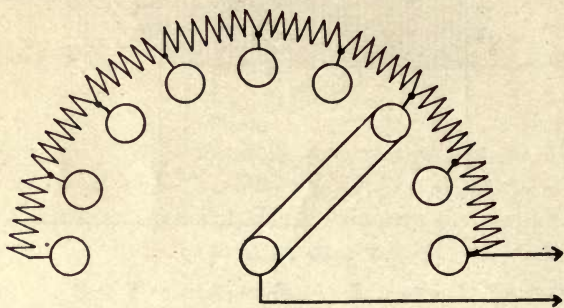

FIG. 18

RHEOSTAT

to a many-pointed switch, we may regulate the amount of reactance effect upon the current.

The principle of the *rheostat* is simpler. A wire of lower conductivity is placed in the circuit with points of adjustment, which determine the amount of resistance to be added to the circuit. This resistance wire is often German silver or iron.

A *bank of lamps* placed in the circuit has the same

effect, and because much cheaper, is often used for the purpose. (See below, Fig. 53.)

The Spark Gap in high-power stations is different from that used in the smaller stations only in having larger sparking contacts, in its capability of standing increased current, and in its fineness of adjustment. Nickel-steel is generally used for the points, although silver is much better. When using over $\frac{1}{2}$ kw., radiators on the handles of the sparking points will be found advantageous, and in fact almost necessary in order to keep the hot contacts cool, and thus to prevent the formation of an arc between them. A highly insulated base and handles are necessary to prevent damage to the operator from leakage of the current. With very high-power sets, several sparking points should be placed on the gap. This is the Multiple Spark Gap. In connection with it, a blow-pipe or fan is necessary to dissipate the gases formed and to cool the contact points, since if hot, these will allow the formation of an arc between the gaps. In sets of 2 kw. or more, the spark gaps should be encased in a box to prevent damage to the operator's eyes from the ultra-violet rays, and to his ears from the deafening noise. A glass front on the box may be used, since glass is impervious to the ultra-violet rays.

The Condenser, in high-power sets, should embody the same principles as that previously described. A glass-plate condenser is advisable by all means. Good flawless glass should be used. Plates should be of the

left and right design, since this ensures an even capacity per plate; for there are two sheets of tinfoil between each one. The plates should be arranged in units so that faulty ones may be removed without destroying the whole condenser. It is well to have the plates cast in some insulating material such as beeswax or rosin; or to immerse them in castor oil, which is one

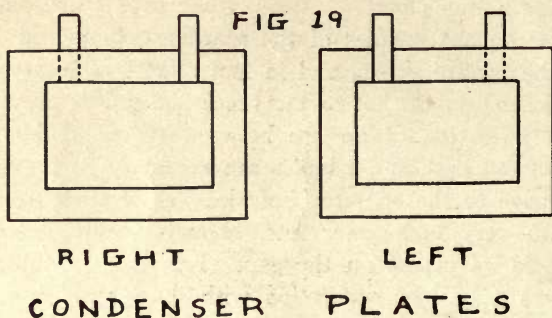

of the best dielectrics known. With care in these respects, the condenser will be satisfactory.

The Helix for this set of instruments should be made of heavy strip copper or large copper tubing and should be mounted on hard rubber. There should be two stationary and two or three variable contacts.

Oscillation Transformer. Better than a helix, however, and answering the same purpose, is an Oscillation Transformer, which gives not only more radiation, but more sharply tuned radiation. This instrument is an additional transformer, giving greater sharp-

ness of tuning to the station than is possible with a helix. Instead of the helix, we have now the primary of the oscillation transformer, which inductively passes on the oscillations received from the transmitting transformer to the secondary of the oscillation transformer. Through this process of induction, if the value of coupling, *i.e.*, the distance between the

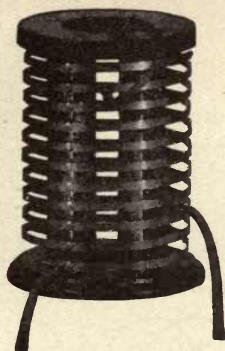

HELIX

two coils, of the oscillation transformer is right, pure trains of waves are given off the aerial. The advantage of giving off sharply tuned or pure trains of waves from the transmitting station is that they may be picked up with less interference at the receiving end. These pure trains of waves (see Fig. 20) are formed by attracting to the same apex the apices of the weaker trains of waves, which would

otherwise form so-called *humps* in the wave (see Fig. 21). When there are humps there may be several tuning points, at the crests of each subordinate wave.

An oscillation transformer may be built to advantage by the operator. Both primary and secondary

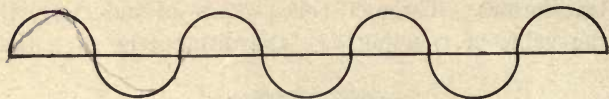

FIG. 20

should be of soft drawn copper ribbon or tubing wound on hard rubber or some other material of as high insulating or dielectric strength. There should be one stationary and one variable contact on both primary and secondary.

With apparatus like that here described, and with

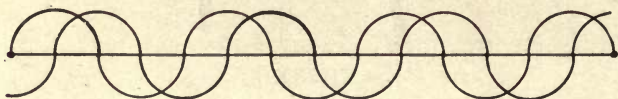

FIG. 21

suitable aerial and ground connections, stations may be fitted up from $\frac{1}{4}$ to 15 kw. capacity. We shall add detailed lists of the instruments necessary for a few sizes of transformers.

Transmitting Set No. 3. $\frac{1}{4}$ Kilowatt. The 110-volt alternating current is all that should be used, although

the 220-volt current may be used with specially built apparatus. If *direct current* only can be obtained, an interrupter must be added.

The Key should be of a special wireless type with heavy contacts, and with a 1-mf. condenser connected across them.

The Transformer may be of either the open or closed core type. With direct current, the open-core type

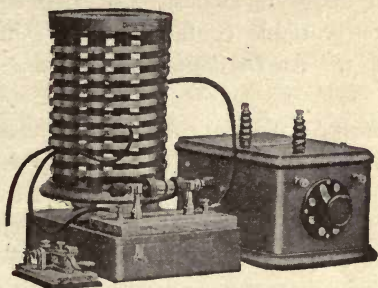

COMPLETE SET

must be used with interrupter, the closed-core type giving little or no efficiency under the circumstances.

The Spark Gap should have contact surfaces of silver, of the design shown in Fig. 9.

The Condenser should have twelve or eighteen glass plates 8 x 10 inches.

The Helix may be of the general type described above, or, if desired, an *Oscillation Transformer* may be used.

Transmitting Set No. 4. $\frac{1}{2}$ Kilowatt. The same power

requirements as in Transmitting Set No. 3. *The Key* should be similar to that in Set No. 3. There should be a transformer of $\frac{1}{2}$ -kw. capacity, of either the open or closed core type. *The Spark Gap*, with silver contacts $\frac{3}{4}$ inch in diameter, should have radiators on both arms. *The Condenser* should be of $\frac{1}{4}$ -inch glass and should consist of from twelve to eighteen sheets of 10 x 10 glass, the insulating margins around the tinfoil being about $1\frac{1}{2}$ inches. *The Helix* should have two or three variable contacts, of the same type as in Set No. 3. An *Oscillation Transformer* would be advisable.

Transmitting Set No. 5. 1 Kilowatt. The same power requirements as in Set No. 3. *The Key* should have very heavy silver contacts, of special 1-kw. design. *The Transformer* of 1-kw. capacity, of either open or closed core type. *The Spark-Gap* contacts should be one inch in diameter, and with radiating surfaces. *The Gap* should be of the enclosed type, in order to muffle the noise and to keep the injurious ultra-violet rays out of the eyes. *The Condenser* as in Set No. 4. A *Helix* may be used, but a 1-kw. *Oscillation Transformer* is strongly advised.

Transmitting Set No. 6. 2 Kilowatt. Power requirements as in Set No. 3. A *Key* with heavy $\frac{1}{2}$ -inch silver contacts. A 2-kw. *Transformer* of either open or closed core type. An *enclosed Spark Gap* with silver sparking surfaces $1\frac{1}{4}$ or $1\frac{3}{8}$ inches in diameter. A *Condenser* constructed in units so that

it may be connected in series multiple to relieve the dielectric (or insulating) strain. There should be thirty to forty sheets of $\frac{1}{4}$ -inch glass, 10" x 10" in size, and immersed in castor oil. A *Helix* may be used, but is not recommended. *The 2-kw. Oscillation Transformer* is necessary to stand the current.

Transmitting Set No. 7. 5 Kilowatt. Power requirements as in Set No. 3. A special *Key* with $\frac{3}{4}$ -inch silver contacts and a 2-mf. condenser. A *5-kw. Transformer*, preferably of the open-core type. An enclosed multiple *Spark Gap*, with blow-pipe or fan, is necessary. Five or six sparking surfaces, $\frac{1}{2}$ inch in diameter will be sufficient. *The Condenser* must be in units, with twenty to forty plates of $\frac{1}{4}$ -inch glass, 14" x 14", and with 2-inch margins, and immersed in castor oil. An *Oscillation Transformer* of special design is necessary.

CHAPTER IV

THE RECEIVING CIRCUIT

THE transmitting apparatus is always engaged in radiating waves from its aerial. These waves, starting from that aerial as a common centre, pass on in ever-widening circles, as do the ripples in water when a stone is dropped. All original activity is confined to this process of sending waves from the transmitter, and the journey of the waves in their circles is as far as the electrical current behind the transmitting apparatus is able to send them. But another process is necessary before wireless communication is established. Not only must waves be sent out, but there must be a way of determining what signals they bear. This is done by stationing another set of instruments somewhere in the circular course of the waves, and this second set of instruments must be able to reveal to the operator the meaning of the signals. This second set is called the *receiving station*. It must be placed within the radius of the waves sent out from the transmitter, but the nearer it is to the sending instruments, the louder and clearer will the signals be received.

Again an aerial is used, but instead of acting as an outlet for waves generated by the instruments below, the receiving aerial or antenna (just as the antenna or feeler of the crab informs him what is passing) conveys to the operator through the receiving instruments news of what is passing. Wireless messages cannot at present carry any secrets of importance, for every aerial within the sending range of the transmitter will carry the message to the operator below. The electrical current necessary to radiate wireless messages from the transmitting aerial is very great, because the waves must radiate in every direction, and cannot be confined to one path as the wire of a wire telegraph confines its current. At the same time, the power received at the receiving station will be infinitesimal, for the very same reason of this scattering of energy. Thus it is necessary to have the most sensitive of receiving instruments in order to detect the waves and make their signals known to us.

The two absolutely necessary parts of the receiving circuit are an aerial and a ground connection. The aerial receives or *picks up* the wave signals by vibrating with the frequency of the waves. Thus a surging effect is set up in the aerial between air and ground. But however true this may be, we must add other instruments before we shall be able to discover them. First of these is the *detector*, which, as its name implies, is used to detect the presence of electric vibrations in the aerial circuit. These vibrations or oscillations

may be detected in various ways, and the several different detectors work on quite different principles. As the mineral forms are most common, and are probably the most efficient, it will be enough in this

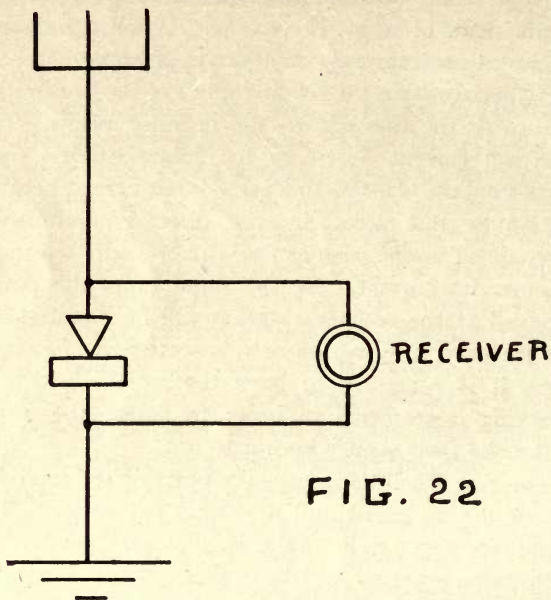

place to take one of these, the *silicon detector*. When, in a detector attached to an aerial circuit through which oscillations are surging, a point of brass rests against a flat surface of silicon, it will allow the current to pass more readily in one direction than in the other.

Thus instead of the alternating current set up by the electric waves, we have a rectified direct current passing through the telephone receivers connected

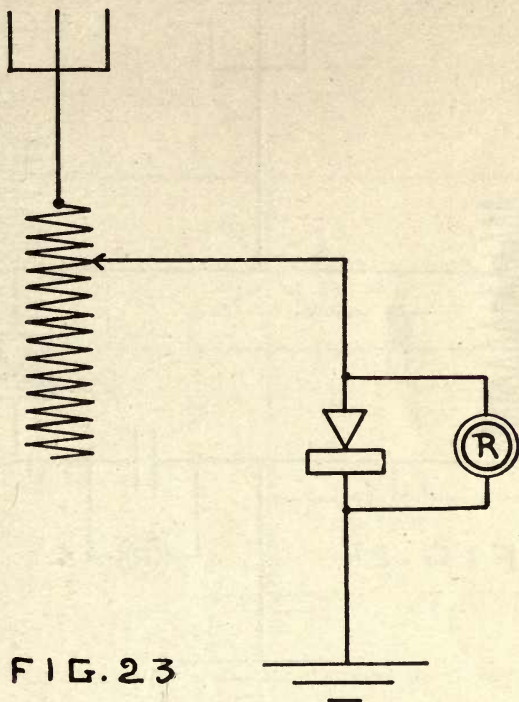
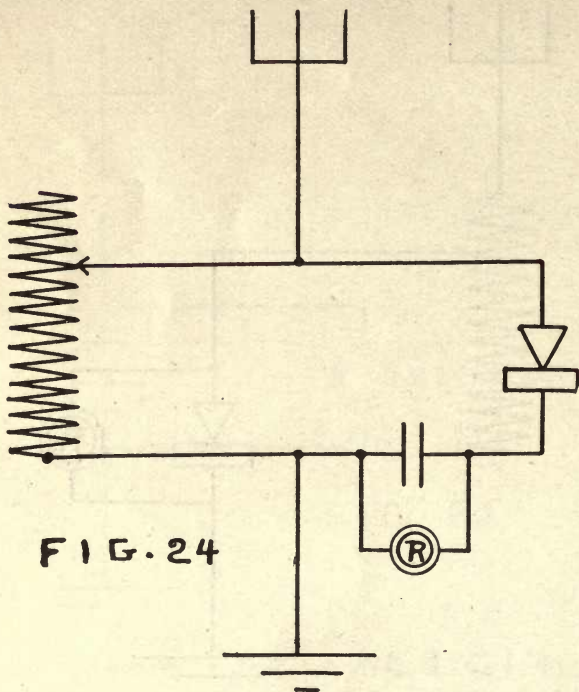

FIG. 23

across the detector. By this means we hear the intermittent splashes of the sending key, and by means of a recognized code we are able to form words from them.

Thus is formed the simplest receiving circuit (see Fig. 22) which will be capable of receiving signals of a wave length comparable with our aerial. But if



waves of greater length are passing, they cannot be picked up by our simple aerial. We therefore add to its (the aerial's) inductance — that is, to its time of

vibration — by placing a coil of wire in the aerial circuit. A variable contact on this “tuning” coil allows

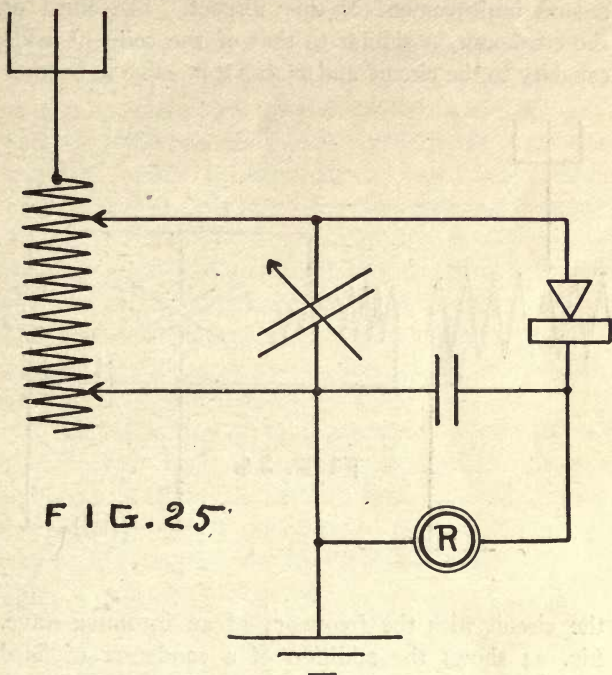
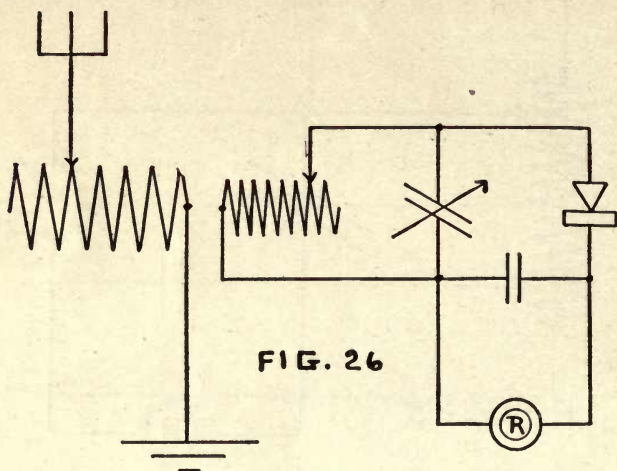

FIG. 25

us to lengthen our oscillatory circuit in accordance with varying wave lengths.

The first purpose of the receiving instruments is to make it possible for the aerial to vibrate in harmony with the waves it picks up. The tuning coil is a dis-

tinct addition in increasing this capability of tuning, but another instrument, the condenser, adds the second improvement in this respect. The effect of the condenser is similar to that of the coil—it adds capacity to the circuit and makes it possible to balance



the circuit with the frequency of an incoming wave. Fig. 24 shows the addition of a condenser of fixed capacity to the circuit, and Fig. 25 shows the further addition of a variable condenser. This latter secures the very finest adjustment for balancing the circuit.

The next improvement in the receiving circuit is to remove the detector circuit entirely from the aerial. This is done by using an oscillation transformer instead

of a tuning coil. We have now two entirely separate circuits, both of which may be equally balanced to any frequency, and which are connected only by induction (*inductively coupled*, we say). The primary of the oscillation transformer is in the aerial circuit, where a complete oscillatory circuit is made. We can, then, vary the primary in the aerial circuit; vary the secondary in the detector circuit, balancing it with the primary; and we can vary the coupling between the two. Then, when our aerial is tuned with the incoming wave, and the secondary circuit is balanced with the primary, this variation of coupling enables us to cut down interference from stations we do not want to receive, and at the same time to bring in more clearly those stations we want.

If the coil in any of these circuits is inadequate to receive waves from any desired station, another coil may be placed in the aerial circuit to add greater inductance. Such a coil is called a *loading coil*, and may be used as well with an oscillation transformer as with an ordinary tuning coil.

CHAPTER V.

RECEIVING APPARATUS

THE receiving station is usually the first one experimented upon, and might more properly precede the transmitting station in our description. It has, however, been thought best to keep to the logical order.

The instruments necessary for a receiving set are as follows:

Detector	Fixed Condenser
Telephone Receivers	Variable Condenser
Tuning Coil	Oscillation Transformer

The Detector is the most essential part of the receiving apparatus, and its purpose is most vital for receiving wireless signals. The waves received from transmitting stations are picked up by the receiving aerial. As a result, an alternating current of very high frequency is set up and surges in the aerial and the receiving circuit. The detector causes this exceedingly feeble current to become perceptible to our ears, by means of very sensitive telephone receivers. The methods are based on different theories according to the type

of detector used, the earliest form, the coherer, depending upon a quite different principle from that of the recent mineral detectors. Some forms once used have been discarded, while new and more sensitive detectors are still being discovered. We shall mention only a few of the most important types, giving them in their historical order, which has proved to be the order of their respective values.

The Coherer is mentioned only because it was the earliest form used. This is constructed of a small glass tube with two highly conducting electrodes of

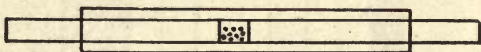

FIG. 27 COHERER

silver. Between these the space is partially filled by a mixture of nickel and silver filings. Large filings, which have a low resistance, are used with relays of low resistance, while finer filings, lying in the tube with a high resistance, are used with relays of high resistance. The filings have normally high resistance. When a signal is received from a transmitting station on an aerial or oscillator, an electric wave conducted to these filings breaks down the resistance caused by the oxide existing on their surface, causes them to cohere and thus lowers the resistance. This lowered resistance and the consequent more perfect path for the current can be easily detected by a relay which is in the circuit

with a battery. This relay in turn may be coupled to any electrical device, for instance the ringing a bell, lighting a lamp, directing a torpedo boat, etc. The coherer of this principle is no longer used, other and more sensitive detectors having taken its place.

The Carbon Detector was a transient device, used but a short time for wireless work. It would be hard to find one to-day, although they became prominent

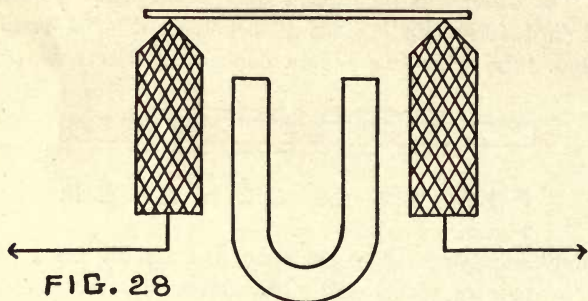

FIG. 28

CARBON DETECTOR

only a few years ago. It was an improvement over the coherer, being somewhat more sensitive and reliable. It is often called a microphone detector. It consists merely of two blocks of carbon, upon which rests a steel needle. The pressure of the needle upon the carbon is varied by the pull of the permanent magnet underneath. Adjustment depends upon having an imperfect contact between the needle and the carbon. The effect of electric waves upon this detec-

tor is to vary the resistance between carbon and needle and to indicate this in a telephone receiver, connected in the circuit together with a battery.

The Electrolytic Detector works on an entirely different principle, and was a great improvement over the two earlier forms. It is still largely used. This detector works on a rectifying principle. It may be

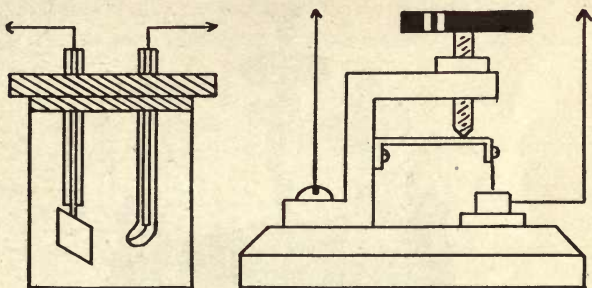

SEALED POINT

BARE POINT

FIG. 29

constructed in two ways, the sealed point and the bare point. The bare point has a fine platinum wire for an anode which rests in a cup of dilute nitric acid. In the sealed point type the fine platinum wire is sealed in a glass tube with its lower end flush with the tube's lower or sealed end. Both forms work on the same theory, which is shortly this: A fine platinum wire just touches the surface of the liquid, and when a slight battery current passes through the circuit,

bubbles are formed at the wire. If the adjustment is just right, these bubbles will continually form, thus making a gaseous insulation about the wire. Now, if there is an aerial and ground connection, a wave picked up by the former becomes a feeble alternating current which breaks down these bubbles. When the circuit between acid and point is thus made, the current

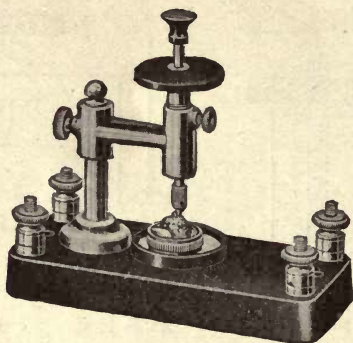

SILICON DETECTOR

passes through and may be detected in the telephone receivers connected in the circuit. At the same time, the acid rushing to the temporary conducting point starts up a direct current which is perceptible in the receivers. This is a rectifying effect.

An electrolytic detector is more easily made than purchased, and is quite as likely to be satisfactory. For the sealed point no adjustments are necessary, but the bare-point type requires very fine adjustments

indeed; for unless the wire can be placed exactly, no effect is produced. It is essential that a battery and potentiometer be used in circuit with either form.

The Solid Rectifiers, sometimes incorrectly called Crystal Detectors, may depend upon any one of several different minerals which have been proved by experiment to have rectifying influence upon alternating currents of high frequency. It is thought by many that this is aided by some thermo-effect. The silicon

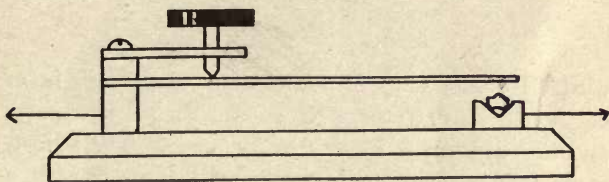

FIG. 30

detector was the first of this type to be universally considered successful. It is still one of the most important and popular ones. Its principle, as has already been stated, is that of a rectifier. No battery is necessary, although a battery and potentiometer help matters along to some extent. The silicon detector consists of a flat surface of highly polished silicon (the flawless kind is best), upon which rests a brass point. A circular or spherical piece of brass resting on the flat surface of silicon makes the finest contact of all. A good experimental form is to allow a sharp

fragment of silicon to rest upon a flat surface of highly polished brass. The detector stand should be so arranged that any part of the silicon surface may be

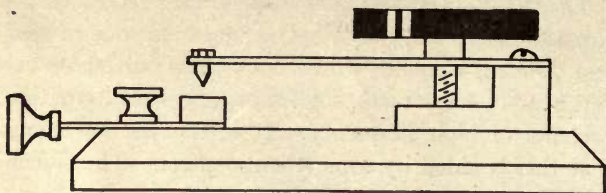

FIG. 31

used. Its simplicity is one chief advantage in favor of the silicon detector. No special care is necessary, and its adjustment is very easily made. The adjustment is, however, easily broken when used with a

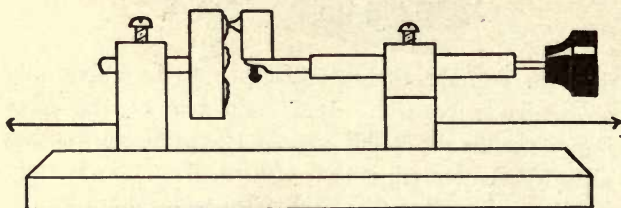

FIG. 32

transmitting set. Nevertheless the silicon detector is advised for all general purposes.

A very good solid rectifier or mineral detector is the *Pyron Detector*, which also works on a rectifying

principle. The adjustment is harder to obtain than with silicon, but once found is more stable, remaining for months at a time in a very sensitive condition. It works with a brass point against the oval fractures of the mineral iron pyrites, sometimes called "fool's gold." A pyron detector stand is somewhat different



PERIKON DETECTOR

from that for silicon, the cup containing the mineral being held more rigidly by a pivot and screw, so that adjustment, once found, may be retained.

The Perikon Detector is now generally held one of the best. It gives far more sensitive and quick adjustment than does silicon, and retains it better. It works on a rectifying principle. The perikon detector

consists of a vertical cup into which are fused five or more fragments of zincite, or zinc oxide. Another cup containing a fragment of chalcopyrite, or better still of bornite, is fused into a cup held at the end of a rotating rod which may be adjusted, by means of an inside spring, to any desired pressure against the zincite fragments. The zincite best for this work occurs in

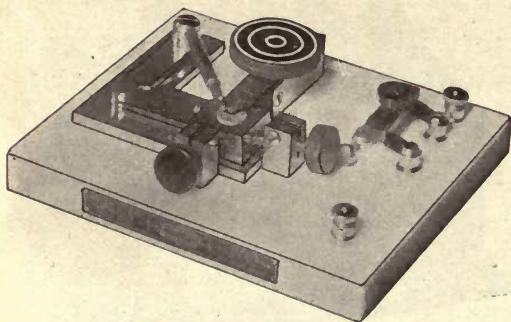

PERIKON-ELEKTRA DETECTOR

layers, and the cross-section of these layers forms the best surface for adjustment. A pressure of from $\frac{1}{2}$ to 2 ounces is necessary to secure the best results.

A very recent form is the new *Perikon-Elektra Detector*, which also acts on the rectifying principle. This detector uses a micrometer adjustment, and its stability is remarkable, while it is half as sensitive again as is perikon. This is Mr. G. W. Pickard's latest achievement in detectors.

There are numerous other forms of detectors, but those already described are the best and most sensitive. We will, however, mention two or three others in pass-

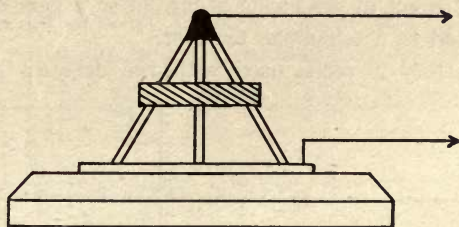

FIG. 33

ing. *The Tripod Detector* (Fig. 33) consists of three needles resting on an aluminum plate, and works on the principle of partial contact. *The Carborundum Detector* is a crystal form, somewhat less sensitive

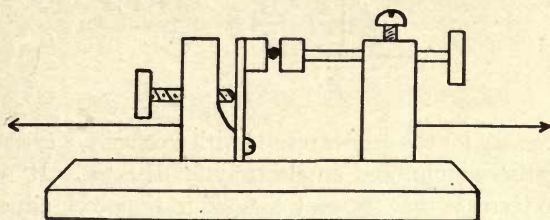

FIG. 34

than silicon (Fig. 34). It consists of a piece of carborundum resting between two carbon blocks.

The Magnetic Detector works on the principle of

diminution of hysteresis; that is, on the principle of the sudden drop in magnetism caused by a shock to a piece of shakily magnetized soft iron, and its consequent effect in producing a current in a near-by coil connected to a telephone receiver.

A battery is often used with the detector and is

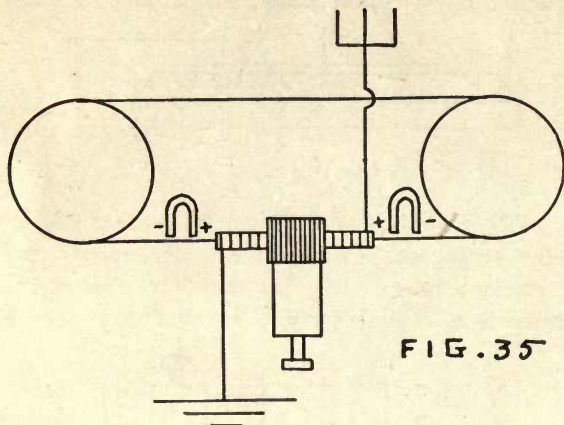

FIG. 35

necessary for the proper results with a coherer, a carbon, a carbörundum, and an electrolytic detector. It will also increase the efficiency and aid in the quick adjustment of the silicon, pyron, and perikon, but should not be used with the magnetic or perikon-elektra forms.

The choice of a detector depends largely on the kind of station constructed. For general experimental purposes, silicon is most adaptable. The electrolytic is

useful and very reliable, but inconvenient to handle. The patent rights on pyron, silicon, and perikon detectors make them more expensive, however much they are superior to other forms.

The potentiometer is a necessity when using an

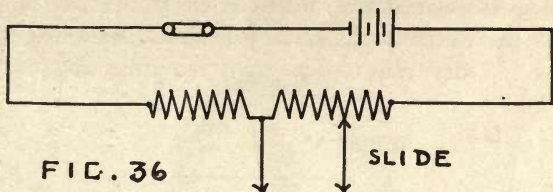

electrolytic, carborundum, carbon detector, or coherer, and an advantage even with a mineral detector. Its purpose is to vary the voltage, and thus to fix a definite amount of potential necessary for the best advantage

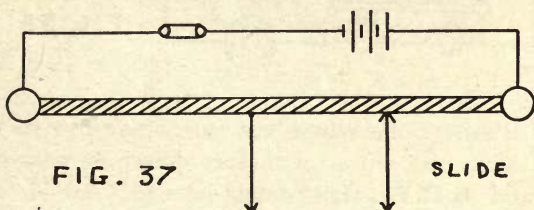

of the detector used. The potentiometer may consist either of German silver wire or a stick of high-resistance graphite connected across a local battery. A slide is necessary, and if desired, the potentiometer may be tapped in the middle and a lead carried

into the circuit. The advantage of this last is that the direction of the battery may be reversed without a pole-changing switch.

The potentiometer used with the silicon or other rectifying mineral forms may be of less resistance than that used, for instance, with the electrolytic detector. With the electrolytic, about 300 ohms resistance and three old dry cells are needed, requiring about 140

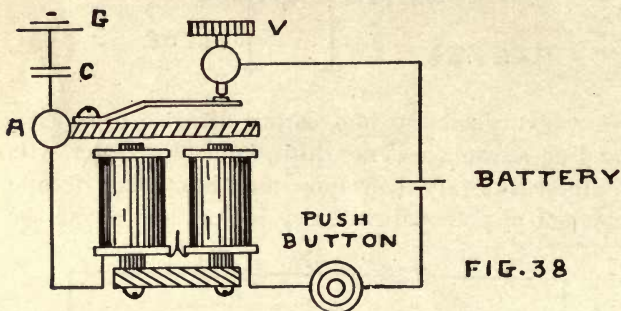

feet of no. 32 German silver wire or 90 feet of no. 36. With the silicon and other detectors, only one cell and about 150 ohms should be used.

A *Testing Buzzer* is of great advantage with any detector; it generates feeble electro-magnetic waves which affect the detector and thus enables the operator to obtain the most sensitive adjustment. A small buzzer is best, and a wooden push button affords the necessary insulation. Only one cell and a small con-

denser are needed. The diagram (Fig. 38) shows the connection. The vibrator point (V) or better the point (A) must be connected through the condenser (C) to the ground (G). The condenser should be about six square inches of tinfoil on each side of a sheet of waxed paper, with some variation of size, according to the strength of signals desired. It will be observed, how-

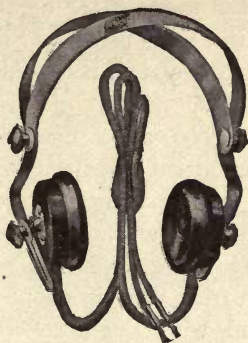

HEAD SET

ever, that weak signals are usually best, and for these a small condenser is needed.

Telephone Receivers are necessary with all of the more recent types of detectors, in order to make perceptible minute fluctuations of current. For wireless work receivers of high resistance are advisable, and up to a certain point, the higher this resistance the more sensitive the receivers are to feeble currents. Not that a great resistance makes the receivers sensitive,

but that a very large number of turns of fine wire around the magnet influences the magnetism of the core on receiving a much feebler current from the detector. Therefore very fine copper wire, a large number of turns, and their nearness to the core are the essential qualities of a wireless receiver. The classification of receivers according to resistance is merely a method of showing the number of turns and the fineness of the wire used; *i.e.*, the sensitiveness. All this is true up to a certain point only. The fineness of wire and the great number of turns used to wind receivers of over 3000 ohms does not add to their sensitiveness, the current dispersed over so much wire being incapable of imparting as much strength of magnetism to the core as in the case of receivers of from 2000 to 3000 ohms resistance.

As will be seen from what has gone before, receivers should be wound with single covered copper wire. Enamelled copper wire may be used for this purpose. A very recent receiver wound with this wire held inside a tiny spark gap in order to prevent burning off the insulation. Some unscrupulous dealers have partly wound the magnets with German silver wire in order to increase the resistance of the receiver, and thus to obtain a high price for it. It will be understood, however, by this time, that such a receiver is no better if as good as one wound with the same number of feet of copper wire, with a resistance usually one-thirteenth that quoted on the fraudulent receiver (the resistance

of German silver being about thirteen times as great as copper).

The receiver cases may be of hard rubber or aluminum. A composition material is most frequently used, and while very much cheaper is more brittle than hard rubber. For wireless work, a receiver must be of the bi-polar type, the single-pole type giving very unsatisfactory results. The diaphragm may be of ordinary thickness, especially in a receiver of a new design which has a small screw to adjust the distance between diaphragm and magnets. Thin gold-plated diaphragms are sometimes used in order to secure sharp signals, while thicker diaphragms will give signals of duller tone. Dull signals can be read in spite of static interference, which would make sharper signals unreadable. The gold-plate is to prevent rust, but lacquer serves the same purpose.

The head band for the receivers may be of nickelled brass or German silver, and may be leather covered for insulation. The convenience of the wearer will determine its shape. Sometimes pure gum rubber tubing is put over the head band, both for its insulation, and for the comfort to the operator. Rubber ear cushions over the receivers, which are often used, are not advisable. They increase the distance of the receiver from the ear and may weaken all very faint signals.

The Tuning Coil is a device by means of which the aerial circuit is increased (or tuned) so as to receive

incoming waves, whatever their wave length (train frequency). The tuning coil is arranged with one or more variable contacts so that this increase in the aerial circuit may be adapted to the length of any waves we desire to receive. The tuning coil is connected with the aerial circuit so as to synchronize (or time) the vibrations of the aerial with the wave length or train frequency of the transmitting station. This increase to the aerial circuit does not depend

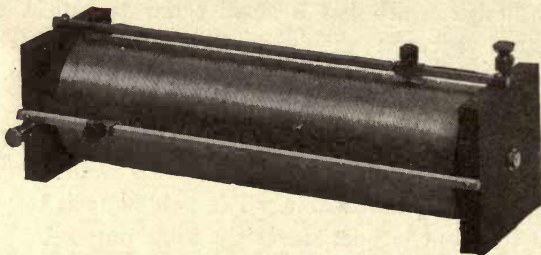

TUNING COIL

entirely upon the length of wire contained in the coil, but upon the amount of coil inductance in the aerial circuit or inductively coupled to it.

A tuning coil should be wound of soft drawn bare copper wire, approximately no. 22, on a core of unshrinkable highly insulating material, such as hard rubber or cardboard seasoned or soaked in shellac. Fibre is sometimes used, but is not to be depended upon. Bare copper wire is best, although single covered copper wire may be used if paths are cut

through the insulation for the slides. Enamelled wire is not good for a tuning coil; not only does it refuse to maintain its close tension around the core and become loose, but the enamel acts as a sort of condenser between turns because of its extreme thinness, and makes the tuning broader or less definitely sharp than is necessary. The wire of the coil must be well insulated, by winding in a thread cut in hard rubber, by spacing it on a screw-cutting lathe on cardboard, or by winding it with a thread between each turn. Such a coil should be from three to four inches in diameter and twelve or eight inches long. There is no advantage in having a larger coil, as the wave lengths of practically all stations come within this range. If a greater range of tuning is desired, which will be rare unless for the extremely long waves used by the transatlantic stations, it is better to have a *loading coil* which may occasionally be switched into the circuit, and which will not permanently burden it.

One, two, or three variable contacts (slides, sliders) are used on tuning coils. Although the three-slide form is employed for its greater selectivity and to produce a loose-coupling effect, the one and two slide forms are most popular for general use. The slides should have a phosphor bronze spring, preferably with a rolling contact, and a well insulated handle.

A *Loading Coil* is a supplementary coil used to give a greater inductance to the circuit, and thus to give it a greater range of resonance, and to enable it to

receive longer waves or those of much lower frequency. In form it is merely a single-slide tuning coil.

The Condenser collects and holds electricity. Its conductors are very close together, and adjacent ones are charged with opposite kinds of electricity — one negatively and one positively. An alternating current passes readily through a condenser, because the charge keeps changing from negative to positive and back

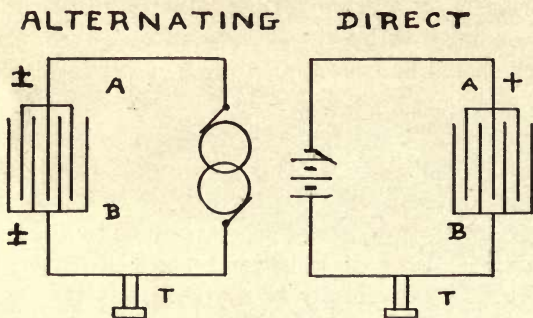
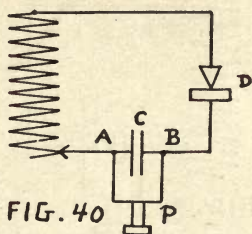

FIG. 39

again. A direct current, while it will give the same initial charge to the first plate, cannot pass through the condenser, since only the change of polarity will maintain the charge in the opposite plate. In other words, we have the two plates of a condenser (A and B), through which an alternating current is passing. When A receives a positive charge, it repels the positive charge from B and attracts the negative; thus B is negative. When A reverses and becomes negative,

B becomes positive for the same reason. The same process goes on; A, constantly changing, forces B to change, and the current continues. When a direct current is led to the condenser it charges A positively. B at once becomes negative and remains so. There is no change of direction in the current after the first connection, and therefore the charge remains fixed and no current can pass.

For wireless work, there are two kinds of condensers



— those which present a fixed value and those where the condenser value may be varied at the will of the operator. The former is called a *Fixed Condenser*, the latter a *Variable Condenser*.

A *Fixed Condenser* is used in order to balance one part of the circuit with the other. This is a part of the process of *tuning or bringing the circuit into resonance* with the transmitting station. Practically the principal use of a fixed condenser for receiving is to short-circuit (*shunt*) the telephone receivers. For instance, in the circuit shown in Fig. 40 the high frequency

current set up in the oscillatory circuit will more readily pass from A to B through the condenser (C) than through the receivers (P), since the latter offer a much higher resistance to it. When a detector rectifies the high frequency alternating current to a direct current, the condenser opposes the passage of this direct current, which therefore passes through the receivers and comes to our ears. A fixed condenser may also be used in the circuit to prevent short-

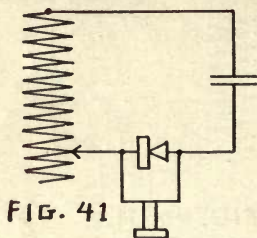

circuiting the detector, when the latter is connected across a coil. This latter connection is, however, of less advantage.

The capacity of a fixed condenser ranges between .002 and .005 microfarads (mf.). Those of large capacity should be used with telephone receivers of low resistance, of smaller capacity with receivers of higher resistance. This is because the larger wire used in the low resistance phone offers an easier passage to the current than the finer wire used in the higher resistance phone, and therefore the low resistance

phones need more condenser to balance the circuit than do those of higher resistance.

Where a potentiometer is used, it should be short-circuited by a fixed condenser and be placed with the phones (see Fig. 42).

The Variable Condenser is used to enable the operator to tune or bring the circuit into finer resonance than would otherwise be possible. If the point of sharp-

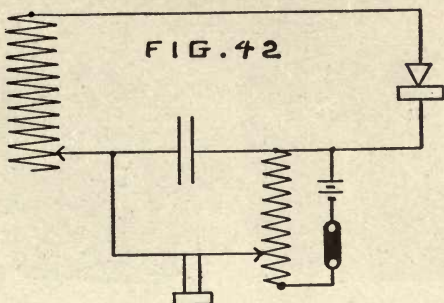

est tuning happens to come between the turns of the coil, and where it cannot be reached exactly by any of the slides, the variable condenser makes it possible for the operator to reach the exact point of sharpest tuning, and thus to obtain the most accurate results.

There are two very good kinds of variable condensers, the Rotary and the Slide Plate types. The Rotary type is the easiest one to manipulate and is the most convenient. If aluminum plates of large diameter, however, are used, there may be some sagging of the

metal, which will cause the plates to short-circuit. The Slide Plate type, while more troublesome to manipulate, has the advantage of greater stability, and its condenser values are more nearly proportionate to the adjustment.

The plates may be of brass or aluminum, and of

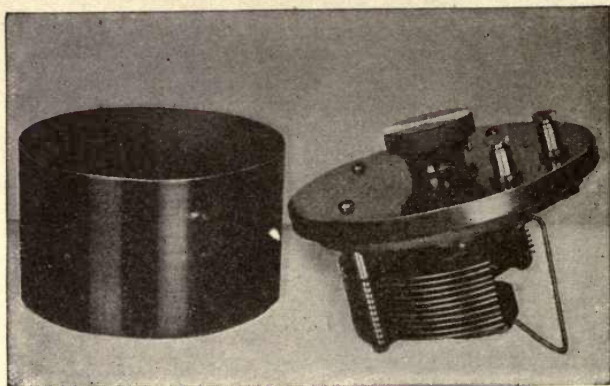

ROTARY CONDENSER

stock sufficiently heavy to prevent sagging. For this reason brass is more durable. The clearance between the plates should be as little as possible. Many commercial variable condensers have a clearance of $\frac{1}{32}$ of an inch. Those with $\frac{1}{64}$ are better, but are rare. The highest capacity of a variable condenser should not be over .004 mf., .003 mf. being that most often necessary.

An *Oscillation Transformer* is added to a receiving set in order to obtain more selective tuning than the ordinary tuning coil will give. They may be easily

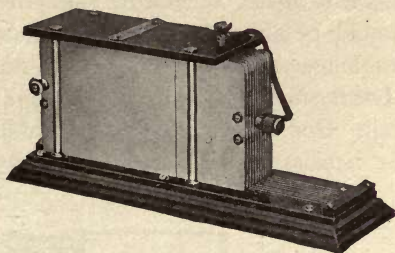

SLIDE PLATE CONDENSER

made and at small comparative expense. They are simple to operate, and generally increase the receiving range of a station.

The best oscillation transformers are wound on

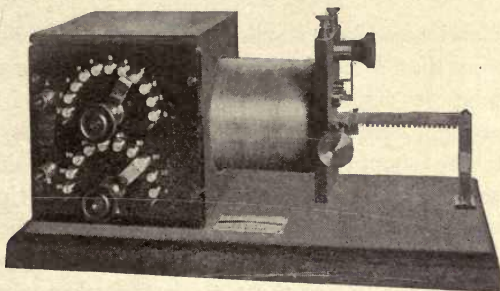

OSCILLATION TRANSFORMER

threaded hard rubber, both primary and secondary. Next to hard rubber comes shellacked cardboard, on which the wire may be spaced on a screw-cutting lathe or wound with thread for insulation. In size the *primary* should be about four inches in diameter and four inches long. No. 22 bare copper wire should be used, twenty-four turns to the inch, about 100 turns in all. One slide with rolling contact on the primary is necessary. The clearance between pri-

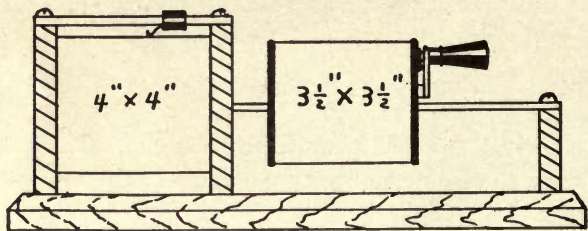
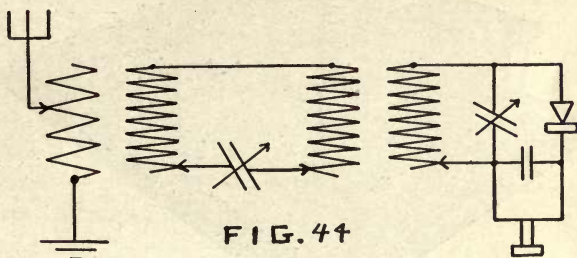

FIG. 43

mary and secondary should be as small as possible, not more than $\frac{1}{4}$ inch. The *secondary* should be about $3\frac{1}{2}$ inches in diameter, and the winding about three inches long. Nos. 26 to 28 bare or single silk insulated wire should be used, about 200 turns in all. The secondary should slide in and out of the primary, and not rotate inside, since by drawing secondary away from primary we vary not only the magnetic of the two coils, but also the mass capacity between the two. In this way we may cut out static effects which

interfere with our receiving. With 200 turns on the secondary, taps should be taken out every twenty turns and brought to a many-point switch.

By the addition of a second oscillation transformer, using a circuit like that shown in Fig. 44, much finer tuning still will be possible, although the difficulty of tuning will at the same time be increased. This is called a *Weeding-out Circuit*. Indeed it is possible to add another oscillation transformer, to gain still



finer tuning, and at the same time make tuning more difficult. Neither of these circuits will be used, however, except where the interference is very bad; and then only seldom, as there is a slight loss of energy as each one is added.

We have now mentioned all the usual instruments for receiving. Only a few out-of-the-way or merely experimental forms have been omitted, and those intentionally. We shall now give a selection of such sets of apparatus as are well fitted for use together,

and which will be adapted to certain receiving distances, at reasonable prices.

Receiving Set No. 1 with Single Slide Tuning Coil. Silicon Detector; one 80-ohm Receiver; Fixed Condenser (.004 mf.); Single Slide Tuning Coil, three inches in diameter and twelve inches long; Two-wire

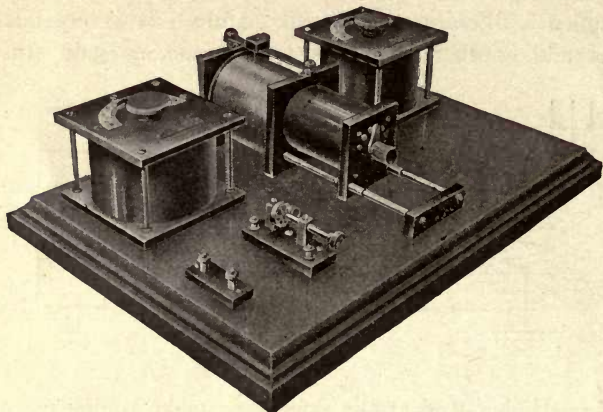

COMPLETE RECEIVING SET

Aerial of no. 12 or 14 copper or aluminum wire, 50 feet long and 50 high, of the T or L type. For receiving distance, use table on page 170.

Receiving Set No. 2 with Double Slide Tuning Coil. Silicon or Electrolytic Detector and Potentiometer; one 1000-ohm Receiver with Single Headband; Fixed Condenser (.003 mf.); Double Slide Tuning Coil, same

dimensions as in Set No. 1; Aerial as in Set No. 1. For receiving distance, see tables.

Set No. 3 with Double Slide Tuning Coil. Silicon or Electrolytic Detector and Potentiometer; two 1000-ohm Receivers and Double Headband; Fixed Condenser; Double Slide Tuning Coil; Variable Condenser, Slide Plate type; Four-wire Aerial, 50 to 75 feet long and 60 feet high, of no. 14 copper, aluminum, or phosphor bronze wire, T, L, or Fan types. For receiving distance, see tables.

Set No. 4 with Three Slide Tuning Coil. Silicon or Perikon Detector; 2000-ohm Receivers, as in Set No. 3; Fixed Condenser as in Set No. 2; Three Slide Tuning Coil, same dimensions as in Set No. 1; Variable Condenser, either Slide Plate or Rotary type; Aerial as in Set No. 3. For receiving distance, see tables.

Set No. 4 with Oscillation Transformer. Perikon Detector; Potentiometer; two 1500-ohm Receivers and Headband; Fixed Condenser (.0025 mf.); Receiving Oscillation Transformer; two Variable Condensers (.003 mf. each). The receiving range of this set may be increased practically without limit, according to the type of aerial used. For aerial, see Chapter VI and diagrams on page 71.

CHAPTER VI

AERIALS AND GROUNDS: TYPES AND CONSTRUCTION

OF first-rate importance in constructing a wireless station is the choice of a type of aerial and a good ground connection for the apparatus. Ground connections are usually easy to obtain and cause little difficulty. Not so, however, with the aerial. We must select a type of aerial suitable for our surroundings, and we must decide upon the size necessary for the transmitting and receiving distances we wish to cover, and we must consider the mechanical difficulties of construction, the cheapest kind of wire suitable for the necessary spans, and the proper insulation of it.

Any aerial which can be used for transmitting makes a good receiving aerial. The converse of this is not always true, for not every good receiving aerial can also be used for transmitting. Therefore the wireless operator will always wish to construct a transmitting aerial, and those described in this chapter are of this kind and may be used indifferently for both purposes. This simply means that there must be a number of strands and that the extreme height of the aerial is somewhat less than its length.

The *Straight-away* and the *Loop* are terms used to indicate the method of connecting the aerial. In the straight-away form all the upper wires end dead on an insulator. These upper wires in the *loop form* are all connected together and divided into two sec-

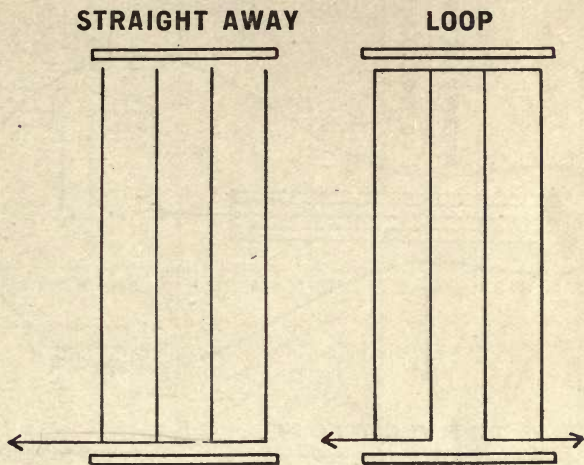

FIG. 45

tions at the bottom, as shown in Fig. 45. Aerials of almost any type may be erected in either form, but while the loop gives slightly better results on a short aerial, the straight-away is decidedly the more efficient in most cases.

There are about six types of good aerials, but the combinations of these are almost innumerable. Each

of the main types, however, is distinct; and it seems best to confine our attention to their principal features. In the order of similarity of construction these are

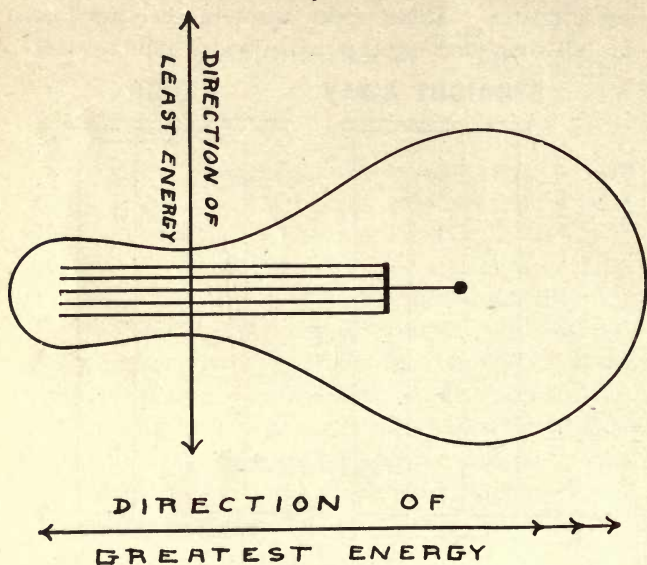

FIG. 46

the *T*, the *Vertical*, the *L*, the *V*, the *Fan*, and the *Umbrella* types.

Of all these the *T* is most nearly perfect and gives the best results. For one thing, the *I* aerial is not directional to any considerable extent, as is the *L* or the *V* type.

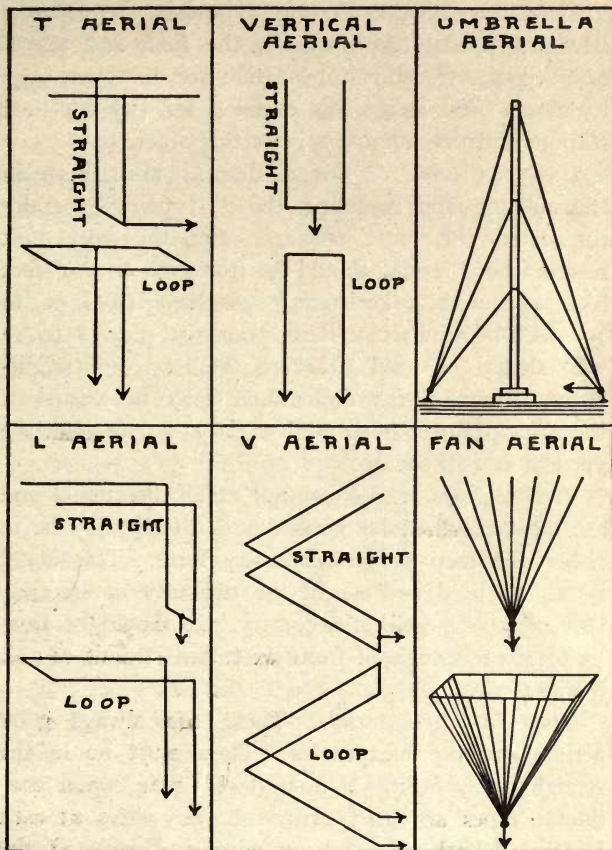

DIAGRAM OF AERIALS

After the *T*, the *Vertical* type has the greatest advantage, then the *Umbrella*, the *Fan*, and the *L* or *V* types. Questions of location are, however, very important in making this decision for any specified station, and may almost reverse this order.

T Type Aerials. For all-around work both in transmitting and receiving the *T* type is generally considered the most efficient. For the very best results the *T* aerial should be from 100 to 200 feet high and with a horizontal stretch of from 90 to 190 feet. From six to ten strands of nos. 8 to 12 wire should be used either in the loop or straight-away forms. These dimensions may be varied if the principal of a horizontal slightly shorter than the vertical is adhered to.

Vertical Type Aerials are not at all directional and are most excellent for general use. They may be in either the loop or straight-away form. This aerial is seldom used because of the difficulty of erecting. One very long pole is necessary. It should be from 75 to 200 feet high, of from six to ten strands of nos. 8 to 12 wire.

Umbrella Type Aerials. These are always good aerials and are inexpensive. They must be in the straight-away form. If instead of a pole, water conductor pipes are used, with four guy-wires at each joint, and both pole and guy-wires are insulated, the latter with strain insulators, the whole thing may be used as an aerial, and is very efficient. In size the

umbrella aerial may be from 50 to 150 feet. The guy-wires will have to be proportional to the height of aerial and the strain upon them. Phosphor bronze or galvanized iron wire should be used. For a 50-foot pole nos. 12 or 14 phosphor bronze would be sufficient, while for a 150-foot pole nos. 4 to 8 stranded steel cable is necessary. This type is becoming very popular.

The L or Horizontal Type Aerial may be either in the loop or straight-away form. It has the disadvantage of being somewhat directional. It should be about 100 feet long and 100 feet high, with eight to ten strands of 8 to 12 wire. This type is very common. It has often a length of 200 feet to a height of 50 to 75, which is all right for receiving, but is objectionable for sending.

The V Type of Aerial is used where the highest point must be near the station, with a lower point some distance away. This type is especially good in crowded quarters, and while slightly directional, gives excellent results. It should consist of six to ten strands of nos. 8 to 12 wire, about 100 feet long on each stretch. The height should be over 50 feet, and preferably 75 feet.

The Fan Type is especially good in crowded quarters also. It is not directional and must be of the straight-away form. It should be composed of from fifteen to twenty strands of nos. 12 to 14 wire and should be from 30 to 90 feet high. There are two kinds of fan-type

aerials — one consisting of a single fan suspended between two poles, the other formed of four fans suspended around four poles, such as is used in the Marconi Station in Wellfleet.

Almost as important as the comparative efficiency of different forms of aerials is the fitting of those types to the location of a station. All the surroundings must be considered and must have due weight in the final decision. The best location for a station is on a hill and near the seacoast. Directly on the seacoast or on an inland hill are both good locations. A wireless station in a forest or in the middle of a large city is at the very greatest disadvantage, since the trees and the trolley lines and iron frame buildings of the city absorb waves of almost any wave lengths in use, except the very long waves of a few such stations as Marconi and Fessenden.

If buildings are crowded together in a city or there are near-by trees, the umbrella type on top of the building will probably be advisable. Where great height cannot be obtained, the loop form should be used. The fan aerial is also very good under these circumstances. Long wave lengths for transmitting are necessary to avoid the absorption which shorter lengths would undergo amid crowded buildings.

In the country it is most desirable to get a location on a hill-top; and if possible, one free from trees. If guy-wires are attached to trees, a series of strain insulators should be placed between tree and aerial.

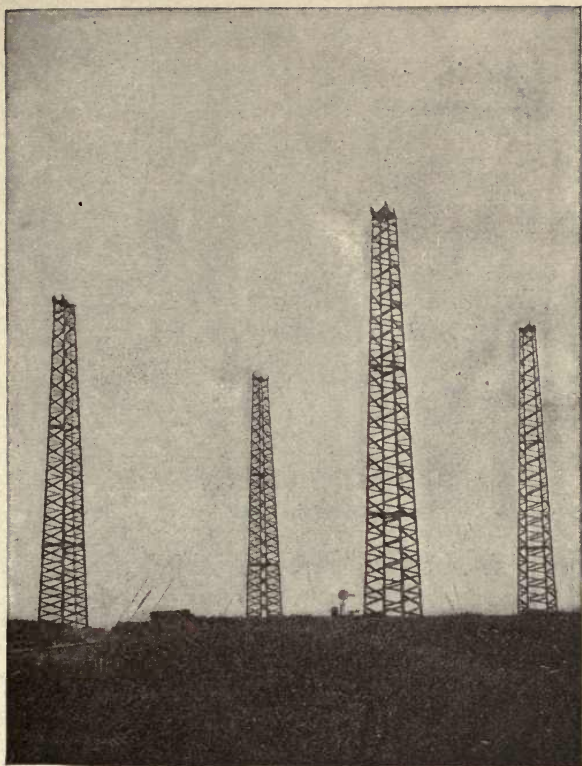

MARCONI STATION

Copper wire is the very best for an aerial. Next in conductivity comes phosphor bronze. Phosphor bronze wire should be used on all stretches of 100 feet and over. Aluminum wire is not as good a conductor as copper, although some of the larger sizes will do just as well. One of its advantages is its cheapness. It is very light also; eight or ten strands of aluminum wire cause very little strain to the cross-arm. Iron wire, because of a certain reactance effect, is a poor conductor and should not be used in the regular aerial, except in the umbrella type, where a great number are used in multiple as guy-wires. Only galvanized wire should be used.

Following is a list of the best sizes and materials of wires at best advantage in any good aerials.

	Size (B & S)
Copper wire, stranded, solid, or tinned	8-14
Phosphor bronze, stranded or solid	6-12
Aluminum, solid	6-12
Galvanized iron, solid (for umbrella type only).....	4-10

Insulation for Transmitting and Receiving Stations.

The proper insulation of an aerial plays a very important part in the transmitting as well as in the receiving distance. One of the greatest faults in the experimenter's transmitting station is that of leakage from improper or poor insulation. In erecting an aerial, two insulators should be used between each wire and the cross-arms. Not only that, but the ropes holding the cross-arms and all guy-wires should be

protected by petticoat strain insulators. The following is a list of the proper insulators for transmitting powers:

1 or 2 inch spark coil	wire cleats or spool insulators.
$\frac{1}{4}$ kw. set	2 inch strain insulators.
$\frac{1}{2}$ " "	2 " petticoat strain insulators.
1 " "	6 " " " "
2 " "	6 " " " "
3 " "	18 " " " "
5 " "	18 " " " "

To ascertain the total strain (T) upon the insulators, the following equation may be used:

$$T = \frac{L^2 W}{8 S}$$

where L is the length of wire in feet, W the weight per foot in pounds, and S the total sag of the wire in feet. For example, if we have the following: Wire, no. 6; weight per foot, 0.112 lbs. (with insulators); sag, one foot; span, 100 feet,

$$T = \frac{(100)^2 \cdot 0.112}{8 \times 1} = \frac{1120}{8} = 140 \text{ lbs., total strain on}$$

insulators.

If an aerial is selected and erected according to these principles, the operator may be sure that he is getting approximately all the efficiency out of his station. As this is so important, he should take great pains in each part, in order that the result may be as faultless as possible.

Closely associated with his aerial efficiency is the adequacy of his ground connections. Although a good ground is nearly always easy to obtain, care should be taken in assuring oneself that it is a good ground.

The ground connections for sets up to one and two kilowatt should be made to water-pipes, with a

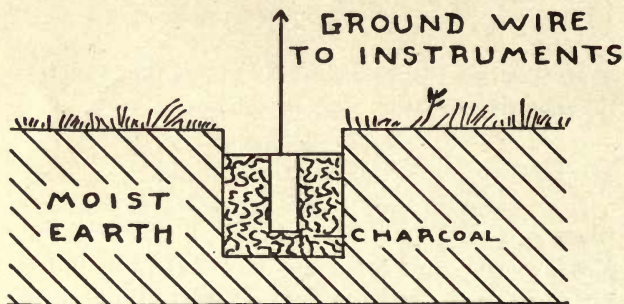

FIG. 47

no. 6 to 8 insulated wire. In all cases this ground connection should be made at or near the street side of the water-pipes, or where it enters the ground. Even a receiving station should be properly grounded in case of thunderstorms. Gas-pipes are not always an efficient ground, because they do not always form a sure connection; a certain red paint used in the joints sometimes acts as insulator. A water-pipe, on the other hand, is always a good ground.

A very good method of getting a ground connection for experimental purposes on a water-pipe is to scrape the pipe well and bind it with tin or lead foil. Upon this is wound a bright piece of new wire, the ground-wire. Another sheet of tinfoil outside is then covered with tape, if it is to be used permanently.

Where water-pipe grounds are not available, several methods may be resorted to. One way is to bury a copper ground plate in charcoal with a good-sized lead (wire 6-8) to the instruments. Another good ground for stations near the water is to throw overboard a large metal plate securely fastened to a substantial lead which runs to the instruments. Still another method, and the best, is to lay several hundred square feet of wire chicken netting over charcoal spread on the surface of the ground. This can be used even on sand, which forms the poorest connection possible.

When an efficient aerial and a good ground connection are secured, the operator may turn his attention to the installation of his station, which we shall proceed to treat in the following chapter.

CHAPTER VII

PROTECTION AND INSTALLATION OF A STATION

HAVING assembled all the separate parts of the wireless station, when the aerial has been erected and a good ground connection made, there still remains the by no means simple task of assembling them and of putting the completed station into working order. The steps in this process are first the protection and then the installation of the instruments in their places. Protection of a station includes both its preservation from lightning and also prevention of injurious effects upon the lighting system or the metres of the household. Installation of a station relates to the wiring of the transmitting apparatus both for alternating current and for direct current with interrupters, and then to the placing and wiring of the receiving apparatus.

Let us begin with the aerial. As it enters the station the aerial should be protected by a one-piece insulator. If, for instance, the wires are brought through the outer wall of the house, one continuous containing tube of porcelain, hard rubber, or electrose should extend four or five inches beyond either surface of the wall to stop any leakages of current. Small porcelain tubes may

be used on spark coils operated by battery current, but an electrose or hard rubber tube one inch thick should be used on sets of from $\frac{1}{4}$ to 1 kw.; for stations of from 1 to 3 kw. hard rubber or electrose insulation two inches thick is necessary; while for sets up to 5 kw. electrose insulators at least three inches thick all around the wire will be needed.

The wires for all leads from the aerial to the apparatus

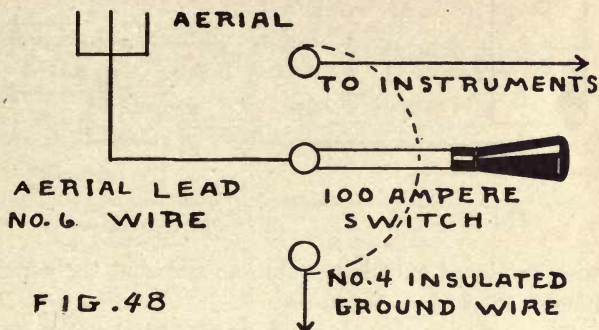
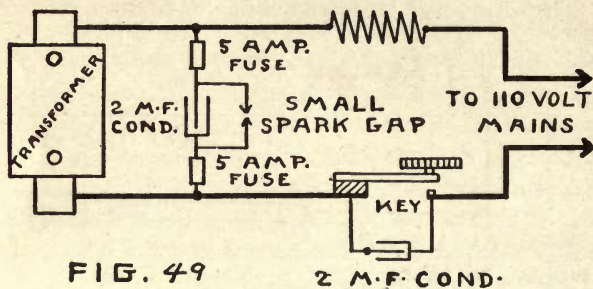

FIG. 48

should be of no. 6 copper wire, rubber insulated. Fire Underwriters' Rules declare that all aerial wire going into a station should be connected to a 100-ampere switch. This switch should be of the single pole double throw order, with the aerial connected to its centre or handle pole. It is advisable to use a double throw switch, since the instruments are entirely cut out when the aerial is grounded, which is not the case if a single throw switch is used. To the lower pole

should be connected an insulated, no. 4, ground wire, joined to the water-pipe on the street side of the water-metre, or to one of the ground connections described in the previous chapter. The upper pole of the 100-ampere switch is connected to the apparatus through the ordinary switches. In cities, Fire Underwriters' Rules order that this switch and the ground



wire be placed outside the station, and that the aerial be grounded when not in use.

The protection of a wireless station includes the safeguarding of the line and metres, of the key, and of the step-up or transmitting transformer. For direct current, little protection is necessary, but this is not the case where alternating current is used.

Thorough protection of the line, key, and transformer from $\frac{1}{4}$ to 5 kw. for alternating current are shown in Figs. 49 and 50.

The sending or step-up transformer should be shunted with two 5-ampere fuses and one 2-mf. con-

denser across which is a small protective spark gap, the whole connected in series across the primary of the transformer. This is the best protective device known, and will prevent all kick-backs. It will be found advisable to use a 1 or 2 mf. condenser across the contacts of the key, where these are not large enough to prevent its sparking or sticking.

The proper protection for the line is shown in Fig.

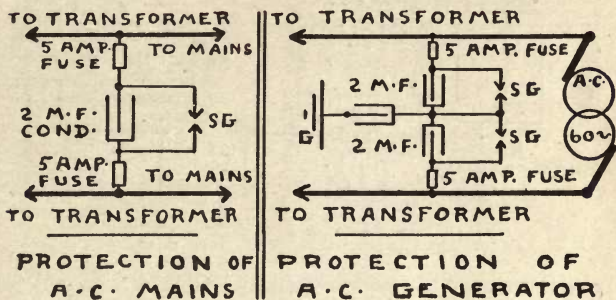

FIG. 50

50. This device is situated near the metres and consists of an arrangement similar to that placed across the transformer; two 5-ampere fuses are connected in series across the main line with a 2-mf. condenser. Across this condenser is placed another protective spark gap with a distance between the gaps of about $\frac{1}{8}$ of an inch. This device is sufficient to protect the line transformer and metres from any kick-backs in the circuit.

For the protection of an alternating current generator it is necessary to use a more complex arrangement of fuses, condensers, and spark gaps. Across the generator are placed two 5-ampere fuses and two 2-mf. condensers in series. Across these condensers in turn are two protective spark gaps. A connection between the two condensers is grounded through a third 2-mf.

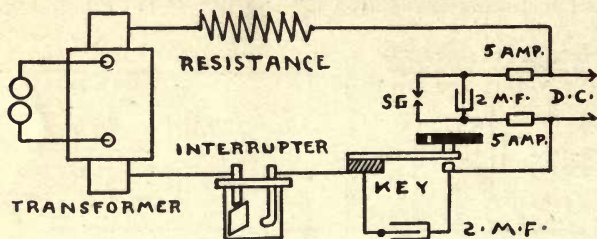
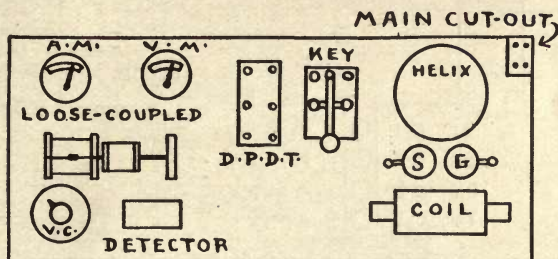

FIG. 51

condenser. This device is especially for motor generator sets and affords adequate protection there.

With direct current somewhat simpler safety devices are necessary. Direct current, however, is not nearly so good as alternating current, for some kind of an interrupter must be used in order to obtain the pulsating current described in Chapter I. Fig. 51 shows a method of protection for direct current. The key is shunted with a one or two microfarad condenser, while the main line has two 5-ampere fuses in series, with a condenser and protective spark gap. This affords sufficient protection for ordinary circuits.

Installation. A broad table is the best thing for mounting the instruments of a wireless station. If this is used the convenient position of the instruments may be easily determined, and by judicious grouping a slight movement of the hands will control them all. All of the switches used in changing from sending to receiving should be beside the key, in order to facilitate the operator's movements. The most convenient



OUTLINE OF INSTALLATION
FIG. 52

arrangement places the transmitting apparatus at the right and that for receiving at the left.

All connecting wires for the transmitting apparatus should be rubber insulated, no. 14, stranded, copper wire. Porcelain or hard rubber insulators are necessary where the wires pass through the table. Care must be taken in wiring underneath the table, as well as on top. On the extreme right is the main cut-off for the sending instruments. If an electrolytic

interrupter or a rotary converter is used, it should be encased beneath the table, where it will be out of the way. Where alternating current is used reactance regulators will cut down the current. With sets from 2 to 5 kw. these are of the best advantage. However, reactance regulators are expensive and hard to build, so a bank of lamps may be used for resistance with

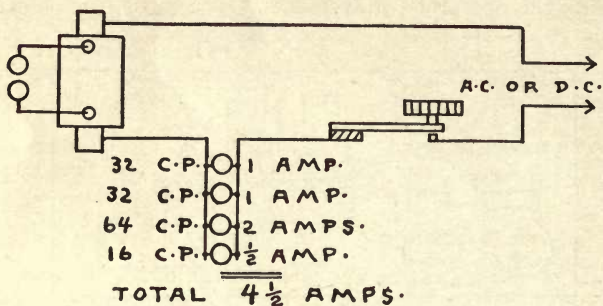

LAMPS USED AS RESISTANCE
FIG. 53

small sets using either alternating or direct current. An 8-candle-power lamp allows a $\frac{1}{4}$ -ampere current to pass; one of 16 c.p. allows $\frac{1}{2}$ ampere; one of 32 c.p. allows a full ampere to pass. If we want a current of $4\frac{1}{2}$ amperes, then, we place in the circuit one 64 c.p., two 32 c.p., and one 16 c.p. lamps, thus securing the necessary amperage.

The receiving apparatus, we have decided, will be on the left of the table. In wiring up, rubber covered,

no. 16 or 18, stranded, copper wire will be necessary. The leading wires of the receiving instruments should be placed on top of the table, so as to leave the under side clear for the transmitting wiring.

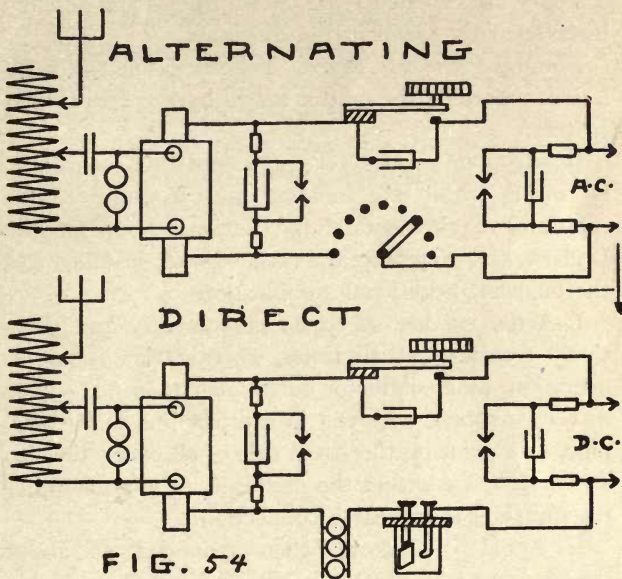

FIG. 54

All leads both for sending and receiving apparatus should be as short as possible. For these and the connections the operator is strongly advised against using the tinsel telephone cords, their resistance being very high.

If pains are taken in following these directions, and

a careful study is made of the diagrams, the operator will find every instrument in his station within easy reach of his hand. Variations may sometimes be advantageous under special circumstances, but for ordinary use experience has shown the placing of every instrument as shown in the diagrams.

Fire Underwriters' Rules. Following are the regulations regarding the matter issued by the Fire Underwriters:

In setting up wireless telegraph apparatus (so called), all wiring within the building must conform to the rules and requirements of the National Board of Fire Underwriters governing the class of work installed and the following additional specifications:

I. Aerial conductors to be permanently and effectively grounded at all times, when station is not in operation, by a conductor not smaller than no. 4 B. & S. Gauge copper wire run in a direct line to a water-pipe, at a point on the street side of all connections to said water-pipe within the premises; or to some other equally satisfactory earth connection.

II. Aerial conductors when grounded as above specified must be effectually cut off from all apparatus within the building.

III. Or the aerial to be permanently connected at all times to earth in the manner specified above, through a short gap or lightning arrester; said arrester to have a gap of not over .015 of an inch between brass or copper plates not less than $2\frac{1}{2}$ inches the other way with

a thickness of not less than $\frac{1}{8}$ of an inch mounted upon non-combustible non-absorptive insulating material of such dimensions as to give ample strength. Other approved arresters of equally low resistance and equally substantial construction may be used.

IV. In cases where the aerial is grounded as specified in no. I, the switch employed to join the aerial to the ground connection shall not be smaller than a standard 100-ampere jack-knife switch.

V. Notice of wiring done for these installations should be sent to the board, the same as for all other electrical work.

CHAPTER VIII

OPERATION OF A STATION

IF good care is taken of a station, it will generally work to its highest advantage. The operator should see that his apparatus is carefully handled at all times and that his transmitting apparatus is always in proper resonance. This chapter will take up not only general questions of care of instruments, but it will deal with tuning devices suitable both for fine apparatus and for the more inexpensive instruments. Hints on the improvement of a station's working will be no small part of this chapter's interest, and in this respect we are now coming to what is perhaps the most important part of the subject.

No general suggestions can apply both to transmitting and receiving apparatus, since the range of distance covered by the two is always different: Therefore we shall take up the two in turn, dealing with the separate parts of our subject-matter first as applied to sending and then to receiving.

Transmitting Apparatus. The working of the station depends largely upon the care that is taken of it, and for that reason apparatus should at all times be kept

free from dust. This is especially true of all spark gaps, the large one used for transmitting, and all small protective gaps. If dust collects between the sparking surfaces, it acts as a conductor, the gap is short-circuited, and then the fuses blow or burn out. Once the adjustments of the spark gaps are made, these should be boxed in and left alone. Wherever also there are small contact points, as in the vibrator or key, a particle of dust may cause considerable trouble.

Operation of transmitting apparatus does not lie in the manipulation of the key so much as in tuning up the helix or condenser. This tuning up of the apparatus brings the helix into resonance with the aerial and with the condenser. It is the most important factor in operation and is one requiring skill and experience.

The theory of resonating or tuning up the transmitting apparatus is as follows: The helix has three contacts, a ground connection, which should be stationary, and two variable connections, one in series with condenser and spark gap, another leading to the aerial (see Fig. 55). The helix is thus divided into two parts or inductive fields, one included between ground and condenser, the other between ground and aerial. These are called inductances (L^1 and L^2). The aerial ordinarily acts as a condenser so that now we have two groups or circuits, consisting, in the first place of the aerial condenser (C^2) and helix inductance (L^2), which act as a secondary; in the second place of the condenser (C^1) and the inductance (L^1), which act

as a primary. These two circuits must be equalized to secure good results, *i.e.*

$$\frac{C^2 \times L^2}{\text{secondary}} = \frac{C^1 \times L^1}{\text{primary}}$$

Bringing this condition about by manipulating the helix contacts is called *tuning*.

The variation in the condenser (C^1) and helix (L^1) necessary to secure the same value as the aerial (C^2)

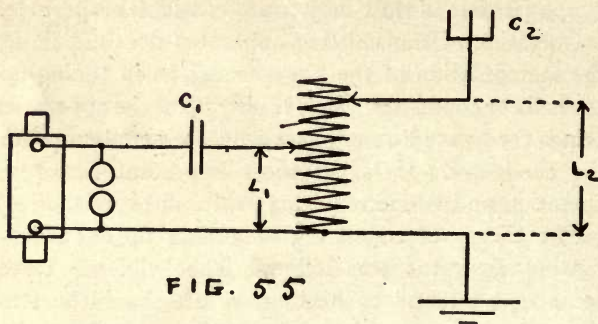

and inductance (L^2) may be done theoretically either in the condenser or in the helix. Practically, however, it is so much easier to move the helix contacts than to cut tinfoil off the condenser plates that the helix is almost always made variable, the condenser stationary. Further, it is necessary to notice that the relative position in the circuit of spark gap and condenser is unimportant and may be changed.

There are several methods of tuning both with the helix and with the oscillation transformer. Two spe-

cial instruments are used in tuning, the Geissler tube and the hot-wire ammeter, the latter being the more efficient.

The Geissler Tube is a glass tube, in both ends of which are sealed electrodes, generally of platinum. The air in the tube being exhausted or nearly so, a spark will readily jump between the metal electrodes in the rarified air. If a slight current is passed through, a faint light is diffused throughout the tube. Increase in its light marks the passage of a stronger current,

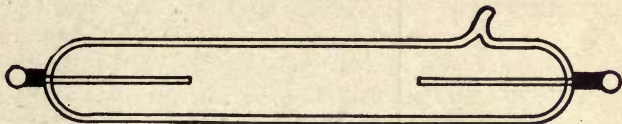

FIG. 56

and the maximum brilliancy marks the highest point of a high frequency current. A *Geissler tube* of plain design is shown in Fig. 56.

The Hot-wire Ammeter is a much more delicate instrument. It depends upon the fact that a German silver wire will expand when heated even slightly. A simple form is shown in Fig. 57, but all such instruments work on variations of the same principle. A German silver wire is stretched between two points (A and B), to the middle of which is attached another wire connected to the end of a fine aluminum needle (D). This needle turns on a pivot or fulcrum (F) and

is shown on the dial scale (E). Now if the instrument is connected in an electrical circuit, a slight current passing through (A) and (B) expands the g.s. wire, which lets down the wire (C) and causes the aluminum needle (D) to deflect from the point of

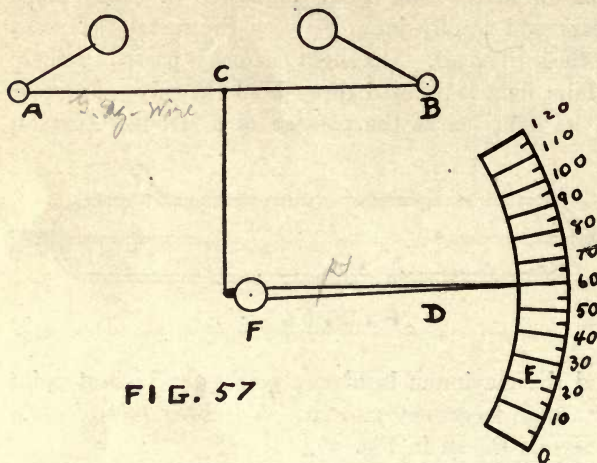
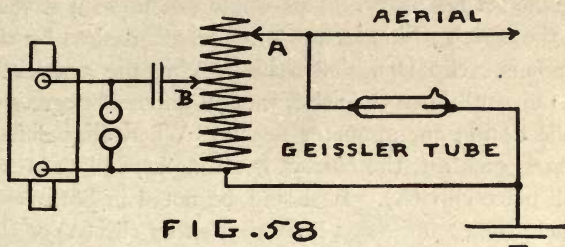

FIG. 57

equilibrium (0°). Where the needle shows the greatest deflection will be the point of greatest current strength. Since the ammeter is very delicate, a variable resistance should be shunted across it, to prevent burning out the wire.

The first step in tuning is to move the condenser clip (B) on the helix until a desired wave length is obtained. Thereafter this clip will remain fixed.

Across the helix, between helix and aerial, is now placed this Geissler tube, which shows by its point of greatest brilliancy the exact position for the clip (A). When



tuning-in the circuit, the light in the tube may be lessened in intensity by decreasing the spark gap. By moving the aerial clip (A) on the helix, with a faint light in the Geissler tube, it will be easy to find the point where a perfect balance occurs, by the maximum

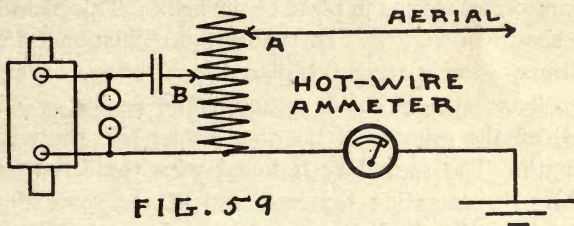

brilliancy of the tube. This is the point of finest tuning or resonance.

A second method of tuning the helix, by using a *hot-wire ammeter*, is better and more exact (Fig. 59).

The ammeter should be placed in the ground circuit, or between ground and aerial, the former method being preferred because the apparatus can then be handled if necessary. This would not be so if it were in the aerial. First fix the wave length desired by the condenser clip (B). Then by moving the aerial clip (A) up and down the helix, we find different degrees of deflection in our ammeter needle. Where that deflection is greatest, the current is strongest, and there we will place clip (A). It should be noted in both cases where tuning up with a helix that either clip (A) or (B) may be used to determine the wave length, the variation being made by the other clip.

With the oscillation transformer the use of tuning instruments is much the same. However, it is possible to secure resonance by the aid of a small auxiliary spark gap, and without special instruments when a transformer is used in place of the helix. This method is shown in Fig. 60. In tuning the oscillation transformer, a test spark gap is placed across the secondary, *i.e.* between aerial and ground. The condenser clip (B) on the primary of the transformer sets the wave length. The secondary is tuned with the aerial clip (A). By operating the key, and at the same time watching the discharges at the auxiliary spark gap, we will find where they are most rapid. In repeating the process the point of highest resonance may be found. This method of tuning is, however, by no means easy, and considerable quickness is required to

count the dots of the key and at the same time note the discharges at the gap. It is advisable only because of the simplicity of the instruments.

When using the Geissler tube with an oscillation transformer, it should be placed in exactly the same position as the auxiliary spark gap shown in Fig. 60.

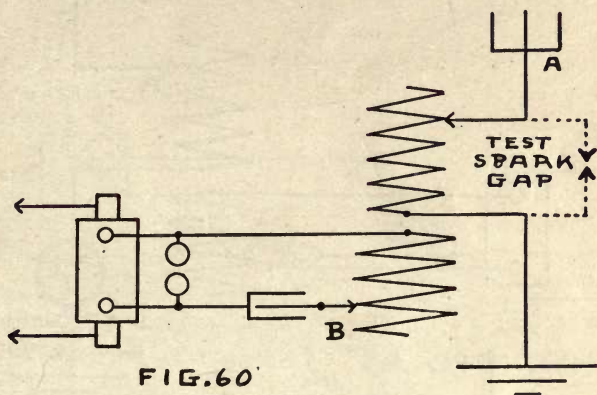

FIG. 60

The maximum brilliancy will show the point of highest resonance for the secondary, the primary determining the wave length by the condenser clip (B).

The hot-wire ammeter is placed in the ground circuit connected with the primary of the oscillation transformer and is used in the same way as with the helix, the condenser clip (B) setting the wave length as in previous examples.

Still a third method of tuning up is as follows: An

ordinary $1\frac{1}{2}$ -volt Tungsten lamp placed in the ground circuit is bridged with a variable resistance. As you press the key and at the same time vary the resistance, the point of brightest light having the lowest resistance

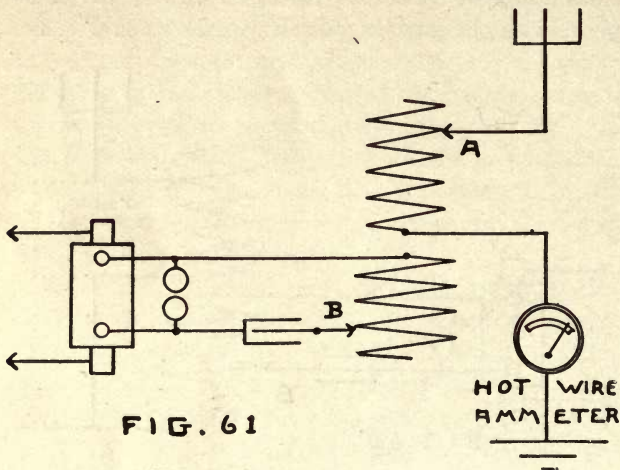

will show best value of balance and the best position for clip (A).

The coupling between primary and secondary should be carefully regulated, so that the two coils be far enough apart to secure sharp tuning, and at the same time be near enough to prevent too great loss of energy. If the two coils are too far apart, they will lose part of the inductive effect upon each other; that is, they will be out of inductive range. If they are too near

together the secondary's reactance on the primary will cause a hump in the wave, and two points of tuning will be the result, the stronger point representing the main tuning point, and the weaker one showing the split or division of energy.

With the transmitting instruments perfectly tuned,

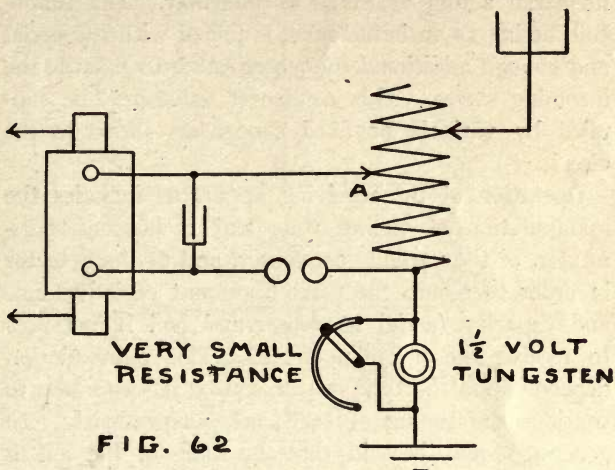

FIG. 62

it is necessary only to manipulate the key quickly and easily. This is, of course, largely a matter of quickness of movement and practice. The matter of the various codes now in use will be further discussed in Chapter X.

Receiving Apparatus. The operation of receiving apparatus consists principally of bringing the instru-

ments into resonance with those of a transmitting station whose messages we desire to receive. In theory the tuning of receiving apparatus is the complement of that of transmitting. Waves of a certain length are sent out from the transmitting station, and the receiving station must be able to catch them on its aerial acting again as a condenser. The tuning coil, acting as an inductance, is joined with the aerial and enough additional condenser value to balance the incoming waves. This condenser value may be supplied by variable or fixed condensers added to the circuit.

Operation of the receiving apparatus includes the manipulation of tuning coils and oscillation transformer, of the variable condenser, and of the detector in order to secure the correct amount of inductance and capacity (aerial condenser and coil inductance) to receive the incoming waves. This manipulation depends upon the type of coil, so that it seems best to consider the tuning of each one independently. In general, it may be said that the slides of the coil or the oscillation transformer should first be brought roughly into tune with the station sending, then the variable condenser should be brought to the point of highest resonance before adjusting the detector.

The Single Slide Tuning Coil is most frequently used without a variable condenser. Under such circumstances there is only one movement to be made, one slide to be moved. (Fig. 63.)

The *Double Slide Coil* should be used with a variable condenser, although of course fair results may be obtained without. The clips are lettered (A) and (B). A rough adjustment is found with (A), and this is made more sharp by (B). The last and finest adjustment is made with the variable condenser (VC). (Fig. 64.)

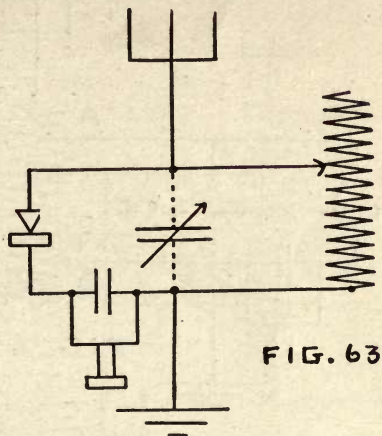
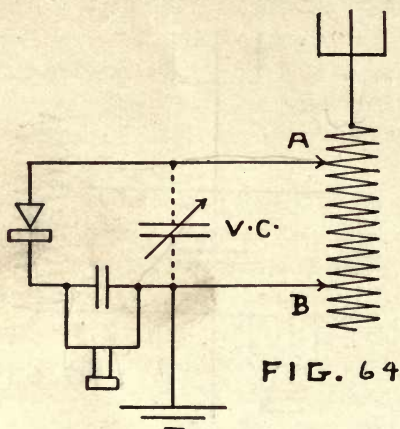

FIG. 63

The *Three Slide Tuning Coil* has an effect similar to the *Loose-coupled coil*, but it is not so selective; *i.e.* it will not bring in one station without interference so well as the latter. In Fig. 65 are shown the three slides; the ground clip (A), between which and the aerial is formed a primary circuit; the distance between clips (B) and (C) forming the secondary circuit, while the coupling is regulated by varying the distance

between (A) and (BC). The first adjustment, which is only approximate, is obtained with (A). Then a more careful tuning is secured by moving (B) and (C) together. The finest adjustment is then made with the variable condenser (VC). Finally a closer adjustment



of (A) may be made, and this completes the tuning of the circuit.

The Loose-coupled Tuning Coil or Receiving Oscillation Transformer is much more delicate in its adjustment than any other and is far more easily manipulated. It is the only tuning device to be recommended for good work. The first thing is to obtain the desired station roughly with the slide (A) on the primary. Then the switch (B) on the secondary should be varied,

followed by the regulation of the coupling (K) between the two coils. After this the variable condenser will be adjusted. And finally a further fine variation on the primary will give us the greatest strength of signals.

The Use of Two Receiving Oscillation Transformers: The Weeding-out Circuit. By placing a second oscilla-

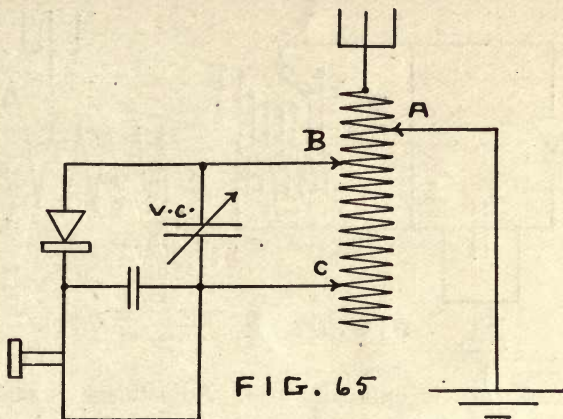

tion transformer in series with the first one (see Fig. 67), greater selectivity still can be obtained, although at some slight loss of energy in the strength of signals. The first adjustment is made on the primary (A). Then either (C) or (B) should be moved and a finer balance found with the variable condenser (D). The slide (E) on the secondary is then regulated to balance this coil with the previous ones, by an additional

movement of the second variable condenser (F). The tuning is so sharp in this circuit that it is necessary to go over the manipulation of these variations a second and even a third time to secure the greatest value.

A Tertiary Weeding-out Circuit is occasionally used for extreme cases, but the increased loss of energy is a serious drawback to its usefulness, except where

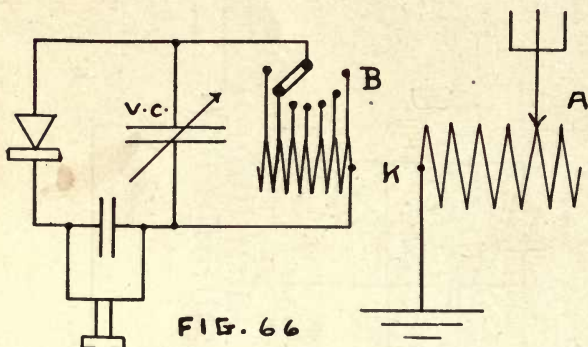

interference is unusually bad. Adjustment is made by the same routine as in the first weeding-out circuit, with the addition of another oscillation transformer and variable condenser. The circuit is shown in the chapter on diagrams.

The Detector will be used in every case, as the last and final adjustment. If the surface of the mineral in a silicon or perikon detector be covered with a thin film of Atlas Oil No. 2, its action will be increased and the mineral's rectifying qualities will be preserved.

Some of the perikon detectors now in use by the government show the mineral entirely immersed in oil, and this form has given great satisfaction when used. *Molybdenite*, which occurs in closely packed layers, should have a sharp knife-edge resting against the cross-section of these layers. Good silicon should

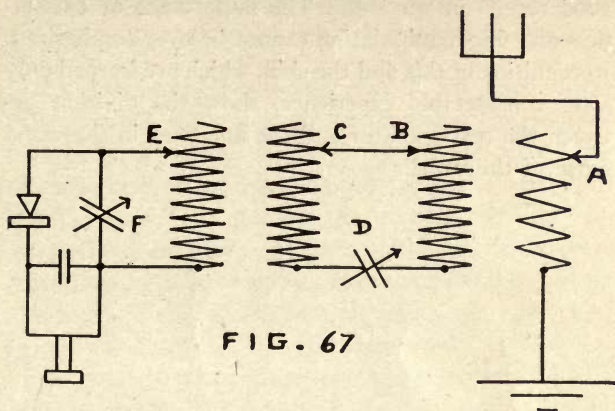

be free from flaws. An artificial or polished surface is the best for contact with a spear-point. The oval fractures of iron pyrites or pyron should come in contact with a spear-point such as is used for silicon. There are several kinds of zincite, only one of which is good for use in perikon detectors. This occurs in layers of some thickness, which should be turned edge-wise in contact with a sharply pointed piece of bornite, both of these minerals being used in their natural

fractures. By adjusting the detector carefully, testing meanwhile with a buzzer, the most sensitive point may be found; and this, as we have already stated, should be retained as long as possible.

Adjustment and operation of both sending and receiving apparatus is of the highest importance for good results in wireless. The importance of carefulness and fine manipulation cannot be over-emphasized. Recognition of this and the skill, which are learned only after considerable experience, show the division between the real operator and the amateur, in the worst sense of the word.

CHAPTER IX

BREAKING-IN SYSTEMS: METHODS OF SIMULTANEOUS RECEIVING AND TRANSMITTING

IN transmitting wireless signals we have always the sending station, from whose aerial are sent out waves of a definite length in every direction. Now it is as easy to receive such signals to the north as to the south of the station, the only limitations being caused by the limits of power of the sending station's electrical apparatus and its distance from the receiving station. Thus all wireless messages are sent out in circles around the transmitting aerial. If there are many such stations close together, the result would be pandemonium but for the fact that sending stations may regulate their wave lengths and thus avoid interference to some extent. It has long been the ideal of wireless experiment to find some method by which the receiving station may be tuned in to a certain sending station, regardless of the fact that other stations nearer at hand and perhaps of greater power were sending at the same time. To some extent this differential tuning is now possible, but only in cases where waves of very different lengths are coming in

at the same time. For instance, if the Marconi Station (Cape Cod, Mass., with a wave length of 1800) is sending at the same time as the Charlestown, Mass., Navy Yard (at a wave length of from 320 to 560), a receiving station in Boston will be able to cut out one or the other, provided he has a Loose-coupled Tuning Coil. But if the Navy Yard is sending at the same time as the Board of Trade Building, Boston

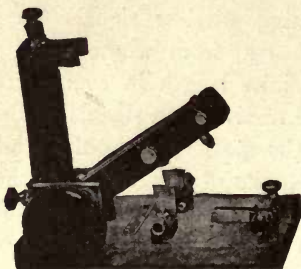

HAND THROW SWITCH

(about 700 metres wave length), it will be almost impossible to tune the stronger station out and receive only the weaker one.

If tuning devices can ever be brought to the perfection necessary to secure such fine tuning readily, every wireless man will be glad. But meanwhile we have a present condition of affairs, and what can be done to obviate interference or make it less annoying is every man's quest. Breaking-in Systems, while not yet generally popular, seem destined to supply this

need, and are increasingly used every day. If they do not prevent interference, they at any rate make it impossible except consciously.

The Breaking-in System is a method of simultaneous transmitting and receiving wireless signals; that is, a device is placed between the sending and receiving sets so that the operator may receive incoming signals even while he is sending them out. This device con-

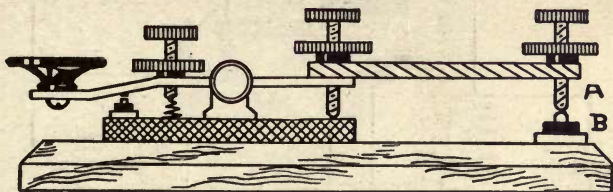

SIMPLE BREAK KEY
FIG. 68

sists usually of some attachment to the key which automatically switches in the transmitting circuit every time the key is pressed, and also automatically switches in the receiving circuit every time the key is released, even between the dots and dashes of the code.

Its advantages are more or less obvious to every operator. To the government or any commercial station, the breaking-in system has the advantage that if serious interference occurs in the course of a long message, that fact may be signalled to the sending operator. Thus the latter will stop until elimination

of the interference, and so save the time and current which would otherwise be used in completing a message which the receiving station could not pick up. On the other hand, a breaking-in system will notify an experimenter or private operator when more important

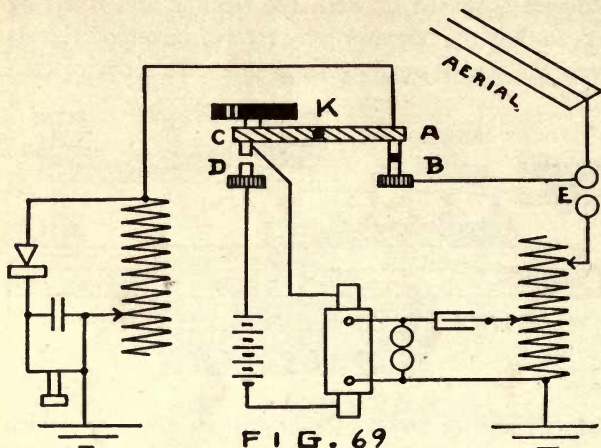

stations are sending. He will, as a matter of course, stop sending with wave lengths near those of the professional stations, and thus will cease to make himself a nuisance and a subject for hostile legislation.

Methods of breaking-in are determined partly of course by personal choice, but much more by the power of the transmitting apparatus. Thus we will take up three or four of the best ways, appropriate for different sizes of instruments.

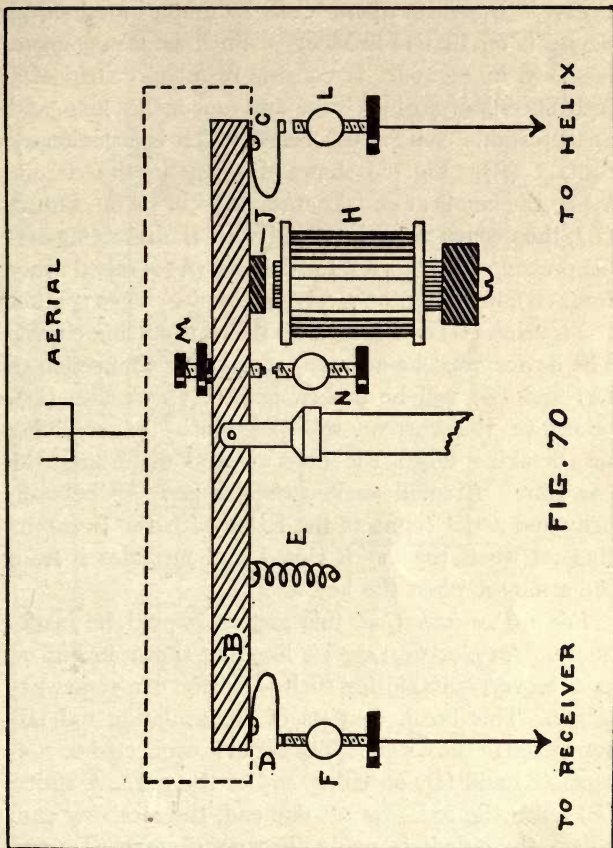

For a One-inch Spark Coil a simple mechanical device is all that is necessary. Such an arrangement is shown in Fig. 68. It consists of a short strip of $\frac{1}{8}$ inch fibre, half an inch wide and four inches long, and an adjustable contact (A) below which is a stationary contact (B). Fig. 69 shows this key in the circuit. When the key is at rest, contact (A) will be on contact (B), thus connecting the aerial with the receiving set. On pressing the key (K), the contact (A) is raised away from (B), breaking the receiving circuit. Then contact (C) touches (D) and completes the transmitting circuit. The device must be adjusted so that the connection of (A) and (B) will be broken before (C) touches (D), otherwise the current will pass into the receiving set, breaking down the detector and disturbing the operator. A small auxiliary spark gap (E) between helix and aerial connects the latter with the transmitting set when the key is closed and insulates it from the same set when the key is open.

For a Two-inch Coil this method would be inadequate. An electrical device like that shown in Fig. 70 is, however, suitable for such a coil or one somewhat larger. This break consists of an insulating rod (B) supported in the centre. The aerial is connected to contacts (C) and (D) on either end of the rod. A spring (E) holds the rod down at one end, the receiving end, where the circuit is made through contacts (D) and (F.) The opposite end of the rod may be pulled down by an electro-magnet (H) operating on an armature (J).

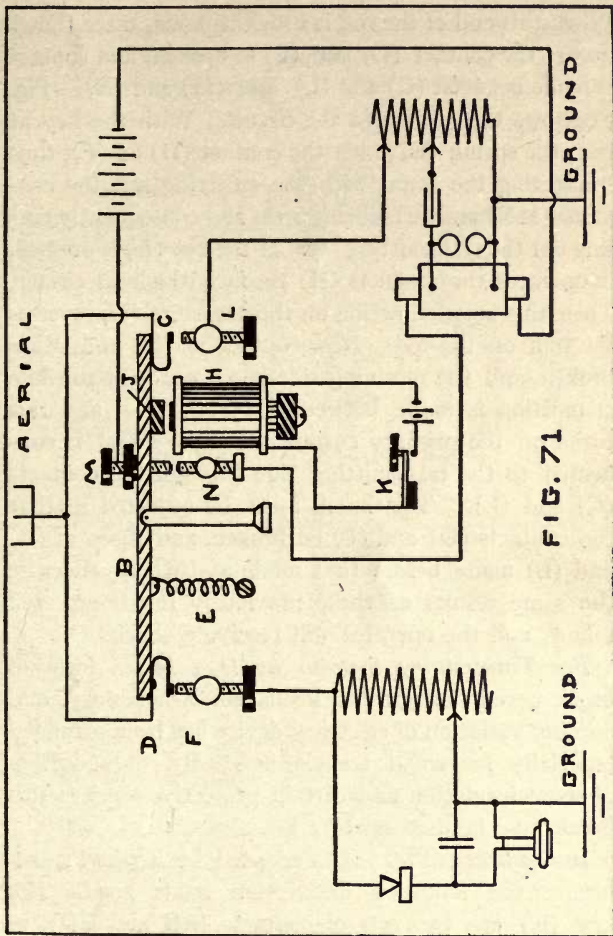

FIG. 71

When this end of the rod is brought down, three things occur: the contact (D) and (F) is broken, and contact is made between (C) and (L), and (M) and (N). Fig. 71 shows this device in the circuit. With the key at rest, the spring (E) holds the contact (D) on (F), thus connecting the aerial with the receiving set; the contacts (MN) and (CL) being open and consequently cutting out the transmitting set. If the key (K) is pressed, it operates the magnets (H) through the local circuit. Then this magnet, acting on the armature (J), reverses the pull on the rod. Now contact at (D) and (F) is broken, and the receiving side is cut out. Meanwhile connection is made between (M) and (N), and this turns on the primary current, and the aerial is connected to the transmitting side through the contacts (C) and (L). This break must be adjusted so that the contacts (D) and (F) be broken, and those of (C) and (L) made before that made at (MN); otherwise the same results as those previously mentioned will follow, and the operator will receive a shock.

For Transmitting Stations up to 1 kw. a form of break permitting greater insulation is necessary, and another variation of electrical device has been arranged especially for small transformers. By the addition of more insulation and certain protective devices this break may be used up to 2 kw.

In the break (Fig. 72) as adapted for a 1-kw. transformer the following description holds good. The key (K) has two sets of contacts (AB and CD), of

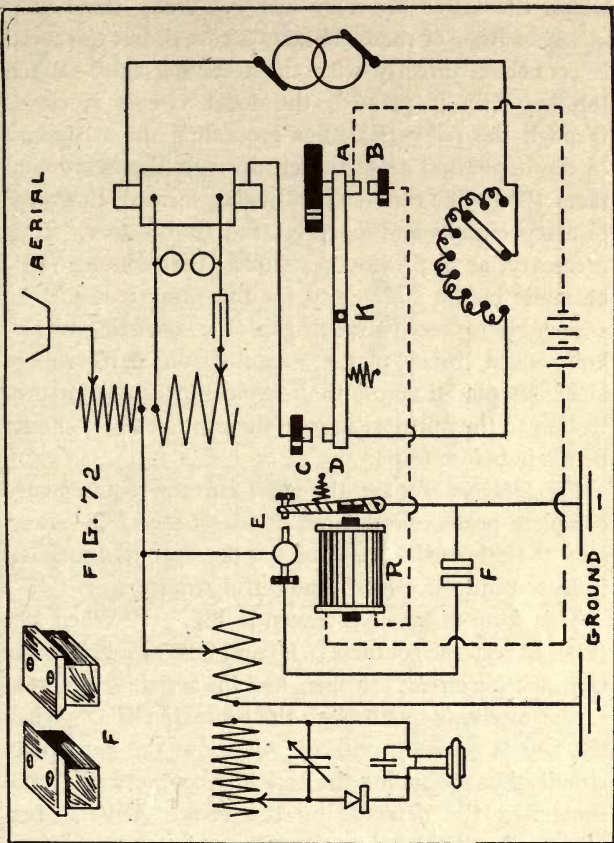
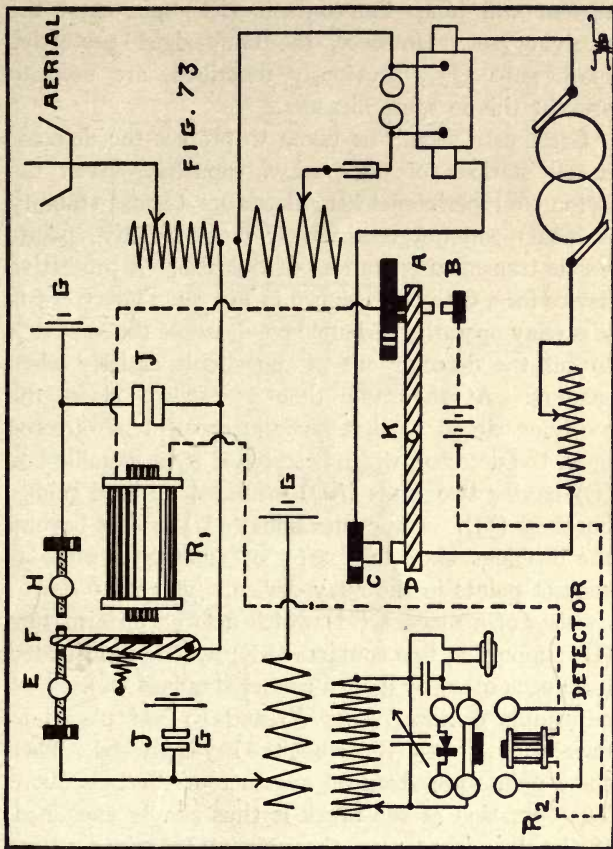

FIG. 72

which the latter are very heavy. When the key is at rest neither of these contacts is closed, but the aerial is connected directly with the receiving side. When the key (K) is pressed, the local circuit is closed through the relay (R), thus grounding the secondary of the oscillation transformer through the relay contacts (E). The contact (CD) being formed, closes the primary circuit and operates the transformer. It is necessary, as in previous examples, that contact (AB) be made before (CD), and for the same reason. An adjustable protective spark gap (F), consisting of two knife-edged brass plates mounted on hard rubber blocks, is placed across the relay contacts (E) for protection to the operator in case the contact (CD) should be made before (AB).

For Stations of 5 kw. the great current requires very complete protective devices, and it is especially necessary that the adjustment of the detector be protected from the influence of the powerful transformer.

This form of break is shown in Fig. 73. When key (K) is at rest, the contacts (AB) and (CD) leading to the transmitting circuit are open, and the aerial is connected to the receiving set through the contacts (EF). When the key is pressed, contacts (AB) close the local relay circuit, thus grounding the aerial by contacts (FH) and protecting the detector by the relays (R^1R^2). Just afterwards, (CD) being closed, completes the primary of the transmitting circuit. Contacts (AB) should be made before those of (CD) or some of the transmitting



current will jump the contacts (EF) and enter the receiving set. However, the knife-edged protective spark gaps (JJ), previously described, are used to prevent this in some measure.

Great care should be taken to protect the detector in all stations of over 1-kw. capacity. Even the pyron and perikon-elektra detectors (whose stability is great) will not retain their most sensitive points beside transmitting stations of this size. A protective device for a detector is shown in Fig. 74. This consists of a relay operating a double pole, double throw switch to cut the detector out of the circuit entirely when sending. At the same time the switch closes the receiving circuit so that no influence will be directed upon the detector, which is screened by a metallic box (E) having two leads (AD) insulated by hard rubber bushings (JJ). The connections (AD) project beyond the bushings about a quarter of an inch to serve as contact points in the relay device. This relay device consists of a magnet (M) which acts on an armature (H) supporting two contacts (BE) which are insulated from each other by a hard rubber standard (K). Two adjustable contact points (C and F) are placed to make contact with (BE) when the key is pressed. Then these points are strapped together or short-circuited. The operation of the break is thus simply explained. If the key is at rest, the magnet (M) is dead, so the spring will hold the contacts (DE) and (AB) closed, connecting the detector in the receiving circuit.

FIG. 74

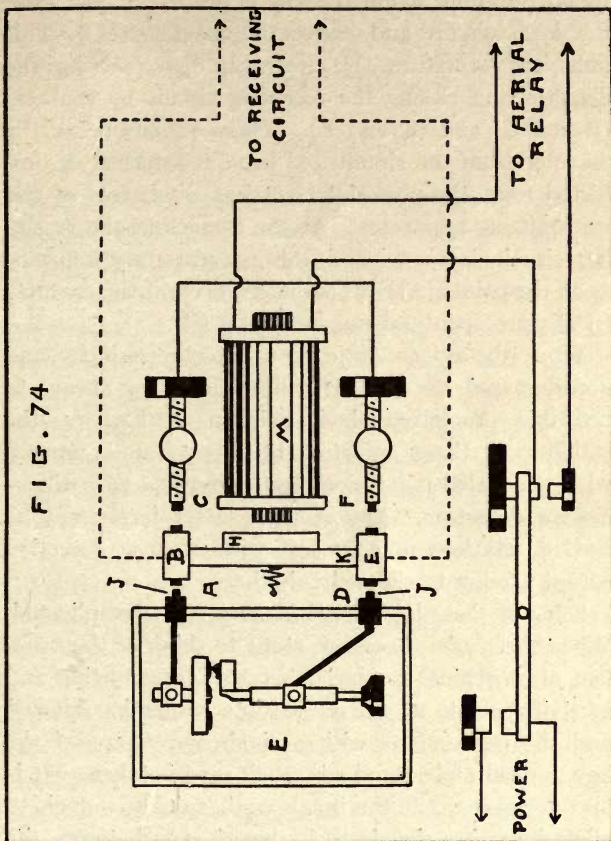

If, on the other hand, the key is pressed, it will close the local circuit and excite the magnet (M). This pulls the armature (H) forward, disconnecting the detector and closing the receiving circuit by contacts (B and C) and (E and F). These actions break the detector from the circuit and leave it screened or protected from the powerful electrical discharges of the transmitting apparatus. At the same time the receiving circuit is closed and this prevents any influence upon the points (AD) which might occur if the contacts (BE) were open and not closed by CF.

When the silicon or perikon detectors (zincite and bornite type) are used, it will be necessary always to use this protective device shown in Fig. 74, the stability of these detectors being poor as compared with the sealed point electrolytic, pyron, and perikon-elektra detectors. Any of these latter forms may be used on stations up to 1 kw. without any protection except a relay to short-circuit them.

Some of these last diagrams may seem complicated. When the reader, however, stops to think of the problem of switching the aerial between transmitting and receiving, while at the same time protecting himself and the instruments with a single movement of the key, he will understand why such care is taken. It is also necessary that the break work quickly enough to allow incoming signals to be heard even between the dots and dashes of an outgoing message.

CHAPTER X

CODES

CODES are merely generally recognized systems of short and long signals, "dots and dashes," arranged to correspond with the letters of the alphabet, numerals, and punctuation marks. By means of these "dots and dashes," a sending operator is enabled to spell out messages to a receiving operator. As codes are only arbitrary agreements, it might be possible to have as many as there are operators or sets of operators, and every one could use a different one. In practice, however, it has been found convenient to use certain generally recognized systems, which become as familiar as a language to every telegraph operator.

There are three of these systems in general use in America—the American Morse, the Continental, and the Naval Codes. The most popular in America is the Morse, although the Continental is used to a considerable extent, especially in wireless telegraphy. The Continental Code is generally used in Europe, and in England is called the Morse, while that code called Morse in America is spoken of as the American Morse. The Naval Code is used officially by the American Navy, but is surpassed in popularity by both the other

codes even in the Navy. The Continental and the Naval Codes have one point of similarity in that none of their letters are spaced (*i.e.* include spaces as well as dots and dashes), as does the Morse. The three are shown together on the following pages.

THE CODES

MORSE	CONTINENTAL	NAVY
A .—	A ..—	A ——
B —....	B —....	B —...—
C .. .	C —...—	C .—.
D —...—	D —...—	D ———
E .	E .	E .—
F .—.	F ..—.	F ———.
G ———.	G ———.	G —...—
H	H	H ———
I ..	I ..	I .
J ———.	J .———	J ..——
K ———	K ———	K —...—
L —	L .—..	L ———.
M ———	M ———	M .——.
N —.	N —.	N ..
O .. .	O ———	O —.
P	P .——.	P .———
Q —...—	Q ————	Q .—...—
R . . .	R .—.	R —...—
S ...	S ...	S ———
T —	T —	T —
U —...—	U —...—	U .—...—
V	V	V ————
W ———	W ———	W
X —...—	X —...—	X ————
Y .. .	Y ————	Y .———
Z	Z ———.	Z ———

1	1	1
2	2	2
3	3	3
4	4	4
5	5	5
6	6	6
7	7	7
8	8	8
9	9	9
0	0	0
.		
,	,		
?	?		
!	!		
¶	¶		

The first necessity for an operator is, of course, to learn thoroughly some one of these codes. As the Morse is so much the more popular, we shall take that for illustrative material, although similar groupings may be made of the Continental. Fig. 76 gives a convenient grouping of the characters which adds to quick memorizing, and acts as an aid to the memory as long as such an aid is of use.

A CONVENIENT GROUPING OF MORSE CHARACTERS

The Dot . E The Dash — T

ALL DOTS

C E H I O P R Y Z 6 S

.....

ALL DASHES

L M T 5 o ¶

SPACED LETTERS

C O R Y Z

FOR MEMORIZING

E I S H P 6 T L o
 —————

DASH FOLLOWED BY DOTS

N D B 8
 —. —. . . —. . . . —.

DOTS FOLLOWED BY DASH

A U V 4
 . — . . — . . . — —

CONTRASTING CHARACTERS

A N	B V	C R	D U	F K	G W	J ,	Q X
·	·	·	·	·	·	·	·
·	·	·	·	·	·	·	·
·	·	·	·	·	·	·	·

Since every word in telegraphy must be spelled out, certain abbreviations have become generally recognized both in wire and wireless telegraphy. These abbreviations most used in ordinary telegraphy have usually been adopted in wireless, but there are additions, like the famous C. Q. D. (S. O. S.), for special wireless needs. The use of these saves considerable time, and the opera-

tor should learn to use them. Every line of business has special signs used frequently in its own business. We include here, however, only the general abbreviations, and the operator will make his own special additions.

ABBREVIATIONS

3 or 30	Finish signal
73	Accept my compliments.
ANS	Answer
BK	Break
CK	Check
DH	Free
FM	From
GA	Go ahead
GE	Good evening
GM	Good morning
GN	Good night
HR	Another message
IMPT.	Important
MIN.	Minute
NM	No more
NO	Number
OFM	Official message (used only by the navy).
OK or II	All right
OFC or OFS	Office
OFR	Operator
PD	Paid (generally in full).
QN and QJ	Beginning and ending of quotations.
SIG	Signature
SOS	International distress signal.
SVC	Service
V	Test letter.
X or 99	Interference.

In operating a wireless station, certain forms of messages are absolutely necessary; and in general practice commercial stations have adopted those forms used by the ordinary telegraph companies. Variations are, of course, required, and the following message-form (Fig. 77) will answer the needs of any commercial wireless station.

Such a form, however, is rather more elaborate than experimenters will ordinarily require for private signalling. For such operators, nevertheless, some formality is advantageous, and a simple question and answer form like the following may be adapted to personal needs.

1. Call of station wanted (three times) CN, CN, CN.
2. Sign call of sending station (once) VA
3. Finish signal 3 or 30

RECEIVING OPERATOR

- a. *call of sending station (three times)* VA, VA, VA.
- b. *Sign call of receiving station (once)* CN.
- c. *All right* OK. OK.
- d. *Go ahead* GA. GA.
- e. *Call of sending station (once)* VA
- f. *Sign call of receiving station* CN
- g. *Finish signal* 3 or 30

SENDING OPERATOR

4. Call of station wanted (three times) CN. CN. CN.
5. Period (repeated two or three times) Period. Period.
6. Body of message
7. Period Period. Period.

NUMBER H.R. 1 S.N.	SENT BY FS	RECEIVED BY SY	CHECK Ck. 7 Paid	TIME 6.26 P.M.	STATION VIA New York
-----------------------	---------------	-------------------	---------------------	-------------------	-------------------------

HR = Message

1 = Number of Message

SN = Sending Station's Call

FS = Sending Operator's Sign

SY = Receiving Operator's Call.
To be filled after the message is copied

Ck = Check

7 = Number of words in body of message

Paid = The message may be either paid, collect, or service.

Time = To be filled in by receiving operator, after the message is copied

If message is relayed

To J. Jones,

All are well will return at once.

BOSTON, MASS.....19.....

Key West, Florida.

Sig. James.

NM meaning no more,
or HR meaning another message.

FIG. 77

- 8. Sign call of sending station.....V A.
- 9. Finish signal.....3 or 30

RECEIVING OPERATOR

- h. All right. (If message is received and understood)*
O K. O K.
- i. Call of sending station.....V A. V A.*
- j. Sign call of receiving stationC N. C N.*
- k. Finish signal3 or 30*

or,

- Question (if message is not understood and must be repeated)*
D N. D N.
- i. Call of sending station.....V A. V A.*
- j. Sign call of receiving station.....C. N. C N.*
- k. Finish signal.....3 or 30*

SENDING OPERATOR

- 10. All right (sending operator will repeat)O K. O K.
- 11. Call of receiving station.....CN. CN.
- 12. Sign call of sending station.....V A.
- 13. PeriodPeriod
- 14. Repeats body of message, and ends as before (8, 9)

CHAPTER XI

THE ETIQUETTE OF WIRELESS AND THE SUBJECT OF INTERFERENCE

THE air is free to all, or at any rate it has been thought so until discussion upon wireless interference has become of importance. Now we have the knowledge that in England a license fee is charged, for the use of the air presumably, whenever a wireless station for transmitting is installed. Many bills on the same subject have been proposed in America, but up to the time of printing, without result.

There is, moreover, some justice on the part of those who wish to limit the use of the air in this way. Since the loudness of signals depends upon the power of the transmitting instruments and the distance to be covered, it is possible for private persons and commercial companies to monopolize the space in certain vicinities, so that a most important government message cannot be received. It is, of course, to be understood that the government should have right of way, not only in the roads, but in the air.

Interference may be of two kinds, unintentional or malicious. In their effect there is no difference; but

as a matter of fact, it is the unintentional interference of experimenters unversed in the code, and without adequate breaking-in systems, that has given rise to most of the legislation hostile to them. Malicious interference either on the part of an experimenter or, as frequent complaints bear witness, on that of commercial stations, should be dealt with as severely as possible. It would seem that license restrictions would be too mild a treatment for such cases, and in all probability a method of dealing with them will be evolved.

In cases of unintentional interference, there is usually no remedy, as it is by an experimenter, or where the station is not properly equipped. No person should operate a transmitting set until he has a proper understanding of the codes, and, if he has no breaking-in system, without *listening-in* frequently to learn whether other stations are trying to make themselves heard. It is while a station is trying to receive messages from a distant source that interference is most objectionable. While a powerful station near you is sending, a sending station of less power or different wave length may send without troublesome effect; but when it is trying to get signals from a weaker station, or one at some distance, your interference will be most effective and most disastrous.

There are, however, some methods of overcoming interference. If the experimenter will use an oscillation transformer for sending, he will be able to tune his

apparatus much more sharply. With a sharply tuned wave length, he will be received only by apparatus tuned in with his instruments most exactly. Therefore, if he is from fifty to one hundred metres either above or below the commercial station, he may be tuned out without trouble at the receiving instruments.

Another method of overcoming interference is by the new duplex system of wireless, where two aerials are used, one for sending and the other for receiving. The shorter aerial is for sending, thus ensuring a short wave length, much below that of the commercial stations. The longer aerial, for receiving, may be as large as is desired or needed, according to the distance to be covered.

Still another method is by the use of a breaking-in system, which will enable the experimenter to hear distant sending stations when they call, even while he is sending.

Where interference occurs with the government or commercial stations, a weeding-out or third (tertiary circuit) should be used. This will make the tuning of the receiving instruments twice as sharp as with the ordinary receiving loose-coupled transformer.

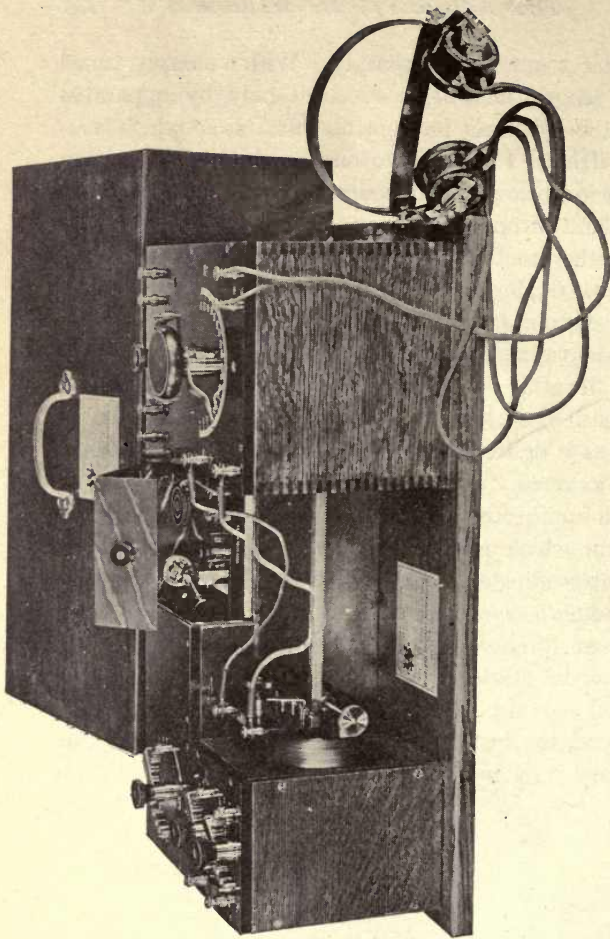

WIRELESS TELEGRAPH AND TELEPHONE RECEIVING SET AS USED BY
UNITED STATES GOVERNMENT

CHAPTER XII

WIRELESS TELEPHONY

THE Wireless Telephone is not yet a success. Various interesting experiments have been made on theoretical principles, and for short distances speech has been transmitted, or at least musical tones have been identified. Much more experiment, however, is necessary before it will be possible to use the wireless telephone even to the extent that we can now use the wireless telegraph.

Distances up to a hundred miles have been claimed by some commercial companies, although it is doubtful whether, on test, telephone transmission has been made for such a distance. Moreover, the principle now most popular with experimenters (the so-called "arc method") does not promise much more in the matter of distance even under the best of conditions. For short distances, however, the wireless telephone has been used, and speech has been distinctly heard for twenty miles certainly. Any greater distance than this is a matter for proof and speculation. This was done by using the arc method, which will be later described. By the disruptive discharge method,

greater distances can easily be covered, but articulation is poor. Professor Fessenden's new system promises improvement in both respects.

The earliest experiments along the line of telephoning without wires were devoted to what we now call

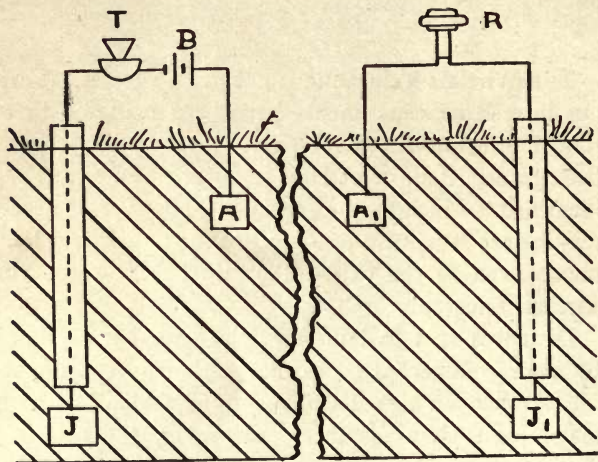

FIG. 78

the "conductive" method of wireless telephoning. The connecting medium, in this case, is the ground. The diagram (Fig. 78) will show the working of the system. A plate (A) buried about three feet below the surface of the earth is connected through a set of batteries (B) and a telephone transmitter (T) by a highly insulated lead-wire to another plate (J) buried

in the ground at a distance of some fifteen feet. A duplicate arrangement on the receiving side leads from a plate (A') through a receiver (R) to another plate (J'). When a current is set up in the transmitting side, it is conducted by the surface of the earth from A to A'; after passing through the metallic connections to J' it will find its way back again to J, and a circuit will be established. Now if we speak into the transmitter (T), we will vary the current over this

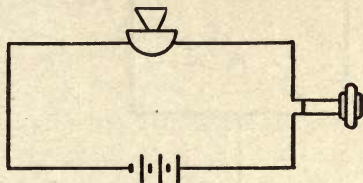
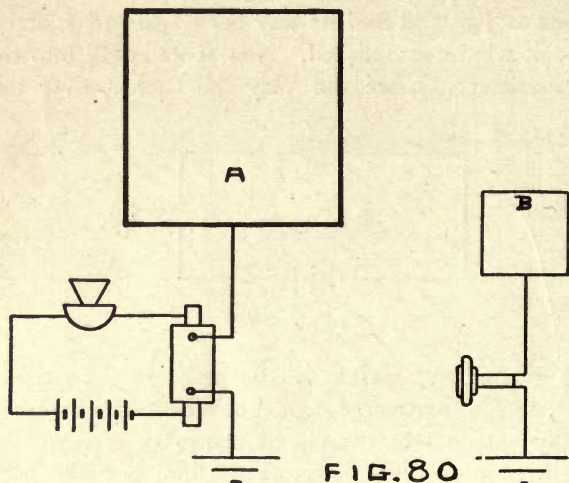

FIG. 79

circuit, and our speech will be heard in the receiver (R). As a matter of fact, the conductive method really amounts to the circuit shown in Fig. 79, the earth forming the connecting medium between both sets of plates. This method will work up to about three miles.

Another early form of wireless telephony both in point of original experiment and of electrical importance is the Static Telephone. This form, shown in Fig. 80, works on the principle of the condenser. A wire frame or grid, consisting of lines of wire, and having the effect of an almost solid metallic surface,

is charged through an induction coil by the human voice. This charge on the grid (A) charges a second grid (B), which is connected to a receiver, and the speech is distinctly transmitted by *electro-static induction*. The effect is represented in our second dia-



gram (Fig. 81), the two grids acting as the plates of a condenser. This will work up to a half mile.

Still another form of wireless telephone works on the principle of the induction coil, by *electro-magnetic induction*. (See Fig. 82.) A loop of heavy copper wire about five feet in diameter, connected to a telephone transmitter of low resistance and a battery, forms the

transmitting side. The receiving end consists of a similar loop of wire attached to a telephone receiver, which should be of the bi-polar type, and must be wound

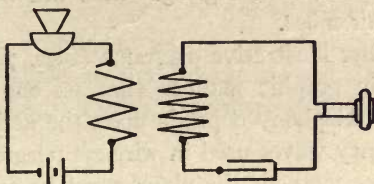

FIG. 81

with about no. 18 wire. The transmitting side acts as the primary, the distance between the two loops as the magnetic field, and the receiving loop as the secondary of the induction coil. It is to be noted

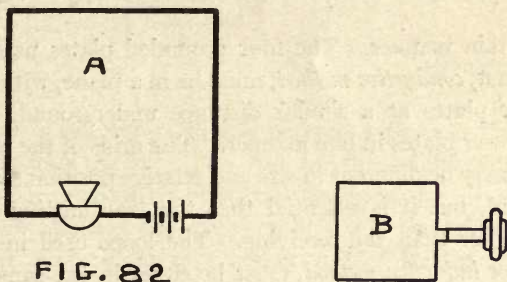

FIG. 82

that in both instances we are dealing with low resistances. This is to avoid the losses of energy caused by a great number of turns of wire in the circuit. For

the same reason we use heavy loops of wire, a low resistance telephone transmitter and receiver, and batteries in series multiple. The effect of this form of telephone is shown in Fig. 83. This will work up to three or four miles.

The smaller illustrative diagrams (Figs. 79, 81, and 83) show in graphic manner that no one of these methods of telephony depends upon the action of the high-frequency waves used in wireless telegraphy. In each of these methods the plates must be arranged in

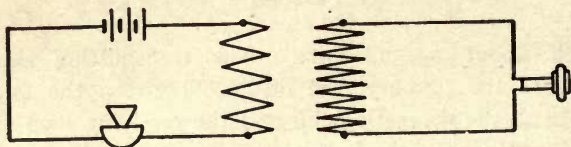

FIG. 83

a certain manner. The four grounded plates used in the first, *conductive method*, must be in a plane, with the upper plates at a similar distance underground, and the lower plates in like manner. The grids of the *static form* may be different in size and relative position above ground, but it is essential that the transmitting end be higher than the receiving. The loops used in the last, or *inductive method*, must be either in the same or parallel planes, as no indications will be received if they are at right angles, a fact true of the induction-coil principle.

Although none of these use detached electro-mag-

netic waves, there are methods of wireless telephony, or rather we should more properly say *Radio-telephony*, which do make use of those waves. Two or three of these wave methods are of importance, and most of the experiment now going on relates to them.

First of these is the *Spark Method*. In passing from our description of the wireless telegraph, this

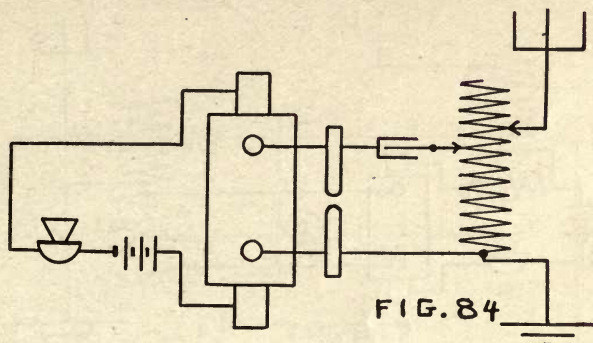

method is simplest. It may be used with an ordinary transmitting circuit (Fig. 84) by the addition of a telephone transmitter of special design in the primary. The vibrations of the voice speaking into this transmitter are stepped up to a higher voltage by the spark coil, and are recorded in the spark gap. This gap, which may be of the ordinary form, or may consist of two small carbon rods, should be connected in an oscillatory circuit of almost any design, with aerial and ground connections. Fig. 85 shows a more efficient

form of telephone working on the same principle. This is the telephone designed by the author and consists of a special telephone transmitter (A), a variable impedance (B), connected with a battery (C) in the primary circuit. Any vibrations received in the transmitter are picked up by the secondary and are discharged through the mercury-vapor spark gap (D). This

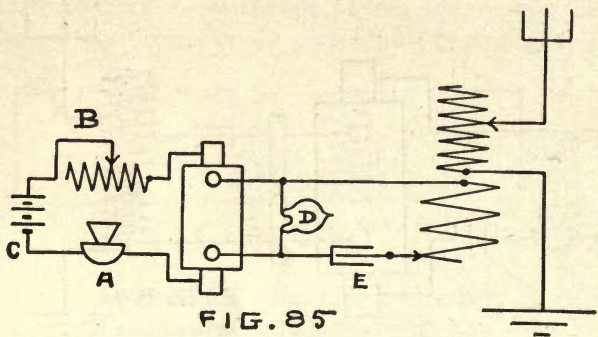

discharge in the mercury-vapor tube sets up oscillations in the circuit, which in turn are picked up by the aerial circuit and radiated off into space. Such a telephone will transmit messages from five to fifteen miles. The ordinary tones of the human voice both in speech and in singing, and the notes of musical instruments, especially the xylophone, are revealed very clearly through this mercury-vapor spark gap, but articulation is sometimes indistinct.

The Arc Method works by the production of un-

damped oscillations. This is most popular at present with experimenters, and several wireless men in America are working with it. A form of arc generator shown in Fig. 86 consists of a singing or musical arc burning in hydrogen gas. This arc will produce oscillations when connected with a coil and condenser, thus forming an oscillatory circuit. An induction

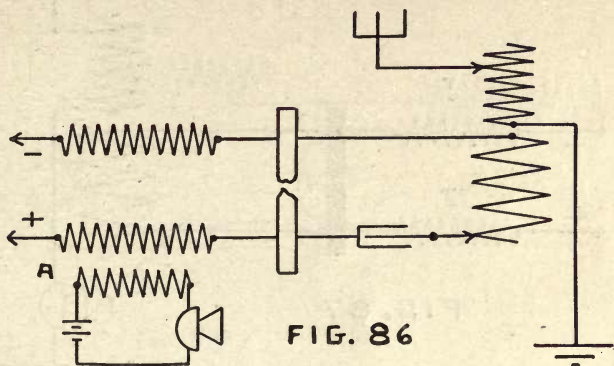

coil (A) is placed in the power circuit between the arc and the power supply. In the primary circuit of this is placed a battery and a telephone transmitter. The vibrations of the voice speaking into the telephone transmitter and varying the current about the arc cause fluctuations in the arc corresponding to those in the transmitter. These variations, communicated to the oscillatory circuit, are picked up by the aerial circuit and radiated from the aerial. Speech is very

clear when using this method, and it has been used up to fifteen or thirty miles. It is often called the speaking arc.

Another arc method is illustrated by Fig. 87, consisting of an arc generator and a transmitter in the

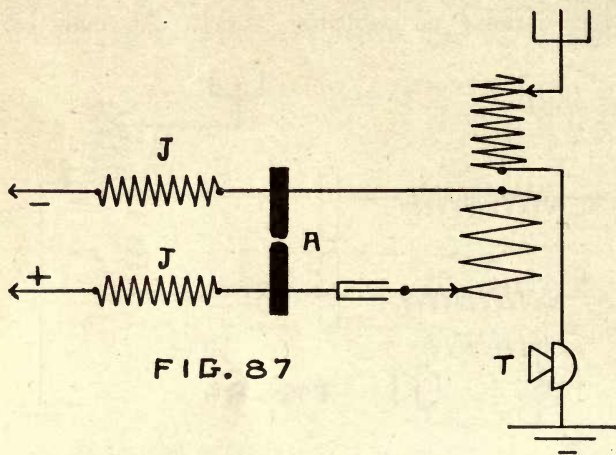

FIG. 87

aerial circuit. An ordinary direct current supply is used and two impedences (JJ). The arc (A) is water cooled, in order to keep down heat disastrous to the production of oscillations. This arc generates best when running on from four to five amperes and not over 220 volts; anything in excess of this tending to destroy the generating properties for some unknown reason. The arc must be kept at its greatest length,

as at that place it generates best. The frequency of the arc (A) ranging between 100,000 and 200,000 per second, the electro-magnetic waves follow each other so closely that the effect upon the telephone receiver is continuous. Now if we speak into the transmitter,

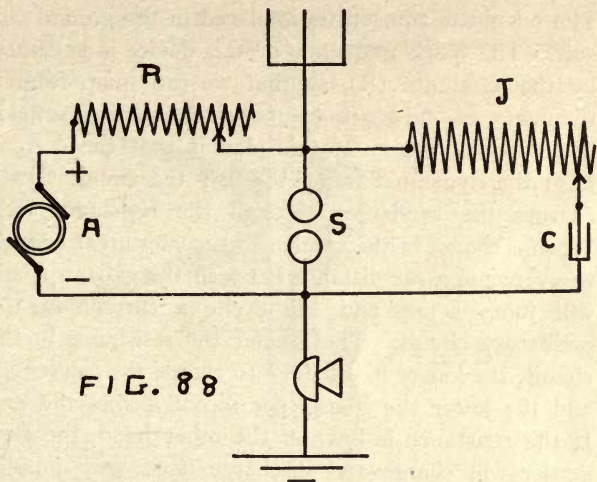

FIG. 88

placed in the aerial circuit, the vibrations of the voice will interrupt these waves, and the interruptions will be audible in the telephone receivers as words. This is the method used by De Forest. Experiments with this system have covered distances of perhaps twenty or thirty miles, due to the limitations of the current in a secondary circuit.

Fig. 88 shows Professor Fessenden's Wave-Generator, one of the latest and most ingenious methods yet produced. A direct current dynamo (A), of about 5000 volts potential, is connected to a spark gap (S) through a variable resistance (R). Across this gap is placed a coil (inductance) (J) and a condenser (C). The telephone transmitter is placed in the ground circuit. The spark frequency of this device is governed by the resistance (R), so that we can jump from a frequency of one spark to one of 100,000 per second. The working theory of this plan is that the current from the dynamo flowing through the circuit slowly charges the condenser through the resistance (R). When a charge in the condenser becomes great enough to overcome a set distance between the gaps, a spark will jump across and will excite a current in the oscillatory circuit. The greater the resistance in the circuit, the longer it will take to charge the condenser, and the fewer the sparks per second across the arc. If the resistance is low, on the other hand, the condenser will charge and discharge itself very rapidly across the gap. When a frequency of from 80,000 to 100,000 is obtained, the waves, following so rapidly, are inaudible at the receiving end, and an almost continuous current is made. The vibrations of the voice speaking into the transmitter interrupt or vary the intensity of the continuous waves, and speech is thus transmitted.

In all forms of wireless telephony a special kind of

transmitter is not only advisable, it is actually almost necessary. There has been considerable experiment as to the kind of transmitter best adapted to the purpose, and numerous modifications of the ordinary transmitter are the result. A type which can be used

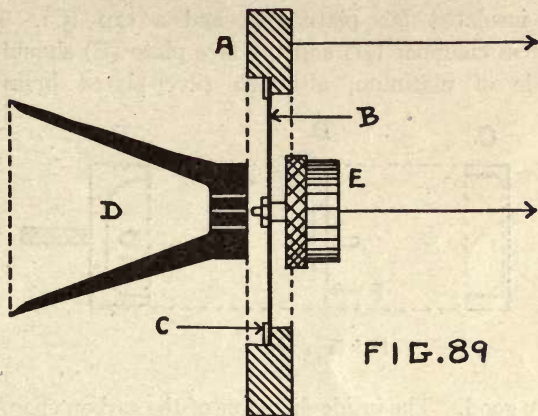

with all the methods of telephony described is shown in Fig. 89.

This transmitter, which is of the inertia type, works very well for all experimental purposes, although for permanent use the solid back type might perhaps be advisable. This inertia transmitter should have a very massive frame of the ordinary type for long distance use. The diaphragm (B), about .006 inch in thickness, of French steel, should be held firmly in

place by a metallic ring (C). The mouthpiece (D), of ordinary type, must be so arranged that the distance between it and the diaphragm may be varied. The transmitter button (E), attached to the centre of the diaphragm, is shown separately in Fig. 90. This button consists of a cup or carbon chamber (A), an insulated face-plate (B), and a cap (C). The carbon chamber (D) and the face plate (E) should be made of platinum, although silver-plated brass is

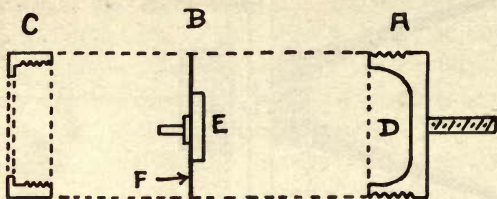
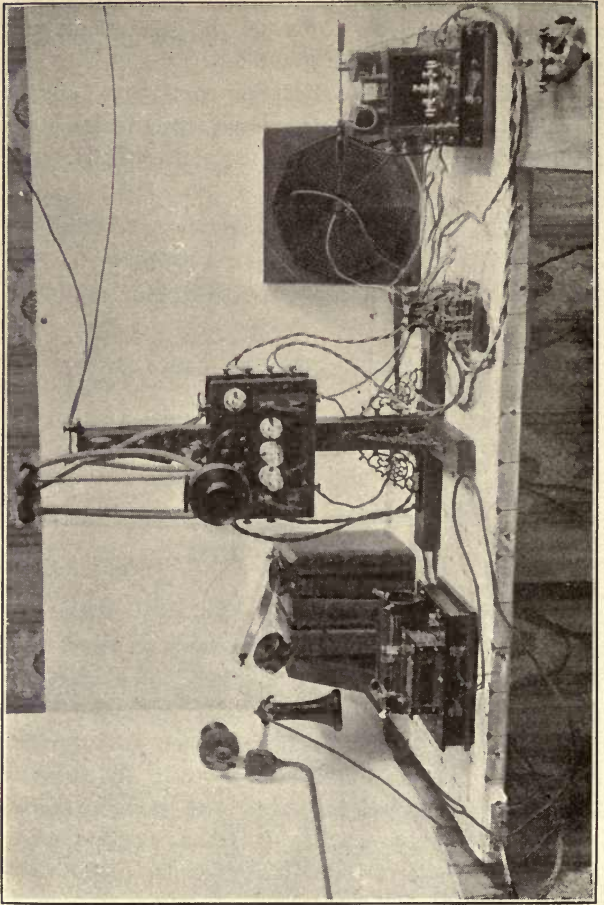

FIG. 90

very good. The inside diameter of the carbon chamber (D) should be about $\frac{5}{8}$ inch, while the distance between the back of this chamber and the face plate should be $\frac{1}{8}$ inch when the cup is closed. The face-plate, backed with a thin mica washer (F), which supports and insulates it, is held in place by the cap (C). The carbon granules will be large and globular when used in the primary circuit, and the chamber should be well filled with them. When used in the aerial circuit they should be much smaller and should only partially fill the chamber. The thinness of the mica washer is

of importance, in order to ensure the greatest amount of vibration reaching the granules.

For receiving wireless telephone messages, any of the detectors and any of the receiving circuits shown in the back of the book may be used successfully.



APPENDIX

AERIALS

The *T*, the *Vertical*, the *Umbrella* are the best types of aerials. The *L*, the *V*, the *Fan* are all good types.

Combinations of types are often best fitted for a specific location.

TRANSMITTING CIRCUITS. I

1. Spark Coil, Spark Gap. The simplest circuit.
2. Spark Coil, Spark Gap, Condenser. The addition of a condenser to give a longer wave.
3. Spark Coil, Spark Gap, Helix. Addition of a helix to give longer wave.
4. Spark Coil, Spark Gap, Condenser, and Helix. The combination of instruments for the best results.

Any of these circuits may be used on a one-inch spark coil for distances of from one to two miles; but they are not practical for greater distances, and do not give the full value of the instruments.

TRANSMITTING CIRCUITS. II

5. Spark Coil, Spark Gap, Helix, and Condenser. A practical circuit for a 3-contact helix.
6. Spark Coil, Spark Gap, Helix, Condenser, and Anchor Gap. For use with loop aerials and breaking-in systems. A practical circuit.

7. Spark Coil, Spark Gap, Condenser, 3-Contact Helix. A popular and practical circuit.

8. Spark Coil, Spark Gap, Condenser, 4-Contact Helix. Circuit especially adapted for the variety of its effects.

All practical circuits.

TRANSMITTING CIRCUITS. III

9. Transformer or Spark Coil, Spark Gap, Condenser, 4-Contact Helix, and 3-Point Anchor Gap. For use with loop aeriels. As practical as any circuit using a loop aerial.

10. Transformer or Spark Coil, Spark Gap, Condenser, 3-Contact Helix, and 3-Point Anchor Gap. Highly recommended for loop aeriels.

11. Transformer or Spark Coil, Spark Gap, Condenser, Oscillation Transformer. The most practical and popular circuit known.

12. Transformer, Spark Gap, three or more Condensers, three or more Oscillation Transformers. A Multiple Transmitting Circuit. For use with very high power.

The best circuits for commercial and long distance work.

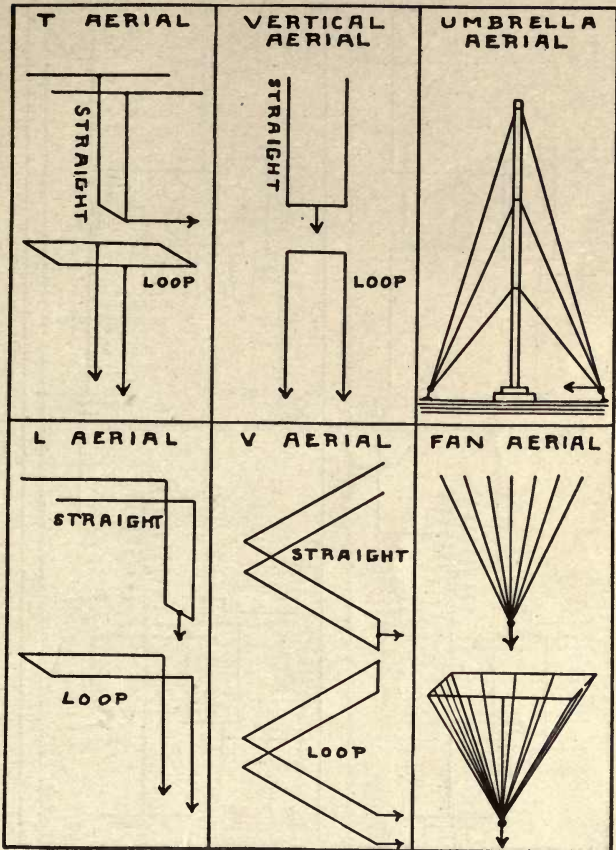

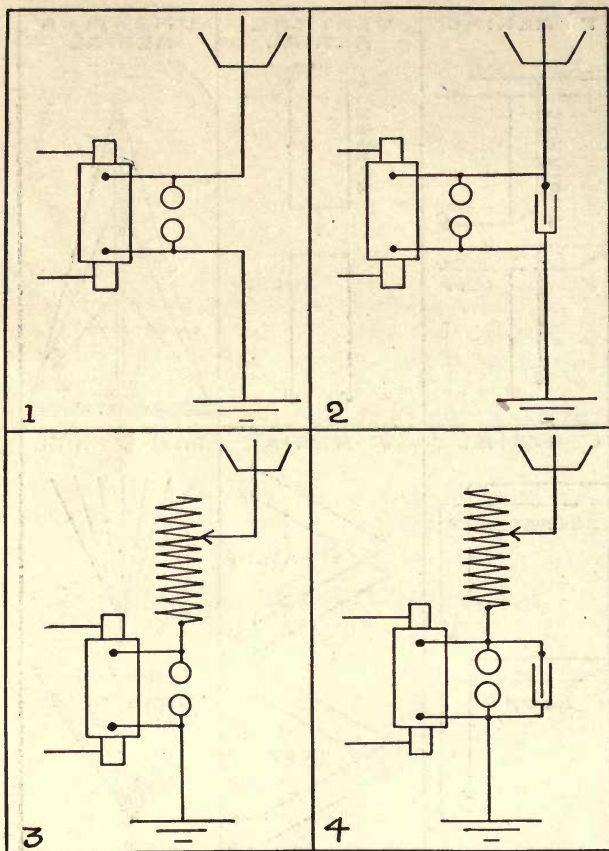

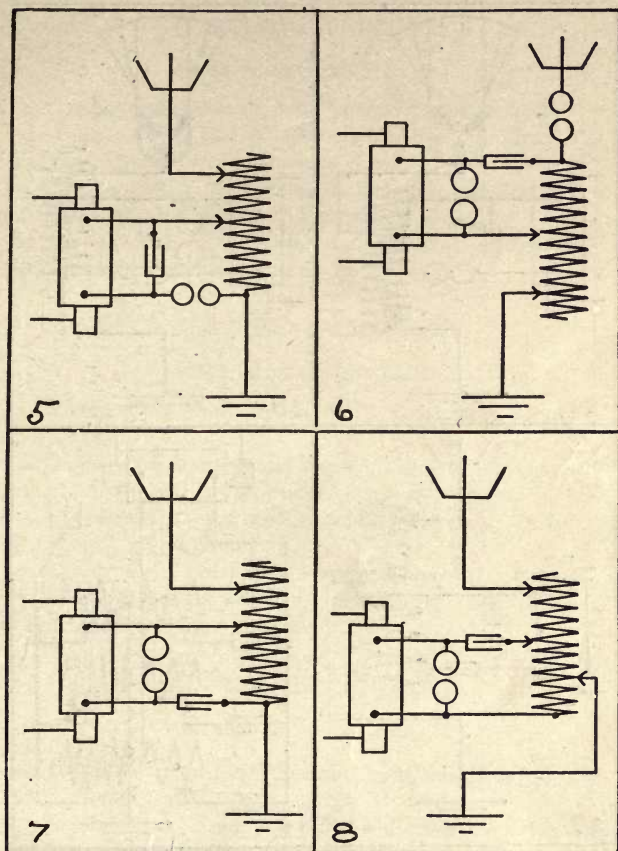

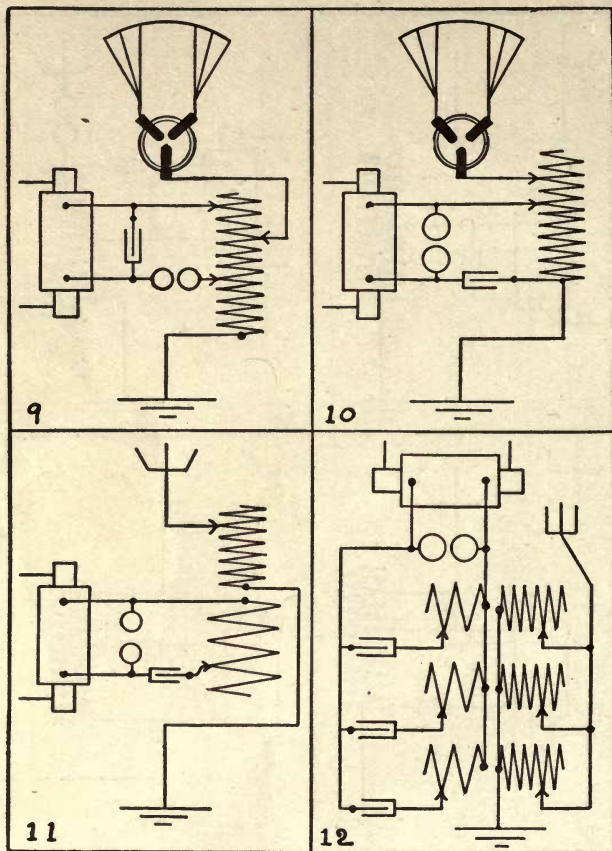

RECEIVING CIRCUITS. I

SINGLE SLIDE TUNING COILS

1. Tuning Coil, Detector, and Phones. Simplest circuit.
2. Tuning Coil, Fixed Condenser, Variable Condenser, Detector, and Phones. A simple tuned circuit.
3. Tuning Coil, Fixed Condenser, Detector, and Phones. A practical circuit, but subject to interference.
4. Tuning Coil, Fixed Condenser, Detector, and Phones. Practical circuit for the beginner. Fairly selective.

RECEIVING CIRCUITS. II

DOUBLE SLIDE TUNING COILS

5. Tuning Coil, Fixed and Variable Condensers, Detector, and Phones.
6. Tuning Coil, Variable and Fixed Condenser, Detector, and Phones. A practical circuit, but subject to interference.
7. Tuning Coil, Fixed and Variable Condensers, Detector, and Phones. A selective circuit.
8. Tuning Coil, Fixed and Variable Condensers, Detector, and Phones. The most selective 2-slide circuit. Will overcome arc-light interference to a measure.

RECEIVING CIRCUITS. III

THREE SLIDE TUNING COILS

9. Tuning Coil, Fixed and Variable Condensers, Detector, and Phones. An all-around selective circuit.
10. Tuning Coil, Fixed and Variable Condensers, Detector, and Phones. Overcomes arc-light interference.
11. Tuning Coil, Fixed Condenser, two Variable Condensers, Detector, and Phones. Very selective circuit for overcoming static and arc-light interference.

12. Tuning Coil, Fixed and Variable Condensers, Detector, and Phones. The best 3-Slide circuit known. Has auxiliary loose coupling, which has an effect similar to an oscillation transformer. Good for overcoming all kinds of interference.

RECEIVING CIRCUITS. IV

SPLIT AERIAL CIRCUITS

13. Two Single Slide Tuning Coils, two Fixed Condensers, Detector, and Phones. Simple interference preventer.

14. Two Double Slide Tuning Coils, Fixed Condenser, Detector, and Phones. Adapted to overcome the humming of motor and power wires.

15. One Single and one 3-Slide Tuning Coil, Fixed Condenser, two Variable Condensers, Detector, and Phones. Will overcome interference from near-by stations.

16. Two Single Slide Tuning Coils, two Fixed and one Variable Condenser, Detector, and Phones. An all-around interference preventer, and a very popular circuit.

Circuits specially for overcoming different forms of interference.

RECEIVING CIRCUITS. V

LOOP AERIALS

17. Double Slide Tuning Coil, Fixed Condenser, Detector, and Phones. A simple loop circuit.

18. Double Slide Tuning Coil, Fixed and Variable Condensers, Detector, and Phones. A practical circuit for all-around work.

19. Two Double Slide Tuning Coils, two Variable Condensers, Detector, and Phones. For overcoming interference.

20. One Single and one Double Slide Tuning Coil, Fixed and two Variable Condensers, Detector, and Phones. A very selective loop circuit. The best and most popular form.

Loop aerials somewhat less practical than the straight-away forms for general work.

RECEIVING CIRCUITS. VI

LOOSE COUPLED TUNING COILS

21. Loose Coupled Tuning Coil, Fixed Condenser, Detector, and Phones. Simplest circuit.

22. Loose Coupled Tuning Coil, Fixed and Variable Condensers, Detector, and Phones. An extremely selective and sensitive circuit. The most popular circuit.

23. Loose Coupled Tuning Coil, Loading Coil, Fixed and two Variable Condensers, Detector, and Phones. The addition of extra inductance in the circuit, when receiving very long waves. By adding the second Variable Condenser alone, short waves may be tuned in.

24. Loose Coupled Tuning Coil, Single Slide Tuning Coil, Fixed and three Variable Condensers, Detector, and Phones. This is for use in overcoming extreme interference and the humming from high-tension lines.

The best and most practical circuits for commercial and professional use.

RECEIVING CIRCUITS. VII

25. Loose Coupled Tuning Coil, Fixed and two Variable Condensers, Detector, and Phones. For loop aerials.

26. Loose Coupled and Loading Coil, Fixed and two Variable Condensers, Detector, and Phones. For loop aerials. A practical circuit.

27. Two Loose Coupled Tuning Coils, Loading Coil, Fixed and three Variable Condensers, Detector, and Phones. A weeding-out circuit. Extremely selective, and excellent for overcoming all kinds of interference.

28. Three Loose Coupled Tuning Coils, Loading Coil, Fixed and four Variable Condensers, Detector, and Phones. The tertiary weeding-out circuit. Its selectivity is wonderful, but it is not wholly practical, a slight amount of energy being lost with the addition of each additional loose coupled tuning coil.

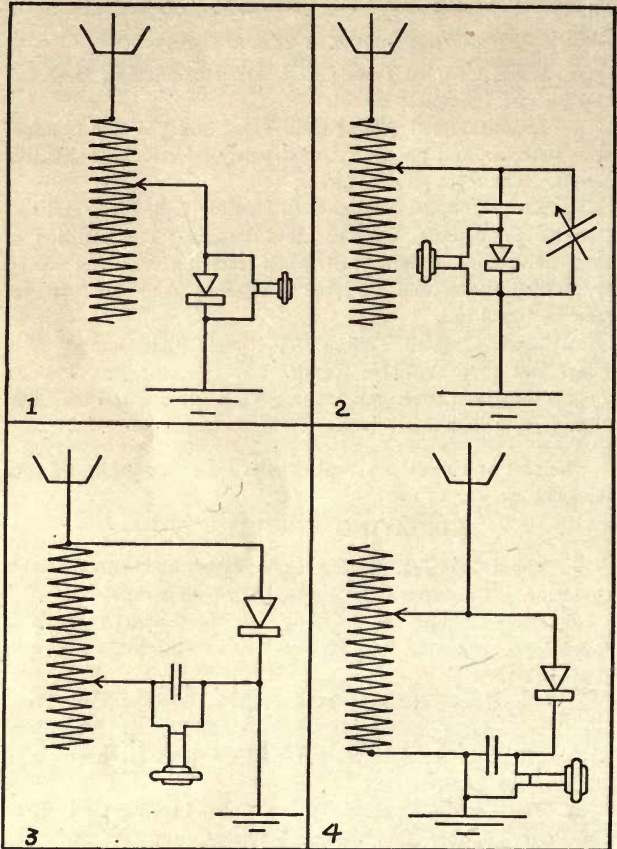

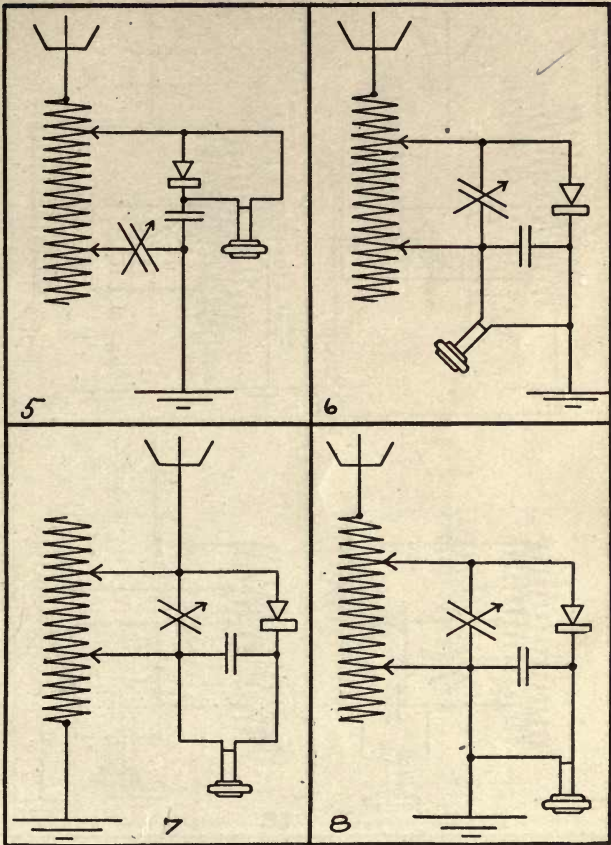

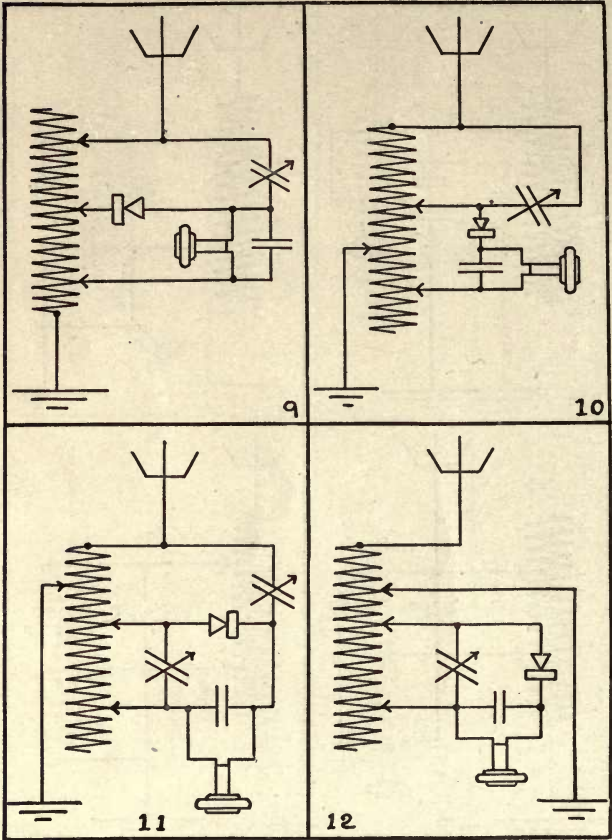

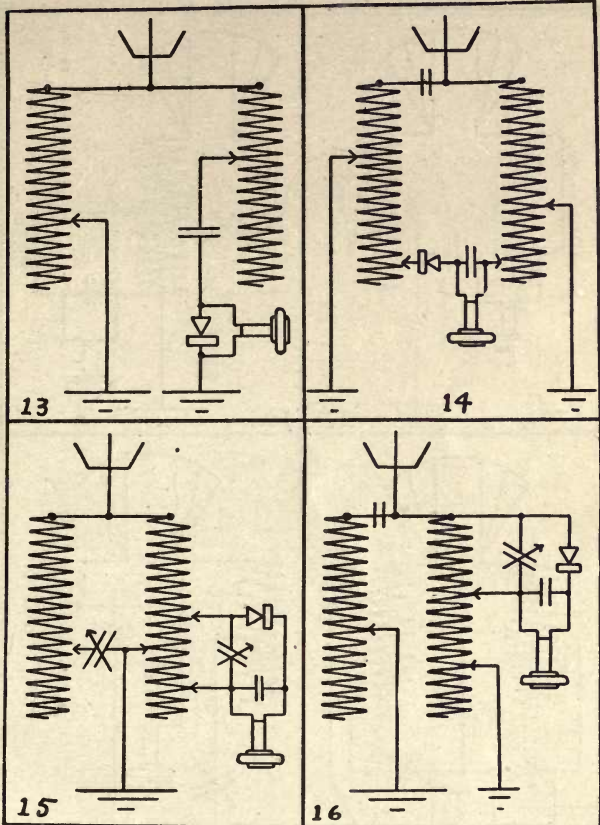

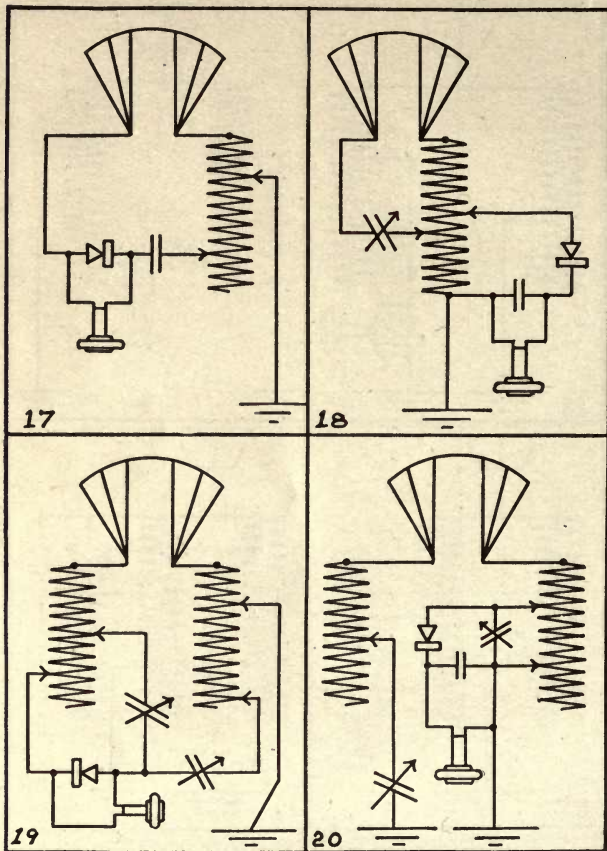

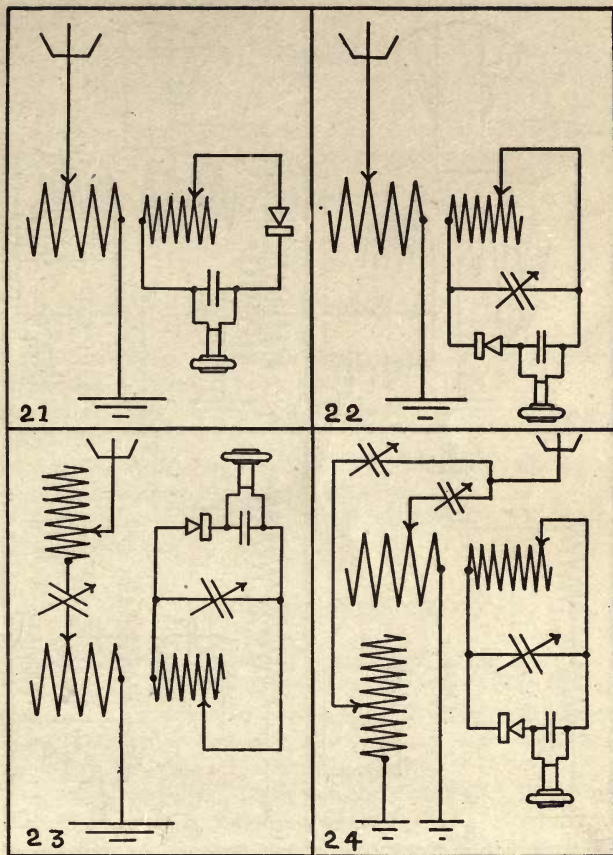

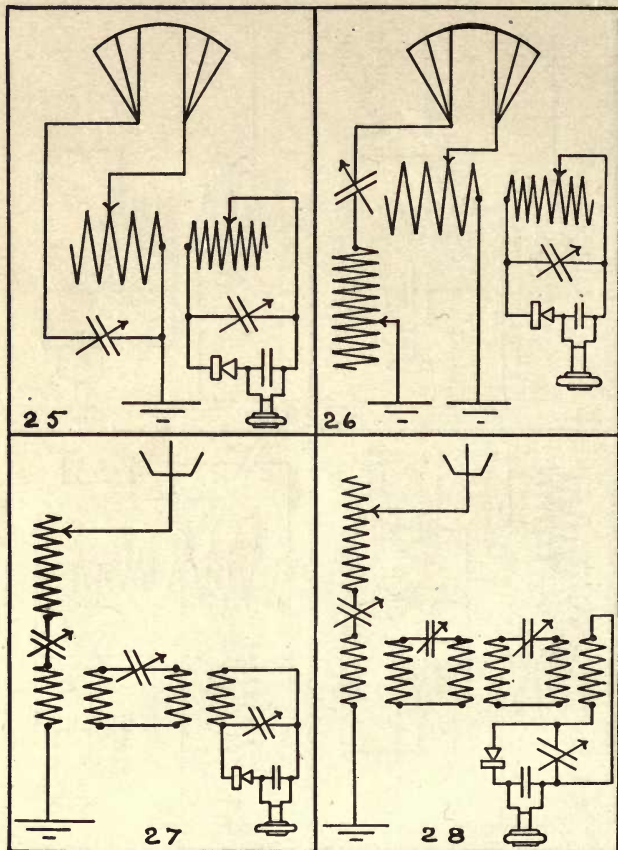

COMPLETE SETS. I

1. *Transmitting Apparatus*: Spark Coil, Spark Gap, Condenser, and a 1, 2, or 3 Clip Helix. For use with batteries and telegraph key.

Receiving Apparatus: 1, 2, or 3 Slide Tuning Coil, Fixed Condenser, Detector, and Phones. A Variable Condenser may be added.

Switch between Sending and Receiving: S.P.D.T.

A beginner's set.

COMPLETE SETS. II

2. *Transmitting Apparatus*: Spark Coil or Transformer, Spark Gap, Condenser, 3 or 4 Contact Helix. To be run from battery or power, key with durable contacts and adjustable resistance.

Receiving Apparatus: Loose Coupled Tuning Coil, Fixed and Variable Condenser, Detector, and Phones.

Switch between Sending and Receiving: D.P.D.T.

A practical set.

COMPLETE SETS. III

3. *Transmitting Apparatus*: Transformer Spark Gap, Condenser, Sending Oscillation Transformer, two protective devices for the line and transformer, Rheostat or Reactance Regulator, a Key with heavy contacts. A Condenser across the key points to prevent formation of arc between them.

Receiving Apparatus: Loose Coupled Tuning Coil, Fixed and Variable Condensers, Detector, and Phones.

Breaking-in System: Relay with single contact, protective Spark Gap, and Batteries for relay circuit.

Aerial Switch of 100 amperes.

COMPLETE SETS. IV

TWO TO FIVE KILOWATT

4. *Transmitting Apparatus:* Transformer, Spark Gap, Condenser, Oscillation Transformer, three protective devices for the transformer, the switchboard, and for the dynamo, a Reactance Regulator, key with heavy contacts with condenser.

Receiving Apparatus: Loose Coupled Tuning Coil, Loading Coil, Fixed and two Variable Condensers, Detector with potentiometer, Battery and Switch, and Phones.

Breaking-in System: Aerial Relay with two contacts, two protective Spark Gaps, Relay with six contacts for protecting the detector, and Batteries.

Switch of 100 amperes.

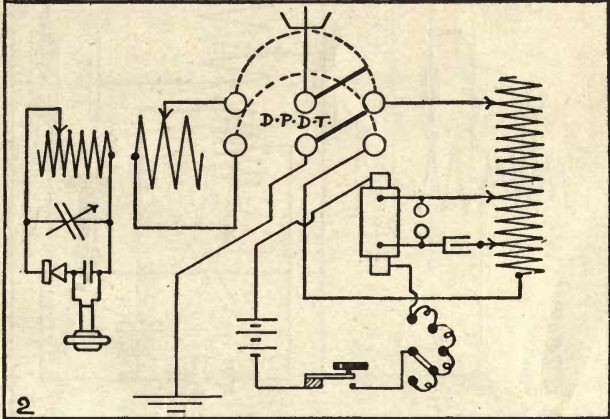
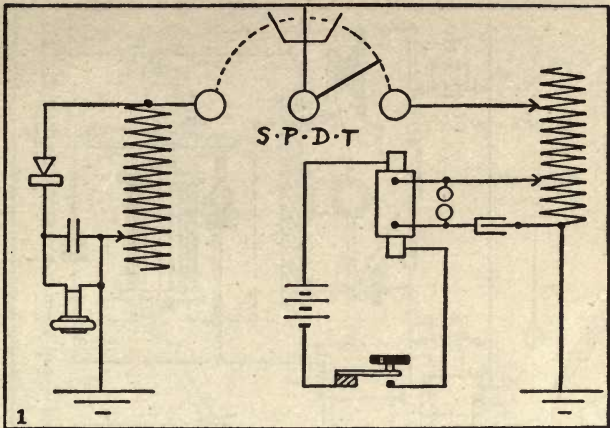

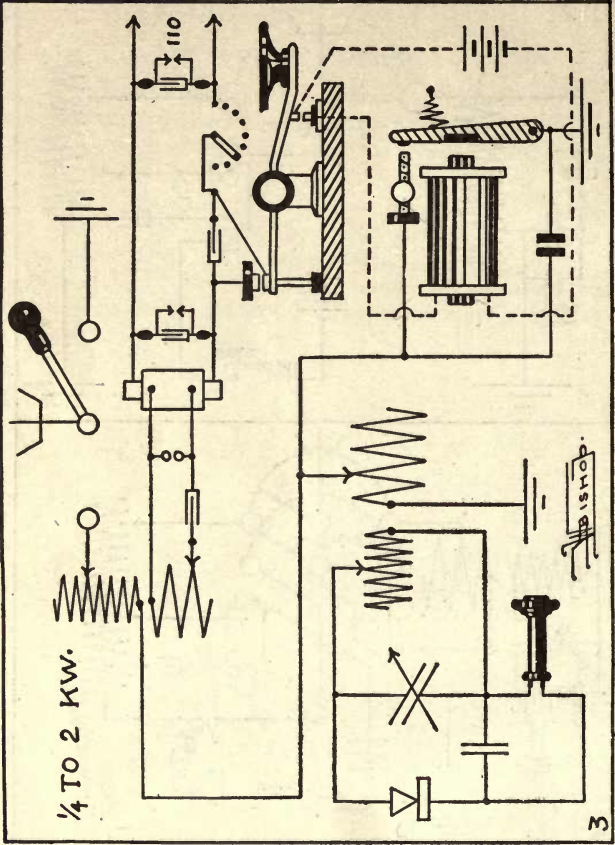

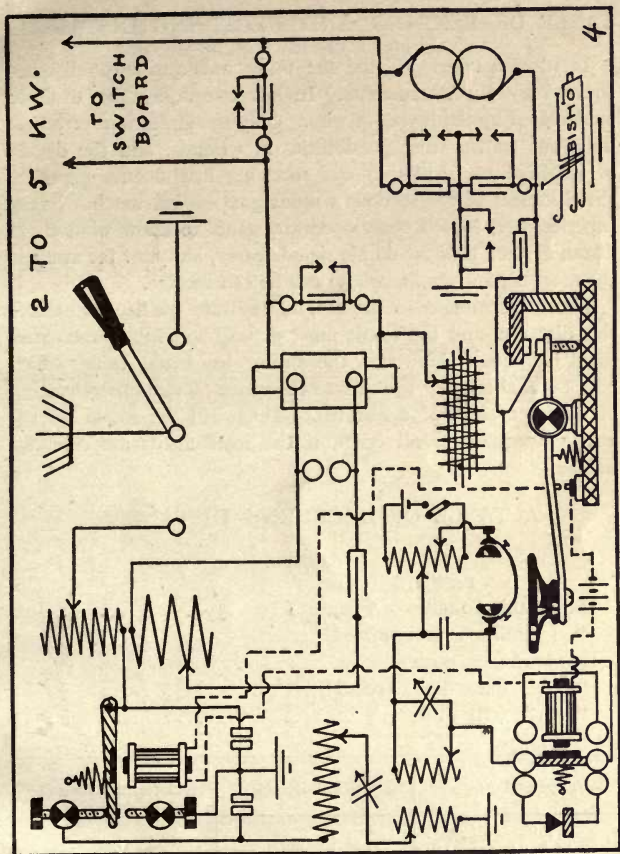

TABLE OF SENDING AND RECEIVING DISTANCES

In wireless telegraphy the one thing unknown is the distance covered by our instruments. In line telegraphy the distance is regulated by the length of wire. Only the limitations of power limit our transmitting possibilities in wireless; and the degree of sensitiveness shown in our receiving instruments regulates the distances of the stations whose signals we can catch. Every experimenter, indeed every operator, wants to know what those distances are: how far do his signals carry, and how far away is the most distant station whose call he can receive.

Every instrument in the set, its separate quality, influences this distance, and the result must depend somewhat upon personal judgment. However, the author has made tables which may be used roughly to indicate the range of stations consisting of different sorts of apparatus. They will be found pretty nearly adequate in all cases, if the instruments are carefully judged.

A TABLE OF RECEIVING DISTANCES

AERIALS

Position

Hill (within 10 miles of seacoast)	I
“ (30 miles or more inland)	$\frac{4}{5}$
Low land (sea, coast)	$\frac{9}{10}$
“ “ (clear space, inland)	$\frac{3}{4}$
“ “ (city or forest)	$\frac{1}{2}$

Type and Value	Vertical Height	Horizontal Length
T L V	$\frac{1}{2}$ in feet	$\frac{1}{10}$ in feet
Umbrella, Fan	$\frac{1}{2}$ “ “	$\frac{1}{2}$ spread, in feet
Vertical	$\frac{1}{2}$ “ “	

CIRCUIT VALUES

Circuits in back of book as standards

Number	
1, 2, 3, 13.....	$\frac{2}{5}$
4, 5, 14, 15.....	$\frac{3}{5}$
6, 16, 17, 18.....	$\frac{2}{3}$
7, 8, 9, 19.....	$\frac{7}{10}$
10, 11, 12, 20.....	$\frac{3}{4}$
25, 26, 27, 28.....	$\frac{9}{10}$
21, 22, 23, 24.....	1

DETECTORS AND TELEPHONE RECEIVERS

DOUBLE POLE, ALL COPPER WOUND

Resistance per Pair	Perikon-Elektra	Perikon with Bat.	Perikon No Bat.	Pyron or Ferron	Electrolytic	Silicon
80	20	12	10	10	8	6
250	22	13	11	11	9	7
500	23	14	12	11	10	8
750	24	14	13	12	11	8
1000	24	15	14	12	11	9
1500	25	15	14	13	12	9
2000	24	15	14	12	11	9
3000	24	16	15	12	10	10

Explanation of Table. Select conditions of the set in question, and multiply their values together to find total receiving distance of station. These distances may be nearly doubled for special atmospheric conditions, and with a good operator. Good between 8 P. M. and 4 A. M. Subtract 20% for day use.

Example

Aerial, Length	180	$\frac{1}{10} \times 180 = 18$	
“ Height	90	$\frac{1}{3} \times 90 = 30$	
	Value for Aerial	48	
Position, Low, Coast		$\frac{9}{10}$	
Circuit, No. 21		1	
Detector, Pyron, Phones 1500 ohms	13		
	$48 \times \frac{9}{10} \times 1 \times 13 = 560$	miles	

SIZES OF AERIAL WIRES

Material	Smallest Size	Largest Size	Kind
Copper	14	8	Stranded or solid
Phosphor bronze.....	12	6	Stranded or solid
Aluminum..	12	6	Solid
Iron (umbrella type)..	10	4	Solid

AERIAL INSULATION

Power	Size of Insulators
1 and 2 Inch spark coils.....	Porcelain cleats or spools
$\frac{1}{4}$ kw. set	2 inch strain insulators
$\frac{1}{2}$ “ “	2 “ “ “
1 “ “	6 “ “ “
2 “ “	6 “ “ “
3 “ “	18 “ “ “
5 “ “	18 “ “ “

A TABLE OF SENDING DISTANCES

AERIALS

Must have two or more strands

1. *Position*

On seacoast, high land, clear space.....	1
On coast, low land	$\frac{3}{4}$

High land, inland.....	$\frac{1}{2}$
Low land, city or forest.....	$\frac{1}{4}$

2. *Size*

Height of aerial over 100 feet.....	1
60-100 foot aerial.....	$\frac{3}{4}$
40-60 " ".....	$\frac{1}{2}$
30-40 " ".....	$\frac{1}{4}$

$\frac{1}{4}$
 $\frac{1}{2}$

CIRCUIT

3. *Numbers* from chapter on transmitting diagrams

11-12.....	1
5, 7, 8.....	$\frac{3}{4}$
6, 9, 10.....	$\frac{1}{2}$
1, 2, 3, 4.....	$\frac{1}{5}$

WAVE LENGTH
Not under 400 metres

POWER

4. *Transformers*

5 kw.....	600
4.....	480
3.....	420
$2\frac{1}{2}$	370
2.....	300
$1\frac{1}{2}$	290
1.....	240
$\frac{3}{4}$	210
$\frac{1}{2}$	180
$\frac{1}{4}$	120
$\frac{1}{8}$	75

5. *Battery-operated Spark Coils*

50 watts (4 inch spark coil).....	40
25 " (2 " " " ").....	25
15 " (1 " " " ").....	12
10 " ($\frac{1}{2}$ " " " ").....	8

Explanation of Table. Select the conditions of the set in question, and multiply together to obtain sending distance of the station. These distances may be nearly doubled when atmospheric conditions are especially favorable. A good operator will also improve the distance somewhat.

Example. A station on the coast, but low land; a 100-foot aerial; a good circuit, using a helix; a one 1-kw. transformer.

1 2 3 4 Result, Distance

$$\frac{3}{4} \times 1 \times \frac{3}{4} \times 240 = 135 \text{ miles}$$

COMPARISON OF COPPER AND ALUMINUM

	Copper	Aluminum
Specific gravity	8.93	2.68
Conductivity	100	63
Area.....	100	48
Diameter	100	126.04

This shows that aluminum has 63% as great conductivity and 48% of the weight of copper; that for wire of equivalent conductivity it has a cross section 60% greater and a diameter 26.4% greater than copper.

It will be noted from the relative diameters that an aluminum wire of equal conductivity with a copper wire will be almost exactly two sizes larger by the B & S Gauge.

Weight to weight, therefore, the conductivity of aluminum is greater than that of copper by 31 $\frac{1}{4}$ %

Table of Dimensions and Resistances of Pure Copper Wire.*

REVISED.

No. B. & S.	Resistance at 75°F.				lbs p. 1000 ft. ins'd H. B. & H. line wire.	Feet per lb. ins'd H. B. & H. line wire.
	R ohms per 1000 feet.	Ohms per mile.	Feet per ohm.	Ohms per pound.		
4-0	.04904	.25891	20392.9	.00007653	800	1.25
3-0	.06184	.32649	16172.1	.00012169	666	1.50
00	.07797	.41168	12825.4	.00019438	500	2.00
0	.09827	.51885	10176.4	.00030734	363	2.75
1	.12398	.65460	8066.0	.00048920	313	3.20
2	.15633	.82543	6396.7	.00077784	250	4.00
3	.19714	1.04090	5072.5	.0012370	200	5.00
4	.24858	1.31248	4022.9	.0019666	144	6.9
5	.31346	1.65507	3190.2	.0031273	125	8.0
6	.39528	2.08706	2529.9	.0049728	105	9.5
7	.49845	2.63184	2006.2	.0079078	87	11.5
8	.62849	3.31843	1591.1	.0125719	69	14.5
9	.79242	4.18400	1262.0	.0199853		
10	.99948	5.27726	1000.5	.0317946	50	20.0
11	1.2602	6.65357	793.56	.0505413		
12	1.5890	8.39001	629.32	.0803641	31	32.0
13	2.0037	10.5798	499.06	.127788		
14	2.5266	13.3405	395.79	.203180	22	45.0
15	3.1860	16.8223	313.87	.323079		
16	4.0176	21.2130	248.90	.513737	14	70.0
17	5.0660	26.7485	197.39	.816839		
18	6.3880	33.7285	156.54	1.298764	11	90.0
19	8.0555	42.5329	124.14	2.065312		
20	10.1584	53.6362	98.44	3.284374		
21	12.8088	67.6302	78.07	5.221775		
22	16.1504	85.2743	61.92	8.301819		
23	20.3674	107.540	49.10	13.20312		
24	25.6830	135.606	38.94	20.99405		
25	32.3833	170.984	30.88	33.37780		
26	40.8377	215.623	24.49	53.07946		
27	51.4952	271.895	19.42	84.39916		
28	64.9344	342.854	15.40	134.205		
29	81.8827	432.341	12.21	213.3973		
30	103.245	545.133	9.686	339.2673		
31	130.176	687.327	7.682	539.3404		
32	164.174	866.837	6.091	857.8498		
33	207.000	1092.96	4.831	1363.786		
34	261.099	1378.60	3.830	2169.776		
35	329.225	1738.31	3.037	3449.770		
36	415.047	2191.45	2.409	5482.766		
37	523.278	2762.91	1.911	8715.030		
38	660.011	3484.86	1.515	13864.51		
39	832.228	4394.16	1.202	22043.92		
40	1049.718	5542.51	.9526	35071.11		

*1 mile pure copper wire 1-16 in. diam.=13.59 ohms at 15.5°C. or 59.9°F.

Table of Dimensions and Resistances of Pure Copper Wire.*

REVISED.

No. B. & S.	Diam. Mils.	Area.		W'gt & Length. Sp. gr. 8.9		
		Circular Mils.	Square Inches.	Lbs. per 1000 ft.	Pounds per mile.	Feet per pound.
0000	460.000	211600.0	166190.2	640.73	3383.04	1.56
000	409.640	167805.0	131793.7	508.12	2682.85	1.97
00	364.800	133079.0	104520.0	402.97	2127.66	2.48
0	324.950	105592.5	82932.2	319.74	1688.20	3.13
1	289.300	83694.5	65733.5	253.43	1338.10	3.95
2	257.630	66373.2	52129.4	200.98	1061.17	4.98
3	229.420	52633.5	41338.3	159.38	841.50	6.28
4	204.310	41742.6	32784.5	126.40	667.38	7.91
5	181.940	33102.2	25998.4	100.23	529.23	9.98
6	162.020	26250.5	20617.1	79.49	419.69	12.58
7	144.280	20816.7	16349.4	63.03	332.82	15.86
8	128.490	16509.7	12966.7	49.99	263.96	20.00
9	114.430	13094.2	10284.2	39.65	209.35	25.22
10	101.890	10381.6	8153.67	31.44	165.98	31.81
11	90.742	8234.11	6467.06	24.93	131.65	40.11
12	80.808	6529.94	5128.60	19.77	104.40	50.58
13	71.961	5178.39	4067.09	15.68	82.792	63.78
14	64.084	4106.76	3225.44	12.44	65.658	80.42
15	57.068	3256.76	2557.85	9.86	52.069	101.40
16	50.820	2582.67	2028.43	7.82	41.292	127.87
17	45.257	2048.20	1608.65	6.20	32.746	161.24
18	40.303	1624.33	1275.75	4.92	25.970	203.31
19	35.890	1288.09	1011.66	3.90	20.594	256.89
20	31.961	1021.44	802.24	3.09	16.331	323.32
21	28.462	810.09	636.24	2.45	12.952	407.67
22	25.347	642.47	504.60	1.95	10.272	514.03
23	22.571	509.45	400.12	1.54	8.1450	648.25
24	20.100	404.01	317.31	1.22	6.4593	817.43
25	17.900	320.41	251.65	.97	5.1227	1030.71
26	15.940	254.08	199.56	.77	4.0623	1299.77
27	14.195	201.50	158.26	.61	3.2215	1638.97
28	12.641	159.80	125.50	.48	2.5548	2066.71
29	11.257	126.72	99.526	.38	2.0260	2606.13
30	10.025	100.50	78.933	.30	1.6068	3286.04
31	8.928	79.71	62.603	.24	1.2744	4143.18
32	7.950	63.20	49.639	.19	1.0105	5225.26
33	7.080	50.13	39.369	.15	.8014	6588.33
34	6.304	39.74	31.212	.12	.6354	8310.17
35	5.614	31.52	24.753	.10	.5039	10478.46
36	5.000	25.00	19.635	.08	.3997	13209.98
37	4.453	19.83	15.574	.06	.3170	16654.70
38	3.965	15.72	12.347	.05	.2513	21006.60
39	3.531	12.47	9.7923	.04	.1993	26427.83
40	3.144	9.88	7.7365	.03	.1580	33410.05

*1 mile pure copper wire 1-16 in. diam.=13.59 ohms at 15.5°C or 59.9°F.

TABLE OF WIRE "B. AND S." GAUGE.

GAUGE.	Diam. in 1000 inch.	Area in Circ. Mill. A=D ²	Lbs. per ft. bare.	Lbs. per ft. covered.	Feet's'c in chain. per foot.	Cents per Foot Covered.		
						At 16c. lb.	At 18c. lb.	At 20c. lb.
0000	.460	211600	.689	.821	.0000491	.1314	.1478	.1642
000	.410	167805	.507	.619	.0000619	.069	.1114	.1288
00	.365	135079	.402	.441	.000078	.0706	.0794	.0882
0	.325	105562	.319	.356	.0000983	.057	.0641	.0712
1	.289	85694	.253	.284	.000124	.0454	.0511	.0668
2	.258	66373	.201	.238	.0001564	.0376	.0428	.0470
3	.229	52854	.159	.191	.0001972	.0306	.0344	.0382
4	.204	41742	.126	.158	.0002487	.0238	.0284	.0316
5	.182	33102	.1	.127	.0003186	.0208	.0259	.0284
6	.162	26250	.079	.102	.0003965	.0163	.0184	.0204
7	.144	20816	.063	.085	.0004987	.0138	.0158	.017
8	.128	16509	.05	.069	.0006288	.011	.0124	.0139
9	.114	13094	.04	.054	.0007928	.0096	.0097	.0109
10	.102	10381	.031	.047	.001	.0075	.0065	.0073
11	.091	8284	.025	.036	.0012607	.0058	.0056	.0067
12	.081	6580	.02	.031	.0015898	.005	.0056	.0067
13	.072	5178	.016	.025	.002047	.0042	.0047	.0052
14	.064	4107	.012	.02	.0025908	.0032	.0036	.004

BUBIER PUBLISHING CO.

ESTABLISHED 1889

LYNN

MASS.

WE PUBLISH A COMPLETE LINE OF EXPERIMENTAL ELECTRICAL BOOKS FOR AMATEURS. THE LIST INCLUDES HOW TO MAKE ALL KINDS OF ELECTRICAL APPARATUS BOTH FOR PLEASURE AND PROFIT. A FEW SELECTED TITLES FROM A LIST OF OVER 150 ARE GIVEN BELOW

A. B. C. of Wireless Telegraphy.....	<i>Trevert</i>	\$1 00
Amateur and Field Magnet Winding	<i>Trevert</i>	1 50
Experimental Electricity	<i>Trevert</i>	1 00
Dynamo Electric Machinery	<i>Trevert</i>	2 50
Electricity and its Recent Application	<i>Trevert</i>	2 00
Direct Current Dynamo Designs	<i>Watson</i>	1 00
How to Make a 1-kw. Dynamo.....	<i>Watson</i>	1 00
Storage Batteries (new revised edition).....	<i>Watson</i>	1 50
Wireless Operators' Pocketbook (leather).....	<i>Bishop</i>	1 50
“ “ “ (cloth)	<i>Bishop</i>	1 00
Arithmetic of Magnetism and Electricity, <i>Morrow and Reid</i>		1 00
Electric Motor Construction for Amateurs....	<i>Parkhurst</i>	1 00

SEND FOR CATALOGUE CONTAINING COMPLETE LIST



“H-C”

**Wireless
Operator's
Head
Receivers**

IN wireless telephone receivers the important points to be considered are, first, their sensitiveness; second, the degree of comfort with which they can be worn; third, their permanence of adjustment and construction.

There are many points in the design of receivers which affect their sensitiveness. The coils must be wound so as to give the greatest possible number of turns with the least resistance. Many people assume that high resistance means great sensitiveness. This is not necessarily the case. The most efficient winding is the one having the greatest number of turns of wire nearest the cores for a given ohmic resistance. It would be possible, for instance, to wind the cores with German silver wire and get a very high resistance, but it would give a very poor receiver. The amount of iron in the cores and the quality of the iron are also important factors.

The diameter and thickness of the diaphragm and the quality of the iron from which it is made also greatly affect the sensitiveness.

Another feature that must be watched is the strength of the permanent magnets. These must be just the right strength to give the best results with the cores and diaphragms with which they are used. Permanence of adjustment can be secured only by mounting all the parts mentioned on some material which will be unaffected by heat or moisture.

H-C Head Receivers have been designed with all of the above points in view. The windings are all made with silk covered copper wire. The magnets are made from a special quality of steel and are of the proper strength to give best results with the diaphragms used. The spools and magnets are mounted in a metal cup which supports the diaphragm. The cores are ground to a proper height so that the adjustment is permanent. The metal cup is enclosed in a hard rubber shell. The two receivers are mounted on an adjustable leather covered head band. There are no nuts or screws to work loose on this band, and nothing to catch the hair. Large pneumatic rubber cushions are provided with each set, which not only shut out extraneous noises but also make the set more comfortable. These cushions are readily detachable. A six-foot two conductor green silk tinsel cord is supplied with each set also.

These sets may be wound to resistance up to 4,000 ohms.

HOLTZER-CABOT ELECTRIC CO.

BROOKLINE, MASS., U. S. A.

$\frac{1}{4}$ KW.

TRANSMITTING
SET

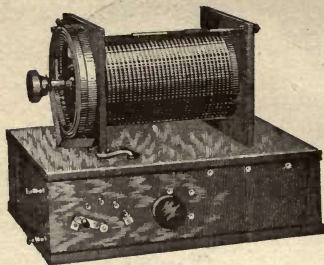

WIRELESS TELEGRAPH APPARATUS

OF

ABSOLUTE RELIABILITY

FOR

PRIVATE, COMMERCIAL & GOVERNMENT
INSTALLATION

STAMP FOR ILLUSTRATED CATALOGUE

CLAPP-EASTHAM CO.

139 MAIN STREET CAMBRIDGE, MASS.

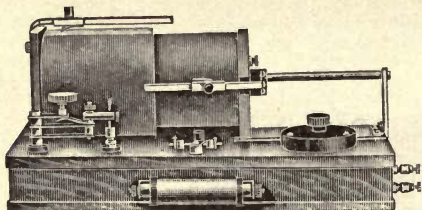

CABINET
TYPE
RECEIVING
SET

IMPROVED NAVY



THE BEST WIRELESS RECEIVER MADE FOR
LONG DISTANCE WORK

THE REASONS

SENSITIVENESS ✿ SOFT AND DISTINCT
TONE ✿ SAME PITCH IN BOTH
RECEIVERS ✿ IS THE LIGHTEST AND
MOST COMFORTABLE SET MADE

Complete outfit weighs only 10 ounces

LET US PROVE OUR CLAIMS :: SEND FOR A PAIR ON TRIAL

Send for catalogue and record bulletin F. D.

C. BRANDES

111 BROADWAY, NEW YORK

SUPPLEMENT

TO THE

Wireless Operators' Pocket-book

OF

Information and Diagrams

BY

LEON W. BISHOP

*LATEST CALL LIST OF
WIRELESS STATIONS*

ALPHABETICALLY ARRANGED

1911

BUBIER PUBLISHING COMPANY
LYNN, MASS., U.S.A.

SUPPLEMENT

Wireless Question Booklet

Information and Diagrams

1917

WIRELESS STATIONS
LATEST CALL LETTERS

Published by the
Radio Club of America

WIRELESS OPERATORS' POCKET-BOOK

OF

Information and Diagrams

SUPPLEMENT

LATEST CALL LIST OF STATIONS

Isles of Shoals, N.H.	A	S. S. Roanoke	AQ
S. S. Alabama	AB	S. S. San Jacinto	AS
S. S. Sabine	AB	S. S. Admiral Sampson	AS
S. S. Chicago	AB	Amsterdam navy-yard	ASD
S. S. Aberdeen	ABD	U. S. Army transport	Buford
S. S. Concho	AC		ATB
S. S. Denver	AD	U. S. Army transport	Dix
S. S. Victoria	AD		ATD
Amsterdam, Holland	ADM	U. S. Army transport	Sumner
S. S. Colorado	AF		ATH
S. S. Rio Grande	AG	U. S. Army transport	Kilpatrick
S. S. Yucatan	AG		ATK
S. S. Nueces	AH	U. S. Army transport	Logan
S. S. Pennsylvania	AH		ATL
S. S. Alamo	AJ	U. S. Army transport	Sherman
German pilot steamer	Jade		ATR
	AJA	U. S. Army transport	Sheridan
S. S. San Marcos	AK		ATS
S. S. Santa Clara	AK	U. S. Army transport	Thomas
S. S. Loftus Cuddy	AL		ATU
Algiers, Algeria	ALG	S. S. Dolphin	AU
Almeria, Spain	ALM	Chatham, Mass.	AU
S. S. America	AM	S. S. Seward	AV
S. S. Comal	AM	S. S. Olympia	AW
S. S. Riverside	AM	S. S. Kansas City	AX
Kamalo, Molokai, Hawaiian Islands	AM	Atlantic City, N.J.	AX
S. S. Northwestern	AN	S. S. Geo. W. Elder	AY
Antivari, Montenegro	AN	S. S. Brazos	AZ
S. S. Minda	AND	Avalon, Catalina Island, Cal.	
S. S. Ohio	AO		A2
S. S. Lampasas	AP	Tug Tyee	A3
S. S. City of Benton Harbor	AQ	Baltimore, Md. (American Building)	B
		Bocas del Toro, Panama	B

S. S. Bermudian	BA	Philadelphia, Pa. (Bellevue-Stratford)	BS
Buenos Aires, Argentine Republic	BA	Washington, D.C., Bureau of Standards	BS
Batavia, Dutch East Indies	BA	U. S. Army cablesip Burnside	BS
Abo, Russia	BAO	Sevastapol, Russia	BSP
S. S. Batavier IV	BBF	S. S. Nyades	BT
S. S. Batavier II	BBS	Butt of Lewis, Scotland	BTL
S. S. Batavier III	BBT	S. S. Rupert City	BU
S. S. Batavier V	BBV	S. S. Cabrillo	BV
S. S. Virginia	BC	S. S. Alliance	BW
S. S. W. S. Porter	BD	Vladivostok, Siberia	BWT
S. S. Trinidad	BD	S. S. City of South Haven	BX
New York, N.Y.	BD	Shoeburyness, England	BY
Buffalo, N.Y. (News Building)	BF	Babyloia, Brazil	BYN
Philadelphia, Pa.	BF	Bombay, India	BYR
Bridgeport, Conn.	BG	Bessemer Barge No. 2	B2
S. S. Iroquois	BG	Tug Goliah	B3
Helsingfors, Finland	BGF	Camaguey, Cuba	C
Quincy, Mass.	BH	S. S. City of Alpena	CA
S. S. Chippewa	BH	S. S. Coamo	CA
Benton Harbor, Mich.	BH	S. S. Priscilla	CA
Blaavands Huk, Denmark	BH	Cambridge, England	CA
S. S. Indianapolis	BI	Saginaw, Mich.	CAN
S. S. John J. Barlum	BJ	S. S. Ashtabula	CAR
Leckte, Russia	BLH	S. S. Regele Carol I	CAR
Libau, Russia	BLW	S. S. Carolina	CB
S. S. Nyack	BM	Buffalo, N.Y.	CB
S. S. Boston	BN	Boca del Colorado, Costa Rica	CB
S. S. Rosecrans	BN	Cheribon, Dutch East Indies	CB
Nikolaistadt, Russia	BNCh	S. S. Sierra	CBJ
S. S. Nann Smith	BO	S. S. City of Cleveland	CC
Brant, Rock Mass.	BO	S. S. City of Detroit	CD
S. S. Hermosa	BP	Duluth, Minn.	CD
Preste, Russia	BPS	Clifden, Ireland	CDN
S. S. Bruce	BR	Detroit, Mich.	CF
S. S. Thomas Barlum	BR	Chicago, Ill	CG
Britz, Germany	BR	Cape May, N.J.	CG
Overtoom, Holland	BRBR		
Reval, Russia	BRW		

S. S. City of St. Ignace	CG	Coruna, Italy	CO
Charlottenburg, Germany	CG	Marion, Mass.	CON
	CGS	Corvo, Azores	COR
S. S. Quadra	CH	S. S. Ponce	CP
Port Huron, Mich.	CH	Port Arthur, Ontario	CPA
San Francisco, Cal. (Chronicle	CH	S. S. Princess Charlotte	CPC
	CH	S. S. Princess May	CPM
Chamartin, Spain	CHA	S. S. Princess Royal	CPR
S. S. Harmonic	CHN	Tug Tees	CPT
S. S. Huronic	CI	S. S. Princess Victoria	CPV
Erie, Pa.	CJ	Marquette, Mich.	CQ
Sault Ste. Marie, Mich.	CJ	S. S. City of Erie	CR
S. S. San Juan	CJ	S. S. Senaca	CS
S. S. Juanita	CJA	S. S. Eastern States	CS
Detroit, Mich. (Detroit	CJL	St. Thomas, Ontario	CST
Journal)	CLS	S. S. Canada	CT
S. S. Charlois	CM	Toledo, Ohio	CT
Calumet, Mich.	CM	S. S. Tionesta	CTA
Milwaukee, Wis.	CM	S. S. City of Buffalo	CU
Buenos Aires, Argentine Re-	CM	S. S. Commonwealth	CW
public	CMA	S. S. Western States	CW
S. S. Hugh Kennedy	CMB	Detroit, Mich.	CW
S. S. Jos. Sellewood	CMD	S. S. St. Croix	CX
S. S. S. M. Clement	CMF	Cleveland, Ohio	CX
S. S. Pendenis White	CMG	Bay City, Mich.	CY
S. S. Moses Taylor	CMH	Seattle, Wash. (Hotel Perry)	DA
S. S. James Gayley	CMI		DA
S. S. W. H. Gratwick	CMJ	Santa Clara, Cuba	DA
S. S. J. J. Albright	CMK	S. S. Philadelphia	DA
S. S. Walter Scranton	CMN	S. S. Admiral	DAA
S. S. E. A. S. Clarke	CMP	S. S. Augustus B. Wolvin	DAB
S. S. Wm. E. Reis	CMQ		DAB
S. S. N. A. Hanna	CMR	S. S. Burgomaster	DAB
S. S. H. S. Houlden	CMS	S. S. Dacia	DAC
S. S. Lagonda	CMU	S. S. Field Marshal	DAF
S. S. J. J. McWilliams	CMV	S. S. Adeline	DAH
S. S. Major	CMW	S. S. Anni	DAI
S. S. Robt. L. Fryer	CN	S. S. Kronprinz	DAK
Bishop, Boston, Mass.	CN	S. S. James H. Hoyt	DAM
Cleveland, Ohio	CO	S. S. Frank H. Peavey	DAN
Ashtabula, Ohio	CO	S. S. Neubau	DAN
Cayo Criso, Cuba	CO	S. S. Prinz Regent	DAP

S. S. Adolf Woermann	DAW	S. S. Pretoria	DDT
S. S. Prinzessin	DAZ	S. S. Cleveland	DDV
Tacoma, Wash.	DB	S. S. Graf Waldersee	DDW
S. S. Caracas	DB	S. S. Prinz Adalbert	DDZ
American schooner Dorothy		Pasadena, Cal.	DE
B. Barrett	DBB	S. S. Edmund	DEH
S. S. Birkenfels	DBB	S. S. Derfflinger	DER
Durban, Hatal	DBN	S. S. Elenore Woermann	DEW
S. S. Bremen	DBR		
S. S. Bulow	DBW	Santa Barbara, Cal. (Hotel	(Hotel
Washington, D.C. (Eighth		Potter)	DF
and Water streets)	DC	Vancouver, British Columbia	DF
S. S. Iowa	DC		
S. S. Cap Arcona	DCA	S. S. Furst Bismarck	DFB
S. S. Cap Blanco	DCB	S. S. Fred. B. Wells	DFB
S. S. Cap Verde	DCE	S. S. Fritz	DFH
S. S. Cap Frio	DCF	Sacramento, Cal.	DG
S. S. Tietgen	DCF	S. S. D. G. Kerr	DGK
S. S. Clare	DCH	S. S. Grosserog von Olden-	
S. S. Kronprinzessin Cecile		burg	DGO
	DCI	S. S. Goeben	DGN
S. S. Clara Blumenfeld	DCL	S. S. Gneisenau	DGU
S. S. Cap Ortegal	DCO	S. S. Gertrude Woermann	DGW
S. S. Cap Roca	DCR		
S. S. Cap Vilabo	DCV	S. S. Kingfisher	DH
S. S. Kaiserin Augusta		S. S. Helene Blumenfeld	DHB
toria	DDA		
S. S. Bleucher	DDB	S. S. Camerones	DHC
S. S. Cincinnati	DDC	S. S. Heluan	DHE
S. S. Bulgaria	DDG	S. S. Habsburg	DHG
S. S. Pisa	DDF	S. S. Mendoza	DHM
S. S. Hamburg	DDH	S. S. Hohenstauffen	DHN
S. S. President Lincoln	DDI	S. S. Frank T. Heffeling	DHN
S. S. Batavia	DDJ		
S. S. Deutschland	DDL	S. S. Hellig Olav	DHO
S. S. Moltke	DDM	S. S. Presidente de Mintre	DHP
S. S. Pennsylvania	DDN		
S. S. Prinz Oscar	DDO	S. S. Presidente Quintana	DHQ
S. S. Patricia	DDP		
S. S. Pallanza	DDQ	S. S. Holger	DHR
S. S. Amerika	DDR	S. S. Kingsway	DI
S. S. President Grant	DDS	S. S. Imperator	DIR

San Pedro, Cal.	DJ	S. S. Prince Adalbert	DPA
S. S. James C. Wallace	DJC	S. S. Prinz Eitel Fried-	
S. S. James H. Reed	DJR	rich	DPE
Everett, Wash.	DK	S. S. Prinz Ludwig	DPL
S. S. Kronprinzessin		S. S. Prince Sigismund	DPS
Cecile	DKA	S. S. Prince Waldemar	DPW
S. S. Berlin	DKB	Eugene, Oreg.	DR
Ikeda Head, Wash.	DKD	Detroit, Mich.	DR
S. S. Friedrich der Grosse	DKD	S. S. Corcovado	DRC
S. S. Princess Irene	DKE	S. S. Prinz Regent Luit-	
S. S. Prinz Friedrich		gold	DRL
August	DKF	S. S. Roon	DRN
S. S. Konig Friedrich		South Haven, Mich.	DS
August	DKF	Port Townsend, Wash	DS
S. S. Konig Wilhelm II	DKG	S. S. Scharnhorst	DSA
S. S. Grosser Kurfurst	DKG	S. S. Senator Holthusen	DSH
S. S. Main	DKI	S. S. Sarnia	DSM
S. S. Neckar	DKK	S. S. H. P. Bope	DSO
S. S. Konigen Luise	DKL	S. S. Senator Refardt	DSR
S. S. Kaiser Wilhelm II	DK	S. S. Kleist	DST
S. S. George Washington	DKN	S. S. Siberia	DSV
	DKO	S. S. Seyditz	DSZ
S. S. Konig Albert	DKO	S. S. Titania	DTG
S. S. Kronprinz Wilhelm	DKP	S. S. Admiral	DTP
	DKR	Wilmington, Del.	DU
S. S. Rhein	DKR	Juneau, Alaska	DU
S. S. Barbarossa	DKS	S. S. Geo. W. Peavey	DUF
S. S. Kaiser Wilhelm der		S. S. United States	DUS
Grosse	DKW	Chehalis, Wash.	DV
S. S. Princess Alice	DKZ	Newport, Oreg.	DW
S. S. Lutzow	DLO	S. S. Ward Ames	DWA
S. S. Lucile Woermann	DLW	Toledo, Ohio (Hotel Secor)	
Duluth, Minn.	DM		DX
S. S. Meteor	DMR	S. S. Ypiranga	DYA
S. S. Mainz	DMZ	S. S. Yorck	DYK
San Luis Obispo, Cal.	DN	Lansing, Mich.	DZ
Drogden, Denmark	DN	Portland, Oreg.	DZ
S. S. Nora	DNH	S. S. Ziethan	DZN
S. S. Moskwa	DOA	Americanschooner Pendleton	
S. S. Oscar second	DOR	Sisters	D1
Dieppe, France	DP	Port Townsend, Wash.	D2

S. S. Earl Grey	EG	Fastnet, Ireland	FNT
S. S. El Norte	EN	Fort Monroe, Va.	FO
S. S. Easton	ES	S. S. Nacoochee	EP
Cerritos de Sinaloa, Mexico	EY	Petersburg, Alaska	FP
U. S. Army cable boat Field	FA	Fort Egbert, Alaska	FQ
S. S. City of Columbus	FA	U. S. Army Cable Ship Joseph Henry	FR
Malabang, P. I.	FA	Fort Omaha, Nebr.	FS
Fajal, Azores	FAL	Jolo, P. I.	FS
Outer Jade lightship, Ger- many	FAU	Fort Totten, N. Y.	FT
S. S. City of Atlanta	FB	Fort Levett, Me.	FV
Fairbanks, Alaska	FB	Villegignon, Brazil	FVG
Borkum Reef lightship, Ger- many	FBR	Fort H. G. Wright, N.Y.	FW
Fort Andrews, Mass.	FC	Wrangell, Alaska	FW
S. S. City of Macon	FC	Wesser lightship, Germany	FWF
Fort Wood, N. Y.	FD	S. S. City of St. Louis	FX
S. S. City of Memphis	FD	Fort Worden, Wash.	FX
Nome, Alaska	FD	S. S. City of Montgomery	FY
Ferrol, Spain	FE	U. S. Artillery harbor tug, General R. B. Ayres	FY
Kotlik, Alaska	FE	Yacht Lydonia	FZ
Elbe I lightship, Ger- many	FEF	Fort Riley, Kans.	FZ
S. S. Naomi	FG	S. S. City of Seattle	GA
Fort Gibbon, Alaska	FG	S. S. Capt. A. F. Lucas	CB
Corregidor Island, P. I.	FH	Cape Breton, Glace Bay, Nova Scotia	GB
Eider lightship, Germany	FIF	Bolt Head, England	GBA
S. S. City of Augusta	FJ	S. S. Georgia	GC
Fort Stevens, Oreg.	FJ	Brow Head, Ireland	GCK
S. S. City of Savannah	FK	Caistor, England	GCS
Circle City, Alaska	FK	Standard Oil barge 91	GD
Fort Leavenworth, Kans.	FL	Graady lightship, Den- mark	GD
Flores, Azores	FLO	S. S. City of Everett	GF
Flekkerø, Norway	FLK	S. S. Falcon	GF
Fort St. Michael, Alaska	FM	S. S. Maverick	GH
Fort Morgan, Ala.	FM	Grand Haven, Mich.	GH
Zamboanga, P. I.	FM	Gjedser, Denmark	GJ
Fort Hancock, N. J.	FN	S. S. Cottage City	GK
Flannon, Isle, Scotland	FNL	Standard Oil barge 94	GK
		Karlskrona, Sweden	GK

The Lizard, England	GLD	Helder, Holland	HDR
Liverpool, England	GLV	Fiume, Austria-Hungary	HF
Grand Marians, Minn.	GM	S. S. Mariposa	HK
S. S. Asuncion	GM	New Orleans, La.	HK
S. S. Pilgrim	GM	Cape d'Aguilar, Hongkong	HK
Malin Head, Ireland	GMH		
S. S. Atlas	GN	Haaks Lightship, Holland	HKS
North Foreland, England			
	GNF	S. S. Jefferson	HM
Niton, England	GNI	S. S. Hanalia	HN
Chicago, Ill. (Congress		S. S. Chester W. Chapin	HN
Hotel)	GO	S. S. Missouri	HN
Standard Oil barge 95	GP	Hunstanton, England	HNU
S. S. City of Pueblo	GQ	S. S. Corwin	HO
Copenhagen, Denmark	GRA	S. S. Chicago	HO
Guaraliba, Brazil	GRA	Hoek van Holland	HOK
Rosslare, Ireland	GRL	Trinidad (High Post)	HP
Grand Rapids, Mich.	GRM	Mackinac Island, Mich.	HQ
S. S. Astral	GS	Horns Reef lightship, Den-	
S. S. Senator	GS	mark	HR
S. S. Umatilla	GU	Cabo Haro, Mexico	HR
Guernsey, England	GU	Tug Savage	HS
Guadalajara, Spain	GU	S. S. Londonderry	HSM
Galveston, Texas	GV	Nak Nek, Alaska	HT
S. S. Governor	GV	Kahuku, Oahu, Hawaiian Is-	
Grand Island, La.	GW	lands	HU
S. S. President	GW	Havana, Cuba (Vedado)	HV
S. S. Queen	GX	S. S. Grant	HV
Los Angeles, Cal.	G2	S. S. Mackinaw	HW
Holland, Mich.	H	Cuban Revenue Cutter	
Horten, Norway	H	Hatuey	HY
Cape Hatteras, N. C.	HA	Ludington, Mich.	HX
New Orleans, La. (United		S. S. Humboldt	HX
Fruit Co.)	HB	Amesbury, Mass	HY
U. S. Army Artillery harbor		S. S. Plymouth	HY
tug Harvey Brown	HB	Zengg, Austria-Hungary	HZ
Heysham, England	HBR	S. S. Rose City	H2
S. S. Arizona	HC	Brest, France (arsenal)	IBF
Carlobago, Austria-Hungary		Ilha das Cobras, Brazil	ICL
	HC	Inistrahull, Ireland	IH
S. S. Alameda	HD	S. S. Illinois	IN
Elizabeth City, N.C.	HD	Toulon, France	ITF

10 WIRELESS OPERATORS' POCKETBOOK

S. S. Imperatul Traian	ITR	Pachena Point, British	
Port Vendres, France	IVF	Columbia	KPD
S. S. City of Racine	JC	S. S. Creole	KR
Kingston, Jamaica	JCA	S. S. Santa Cruz	KS
Chosi, Japan	JCS	Constanca, Roumania	KST
S. S. North Land	JD	The Dalles, Oreg.	KT
Jersey, England	JE	Tsingtau, China	KTS
S. S. Horato Hall	JH	Signalberg, Germany	KTS
S. S. Manhattan	JM	Walla Walla, Wash.	KU
Otchishi, Japan	JOI	Key West, Fla.	KW
Ose Saki, Japan	JOS	S. S. Kentucky	KY
S. S. North Star	JS	Lahaina, Maui, Hawaiian Is-	
Shiomizaki, Japan	JSM	lands	LH
Tsunoshima, Japan	JTS	Machrihanish Bay, Scot-	
S. S. James Whalen	JW	land	LK(D)
Jacksonville, Fla.	JX	Cullercoats, England	LNS
S. S. Antilles	KA	S. S. Lady Laurier	LR
Puako, Hawaiian Islands	KA	Castelneuvo, Austria-	
Angaur, Caroline Islands	KAN	Hungary	LRC
Spokane, Wash.	KB	Pola, Austria-Hungary	LRP
Bremerhaven, Lloyd Hall,		Sebenico, Austria-Hungary	LR
Germany	KBH		LR
Arkona, Germany	KAR	Loch Boisdale, Scotland	LSG
Bwlk, Germany	KBK	Lussin, Austria-Hungary	LU
Borkum, Germany	KBM	Havana, Cuba. (Morro	
Brunsbüttelkoog, Germany	KBR	Castle)	M
		Messina, Italy	M
S. S. Christopher Colum-		S. S. Alliance	MA
bus	KC	S. S. Maine	MA
Cuxhaven, Germany	KCX	S. S. Carmania	MAA
S. S. Comus	KD	S. S. Lombardia	MAB
St. Helens, Oreg.	KE	S. S. Sicilia	MAC
S. S. King Harold	KGH	S. S. Duca Degli Abruzzi	MAD
Helgoland, Germany	KHG		MAD
Yap, Caroline Islands	KJA	S. S. Duca di Genova	MAE
S. S. Momus	KM	S. S. Mendoza	MAF
Marienleuchte, Germany	KMR	S. S. Cordova	MAG
		S. S. Virginia	MAH
Erie, Pa.	KN	S. S. Caledonia	MAI
Norddeich, Germany	KND	S. S. Indiana	MAK
		S. S. Liguria	MAL
		S. S. Lusiania	MAM

S. S. Niagara	MAN	Mocangue, Brazil	MCG
S. S. Duca d'Aosta	MAO	S. S. California	MCI
S. S. Sardegna	MAS	Point Rich, Nova Scotia	MCH
Steam yacht Atalanta	MAT		MCI
American Tickle, Labrador	MAT	S. S. Chili	MCK
Asinara, Sardinia, Italy	MAS	Clarke City, Seven Islands, Canada	MCL
S. S. Umbria	MAU	Cable ship Colonia	MCM
S. S. Florida	MAV	Capo Mele, Liguria, Italy	MCN
S. S. Alva	MAV		MCO
S. S. Antony	MAY	S. S. Corsican	MCP
Mobile, Alá.	MB	S. S. Chaco	MCR
Cable steamer Mackay-Bennett	MB	Monte Capuccini, Ancona, Italy	MCT
S. S. Asturias	MBB	Cape Ray, Newfoundland	MCY
S. S. Baltic	MBC		MCZ
Bardera, Italy	MBD	S. S. Buccaneer	MD
Cape Bear, Prince Edward Island	MBE	Cape May, N. J.	MD
S. S. Araguay	MBG	Cozzo Spadaro, Cape Passaro, Sicily	MDC
Battle Harbor, Labrador	MBH	S. S. Cristobal	MDF
Belle Isle, Newfoundland	MBI	S. S. Shinnecock	MDL
Bernal, Argentine Republic	MBL	S. S. Cedric	MDN
	MBN	S. S. Dominion	MDO
S. S. Arragon	MBN	S. S. Devonian	ME
S. S. Avon	MBO	S. S. Sardinian	MEA
S. S. Ben My Chree	MBQ	Domino Island, Labrador	MEB
Bloomfield, England	MBR		MEC
Palm Beach, Fla.	MBS	Steam yacht Electra	MED
Becco di Vela, Caprera, Italy	MBV	S. S. Narragansett	MEI
S. S. Athenie	MBW	S. S. Cassandra	MEK
Brava, Italy	MBW	S. S. Iroquois	MEL
S. S. Old Colony	MC	S. S. Bohemian	MEL
S. S. Sheboygan	MC	Merka, Italy	MEN
S. S. Campania	MCA	S. S. Navahoe	MEQ
Chateau Bay, Labrador	MCB	S. S. Empress Queen	MER
Cape Cod, Mass.	MCC	S. S. Royal Edward	MES
Steam yacht Cassandra	MCD	S. S. Satrustegin	MET
S. S. Cambria	MCG	S. S. Alfonse XII	

12 WIRELESS OPERATORS' POCKETBOOK

S. S. Finance	MF	S. S. Ivernia	MIA
S. S. Lusitania	MFA	S. S. Laurentic	MIC
S. S. Arabic	MFC	S. S. Inanda	MID
S. S. Canada	MFC	S. S. Inkosi	MIK
S. S. Finland	MFD	S. S. Iolanda	MIL
S. S. W. H. Gratwick	MFD	S. S. Principesa Mafalda	MIM
Fraserburgh, Scotland	MFH	S. S. Ionian	MIN
S. S. Furnessia	MFI	S. S. Principesa Iolanda	MIO
S. S. Winifredian	MFL	Itala, Italy	MIT
S. S. Pretorian	MFN	S. S. Suevic	MJC
Fame Point, Quebec	MFP	S. S. Haverford	MJH
Fort Spuria, Messina, Italy	MFS	S. S. Merion	MJM
Tug Tatoosh	MG	S. S. Millinocket	MK
S. S. Mauretania	MGA	Milwaukee, Wis.	MK
Steam yacht Lysistrata	MGB	S. S. Olympic	MKC
S. S. Cymric	MGC	S. S. Kroonland	MKD
S. S. Saturnia	MGD	S. S. Frisia	MKF
S. S. Germania	MGE	S. S. Holland	MKH
S. S. Harvard	MGH	S. S. Corinthian	MKN
Grosse Isle, Quebec	MGI	S. S. Makara	MKU
S. S. Canadian	MGL	S. S. Killarney	MKY
S. S. Virginian	MGN	S. S. Montcalm	ML
Giumbo, Italy	MGO	S. S. Guadeloupe	MLA
S. S. Royal George	MGR	S. S. La Bretagne	MLB
S. S. Yale	MGY	S. S. Celtic	MLC
S. S. Panama	MH	S. S. Leopold II	MLD
S. S. Noordan	MHA	S. S. Lake Erie	MLE
S. S. New Amsterdam	MHB	S. S. Milwaukee	MLF
S. S. Adriatic	MHC	S. S. La Flandre	MLF
New Haven, England	MHH	S. S. La Gascoyne	MLG
S. S. Cestrian	MHL	S. S. Lake Michigan	MLH
S. S. Potsdam	MHM	S. S. Montreal	MLI
S. S. Cartheginian	MHN	S. S. Montrose	MLJ
Heath Point, Anticosti Island, Canada	MHP	S. S. Montezuma	MLK
S. S. Rotterdam	MHR	S. S. La Lorraine	MLL
S. S. Statendam	MHS	S. S. Lake Manitoba	MLM
Camperdown, Halifax, Nova Scotia	MHX	S. S. Lake Champlain	MLN
S. S. Rijndam	MHY	S. S. Mount Royal	MLO
S. S. Minnesota	MI	S. S. La Provence	MLP
		S. S. Mount Temple	MLQ
		S. S. La Navarre	MLR
		S. S. La Savoie	MLS

S. S. La Touraine	MLT	S. S. New York	MHK
S. S. La Champagne	MLU	S. S. Manitou	MNM
Lugh, Italy	MLU	S. S. Numidian	MNN
S. S. Montfort	MLW	S. S. Oranje	MNO
S. S. Monmouth	MLX	S. S. Prinses Juliana	MNP
S. S. Chicago	MLY	S. S. Marquette	MNQ
S. S. Montcalm	MLZ	S. S. Rembrandt	MNR
S. S. Minnehaha	MMA	Indian Harbor, Labrador	MNR
S. S. Madonna	MMB	S. S. Konig Wilhelm III	MNT
S. S. Majestic	MMC	S. S. Vondel	MNV
S. S. Malwa	MMD	S. S. Konig Wilhelm I	MNW
S. S. Mantua	MME	S. S. Ancona	MOA
S. S. Morea	MMF	S. S. Bologna	MOB
S. S. Egypt	MMG	S. S. Oceanic	MOC
S. S. Moldavia	MMH	S. S. Otrato	MOO
S. S. Marie Henriette	MMH	S. S. Sienna	MOE
S. S. Charles Roux	MMI	S. S. Columbia	MOI
S. S. Mongolia	MMJ	S. S. Mongolian	MON
S. S. Minnetonka	MMK	S. S. Ravenna	MOR
S. S. Macedonia	MML	S. S. Toscana	MOS
S. S. Mooltan	MMM	S. S. Taormina	MOT
S. S. Minneapolis	MMN	S. S. Verona	MOV
Punta del Este, Uruguay	MMO	S. S. Carpathia	MPA
S. S. Persia	MMQ	S. S. Empress of Britain	MPB
S. S. Marmora	MMR	S. S. Canopic	MPC
San Guilano di Trapani, Italy	MMS	S. S. Princess Clementine	MPC
S. S. Salsette	MMT	Poldhu, England	MPD
S. S. China	MMU	S. S. Lapland	MPD
S. S. Perou	MMV	S. S. Princess Elizabeth	MPE
S. S. Mesaba	MMV	S. S. Empress of China	MPG
S. S. Minnewaska	MMW	S. S. Philadelphia	MPH
S. S. India	MMY	S. S. Princess Henriette	MPH
S. S. Arabia	MMZ	S. S. Empress of India	MPI
Tug Lorne	MN	S. S. Empress of Japan	MPJ
S. S. Manitou	MN	S. S. Princess Josephine	MPL
S. S. Pannonia	MNA	S. S. Empress of Ireland	MPL
S. S. Romanic	MNC	Palmaria, Italy	MPM
North Sydney, Canada	MND	Capo Sperone, Sardinia, Italy	MPN
S. S. Menominee	MNE	Point Amour, Labrador	MPR
S. S. Grotius	MNG		

14 WIRELESS OPERATORS' POCKETBOOK

Ponza Island, Italy	MPS	S. S. San Georgio	MSH
S. S. Patris	MPT	St. John, Pattridge Island,	
S. S. Balmoral Castle	MPW	New Brunswick	MSJ
S. S. Persic	MQC	Sagaponack, N. Y.	MSK
S. S. Bunker Hill	MR	Santa Maria di Leuca,	
S. S. Caronia	MRA	Italy	MSL
S. S. Roma	MRB	S. S. St. Louis	MSL
S. S. Cretic	MRC	S. S. San Guiseppi	MSN
S. S. Sindoro	MRD	S. S. Hesperian	MSN
S. S. Regina Elena	MRE	S. S. San Guglielmo	MSO
S. S. Sannio	MRF	S. S. St. Paul	MSP
S. S. Regina d'Italia	MRG	Wellfleet, Cape Cod, Mass.	
S. S. Campania	MRH		MSW
S. S. Re d'Italia	MRI	S. S. Minto	MT
S. S. Ophir	MRJ	S. S. Ultonia	MTA
S. S. Kawi	MRK	S. S. Teutonic	MTC
Monte Mario, Rome, Italy		Cross Sand lightship,	
	MRM	England	MTD
S. S. Grampian	MRN	East Goodwin lightship, Eng-	
S. S. Re Vittorio	MRO	land	MTE
S. S. Principe di Piemonte		Gull lightship, England	MTG
	MRP	S. S. Themistocles	MTH
S. S. Soentuer	MRQ	S. S. Athinai	MTI
S. S. Rindjani	MRM	Steam yacht Florence	MTK
S. S. Tomasodi Savoia	MRS	Sunk lightship, England	
Three Rivers, Canada	MRS		MTK
Father Point, Quebec	MRT	Montreal, Quebec	MTL
S. S. Principe Umberto	MRU	S. S. Tunisian	MTN
S. S. Principe di' Udine	MRV	Torre Piloti di Malamocco,	
S. S. Willis	MRW	Italy	MTP
S. S. Tambora	MRY	S. S. Trotona	MTR
S. S. Lazio	MRZ	South Goodwin lightship,	
S. S. Ancon	MS	England	MTS
S. S. Massachusetts	MS	Tongue lightship, England	
S. S. Saxonia	MSA		MTT
Cape Sable, Nova Scotia		Murdock, Chelsea, Mass.	MU
	MSB	Musil, Austria-Hungary	MU
Siasconsett, Mass.	MSC	S. S. Umbria	MUA
Sable Island, Nova Scotia		S. S. Titanic	MUC
	MSD	S. S. Francesca	MUF
Sea Gate, N. Y.	MSE	S. S. Argentina	MUG
S. S. San Giovanni	MSF	S. S. Alice	MUL

S. S. Sicilian	MUN	S. S. Afric	MYC
S. S. Oceania	MUO	Mazatlan, Mexico	MZ
S. S. Laura	MUR	S. S. Zealandia	MZA
S. S. Sophia	MUS	S. S. Bornu	MZB
S. S. Martha Washington	MUW	S. S. Megantic	MZC
		S. S. Zeeland	MZD
S. S. Advance	MV	S. S. Florizal	MZL
S. S. New Haven	MV	S. S. Parisian	MZN
S. S. Argentina	MVA	S. S. Rosalind	MZR
S. S. Bresilia	MVB	Venice, Italy (Arsenal)	MZV
S. S. Italia	MVC		
S. S. Vaderland	MVD	Gjedser Reef lightship, Denmark	N
Montevideo, Uruguay	MVD	Nauen, Germany	NA
S. S. Europa	MVE	Cape Elizabeth, Me. (naval station)	NAB
S. S. Savoia	MVF	Portsmouth, N. H., (navy yard)	NAC
Venison Island, Labrador	MVI	Boston, Mass. (navy-yard)	NAD
Steam yacht The Viking	MVK	Cape Cod, Highland Light, Mass. (naval station)	NAE
S. S. Victorian	MVN	Newport, R. I. (naval station)	NAF
S. S. Oceania	MVO	Fire Island, N. Y. (naval station)	NAG
S. S. Viking	MVQ	Brooklyn, N. Y. (navy-yard)	NAH
S. S. Nord America	MVR	Philadelphia, Pa. (navy-yard)	NAI
S. S. America	MVS	Cape Henlopen, Lewes, Del. (naval station)	NAJ
Viesti, Mount Gargano, Italy	MVT	Annapolis, Md. ((Naval Academy)	NAK
S. S. Venezia	MVZ	Washington, D. C. (navy-yard)	NAL
S. S. Maurence	MW	Norfolk, Va. (navy-yard)	NAM
Manitowoc, Wis.	MW	Pivers Island, Beaufort, N.C. (naval station)	NAN
Wilhelmshaven, Germany	MW	Charleston, S. C. (navy-yard)	NAO
Vladivostok, Siberia	MW		
S. S. Aaro	MWA		
S. S. Runic	MWC		
S. S. Ionic	MWI		
S. S. Athenic	MWN		
S. S. Oslo	MWO		
Whittle Rocks, Quebec	MWR		
Withernsea, England	MWS		
S. S. Corinthic	MWT		
S. S. Colon	MX		
S. S. Medic	MXC		

16 WIRELESS OPERATORS' POCKETBOOK

St. Augustine, Fla. (naval station)	NAP	U. S. S. Chester	NDG
Jupiter Inlet, Neptune, Fla. (naval station)	NAQ	U. S. S. Chicago	NDI
Key West, Fla. (naval station)	NAR	U. S. S. Cincinnati	NDL
Pensacola, Fla. (navy-yard)	NAS	U. S. S. Cleveland	NDM
New Orleans, La. (naval station)	NAT	U. S. S. Colorado	NDN
San Juan, P. R. (naval station)	NAU	U. S. S. Connecticut	NDQ
Culebra, W.I. (naval station)	NAV	U. S. S. Culgoa	NDU
Guantanamo, Cuba (U. S. naval station)	NAW	U. S. S. Cyclops	NDY
Colon, Isthmian Canal Zone (naval station)	NAX	S. S. Nushagak	NE
Porto Bello, Isthmian Canal Zone (naval station)	NAY	U. S. S. Dale	NEH
U. S. S. Ajax	NBH	U. S. S. Decatur	NEJ
U. S. S. Alabama	NBI	U. S. S. Delaware	NEK
U. S. S. Albany	NBJ	U. S. S. Denver	NEM
U. S. S. Alexander	NBM	U. S. S. Des Moines	NEN
U. S. S. Arethusa	NBU	U. S. S. Dixie	NEP
U. S. S. Bailey	NCF	U. S. S. Dolphin	NEQ
U. S. S. Bainbridge	NCG	U. S. S. Don Juan de Austria (Michigan Naval Militia)	NER
U. S. S. Baltimore	NCH	U. S. S. Drayton	NET
U. S. S. Barry	NCK	U. S. S. Dubuque	NEU
U. S. S. Biddle	NCM	U. S. S. Eagle	NFC
U. S. S. Birmingham	NCN	U. S. S. Farragut	NFP
U. S. S. Brutus	NCT	U. S. S. Flusser	NFS
U. S. S. Buffalo	NCU	U. S. S. Galveston	NGD
U. S. S. Burrows	NCV	U. S. S. Georgia	NGF
U. S. S. Caesar	NCY	U. S. S. Glacier	NGH
U. S. S. California	NCZ	U. S. S. Goldsborough	NGJ
S. S. Northland	ND	U. S. S. Gopher (Minnesota Naval Militia)	NGK
U. S. S. Castine	NDA	U. S. S. Hannibal	NGU
U. S. S. Celtic	NDB	U. S. S. Hartford	NGV
U. S. S. Charleston	NDC	U. S. S. Hector	NGX
U. S. S. Chattanooga	NDE	U. S. S. Helena	NGY
U. S. S. Chauncey	NDF	S. S. Wilhelmina	NH
		U. S. S. Hopkins	NHC
		U. S. S. Hull	NHE
		U. S. S. Idaho	NHN
		U. S. S. Illinois	NHO
		U. S. S. Indiana	NHQ
		U. S. S. Iowa	NHT
		U. S. S. Isis	NHU

S. S. Klamath	NI	U. S. S. New Orleans	NMG
U. S. S. Jupiter	NIE	New York nautical school	
U. S. S. Justin	NIF	ship Newport	NMH
U. S. S. Kansas	NIO	U. S. S. New York	NMI
U. S. S. Kearsarge	NIP	U. S. S. North Carolina	NMN
U. S. S. Kentucky	NIQ	U. S. S. North Dakota	NMO
U. S. S. Lamson	NIW	U. S. S. Ohio	NMW
U. S. S. Lawrence	NIY	U. S. S. Olympia	NMX
U. S. S. Lebanon	NIZ	Nonendamm, Germany	NO
U. S. S. Leonidas	NJA	U. S. S. Paducah	NOG
U. S. S. Louisiana	NJB	U. S. S. Panther	NOJ
U. S. S. Macdonough	NJH	U. S. S. Patapsco	NOL
U. S. S. Machias	NJI	U. S. S. Patuxent	NOM
U. S. S. Maine	NJL	U. S. S. Paulding	NON
U. S. S. Marietta	NJQ	U. S. S. Paul Jones	NOP
U. S. S. Mars	NJR	U. S. S. Pennsylvania	NOT
U. S. S. Maryland	NJS	U. S. S. Perkins	NOX
U. S. S. Massachusetts	NJT	U. S. S. Perry	NOY
U. S. S. Mayrant	NJU	Cordova, Alaska (naval	
U. S. S. Mayflower	NJV	station)	NPA
U. S. S. McCall	NJW	Sitka, Alaska (naval	
U. S. S. Michigan	NJZ	station)	NPB
S. S. Pequonock	NK	Bremerton, Wash. (navy-	
U. S. S. Milwaukee	NKA	yard)	NPC
U. S. S. Minnesota	NKD	Tatoosh Island, Wash. (naval	
U. S. S. Mississippi	NKE	station)	NPD
U. S. S. Missouri	NKF	North Head, Wash. (naval	
U. S. S. Montana	NKM	station)	NPE
U. S. S. Monterey	NKN	Cape Blanco, Oreg. (naval	
U. S. S. Montgomery	NKO	station)	NPF
U. S. S. Nanshan	NKV	Table Bluff, Cal. (naval	
Nantucket Shoals light-		station)	NPG
ship	NLA	North Post, Trinidad	NPG
Diamond Shoals light-		Mare Island, Cal. (navy-	
ship	NLB	yard)	NPH
Frying Pan Shoals light-		Farallon Islands, Cal. (naval	
ship	NLC	station)	NPI
U. S. S. Nebraska	NMA	Yerba Buena Island, Cal.	
U. S. S. Nero	NMB	(naval station)	NPJ
U. S. S. New Hampshire	NME	Point Arguello, Cal. (naval	
	NMF	station)	NPK
U. S. S. New Jersey			

18 WIRELESS OPERATORS' POCKETBOOK

Point Loma, Cal. (naval station)	NPL	U. S. S. Tonopah	NUN
Honolulu, Hawaii (naval station)	NPM	U. S. S. Truxtun	NUS
Guam, Marianas (naval station)	NPN	S. S. Charles S. Nelson	NV
Cavite, P. I. (naval station)	NPO	U. S. S. Vermont	NVK
Nieuport, Belgium	NPT	U. S. S. Vestal	NVL
S. S. Holland	NQ	U. S. S. Vicksburg	NVN
U. S. S. Pompey	NQF	U. S. S. Virginia	NVR
U. S. S. Prairie	NQM	U. S. S. Vulcan	NVT
U. S. S. Preble	NQN	S. S. Northwest	NW
U. S. S. Preston	NQO	Nawiliwili, Kauai, Hawaiian Islands	NW
U. S. S. Princeton	NQP	U. S. S. Warrington	NWD
U. S. S. Prometheus	NQR	U. S. S. Washington	NWE
U. S. S. Rainbow	NRA	U. S. S. West Virginia	NWG
U. S. S. Raleigh	NRB	U. S. S. Wheeling	NWH
Massachusetts nautical school ship Ranger	NRC	U. S. S. Whipple	NWI
U. S. S. Reid	NRE	U. S. S. Wilmington	NWK
U. S. S. Rhode Island	NRI	U. S. S. Wisconsin	NWM
U. S. S. Decatur	NRJ	U. S. S. Worden	NWP
U. S. S. Roe	NRM	U. S. S. Yankton	NXB
U. S. S. Salem	NRZ	U. S. S. Yorktown	NXD
S. S. New Hampshire	NS	New York, N. Y. (42 Broadway)	NY
U. S. S. Saturn	NSF	Tug Fearless	N2
U. S. S. Scorpion	NSG	S. S. Hamilton	OA
U. S. S. Smith	NSQ	S. S. Atlanta	OAA
U. S. S. Solace	NST	S. S. Columbia	OAC
U. S. S. South Carolina	NSW	S. S. Sophia Hohenberg	OAH
U. S. S. South Dakota	NSX	S. S. Princess Anne	OB
U. S. S. Sterling	NTA	S. S. Jamestown	OC
U. S. S. Sterrett	NTB	S. S. Jefferson	OD
U. S. S. Stewart	NTC	New York, N. Y. (Herald ship news office, The Battery)	OHX
U. S. S. St. Louis	NTF	S. S. Kayo Maru	OKY
U. S. S. Stringham	NTI	Pernambuco, Brazil	OL
U. S. S. Supply	NTK	S. S. Monroe	OM
S. S. J. S. Chanslor	NU	U. S. Artillery harbor tug General Randall	OR
U. S. S. Tacoma	NUA	S. S. Olivette	OV
U. S. S. Tennessee	NUG	S. S. Mascotte	OW
U. S. S. Terry	NUI	Berlin, Germany	OW

SUPPLEMENT

19

Oxford, England	OX	Alpena, Mich.	PN
S. S. Miami	OZ	Katalla, Alaska	PN
New York, N. Y. (Hotel Plaza)	P	Manila, P. I.	PN
Isle of Pines, Cuba	P	Ponta Negra, Brazil	PNA
Seattle, Wash. (University grounds)	PA	Cordova, Alaska	PO
S. S. Prince Albert	PA	Kronstadt (Fort Menschikoff), Russia	PPZ
Ketchikan, Alaska	PB	Monterey, Cal.	PQ
Pemba Island, Zanzibar	PB	S. S. City of Chicago	PQ
Astoria, Oreg.	PC	Parkeston Quay, England	PQL
Tampa, Fla.	PD	North Vancouver, British Columbia	PR
Friday Harbor, Wash.	PD	Prince Rupert, British Columbia	PRD
Port Said, Egypt	PD	San Francisco, Cal. (Presidio)	PS
Providence, R. I.	PF	Port of Spain, Trinidad	PS
Aberdeen, Wash.	PF	Fort Bragg, Cal.	PT
Westport, Wash.	PG	St. Petersburg, Russia	PTB
Payo Obispo, Mexico	PG	Bellingham, Wash.	PU
Point Grey, British Columbia	PGD	S. S. Mobilla	PU
San Francisco, Cal.	PH	S. S. Providence	PV
Avalon, Catalina Island, Cal.	PI	Victoria, British Columbia	PW
Fort Frank, P. I.	PIA	Los Angeles, Cal. (Examiner)	PX
Fort Drumm, P. I.	PIB	Olympia, Wash.	PY
Fort Wint, P. I.	PIC	S. S. Enterprise	P1
Fort William McKinley, P. I.	PID	S. S. Hilonian	P2
Point Judith, R. I.	PJ	S. S. Portland	P3
Los Angeles, Cal. (Boyle Heights)	PJ	S. S. Col. E. L. Drake	P4
San Diego, Cal.	PK	Standard Oil barge 3	P5
Porthcuno, Cornwall England	PK	S. S. Buckman	P7
Port Tewfik, Egypt	PK	S. S. Watson	P8
Peking, China (Italian embassy)	PK	S. S. Bertha	P9
Eureka, Cal.	PM	Quebec	Q
Bahia Blanca, Argentine Republic	PM	Bluefields, Nicaragua	Q
Pere Marquette car ferry No. 5	PM5	Alderney, England	QDH
		Washington, D. C. (Elliott Woods)	QK
		Antwerp, Belgium	QR

UNITED
RELEASES
CO.

20 WIRELESS OPERATORS' POCKETBOOK

Bermuda	QWC	U. S. revenue cutter	Semi-
Reggio, Italy	R	nole	RCS
S. S. Algeria	RAG	U. S. revenue cutter	Thetis
S. S. Governor Cobb	RB		RCT
Lightship Recalada, La Plata		U. S. revenue cutter	Acush-
River, Argentine Re-		net	RCU
public	RC	U. S. revenue cutter	Win-
U. S. revenue cutter Algon-		dom	RCW
quin	RCA	U. S. revenue cutter	Yama-
U. S. revenue cutter Bear		craw	RCY
	RCB	S. S. La Rapide	RD
U. S. revenue cutter Andros-		S. S. France	RFR
coggin	RCD	S. S. Formosa	RFS
U. S. revenue cutter Seneca		New Haven, England	RHN
	RCE	S. S. Ile-de-France	RIF
U. S. revenue cutter Sno-		S. S. Russie	RIO
homish	RCF	S. S. Italie	RIT
U. S. revenue cutter Gres-		Tug Relief	RJ
ham	RCG	Rio de Janeiro, Brazil	RJ
U. S. revenue cutter McCul-		Rijo, Brazil	RJI
lough	RCH	Corkbeg, England	RJF
U. S. revenue cutter Itasca		Santa Rosalia, Mexico	RH
	RCI	S. S. Plata	RLA
U. S. revenue cutter Wood-		S. S. Puritan	RN
bury	RCJ	S. S. Calvin Austin	RN
U. S. revenue cutter Tahoma		S. S. Atrato	RNA
	RCK	Magdalena	RND
U. S. revenue cutter Tusca-		S. S. Nile	RNJ
rora	RCL	S. S. Clyde	RNK
U. S. revenue cutter Mo-		S. S. Thames	RNM
hawk	RCM	S. S. Orinoco	RNO
U. S. revenue cutter Mann-		S. S. Ortona	RNQ
ing	RCN	S. S. Trent	RNR
U. S. revenue cutter Onon-		S. S. Tagus	RNS
daga	RCO	S. S. Orotava	RNV
U. S. revenue cutter Apache		S. S. Oruba	RNU
	RCP	S. S. Berbice	RNX
U. S. revenue cutter Perry		S. S. Premier	RP
	RCQ	S. S. Pampa	RPP
U. S. revenue cutter Rush		S. S. Parana	RPR
	RCR	S. S. I. J. Merritt	RQ
		S. S. Marquette	RQ

Dover, England	RQW	S. S. Wm. P. Porter	SND
Rixhoft, Germany	RRX	S. S. Wilpèn	SNW
S. S. Rescue	RS	S. S. King Oscar II	SOR
Pinar del Rio, Cuba	RS	Sorvaagen, Norway	SOT
Rost, Norway	RST	S. S. Prinz Joachim	SP
Port Arthur, Tex.	RU	S. S. Russia	SRN
S. S. Governor Dingley	RV	S. S. Puritan	SQ
U. S. Artillery Harbor Tug		S. S. Stanley	ST
Captain Rowell	RW	Santa Maria, Azores	STM
Mexican cable ship Relay	RX	Savannah, Ga.	SV
S. S. Yale	RY	Southwest Pass, La.	SW
Raza, Brazil	RZA	Seattle, Wash.	S2
Cambridge, Mass.	S	Cherbourg, France	TCF
S. S. Salvor	SAL	S. S. Chito Maru	TCY
S. S. Satellite	SAT	Dunkerque, France	TDF
S. S. Prinz August Wilhelm	SB	Tobermory Island, Scotland	THM
S. S. Birma	SBA	S. S. Hong Kong Maru	THN
S. S. Indiana	SC	Triangle Island, British Columbia	TLD
S. S. Tasco	SC	Lorient, France	TLF
Bari, Italy	SC	Port Patrick, England	TLK
S. S. J. F. Tietgen	SCF	S. S. America Maru	TMC
Scheveningen, Holland	SCH	Tjomo, Norway	TMO
Felixstowe, England	SCQ	Rame Head, England	TMP
S. S. Estonia	SEA	S. S. Tennessee	TN
San Francisco, Cal.	SF	Tienstin, China	TN
S. S. Prinz Eitel Frederich	SF	S. S. Nippon Maru	TNP
S. S. Prinz Sigismund	SG	Oran, Algeria	TOF
Sault Ste. Marie, Mich.	SH	Brest, France	TQF
S. S. Oceana	SK	S. S. Rosina	TR
Cape Lazo, B. C.	SKD	Rochefort, France	TRF
Skegness, England	SKE	S. S. Tenyo Maru	TTY
San Jose del Cabo, Mexico	SJ	Tempelhofer, Germany	TU
S. S. Litunia	SLA	Kiel, Germany (torpedo station)	TVK
S. S. Sierra	SM	Scilly Islands, England	TVP
Ponta Delgado, San Miguel, Azores	SMG	Tangiér, Morocco	TW
Windmill Hill, Gibraltar	SMP	Portland, England	TWQ
Charleston, S. C. (Hampton Park)	SN	New York, N. Y., (111 Broadway)	TWT
Santiago de Cuba, Cuba	SN	S. S. Jos. Vacarro	TY
Barge Shenango	SNA		

22 WIRELESS OPERATORS' POCKETBOOK

Tacoma, Wash.	T2	S. S. Prince George	UPG
S. S. Ellis	UA	Porquerolies France	UPQ
S. S. Preston	UB	S. S. Prince Rupert	UPR
Boulogne, France	UBL	S. S. Santa Rita	US
S. S. Buffalo	UBO	Estevan Point, B. C.	USD
S. S. Cartago	WC	S. S. Eskimo	USK
S. S. Ucayali	UCL	St. Marie de la Mer, France	
S. S. Lansing	UD		USM
S. S. Parisiana	UD	S. S. St. Vincent	USV
S. S. Idaho	UDI	S. S. Admiral Dewey	UV
Rama, Nicaragua	UE	S. S. Verdi	UVD
S. S. Admiral Schley	UG	S. S. Vasari	UVR
S. S. Galilee	UGO	S. S. Admiral Farragut	UW
S. S. Heredia	UH	S. S. Pectan	UW
S. S. Herman Frasch	UHF	S. S. San Paulo	UWK
S. S. Noruega	URG	S. S. Minas Geraes	UWN
S. S. Highland Laddie	UHL	S. S. Rio de Janeiro	UWR
S. S. Highland Pride	UHP	S. S. Texas	UXS
S. S. Highland Rover	UHR	S. S. Lurline	U2
Cape San Antonio, Cuba	UJ	San Giovanni, Italy	V
S. S. Acre	UJA	S. S. Apache	VA
S. S. Sergipe	UJB	S. S. Arapahoe	VB
S. S. Orion	UJC	S. S. Comanche	VC
S. S. Bahia	UJG	S. S. Villa de Douvres	VD
S. S. Marnhao	UJH	Yacht Vanadis	VDS
S. S. Olinda	UJI	S. S. Iroquois	VF
S. S. Brazil	UJK	Sheerness, England	VFM
S. S. San Salvador	UJM	S. S. Algonquin	VG
S. S. Goyaz	UJN	S. S. Huron	VH
S. S. Para	UJO	S. S. Seminole	VJ
S. S. Saturno	UJP	S. S. Cherokee	VK
S. S. Manaos	UJQ	Wyl lightship, Denmark	VL
S. S. Jupiter	UJR	S. S. Mohawk	VM
S. S. Ceara	UJV	Victoria, British Columbia	
S. S. Alagoas	UJY		VSD
S. S. Sirio	UJZ	Victoria, British Columbia	V2
S. S. Turralba	UK	New York, N. Y. (Waldorf-	
S. S. Huallaga	ULA	Astoria)	WA
S. S. Santa Maria	UM	S. S. China	WA
S. S. Antenas	UM	S. S. W. B. Davock	WB
S. S. Druid	UMD	S. S. Beaver	WB
Ouessant, France	UOS	Wiborg, Italy	WB

S. S. Morro Castle	WC	S. S. Alabama	GX
S. S. Bear	WD	S. S. Virginia	XK
Bayonne, N.J.	WD	S. S. Alaska	XK
S. S. City of Lowell	WE	Duluth, Minn.	XKA
S. S. Manchuria	WE	Houghton, Mich.	XKD
Escuela Naval, Chile	WEN	Sault Ste. Marie, Mich.	XKG
Playa Ancha, Chile	WFT	Cheboygan, Mich.	XKJ
S. S. Seguranca	WG	Toledo, Ohio	XKS
S. S. Havana	WH	Cleveland, Ohio	XKW
S. S. Korea	WK	S. S. Mindora	XM
Las Salinas, Chile	WLS	Escanaba, Wis.	XMB
S. S. Merida	WM	Milwaukee, Wis.	XMH
S. S. Mongolia	WN	Chicago, Ill.	XMJ
Wilsons Point, Conn.	WN	Michigan City, Ind.	XMQ
Eastport, Me.	WQ	Ludington, Mich.	XMV
S. S. City of Traverse	WQ	S. S. J. L. Lawrence	XN
New London, Conn.	WS	S. S. City of Norfolk	XN
S. S. Asia	WT	S. S. City of Baltimore	XO
S. S. Siberia	WU	Xcalac, Mexico	XP
S. S. Vigilancia	WV	S. S. Louise	XQ
S. S. Mexico	WX	S. S. Quick Step	XQ
S. S. Monterey	WY	S. S. Jos. Wharton	XW
Motor yacht Sea Otter	WY	S. S. S. V. Luckenbach	YA
S. S. Esperanza	WZ	S. S. Paraguay	YA
U. S. Artillery harbor tug		S. S. Thalia	YA
Reno	X	S. S. Aki Maru	YAK
Port Limon, Costa Rico	X	S. S. Awa Maru	YAW
S. S. Hendrick Hudson	XA	S. S. Toledo	YD
S. S. Arizona	XA	S. S. Inaba Maru	YIB
S. S. City of Philadelphia	XA	S. S. Iyo Maru	YIY
New York, N. Y. (66 Broad-		S. S. Kaga Maru	YKG
way)	XAS	S. S. Illinois	YN
New York, N. Y. (Metropo-		S. S. Shinano Maru	YSN
litan tower)	XAV	S. S. Tamba Maru	YTB
S. S. City of Wilmington	XB	S. S. Tango Maru	YTG
S. S. Robert Fulton	XB	S. S. Toso Maru	YTS
Philadelphia, Pa.	XBG	S. S. Ossabow	ZB
Washington, D. C. (Evans		S. S. Ogeechee	ZK
Building)	XBM	S. S. Satilla	ZM
S. S. Walter Adams	XD	S. S. Altamaha	ZQ
S. S. Florida	XF	Zanzibar	ZR
		S. S. Ocmulgee	ZU

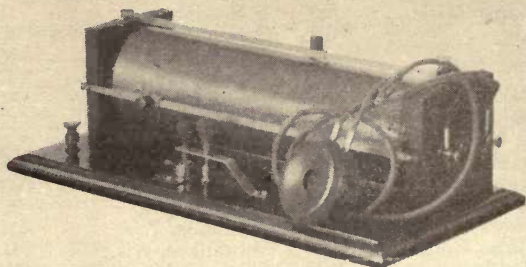

RELIABLE WIRELESS APPARATUS

OUR POLICY—To manufacture wireless apparatus of advanced scientific design, easily operated and thorough in every detail of workmanship.

OUR STOCK—Includes complete sending sets, receiving sets, head receivers, tuning coils, detectors, spark gaps, condensers, keys, supplies apparatus parts, etc.

OUR PRICE—Much less than generally charged for instruments of the same quality.

Complete Receiving Sets (as shown in the cut) **\$5.95**. Also various grades up to **\$85.00** for finest professional set. Sending sets for all distances and all prices.

Send stamp for catalogue.

ALDEN WIRELESS COMPANY
1210 Montello Street : Campello, Mass.

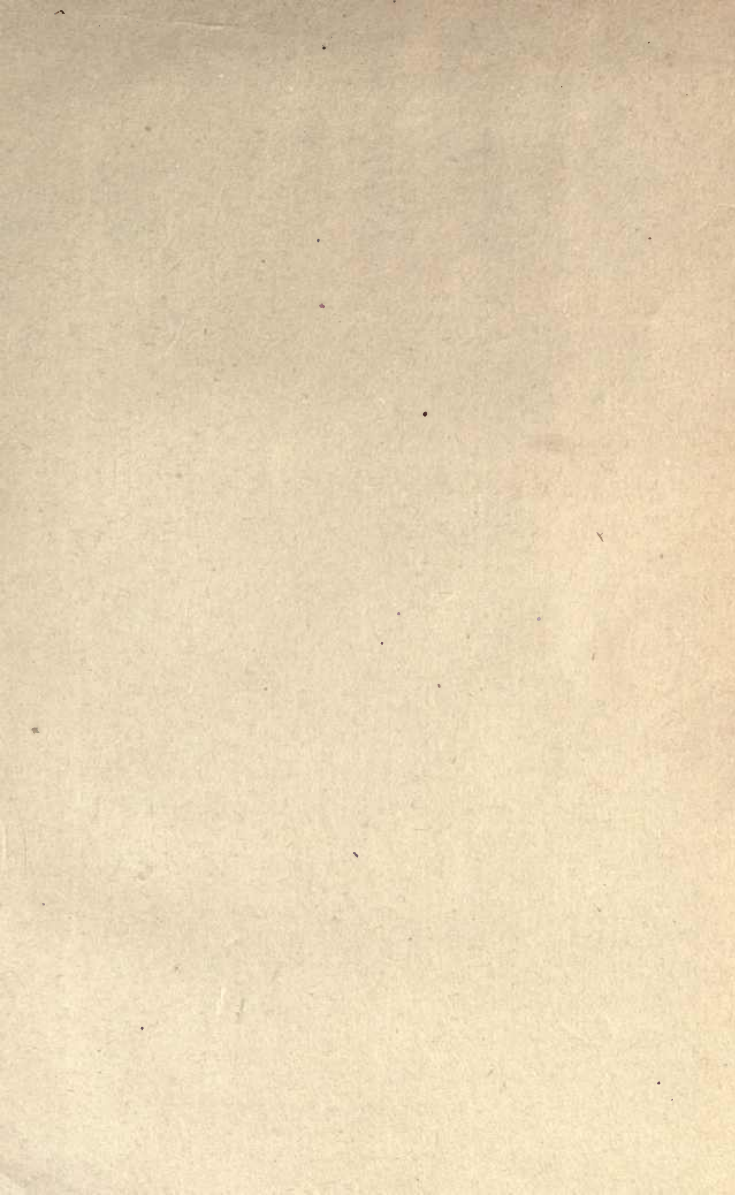

THIS BOOK IS DUE ON THE LAST DATE
STAMPED BELOW

AN INITIAL FINE OF 25 CENTS

WILL BE ASSESSED FOR FAILURE TO RETURN
THIS BOOK ON THE DATE DUE. THE PENALTY
WILL INCREASE TO 50 CENTS ON THE FOURTH
DAY AND TO \$1.00 ON THE SEVENTH DAY
OVERDUE.

MAR 26 1952

JAN 2 - 1952

A. K. Smiley Public Library
Redondo, Calif.

INTER-LIBRARY LOAN

No 30'51JK

LIBRARY USE

OCT 23 1955

OCT 23 1955 LW

YB 15627

TK5743

B 5

222658

Bishop

