

UC-NRLF



QB 33 023

WIRELESS TRANSMISSION OF PHOTOGRAPHS

MARCUS J. MARTIN



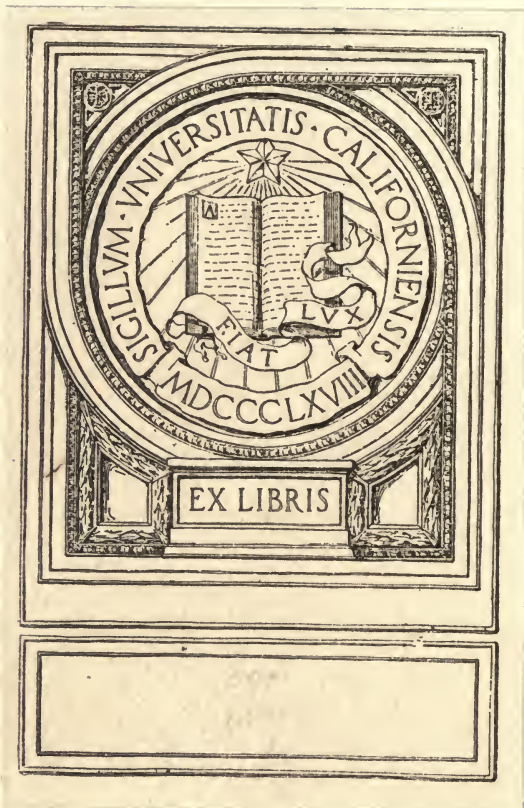

SIGILLUM · VNIVERSITATIS · CALIFORNIENSIS
MDCCCLXVIII

EX LIBRIS

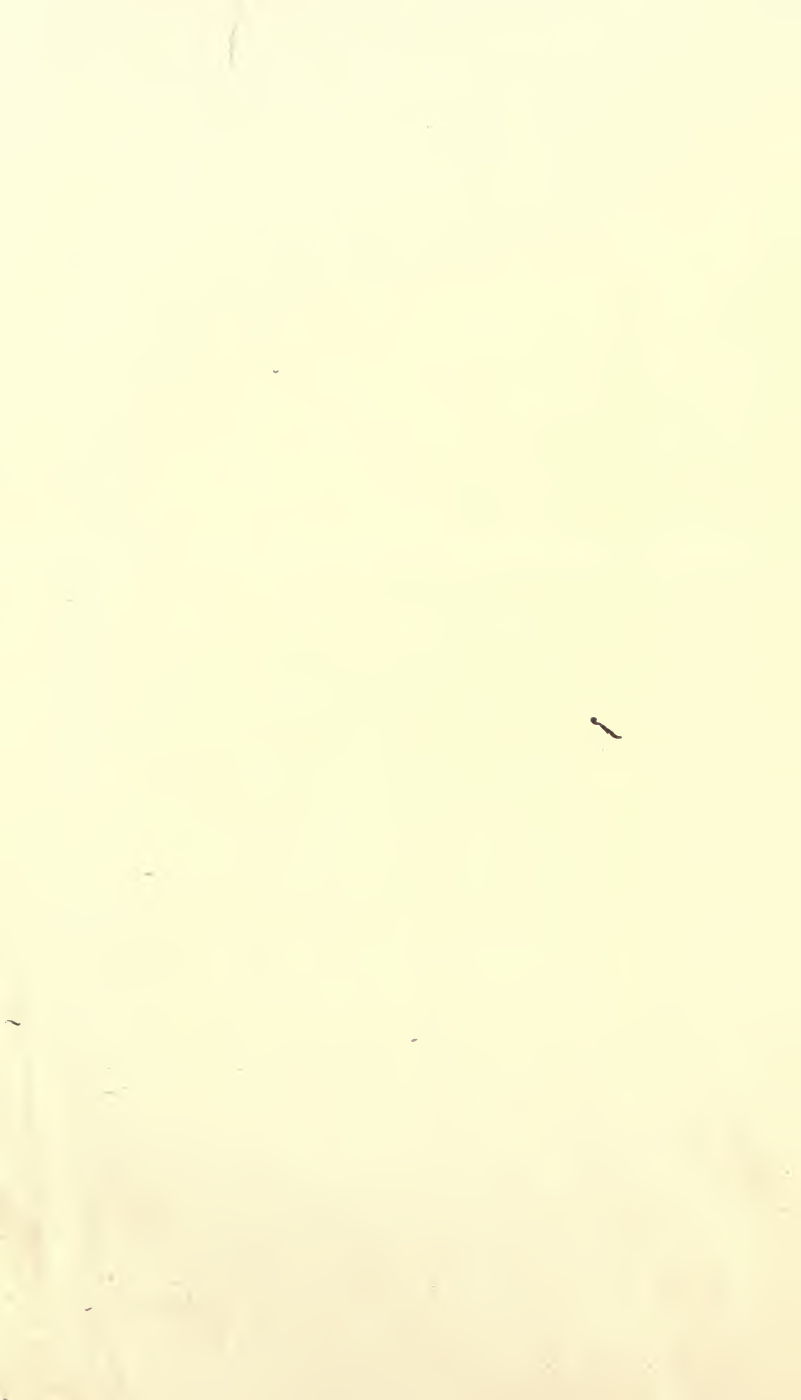

WIRELESS TRANSMISSION OF PHOTOGRAPHS

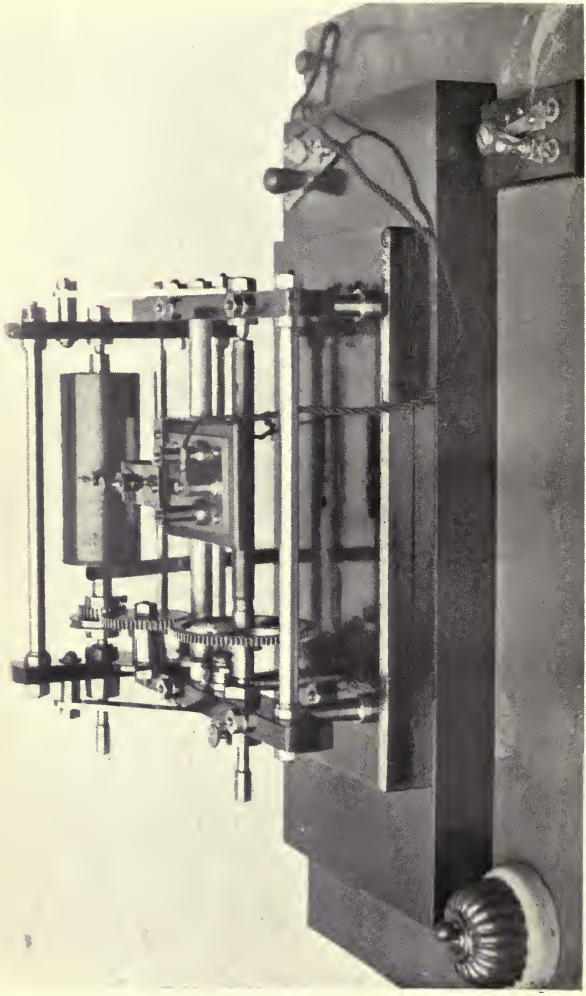

FIG. 10.

WIRELESS TRANSMISSION
OF
PHOTOGRAPHS

BY

MARCUS J. MARTIN

UNIV OF
CALIFORNIA

LONDON

THE WIRELESS PRESS, LTD.

MARCONI HOUSE, STRAND, W.C.

GLASGOW

JAS. BROWN & SON, 52-58 DARNLEY STREET

1916

TK6600
M3

TO VINT
ALBANY

PREFACE

IN these progressive times it is only reasonable to expect that some attempt would be made to utilise the ether-waves for other purposes than that of telegraphic communication, and already many clever minds are at work trying to solve the problems of the wireless control of torpedoes and airships, wireless telephony, and, last but not least, the wireless transmission of photographs.

It may seem rather premature to talk about the wireless transmission of photographs at a time when the ordinary systems are not fully developed; but the prospects of wireless photography are of a very encouraging nature, especially for long over-water distances, as there are great difficulties to be overcome in long-distance transmission over ordinary land lines and cables which will be entirely eliminated by wireless methods.

From a perusal of Chapter I. the reader will be able to understand something of the difficulties that are to be encountered in working over long distances, and he will also be able to appreciate something of the advantages that would be derived

from a reliable wireless system. Apart from the value of such a system for transmitting news pictures, it would also be of great advantage to transmit to ships at sea photographs of criminals for identification purposes. In such a small volume as this it would be impossible to deal with the working of wireless apparatus and the many systems that have been devised for the transmission of photographs over metallic circuits. The Author has taken it for granted that other works have been studied in connection with these subjects, and will therefore only describe such apparatus as is likely to be of use in wireless transmission. At present the transmission of photographs by wireless methods is in a purely experimental stage, and this book will have served its purpose if it helps to put future experimenters on the right track and prevent them from making expensive and fruitless experiments, by showing them the right direction in which investigations are being carried out. As there is no claim to originality in respect of a good many pieces of apparatus, etc., described, I have not thought it necessary to state the various sources from which the information has been obtained.

M. J. M.

CONTENTS

	PAGE
PREFACE	v

CHAPTER I

INTRODUCTORY	1
------------------------	---

Foreword—Early experiments—Advantages of Radio-Photography—Difficulties in Cable working—Bernochi's System—Knudsen's System.

CHAPTER II

TRANSMITTING APPARATUS	13
----------------------------------	----

Wireless Apparatus—Preparing the Photographs—Transmitting Machines—Transmitting Apparatus—Effects of Arcing—Spark-Gaps—Contact Breakers—Complete Station—Professor Korn's Apparatus—Poulsen Company's Photographic Recorder—Comparison of various systems—Practical applications.

CHAPTER III

RECEIVING APPARATUS	37
-------------------------------	----

Methods of Receiving—Author's Photographic Receiver—Decohering Apparatus—Description of Einthoven Galvanometer—Use of Galvanometer in Receiving—Belin's Application of Blondel's Oscillograph—Description of Charbonelle's Receiver—Use of Telephone Relay—Description of Telephone Relay—Telephotographic Receiver—Polarisation Receiver—Kathode-Ray Receiver—Electrolytic Receiver—Atmospherics in Long-Distance working.

CHAPTER IV

SYNCHRONISING AND DRIVING	PAGE 63
-------------------------------------	------------

Driving Motors—Isochronising the Electrolytic System—Professor Korn's method—Description of Hughes Governor—Author's Speed Regulator—Problem of Synchronising—Methods of Synchronising—Advances made in Radio-Photography.

CHAPTER V

THE "TELEPHOGRAPH"	74
------------------------------	----

Author's System of Radio-Photography—Requirements—Advantages—Transmitting machine—Description of Differential Relay—Wireless Receiving Apparatus—Photo-Telegraphic Receiving Apparatus—Circuit Breaker—Friction Brake—Magnetic Clutch—Description of Isochroniser—Method of working.

APPENDIX A

SELENIUM CELLS	99
--------------------------	----

Nature of Selenium—Preparation of Selenium—Forms of Selenium Cells—Action of Selenium Cells—Characteristics of Selenium Cells—Effects of Inertia in Photo-Telegraphy—Methods of counteracting Inertia—Sensitiveness of Selenium to Light—Effect of Heat on Selenium.

APPENDIX B

PREPARING THE METAL PRINTS	105
--------------------------------------	-----

Outline of Process—Line Screens—Choice of Camera—Fixing Line Screen in Camera—Lenses and Stops—Taking the Photograph—Copying Stands—Choice of Photographic Plates—Sources of Illumination—Metal Prints—Coating the Metal Sheets—Sensitising Solution—Printing Operations—Developing—Intensifying—Precautions to be observed in working—Preparing Sketches on Metal.

ILLUSTRATIONS

FIG.	PAGE
1. Diagram showing effects of capacity on an intermittent current	5
2. Bernochi's wireless apparatus	7
3. Knudsen's wireless apparatus	10
4. Wireless transmitting station	13
5. Diagram of experiment illustrating principle of line photograph	16
6. Drawing of transmitting machine	17
7. Drawing of transmitting machine	18
8. Drawing of stylus	18
9. Electrical connections of machine	19
10. Photograph of Author's experimental machine .	<i>Frontispiece</i>
10a. End view of Author's experimental machine	} <i>facing page 21</i>
10b. View of image broken up by a "cross" screen	
11. Connections of complete transmitting apparatus	23
12. Drawing of ordinary type of spark-gap	27
13. Synchronous rotating spark-gap	28
14. Non-synchronous rotating spark-gap	28
15. Connections for complete wireless photographic station .	30
16. Connections of Professor Korn's apparatus	31
17. Connections of Poulsen's photographic recorder	33
18. Author's photographic receiver	38
19. Enlarged drawing of cone	39
20. End view of Author's photographic receiver	39
21. Connections of decohering apparatus	41
22. Connections for complete photographic receiver	42

FIG.	PAGE
23. Arrangement of Einthoven galvanometer	45
24. Einthoven galvanometer arranged for receiving	46
25. Connection of telephone relay	49
26. Drawing of Author's improved photographic receiver	51
27. Diagram giving ratio of vibrating arm	51
28. Arrangement of polarisation receiver	53
29. Arrangement of kathode-ray receiver	54
30. Connections of electrolytic receiver	56
31. Drawing of improved stylus for receiving	58
32. Drawing of Hughes telegraph governor	66
33. Arrangement of simple speed regulator	68
34. Diagram of connections of simple speed regulator	68
35. Author's arrangement for complete radio-photographic station	77
36. Drawing of transmitting machine and circuit breaker	78
37. Drawing of special transmitting stylus showing adjusting arrangements	79
37a. End view of transmitting stylus	79
38. Connections of new type of relay designed by the Author	80
39. Arrangement of mercury containers and dipping rods for relay	82
40. Drawing of Author's receiver	84
41. Enlarged drawing of diaphragm and steel point	84
41a. Drawing showing arrangement of bush and counter-weight	84
42. Optical arrangements of receiver	85
43. Optical arrangements of receiver	86
44. Drawing of circuit breaker	88
45. Drawing of friction brake	89
46. Sectional drawing of magnetic clutch	90
47. Plan of magnetic clutch	90
48. Details of Isochroniser	92
49. Connections of Isochroniser	94
50. Dial of Isochroniser	94
51. Diagram of driving mechanism	96

ILLUSTRATIONS

xi

FIG.	PAGE
52. Diagram showing starting positions of machines . . .	97
53. Connections of selenium cell elements	100
53a. Form of selenium cell used by Bell and Tainter	100
54. Diagram showing construction of modern cell	101
55. Resistance curve of selenium cell	101
55a. Actual curve of selenium cell	102
56. Diagram of Professor Korn's method for counteracting inertia	103
57. Arrangement of plate sheath and line screen	107
58. Details of clips to hold line screen	108
59. Arrangement of apparatus for copying	109
60. Drawing showing method of arranging camera and copying stand for adjustment	109
61. Photograph of line screen and metal print	} <i>facing page</i> 114
62. Photograph of sketch drawn upon metal foil	

RADIO-PHOTOGRAPHY

CHAPTER I

INTRODUCTORY

THOSE who desire to experiment on radio-photography, *i.e.* transmitting photographs, drawings, etc., from one place to another without the aid of artificial conductors, must cultivate at least an elementary knowledge of optics, chemistry, mechanics, and electricity; photo-telegraphy calling for a knowledge of all these sciences. There are, no doubt, many wireless workers who are interested in this subject, but who are deterred from experimenting owing to a lack of knowledge regarding the direction developments are taking, besides which, information on this subject is very difficult to obtain, the science of photo-telegraphy being, at the present time, in a purely experimental stage.

The wireless transmission of photographs has, no doubt, a great commercial value, but for any system to be commercially practicable, it must be simple, rapid, and reliable, besides being able to work

in conjunction with the apparatus already installed for the purpose of ordinary wireless telegraphy.

As far back as 1847 experiments were carried out with a view to solving the problem of transmitting pictures and writing by electrical methods over artificial conductors, but no great incentive was held forth for development owing to lack of possible application ; but owing to the great public demand for illustrated newspapers that has recently sprung into being, a large field has been opened up. During the last ten years, however, development has been very rapid, and some excellent results are now being obtained over a considerable length of line.

The wireless transmission of photographs is, on the other hand, of quite recent growth, the first practicable attempt being made by Mr. Hans Knudsen in 1908. It may seem rather premature to talk about the wireless transmission at a time when the systems for transmitting over ordinary conductors are not perfectly developed, but everything points to the fact that for long-distance transmission a reliable wireless system will prove to be both cheaper and quicker than transmission over ordinary land lines and cables.

The effects of capacity and inductance—properties inherent to all telegraph systems using metallic conductors—have a distinct bearing upon the two questions, how far and how quickly can

photographs be transmitted? Owing to the small currents received and to prevent interference from earth currents it is necessary to use a complete metallic circuit. If an overhead line could be employed no difficulty would be experienced in working a distance of over 1000 miles, but a line of this length is impossible—at least in this country—and if transmission is attempted with any other country, a certain amount of submarine cable is essential. It has been found that the electrostatic capacity of one mile of submarine cable is equal to the capacity of 20 miles of overhead line, and as the effect of capacity is to retard the current and reduce the speed of working, it is evident that where there is any great length of cable in the circuit the distance of possible transmission is enormously reduced.

If we take for an example the London-Paris telephone line with a length of 311 miles and a capacity of 10.62 microfarads, we find that about half this capacity, or 5.9 microfarads,¹ is contributed by the 23 miles of cable connecting England with France.

In practice the reduction of speed due to capacity has, to a great extent, been overcome by means of apparatus known as a line-balancer, which hastens the slow discharge of the line and

¹ These measurements only apply to a single line. Where a double line is employed the capacity is halved.

allows each current sent out from the transmitter—the current in several systems being intermittent—to be recorded separately on the receiver. Photographs suitable for press work can now be sent over a line which includes only a short length of cable for a distance of quite 400 miles in about ten minutes, the time, of course, depending upon the size of the photograph. In extending the working to other countries where there is need for a great length of cable, as between England and Ireland, or America, the retardation due to capacity is very great. On a cable joining this country with America the current is retarded four-tenths of a second. In submarine telegraphy use is made of only one cable with an earth return, but special means have had to be adopted to overcome interference from earth currents, as the enormous cost prohibits the laying of a second cable to provide a complete metallic circuit. The current available at the cable ends for receiving is very small, being only $\frac{1}{200000}$ th part of an ampere, and this necessitates the use of apparatus of a very sensitive character. One system of photo-telegraphy in use at the present time, employs what is known as an electrolytic receiver (see Chapter III.) which can record signals over a length of line in which the capacity effects are very slight, with the marvellous speed of 12,000 a minute, but this speed rapidly decreases with an increase of distance between the

two stations. The effect of capacity upon an intermittent current is clearly shown in Fig. 1. If we were to send twenty brief currents in rapid succession over a line of moderate capacity in a given time, we should find that instead of being recorded separately and distinctly as at *a*, each mark would be pointed at both ends and joined together as shown at *b*, while only perhaps fifteen could be recorded. If the capacity be still farther increased as at *c*, only perhaps half the original



FIG. 1.

number of currents could be recorded in the same time, owing to the fact that with an increase of resistance, capacity, and inductance of the line a longer time is required for it to charge up and discharge, thereby materially lessening the rate at which it will allow separate signals to pass; the number of signals that can therefore be recorded in a given time is greatly diminished. If we were to attempt to send the same number of signals over a line of great capacity, as could be sent, and recorded separately and distinctly over a line of small capacity—the time limit being of course the same in both instances—we should find that the

signals would be recorded practically as a continuous line. The two latter cases *b*, and *c*, Fig. 1, clearly shows the retardation that takes place at the commencement of a current and the prolongation that takes place at the finish. If the photo-telegraphic system previously mentioned could be rendered sensitive enough to work on the Atlantic cables, we should find that only about 1200 signals a minute could be recorded, and this would mean that a photograph which could be transmitted over ordinary land lines in about ten minutes would take at least fifty minutes over the cable. This would be both costly and impracticable, and time alone will show whether, for long-distance work, transmission by wireless will be both cheaper and more rapid than any other method. At present wireless telegraphy has not superseded the ordinary methods of communicating over land, but there can be no doubt that wireless telegraphy, if free from Government restrictions, would in certain circumstances very quickly supersede land-line telegraphy, while it has proved a formidable commercial competitor to the cable as a means of connecting this country with America. Likewise we cannot say that no system of radiophotography will ever come into general use, but where there is any great distance to be bridged, especially over water, wireless transmission is really the only practical solution. From the fore-

going remarks, it is evident that a reliable system of radio-photography would secure a great victory in the matter of time and cost alone, besides which, the photo-telegraphic apparatus would be merely an accessory to the already existing wireless installation.

There have been numerous suggestions put forward for the wireless transmission of photographs,

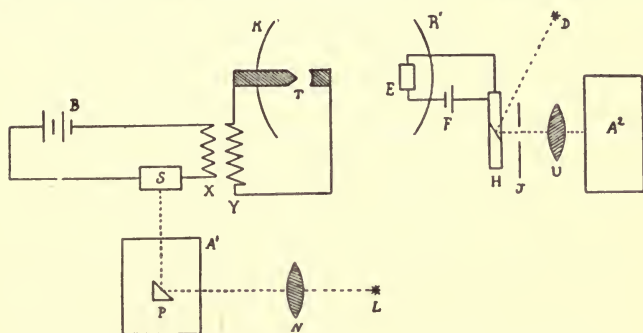

FIG. 2.

but they are all more or less impracticable. One of the earliest systems was devised by de' Bernochi of Turin, but his system can only be regarded interesting from an historical point of view, and as in all probability it could only have been made to work over a distance of a few hundred yards it is of no practical value. Fig. 2 will help to explain the apparatus. A glass cylinder A' is fastened at one end to a threaded steel shaft, which runs in two bearings, one bearing having an internal thread corresponding with that on the

shaft. Round the cylinder is wrapped a transparent film upon which a photograph has been taken and developed. Light from a powerful electric lamp L, is focussed by means of the lens, N, to a point upon the photographic film. As the cylinder is revolved by means of a suitable motor, it travels upwards simultaneously by reason of the threaded shaft and bearing, so that the spot of light traces a complete spiral over the surface of the film. The light, on passing through the film (the transmission of which varies in intensity according to the density of that portion of the photograph through which it is passing), is refracted by the prism P on to the selenium cell S which is in series with a battery B and the primary X of a form of induction coil. As light of different intensities falls upon the selenium cell,¹ the resistance of which alters in proportion, current is induced in the secondary Y of the coil and influences the light of an arc lamp of whose circuit it is shunted. This arc lamp T is placed at the focus of a parabolic reflector R, from which the light is reflected in a parallel beam to the receiving station.

The receiver consists of a similar reflector R' with a selenium cell E placed at its focus, whose resistance is altered by the varying light falling upon it from the reflector R. The selenium cell

¹ See Appendix A.

E is in series with a battery F and the mirror galvanometer H. Light falls from a lamp D and is reflected by the mirror of the galvanometer on to a graduated aperture J and focussed by means of the aplanatic lens U upon the receiving drum A², which carries a sensitised photographic film. The two cylinders must be revolved synchronously. The above apparatus is very clever, but cannot be made to work over a distance of more than 200 yards.

A system based on more practical lines was that invented and demonstrated by Mr. Hans Knudsen, but the apparatus which he employed for receiving has been discarded in wireless work, as it is not suitable for working with the highly-tuned systems in use at the present time.

Knudsen's transmitter, a diagrammatic representation of which is given in Fig. 3, consists of a flat table to which a horizontal to-and-fro motion is given by means of a clockwork motor. Upon this table is fastened a photographic plate which has been prepared in the following manner. The plate upon which the photograph is to be taken has the gelatine film from three to four times thicker than that commonly used in photography. In the camera, between the lens and this plate, a single line screen is interposed, which has the effect of breaking the picture up into parallel lines. Upon the plate being developed and before it is

completely dry, it is sprinkled over with fine iron dust. With this type of plate the transparent parts dry much quicker than the shaded or dark parts, and on the iron dust being sprinkled over the plate it adheres to the darker portions of the film to a greater extent than it does to the lighter portions; a picture partly composed of iron dust

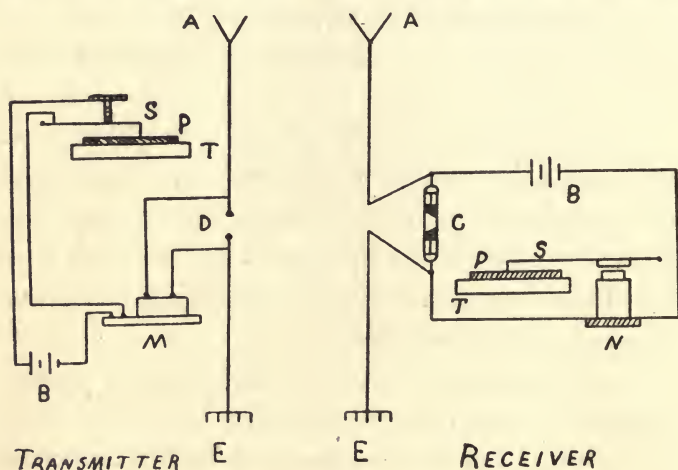

FIG. 3.

A, aerial; B, batteries; C, coherer; E, earth; D, spark-gap; M, spark-coil; N, magnet; P, plates; S, springs; T, tables.

is thus obtained. A steel point attached to a flat spring rests upon this plate and is made to travel at right-angles to the motion of the table. As the picture is partly composed of iron dust, and as the steel needle is fastened to a delicate spring it is evident that as the plate passes to and fro under the needle, both the spring and needle are set in a state of vibration. This vibrating spring makes

and breaks the battery circuit of a spark coil, which in turn sets up sparking in the spark-gap of the wireless apparatus.

The receiver consists of a similar table to that used for transmitting, and carries a glass plate that has been smoked upon one side. A similar spring and needle is placed over this plate, but is actuated by means of a small electro-magnet in circuit with a battery and a sensitive coherer. As the coherer makes and breaks the battery circuit by means of the intermittent waves sent out from the transmitting aerial, the needle is made to vibrate upon the smoked glass plate in unison with the needle at the transmitting end. Scratches are made upon the smoked plate, and these reproduce the picture on the original plate. A print can be taken from this scratched plate in a similar manner to an ordinary photographic negative.

The two tables are synchronised in the following manner. Every time the transmitting table is about to start its forward stroke a powerful spark is produced at the spark-gap. The waves set up by this spark operate an ordinary metal filings coherer at the receiving end which completes the circuit of an electro-magnet. The armature of this magnet on being attracted immediately releases the motor used for driving, allowing it to operate the table. The time taken to transmit a photograph, quarter-plate size, is about fifteen minutes.

Although very ingenious this system would not be practicable, as besides speed the quality of the received pictures is a great factor, especially where they are required for reproduction purposes. The results from the above apparatus are said to be very crude, as with the method used to prepare the photographs no very small detail could be transmitted.

CHAPTER II

TRANSMITTING APPARATUS

LET us now consider the requirements necessary for transmitting photographs by means of the wireless apparatus in use at the present time.

The connections for an experimental syntonic wireless transmitting station are shown in the diagram Fig. 4. A is the aerial; T, the inductance; E, earth; L, hot-wire ammeter. The closed oscillatory circuit consists of an inductance F, spark-gap G, and a block condenser C.

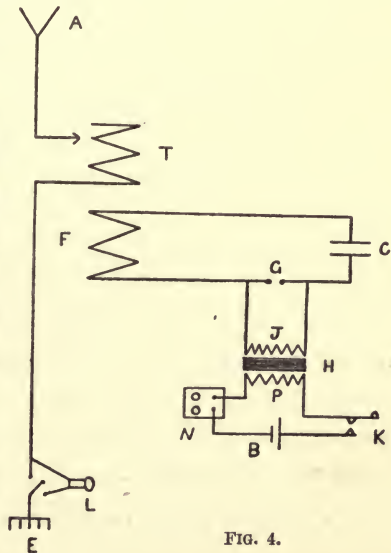

FIG. 4.

H is a spark-coil for supplying the energy, the secondary J being connected to the spark-gap. A

mercury break N and a battery B are placed in the primary circuit of the coil. The Morse key K is for completing the battery circuit for signalling purposes. When the key K is depressed, the battery circuit is completed, and a spark passes between the balls of the spark-gap G producing oscillations in the closed circuit, which are transposed to the aerial circuit by induction. For signalling purposes it is only necessary for the operator by means of the key K to send out a long or short train of waves in some pre-arranged order, to enable the operator at the receiving station to understand the message that is being transmitted.

If a photograph could be prepared in such a manner that it would serve the purpose of the key K, and could so arrange matters that a minute portion of the photograph could be transmitted separately but in succession, and that each portion of the photograph having the same density could be given the same signal, then it would only be necessary to have apparatus at the receiving station capable of arranging the signals in proper sequence (each signal recorded being the same size and having the same density as the transmitted portion of the photograph) in order to receive a facsimile of the picture transmitted.

The following method of preparing the photograph¹ is one that has been adopted in several

¹ See Appendix B.

systems of photo-telegraphy, and is the only one at all suitable for wireless transmission. The photograph or picture which is to be transmitted is fastened out perfectly flat upon a copying-board. A strong light is placed on either side of this copying board, and is concentrated upon the picture by means of reflectors. The camera which is used for copying has a single line screen interposed between the lens and sensitised plate, and the effect of this screen is to break the picture up into parallel lines. Thus a white portion of the photograph would consist of very narrow lines wide apart, while the dark portion would be made up of wide lines close together; a black part would appear solid and show no lines at all. From this line negative it will be necessary to take off a print upon a specially prepared sheet of metal. This consists of a sheet of thick lead- or tinfoil, coated upon one side with a thin film of glue to which bichromate of potash has been added; the bichromate possessing the property of rendering the glue waterproof when acted upon by light. The print can be taken off by artificial light (arc lamps being generally used), but the exact time to allow for printing can only be found by experiment, as it varies considerably according to the thickness of the film. The printing finished, the metal print is washed under running water, when all those parts not acted upon by light, *i.e.* the parts between the lines, are

washed away, leaving the bare metal. We have now an image composed of numerous bands of insulating material (each band varying in width according to the density of the photograph at any point from which it is prepared) attached to a metal base, so that each band of insulating material is separated by a band of conducting material. It is, of course, obvious that the lines on the print cannot be wider apart, centre to centre, than the lines of the screen used in preparing it. A good screen to use is one having 50 lines to the inch, but one is perhaps more suitable for experimental work a little coarser, say 35 lines to the inch. To use a screen having 50 or more lines to the inch, the transmitting apparatus, as will be evident later on, will require to be very nearly perfect.

Before proceeding further it will perhaps be as well to make an experiment. If we take one of

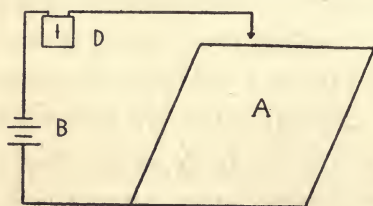

FIG. 5.

the metal prints or, more simple, draw a sketch in insulating ink upon a sheet of metal A, Fig. 5, and connect a battery B and the galvanometer

D as shown, we shall find on drawing the free end of the wire across the metal plate that all the time the wire is in contact with the lines of insulating material the needle of the galvanometer will remain

at zero, but where it is in contact with the metal plate the needle is deflected.

From this experiment it will be seen that we have in our metal line print, which consists of alternate lines of insulating and conducting material, a method by which an electric circuit can be very easily made and broken. It is, of course, necessary to have some arrangement whereby the whole of the surface of the metal print is utilised for this purpose to the best advantage. One type of transmitting machine used for this

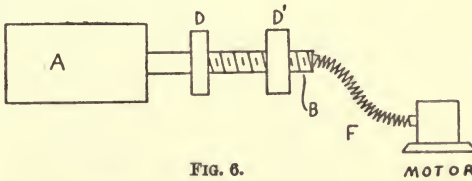

FIG. 6.

purpose is represented by the diagram, Fig. 6. The cylinder A is fastened to the steel shaft B, which runs in the two bearings D and D', the bearing D' having an internal thread corresponding to that on the shaft. The stylus in this class of machine is a fixture, the cylinder being given a lateral as well as a revolving movement. As it is impossible to use a rigid drive, a flexible coupling F is employed between the shaft B and the motor.

Another type of machine is shown in Fig. 7. The drum in this case is stationary, the table T moving laterally by reason of the screwed shaft

and half nut F. The table, shown separate in Fig. 8, carries a stiff brass spring A, to which is attached a holder B made to take a hardened steel point. The holder is provided with a set screw P for securing the steel point Z. The spring

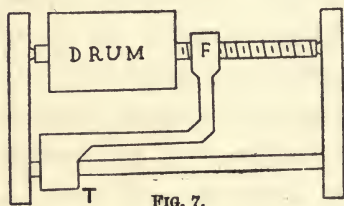

FIG. 7.

and needle are insulated from the rest of the machine, as shown in the drawing. In working, the metal print is wrapped tightly round the cylinder

of the machine, the glue image being, of course, uppermost. To fasten the print a little seccotine should be applied to one edge, and the joint carefully smoothed down with the fingers. If there is any tendency on the part of the print to slip round on the drum, a couple of small spring clips placed over the ends of the drum will act as a pre-

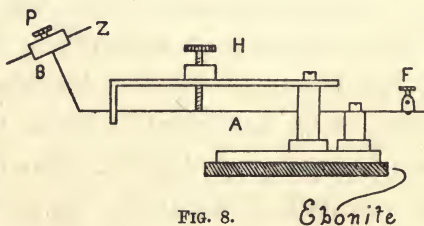

FIG. 8.

Ebonyte

ventive. It is necessary to place the print upon the drum in such a manner that the stylus draws away from the edge of the lap and not towards it, and the metal prints should be of such a size that when placed round the drum of the

machine a lap of about $\frac{3}{16}$ ths of an inch is allowed.

The steel point Z (ordinary gramophone needles may be used and will be found to answer the purpose admirably) is made to press lightly upon the metal print, and while the pressure should be sufficient to make good electrical contact, it should not be sufficient to cause the needle to scratch the surface of the foil. The pressure is regulated by means of the milled nut H. The electrical connections are given in Fig. 9. One wire from the battery M is taken to the terminal T, and the other wires from M and F lead to the relay R.

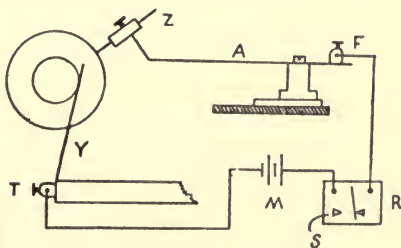

FIG. 9.

The current flows from the battery M through the spring Y, through the drum and metal print, the stylus Z, spring A, down to the relay R, and from R back to the battery M. As the drum carrying the single line half-tone print is revolved, the stylus, by reason of the lateral movement given to the table or cylinder as the case may be, will trace a spiral path over the entire surface of the print. As the stylus traces over a conducting strip the circuit is completed, and the tongue of the relay R is attracted, making contact with the stop S.

On passing over a strip of insulation the circuit is broken and the tongue of the relay R returns to its normal position.

As already stated, the conducting and insulating bands on the print vary in width according to the density of the photograph from which it is prepared, so that the length of time that the tongue of the relay R is held against the stop S, is in proportion to the width of the conducting strip which is passing under the stylus at any instant. The function of the transmitter is therefore to send to the relay R an intermittent current of varying duration.

The two photographs Figs. 10 and 10a are of a machine designed and used by the writer in his experiments. In this machine the drum is 3.5 inches long and 1.5 inches in diameter. The lead screw has 30 threads to the inch, and the reduction between it and the drum is 3 : 1, so that the table has a movement of $\frac{1}{30}$ th inch per revolution of the drum.

From the brief description of the various types of machines that have been given it will be apparent that in the design of the machine proper there is nothing very complicated, although the addition of the driving and synchronising apparatus complicates matters rather considerably. The questions of driving and synchronising the machines at the two stations is fully dealt with in Chapter IV.

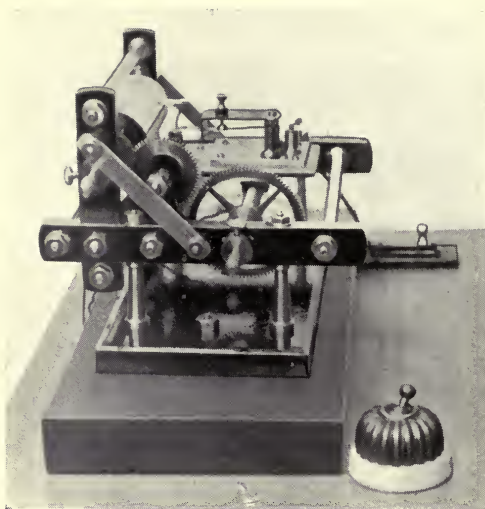

FIG. 10a

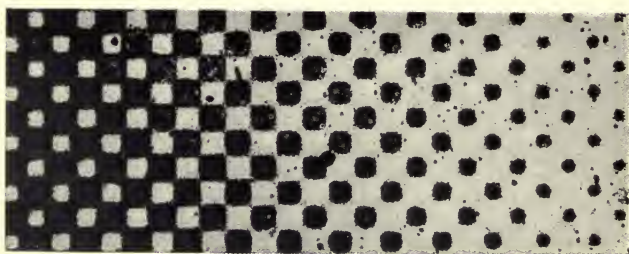

FIG. 10b.

Enlarged view of an image broken up by a "cross" screen.

Although the design of the machines is rather simple great attention must be paid both to accuracy of construction and accuracy of working, and this applies, not only to the machines (whether for transmitting or receiving) but for all the various pieces of apparatus that are used. Too much care cannot be bestowed upon this point, as in the wireless transmission of photographs there is a large number of instruments all requiring careful adjustment, and which have to work together in perfect unison at a high speed.

The machine shown in Figs. 10 and 10a was designed and used by the writer solely for experimental work. It will be noticed in the description given in the appendix of the method of preparing the metal prints that a 5" x 4" camera is recommended, while the machine, Fig. 10, is designed to take a print procured from a quarter-plate negative. This size of drum was adopted for several reasons, and although it will be found quite large enough for general experimental work the writer has come to the conclusion that for practical commercial work a drum to take a print 5" x 4" will give better results.

In making a negative of a picture that is required for reproduction purposes, the line screen in the camera is replaced by a "cross screen," *i.e.* two single line screens placed with their lines at an angle of 90° to one another, and this breaks the

image up into small squares instead of lines. By looking at any ordinary newspaper or book illustration through a powerful magnifying glass the effects of a cross screen will readily be seen. With a cross screen a certain amount of detail is necessarily lost, but with a single line screen the amount lost is much greater. If there is any very small detail in the picture most of this would be lost in a coarse screen, hence the necessity of employing as fine a line screen as practicable in order to get as much detail in as possible. It is mainly on this account that a 5" x 4" print is recommended, as, if fairly bold subjects are used for copying, the small detail (this is, of course, a very vague and indefinable term) will not be too fine, and the time required for transmitting reasonable. For obvious reasons it is a great advantage to put the print under pressure to cause the glue image to sink into the soft metal base and leave a perfectly flat and smooth surface. It is essential that the bands on the print lie along the axis of the cylinder, so that the stylus traces its path across them, and not with them.

We have now an arrangement that is capable of taking the place of the key K, Fig. 4, and the diagram, Fig. 11, gives the connections for the complete transmitter. A is the aerial, E earth, T inductance, L ammeter. The closed oscillatory circuit consists of a spark-gap G, inductance F,

and a condenser C. The secondary J of the coil H is connected to the spark-gap, and the primary P is in circuit with the mercury break N, the battery B, and the local contacts of the relay R. The action is as follows. When contact is made between the stylus Z and the drum V by means of the conducting bands on the line print, the

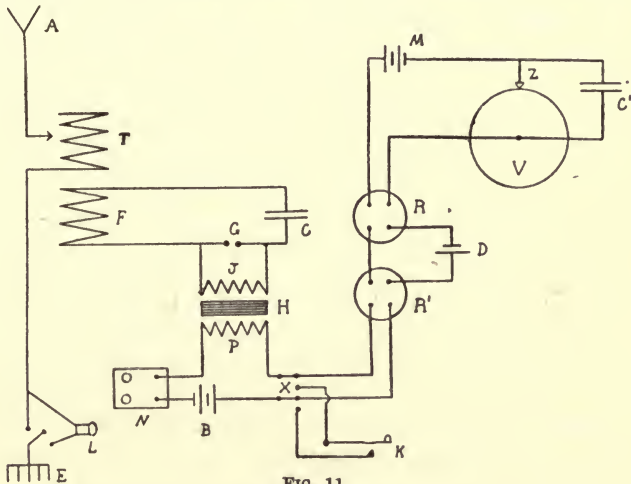

FIG. 11.

circuit of the relay R and the battery M is completed. The closing of the local circuit of the relay R actuates the second relay R', allowing the primary circuit of the coil H to be closed. As soon as the primary circuit of the coil is completed sparks pass between the electrodes of the spark-gap G, causing waves to radiate from the aerial. The duration of the wave-trains radiated depends upon the duration of contact made by the relays

R and R', and this in turn depends upon the width of the conducting strip that is passing under the stylus. The battery M should be about 4 volts, and the battery D about 2 volts. The two-way switch X is connected up so that the relay R' can be thrown out and the key K switched in for ordinary signalling purposes. If any sparking takes place at the point of the stylus, a small condenser C' (about 1 microfarad capacity) should be connected as shown. In the present instance the condenser should be used more as a preventive than as a cure, as in all probability the voltage from M will not be sufficient to cause destructive (if any) sparking; but, as most wireless workers know, anything in the nature of a spark occurring in the neighbourhood of a detector (this, of course, only applies when the receiving apparatus is placed in close proximity to the transmitter) is liable to destroy the adjustment.

In transmitting over ordinary conductors where the initial voltage is fairly high and the self-induction of the circuit very great, the use of the condenser will be found to be absolutely essential. It has also been noted that the angle which the stylus presents to the drum has a marked effect upon the sparking, an angle of about 60° being found to give very good results.

If the size of the single line print used is 5 inches by 4 inches, and a screen having 50 lines

to the inch is used for preparing it, then the stylus will have to make 250 contacts during one revolution of the drum. Assuming the drum to make one revolution in three seconds, then the time taken to transmit the complete photograph can be found from the equation $T = w \times t \times s$, where w is the width of the print, t the travel of the stylus during one revolution of the drum, and s the time required for one revolution of the drum. In the present instance this will be $T = 4 \times 90 \times 3 = 1080$ seconds = 18 minutes. The number of contacts made by the stylus per minute is 5000, and in working at this speed the first difficulty is encountered in the use of the two relays. The relay R is lightly built, and capable of working at a fairly high speed, but R' is a heavier pattern, and consequently works at a slightly lower rate. This relay must necessarily be heavier, as more substantial contacts are needed in order to pass the heavy current taken by the spark-coil.

Relays sensitive and accurate enough to work at this speed will in all probability be beyond the reach of the majority of workers, but there are several types of relays on the market very reasonable in price that will answer very well for experimental work, although the speed of working will no doubt be slower.

For the best results the duration of the wave-trains sent out should be of the same duration as

the contact made by R, and therefore equal to the time taken by the stylus to trace over a conducting strip; but if the duration of the contact made by R is t , then that made by R' and consequently the duration of the groups of wave-trains would be $t - v$ where v equals the extra time required by R' to complete its local circuit. The difference in time made by the two relays, although very slight, will be found to affect very considerably the quality of the received pictures. Renewing the platinum contacts is also a great expense, as they are soon burnt out where a heavy current is passed. If the distance experimented over is short so that the power required to operate the spark-coil is not very heavy, one relay will be sufficient providing the contacts are massive enough to carry the current safely. It is useless to expect any of the ordinary relays in general use to work satisfactorily at such a high speed, and in order to compensate for this we must either increase the time of transmitting, or, as already suggested, make use of a coarser line screen in preparing the photographs.

For reasons already explained, all points of make and break should be shunted by a condenser. The effective working speed of an ordinary type of relay may be anything from 1000 to 2500 dots a minute, depending upon accuracy of design and construction.

In the wireless transmission of photographs it

is absolutely essential to use some form of rotary spark-gap, as where sparks are passed in rapid succession the ordinary type of gap is worse than useless. When a spark passes between the electrodes of an ordinary spark-gap, Fig. 12, we find that for a fraction of a second after the first spark has passed, the normally high resistance of the gap has

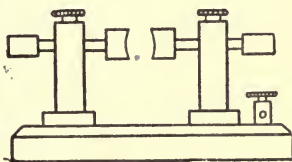

FIG. 12.

been lowered to less than one ohm. If the column of hot gas which constitutes the spark is not instantly dispersed, but remains between the electrodes, it will provide an easy path for any further discharges, and if sparks are passed at all rapidly, what was at first a disruptive and oscillatory discharge will degenerate into a hot, non-oscillatory arc.¹

Two forms of rotating spark-gaps are shown in Figs. 13 and 14, and are known as "synchronous" and "non-synchronous" gaps respectively. In the synchronous gap the cog-wheel is mounted on the shaft of the alternator, and a cog comes opposite the fixed electrode when the maximum of potential is reached in the condenser, thus ensuring a discharge at every alternation of current. With this type of gap a spark of pure tone is obtained which

¹ In wireless telegraphy "arcing" is principally caused by the continuation of the supply current in the spark-gap after the capacity has been charged to a potential sufficient to break down the insulation of the gap.

is of great value where the signals are received by means of a telephone, but where the signals are to be mechanically recorded the tone of the spark is

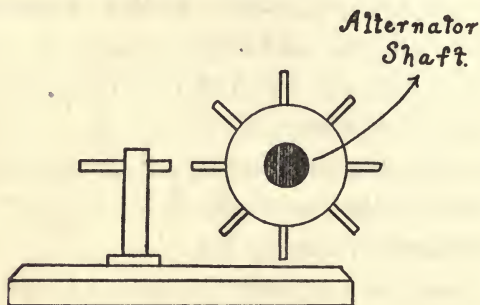

FIG. 13.

of little consequence. In a non-synchronous gap a separate motor is used for driving the toothed wheel, and can either be mounted on the motor shaft or driven by means of a band, there being no

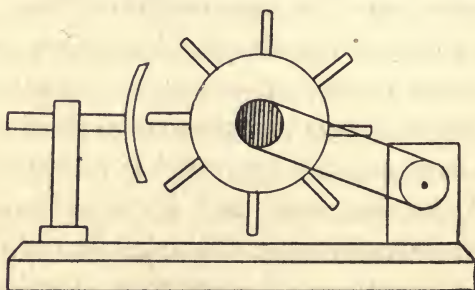

FIG. 14.

regard given to synchronism with the alternator. The fixed electrode is best made long enough to cover about two of the teeth, as this ensures regular sparking and a uniform sparking distance; the

spark length is double the length of the spark-gap. The toothed wheel should revolve at a high speed, anything from 5000 to 8000 revolutions per minute, or even more being required. The shaft of the toothed wheel is preferably mounted in ball-bearings.

Owing to the large number of sparks that are required per minute in order to transmit a photograph at even an ordinary speed, it is necessary that the contact breaker be capable of working at a very high speed indeed. The best break to use is what is known as a "mercury jet" interrupter, the frequency of the interruptions being in some cases as high as 70,000 per second. No description of these breaks will be given, as the working of them is generally well understood.

In some cases an alternator is used in place of the battery B, Fig. 4, and when this is done the break M can be dispensed with. In larger stations the coil H is replaced with a special transformer.

The writer has designed an improved relay which will respond to currents lasting only $\frac{1}{100}$ th part of a second, and capable of dealing with rather large currents in the local circuit.¹ This relay has not yet been tried, but if it is successful the two relays R and R' can be dispensed with, and the result will be more accurate and effective transmission.

¹ See Chapter V.

The connections for a complete experimental station, transmitting and receiving apparatus combined, are given in Fig. 15. The terminals W, W are for connecting to the photo-telegraphic receiving apparatus Q, being a double pole two-way switch for throwing either the transmitting or receiving apparatus in circuit. There is another system

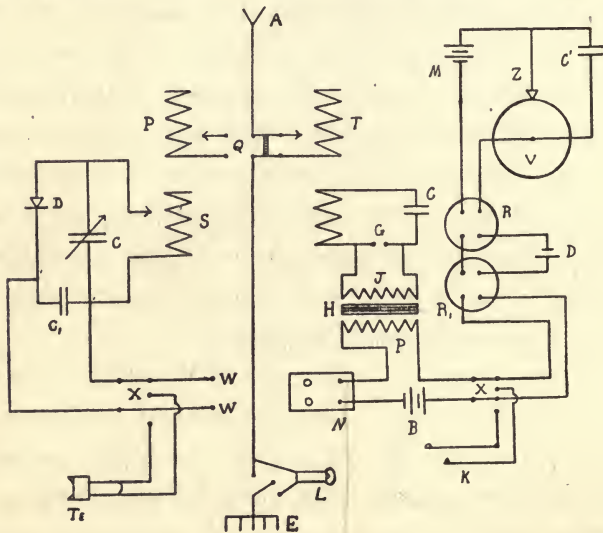

FIG. 15.

of transmitting devised by Professor Korn, which employs an entirely different method from the foregoing. By using the apparatus just described, the waves generated are what are known as "damped waves," and by using these damped waves, tuning, which is so essential to good commercial working, can be made to reach a fairly high degree of efficiency.

The question of damped *versus* undamped waves is a somewhat burning one, and no attempt will be made here to deal with the merits or demerits of the claims made for the respective systems. A series of articles describing the production of undamped waves and their efficiency in working compared with damped waves will be found in the *Wireless World*, Nos. 3 and 4, 1913,

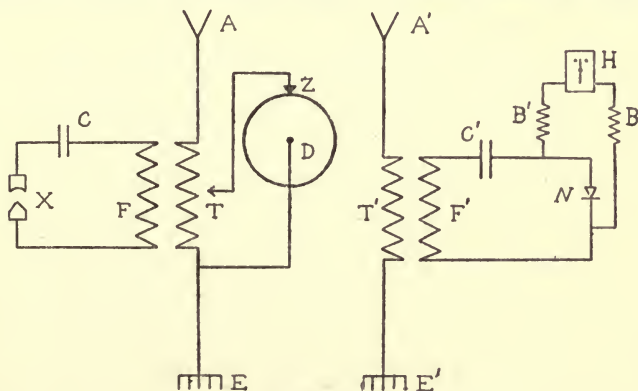

FIG. 16.

and are well worth reading by any one interested in the subject.

A diagrammatic representation of the apparatus as arranged by Professor Korn is given in Fig. 16. The undamped or "continuous" waves are generated by means of a high-frequency alternator or Poulsen arc. In Fig. 16, X is the generator, F inductance, C condenser; the aerial inductance T is connected by the aerial A and earth E. By this means the waves are tuned to a certain period.

A metal print, similar to what has already been described, is wrapped round the drum D of the machine, and when the stylus Z traces over an insulating strip the waves generated are in tune with the receiving station, but when it traces over a conducting strip, a portion of the inductance T is short-circuited, the period of the oscillations is altered, and the two stations are thrown out of tune.

The receiving station is provided with an aperiodic circuit, which consists of an inductance F', condenser C', and a thermodetector N. A string galvanometer H (described in Chapter III.), and the self-induction coils B, B' are connected as shown, the coils B, B' preventing the high-frequency currents, which change their direction, from flowing through the galvanometer. The manner in which the string galvanometer is arranged to reproduce a transmitted picture is shown in Fig. 24.

The connections adopted by the Poulsen Company for photographically recording wireless messages are given in Fig. 17, a string galvanometer of the Einthoven type being used. The two self-induction coils S and S' are in circuit with the detector D and the galvanometer G. The condenser C' prevents the continuous current produced by the detector from flowing through the high frequency circuit; P is the primary of the aerial

inductance and F the secondary. The method of transmitting adopted by Professor Korn appears to be a simple and reliable arrangement, provided that an equally reliable method of producing the undamped waves can be found. Owing to the absence of mechanical inertia it should be capable of working at a good speed, while the absence of a number of pieces of delicate apparatus all

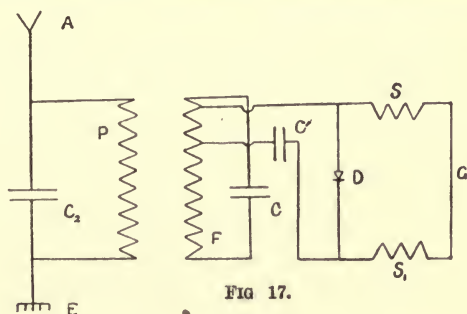

FIG 17.

requiring careful adjustment add greatly to its reliability.

In any spark system with a properly designed aerial a coil taking ten amperes is capable of transmitting signals over a distance of thirty to fifty miles, but where the number of interruptions of the break required per second is very high, as in radio-photography, it must be remembered that a much higher voltage is needed to drive the requisite amount of current through the primary winding of the coil than would be the case if the interruptions were slower. It is possible to use platinum

contacts for the relays, for currents up to ten amperes, but for heavier currents than this some arrangement where contact is made with mercury will be found to be more economical and reliable.

In the transmitter already described and given in Fig. 11, the best results would be obtained by finding the speed at which the relay R' works best, and regulating the number of contacts made by the stylus accordingly.

The method employed by De' Bernochi (see Chapter I.) of varying the intensity of a beam of light by passing it through a photographic film, which in turn alters the resistance of a selenium cell, has been very successfully employed in at least one system of photo-telegraphy. Its application has also been suggested for wireless transmission, and although with any system using continuous waves this would not be very difficult, it could hardly be adapted to work with the ordinary spark system. The apparatus for receiving from this type of transmitter would, on the other hand, necessarily be more elaborate than the methods that are described in the next chapter, and as far as the writer's experience goes, experiments along these lines would not prove very profitable, as simplicity is the keynote of success in any radio-photographic system.

It has been suggested that in order to decrease the time of transmission a cylinder capable of

taking a print 7 inches by 5 inches be employed, the print being prepared from rather a coarse line screen—say 35 to the inch—and a traverse of about $\frac{1}{50}$ inch given to the stylus, thus reducing the time of transmission to about twelve minutes. It is questionable, however, whether the increase in speed would compensate for the loss of detail, as only very bold subjects could be transmitted. As already pointed out, wireless transmission would only be employed for fairly long distances, and the extra time and expense required to receive a fairly good detailed picture is negligible when compared with the enormous time it would take to receive the original photograph by any ordinary means of transit.

The public much prefer to have passable pictorial illustrations of current events than wait several days for a more perfect picture—the original, and the advantage of any newspaper being able to publish photographs several days before its rivals is obvious. There can also be no doubt but that a system of radio-photography, if fairly reliable and capable of working over a distance of say thirty miles, would be of great military use for transmitting maps and written matter with a great saving of time and even life. Written matter could be transmitted with even greater safety than messages which are sent in the ordinary way in Morse Code, as the signals received in the receiver

of an hostile installation would be but a meaningless jumble of sounds, and even were they possessed of radio-photographic apparatus the received message would be unintelligible, unless they knew the exact speed at which the machines were running and could synchronise accurately.

CHAPTER III

RECEIVING APPARATUS

THERE are only two methods available at present for receiving the photographs, and both have been used in ordinary photo-telegraphic work with great success. They have disadvantages when applied to wireless work, however, but these will no doubt be overcome with future improvements. The two methods are (1) by means of an ordinary photographic process, and (2) by means of an electrolytic receiver.

In several photo-telegraphic systems the machine used for transmitting has the cylinder twice the size of the receiving cylinder, thus making the area of the received picture one-quarter the area of the picture transmitted. The extra quality of the received picture does not compensate for the disadvantage of having to provide two machines at each station, and in the writer's opinion results, quite good enough for all practical purposes, can be obtained by using a moderate size cylinder so that one machine answers for both transmitting

and receiving, and using as fine a line screen as possible for preparing the photographs.

The writer, when first experimenting in photo-telegraphy, endeavoured to make the receiving apparatus "self-contained," and one idea which was worked out is given in Fig. 18. The electric lamp L is about 8 c.p., and is placed just within the focus of a lens which has a focal length of $\frac{3}{4}$ inch. When a source of light is placed at some

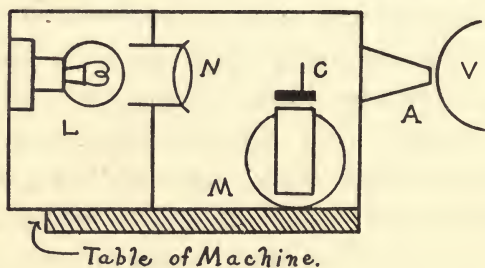

FIG. 18.

point between a lens and its principal focus, the light rays are not converged, but are transmitted in a parallel beam the same size as the lens. It has been found that this arrangement gives a sharper line on the drum than would be the case were the light focussed direct upon the hole in the cone A. An enlarged drawing of the cone is given in Fig. 19. The hole in the tip of the cone A is a bare $\frac{1}{30}$ inch in diameter—the size of this hole depends upon the travel per revolution of the drum or table of the machine used—and in working, the cone is run as close as possible to the

drum without being in actual contact. The magnet M is wound full with No. 40 S.C.C. wire, and the armature is made as light as possible. The spring to which the armature is attached should be of such a length that its natural period of vibration is equal to the number of contacts made by the transmitting stylus. The spring must be stiff enough

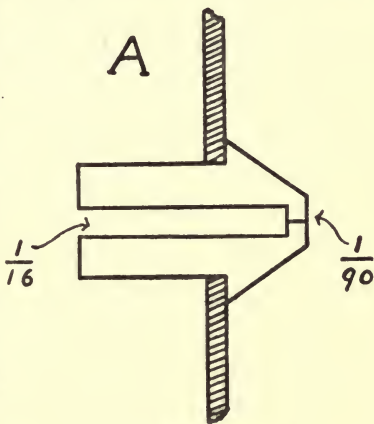

FIG. 19.

to bring the armature back with a fairly crisp movement. The spring and armature is shown separate in Fig. 20.

The shutter C is about $\frac{1}{4}$ inch square and made from thin aluminium. The hole in the centre is $\frac{1}{16} \times \frac{1}{8}$ inch, and the movement of the armature is limited to about $\frac{3}{32}$ inch. In all arrangements of this kind there is a tendency for the armature spring to vibrate, as it were, sinusoidally, if the coil is mag-

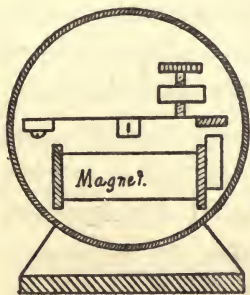

FIG. 20.

netised and demagnetised at a higher rate than the natural period of vibration of the spring.

This causes an irregularity in the rate of the vibrations which affects the received image very considerably. A photographic film is wrapped round the drum of the machine, being fastened by means of a little celluloid cement smeared along one edge.

This device, although it will work well over artificial conductors, is not suitable for wireless work, as it is too coarse in its action; it can be made sensitive enough to work at a speed of 1000 to 1500 contacts per minute, with a current of .5 milliampere. It is impossible to obtain a current of this magnitude from the majority of the detectors in use, so that if any attempt is made to use this device for radio-photography it will be necessary to employ a Marconi coherer (filings), as this is practically the only coherer from which so large a current can be obtained.

There have been many attempts made to receive with an ordinary filings coherer, but as was pointed out in Chapter I. these have now been discarded in serious wireless work, being only used in small amateur stations or experimental sets. As the reasons for this are well known to the majority of wireless workers there is no need to enumerate them here.

A method whereby a filings coherer can be decohered, the act of decohering closing a local circuit which contains the photographic

receiving apparatus, is given in the diagram Fig. 21.

In the figure, the coherer C is fixed in rigid supports, one support being provided with a platinum pin F. To the coherer is connected the sensitive electro-magnet M, which becomes magnetised as soon as the incoming waves act upon

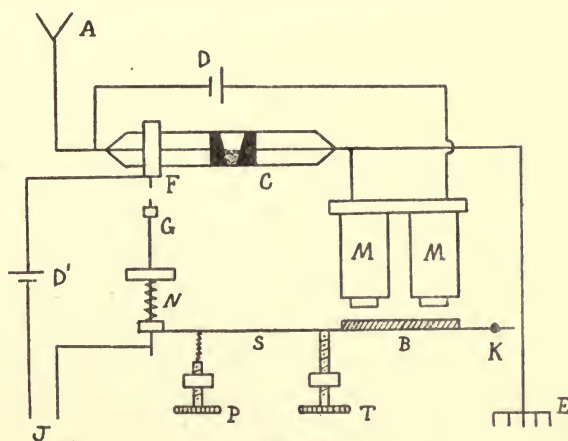

FIG. 21.

the coherer. To the armature B is attached a light aluminium arm S, pivoted at K, and carrying at the other end the striker G, which is fitted with a platinum contact. When the armature B is attracted the coherer is decohered by the force of the impact between the contacts F and G. To prevent damage to the coherer the force of the blow is taken off by the ability of the striker to work back through a hole in the arm S, the spring

N keeping it normally in a fixed position. T and P are adjusting screws, and the terminals J are for connecting to the receiving apparatus. With this arrangement a very short wave-train causes only one tap of the contacts, so that only one mark is registered on the receiving drum for every contact made on the transmitter.

The drawing, Fig. 22, gives a diagrammatic

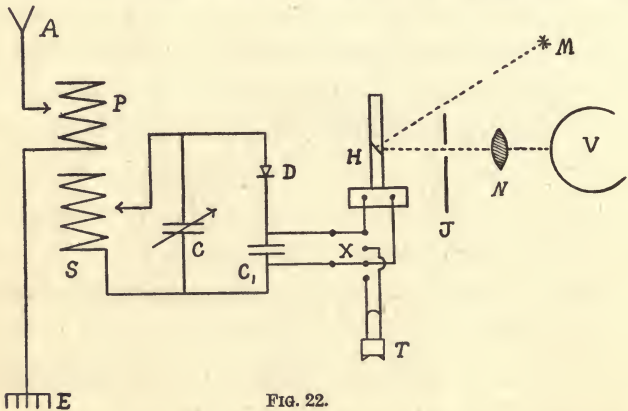

FIG. 22.

representation of apparatus arranged for another photographic method of receiving. The machine shown in Fig. 6 is used in this case. A is the aerial, E earth, P primary of oscillation-transformer, S secondary of transformer, C variable condenser, C' block condenser, D detector, X two-way switch, T telephone.

A De' Arsonval galvanometer H is also connected to the switch X, so that either the telephone or the galvanometer can be switched in. The

galvanometer can be made sensitive enough to work with a current as small as 10^{-7} of an ampere, with a period of about $\frac{1}{150}$ th of a second. The screen J has a small hole about $\frac{1}{8}$ inch diameter drilled in the centre. Under the influence of the brief currents which pass through the detector every time a group of waves is received, the mirror of the galvanometer swings to-and-fro in front of the screen J, and allows the light reflected from the source of light M to pass through the aperture in the screen, on to the lens N.

Round the drum V of the machine is wrapped a sensitive photographic film, and this records the movements of the mirror which correspond to the contacts on the half-tone print used in transmitting. Every time current passes through the galvanometer, the light that is received from M,¹ passes through the aperture in the screen J, and is focussed by the lens N to a point upon the revolving film. As soon as the current ceases, the mirror swings back to its original position, and the film is again in darkness. Upon being developed a photograph, similar to the negative used for preparing the metal print is obtained. If desired the apparatus can be so arranged that the received picture is a positive instead of a negative.

¹ Nernst lamps are the best to use, as they produce abundantly the blue and violet rays which have the greatest chemical effect upon a photographic film. Carbon filament lamps are very poor in this respect.

The detector used should be a Lodge wheel-coherer or a Marconi valve-receiver, as these are the only detectors that can be used with a recording instrument. If the swing of the galvanometer mirror is too great, a small battery with a regulating resistance can be inserted in order to limit the movement of the mirror to a very short range; the current of course flowing in an opposite direction to the current flowing through the coherer.

In this, as in all other methods of receiving, the results obtained depend upon the fineness of the line screen used in preparing the metal prints; and as already shown the fineness of the screen that can be used is dependent upon the mechanical efficiency of the entire apparatus.

Another system, and one that has been tried as a possible means of recording wireless messages, is as follows. The wireless arrangements consist of apparatus similar to that shown in Fig. 22, but instead of a Lodge coherer a Marconi valve is used, and an Einthoven galvanometer is substituted for the reflecting galvanometer. The Einthoven galvanometer consists of a very powerful electromagnet, the pole pieces of which converge almost to points. A very fine silvered quartz thread is stretched between the pole pieces, as shown in Fig. 23, the tension being adjustable. The period of swing is about $\frac{1}{250}$ th of a second. A hole is bored through the poles, and one of them is fitted

with a sliding tube which carries a short focus lens N. The light from M passes through the magnets, and a magnified image of the quartz thread is thrown upon the ebonite screen J. This screen is provided with a fine slit, and when the galvanometer is at rest the shadow of the thread just covers the slit in the screen and prevents any light from M reaching the photographic film. Upon signals being received the shadow of the thread moves to one side for a long or short period,

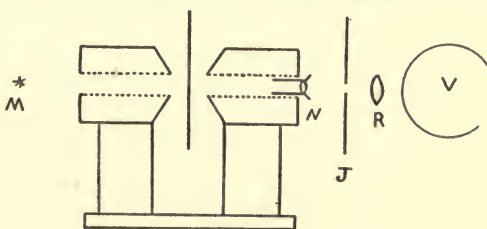

FIG. 23.

uncovering the slit, and allowing light to pass through. The lens R concentrates the collected light to a point upon the revolving film. The connections for the complete receiver are given in Fig. 24.

The modified form of the Einthoven galvanometer, as arranged by Professor Korn for use with his selenium machines for photo-telegraphy over ordinary land lines, consists of two fine silver wires which are displaced in a lateral direction between the pole pieces when traversed by a current; the current passing through both wires in the same

direction. A small shutter of aluminium foil is attached to the wires at the optical centre. The silver wires used are $\frac{1}{1000}$ inch in diameter, with a natural period of about $\frac{1}{120}$ th of a second; the length of wires free to swing being usually about 5 cm.

The period of the wires depends to a great extent upon their length and diameter, and also upon their tension. By using short fine wires the period can be made much smaller, but a greater current is required to produce a similar displace-

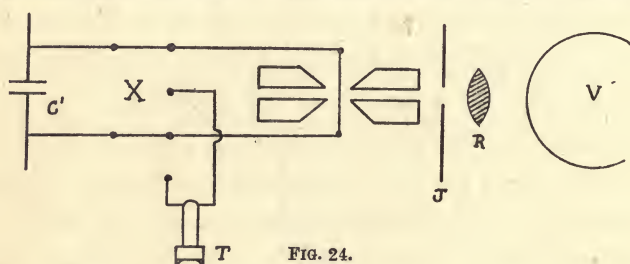

FIG. 24.

ment. Where the current available, as in wireless telegraphy, is very small, and a definite displacement of the wires is required, it is at once apparent that with wires of a given diameter there is a limit to their length and therefore to the period. Finer wires can be used, but here again there is a practical limit to their fineness, although galvanometers have been constructed with a single silvered quartz thread $\frac{1}{12000}$ th of an inch diameter, which, when placed in a powerful field, will give a good displacement with a current as small as 10^{-8} ampere.

With the apparatus arranged by the Poulsen Company, given in the diagram, Fig. 17, for photographically recording wireless signals, the current required to operate the galvanometer for signals transmitted at the rate of 1500 a minute is 1×10^{-6} ampere, while for signals up to 2500 a minute a current about 5×10^{-6} ampere is necessary.

Another very sensitive instrument, employed by M. Belin, and known as Blondel's oscillograph, consists of two fine wires stretched between the poles of a powerful electro-magnet, a small and very light mirror being attached to the centre of the wires. The current passes down one wire and up the other, and the wires, together with the mirror, are twisted to a degree depending upon the strength of the received current. In order to render the instrument dead-beat the moving parts are arranged to work in oil. The light reflected from the mirror is made use of in a manner similar to that shown in Fig. 22.

In all photographic methods of receiving, the apparatus must be enclosed in some way to prevent any extraneous light from reaching the film, or better still placed in a room lighted only by means of a ruby light.

The following method is given more as a suggestion than anything else, as I do not think it has been tried for wireless receiving, although it is stated to have given some good results over

ordinary land lines. It is the invention of Charbonelle, a French engineer, and is quite an original idea. His method consists of placing a sheet of carbon paper between two sheets of thin white paper, and wrapping the whole tightly round the drum of the machine. A hardened steel point is fastened to the diaphragm of a telephone receiver, and this receiver is placed so that the steel point presses against the sheets of paper. As the diaphragm and steel point vibrates under the influence of the received currents marks are made by the carbon sheet on the bottom paper.

Over a line where a fair amount of current is available at the receiver, the diaphragm would have sufficient movement to mark the paper, but the movement would be very small with the current received from a detector. This difficulty could no doubt be overcome to a certain extent by making a special telephone receiver, with a large and very flexible diaphragm, and wound for a very high resistance. The movement of an ordinary telephone diaphragm for a barely audible sound is, measured at the centre, about 10^{-6} of a c.m. With a unit current the movement at the centre is about $\frac{1}{700}$ th of an inch. Greater movement of the diaphragm could be obtained by connecting a *Telephone relay* to the detector, and using the magnified current from the relay to operate the telephone.

The telephone relay consists of a microphone C, Fig. 25, formed of the two pieces of osmium iridium alloy. The contact is separated to a minute degree partly by the action of the local current from F, which flows through it and also through the winding W, of the two magnet coils. The local current from F assists in forming the microphone by rendering the space between the

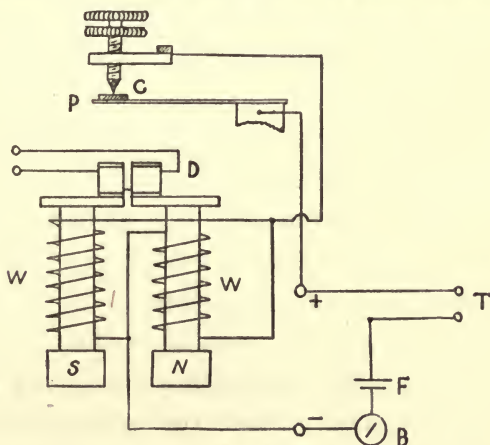

FIG. 25.

contacts conductive. The vibrating reed P is fastened to the metal frame (not shown) which carries a micrometer screw by which the distance between the contacts can be accurately regulated. It will be seen from Fig. 25 that the local circuit consists of a battery F (about 1.5 volts), the microphone contacts C, the windings W, milli-ampere meter B, and the terminals T, for connecting to the galvanometer or telephone, all in

series. On the top of the magnet cores N, S is a smaller magnet D, wound with fine wire for a resistance of about 4935 ohms, the free ends of the coils being connected to the detector terminals. The working is as follows. Supposing the current from the detector flows through D in such a way that its magnetism is increased, the reed P will be attracted, the contacts opened, and their resistance increased. It will be seen that the current from F is passed through the coils W, in such a way as to increase the magnetism of the permanent magnet, so that any opening of the microphone contact increases their resistance, causes the current to fall, and weakens the magnets to such an extent that the reed P can spring back to its normal position. On the other hand, if the detector current flows through D in such a direction as to decrease the magnetism in the permanent magnets, the reed P will rise and make better contact owing to the removal of the force opposing the stiffness of the reed. Owing to the decrease in the resistance of the microphone, the strength of the local current will be increased, the magnets strengthened, and the reed P will be pulled back to its original position. This relay gives a greatly magnified current when properly adjusted, the current being easily increased from 10^{-4} to 10^{-2} amperes. It is also very sensitive, but needs careful adjustment in order that the best results may

be obtained. A greater range of magnification can be obtained by placing two or more relays in series.

A very sensitive receiver designed by the writer is given in the figures

26 and 27. To the centre of a telephone diaphragm is fastened a light steel point P, and the movement of this point is communicated to the aluminium arm D, which is pivoted at C. As will be seen the telephone

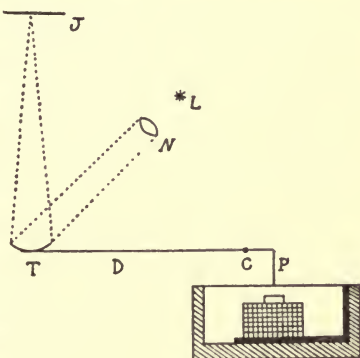

FIG. 26.

receiver is of special construction, it containing only one coil and therefore only one core; by this means the movement of the diaphragm is centralised. The coil is wound for a resistance of about 200 ohms, and the diaphragm should be fairly thin but very resilient.

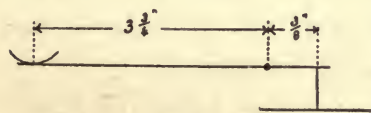

FIG. 27.

To the free end of D is fastened the mirror T, made from

thin diaphragm glass about $1\frac{1}{2}$ centimetres diameter, and having a focal length of 40 inches. Light from the lamp L is transmitted by the lens N in a parallel beam to the mirror which

concentrates it to a point upon a hole $\frac{1}{100}$ th of an inch in diameter in the screen J. As the telephone diaphragm vibrates under the influence of the received signals the arm, and consequently the mirror, vibrates also, and the hole in the screen J is constantly being covered and uncovered by the spot of light. It will be seen from Fig. 27 that the ratio between the centre of the mirror and the pivot C, and C and the steel point P is 10 : 1, so that if a movement of $\frac{1}{20000}$ th of an inch is obtained at the centre of the diaphragm the mirror will move $\frac{1}{2000}$ th of an inch; and as the focal length of the mirror is 40 inches a movement of $\frac{1}{80}$ th inch is given to the spot of light.

This receiver is capable of working at a fairly high speed, as the inertia of the moving parts is practically negligible; the weight of the arm and mirror being less than 20 grains. The hole in the screen is made slightly less in diameter than the traverse of the revolving cylinder, the slight distance between the cylinder and the screen allowing the light to disperse sufficiently to produce a line on the film of about the right thickness.

There are two other possible means of photographically receiving the picture that upon investigation may yield some results; but it is doubtful whether the current available, even that obtained from a telephone relay, will be sufficient to produce the desired magnetic effect, and the

insertion of a second relay would detract greatly from the efficiency by decreasing the speed of working. If rays of monochromatic light from a lamp L, Fig. 28, pass through a Nicol prism P (polarising prism), then through a tube containing CS_2 (carbon bisulphide), afterwards passing through the second prism P' (analysing prism), and if the two Nicol prisms are set at the polarising angle, no light from L would reach the photographic film wrapped round the drum V of the machine. Upon the tube being subjected to a field produced

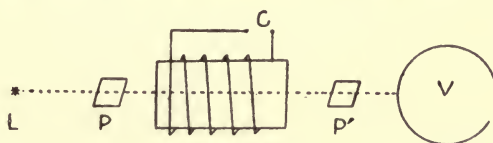

FIG. 28.

by a current passing through the coil C, the refractive index of the liquid will be changed, and light from L will reach the photographic film.¹

The second method is rather more complicated, and is based upon the fact that the cathode rays in a Crookes' tube can be deflected from their course by means of a magnet. In Fig. 29 the cathode K of the X-ray tube sends a cathode ray discharge through an aperture in the anode A, through a small aperture in the ebonite screen J

¹ A description of the apparatus required will be found in Ganot's *Physics*.

on to the drum V of the machine, round which is wrapped a photographic film; A and K being connected to suitable electrical apparatus. Upon the coil M being energised, the kathode-ray is deflected from its straight-line course, and the drum V is left in darkness.

The method which is now going to be described is very ingenious, as it makes use of what is known as an electrolytic receiver. This method of re-

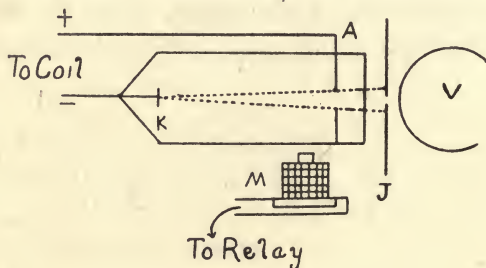

FIG. 29.

ceiving has proved to be the most practical and simple of all the photo-telegraphic systems that have been devised.

The application of this system to wireless reception is as follows. The aerial A, and the earth E, are joined to the primary P of a transformer, the secondary S being connected to a Marconi valve receiver C. The valve receiver is connected to the battery B and silvered quartz thread K of an Einthoven galvanometer (already described). The thread is $\frac{1}{12000}$ th of an inch in diameter, and will respond to currents as small as 10^{-8} of

an ampere. The light from M throws an enlarged shadow of the thread over a slit in the screen J, and as the thread moves to one side under the influence of a current, the slit in J is uncovered, and the light from M is thrown upon a small selenium cell R. In the dark the selenium cell has a very high resistance, and therefore no current can flow from the battery D to the relay F. When the string of the galvanometer moves to one side and uncovers the slit in the screen J, a certain amount of light is thrown upon the selenium cell lowering its resistance, allowing sufficient current to pass through to operate the relay.

Round the drum of the machine (shown in Fig. 7) is wrapped a sheet of paper that has been soaked in certain chemicals that are decomposed on the passage of an electric current through them. As soon as the local circuit of the relay is closed, the current from the battery Z (about 12 volts) flows through the paper and produces a coloured mark. The picture, therefore, is composed of long or short marks which correspond to the varying strips of conducting material on the single line print. In order to render the marks short and crisp, a small battery Y, and regulating resistance L, is placed across the drum and stylus. The diagram, Fig. 30, gives the connections for the complete receiver.

The paper used is soaked in a solution consisting of

Ferrocyanide of potassium	.	.	.	$\frac{1}{4}$ oz.
Ammoniac Nitrate	.	.	.	$\frac{1}{2}$ oz.
Distilled water ¹	.	.	.	4 oz.

The paper has to be very carefully chosen, as besides being absorbent enough to remain moist during the whole of the receiving, the surface must also remain fairly smooth, as with a rough paper the grain shows very distinctly, and if there is an excess of solution the electrolytic marks are

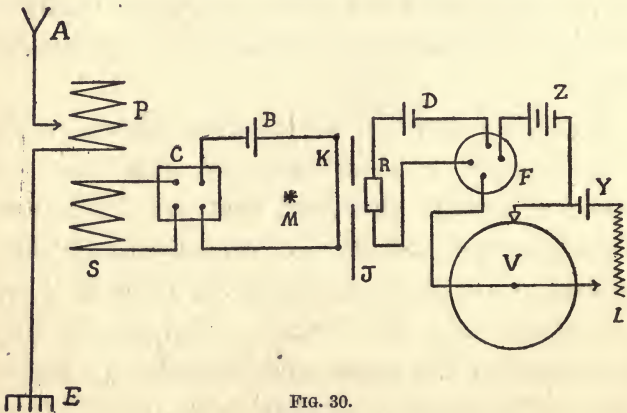

FIG. 30.

inclined to spread and so cause a blurred image. The writer tried numerous specimens of paper before one could be found that gave really satisfactory results. It was also found that when working in a warm room the paper became nearly

¹ Great care must be exercised in using this solution, as it is exceedingly poisonous.

dry before the receiving was finished, and the resistance of the paper being greatly increased (this may be anything up to 1000 ohms), the marking became very faint. A sponge moistened with the solution and applied to the undecomposed portion of the paper, while still revolving, was found to help matters considerably.

Another experience which happened during the writer's early experiments, the cause of which I am still unable to explain, occurred in connection with the stylus. The stylus used consisted of a sharply pointed steel needle, and after working for about three minutes it was noticed that the lines were becoming gradually wider, finally running into each other. Upon examination it was found that the point of the needle had worn away considerably, becoming in fact, almost a chisel point. Almost every needle tried acted in a similar manner, and to overcome this difficulty the stylus shown in Fig. 31 was devised.

It will be seen that it consists of a holder A, somewhat resembling a drill chuck, fastened to the flat spring B in such a manner that the angle the stylus makes to the drum can be altered. The needle consists of a length of 36-gauge steel wire, and as this wears away slowly the jaws of the holder can be loosened and a fresh length pushed through. The wire should not project beyond the face of the holder more than $\frac{1}{8}$ th inch. The gauge

of wire chosen would not suit every machine, the best gauge to use being found by trial, but in the writer's machine the pitch of the decomposition marks is much finer than of those made by the commercial machines, and this gauge, with the slight but unavoidable spreading of the marks, will produce a mark of just the right thickness. As already mentioned, no explanation of this peculiarity on the part of the stylus can be given, as there is nothing very corrosive in the solution used,

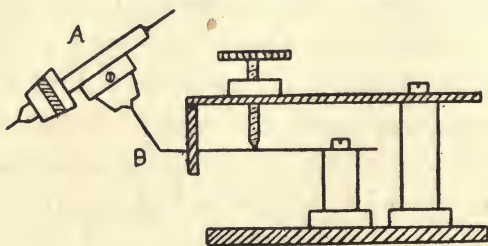

FIG. 31.

and the pressure of the stylus upon the paper is so slight as to be almost negligible.

No special means are required for fastening the paper to the drum, the moist paper adhering quite firmly. Care should be taken, however, to fasten the paper—which should be long enough to allow for a lap of about $\frac{1}{4}$ inch—in such a manner that when working the stylus draws away from the edge of the lap and not towards it.

The current required to produce electrolysis is very small, about one milliampere being sufficient.

Providing that the voltage is sufficiently high, decomposition will take place with practically "no current," it being possible to decompose the solution with the discharge from a small induction coil. The quantity of an element liberated is by weight the product of time, current, and the electro-chemical equivalent of that element, and is given by the equation $W = zct$, where

- W = quantity of element liberated in grammes.
- z = electro-chemical equivalent,
- c = current in amperes,
- t = time in seconds.

The chemical action that takes place is therefore very small, as the intermittent current sent out from the transmitter in some cases only lasts from $\frac{1}{50}$ th to $\frac{1}{100}$ th of a second.

The decomposed marks on the paper are blue, and, as photographers know, blue is reproduced in a photograph as a white, so that a photograph taken of our electrolytic picture, which will of course be a blue image upon a white ground, will be reproduced almost like a blank sheet of paper. If, however, a yellow contrast filter is placed in front of the camera lens, and an orthochromatic plate used, the blue will be reproduced in the photograph as a dead black.

There is one other point that requires attention. It will be noticed that the metal print used for

transmitting is a positive, since it is prepared from a negative. The received picture will therefore be a negative, making the final reproduction, if it is to be used for newspaper work, a negative also. Obviously this is no good. The final reproduction must be a positive, therefore the received picture must be also a positive. To overcome this difficulty matters must be so arranged at the receiving station that in the cases of Figs. 17, 18, 22, and 24, the film is kept permanently illuminated while the stylus on the transmitter is tracing over an insulating strip, and in darkness when tracing over a conducting strip. In Fig. 30 the relay F should allow a continuous current from Z to flow through the electrolytic paper, and only broken when the resistance of the selenium cell is sufficiently reduced to allow the current from D to operate the relay.

The author has endeavoured to make direct positives on glass of the picture to be transmitted, so that a negative metal print could be prepared. The results obtained were not very satisfactory, but the method tried is given, as it may perhaps be of interest. The plate used in the camera has to be exposed three or four times longer than is required for an ordinary negative. The exposed plate is then placed in a solution of protoxalate of iron (ferrous oxalate) and left until the image shows plainly through the back of the plate. It

is then washed in water and placed in a solution consisting of

Distilled water	1000 cc.
Nitric acid	2 cc.
Sulphuric acid	3 cc.
Bichromate of potash	105 grammes.
Alum	80 ..

After being in this bath for about fifteen minutes the plate is again well washed in water, and developed in the ordinary way. The first two operations should be performed in the dark room, but the remaining operations can be performed in daylight, once the plate has been placed in the bichromate bath. As already stated, the results obtained were not very satisfactory, and such a method is not now worth following up, as it is comparatively easy so to arrange matters at the receiving station that a positive or negative image can be received at will.

It is necessary to connect the stylus of the receiving machine to the positive pole of the battery Z, otherwise the marks will be made on the underside of the paper. The electrolytic receiver, owing to the absence of mechanical and electro-magnetic inertia, is capable of recording signals at a very high speed indeed.

“Atmospherics,” which are such a serious nuisance in long-distance wireless telegraphy, will also prove a nuisance in wireless photography,

but their effects will not be so serious in a photographic method of receiving as they would be in the electrolytic system. In a photographic receiver where the film is, under normal conditions, constantly illuminated, the received signals (both the transmitted signals and the atmospheric disturbances) will be recorded, after development, as transparent marks upon the film, the remainder of the film being, of course, perfectly opaque. By careful retouching the marks due to the disturbances can be eradicated, a print upon sensitised paper having been first obtained to act as a guide during the process.

CHAPTER IV

SYNCHRONISING AND DRIVING

CLOCKWORK and electro-motors are the source of driving power that are most suitable for phototelegraphic work, and each has its superior claims depending on the type of machine that is being used. For general experimental work, however, an electro-motor is perhaps the most convenient, as the speed can be regulated within very wide limits. For a constant and accurate drive a falling weight has no equal, but the apparatus required is very cumbersome and the work of winding both tedious and heavy. This method of driving was at one time universally employed with the Hughes printing telegraph, but it has now been discarded in favour of electro-motors, which are more compact, besides being cheaper to instal in the first instance.

Synchronising and isochronising the two machines are the most difficult problems that require solving in connection with wireless photography, and as previously mentioned, the syn-

chronising of the two stations must be very nearly perfect in order to obtain intelligible results. The limit of error in synchronising must be about 1 in 500 in order to obtain results suitable for publication.

The electrolytic system is perhaps the easiest to isochronise, as the received picture is visible. On the metal print used for transmitting, and at the commencing edge a datum line is drawn across in insulating ink. The reproduction of this line is carefully observed by the operator in charge of the receiving instrument, and the speed of the motor is regulated until this line lies close against a line drawn across the electrolytic paper. Although this may seem an ideal method there are one or two considerations to be taken into account. Unless the decomposition marks are made the correct length and are properly spaced, however good the isochronising may be, the result will be a blurred image. Any one who has worked with a selenium cell, will know that it cannot change from its state of high resistance to that of low resistance with infinite rapidity, and the effects of this inertia, or "fatigue" as it has been called, are more pronounced when working at a high speed. In working, the effects of this inertia would be to increase the time of contact of the relay F' (Fig. 30) as the current from D would flow for a slightly longer period through R to F' than the period of

illumination allowed by K. This, of course, would mean a lengthening of the marks on the paper ; results would also differ greatly with different selenium cells. There is a method of compensation by which the inertia of a cell can almost entirely be overcome, but it would add greatly to the complicacy of the receiving apparatus.

In using an electro-motor with any optical method of receiving there are two methods available. The first is an arrangement similar to that used by Professor Korn in his early experiments with his selenium machines. The motor used for driving has several coils in the armature connected with slip rings, from which an alternating current may be tapped off ; the motor acting partially as a generator, besides doing good work as a motor in driving the machine. This alternating current is conducted to a frequency meter, which consists of a powerful electro-magnet, over which are placed magnetised steel springs, having different natural periods of vibration. By means of a regulating resistance the motor is run until the spring which has the same period as the desired armature speed vibrates freely. The speed of the motors at both stations can thus be adjusted with a fair amount of accuracy. Another method is to make use of a governor similar to those employed in the Hughes printing telegraph system. A drawing of the governor is given in Fig. 32. It consists of a

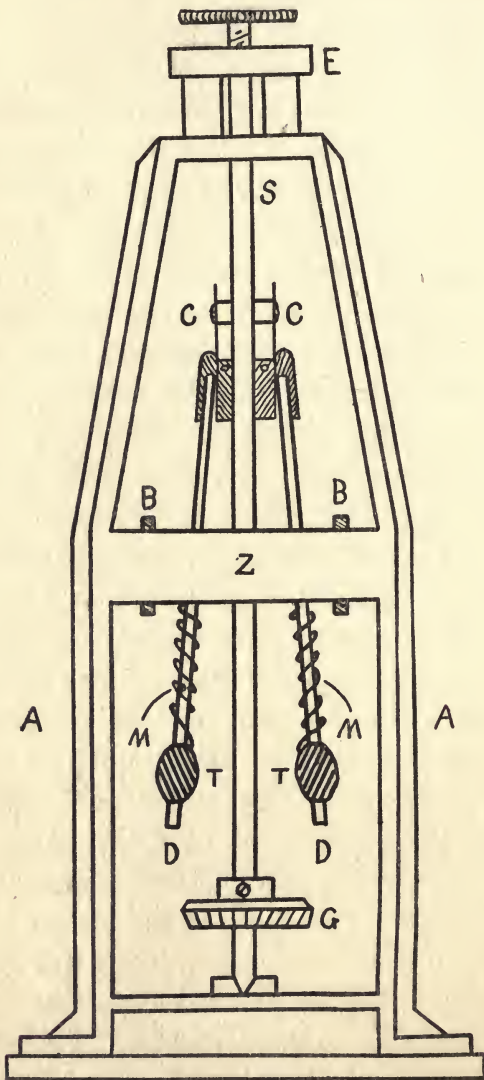

FIG. 32.

metal frame which supports an upright steel bar S, whose ends turn on pivots. This bar is rectangular in section. The gear-wheel G is fastened near the bottom of this rod and gears with a similar wheel on the shaft of the driving motor (not shown). Suspended from the broader sides of S are the two flexible arms D, each carrying a brass ball T. These balls are not fastened to the arms, but can slide up and down, being held in position by the wire springs M, one end of each spring being fastened to the screws C. These screws work in a slot cut in the upper part of S, and are connected to the adjusting screw E. When E is turned the screws are raised or lowered accordingly, and also the balls on the arms D.

Fastened to the arms are two brushes of tow B, and these revolve inside but just clearing the inner surface of the steel ring Z. Upon the motor speed increasing above the normal the arms D, and consequently the balls T, swing out, making a larger circle, causing the brushes B to press against the steel ring Z, setting up friction which, however, is reduced as soon as the motor regains its ordinary working speed. By careful adjustment the speed of the motors can be kept perfectly constant. The object of having the balls T adjustable on D, is to provide a means of altering the motor speed, as the lower the balls on D the slower the mechanism runs, and *vice versa*.

A simple and effective speed regulator devised by the writer is given in drawings 33 and 34. It comprises two parts, A and B, the part A being

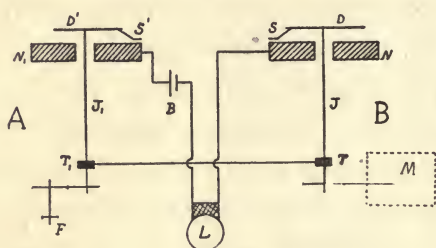

FIG. 33.

connected to the driving motor, and the part B working independently. The independent portion B consists of an ordinary

clock movement M, a steel spindle J being geared to one of the slower moving wheels, so that it makes just one revolution in two seconds. This spindle, which runs in two coned bearings, carries at its outer end a light

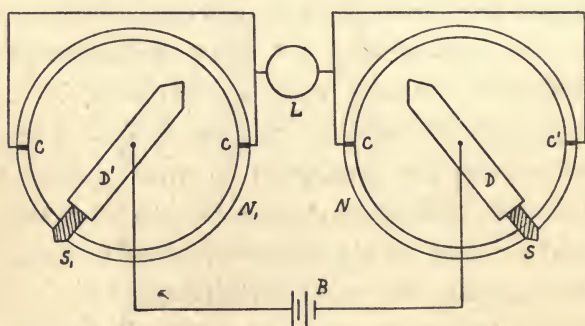

FIG. 34.

pointer D, about two inches long, to the underside of which is fastened the thin brass contact spring S, which presses lightly upon the ebonite ring N.

The portion A comprises a spindle, pointer, and contact spring similar to those employed in B, the spindle J' being geared to the driving motor by means of F, so that the pointer D' makes a little more than one revolution in two seconds. By means of a special form of brake on the driving motor, the speed is reduced, so that both pointers travel at the same rate, viz. one revolution in two seconds. By careful adjustment the two pointers can be made to revolve in synchronism,¹ and when this is obtained the contact springs S, S', pass over the contacts C, C', completing the circuit of the battery B and lamp L. When working properly the lamp L lights up regularly once every second. This regulator is an excellent one to use for experimental work, although it depends a great deal upon the skill of the operator, but good adjustment should be obtained in about two minutes. It is a good plan to insert a clutch of some description between the driving motor and the machine, so that the regulator can be adjusted prior to the act of receiving or transmitting, the machine being prevented from revolving by means of a catch. The motor used should be powerful enough to take up the work of driving the machine without any reduction in speed. The clocks M can be regulated so that they only gain or lose a few seconds in

¹ Two clocks would isochronise if their hands travelled at precisely the same rate round the dials, but would not synchronise unless they both registered the same time as well.

twenty-four hours, which gives an accuracy in working sufficient for all practical purposes.

Connection is made with the contact springs S, S', by means of the springs T, T', which press against the spindles J, J',

Another important point is the correct placing of the picture upon the receiving drum. It is necessary that the two machines besides revolving in perfect isochronism should synchronise as well, *i.e.* begin to transmit and record at exactly the same position on the cylinders, *viz.* at the edge of the lap, so that the component parts of the received image shall occupy the same position on the paper or film as they do on the metal print. If the receiving cylinder had, let us suppose, completed a quarter of a revolution before it started to reproduce, the reproduction when removed from the machine and opened out will be found to be incorrectly placed; the bottom portion of the picture being joined to the top portion, or *vice versa*, and this means that perhaps an important piece of the picture would be rendered useless even if the whole is not spoilt. It is evident, therefore, that some arrangement must be employed whereby synchronism, as well as isochronism of the two instruments can be maintained.

There are several methods of synchronising that are in constant use in high-speed telegraphy, in which the limit of error is reduced to a minimum,

and some modification of these methods will perhaps solve the problem, but it must be remembered that synchronism is far easier to obtain where the two stations are connected by a length of line than where the two stations are running independently.

In one system of ordinary photo-telegraphy synchronism is obtained in the following manner. The receiving cylinder travels at a speed slightly in excess of the transmitting cylinder, and as its revolution is finished first is prevented from revolving by a check, and when in this position the receiving apparatus is thrown out of circuit and an electro-magnet which operates the check is switched in. When the transmitting cylinder has completed its revolution (about $\frac{1}{100}$ th of a second later) the transmitting apparatus, by means of a special arrangement, is thrown out of circuit for a period, just long enough for a powerful current to be sent through the line. This current actuates the electro-magnet. The check is withdrawn and the receiving cylinder commences a fresh revolution in perfect synchronism with the transmitting cylinder. As soon as the check is withdrawn the receiving apparatus is again placed in circuit until another revolution is completed. As the receiver cannot stop and start abruptly at the end of each revolution a spring clutch is inserted between the driving motor and the machine.

Although a method of synchronising similar to this may later on be devised for wireless photography, the writer, from the result of his own experiments, is led to believe that results good enough for all practical purposes can be obtained by fitting a synchronising device whereby the two machines are started work at the same instant, and relying upon the perfect regulation of the speed of the motors for correct working.

The method of isochronism must, however, be nearly perfect in its action, as it is easy to see that with only a very slight difference in the speed of either machine this error will, when multiplied by 40 or 50 revolutions, completely destroy the received picture for practical purposes.

From what has been written in this and in the preceding chapters it will be evident that the successful solution of transmitting photographs by wireless methods will necessitate the use of a great many pieces of apparatus all requiring delicate adjustment, and depending largely upon each other for efficient working. As previously stated, there is at present no real system of wireless photography, the whole science being in a purely experimental stage, but already Professor Korn has succeeded in transmitting photographs between Berlin and Paris, a distance of over 700 miles. If such a distance could be worked over successfully, there is no reason to doubt that before long

we shall be able to receive pictures from America with as great reliability and precision as we now receive messages.

In nearly all wireless photographic systems devised up to the present the chief portion of the receiver consists of a very sensitive galvanometer, and although very good results have been obtained by their use they are more or less a nuisance, as the extreme delicacy of their construction renders them liable to a lot of unnecessary movement caused by external disturbances. A galvanometer of the De' Arsonval pattern, used by the writer, was constantly being disturbed by merely walking about the room, although placed upon a fairly substantial table; and for the same reason it was impossible to attempt to place the driving motor of the machine on the same table as the galvanometer. For ship-board work it will be evident that the use of such a sensitive instrument presents a great difficulty to successful working, and a good opening exists for some piece of apparatus—to take the place of the galvanometer—that will be as sensitive in its action but more robust in its construction.

CHAPTER V

THE "TELEPHOGRAPH"

IN the present chapter it is proposed to give a brief description of a system of radio-photography devised by the author, and which includes a greatly improved method of transmitting and receiving, as well as an ingenious arrangement for synchronising the two stations; the whole being an attempt to produce a system that would be capable of working commercially over fairly long distances.

The system about to be described, and which I have designated the "telephograph," is the outcome of several years' original experimental work, many difficulties that were manifest in the working of the earlier systems having been overcome by apparatus that has been expressly designed for the purpose.

In any practical system of radio-photography the following points are of great importance: (1) the speed of transmission; (2) the quality of the received picture; (3) the method of synchronising

the two machines so that transmission and reception begin simultaneously ; (4) the correct regulation of the speed of the driving motors ; (5) the simplicity and reliability of the entire arrangement. Points 1 and 2 are dependent upon several factors ; the number of contacts made by the stylus per minute ; the size of the metal print used ; the number of lines per inch on the screen used in preparing the print ; and the accurate and harmonious working of the various pieces of apparatus employed.

In the system under discussion the size of the metal print used is 5 inches by 7 inches, and a screen having 50 lines to the inch is used for preparing it. With the drum of the machine making one revolution in four seconds, the stylus makes 87 contacts per second, or 5220 a minute, the time for complete transmission being twenty-five minutes. By the use of ordinary relays not more than 2000 contacts a minute can be obtained, and in the present system it is only by means of a specially designed relay that such a high rate of working has been made possible. Similarly, too, with the receiving of such a large number of signals transmitted at such a high speed, a special instrument has been devised that can record this number of signals without any trouble, and could even record up to 8000 signals a minute, provided that a suitable transmitter could be designed.

In the present system the writer does not claim to have completely solved the problem of the wireless transmission of photographs, but it is a great advance on any system previously described, and the following advantages are put forward for recognition: (1) a greatly improved method of transmitting and receiving; (2) a simple method of regulating the speed of the driving motors and maintaining isochronism with a limit of error of less than 1 in 800; (3) an arrangement for synchronising the two machines whereby transmitting and receiving begin simultaneously; (4) the use of one machine only at each station.

TRANSMITTING APPARATUS

A diagrammatic representation of the apparatus required for a complete station, transmitting and receiving combined, is given in Fig. 35, the usual wireless equipment having been omitted from the diagram to avoid confusion.

The Machine.—This, as will be seen from Fig. 36, consists of a base-plate M, to which are attached the two bearings B and B'. The bearing B' is fitted with an internal thread to correspond with the threaded portion of the shaft D. The drum V is a brass casting, being fastened to the shaft by set screws. The shaft is threaded 75 to the inch. The bearings are preferably of the concentric type. The circuit breaker C is so arranged that when

the drum has traversed the required distance, the end of the shaft pushes back the spring M, breaking the circuit of the driving gear and stopping the machine. The machine is connected to the driving gear by the flexible coupling A.

The drum measures 5 inches long by $2\frac{1}{8}$ inches

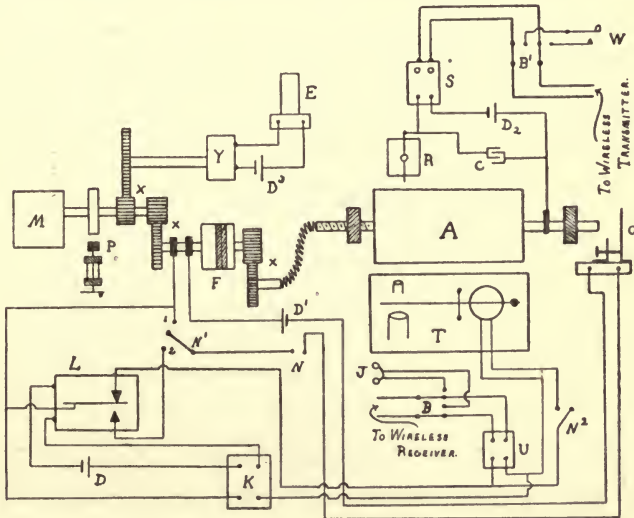

FIG. 35.

M, motor; Y, isochroniser; F, clutch; A, machine; R, stylus; S, relay; X, gearing; O, circuit breaker; T, receiver; C, condenser; U, telephone relay; K, polarised relay; L, contact breaker; D, D¹, D², D³, D⁴, batteries; P, friction brake; B, B¹, double-pole two-way switches; N, N¹, N², single switches; W, key; E, electric clock; J, telephones.

diameter, and this takes a metal print 5 inches by 7 inches, which allows for a lap of about $\frac{1}{4}$ inch. In working, the print is wrapped tightly round the drum, being secured by means of a little seccotine smeared along one edge. Care must be taken that the edge of the lap draws away from the point of

the stylus and not towards it. A margin of bare foil, about $\frac{1}{8}$ inch wide, should be left on the print at the commencing edge, the purpose of which will be explained later.

The Stylus.—As the drum of the machine travels laterally, by reason of the threaded shaft and bearing, the stylus must necessarily be a fixture. It consists of a holder B, drilled to take a hardened steel point S, attached to the spring M. The spring is arranged to work in the guide F, which

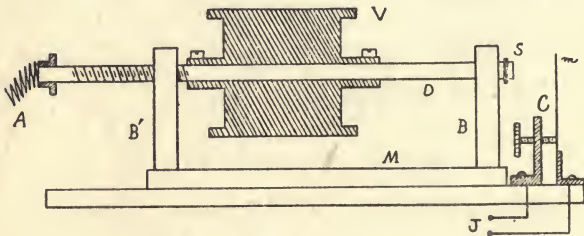

FIG. 36.

is provided with an adjusting screw W for regulating the pressure of the stylus upon the print; the pressure being sufficient to enable good contact to be made, but must not be heavy enough to scratch the soft foil. The needle should present an angle of about 60° to the surface of the print, as this angle has been found to give the best results in working.

To eliminate any sparking that may take place at the point of make and break, due to the self-induction of the relay coils, a condenser C, about 1 microfarad capacity, should be connected across

the drum and stylus. The complete stylus is given in the drawings, Figs. 37, 37a, and also in the diagrams Figs. 8 and 9.

The Relay.—As will be seen from the diagram,

Fig. 38, this consists of two electro-magnets having very soft iron cores, the magnet M being wound in the usual manner,

while the magnet N is wound differentially. The armature A is made as light as possible, and is pivoted at P, and when there is no current flowing through any of the coils, is held midway between the magnet cores by the two spiral springs S and T, which are under slight but equal tension. The connections are as follows.

The wires from the winding on M are connected directly to the relay terminals F and H, as are also the wires from one winding on N. The other

winding on N is connected in series with the battery C, ammeter B, and regulating resistance R.

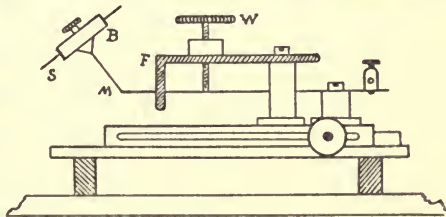

FIG. 37.

Showing the arrangement for sliding the stylus to or from the machine.

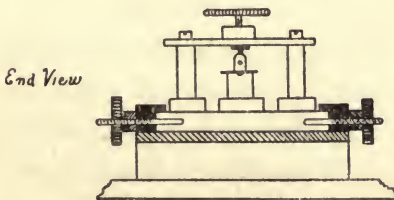

FIG. 37a.

When the circuit of the battery C is completed, the coil of N, to which it is connected, is energised, and the armature A is attracted against the stop V. When in this position the tension of the spring S is released, while the tension of the spring T is increased. As soon as the circuit of the battery D is completed by means of the metal line print on the transmitting machine, the current divides at

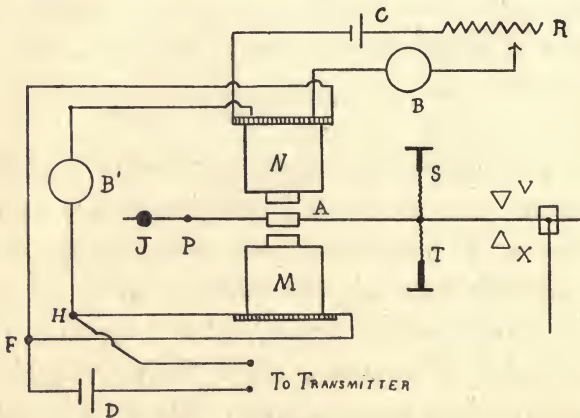

FIG. 38.

the terminals F and H, a portion flowing through the magnet coil M, and a portion through the remaining winding on N. The current which flows through the winding on N produces a magnetising effect equal to that caused by the other winding on N, but since the two windings are of equal length and resistance, and since the current flowing through the two windings is of equal strength but in opposite directions, the result is to neutralise

the magnetising effects produced by each winding, and consequently no magnetism is produced in the cores.

The other portion of the current from D flows through the coil M, and it becomes magnetised at the same time that the coil N becomes demagnetised. The armature A is attracted by M against the stop X, and this attraction is assisted by the spring T, which was under increased tension. The conditions of the springs are now reversed, the spring S being under increased tension, while the tension of the spring T is released.

As soon as the current from D is broken, the magnetism disappears from M, the neutralising current in N ceases, and N once more becomes magnetised, owing to the current which still flows through one winding from C; the armature is therefore again attracted by N, assisted by the spring S. The current flowing through the two windings of N must be perfectly equal, and the regulating resistance R, and ammeters B and B', are inserted for purposes of adjustment. The current from C must flow in a direction opposite to that which flows from D.

The local circuit of the relay is completed by means of a copper dipper in mercury, somewhat resembling an ordinary mercury break, but modified to suit the present requirements. The arrangement will be seen from Fig. 39. The whole of the

moving parts are made as light as possible, and for this reason the rod C and the dippers F, F' should be made as short as convenient. The containers H, H' are separate, of cast iron, and rectangular in shape. The dipper is of very thin copper tube—an advantage where alternating current is to be used—and is made adjustable for height on the suspending rod C. The leg F is of such a length that permanent contact is made

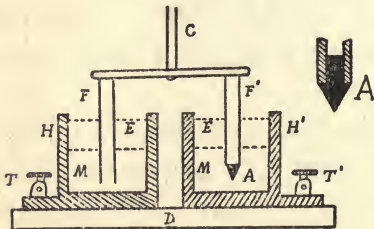

FIG. 39.

H, H', containers; M, mercury; E, paraffin oil; T, T', terminals; C, suspending rod; D, base; F, F', dipping rods.

with the mercury in the container H, while the leg F' clears the surface of the mercury by about $\frac{1}{4}$ inch, when the armature of the relay is in its normal position. To prevent

undue churning of the mercury, which would necessarily take place if the dipper entered and left the mercury at each movement of the armature, a pointed ebonite plug is inserted in the end of the tube. This will be found to give good results at a high speed, the mercury being practically undisturbed, and the production of "sludge" reduced to a minimum. To prevent oxidation of the mercury, and to prevent arcing, the surface is covered with paraffin oil. If this is not sufficient to prevent arcing a condenser should be shunted across the

containers. The volume of mercury, and the area of the dippers, should be sufficient to carry the current used for a considerable period without heating up to any extent. An adjustable weight J is provided in order to balance the armature and dipping rod.

The remaining transmitting apparatus consists of the battery D² and the usual wireless apparatus. The double-pole two-way switch B' is to enable the photo-telegraphic set to be switched out and the hand key W switched in for ordinary signalling purposes. The battery D² should be about 12 volts.

RECEIVING APPARATUS

The wireless portion of the receiver is similar to that given in Fig. 22, is of the usual syntonic type, and comprises an oscillation transformer, S being the secondary, and P the primary; C' is a block condenser, and C a variable condenser. The detector D is of the carborundum crystal or electrolytic pattern. A two-way switch B is provided so that the relay U can be switched out and the telephones J switched in for ordinary receiving purposes. The relay U is a Brown's telephone relay.

The Receiver.—The magnified current from the relay U is taken to a special telephone receiver, the construction of which is given in Fig. 40. The diaphragm F is about 2½ inches diameter, and should be fairly thin but very resilient. Only one

coil is provided, and this should be wound with No. 47 S.S.C. copper wire for a resistance of about

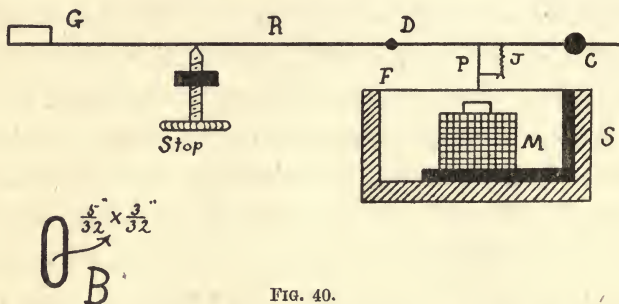

FIG. 40.

2000 ohms. By using only one coil and therefore only one core, the movement of the diaphragm is centralised. To the centre of the diaphragm a light steel point is fastened, about $\frac{1}{2}$ inch long, and provided with a projecting hook H. An enlarged view of this pin is given in Fig. 41. The movement

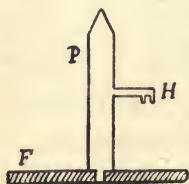

FIG. 41.

of the diaphragm and consequently of the steel point P is communicated to a pivoted rod R, which is of special construction. A piece of aluminium tube $3\frac{3}{4}$

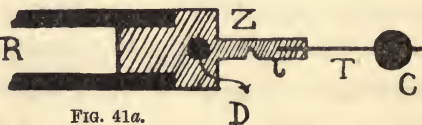

FIG. 41a.

inches long, and of the section given at B, is bushed at one end with a piece of brass of the shape shown in Fig. 41a. A stiff steel wire T about 1 inch long (20 gauge) is screwed into the end of Z, and carries a counterbalance weight C. A hardened

steel spindle, pointed at both ends, is fastened at D, and runs between two coned bearings, one of which is adjustable. The underside of Z is flattened, and a small coned depression is made for the reception of the pointed end of the pin. By means of the spring J the two pieces, Z and P, are held firmly together, at the same time allowing perfect freedom of movement. The bridge G is made from a piece of sheet aluminium placed in a slot cut in the tube R, the end of the tube being pressed tight upon G, and secured by means of a small rivet.

The optical arrangements are as follows. By means of the Nernst lamp L, and the lenses B and B', Figs. 42 and 43, a magnified shadow of G is thrown upon the screen J. When the shutter G is in its normal position (*i.e.* at rest), its shadow is just above the small hole in J, and light from L reaches the photographic film wrapped round the drum V of the machine.

When, however,

signals are sent out from the transmitting apparatus, the magnified current from the relay U energises the coil of the special telephone S, attracting the diaphragm F, and consequently giving movement to the pivoted rod R. As by means of the optical arrangements a

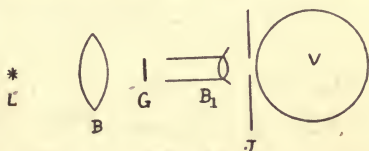

FIG. 42.

J, screen ; L, Nernst lamp ; G, shutter ; B, condensing lens ; B₁, focussing lens.

magnified movement as well as a magnified image of G is thrown upon the screen J, the shadow of G will, when the telephone S is actuated, cover the hole in the screen, and prevent any light from reaching the film on V, until current from the relay U ceases to flow. Therefore, when the stylus of the transmitter traces over a conducting strip on the metal print, no light reaches the film on V, but when tracing over an insulating strip the

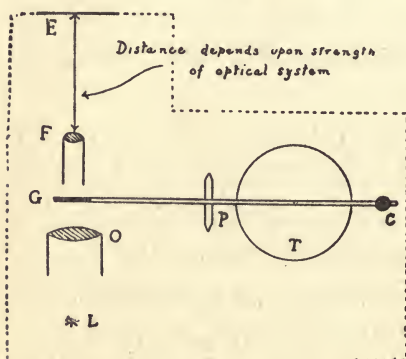

FIG. 43.

E, ebonite screen; F, focussing lens; G, shutter; O, condensing lens; L, Nernst lamp.

shadow of G on the screen J rises, and the light from L reaches the film. By this means a positive picture is received, which is a great advantage where the photographs are required

for reproduction.

Atmospherics

would be represented by irregular transparent marks on the film after development, and these can be easily eradicated by retouching.

The drum of the machine moves laterally $\frac{1}{75}$ th of an inch per revolution, and the hole in the screen is $\frac{1}{30}$ th of an inch in diameter. As the screen J is not in direct contact with the film, the slight diffusion of the light that takes place will produce

a mark of about the right thickness. With a movement of the diaphragm of only $\frac{1}{40000}$ th of an inch, the actual movement of G will be $\frac{1}{4000}$ th of an inch. If the optical arrangements have a magnifying power of 100, then the movement of the shadow upon the screen will be $\frac{1}{40}$ th of an inch, which will be ample to cover the aperture.

The aluminium rod R, minus the counter-weight, can be made to weigh not more than 12 grains. It is necessary to enclose the optical parts in a light tight box, indicated by the dotted lines in Fig. 43, in order to prevent any extraneous light from reaching the film.

The Contact Breaker.—The contact breaker (L, Fig. 35), as will be seen from Fig. 44, consists of an electro-magnet N, the windings of which are connected with the battery B and the polarised relay K. The armature which is supported by the spring G carries a contact arm A, which in its normal position makes permanent contact with the contact screw T, and completes the circuit between the relay K and the telephone relay U (Fig. 35). As soon as the transmitter sends out the first signal, the magnified current from the telephone relay actuates the relay K, which in turn completes the circuit of the contact breaker. Directly the armature M has been attracted, the contact with T is broken, and A makes fresh contact with the screw H, by means of the spring Z

fastened to the underside of A. The armature, once it has been attracted, is held in permanent contact with H by the catch S, independent of the magnets N. As soon as contact is made with H, the clutch (F, Fig. 35) circuit is completed, and the circuit of the relay K is broken. When the circuit of the clutch F is broken by means of the circuit breaker C on the machine (Fig. 36), the stop S is pulled back by hand, allowing the contact

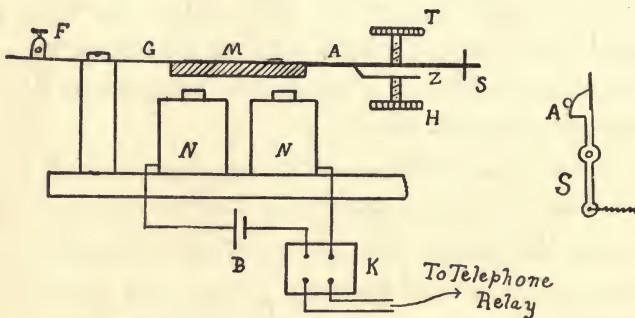

FIG. 44.

arm A to rise, and again make fresh contact with the contact screw T.

DRIVING APPARATUS

The Friction Brake.—This consists of a steel disc A, Fig. 45, about $2\frac{1}{2}$ inches diameter and $\frac{3}{8}$ inch or $\frac{1}{2}$ inch wide on the face, secured to the main shaft of the driving motor. The arm H, pivoted at C, carries at one end the curved block B, which is faced with a pad of tow F. The other extremity is pivoted to the steel rod P, which slides

in holes bored in the standards J. One end of the rod P is screwed with a fine thread, about 75 to the inch, and is fitted with a regulating wheel T, by means of which the block B can be made to press upon the disc A with any required degree of pressure. A fairly stiff steel spring R is placed upon the rod P, between one standard J and the collar N. As the speed of the driving motor is slightly in excess of that required by the machine, the block B, by means of the wheel, is made to press upon the disc A, setting up friction which reduces the motor speed until the isochroniser indicates that the correct working speed has been attained.

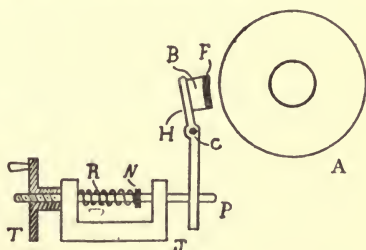

FIG. 45.

The Clutch.—The details of this will be seen from Figs. 46 and 47. It consists of a steel shaft coned at both ends running between two counter-sunk bearings, one of which is adjustable. This shaft carries the two portions of the clutch A and B, the portion A being a fixture on the shaft, and the portion B running free upon it. The portion B is a gun-metal casting bored to run accurately upon the steel shaft. A soft iron annular ring is fastened to the face.

The portion A consists of a gun-metal casting

bored a tight fit for the shaft E, secured by means of a set screw. The two magnet cores P are screwed into the front plate V, which is also of gun-metal,

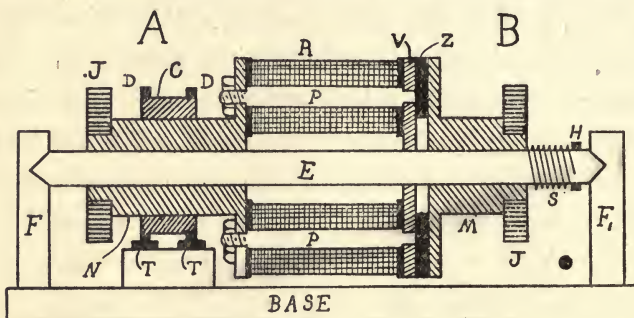

FIG. 46.

E, spindle; R, bobbins; P, iron cores; D, copper rings; T, brushes; N, back plate; V, front plate; J, gearing; S, spring; H, collar; Z, iron ring; F, fixed bearing; C, insulating bush.

and after the bobbins R have been slipped on, the shanks of the cores are passed through holes drilled

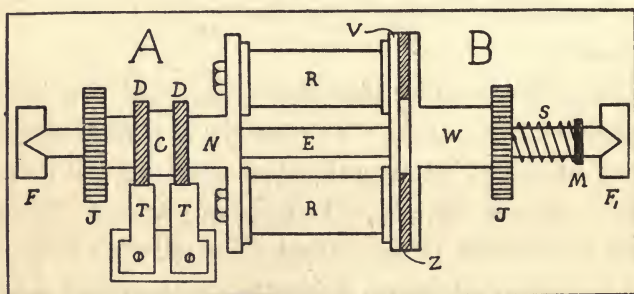

FIG. 47.

in the flange N of the main casting and held in place with nuts. The faces of both A and B must be turned perfectly square with the shaft, so that they run accurately together. The portion B is

kept in contact with A by means of a spring S, the pressure being regulated by the collar H. Current is taken to the magnets by means of the two insulated copper rings D mounted upon the body of A. The gear-wheels on both portions have teeth of very fine pitch, the number of teeth on each being regulated by the speed of the driving motor and the required machine speed. Connection with the circuit breaker L and the battery B² is made with the collecting rings D by the brushes T. The complete connections are given in the diagram Fig. 51.

The Isochroniser.—This is a device for ensuring the correct speed regulation of the driving motors, and is shown in detail in Fig. 48. It comprises two portions, one portion being rotated at a definite speed by electrical means, and the other portion rotated by the driving motor.

The main portion consists of a metal tube N, bushed at both ends, the bottom end of the tube being arranged to work on ball-bearings. An ebonite bush C carries three copper rings T, T¹, T², and the brushes R, R¹, R² are in electrical contact with them. The ebonite plate J, 3½ inches diameter, is secured to the top end of N, and carries a contact piece Q, shown separate at E. As will be seen this is a block of ebonite with three contacts arranged on the top surface. The middle contact P is $\frac{1}{64}$ th of an inch wide, and the contacts P¹

and P^2 are placed on either side at a distance of $\frac{1}{16}$ inch; the contact strips P^1 , P^2 carry the brass pins D , which are about $\frac{1}{16}$ inch diameter, and spaced $\frac{3}{8}$ inch apart. A connecting wire is

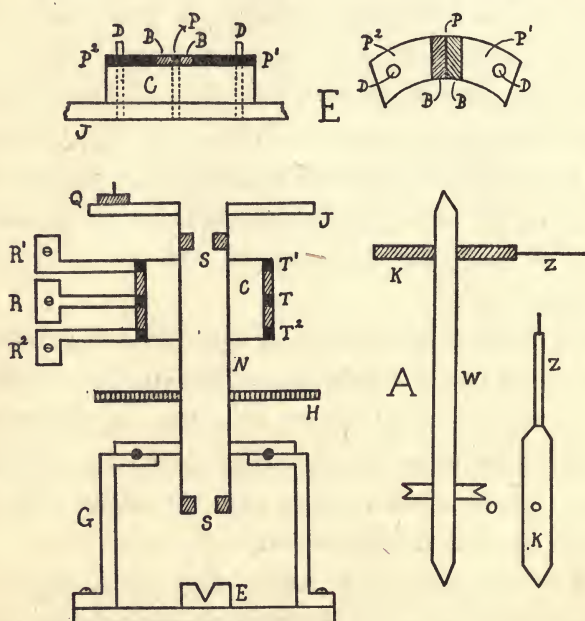

FIG. 48.

N , brass tube; S , bushes; G , ball-bearing; H , gear-wheel; T , T^1 , T^2 , copper rings; C , insulating block; R , R^1 , R^2 , brushes; J , ebonite disc; Q , contact block; D , metal pins; O , pulley; P , P^1 , P^2 , contact plates; K , needle; Z , spring; W , steel rod; E , countersunk bearing.

carried from the contact P to the copper ring T , another from P^1 to T^1 , and one from P^2 to T^2 .

The bushes S are bored a running fit for the steel rod W (shown separate at A), which is coned at both ends, and runs between two countersunk bearings, the bottom bearing E being fixed while

the top bearing (not shown) is adjustable. A needle K is fastened near the end of the rod W, and attached to this needle is the spring Z, which presses lightly but firmly upon the contact block Q. To provide a level surface for Z to work over, the spaces between the contact pieces are filled in with an insulating material, and the whole surface finished off perfectly smooth. The spring Z is $\frac{1}{8}$ inch wide for portion of its length, but at the point where it presses upon Q it is reduced in width to $\frac{1}{64}$ th of an inch (see Fig. 48). The driving arrangements are as follows. A counter-shaft Q, Fig. 51, fitted with a grooved pulley, is run in bearings parallel with the shaft W, and is connected by suitable gearing to the shaft of the driving motor, so that the needle K makes one revolution in about $2\frac{1}{2}$ seconds. A belt passing over the pulleys connects the two shafts, and the tension of the belt is regulated by means of an adjustable jockey pulley.

The tube N, carrying the disc J, must be rotated at a fixed speed, and this is accomplished in the following manner. An ordinary electric clock impulse dial, actuated from a master clock, is connected by suitable gearing H, so that the tube N makes exactly one revolution in 2 seconds; it being possible to adjust an electric clock of the "Synchronome" type, so that it only gains or loses about 1 second in 24 hours, and this provides

an accuracy sufficient for all practical purposes. The connections are given in Fig. 49, and the face

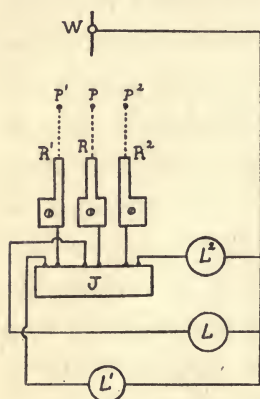

FIG. 49.

of the instrument in Fig. 50. It will be seen that a connecting wire is run from the steel spindle W to one terminal each of the lamps L, L¹, L², and from the other terminal of the lamps to one terminal of the batteries J, the battery comprising a set of three 4-volt accumulators. The other terminals of the batteries

are joined one to each of the brushes R, R¹, R².

The lamps are coloured, the lamp L being white, and the lamps L¹ and L² blue and red respectively, and care must be taken in connecting up that when the needle K makes contact with the stud P the white lamp L is in circuit. When the machines are working, the operator, by means of the brake (already described), reduces the speed of the driving motor until

the needle K travels in unison with the disc J, making permanent contact with P on the contact

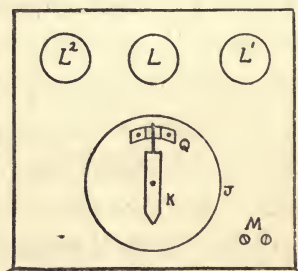

FIG. 50.

M, terminals for connecting to electric clock; L, white lamp; L¹, blue lamp; L², red lamp.

block Q, which is evidenced by the lamp L remaining alight. If, however, the needle travels faster than the disc J, contact with P is broken and fresh contact is made with P², the lamp L is extinguished and the red lamp L² lights up, and remains alight until the operator reduces the speed. Similarly, too, if the needle travels slower than J, contact is made with P¹, and the circuit of the blue lamp L¹ is completed. When the speed is either above or below the normal, the needle K engages with one or the other of the pins D, and as the tension of the driving belt is only such as is required to drive the needle, the belt slips on the pulleys until the normal speed is regained.

METHOD OF WORKING

The clockwork motor M, Fig. 51, should be capable of running for several hours with one winding, and powerful enough to take up the work of driving the machine without any appreciable effort. The main spindle of the motor is so arranged that it makes one revolution in two minutes, and the reduction in speed between the motor shaft and the shaft to which the coupling A is attached is 30 : 1. The metal line print having been wrapped round the drum of the machine, the stylus is put into position, at the edge of the lap, and with the needle resting about half-way on

the margin of the bare foil left at the commencing edge of the print. Now, when the two stations are in perfect readiness for work, the motors are started and the speed adjusted; the speed of the machine being just under one revolution in four seconds.

The switch D is then closed, and the arm of

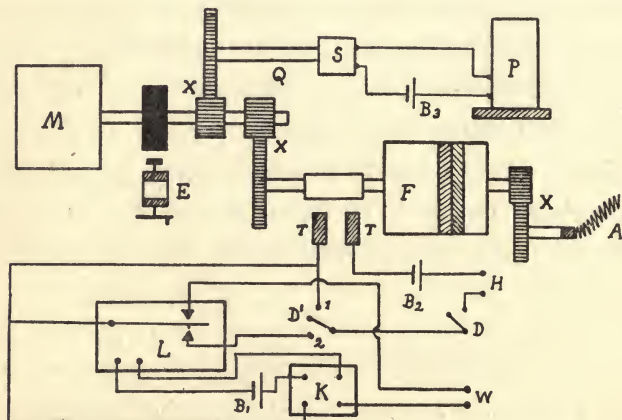

FIG. 51.

M, clockwork motor; S, isochroniser; E, friction brake; T, brushes; F, electric clutch; X, gearing; D, D¹, switches; A, flexible coupling; K, polarised relay; L, circuit breaker; B₁, B₂, B₃, batteries; P, electric clock; W, terminals for connection to telephone relay; H, terminals for connection to terminals J, on transmitting machine.

the switch D¹ placed on the contact stud (1), at the transmitting station only. As soon as the switches are closed the clutch F comes into action, and the transmitting machine begins to revolve. When the whole of the line print wrapped round the drum of the machine has passed under the stylus, the end of the shaft D, Fig. 36, engages

with the spring *m*, breaking the clutch circuit and allowing the motor to run free. As soon as the machine stops, the switch D is opened and the machine run back to its starting position by hand.

At the receiving station the switch D is also closed, and the arm of the switch D¹ placed on the contact stud (2). The closing of these switches does not bring the clutch F into operation until current from the telephone relay U connected to the wireless receiving apparatus works the sensitive polarised relay K, which in turn completes the circuit of the circuit-breaker L. When the armature of L is attracted, the circuit of the relay K is broken, the circuit of the clutch F is completed, and the machine starts revolving.

The current from the relay U, due to the transmitting stylus passing over *one* contact strip on the metal print, is too brief to actuate the heavier mechanism of the relay K, hence the need of the margin of bare foil at the commencing edge of the metal print, so that a practically continuous current will flow to the relay K until the armature is attracted. As, however, the relay is not actuated at the receipt of the first signal, and as it is necessary for the machine to start recording at a certain point on the film, viz.

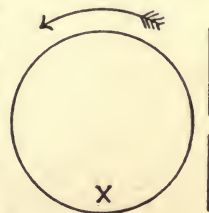

FIG. 52.

at the edge of the lap—the reason for this was given in Chapter IV.—the starting position of the receiving drum will be similar to that given in the diagram Fig. 52, where X indicates the lap of the photographic film, and the arrow the direction of rotation.

It is, of course, obvious that a somewhat similar adjustment must be made with regard to the position of the stylus on the metal print at the transmitting machine.

APPENDIX A

SELENIUM CELLS

SELENIUM is a non-metallic element, and was first discovered by Berzelius in 1817, in the deposit from sulphuric acid chambers, which still continues the source from which it is obtained for commercial purposes, although it is found to a small extent in native sulphur. Its at. wt. is 79.2, and its sp. gr. 4.8. Symbol, Se.

In its natural state selenium is practically a non-conductor of electricity, its resistance being forty thousand million times greater than copper. Its practical value lies in the property which it possesses, that when in a prepared condition it is capable of varying its electrical resistance according to the amount of light to which it is exposed, the resistance decreasing as the light increases.

Selenium is prepared by heating it to a temperature of 120° C., keeping it there for some hours, and allowing it to cool slowly, when it assumes a crystalline form and changes from a bluish grey to a dull slate colour. A selenium cell in its simplest form consists merely of some prepared selenium placed between two or more metal electrodes, the selenium acting as a high resistance conductor between them. The form given by Bell and Tainter to the cells used in their experiments is given in Figs. 53 and 53a. It consists of a number of rectangular brass plates P, P', separated by very thin sheets of mica M, the mica sheets being slightly narrower than the brass plates, the whole being clamped together in the frame F by the two bolts B.

By means of a sand-bath the cell is raised to the desired temperature, and selenium is rubbed over the surface, which melts and fills the small spaces between the brass plates. All the plates P are connected together to form one terminal, and the plates P' to form the other. By using very thin mica sheets, and a large number of elements, a very narrow transverse section of selenium, together with a large active surface, can be obtained.

The cell used for commercial purposes is usually constructed as follows. A small rectangular piece of porcelain, slate, mica, or other insulator, is wound with many turns of fine platinum wire. The wire is wound double, as shown



FIG. 53.

P, P', plates; M, mica;
S, selenium.

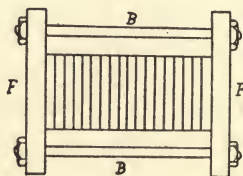

FIG. 53a.

in Fig. 54, the spaces between the turns being filled with prepared selenium. A thin glass cover is sometimes placed over the cell to protect the surface from injury.

A strong light falling upon a cell lowers its resistance, and *vice versa*, the resistance of a cell being at its highest when unexposed to light; the light is apparently absorbed and made to do work by varying the electrical resistance of the selenium. Selenium cells vary very considerably as regards their quality as well as in their electrical resistance, it being possible to obtain cells of the same size for any resistance between 10 and 1,000,000 ohms, and also, a cell may remain in good working condition for several months, while another will become useless in as many weeks.

The ability of a cell to respond to very rapid changes in the illumination to which it is exposed is determined largely upon its inertia, it being taken as a general rule

that the higher the resistance of a cell the less the inertia, and *vice versa*, and also, that the higher the resistance the greater the ratio of sensitiveness. Inertia plays an important part in the working of a cell, slightly opposing the drop in resistance when illuminated, and opposing to a much greater degree the return to normal for no-illumination. The effects of inertia or "lag," as it is termed, can readily be seen by reference to Fig. 55. It will be noticed that the current value rapidly increases when the cell is first illuminated, but

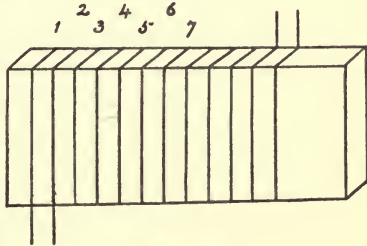

FIG. 54.

if after a short time t the light is cut off, the current value, instead of returning at once to normal for no-illumination, only partially rises owing to the interference of the inertia, and some time elapses before the cell returns to its normal condition; the time varying from a few seconds to several minutes, depending upon the characteristics of the cell and the amount of light to which it is exposed. An actual curve is given in Fig. 55a. The inertia or "lag" of a cell produces upon an intermittent current an effect similar to that produced by the capacity

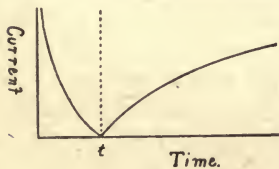

FIG. 55.

of a line, as was noted in Chapter I., preventing the incoming signals from being recorded separately, and distinctly. To obtain the best results in photo-telegraphy, the resistance of a cell should only be decreased to an extent

sufficient to pass the current required to operate the recording apparatus, and the illumination should be regulated so that this condition of the cell takes place.

The comparative slowness of selenium in responding to

any great changes in the illumination offers a serious difficulty to its use in photo-telegraphy, but various methods have been devised whereby the effects of inertia can be counteracted. In the system of De' Bernochi (see Chapter I.) the changes in the illumination are neither very rapid nor very great, and the inertia effects would therefore be very slight; but in any photo-telegraphic system in which a metal line print is used for transmitting, where the source of illumination is constant and the resistance of the cell is required to drop to a definite value and return to normal

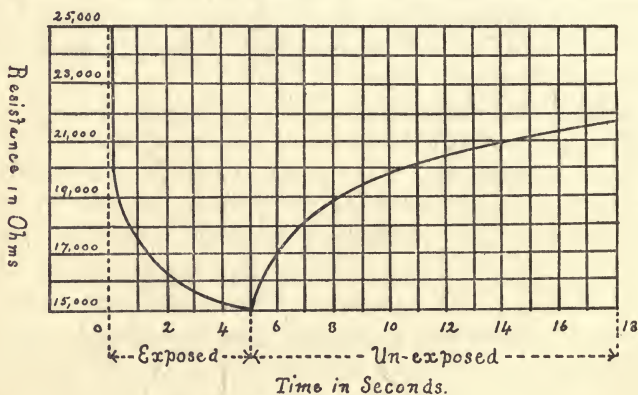

FIG. 55a.

instantly, many times in succession, the inertia effects are very pronounced. The most successful method of counteracting the inertia is that adopted by Professor Korn of always keeping the cell sufficiently illuminated to overcome it, so that any additional light acts very rapidly. Another method worked out and patented by Professor Korn, and known as the "compensating cell" method, gives a practically dead beat action, the resistance returning to its normal condition as soon as the illumination ceases. The arrangement is given in the diagram Fig. 56.

Light from the transmitting or receiving apparatus, as the case may be, falls upon the selenium cell S^1 , which is

placed on one arm of a Wheatstone bridge, a second cell S^2 being placed on the opposite arm. The selenium cell S^1 should have great sensitiveness and small inertia, the compensating cell S^2 having proportionally small sensitiveness and large inertia. Two batteries B, B' , of about 100 volts, are connected as shown, B being provided with a compensating variable resistance W ; W' is also a regulating resistance. When no light is falling upon the cell S^1 , light from L is prevented from reaching the second cell S^2 by a small shutter which is fastened to the strings of the Einthoven galvanometer (described in Chapter III.), and the piece of apparatus C —relay or galvanometer as the case may be—remains in a normal condition. When, however, light falls upon the cell S^1 , the balance of the bridge is upset, and light from L falls a fraction of a second later upon the second cell S^2 , and the current flowing through C completes the circuit. Needless to say it is necessary that the two cells be well matched, as it is very easy to have over-compensation, in which case the current is brought below zero.

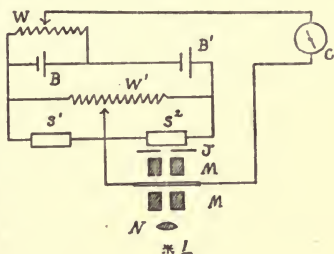

FIG. 56.

It is also stated that by enclosing the cells in exhausted glass tubes, their inertia can be greatly reduced and their life considerably prolonged. The sensitiveness of a cell is the ratio between its resistance in the dark and its resistance when illuminated. The majority of cells have a ratio between 2 : 1 and 3 : 1, but Professor Korn has shown mathematically that by conforming to certain conditions regarding the construction the ratio of sensitiveness may be between 4 : 1 and 5 : 1. Thus a cell of $R = 250,000$ ohms can be reduced to 60,000 ohms from the light of a 16 c.p. lamp placed only a short distance away; the resistance may be still

further decreased by continuing the illumination, but this produces a permanent defect in the cells termed "fatigue," the cells becoming very sluggish in their action and their sensitiveness gradually becoming less, the ratio between their resistance in the dark and their resistance when illuminated being reduced by as much as 30 per cent.

Excessive illumination will also produce similar results. The inertia of a cell is practically unaffected by the wavelength of the light used, but the maximum sensitiveness of a cell is towards the yellow-orange portion of the spectrum.

In addition to light, heat has also been found to vary the electrical resistance of selenium in a very remarkable manner. At 80° C. selenium is a non-conductor, but up to 210° C. the conductivity gradually increases, after which it again diminishes.

APPENDIX B

PREPARING THE METAL PRINTS

ELECTRICIANS who desire to experiment in photo-telegraphy, but who have no knowledge of photography, may perhaps find the following detailed description of preparing the metal prints of some value. The would-be experimenter may feel somewhat alarmed at the amount of work entailed, but once the various operations are thoroughly grasped, and with a little patience and practice, no very great difficulty should be experienced. The simpler photographic operations, such as developing, fixing, etc., cannot be described here, and the beginner is advised to study a good text-book on the subject.

The method to be given of preparing the photographs is practically the only one available for wireless transmission, and although the manner given of preparing is perhaps not strictly professional, having been modified in order to meet the requirements of the ordinary amateur experimenter, the results obtained will be found perfectly satisfactory.

As will have been gathered from Chapter II., the camera used for copying has to have a single line screen placed a certain distance in front of the photographic plate, and the object of this screen is to break the image up into parallel bands, each band varying in width according to the density of the photograph from which it has been prepared. Thus a white portion of the photograph would consist of very narrow lines wide apart, while a dark portion would be made up of wide lines close together; a black part would appear solid and show no lines at all. It is, of course, obvious

that the lines on the negative cannot be wider apart, centre to centre, than the lines of the screen. A good screen distance has been found to be 1 to 64, *i.e.* the diameter of the stop is $\frac{1}{64}$ th of the camera extension, and the distance of the screen lines from the photographic plate is 64 times the size of the screen opening. The following table shows what this distance is for the screen most likely to be used. The line screens used consist of glass plates upon which a number of lines are accurately ruled, the width of the lines and the spaces between being equal; the lines are filled in with an opaque substance. These ruled screens are very

DIAMETER OF STOP USED $\frac{1}{64}$ TH OF CAMERA EXTENSION.

Screen ruling lines per inch.	Actual space in inches.	Distance of screen ruling in inches.	In $\frac{1}{2}$ inches.	In millimetres.
35	$\frac{1}{75}$.91	28.8	21.8
50	$\frac{1}{100}$.64	20.5	16.2
65	$\frac{1}{130}$.49	15.7	12.4

expensive, and are only made to order,¹ a screen half-plate size costing from 21s. to 27s. 6d. An efficient substitute for a ruled screen can be made by taking a rather large sheet of Bristol board and ruling lines across in pure black drawing ink, the width of the lines and the spaces between being $\frac{1}{12}$ th of an inch respectively. A photograph must be taken of this card, the reduction in size determining the number of lines to the inch. A card 20×15 inches, with 12 lines to the inch, would, if reduced to 5×4 inches, make a screen having 48 lines to the inch. Preparing the board is rather a tedious operation, but the line negative produced will be found to give results almost as good as those obtained from a purchased screen.

As it is impossible for many to have the use of professional apparatus designed for this particular kind of work,

¹ Line screens can be obtained from Messrs. Penrose, 109 Farringdon Street, London; or Messrs. Fallowfield, 146 Charing Cross Road, London.

the fixing of the screen into an ordinary camera must be left to the ingenuity of the worker. A half-plate back focussing camera will be found suitable for general experimental work, but if this is not available, a large box camera can be pressed into service.

The writer has never seen a half-plate box camera, but one taking a 5×4 inch plate can be obtained second-hand very cheaply. It is a comparatively simple matter to fix the line screen into a camera of this description, the drawings Figs. 57 and 58 showing the method adopted by the writer. The two clips

D, made from fairly stout brass about $\frac{1}{2}$ inch wide, are bent to the shape shown (an enlarged section is given at C) and soldered at the top and bottom of one of the metal sheaths provided for holding the plates. The distance between the front of the photographic plate (the film side) and the back of the line screen (also the film side), indicated

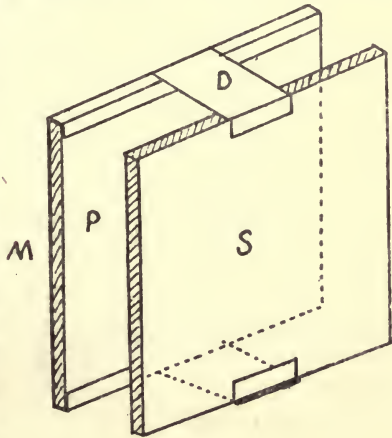

FIG. 57.

by the arrow at A, is determined by the number of lines on the screen. As will be seen from the table given, the distance for a screen having 50 lines to the inch will be $\frac{41}{64}$ ths of an inch.

In all probability there will be enough clearance between the top of the sheath and the top of the camera to allow for the thickness of the clip, but if not, a shallow groove a little wider than the clip should be carefully cut in the top of the camera, so that it will slide in easily. The screen should be placed between the clips, the film side on the

inside, *i.e.* facing the photographic plate. As with a box camera the extension is a fixture, the size of stop to be used is a fixture also. The extension of a camera (this term really applies to a bellows camera) is measured from the front of the photographic plate to the diaphragm, and

if this distance in our camera is 8 inches, then the diameter of the stop to give the best results would be $\frac{1}{64}$ th of this, or $\frac{1}{8}$ th inch. Although for all ordinary experimental work the lens fitted to the camera will be suitable, the best type of lens for process work of all kinds is the "Anastigmat."

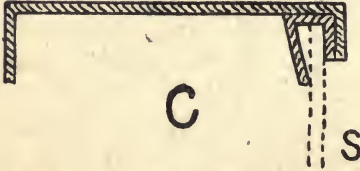
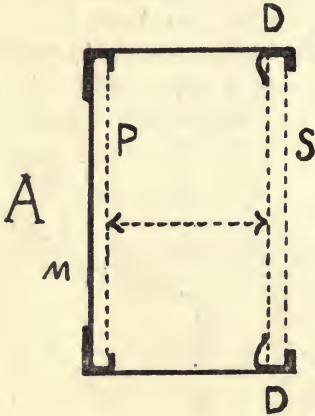

FIG. 58.

M, sheath; P, photographic plate; D, clips; S, line screen.

The picture or photograph from which it is desired to make a print should be fastened out perfectly flat upon a board with drawing pins, and if a copying stand is not available it must be placed upright in some convenient position.

The diagram Fig. 59 gives the disposition of

the apparatus required for copying. A simple and inexpensive copying stand is shown in Fig. 60. The black-board A should be about 30 inches square, and must be fastened perfectly upright upon the base-board B. The stand C should be made so that it slides without any side play between the guides D, and should be of such a height that the lens of the camera comes exactly opposite the

centre of the board A. The camera, if of the box type, can be secured to the stand by means of a screw and wing-nut, the screw being passed from the inside as shown. The

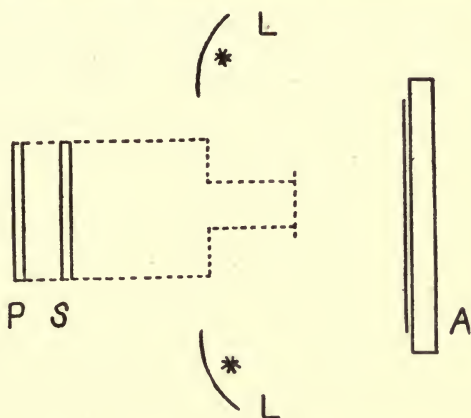

FIG. 59.

L, L, lamps ; A, board with picture ; S, line screen ; P, photographic plate.

beginner is advised to photograph only very bold and simple subjects, such as black and white drawings or enlargements. It is not safe to trust to the view-finders as to whether the whole of the picture is included on the plate, a piece of ground glass the same size as the plate sheaths,

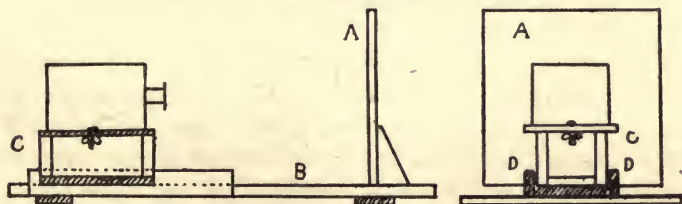

FIG. 60.

and used as a focussing screen, being much more reliable. It is a good plan to focus the camera for a number of different-sized pictures, marking the board A, and the

guides D, so that adjustment is afterwards a very simple matter.

The make of plate used is also a great factor in getting a good negative, and Wratten Process Plates will be found excellent. As already mentioned, such subjects as the exposure and the development of the plate cannot be dealt with here, these subjects having been exhaustively treated in several text-books on photography. With an arc lamp the exposure is about twice as long as in daylight, but the exposure varies with the amount of light admitted to the plate, character of the source of light, and the sensitiveness of the plate used, etc. The writer has used acetylene gas lamps for this purpose with great success. The beginner is advised to use artificial light, as this can be kept perfectly even. With daylight, however, the light is constantly fluctuating, and this renders the use of an actinometer a necessity for correct exposure. After development, if the plate is required for immediate use, it can be quickly dried by soaking for a few minutes in methylated spirit.

Having obtained a good negative, the next operation is to prepare what is known as a metal print. For this we shall require some stout tin-foil or lead-foil, about 12 or 15 square feet to the pound, and this should be cut into pieces of such a size that it allows a lap of $\frac{3}{16}$ inch when wrapped round the drum of the transmitting machine. Obtain some good fish-glue and add a saturated solution of bichromate of potash in the proportion of 4 parts of potash to 40 or 50 parts of glue. Pour a little of this glue into a shallow dish, lay a sheet of foil upon a flat board, and with a fairly stiff brush (a flat hog's-hair as wide as possible) proceed to coat the sheet of foil with a thin but perfectly even coating of glue. The thickness of the coating can only be found by trial, for if the coating is too thick a longer time will be required for printing; but it must not be thin enough to show interference colours. After the coating has been laid on, a soft brush, such as photographers use for dusting dry

plates, should be passed up and down, and across and across, with light, even strokes to remove any unevenness. A glue solution used by professional photo-engravers is as follows :

Fish-glue	12 oz.
Bichromate of Ammonia	$\frac{3}{4}$ oz.
Water	18 to 24 oz.
Ammonia '880	30 minims.

The bichromate should be dissolved in the water, and, when added to the glue, stir very thoroughly in order that complete mixing may take place. The coating may be done in a good light, not bright sunlight, *but it must be dried in the dark*, because, although insensitive while in a moist condition, it becomes sensitive immediately on desiccation. If allowed to dry in the light the whole coating will become insoluble, and for this reason the brushes used should be washed out as soon as they are finished with. The sheets will take about 15 minutes to dry in a perfectly dry room, but it is not advisable to prepare many sheets at once, as they will not keep for more than two or three days.

The prepared negative must now be placed in an ordinary printing frame, and a print taken off upon one of the metal sheets in the same way as a print is taken off upon ordinary sensitised paper. In daylight the exposure varies from 5 to 20 minutes, but in artificial light various trials will have to be made in order to get the best results, the exposure varying with the amount of bichromate in the coating; the proportion of the bichromate to the glue should remain about 6 per cent. Light from a 25 ampere arc lamp for 2 to 5 minutes, at a distance of 18 inches, will generally suffice to "print" the impression on the metal sheets. The printing finished, the metal print should be laid upon a sheet of glass and held under a running stream of water. The washing is complete as soon as the unexposed parts of the glue coating have been entirely washed away leaving the bare metal, and this will take anything from 3 to 7

minutes, depending upon the thickness of the film. As soon as it is dry the print is ready for use.

As already mentioned, the negative from which the metal print is made requires that the lines be perfectly sharp and opaque, and the spaces between perfectly transparent. Ordinary dry plates are too rapid, a rather slow plate being required. Wratten Process Plates give excellent results, and the following is a good developer to use with them :

Glycin	15 grammes	1 oz.
Sulphite of Soda	40 "	2½ "
Carbonate of Potash	80 "	5 "
Water	1000 c.c.	60 "

This developer should be used for 6 minutes at a temperature of 50° F., 3½ minutes at 65°, and 1¾ minutes at 80°. It is best only used once. If an intensifier is required, the following formula will be found to give satisfactory results :

Bichloride of Mercury	1 oz.	60 grammes.
Hot Water	16 "	1000 c.c.

Allow to cool, completely pour off from any crystals, and add :

Hydrochloric Acid	30 minims	4 c.c.
-----------------------------	-----------	--------

Allow negative to bleach thoroughly, wash well in water, and blacken in 10 per cent ammonia '880, or 5 per cent sodium sulphide.

In preparing the negatives and metal prints the following points should be observed :

A good negative should have the lines perfectly sharp and opaque ; there should be no " fluff " between the lines even when they are close together.

A properly exposed and developed negative should not require any reducing or intensifying.

If the lamps used for illuminating the copying-board are placed 2 feet away, and the exposure required is 5 minutes, the exposure, if the lamps are placed 4 feet away, will be

20 minutes, as the amount of light which falls upon an object decreases as the inverse square of the distance.

Get the coating on the foil as thin as possible, and err on the side of over-exposure, for if the coating is thick and has been under-exposed, excessive washing will dissolve the whole coating; for, unless insolubilisation has taken place right up to the metal base, the under parts will remain in a more or less soluble condition.

On no account must the unexposed sheets be placed near a fire, otherwise they will be spoilt, the whole coating becoming insoluble; heat acting in the same manner as light.

In washing, keep the print moving so that the stream of water does not fall continually in one place. It is best to hold the print so that the water runs off in the direction of the lines.

To dry the prints after washing they can be laid out flat in a moderately warm oven, or before a stove, the heat of course not being sufficient to cause the coating to peel.

To render the glue image more distinct the print should be immersed for a few seconds in an aniline dye solution, the glue taking up the colour readily. These dyes are soluble in either water or alcohol. A dye known as "magenta" is very good.

The process of coating the metal sheets must be performed as quickly as possible (about 10 seconds), as owing to the peculiar nature of the bichromated glue it soon sets, and once this has taken place it is impossible to smooth down any unevenness.

See that the negative and metal sheet make good contact while printing.

If the glue solution does not adhere to the surface of the foil in a perfectly even film, but assumes a streaky appearance, a little liquid ammonia, or a weak solution of nitric acid, rubbed over the surface of the foil, which is afterwards gently scoured with precipitated chalk on a tuft of cotton

wool, will remove the grease which is the cause of the difficulty.

A photograph of a picture prepared from a line negative is given in Fig. 61. For a great many experiments, and in order to save time, trouble, and expense, sketches drawn upon stout lead-foil in an insulating ink will answer the purpose admirably, but if any exact work is to be done a single line print is of course absolutely necessary. The insulating ink can be prepared by dissolving shellac in methylated spirit, or ordinary gum can be used. A very fine brush should be used in place of a pen, as the gum will not flow freely from an ordinary nib unless greater pressure than the foil will safely stand be applied. A sketch prepared in this manner is shown in Fig. 62. A little aniline dye should be added to the gum to render it more visible, or a mixture of gum and liquid indian ink will be found suitable.

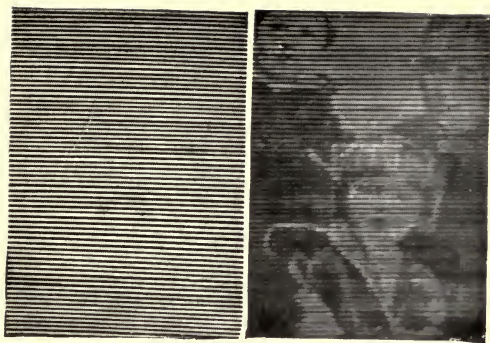

FIG. 61.

Portions of photographs (full size) of single line screen, and single line print. Screen 40 lines to the inch.



FIG. 62.

INDEX

- Accuracy of working, 70, 72
Acetylene gas lamps, 110
Actinometer, 110
Alternating current, 82
Ammonia, 113
Angle of stylus, 24, 78
Aniline dye, 113
Arcing, 27, 82
Arc lamps, 15, 110, 111
Atmospherics, 61, 85
- Belin, 47
Bernochi, 7, 102
 system of, 7, 34
Berzelius, 99
Bichromate of potash, 110
Blondel's oscillograph, 47
- Camera extension, 106, 108
 choice of, 107
Capacity of condenser, 24, 78
 electrostatic, 3, 5
 of cable, 3
 of London-Paris telephone line, 3
Carbon bisulphide, 53
Charbonelle, 48
 receiver of, 48
Chemical solution, 56
Circuit breaker, 76
Clutch, details of, 88, 89, 91
 spring, 71
Coating the metal sheets, 110
Coherer, 11, 40
Collecting rings, 91
Commercial value of photo-tele-
 graphy, 1
Compensating selenium cell, 102
Contact breaker, 37
- Copying arrangements, 108
Cross screen, 21
- De' Arsonval galvanometer, 47,
 73
Decoherer, 41
Design of machines, 21
Detectors, 83
Developing solutions, 112
Diaphragm, movement of, 48, 52,
 84, 87
Dipping rods, 81, 83
Distance of transmission, 33
Duration of wave-trains, 23, 25
- Early experiments, 2
Einthoven galvanometer, 32, 44,
 45, 54, 103
Electric clock, 93
Electrolysis, 58, 59
Electrolytic receiver, 4, 37, 54, 61,
 64
Experimental machine, 20
Extraneous light, 47
- Fastening electrolytic paper, 58
Fatigue of selenium cell, 64, 104
Fish glue, 110
Flexible couplings, 77
Frequency meter, 65
Friction brake, 88
- High speed telegraphy, 70
Hughes governor, 65
Hughes printing telegraph, 63
- Inertia, 64, 65, 101
 effects in photo-telegraphy, 100

- Inertia, method of counteracting,
102, 103
effect of wave-length of light on,
104
- Intensifying solution, 112
- Isochroniser, 89, 91
details of, 91, 92, 95
- Isochronism, 64, 69, 70, 71
- Kathode rays, 53
- Knudsen, 2
apparatus of, 9
- Korn, 30, 33, 45, 65, 72
apparatus of, 31
- Lamps, coloured, 94
- Lenses, 85
principal focus of, 38
- Light, diffusion of, 86
extraneous, 87
- Limit of error in synchronising, 64
- Line balancer, 3
- Line screens, 9, 15, 16, 106
making, 106
- Marconi valve, 44, 54
coherer, 40
- Mechanical inertia, 33
- Mercury break, 81
churning of, 82
containers, 82
- Mercury jet interrupter, 29
- Metal prints, 15, 18, 32, 59, 64, 95,
110, 114
drying the, 111, 113
exposure of, 111
size of, 22, 24, 75, 77
pressing the, 22
- Military uses, 35
- Mirror galvanometer, 9, 42, 73
- Mirror, 47, 51
- Morse Code, 35
- Motor speed, 89, 95
driving, 91, 93, 95
clockwork, 63
electric, 63
- Nernst lamps, 43, 85
- Nicol prism, 53
- Paper for electrolytic receiver, 56
- Parabolic reflector, 8
- Period of galvanometer, 43, 44, 46
- Photographic films, 40, 43, 45, 53,
54, 62, 85, 86, 98
process, 37
plates, orthochromatic, 59
plates, 110
- Points to be observed in preparing
metal prints, 113
- Poulsen Company, 32, 47
arc, 31
- Preparing selenium, 99
photographs for transmitting,
15, 105
sketches on metal foil, 114
- Process plates, 112
- Radio-photography, requirements
of, 74
advantages of, 6, 35
- Relay, 25, 39, 49, 53, 55, 60, 75
differential, 79
polarised, 97
working speed of, 26, 75
- Reproducing for newspapers, 60
- Resistance of selenium, 99
of selenium cells, 100
regulating, 103
- Retardation of current, 6
- Retouching, 62
- Rotary spark-gap, 28
- Selenium, 99
cells, 8, 34, 55, 60, 64, 99, 100
machines, 45
- Self-induction, 24, 78
- Sensitiveness of selenium cells, 103
ratio of, 103
- Silvered quartz thread, 44, 46
- Spark-gap, 27
- Speed regulator, 68
adjustment of, 69
- Spring clutch, 71
- Starting position of machines, 98
- String galvanometer, 32
- Stylus, 17, 18, 57, 61, 78, 95
parking at, 24
angle of, 24, 78
defects of, 57
- Submarine cable, 4
- Synchronism, 11, 20, 36, 64, 69, 71

- Telephograph, 74
 advantages of, 76
 method of working, 96
- Telephone receiver, 83, 85
 diaphragm, 48
 receiver, improved, 51
- Telephone relay, 48, 50, 52, 83, 85,
 97
- Thermodetector, 32
- Tow, 88
- Transmission, distance of, 35, 72
 speed of, 25, 35, 75
- Vibration, natural period of, 39
- Waves, damped, 30
 undamped, 30, 31
- Wheatstone bridge, 103
- Wireless apparatus, 13
- Wireless World*, 31

THE END



PUBLICATIONS OF THE WIRELESS PRESS, LIMITED

The Elementary Principles of Wireless Telegraphy

By R. D. BANGAY.

Crown 8vo.

1/- NETT

160 *pages.*

Specially prepared to provide the beginner with a thorough understanding of the first stages of Wireless before studying the advanced text-books.

Handbook of Technical Instruction for Wireless Telegraphists

By J. C. HAWKHEAD AND H. M. DOWSETT, A.M.I.E.E.

Demy 8vo.

SECOND EDITION, EXTENSIVELY
REVISED AND ENLARGED.

344 *pages.*
240 *Diagrams*
and *Illustrations.*

A Complete Course for the Postmaster-General's Examination.

The Wireless Telegraphist's Pocket Book of Notes, Formulae and Calculations

By J. A. FLEMING, M.A., D.Sc., F.R.S., M.Inst.E.E., ETC.

352 *pages, size 4½ × 7½.*

6/- NETT

Roan Binding.

The Year-Book of Wireless Telegraphy and Telephony

This important Work of Reference contains:—

A unique collection of all the Laws and Regulations relating to Wireless Telegraphy throughout the World.

A Complete Alphabetical List of Land and Ship Stations with their call letters.

A Glossary of Technical Terms printed in Five Languages.

Map of the Wireless Stations of the World, giving location of over 700 Stations.

International Time Signal Regulations. Together with a vast amount of exclusive information upon technical subjects.

900 *pages.*

PRICE **3s. 6d.** NETT

Illustrated.

Postage: United Kingdom, 6d. extra; Abroad, 1s. 4d.

THE WIRELESS PRESS, LIMITED

MARCONI HOUSE, STRAND, LONDON, W.C.

'The Wireless World'

PRICE

6^D

PUBLISHED MONTHLY.

PRICE

6^D

A Magazine for all interested in
Wireless Telegraphy



The Leading Features month by month are :

Technical Articles by Prominent Experts.

Wireless Stations and Services in Foreign
Climes.

Instructional Articles.

Portraits and Biographies of Celebrities in
the World of Wireless.

Answers to Readers' Queries.

Operators' Experiences.



PUBLISHED FIRST OF EACH MONTH,

And obtainable from all Newsagents.



Annual Subscriptions :

English or Foreign Address, 8s.

Canada \$2.

Single Copies, 9d. post free.

THE WIRELESS PRESS, LTD.

MARCONI HOUSE, STRAND, LONDON, W.C.

RETURN TO the circulation desk of any
University of California Library

or to the

NORTHERN REGIONAL LIBRARY FACILITY
Bldg. 400, Richmond Field Station
University of California
Richmond, CA 94804-4698

ALL BOOKS MAY BE RECALLED AFTER 7 DAYS

- 2-month loans may be renewed by calling
(510)642-6753
- 1-year loans may be recharged by bringing
books to NRLF
- Renewals and recharges may be made
4 days prior to due date

DUE AS STAMPED BELOW

SENT ON ILL

JUL 30 2004

U. C. BERKELEY

TK6600

M3

358340

Martin

UNIVERSITY OF CALIFORNIA LIBRARY

