

THE WOODWORKER SERIES

WOODWORK
JOINTS



Class TT180

Book .W6

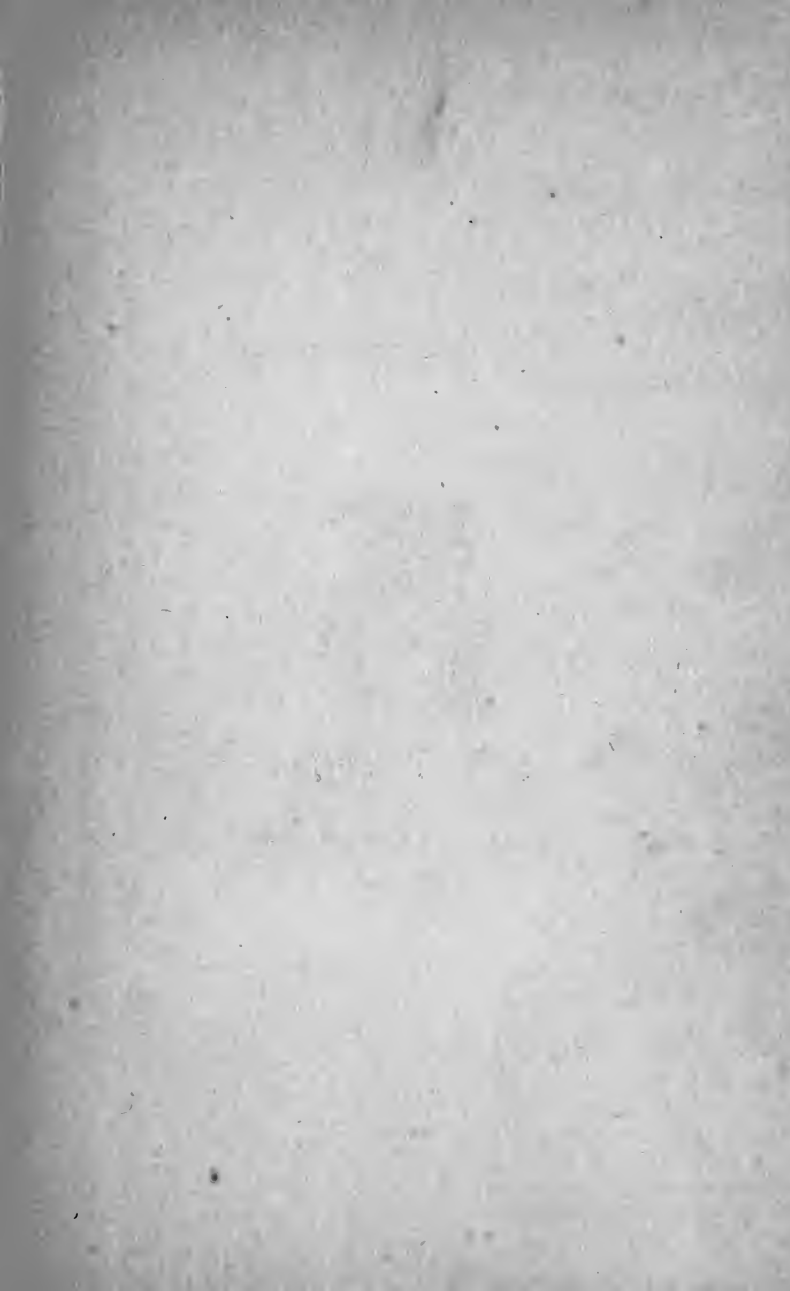

THE UNIVERSITY OF CHICAGO

WOODWORK JOINTS

THE WOODWORKER SERIES

CARPENTRY FOR BEGINNERS

POLISHING AND STAINING

WOODWORK JOINTS

FRETWORK

THE WOODWORKER SERIES

WOODWORK " JOINTS

HOW THEY ARE SET OUT, HOW MADE AND
WHERE USED; WITH FOUR HUNDRED AND
THIRTY ILLUSTRATIONS AND A COMPLETE
INDEX OF ELEVEN HUNDRED REFERENCES

William Fairbank - Author



PHILADELPHIA AND LONDON
J. B. LIPPINCOTT COMPANY

TT180
.W6

295596

22



PRINTED BY J. B. LIPPINCOTT COMPANY
AT THE WASHINGTON SQUARE PRESS
PHILADELPHIA, U. S. A.

22-26119

6. 95. B. Feb. 10. 22

FOREWORD

THE principal aim of this Volume is to provide the woodworker with full information as to the uses, and clear practical directions as to the making, of every joint he may at any time be likely to encounter. Those of us whose occupation or recreation is wood-working are familiar with numerous joints which we make and use in our own way. It is possible, however, that there are many which we do not make *well*, not because we lack skill or care, but because we are unfamiliar with some simple rule which governs either the setting out or the method of using the tool; whilst probably there are many others which might suit our purpose better, but which we neglect because their existence has never occurred to us.

To be successful in woodwork construction the possession of two secrets is essential—to know the right joint to use, and to know how to make that joint in the right way. The woodwork structure or the piece of cabinet-work that endures is the one on which skilful hands have combined to carry out what the constructive mind planned. And it is just here that the present Volume will help, not alone the beginner who wishes preliminary instruction, but also the expert who desires guidance over ground hitherto unexplored by him.

The Table of Contents—and more particularly the exhaustive Index at the end of Volume—will show that practically every joint in cabinet-work and ordinary joinery is dealt with. In the case of the Bridle Joint, the Halved Joint, the Mortise and Tenon

FOREWORD

Joint, and the Dovetail Joint, the actual tool operations—setting out, gauging, marking, sawing, chiselling, paring, etc.—are fully explained; and the fact that nearly sixty illustrations are devoted to the subject of Dovetailing is but one indication of the care which has been taken in making the directions clear and complete. As the methods of working are almost similar in the case of other joints, it has not of course been deemed necessary to repeat these detailed instructions in every chapter.

In the preparation of the Volume the Publishers have secured the services of Mr. William Fairham, by whom most of the chapters have been written and illustrated. Although intended for the practical man, and not professing to be a graded course of "educational woodwork," the Volume is one which Manual Training Instructors will find of the greatest value in conducting woodwork classes. No book hitherto published contains such a variety of illustrations of joints, almost all of which will form suitable exercises of practical educational importance in a Manual Training course.

In conjunction with the other Volumes in *The Woodworker Series* ("Details of Cabinet Construction," "Staining and Polishing," etc.), this Volume, it is hoped, will leave the woodworker in possession of a store of information which, associated with his own practical knowledge and skilled experience, will enable him—if he so pleases—to reach to the highest and most advanced branches of his craft.

J. C. S. BROUGH.

CONTENTS

COMPLETE INDEX, with full references to joints, tools, materials, accessories, etc., is provided on pages 201—214.

	PAGE
THE GLUED JOINT	I
Glueing—Hints on Jointing—Applications of the Glued Joint.	
THE HALVED JOINT	11
Various Halved Joints—Tee, oblique, mitred, dovetailed, and crosshalving—Applications of the Halved Joint—Setting Out—Sawing—Paring.	
THE BRIDLE JOINT	27
Various Bridle Joints—Setting Out and Marking—Sawing—Chiselling.	
THE TONGUED AND GROOVED JOINT	39
Flooring — Matchboarding—Tongues—Applications of the Joint—Corner Joints—Ploughing—Tongueing—Planes.	
THE MORTISE AND TENON JOINT	53
Barefaced Tenons—Haunched Tenons—Shouldered Tenons—Other Joints, with Applications—Setting Out—Sawing the Tenons—Cutting the Mortises.	
THE DOWELLING JOINT	77
Making Dowels—Dowelling—Various Applications of the Dowelled Joint.	
THE SCARF JOINT	89
Half Lap Scarf Joints—Dovetailed Joints—Tenoned Joints—Fished Joints.	
THE HINGED JOINT	93
Alignment — Gauging — Sawing and Paring — Various Types of Hinges—Inside and Outside Hanging—Hingeing Draught Screens—Various Hinged Joints.	
SHUTTING JOINTS	111
Cupboard Door Joints—Astragals—Various Joints.	

CONTENTS (*Continued*)

	PAGE
THE DOVETAIL JOINT	117
Through Dovetailing—Lap Dovetailing—Dovetailing Drawers—Variations of the Dovetail Joint—Dovetail Keying—Applications of the Dovetail Joint—Setting Out and Marking—Sawing—Chiselling—Paring.	
DOVETAIL GROOVING	145
JOINTS FOR CURVED WORK	149
Circular Framing—Lamination.	
MISCELLANEOUS JOINTS	153
Weather Boards—Ladders—Cornice Poles—Rustic Work—Patera Screw Covers—Veneer Keying—Pelleting—Jointing Turned Work—Castor Pins—Crush Feet—Tee Slide Joints—Pocket Screwing—Glue Blocking—Notched, Cogged, and Saddle Joints—Roll-top Desk Joints—Birdsmouth Joints—Scribing Joints—Butt Jointing—Buttoning—Wall Plugs—Slot Screwing—Housing—Bookcase Shelf Joints—Battening—Dovetail Keying—Coopered Joints—Wedged Frame Joints—Corrugated Steel Fasteners, etc.	
THE MITRED JOINT	177
How to find Angles for Straight and Curved Mitres—Mitreing.	
PUZZLE JOINTS	187
Chinese and Other Eastern Puzzle Joints—Dovetail Puzzle Joints.	
INDEX, with Eleven Hundred References	201
THE ART OF WOODWORKING	215

THE GLUED JOINT

THE glued joint in its various forms is in use in every country in the world, and is frequently met with in mummy cases and other examples of ancient wood-work. Alternative names under which it is known are the butt joint, the rubbed joint, the slipped joint, whilst in certain localities it is known as the slaped (pronounced *slayped*) joint.

The Glued Joint is made by planing two pieces of timber so that when placed together they are in contact with each other at every point; they are then usually united with glue. Fig. 1 shows a sketch of a butt joint in its simplest form. In Fig. 6 is shown the method of holding the joint whilst being glued; the upright portion is held rigid in the bench vice, thus leaving the left hand to hold the piece which is to be jointed, whilst the right hand operates the glue brush. The pieces of wood which form a butt joint may be glued together with or without the aid of cramps or artificial pressure. If the joint is to be made without cramping, the two surfaces of the timber are warmed so as not to chill the glue. The surfaces are then glued and put together and rubbed backwards and forwards so as to get rid of the superfluous glue. This rubbing is continued three or four times until the joint begins to adhere. Care must be taken that the boards are in their correct relation to each other. They are then put aside to dry.

GLUEING.

The better the glue penetrates into the pores of the wood, the stronger the joint will be; for this reason timber of the loose-fibred variety, such as pine, etc., will hold up at the joint better than hardwoods like teak and rosewood. The

Joints in Woodwork

glue used for jointing should be neither too thick nor too thin ; the consistency of cream will be found suitable for most purposes. It should be nice and hot, and be rapidly spread over the surface of the wood.

If light-coloured woods, such as pine, satin-wood, sycamore, etc., have to be jointed, a little flake white should be procured and mixed into the liquid glue. This will have no detrimental effect on its adhesive qualities, and it will prevent the glue showing a thin black line on the joint. An alternate method which answers well on ordinary work is to rub the joint with a piece of chalk and wipe the surplus amount away previous to glueing.

Broad surfaces of close-grained hardwood, which generally present a shiny surface to the eye, are usually carefully roughened with a fine toothing plane blade previous to glueing.

Supporting the Joint.—The jointed boards should not be reared up against a “ bench leg ” or wall without having any support in the centre, as dotted line at Fig. 5, because in all probability they will fracture before the glue has time to set ; and, when we go to take them up to renew working operations, we shall be annoyed to find that they have assumed a position similar to that shown at Fig. 5, and this will, of course, necessitate re-jointing.

A correct method to adopt is shown at Fig. 4. Here we have supported the joint by rearing up against the wall a couple of pieces of batten, one at each end of the board, thus supporting it throughout its entire width until the glue is thoroughly set. The two or more pieces of timber in a butt joint adhere by crystallisation of the glue and atmospheric pressure. A well-fitted joint made with good quality glue is so strong that, when boards of three feet and upwards are jointed together by this method, the timber in most cases will break with the grain sooner than part at the joint.

Butt joints may be cramped up, if desired, and it is customary to warm them as previously stated. In the

The Glued Joint.

absence of the usual iron clamp, the amateur may make an excellent wooden arrangement as shown in Fig. 21. This can be made out of any odd pieces of timber that happen

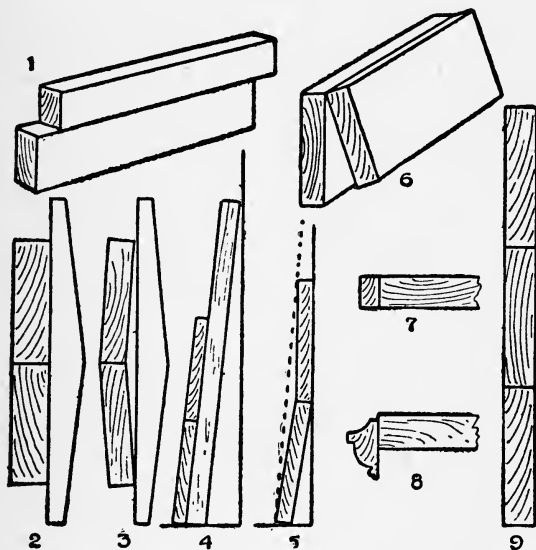

Fig. 1.—Simplest form of glued joint.

Figs. 2 and 3.—Testing the jointed board with a straight edge.

Fig. 4.—Supporting a glued joint.

Fig. 5.—Showing the result of want of support.

Fig. 6.—Holding the joint whilst glueing.

Fig. 7.—Shelf slip-glued with hardwood.

Fig. 8.—Moulding glued on shelf.

Fig. 9.—Boards arranged with grain alternating.

to be handy. Two blocks of hardwood are screwed on the base board at a suitable distance for the work in hand; the boards to be jointed are glued and placed in position between the blocks; and the two hardwood wedges are

Joints in Woodwork

inserted and hammered in opposite directions to each other, thus exerting the desired pressure.

HINTS ON JOINTING.

When jointing, care should be taken to first plane up the boards true on one side—*i.e.*, take them out of winding. The method of testing for this is shown at Fig. 23, and it may with advantage be used when jointing the edges of the boards. Two laths or strips of wood are planed up to exactly the same width, having their edges straight and parallel. One edge of each lath may, if desired, be bevelled a little. The method of using these “twist sticks” or “winding laths” is to put them on the board as shown at Fig. 23, and sight along their top edges. The winding laths, being much longer than the width of the board, show up the irregularity greatly pronounced.

The Tools generally used for making the butt joints are:—

The jack plane, for roughing the edges, etc.

The wooden trying plane (or iron jointing plane) for trueing up the work.

The set square for testing purposes.

The winding laths and straight edge.

The Method of Work is as follows: Each board is in turn put in the vice and planed straight lengthwise; it is then tested with winding laths and a set square (the latter method is shown at Fig. 20).

The boards are then put on the top of one another as at Fig. 2 and tested with a straight edge; they should appear true as shown at Fig. 2; if they show faulty as at Fig. 3 the joints must be again fitted until the required degree of accuracy is obtained. Difficulties may be avoided by care in selecting timber suitable for jointing, and it must be remembered that timber shrinks circumferentially (the heart side becoming round) as Fig. 24. If the timber

The Glued Joint

be jointed with all the heart side one way as at Fig. 24, the tendency will be for it to cast as shown by the single line. If the timber be alternated as at Fig. 25, the tendency will be to cast wavy, whereas if quartered timber can be obtained it will stand practically straight as the tendency to shrink

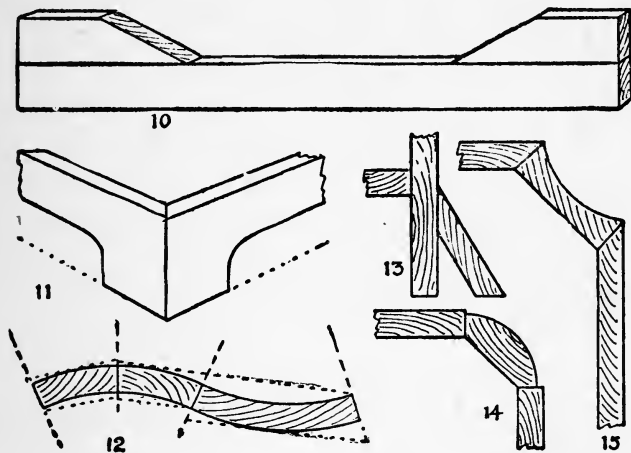

- Fig. 10.—Carcase wing pieces glued.
Fig. 11.—Angle butt joint.
Fig. 12.—Jointing ogee-shaped panel.
Fig. 13.—Timber jointed at 90° and 30° angles.
Fig. 14.—Quarter circle jointing.
Fig. 15.—Hollow corner jointing.

is in thickness only. The grain of quartered timber is shown in Fig. 26.

Judgment should also be exercised to avoid jointing in which one piece of timber is wild and large in the grain, and the adjoining piece of a mild-grained nature. Jointed boards should always be glued up with the grain running in the same direction if possible; this we show at Fig. 27, and nothing looks worse than a dressing chest end, or

Joints in Woodwork

similar piece of work, in which the grain runs haphazard. When jointing thin timber (say, $\frac{1}{4}$ in., $\frac{3}{8}$ in., $\frac{1}{2}$ in., and $\frac{5}{8}$ in. boards) the best method is to use a shooting board. It must be noted, however, that a shooting board and plane practically never give a true right angle, owing to wear and the grinding of the blade. Therefore, the boards *should not* all be laid with the "face mark," on the shooting board whilst the edges are shot, because any inequality would be multiplied by the number of pieces jointed. A better method is to alternate the boards, face side up, then face side down, whilst shooting the edges; this will prevent convexity or concavity on the face of the jointed board, because any slight error in the angle is neutralised (see Fig. 9).

APPLICATIONS OF THE GLUED JOINT.

Our other sketches show various applications of the butt or glued joint as follows:—

Fig. 7 shows a mahogany or other choice wood slip-glued on the edge of a cheaper wood, such as pine or whitewood, as is the case on bookcase shelves when only the front edge is seen and polished.

Fig. 8 shows a moulding glued on a shelf, both mould and shelf in this instance being of polished hardwood. A shelf of this type would be used as the top shelf across a recess in a dining-room. The object of the moulding is to hide a small $\frac{3}{8}$ -in. iron rod which would carry the curtain rings and heading of the curtain which covers the recess. The shelf would be fixed about 3 ft. 9 ins. to 4 ft. 3 ins. from the floor.

Fig. 10 shows the wing pieces glued on the top bearer of carcase work. The application of this bearer in its position will be shown in the chapter on Dovetailing.

Fig. 11 shows a butt joint planed at an angle of 45° (commonly called a mitre), used for box feet, etc.

Fig. 12 shows jointing up of an ogee-shaped panel. The

The Glued Joint

dotted lines indicate the thickness of the timber previous to its being worked up to the finished shape. Bow-fronted and semi-circular panels are jointed in a similar manner.

Fig. 13 shows timber jointed at right angles to the upright piece, and at an angle of 30 degrees.

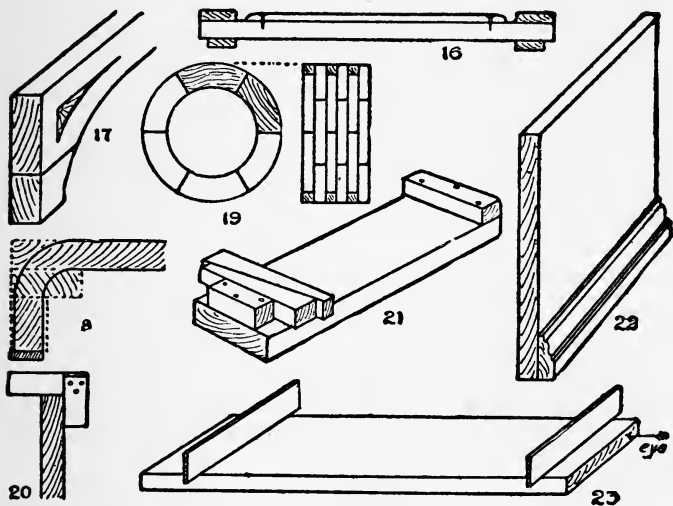

- Fig. 16.—Lining-up a glass frame.
- Fig. 17.—Jointing a shaped spandrel.
- Fig. 18.—Building up case of piano fall.
- Fig. 19.—Laminated work.
- Fig. 20.—Testing with square.
- Fig. 21.—Cramping arrangement.
- Fig. 22.—Glueing ploughslip to drawer.
- Fig. 23.—Test for winding.

Fig. 14 shows quarter-circle jointing, as used in round-cornered chests of drawers, wardrobes, cupboards, etc.

Fig. 15 is similar to Fig. 14, but with hollow corners (or coves).

Fig. 16 gives the plan of a glass frame, showing pilasters

Joints in Woodwork

at the front and the lining-up pieces at the back. The object of the latter is so that the glass will stand clear of the wall. The lining up pieces will of course bed to the wall, preventing an accumulation of dust and dirt, and the loss of small articles such as papers and letters, as frequently occurs when overmantel glasses, etc., are not lined up.

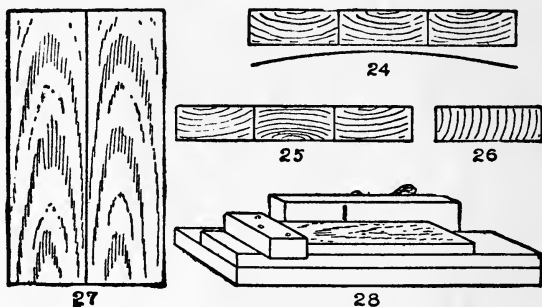

- Fig. 24.—Showing heart side one way.
Fig. 25.—Showing heart side alternated.
Fig. 26.—Grain of quartered timber.
Fig. 27.—Showing uniformity of grain.
Fig. 28.—Jointing with shooting board and try plane.

Fig. 17 shows the jointing up of a shaped spandrel to the required width. In a case of this description suitably grained and coloured wood should be selected, otherwise the bad match will at once draw attention to the joint.

Fig. 18 shows the application of butt or glued jointing to the building up of the core of a piano fall previous to shaping up and veneering.

Fig. 19.—Laminated work—the building up of circular rims for cabinet and joinery work. Plan and elevation show rim pattern of a pulley as used in the pattern-making trade.

Fig. 22.—The glueing of a ploughslip to a drawer side, the ploughslip being used to carry the drawer bottom.

The Glued Joint

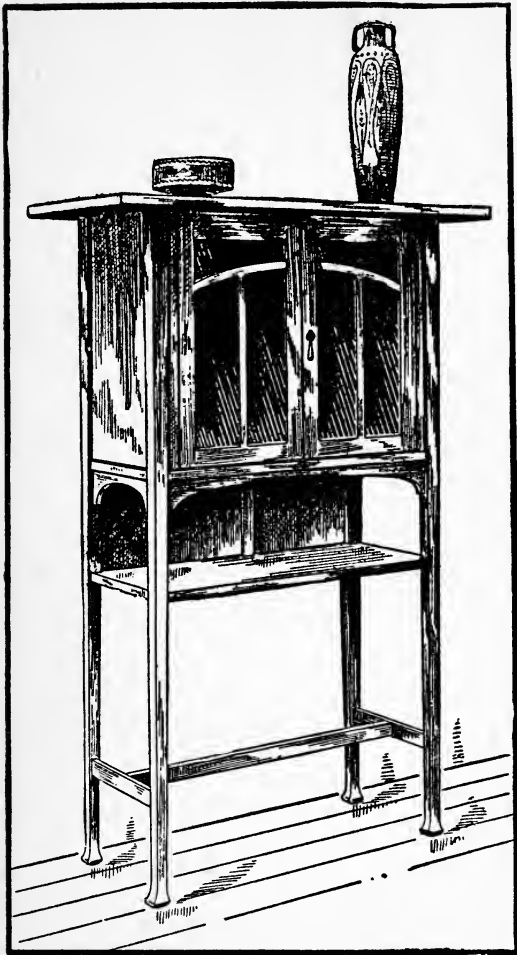

Display Cabinet. (The top will be glue-jointed.)

Joints in Woodwork

Fig. 28 shows the method of jointing with shooting board and trying plane ; the right hand operates the plane whilst the left hand holds the wood firm upon the shooting board.

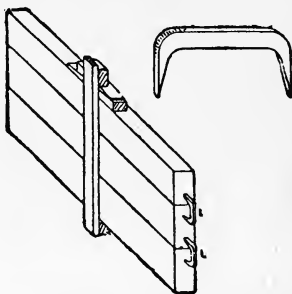

Method of holding Glued
Joints with Iron Dogs.

Owing to the importation of narrow and faulty timber the necessity of jointing is greater to-day than ever it was, wide timber of course meaning higher cost for raw material.

THE HALVED JOINT

THE HALVED JOINT is frequently known as half-lapping, and sometimes as checking and half-checking. In the majority of cases it is made by halving the two pieces, *i.e.*, by cutting half the depth of the wood away. There are, however, exceptions to this rule, as in the case of "three-piece halving" (or, as it is sometimes called, "third lapping") and in the halving of timber with rebated or moulded edges. Halving is one of the simplest

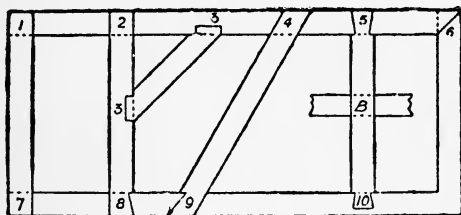

Fig. 29.—Frame, with various halved joints. These, numbered 1, 2, 3, etc., are shown in detail in Figs. 30 to 39.

methods of connecting two pieces of timber, especially where it is desired to make frames and bracket supports for either inside or outside use.

Fig. 29 shows the elevation of a frame which is made up of a number of halving joints; it shows also the application of the various joints to this class of work. Each joint used in the construction of this frame may be dealt with separately. The numbers marked on Fig. 29 refer to the individual joints, shown separately in Figs. 30 to 39.

Fig. 30 shows the "Halved Joint" at the corner of the frame where the two pieces form a right angle. Each piece

Joints in Woodwork

is halved and shouldered at opposite sides, thus forming a perfect fit one with the other and giving a strong joint with a minimum amount of labour. For inside work the joint would be glued and screwed together, the screw heads being countersunk so as not to come in contact with

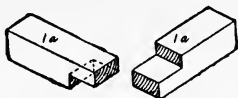

Fig. 30.—Halved Corner Joint.



Fig. 31.—Halved Tee Joint.

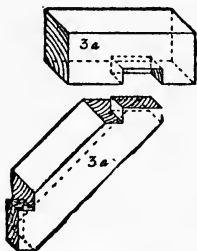

Fig. 32.—Oblique Halving, with Shoulder.

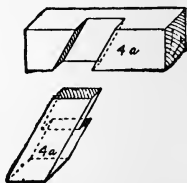

Fig. 33.—Oblique Halving.

the cutting iron of the plane when levelling off the work. For outside work, in exposed positions where the work will have to withstand the weather, the alternate method of smearing the joint with paint or with a mixture of varnish and white lead would be advisable, the joint being nailed or screwed. Fig. 30 shows the two pieces separated.

Fig. 31 shows a similar joint to the above, but in this case the top rail runs through and it is generally spoken of as a "Halved Tee Joint." It may be used in nearly all cases where a top or bottom rail runs through an upright.

The Halved Joint

The method of securing the joint is as before. Fig. 31 shows a sketch of the joint separated.

At Fig. 32 is shown an "Oblique Halving Joint," where the oblique piece, or strut, does not run through. This type of joint is used for strengthening framings and shelf brackets; an example of the latter is shown at Fig. 49. A strut or rail of this type prevents movement or distortion to a frame diagonally (generally spoken of in the trade as "racking"). Fig. 32 shows the joint apart.

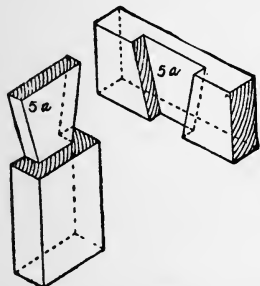

Fig. 34.—Dovetail Halving.

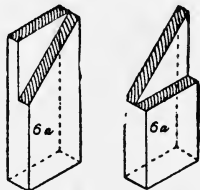

Fig. 35.—Mitred Halving.

Fig. 33 is an example of "Oblique Halving" with the upper piece running through. This joint is used in similar positions to Fig. 32, and has in some cases the disadvantage of showing end grain at the top of the frame. Fig. 33 shows a sketch of the two pieces separated.

Fig. 34 is "Dovetail Halving," the dovetail running through the top piece. This is a strong joint, used where outside strain is likely to occur in the top piece, the dovetail preventing the rail from being drawn away from the shoulder. At Fig. 34 is a sketch of the two pieces.

At Fig. 35 is seen "Mitred Halving," a somewhat weak joint, but necessary in looking-glass frames, etc., where good appearance is required on the face side. Its use is obvious if the face of the frame be moulded with beads

Joints in Woodwork

or other sections which require to intersect one with the other. This also applies if the frame be moulded on its face edges. At Fig. 35 the joint is shown separated.

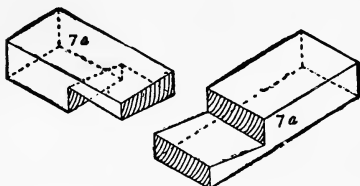

Fig. 36.—Halved Joint with Double Dovetail.

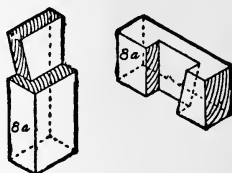

Fig. 37.—Halved Joint with One Side Dovetailed.

Fig. 36 indicates the “Halved Joint,” the pieces at one end showing a double dovetail. This particular joint is seldom used except for Manual Training purposes. Fig. 36 shows a sketch of the joint apart.

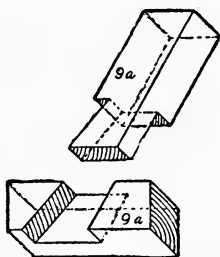

Fig. 38.—Oblique Dovetail Halving.

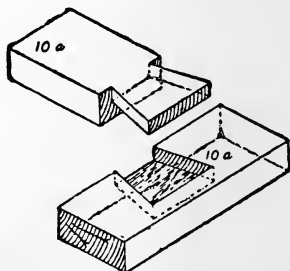

Fig. 39.—Stopped Dovetail Halving.

Fig. 37 is a “Halved Joint” with one side of the piece dovetailed. This joint is used in similar positions to Fig. 34, and rather less labour is required in the making. At Fig. 37 are given the two separate pieces.

The Halved Joint

Fig. 38 is "Oblique Dovetail Halving," one side of the piece being dovetailed, used to prevent "racking," and as a cross brace to framing. It is occasionally made with both

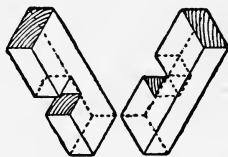
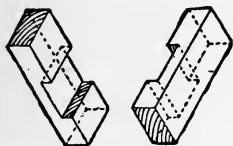

Fig. 40.—Cross Halving Joint. Fig. 41.—Cross Halving Joint, edgewise.

its sides dovetailed as shown at Fig. 34. The sketch Fig. 38 shows the joint apart.

Fig. 39 shows "Stopped Dovetail Halving." In this case the dovetail is similar to Fig. 34, with the exception that it does not run through the bottom rail. This is an advan-

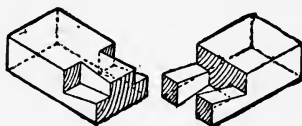
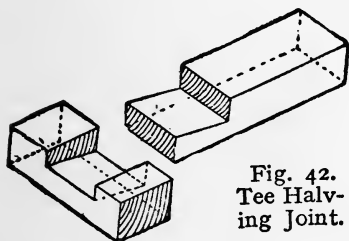

Fig. 42.—Tee Halving Joint.

Fig. 43.—Dovetailed Halving Joint for Lengthening Timber.

tage if the bottom edge of the rail is in evidence, or if it is required to glue a moulding or hardwood facing slip on the lower edge. The glue adheres better *with* the grain than it would *end way* of the grain, and if slight shrinkage occurs across the width of the bottom rail the moulding would not be forced away by the upright.

The joint lettered B in Fig. 29 is a "Cross Halving Joint" where each piece runs through the other. Fig. 40 shows this

Joints in Woodwork

joint separated, and Fig. 41 shows a similar joint separated where the joint is made edgewise.

Fig. 42 shows a "Tee Halving Joint" with a dovetail cut

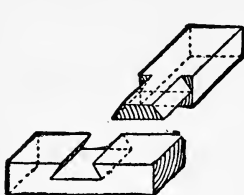

Fig. 44.—Dovetailed and Halved Joint.

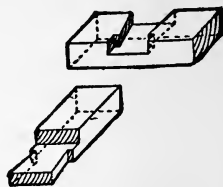

Fig. 45.—Dovetailed Halved Joint with Shoulders.

on the edge. This is seldom used except as a woodwork exercise.

Fig. 43 is a "Dovetailed Halving Joint" used for lengthen-

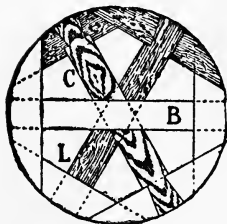

Fig. 46.—Halved Joints on Barrow Wheel.

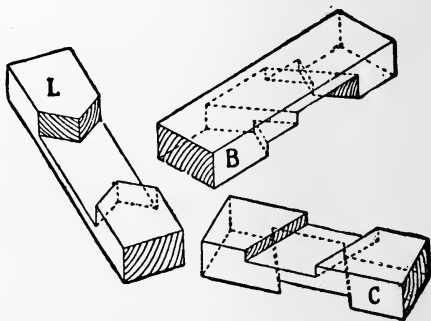

Fig. 47.—Detail of Halved Joints as in Fig. 46.

ing timber, and is also a favourite Manual Training model. It might also come under the heading of scarf joint, although rarely used in actual practice as such. As a practical

The Halved Joint

woodwork exercise it calls for accurate marking out and careful fitting.

Fig. 44 shows a combination of a dovetailed and halved joint; whilst Fig. 45 shows a dovetailed halved joint with the shoulders housed. This latter is seldom used in actual work.

Fig. 46 shows the application of halving joints when constructing a barrow wheel. The centre portion is an



Fig. 48.—Bevelled
Dovetail Half-
lapped Joint.

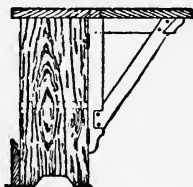

Fig. 49.—Kitchen
Drop Table.

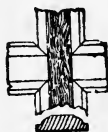

Fig. 50.—Halved
Moulded Joint.

example of three pieces "half-lapped" or, as it is sometimes called, "one-third lapped." A sketch of the three pieces separated is shown at L, B, C, Fig. 47.

This joint is extensively used in the pattern making trade for lap-jointing the arms of pulley patterns, etc. It is probably the most difficult of the halving joints to mark out and construct with the desired degree of accuracy.

Fig. 48 shows a combination of a bevelled dovetail half-lapped joint. This is only used as a puzzle joint. When neatly constructed and glued together it is apparently impossible to make it, showing as it does a half lap on one side and a dovetailed half lap on the reverse side.

Fig. 49 is the end view of a kitchen table with drop leaf, showing the overhang of the top to clear the skirting board. A table of this type is fastened to the wall with two iron holdfasts which engage with the ends of the table. The hinged bracket frame shows the application of the

Joints in Woodwork

halving joint to bracket supports for this and similar purposes, such as brackets to support shelving, etc. In this example the hinged brackets turn underneath the table top, and allow the leaf to drop out of the way when not

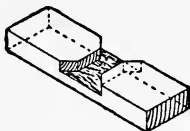

Fig. 51.—Separate piece of Fig. 50, used for Moulded Halved Joint.

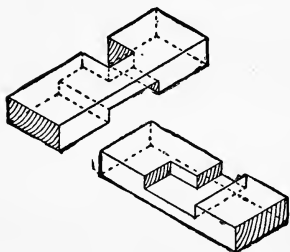

Fig. 53.—Manual Training Halved Joint Exercise.

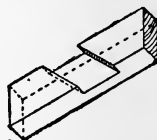
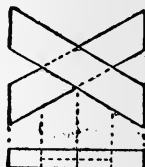

Fig. 52.—Cross Halving Joint.

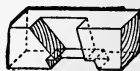

Fig. 54.—Exercise Joint.

required. The dotted lines show the position of a shelf for boots and shoes.

Fig. 50 shows the halving of cross pieces which have their edges moulded; a piece is shown separately at Fig. 51, but in this sketch the moulding is omitted to give a clearer representation of the method of construction.

Fig. 52 is a "Cross Halving Joint" where the two pieces are not at right angles. A plan and elevation of the joint

The Halved Joint

are shown in the upper part of the figure, whilst a sketch of one piece of the joint is given in the lower illustration.

Figs. 53 and 54 are principally used as Manual Training models, and call for patience and manual dexterity.

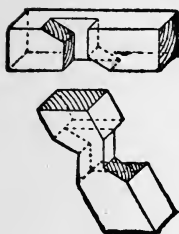

Fig. 55.—Carpentry Tie Joint.

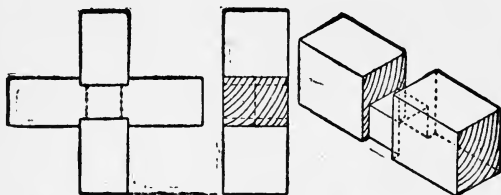

Fig. 56.—Cross Halving Joint with Housed or Notched Shoulders.

Fig. 55 is used in carpentry and joinery where a tie or cross piece ties joists or beams at an angle.

Fig. 56 shows the elevation, end view and sketch of a

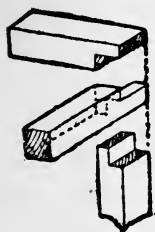

Fig. 57.—Cross Rail and Upright Halved Joint.

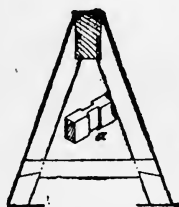

Fig. 58.—Workshop Trestle Joint.

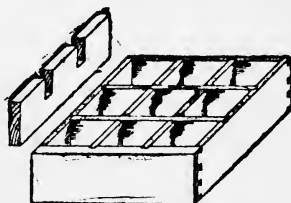

Fig. 59.—Cellarette Partition Joints.

“Cross Halving Joint” with housed or notched shoulders. This joint is seldom used in actual practice.

At Fig. 57 are shown two cross rails and an upright halved together. This type of joint is used where three pieces

Joints in Woodwork

meet, as is the case in building the framing of a poultry house.

Fig. 58 is the end view of an ordinary workshop trestle, showing the application of dovetailed halving where the legs have a tendency to strain outwards. The inset (a) shows the housing of the top rail to receive the legs.

Fig. 59 shows a deep drawer, generally known as a cellarette, and used in a sideboard to accommodate wine

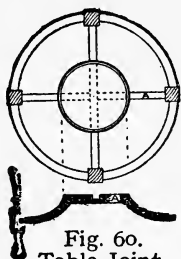

Fig. 60.
Table Joint.

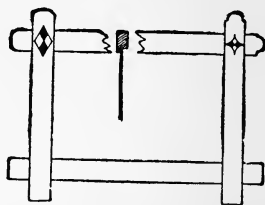

Fig. 61A.—Oxford Frame
Halved Joints.

bottles. This shows a good example of halving the cross pieces so as to form compartments. The piece shown separately illustrates the method of construction. The ends of these pieces engage in the housings or grooves of the drawer sides. Pigeon holes or compartments in stationery cases, bookcases and writing bureaux are constructed in a similar manner, although the method of housing, or combined halving and housing, is to be preferred in some cases.

At Fig. 60 is the plan of a circular table having a small circular shelf with the top removed. The rims or framing are built by the method known as laminating (see Fig. 19 in chapter on THE GLUED JOINT), after which they are veneered on the face sides. The application of the halving joint to the shaped bottom rails, which in this case carry and support the small shelf, is shown in the part elevation.

Fig. 61A shows the well known "Oxford frame," illus-

The Halved Joint

trating halved joints when the edge is rebated. Figs. 61B and 61C make clear the construction of this type of joint. Alternate suggestions are shown for the treatment of the corners, the simple inlay being black and white (ebony and holly or boxwood). Frames of this type are made

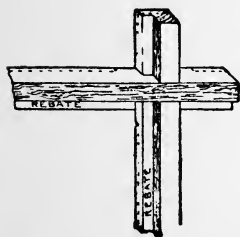

Fig. 61B.—Back View of Corner of Oxford Frame.

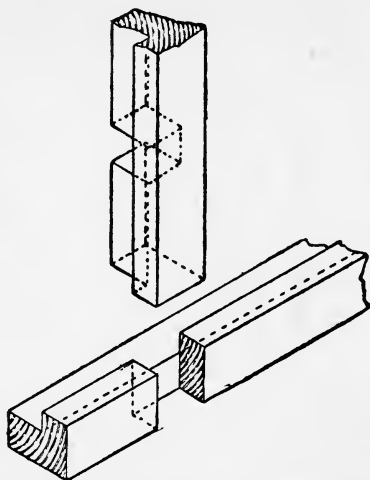

Fig. 61C.—The Halved Joints of an Oxford Frame.

in various widths and sizes and are used for pictures, mirrors, etc.

Tools Used.—The tools used for making joints of the above class are: planes, the gauge, tenon or other saw, chisels, try square, and in some cases a joiner's bevel to obtain and mark the necessary angles, pencil and marking knife.

Method.—Plane up the face side and face edge of the timber, gauge and plane to both thickness and width; mark shoulders with pencil or marking knife; gauge to

Joints in Woodwork

the thickness of the required halving ; saw waste portions away ; pare up with chisel to a good fit ; glue or glue and screw, or use paint as previously mentioned, and then level off the surfaces.

HOW TO SET OUT AND MAKE THE HALVED JOINT.

Although at first sight the halved joint may appear to be a very easy item of construction, it requires much care and

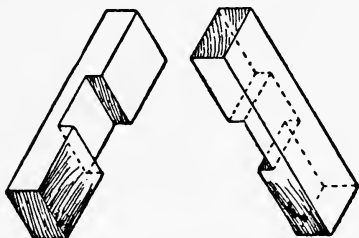

Fig. 62.—The Two Pieces of a Halved Joint.

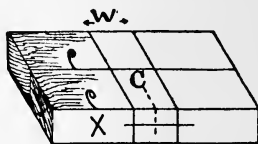

Fig. 63.—Marking the Timber.



Fig. 64.—Scoring with Square.

attention in marking out and sawing. Fig. 62 shows the two pieces which form the joint separated, and it will be noticed that each piece of wood has half its thickness cut away, so as to accommodate the other piece. This type of joint is used where two pieces of wood cross each other at right angles, or at an angle as shown in Fig. 70. The halving joint is used also for joining two pieces of wood at their ends, as for instance the corner of a frame, one half of this joint being shown at Fig. 65 B.

MARKING OUT.

To make the joint, the timber should be carefully planed to its exact width and thickness. The two pieces may then

The Halved Joint

be placed upon the bench (as shown at Fig. 63) or fixed in the vice.

To Mark Out, find the centre of the timber, C, Fig. 63, and set out half the width of the wood on each side of the dotted centre line. Thus, suppose the wood (W) to be 2 ins. wide, then set 1 in. on each side of the centre line. Take a square as at Fig. 64, and with a sharp penknife blade score or cut a line all round each piece of timber.

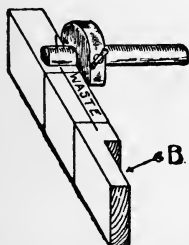

Fig. 65.—Using the Marking Gauge.



Fig. 66.—Chiselling away Wood up to the Gauge Line.

Next take up a marking gauge, and set the marking point to half the thickness of the wood. This distance may be measured, and its exactness tested, by pricking a small hole from each side of the wood with the marking gauge and carefully noting that the pricked holes coincide. The gauge mark is clearly shown in the various illustrations. Now, take a pencil and scribble or mark "waste," on the parts you intend to cut away. This will save trouble later on, especially if you are making several joints at once. Take your sharp penknife or marking knife blade, and cut fairly deeply into the marked line on the portion you are going to pare away.

Chiselling.—Fix the wood firmly in your vice, or against your cutting board or bench stop, as may be more convenient to you, and with a sharp chisel cut away the

Joists in Woodwork

wood up to the marked line, as at Fig. 66. The channel in the sketch is exaggerated, so as to show the method clearly. Turn your wood about and cut a similar channel at A, as indicated by the dotted line. The object of using a penknife or marking knife to mark out your work, instead of using a pencil, will now be obvious. Owing to the knife having scored about $\frac{1}{16}$ in. deep across the fibres of the wood, the timber will come away cleanly when the chisel

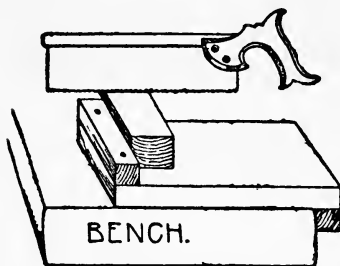

Fig. 67.—Sawing.

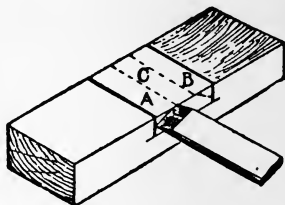

Fig. 68.—Paring away Waste.

is used, as at Fig. 66. The small channel thus made will form a guide in which to start your tenon or dovetail saw; it prevents the saw cutting on the wrong side of the marked line and thus making the halving too wide.

Sawing.—Lay the work on the cutting board as at Fig. 67; or, if you prefer, put the work in the vice. Carefully saw down the work until you *just touch* the gauge line. Do not press heavily with the saw; use it lightly; the weight of the back iron which is fixed on the saw will ensure the saw feeding into the work quite fast enough. If the saw is newly sharpened it will, in fact, be an advantage to slightly ease the weight of the saw from off the wood, owing to the keenness of its edge. If the halving is a very wide one, additional cuts may be sawn between the outside marks, and these will greatly facilitate the removal of the waste wood when paring it away. For sawing the joint

The Halved Joint

reference may be made to Fig. 322 in the chapter on DOVE-TAILING.

Paring Away the Waste material with a chisel is the next step, and this is shown at Fig. 68. The work may be chiselled either in a vertical or a horizontal position. The horizontal position is the easiest for the amateur who has a vice or handscrew, because he may hold the work securely with a mechanical device and so avoid the unnecessary risk to his fingers.

Take the chisel and cut away A, Fig. 68; now turn the chisel and cut away B; after which keep the chisel horizontal

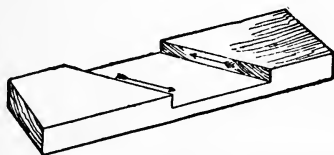

Fig. 69.—Showing Halved Joint at other than a Right Angle.

and cut off "the top of the hill," as it were, C. Repeat the three operations until you gradually pare the wood away exactly to the gauge line. When chiselling, if you find a tendency for the work to chip or crumble at the back edge, owing to the forward pressure of the chisel, turn your wood round and begin to cut from the other edge, allowing the chisel to finish paring at the centre.

Joints Other than a Right Angle.—If the halving joint is at an angle similar to the sketch, shown at Fig. 69, great care will have to be exercised in the use of the chisel, owing to the change in the direction of the grain of the wood. The arrow marks in this sketch distinctly indicate the direction in which the chiselling must be done so as to give a smooth result. This change of direction for cutting also applies to the bottom of the halving joint.

Cutting Joint at End of Timber (Fig. 70).—Should

Joins in Woodwork

the halving joint be used at the end of a piece of wood, as at Fig. 30, separated, and Fig. 29, completed, the waste material may be roughly sawn away, and the flat surface trimmed up with a chisel.

To saw out this type of halving joint, proceed to work the line B exactly as already described; then place the piece of wood obliquely in the vice as shown (Fig. 70) and

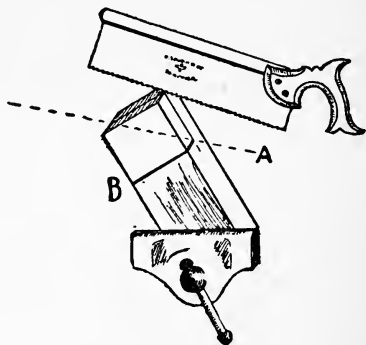

Fig. 70.—Halved Joint at End of Timber.

proceed to saw down the dotted line A, carefully watching the gauge line to see that you saw on the *waste* side of the lines. Then turn the piece of timber with its opposite edge towards you, and again use the saw as illustrated. You will this time only have to watch the gauge mark on the edge of the wood, because the saw will readily follow in the saw kerf already made. Now place the wood vertically in the vice, and, keeping the saw in a horizontal position, saw down to the shoulder line B.

Halving joints properly made and fitted should knock together with the weight of the clenched fist; the use of a heavy mallet or hammer will deface the work.

THE BRIDLE JOINT

A BRIDLE JOINT is often defined as the reverse of a mortise and tenon, and it is chiefly used in the carpentry and joinery trades. The name probably originated from the fact that it bears some resemblance to the manner in which a bit slips into the horse's mouth and is fastened to the bridle. There are not nearly so many varieties of the bridle joint as

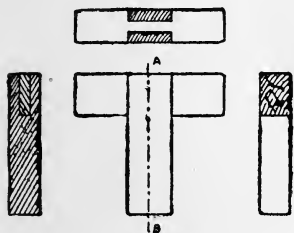

Fig. 71.—Simple Bridle Joint with section at A B.

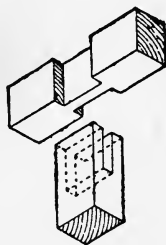

Fig. 72.—Bridle Joint, showing the two parts.



Fig. 73.—Leg Bridle-jointed to Rail.

there are of the halved and the mortise and tenon joints; this being the case, we may take the opportunity of giving a few detailed directions, with explanatory illustrations, on the setting out and the making.

Fig. 71 shows a bridle joint in what is perhaps its simplest form, the plan, elevation, end view and a section on the line A B being shown. A joint of this type may be applied in nearly all cases where a halved or a mortise and tenon

Joints in Woodwork

joint could be used. Fig. 72 is a sketch of the joint separated. Such bridle joints have an advantage as regards appearance over the mortise and tenoned variety in cases such as that shown at Fig. 73, which shows an occasional table leg fitted to the circular top framing. The bridle joint here allows the grain of the leg to run through to the top, and gives a better and more workmanlike appearance to the completed article.

Fig. 74 is a mitred bridle joint, the part *a* showing the

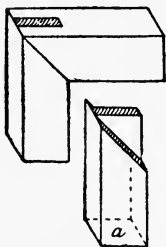

Fig. 74.—Mitre
Bridle Joint.



Fig. 75.—Frame
with Bridle Joints.

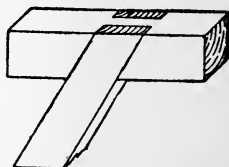

Fig. 76.—Oblique
Bridle Joint.

upright portion separated. This is a most useful joint for positions similar to that shown in the small glass frame, Fig. 75. The wood framing in this case is only $1\frac{3}{8}$ in. in width, and if a mortise were used it would have to be exceptionally small. The shaped rail at the bottom of this frame again shows the application of the bridle joint.

Fig. 76 shows an oblique bridle joint, used in many instances as a brace, or strut, to prevent framing from racking. (See also Fig. 32.)

Fig. 77 is a stopped bridle joint, used in positions where the top or bottom edge of the work meets the eye, and where, if the rail were allowed to run through, the end grain would appear unsightly.

Fig. 78 is a so-called bridle joint at the corner of a frame. This is also called "an open slot mortise and tenon joint."

The Bridle Joint

A good strong, serviceable joint which can be used instead

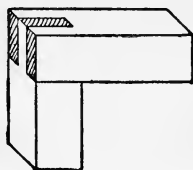

Fig. 78.—Bridle Joint.

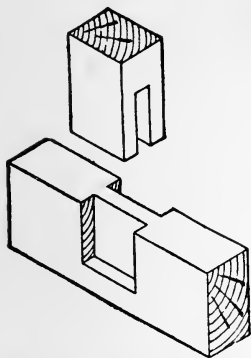

Fig. 77.—Stopped Bridle Joint.

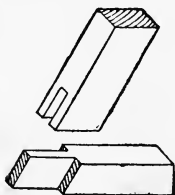

Fig. 79.—Oblique Angle Bridle Joint.

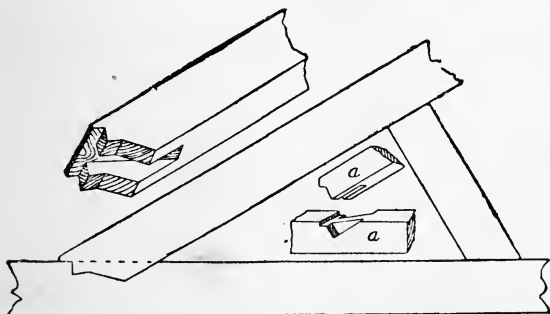

Fig. 80.—Application of Bridle Joint to Roof Truss.

of the closed mortise and tenon type, its advantage is that less labour is required in the making. (See also Fig. 92.)

Joints in Woodwork

Fig. 79 is an oblique bridle joint used in similar positions to the above, but when the two pieces meet at an acute angle at the end of a frame.

Fig. 80 shows the application of the bridle joint to a roof truss. Two sketches are shown at the joining of the tie beam and the principal rafter. The joint *a* is the type generally used.

SETTING OUT AND MARKING.

It is a safe rule, when setting out a bridle joint, to divide the thickness of the timber into three equal parts. This will leave the timber on each side of the tongue equal to the thickness of the tongue, thus giving uniform strength to the joint. The bridle joint is chiefly used for connecting the internal parts of wooden frames. It is stronger than the halving joint, and, owing to its peculiar construction, requires little in the way of pegs, screws or nails, to secure it in position. Fig. 81 illustrates the joint both open and closed.

To understand the method of setting out and marking, glance at the sketch, Fig. 81. It is not necessary that the bridle piece *A* be the same width as the cross piece *B*; but it must be remembered when setting out the joint with the marking knife or pencil that the width marked *W* on piece *B* must be equal to the width *W* on the piece *A*. The timber should be fairly accurately sawn or planed to the same thickness, and all edges should be square and true.

Marking.—The wood is placed upon the bench, and the joint marked out by using a marking knife or penknife blade and the try square. A knife blade is much better than a pencil, as the sharp edge severs the fibres of the wood and gives a much finer line than the pencil. It is not always necessary to exactly square and trim the end of piece *A*; it may with advantage in many cases be left $\frac{1}{8}$ in. longer than necessary and levelled off with the saw, plane and chisel after the joint is put together.

The Bridle Joint

When the piece A has to have a bridle joint fitted at each end, it is the usual workshop practice to cut the timber about $\frac{3}{8}$ in. longer than necessary, and mark the shoulder lines C to the exact length, after which the joints are cut. This leaves the ends standing over the horizontal rails, and, after fixing the complete frame together, the small projecting ends are levelled off flush with the cross rails.

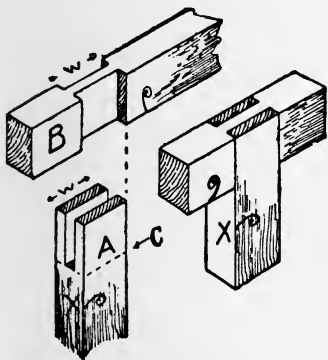

Fig. 81.—Bridle Joint, open and closed.

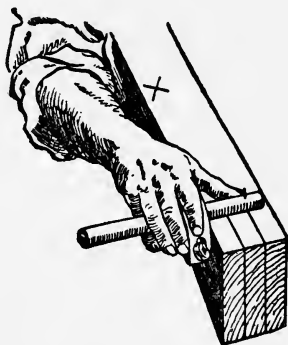

Fig. 82.—Gauging the Timber with Mortise Gauge.

Gauging.—After squaring all the shoulder lines round the timber with the knife and try square, the mortise gauge should be set so as to strike the two gauge lines marked G, Figs. 83 and 84, at one operation. If the worker does not possess a mortise gauge the work may be marked at two distinct operations with the aid of the marking gauge. The gauge should be adjusted so as to mark the wood into thirds, and the stock of the gauge (the portion of the gauge containing the thumb screw in Fig. 82) must be used from the face side of the timber when gauging up the whole of the pieces forming a frame. The face mark on the work is indicated by a glorified comma, and the edge

Joints in Woodwork

mark is shown by an x , as in the various illustrations. Fig. 82 shows the method of holding the gauge in the right hand whilst gauging the lines on the work.

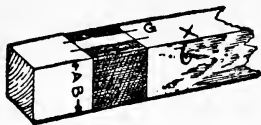

Fig. 83.

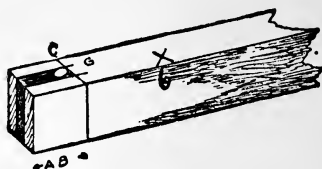

Fig. 84.

The Two Parts of the Joint Marked.

The joint, when marked out, will appear as at Figs. 83 and 84, and the portions which are to be cut away may be shaded with a pencil as indicated; this will prevent

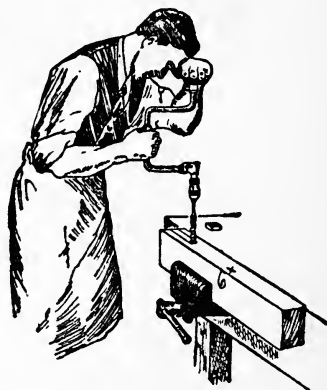

Fig. 85.—Boring previous to Chiselling.

mistakes arising whilst cutting the work, especially by one who is not thoroughly familiar with the joint.

The distance A B, in Fig. 83, must not be less than the distance A B in Fig. 84.

The Bridle Joint

Boring Away Waste.—Examine Fig. 84; the shaded portion in the centre has to be cut away, and it will greatly facilitate the removal of this waste piece by boring a hole with a twist bit at the position shown. The twist bit should be about $\frac{1}{4}$ in. less in diameter than the width between the

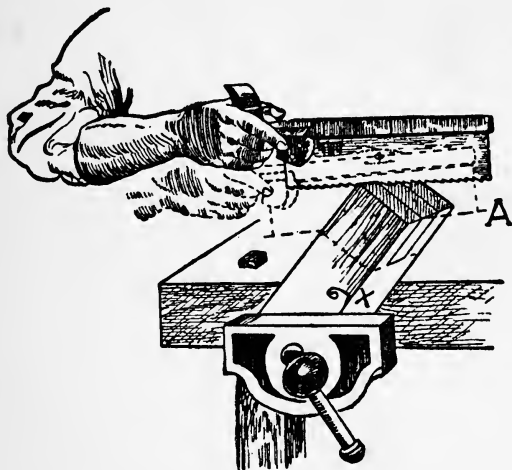

Fig. 86.—Sawing—the first cut.

gauge lines G. The easiest method of boring out this hole is shown at Fig. 85.

SAWING THE JOINT.

Sawing.—The wood should be put in the vice as Fig. 86. Taking up a saw, with the index finger on the side of the handle, commence sawing, and proceed until you come to the position indicated by the dotted hand and saw A; this will leave a saw kerf or cut running diagonally from the shoulder line to corner of the wood. Release the vice and refix the wood so that it leans in exactly the opposite

Joins in Woodwork

direction to Fig. 86; then reverse your own position and repeat the sawing, so as to cut another diagonal saw cut from the shoulder line to the corner. Fix the wood upright, as shown at Fig. 87, and saw as shown, when you will find that the saw has no tendency to run out of the guide cuts already formed by the method used at Fig. 86. Remember, when commencing to saw at Fig. 86, that it is necessary to saw *inside* the gauge line; otherwise the joint

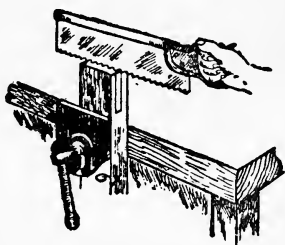

Fig. 87.—Third or horizontal saw cut.



Fig. 88.—Chiselling.

will be too slack, owing to the thickness of the wood, which will be made into sawdust by the thickness of the saw blade. The index finger on the side of the saw, and pointing in the direction of the saw cut, will greatly help the worker to saw in a straight line, as it is natural to point with this finger to any object that is to be aimed at.

Cut down the other line in a similar manner, and then with a chisel of suitable width carefully chop away the waste material. The wood may be placed edge way upon the bench, or in the vice, and the chisel should be held vertically. The hole which has been bored with the twist bit will allow the chips which are cut away to offer little or no resistance to the chisel blade. The chiselling should not all be done from one side, or a chipped under-edge will be the result; it is better to chisel the work until half way through and then turn the other edge of the wood

The Bridle Joint

uppermost and again begin to chisel from the top. This method will finish the cutting in the centre of the work and prevent burred and ragged or chipped edges at the shoulder.

Cutting the Shoulders.—With regard to working piece B, Fig. 81, place the wood against the bench stop or in the

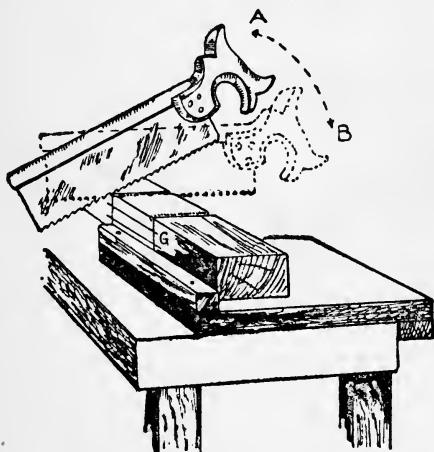
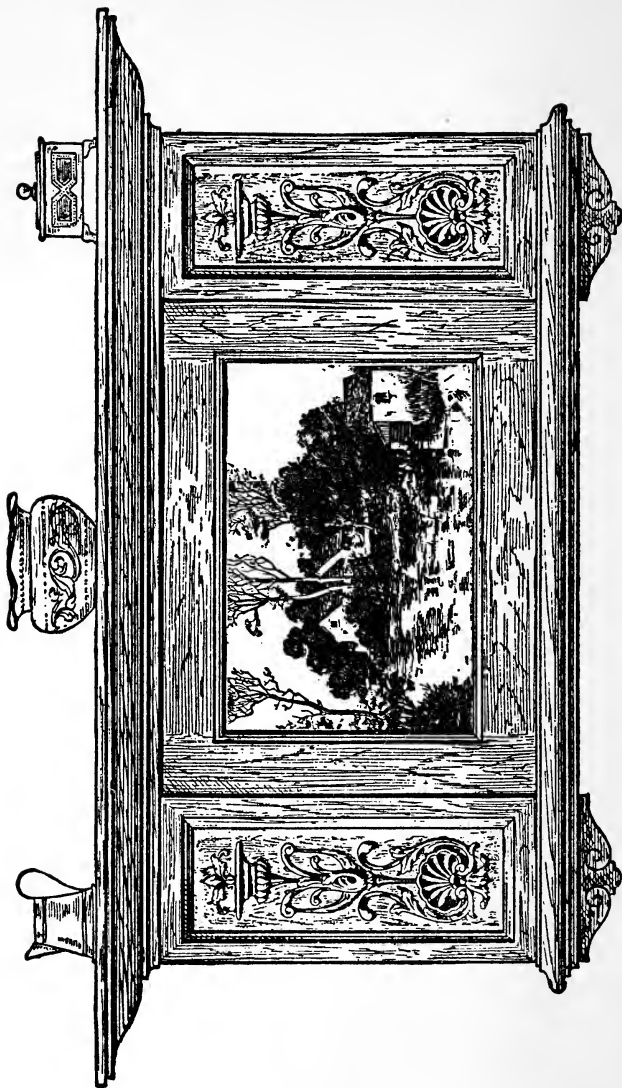

Fig. 89.—Sawing the Shoulders.

vice, and taking up a $\frac{3}{4}$ in. chisel, carefully cut away a small channel, as shown at Fig. 88; treat the other shoulder lines in a similar manner. If the marking knife or pen-knife blade has been used with a fair amount of pressure, so as to score the fibres of the wood, this small channel, which is to form a guide for the saw, will quickly and easily be cut. Next place the wood in the vice or on the cutting board as shown at Fig. 89, and begin by sawing lightly at the back edge as shown. When the saw has entered the wood $\frac{1}{4}$ in. gradually bring the handle of the saw down from A to B whilst the saw is in motion. Continue sawing until



Carved and Moulded Picture Frame. (The inner Frame is Bridle-jointed.)

The Bridle Joint

just on the gauge line ; then treat the other shoulder lines in a similar manner.

Chiselling away Waste.—Fix your wood firmly in any suitable manner, vice or otherwise, and, holding your chisel tilted as at Fig. 90, pare away the blacked portion 1 ; then pare away the blacked portion 2 ; after which hold the chisel flat and by gradual operations pare away the dotted

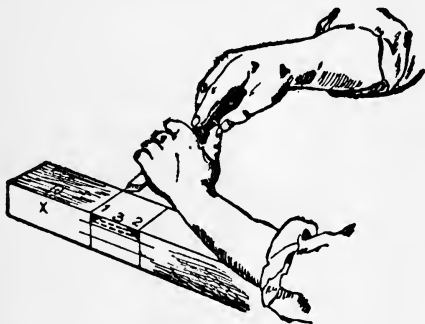

Fig. 90.—Chiselling away Waste.

lines 3, until you come down to the gauge line ; then repeat the method of cutting on the opposite side of the wood. If any difficulty be experienced by chipped or ragged edges whilst chiselling, it can easily be overcome by chiselling alternately from the outside of the wood, so that the finish of the chisel cut takes place in the centre of the work, as previously described. Some workers prefer to chisel away the waste by placing the wood on its edge and using the chisel vertically instead of horizontally. The same methods (1, 2, and 3) hold good in this case.

Joints Other than at 90°.—The two pieces forming a bridle joint are not always at right angles, as at Fig. 81 ; in many instances it is necessary that the joint be at other than 90°. The work, however, is treated in a similar

Joints in Woodwork

manner, with the exception that an adjustable joiner's bevel is used instead of a try square to mark out the shoulder lines, and that a change of direction in the grain of the wood will occur when chiselling out the work. Fig. 91 indicates the change in the grain of the wood, and the adjustable joiner's bevel is also shown.

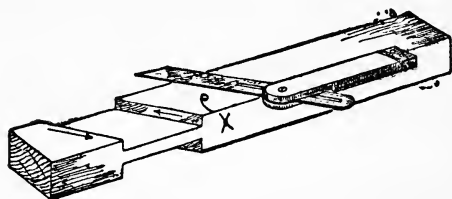

Fig. 91.—Bridle Joint at Angle other than Right Angle.

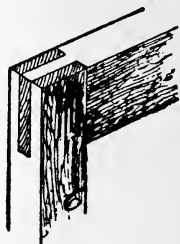

Fig. 92.—Open Slot Joint.

Fig. 92 shows an open slot mortise and tenon joint, and not a bridle joint, as it is sometimes called; this joint is marked out and cut in the same way as the bridle joint. Leading authorities are agreed that a bridle joint is an internal joint, and Fig. 92 shows the joint at the end of a frame, and it therefore comes under the heading of open slot mortise and tenon joints. (See also remarks on Fig. 78.)

THE TONGUED AND GROOVED JOINT

THE tongued and grooved joint is used in one form or another throughout the whole of the woodworking trades, covering, as it does, a great variety of work from the laying of flooring boards to the construction of light cabinet work.

Flooring and Match Boarding generally have the tongues worked on the solid board, and examples of a few of the various types are shown as follows:—



Fig. 93.—Tongued and Grooved Flooring Board.



Fig. 94.—Section of Hardwood Flooring.

Fig. 93 shows the end view of the ordinary $\frac{7}{8}$ in. tongued and grooved flooring board, as used in the construction of floors for mills, workshops and cottage property. This type of flooring is nailed to the joists in the ordinary manner, no attempt being made to conceal the nails used.

Fig. 94 is a section of flooring which is generally made of hardwood, such as maple, oak, or jarrah. It is used in positions such as ballroom and skating rink floors, etc., the tongue and groove being worked in such a manner that it covers the nails as shown. Each nail is driven into its position at one edge of the board, the groove holding the next board and hiding the nail.

Fig. 95 shows an example of matchboarding known as

Joints in Woodwork

tongued, grooved, and beaded on one side only, and Fig. 96 shows a similar type tongued, grooved and beaded on both sides. This variety of matchboarding is known in the trade as "T. G. and B." It is used for nailing on framing to



Fig. 95.—Tongued and Grooved Matchboarding, with Bead on One Side.

Fig. 96.—Tongued and Grooved Matchboarding, with Bead at Each Side.

Fig. 97.—Matchboarding, Tongued, Grooved and Vee'd.

form partitions for rooms, offices, etc., for panelling corridors, etc., and for making framed and ledged doors, building tool houses, cycle sheds and other outhouses, etc.

Fig. 97 is an example of matchboarding that is tongued, grooved and vee'd on one side, and Fig. 98 shows tongued,



Fig. 98.—Matchboarding Vee'd Both Sides.

Fig. 99.—Double-tongued Matchboarding.

Fig. 100. Double-dovetailed, Tongued, and Grooved Joint.

grooved and vee'd both sides. These are used for similar purposes to Figs. 95 and 96, and many prefer the V matchboarding, because it is more easily painted than the beaded variety.

The object of working a bead or beads on matchboarding is to break the jointing of the various pieces and to aim at ornamental effect; also to prevent unsightliness should

The Tongued and Grooved Joint

the timber shrink slightly. If a moderate amount of shrinkage takes place, as is nearly always the case, the joint at the side of the bead appears to the casual observer to be the fillet or channel worked at the side of the bead. If the tongues are not painted before the work is put together, the shrinkage will cause the raw wood to show, and thus make the joint too much in evidence.

Fig. 99 shows a double tongued and grooved joint used in the wholesale cabinet factories. It is preferred for the



Fig. 101.—Joint with Single Dovetail Tongue and Groove.



Fig. 102.—Loose Tongues.
A. Cross Tongue.
B. Feather Tongue.

jointing of cabinet stock, and the amateur can make a similar joint by working two grooves and inserting loose tongues.

Fig. 100 is the end view of a double-dovetailed, tongued, and grooved joint, and Fig. 101 is a sketch of a similar joint having only one dovetailed tongue.

From a constructional point of view Fig. 100 is far and away the best joint that has yet been produced. Unfortunately, however, there is not at the present time any hand tool that will economically produce it, owing probably to the fact that the joint is the subject of a patent. The dovetail tongue tapers slightly throughout its entire length, gripping the joint on the principle of the wedge, and squeezing the glue into the pores of the wood.

Cabinetwork Joints.—With regard to tongued and grooved joints which apply more particularly to the jointing of cabinet work, Fig. 93 is produced by planes which are

Joints in Woodwork

especially made for the purpose. One plane makes the tongue and another the groove. The handiest sizes to buy are those which joint $\frac{3}{8}$ in., $\frac{5}{8}$ in., and $\frac{3}{4}$ in. timber, it being usual to dowel or loose-tongue thicker boards. The $\frac{3}{8}$ in. partitions (or, as they are sometimes called, "dustboards") between the drawers of a sideboard or dressing chest are in good work jointed in this manner. The $\frac{5}{8}$ in. and $\frac{3}{4}$ in. "ends and tops" of pine or American whitewood dressing tables, wardrobes, etc., call for the larger sized planes.

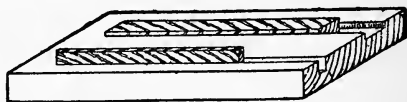

Fig. 103.—Cradle for Planing.

Loose Tongues.—There are two methods of jointing with loose tongues, viz., the use of the cross tongue, Fig. 102 A, and the use of the feather tongue, Fig. 102 B. Cross tongues are the stronger when glued in their position, and they can be used very much thinner than feather tongues. Feather tongues are cut diagonally across the grain as illustrated.

Fig. 103 is a cradle for planing up loose tongues to the required width (generally $\frac{7}{8}$ in.). Two grooves are made in a piece of $1\frac{1}{4}$ in. hardwood; one groove is used for planing the width way of the tongue and the other for planing the edge way.

These tongues can be cut to accurate size on a circular saw bench if power and machinery are at hand.

APPLICATIONS OF THE TONGUED AND GROOVED JOINT.

Fig. 104 is a sketch of a portion of a sideboard top, showing the plough groove ready worked out to receive the

The Tongued and Grooved Joint

tongue; the other half of the top is treated in a similar manner. It will be noticed that the groove is not worked through the full length of the board, but stopped about $1\frac{1}{4}$ in. from each end; this leaves a square joint at each end of the top on which the moulding is worked. If the groove be run through the board it looks very unsightly when the mould is finished.

Fig. 105 is a shaped spandrel, such as is fixed in the recess of a sideboard or cupboard or shop window fitment. It is

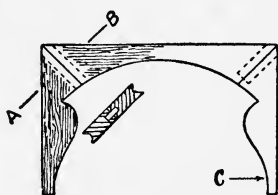
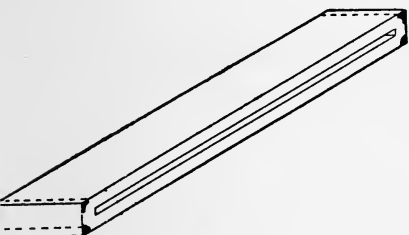

Fig. 104.—Part of Sideboard Top; grooved with ends left blind.

Fig. 105.—Shaped Spandrel for Recess.

of such a width that, were it cut from a wide board, the shaped portion would be apt to break off owing to the short grain at C. The shaping is therefore built up out of three separate pieces, the grain running as indicated by the sketch. The loose tongue is represented by the dotted line and a section is shown of the joint at the line A B. At the opposite corner the tongue is left blind, *i.e.*, not run through the edge. This is the method that should be used when the shaping is above the level of the eye.

Fig. 106 shows part of a carcass of a dressing table. The drawer runner A is shown grooved across the end to receive a cross tongue; this cross tongue engages with a similar groove in the front bearer. This method of fastening the runner to the bearer is in every-day use.

Fig. 107 is a writing table top. The centre boards are

Joints in Woodwork

first jointed and glued up, after which the ends and sides are grooved ready to receive the cross tongues. The hardwood margins are shown at one end and at the front, and the

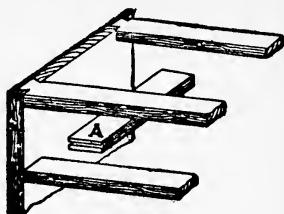

Fig. 106.—Part Carcase of Dressing Table.

grooves are arranged so that, on completion, the marginal frame stands above the top just the amount of the thickness of the leather which will cover the table. In some cases the margin at the end runs the same way of

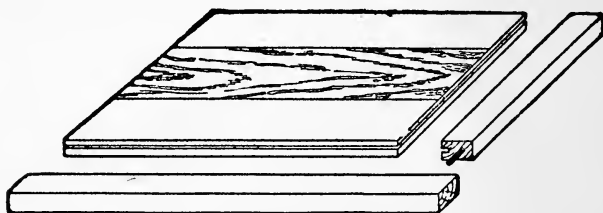

Fig. 107.—Writing Table Top.

the grain as the top, thus allowing for slight shrinkage. Cross tongues would of course be used in this case.

Fig. 108 is a sketch showing one-quarter of a barred or tracery cabinet door. An enlarged section of the astragal mould which is grooved to fit on the bar which forms the rebate is also shown,

The Tongued and Grooved Joint

Fig. 109 is a combing or corner locking joint, a method of making boxes by means of a continuous use of tongues and grooves instead of dovetails. This type of joint is generally machine made. The amateur, however, who is

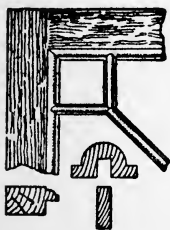

Fig. 108.—Corner of Barred Door.

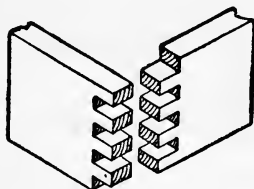

Fig. 109.—Combing or Locking Joint.



Fig. 110.
Single Loose
Tongue and
Double-
tongue Joint.

not proficient to undertake a dovetailed box frequently uses this method.

Corner Joints.—Fig. 110 is a single loose tongue and a double solid tongue. Both are methods used to connect



Fig. 111.



Fig. 112.



Fig. 113.

Examples of Tongued and Grooved Corner Joints.

circular cornered work, such as a counter end, to the front framing.

Fig. 111 shows a tongue and grooved joint suitable for edge or end jointing, such as fitting matchboarding round a chimney breast, making small jewel drawers, etc.

Fig. 112 is a tongued and grooved joint, with a bead worked on same to hide the joint, sometimes called a staff-

Joints in Woodwork

bead. It would be used in positions such as boarding in an upright iron pillar, etc., the bead giving a neat finish at each corner.

Fig. 113 is a similar joint, but at an obtuse angle. An example of its use is in fixing boarding round an octagonal column of brickwork.

Fig. 114 shows a tongued and grooved mitre as used for strengthening the corners of cabinet work, such as tea caddies, small boxes, plinths, etc. B shows a small

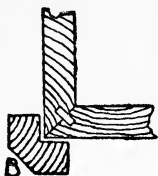

Fig. 114.
Tongued and
Grooved Mitre.

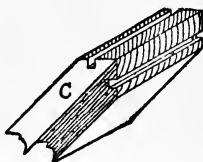

Fig. 115.
Method of
Working Groove.

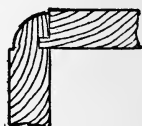

Fig. 116.
Corner Joint with
Corner Mould.

rebated block, one of which would be used at each corner to facilitate the cramping up when glueing the joints.

Fig. 115 shows the method of working the groove in the above joints. The pieces are turned back to back, the mitres thus making a right angle. The guide on the grooving plane thus works against each face of the joint, and this ensures correct jointing.

Fig. 116 is somewhat similar to Fig. 111, but with a quarter circle mould to hide the joint.

Fig. 117 indicates the building up of a double skirting mould. C represents the brickwork, A the oak-framed panelling, and B the packing and fixing block. A wide skirting of this type is made in two portions for convenience of working the moulding and to prevent undue shrinkage.

Fig. 118 is the top part of a dressing table with glass and jewel drawers. The sketch shows the two pieces separated.

The Tongued and Grooved Joint

These are jointed by tonguing and grooving, and when glued up the capping mould hides the joint. This makes a neat finish, no screws or nails being required, and the joint is to all appearances a glued butt joint.

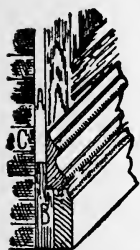

Fig. 117.
Double Skirting
Mould.

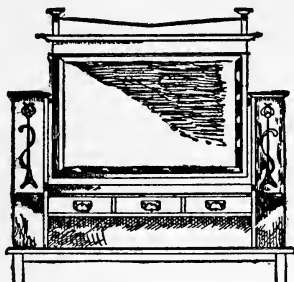

Fig. 118.—Dressing Table Top, with sketch
of parts separated.

PLOUGHING.

When grooves have to be worked in the edge or face of a board to receive tongues, the process is generally called ploughing, and it is usually accomplished by a special tool called a plough (or, as it is occasionally spelt, "plow"). When a plough plane is bought it is usual to procure eight plough bits or blades of various sizes to fit the plane. Fig. 119 shows the back elevation of a plough plane with the names of the various parts lettered thereon.

The board or boards which it is desired to groove are first planed straight and true, exactly as though it were desired to make a glued or butt joint. One of the boards is now placed edge way up in the vice and with the face side to the worker.

Joints in Woodwork

Take the plough plane and select a suitably-sized blade ; fix it in the plane in the usual way, allowing the cutting edge to project beyond the steel skate about $\frac{1}{2}$ of an inch, and securely drive up the wedge. Next loosen the small boxwood wedges at the side of each stem (the parts

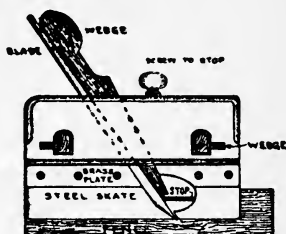

Fig. 119.—Plough Plane.

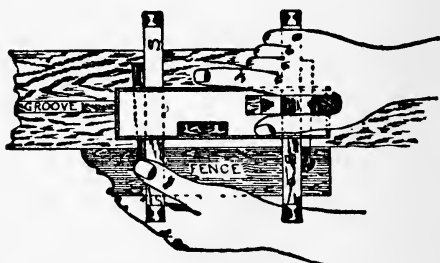

Fig. 120.—Plan of Plough Plane.

called the stems are lettered S in the plan, Fig. 120), and adjust the plane by tapping the stems with a hammer until the cutting iron is in the desired position ; then knock up the small wedges nice and tight. When setting the fence to or from the blade it is a wise precaution to measure the distance from the fence to the skate at each end of the plane ; this will ensure the skate being parallel to the fence. The neglect of this is a source of annoyance to many amateurs.

The Tongued and Grooved Joint

Now adjust the depth stop by turning the screw at the top of the plane, measuring the depth of the required groove from the edge of the blade to the stop, and then carefully lock the screw which adjusts this stop. The screw is generally adjusted with a screwdriver at the side of the plane. Other types of plough or fillister planes have a screw adjustment on the stems in place of the wedges.

Using the Plane.—The plane is now ready for use. Hold the fence close up to the side of the timber, the hands in position as shown at Fig. 120, the position of the body being that generally assumed in planing. Move the plane backwards and forwards in the usual manner, beginning the cut at the end of the board nearest to the vice jaws (the front), and proceed with the planing until the depth stop is in contact with the wood. Then take a step backwards and repeat the process until the whole length of the groove is ploughed. Care must be taken to force the fence up to the board with the left hand, whilst the right hand thrusts the plane backwards and forwards, and the plane must be kept vertical.

TONGUEING.

The grooves having been completed the tongues have to be made. Fig. 121 shows a sketch of a board and the method of marking out cross tongues (*a*) and feather tongues (*b*). The usual procedure for making cross tongues is to plane the end of the board and use a cutting gauge to give a line the required distance from the end (see sketch). The board is sawn with a tenon or panel saw, and the piece of timber for the tongue is thus procured. If a feather tongue is to be used it is cut diagonally from the board (*b*) and the ends cut square as shown by the dotted line.

Feather Tongues can be obtained in fairly long lengths out of narrow boards, whilst on the other hand cross tongues are limited by the width of the board. After

Joints in Woodwork

cutting off the tongues, they require planing with nicety to fit the grooves, and the advantage of a grooved board (Fig. 103) will be appreciated. A glue spoon similar to

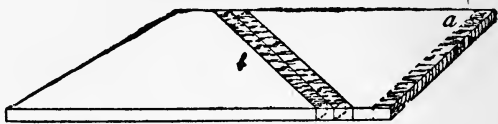

Fig. 121.—Method of Marking Out for Cross Tongues and Feather Tongues.

a plumber's ladle is generally used to pour the glue into the grooves, and it is usual to glue the tongue into one

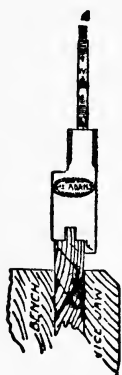

Fig. 122.
End Views of Tongueing and Grooving Planes.



Fig. 123.

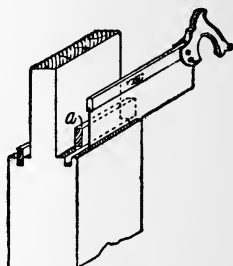

Fig. 124.—Method of Tongueing.

board first ; after allowing this to set, the joint is completed in the usual manner.

Tongueing Planes.—Fig. 122 shows the end view of a tongueing plane for working matched joints out of the

The Tongued and Grooved Joint

solid. The method of holding and using the plane is similar to the directions given for using the plough. The portion F represents the fence, which in this case is not adjustable; *a* is the blade and *w* the wedge.

In description Fig. 123 is similar to Fig. 122. The steel skate runs in the groove and supports the cutting blade similar to that in the plough plane, and it may be here pointed out that, provided a grooving plane of this type is of suitable width, it may be used for making grooves for loose tongues. Many workers who do not possess a plough use planes of this type for ploughing.

Fig. 124 shows the method of tongueing the shoulders of tenons as used in thick timber which is to be veneered on the face. A temporary piece of wood (*a*) is put between the tenon cheek and the saw, thus forming a guide for the latter. After cutting one saw kerf a thicker piece is made and a second saw kerf cut; the waste between the saw kerfs is now removed with an $\frac{1}{8}$ in. chisel and this completes the groove. A tongue of this type acts as an extra tenon and prevents the joint from "lipping" (becoming uneven) on the face side.

Joints in Woodwork

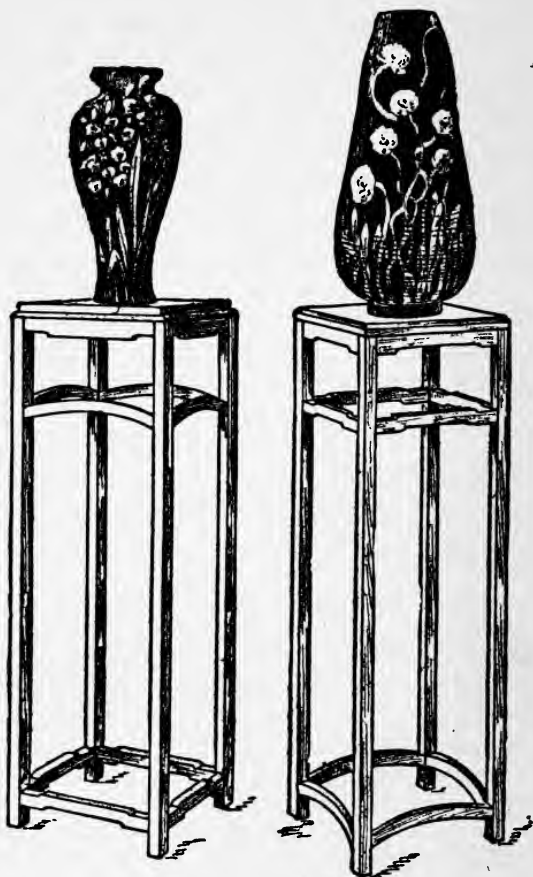

Light Japanese Vase Stands. (Fixing is by means of Mortise and Tenon Joints.)

THE MORTISE AND TENON JOINT

A MORTISE AND TENON JOINT is the method of joining timber or other material by forming a solid rectangular projection in the one piece and cutting a corresponding cavity to receive it in the adjoining piece. The projection is called the tenon, and the cavity the mortise (Latin, *teneo*, to hold; and French, *mortaise*). Joints of this type are secured in various ways.

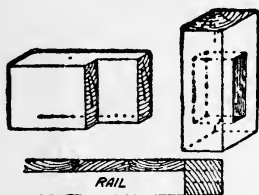

Fig. 125.—Barefaced Tenon Joint.

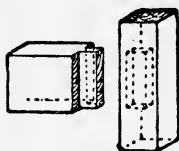

Fig. 126.—Stub Tenon.

Small wedges, wooden dowels, metal dowel pins, glue and paint are frequently used, and prior to the introduction of glue we have examples of Egyptian furniture in which the mortise and tenon joints were united by a composition of cheese.

Barefaced Tenons.—Fig. 125 illustrates the joint in its simplest form and shows a tenon having only one shoulder. This is called a barefaced tenon, and it will be noticed that the portion which carries the mortise is thicker than the rail on which the tenon is cut. The joint is therefore level (or flush as it is called) on one side only, and it should never be used at the corner of a frame. It is a useful interior joint for framing that has to be covered on the back side with matchboarding, and allows the work to

Joints in Woodwork

finish level at the back when the boarding has been applied (see plan).

Stub or Stump Tenon (Fig. 126)—also occasionally called a joggle tenon. The illustration shows a tenon as used in the interior of a frame. The tenon is not allowed to run through the stile, and unsightliness on the edge is thus avoided. This type of tenon is often used at the corner of a frame, and it then requires to be haunched.

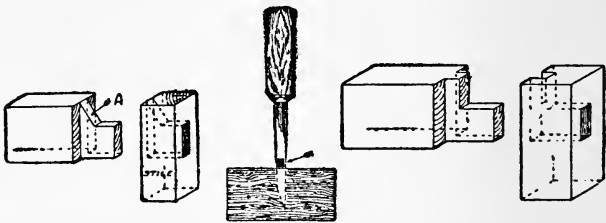

Fig. 127.
Haunched Tenon.

Fig. 128.
Gauging.

Fig. 129.
Haunched Tenon Joint.

A good workshop method of gauging the depth of the mortise for a stub tenon is shown in Fig. 128; a piece of gummed stamp paper is stuck on the side of the mortise chisel, indicating the desired depth of the mortise. This greatly facilitates the work, as it is not necessary to be constantly measuring

A Haunched Tenon, as used at the end of a door frame, is shown at Fig. 127. In this case it will be seen that the width of the tenon is reduced, so that sufficient timber will be left at the end of the stile to resist the pressure of the tenon when the joint is driven together. The short portion A, which is left on the tenon, is called the haunch, and the cavity into which it engages is called the haunching. The haunch and the haunching prevent the two pieces of timber lipping, or becoming uneven on

The Mortise and Tenon Joint

the face side, as would be the result if it were cut away entirely up to the shoulder.

Fig. 129 shows the type of tenon and haunch used when the stile or upright rail is grooved to receive a panel. In this and similar cases the haunch is made the same width and the same depth as the groove; the groove therefore acts as the haunching. An application of this joint is shown in the top rail of the door frame, Fig. 130.

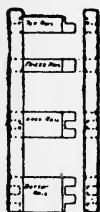

Fig. 130.
Application of
Haunched
Mortise and
Tenon Joints.



Fig. 131.
Occasional
Stump
Tenon.

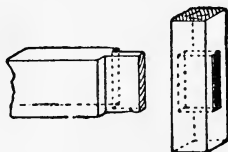

Fig. 132.
Joint for Inside
Framing.

This type of joint is also used to connect the rail to the leg of an ordinary kitchen table, Fig. 164.

Fig. 131 is a variation of the stump tenon, occasionally used where the work in hand demands a thin tenon and a stout stump to take heavy strains.

A Mortise and Tenon Joint, used for inside framing, is shown at Fig. 132, an application of its use being seen in the frieze rail, Fig. 130 (second rail from top). The rails may be used as shown in Fig. 132, but in the case of a door frame (as Fig. 130) they would have the inside edges grooved to receive the panels; the tenons would therefore be slightly narrower than shown, owing to the groove at each edge.

A Haunched Barefaced Tenon, used in similar positions

Joints in Woodwork

to Fig. 129, is shown at Fig. 133. The door or frame in this case would be made of matchboarding nailed on the back as shown in the plan, Fig. 125.

Fig. 134 is an illustration showing a haunched tenon, with the names of the various parts.

Wedges.—Fig. 135 shows the method of cutting wedges which are to be used to wedge the tenons; this avoids waste of material. Some workers cut the wedges from

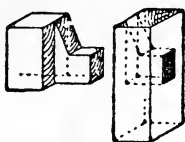

Fig. 133.
Haunched Bare-
faced Tenon.

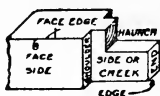

Fig. 134.



Fig. 136.—Stile
and Cross Rail
with Horn.

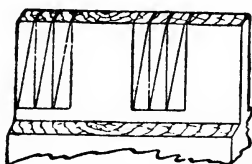

Fig. 135.—Cutting Wedges
from Waste of Haunching.

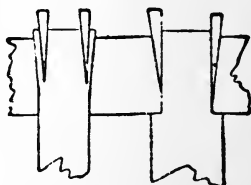

Fig. 135A.—Method of
Wedging Tenons.

the pieces left out of the haunching of the lock rail, or the bottom rail shown at Fig. 130.

A Stile and Cross Rail, framed together, are shown at Fig. 136. The portion above the rail is called the horn, and it is usual to leave sufficient length of stile to project above and below the cross rails, so that there will be no tendency for the stile to burst out at the end whilst the cramping and wedging of the frame is in progress. On completing the framing the horn is cut away.

The Mortise and Tenon Joint

In Fig. 137 A denotes a single line diagram of a field gate and the illustration above shows the method of tenoning the three pieces to the top rail, barefaced tenons being shown.

Fig. 138 indicates the method of fixing an interior leg to a table having a circular or straight top rail. The inlaid leg in this case is stump-tenoned into the top rail, and the inlaid portion of the leg is allowed to run through the rail, thus giving continuity of design.

Sprocket Wheel.—At Fig. 139 are shown the guide bar and chain of a chain-mortising machine, two enlarged links of the chain being indicated at A. The chain is

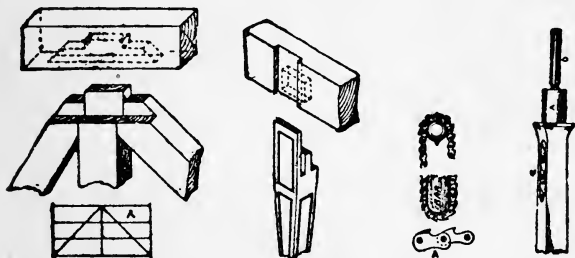

Fig. 137.

Fig. 138.

Fig. 139. Fig. 140.

Fig. 137.—Gate Joint. Fig. 138.—Fixing Interior Leg to Table. Fig. 139.—Sprocket Wheel. Fig. 140.—Mortising Tool.

similar in construction to the driving chain of a bicycle, with the exception that it is provided with teeth which cut away the timber as the chain revolves. When using a chain mortiser the portion of the machine carrying the chain is fed downwards into the timber, thus cutting a clean and true mortise. If, however, a stump mortise is required it is necessary to pare away a certain amount of timber by hand, because the machine obviously leaves a semicircular bottom to the mortise. To overcome this difficulty the latest type of mortising machines have a square hole-boring attachment fixed alongside the chain.

Joints in Woodwork

This tool, the working portion of which is illustrated in Fig. 140, consists of a square hollow chisel E, which is sharpened from the inside, and a revolving twist bit D, fitted with spurs or nickers, but without a point (one spur can be seen at the bottom of the illustration). This bit revolves inside the shell like a chisel, and bores away the superfluous timber, whilst the pressure exerted on the chisel causes the corners to be cut away dead square. A mortise $\frac{3}{8}$ in. square by 6 ins. in depth may thus be cut. The portion marked A is the shank of the chisel (Fig. 140), where it is fixed into the body of the machine, and the hole at E allows the boring bit to free itself.

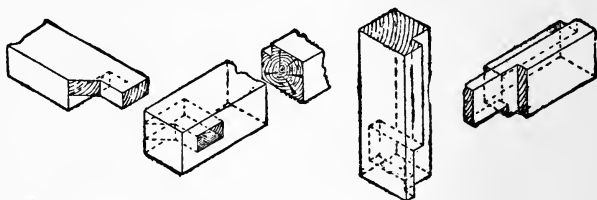

Fig. 141.—Haunched Tenon for Skylight or for Garden Frame.

Fig. 142.—Long and Short Shouldered Tenon Joint.

Fig. 141 shows the application of Fig. 133 to the making of a skylight or garden frame. In this and similar cases the side rails are rebated as shown in the section, and the bottom rail is thinner than the side rails to allow the glass to finish level upon it.

Long and Short Shouldered Joint.—Fig. 142 shows a haunched mortise and tenon joint having a long and short shoulder. This is a fairly common joint in framed partitions for offices, framing for greenhouses, tool sheds, etc., and is a frequent source of annoyance to the amateur. It is necessary to use this joint when both the stiles and uprights are rebated, and it calls for accurate marking out and great care in the making.

The Mortise and Tenon Joint

Fig. 143 shows the upright and rails of common garden or field fencing. The tenons are bevelled to fit and wedge each other in the mortise. The illustration shows both cross rails shouldered, but in many cases shoulders are omitted when the rails are not thick enough to carry them.

Fig. 144 indicates faulty methods of working a tenon. At *a* the saw has been allowed to run too far when cutting

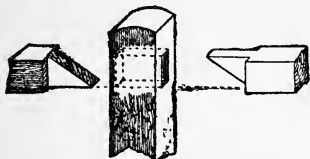

Fig. 143.—Joint for Fencing.

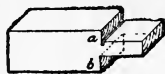

Fig. 144.—Faulty Tenon.

the shoulder, thus greatly weakening the tenon. At *b* faulty sawing has again occurred, and to remedy this defect the worker has resorted to paring the shoulder with a chisel. Had the chisel been used vertically an undercut

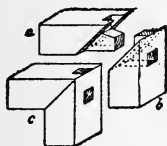

Fig. 145.—Japanese Tenon Joint.

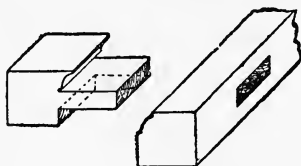

Fig. 146.—Tenoned and Scribed Joint.

shoulder (as at *b*) would not have occurred. The trouble now is that the slightest amount of shrinkage in the width of the stile will show an open joint. The result will be the same if it is necessary to remove a shaving or two when planing or levelling up the face of the frame.

A Japanese Tenoned Joint, little known and rarely used in this country, is shown at Fig. 145 *c*. The joint

Joints in Woodwork

open is seen at *a* and *b*. At *c* it is shown closed. It is of the soft-wedging variety and should be interesting to Manual Training teachers.

A Tenoned and Scribed Joint is seen at Fig. 146. The cross rail is cut at the shoulder, so as to fit the moulding which is worked on the stile. This is a good joint in everyday use.

Mitred and Moulded Joint.—Fig. 147 shows a type of joint largely used in light cabinet work. The method of mitreing the moulding and tenoning the stile to rail is indicated.

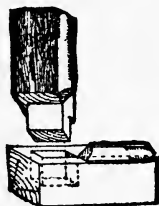

Fig. 147.—Mitred and Moulded Joint.

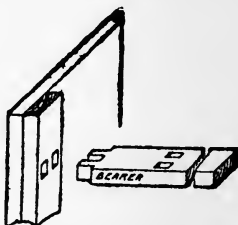

Fig. 148.—Twin Tenons.

Twin Tenons (Fig. 148).—The method of tenoning the bearers which carry the drawers, or the midfeather between two drawers, in a dressing table or similar carcass is here shown. On completion, the tenons on the midfeather are wedged diagonally.

Pinning.—Fig. 149 shows the tenoning of the inside end of a wardrobe to the top of the carcass. This is also called pinning. The tenons should be wedged diagonally. The tenons and the distance between the tenons are more satisfactory if made equidistant, because if slight shrinkage occurs this is partially equalised. The width between the tenons should in no case exceed 3 ins.

Top Rails.—At Fig. 150 is shown the method of joining the top rails to the post of a tool shed or similar outhouse.

The Mortise and Tenon Joint

The two rails, which are at right angles to each other, are half-lapped and mortised; the tenon on the post runs entirely through them.

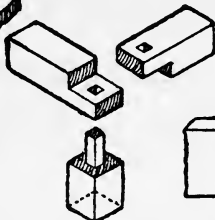
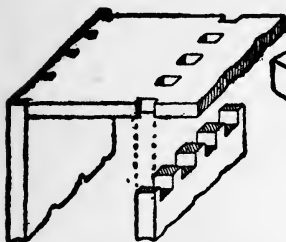

Fig. 149.—Pinning.

Fig. 150.—Joining
Top Rails of
Upright Post.

Fig. 151.—Tusk
Tenon.

A Tusk Tenon Joint, with wedge, as used to secure the binder to the girder when making floors, is indicated at Fig. 151. The tenon here is narrow, and engages with the mortise, which is situated in the compressional fibres

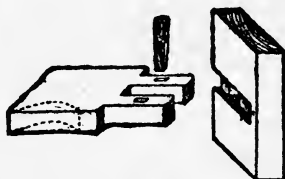

Fig. 152.—Another Tusk
Tenon.

Fig. 153.—Tusk Tenon and
Wedge.

immediately adjoining the neutral layer. In our illustration the mortise has been cut to show the interior.

Fig. 152 is a variation of the above joint.

Fig. 153 shows tusk and wedged tenons as used when making a portable book or medicine cupboard like Fig. 154.

Joists in Woodwork

The shelf is housed into the end, and the tenons run through the end and are secured by wedges. This allows the article to be quickly and easily taken to pieces for removal or re-polishing. The dotted line in Fig. 153 indicates that the shelf may be shaped if desired.



Fig. 154.
Medicine Cupboard.

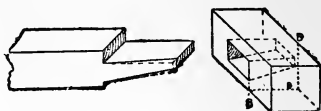

Fig. 155.
Wheelwright's Joint.

Wheelwright's Self-wedging Mortise and Tenon Joint.—In Fig. 155 the line B, B, B is carried around the timber so as to clearly illustrate the amount of taper given to the mortise.

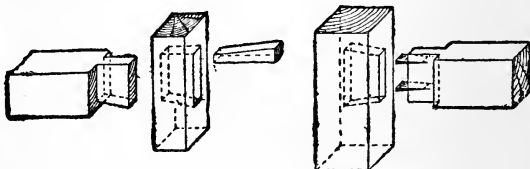

Fig. 156.—Dovetail and Wedged Tenon. Fig. 157.—Fox-wedging.

Dovetail and Wedged Tenon (Fig. 156).—When two pieces such as the cross rail and leg of a carpenter's bench are required to be held together by a mortise and tenon, and to be readily taken apart, the tenon is dovetailed on one side and the mortise is made of sufficient width to permit the widest part of the dovetailed tenon to pass into it. When the tenon is in its position a hardwood wedge is driven in above the tenon, as shown.

The Mortise and Tenon Joint

Fox Wedged Tenon (Fig. 157).—This is the method of securing a stub tenon by small wedges. The mortise is slightly dovetailed and two saw cuts are made in the tenon about $\frac{3}{16}$ in. from each side. Into each saw kerf

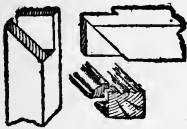

Fig. 158.—Joint with Mitred Face.

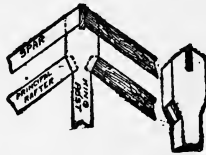

Fig. 159.—Rafter Joint.

a wedge is inserted and the joint glued up. The cramping operation forces the wedges into the saw cuts, thus causing the end of the tenon to spread and tightly grip the mortise.

Mortise and Tenon with Mitred Face (Fig. 158).—This is a useful method of jointing framing which has a square

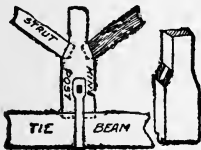

Fig. 160.—Roof Joints — Tie Beam, King Post and Strut.

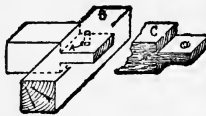

Fig. 161.—Draw-bore Pinning.

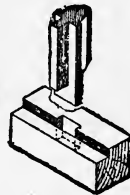

Fig. 162.—Tenoning Moulded Sash Bar.

edge as shown; and it is equally useful even if the face edges have moulds worked upon them. If the joint has square edges a rebate may be formed to accommodate a panel by fixing a bolection moulding around the frame. A section of the bolection mould planted on the frame is shown in the lower figure.

Joints in Woodwork

Rafter Joint.—Fig. 159 shows the method of tenoning the principal rafter to the king post.

Roof Joints.—Fig. 160 illustrates the tenoning of the struts to the king post, and the king post to the tie beam. Both these examples are used in roof work.

Drawbore Pinning.—At Fig. 161 is seen the method of securing a tenon by drawbore pinning, employed when it is not convenient to obtain the necessary pressure by



Fig. 163.
Tenon with
Tongued and
Grooved
Shoulder.

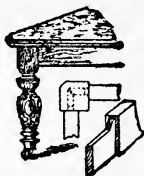

Fig. 164.
Table
Framing.

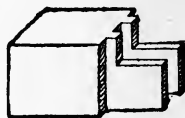

Fig. 165.
Twin Tenons with
Haunch, for thick
Timber.

using a cramp. The joint is made in the usual manner, and a $\frac{3}{8}$ -in. twist bit is used to bore a hole through piece B. The tenon is driven home and the hole is marked on the side of the tenon; the tenon is then withdrawn and the hole bored about $\frac{1}{8}$ in. nearer to the shoulder than as marked at C. When the tenon is finally inserted the holes will not register correctly, and if a hardwood pin be driven into the joint it will draw the shoulders of the tenon to a close joint and effectually secure the parts.

Sash Bars.—Fig. 162 shows how to tenon a moulded sash bar to the rebated cross rail. In this illustration both shoulders of the moulded bar are shown square, but in the best class work these shoulders may be slightly housed into the cross rail to prevent side play. This type of joint is used for horticultural buildings, etc. If the lower rail

The Mortise and Tenon Joint

be moulded with the same members as the sash bar, the end of the sash bar will have to be scribed on to it to make a fit.

Tenon with Tongued and Grooved Shoulders (Fig. 163).—The object of the tongues and grooves here are to prevent the face of the work casting, or becoming warped, and thus spoiling the appearance of the surface of the work. If framing is to be veneered on the face side this is an exceptionally good method.

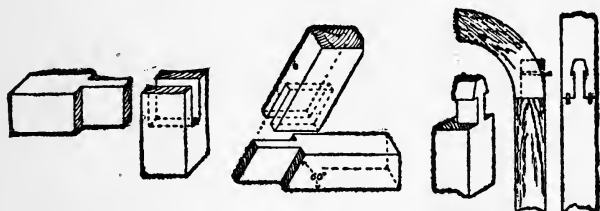

Fig. 166.—Open Slot Mortise.

Fig. 167.—Open Slot Mortise at 60° angle.

Fig. 168.—Hammer Head Tenon.

Table Framing.—Fig. 164 indicates the framing of a rail to a dining-table leg. In cases similar to this the tenons run into the leg and almost touch each other. They are therefore mitred on the end as shown in the inset. Chair frames often call for similar treatment.

Twin Tenons with haunch, as used when the timber is of great thickness, are shown in Fig. 165.

An Open Slot Mortise at the end of a right-angled frame is seen in Fig. 166. Fig. 167 shows an open slot mortise and tenon joint at the end of a frame of 60°. Both these joints are occasionally called end bridle joints.

Hammer Head Tenons.—At Fig. 168 is shown the method of jointing framing having semicircular or segmental heads. The front elevation indicates the method

Joints in Woodwork

of wedging the joint so as to draw up the shoulders; the end view shows the tonguing of the shoulders, which is necessary if thick timber has to be wrought. The sketch depicts the stile when taken apart from the head of the frame.

Clamping.—Fig. 169 shows the method of tenoning drawing boards, desk tops and secretaire falls. This is commonly called clamping. The method is used to prevent wide surfaces from winding. A variation of the joint is

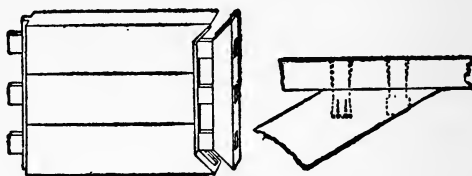

Fig. 169.—Clamping. Fig. 170.—Inserted Tenons.

shown at the left-hand side, the corners in this example not being mitred.

Inserted Tenons (Fig. 170).—Where two pieces of timber run together at an acute angle it becomes necessary to use inserted tenons. Both pieces of the timber are mortised and the inserted tenons are secured into the widest piece. On the left is shown the inserted tenon, secured by the method known as fox-wedging; on the right the inserted tenon has been let into the wide rail from the edge. The narrow rail is secured by wedging the tenons from the outside edge in the ordinary manner.

Wide and Narrow Rails.—Fig. 171 shows the tenoning of a wide to a narrow rail when the joint is at an angle.

Dreadnought File.—At Fig. 172 is a sketch of a portion of a dreadnought file. This has superseded the old-fashioned home-made float used to clean out the sides of a mortise.

The Mortise and Tenon Joint

General Rule.—In practically all cases where a single tenon is used the thickness of the tenon should be one-third

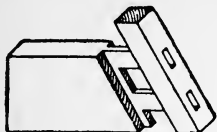

Fig. 171.—Tenoning a Wide and a Narrow Rail.



Fig. 172.—Dreadnought File.

the thickness of the timber. This leaves the timber at each side of the mortise the same strength as the tenon.

Mortise and tenon joints for inside work may be united

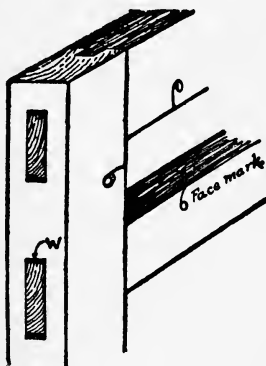

Fig. 173.—External and Internal Tenon Joints.

with glue. If, however, the work has to stand the weather a better method is to unite the joint with white lead, which is run down to the required consistency with good outside varnish.

Joints in Woodwork

SETTING OUT AND MAKING THE JOINT.

The Principal Use of the mortise and tenon joint is in the construction of various types of framing, such as door and window frames. In one or other of its many and varied forms it may be classed as the most important joint in the general woodworking trade. The joint may be used as an internal one, as shown at the lower rail, Fig. 173,

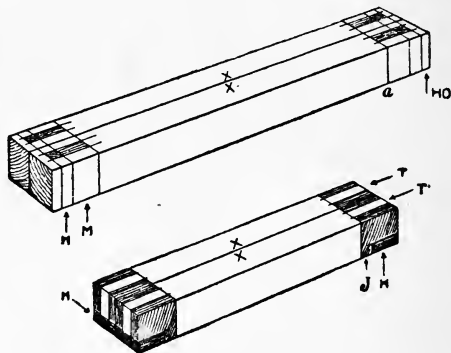

Figs. 174 and 175.—Setting Out Stiles and Rails for Mortise and Tenon Joints.

or as an external joint, as the upper rail of the same illustration.

Planing.—Whatever type of framing has to be made, it is necessary that the face side of the wood be planed up straight and out of winding, and the face mark (as shown in Fig. 173) pencilled upon it. The best edge of the timber should next be planed up true in length, and square to the face side, and the edge mark X clearly placed upon it.

The Marking Gauge is now set to the desired width, and gauge lines are marked on the wood, after which the

The Mortise and Tenon Joint

waste wood is planed off until the timber is the required width. The thickness is gauged and treated in a similar manner, except in such cases where the finished work is to be of a rough and ready character.

The two Stiles or upright rails have their faces turned to touch each other, as shown at Fig. 174; and their length may be anything from 1 in. to 3 ins. longer than

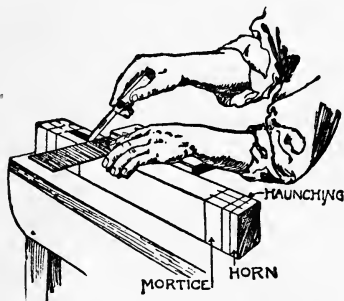

Fig. 176.—Setting Out the Stiles with Marking Knife.

the required finished size. This waste wood at each end of the stiles, as shown by the arrow HO, is of importance to the work, as it prevents to a great extent the bursting of the mortise whilst cutting the hole or when knocking together the work. The small projection is called the "horn," and it is cut off after the frame has been put together.

The two Cross Rails, Fig. 175, have their faces placed together as shown in the sketch. These rails may with advantage be left $\frac{1}{2}$ in. longer than the finished size, and the portion of the tenon (which will protrude through the stile $\frac{1}{4}$ in. at each end) may be cut off after the work is put together.

Joints in Woodwork

Set out the Stiles with a marking knife or penknife and a try square, as shown at Fig. 176. In this sketch only one stile is shown for clearness of representation, but two or more stiles (as at Fig. 174) may be marked out at the same time, provided a 12-in. try square be used; in fact, marking out the stiles in pairs is to be recommended, as all cross lines will be exact, owing to their being marked

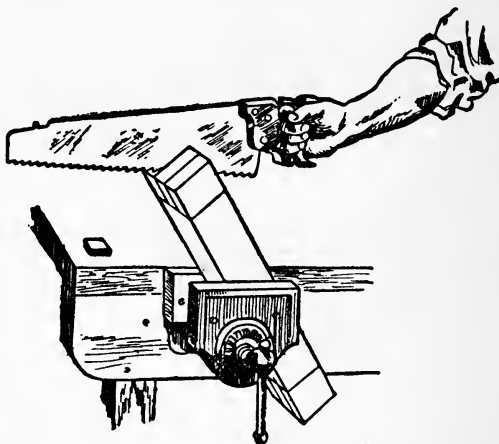

Fig. 177.—How to Saw the Tenons—First Operation.

at the same operation. The cut made by the marking knife should be lightly carried all round the work as the mortising is cut from each edge of the stile, the cutting of the mortising being finished in the centre. The lettering on Fig. 174 is as follows:—HO, horn; M, position of mortise; H, position of haunching; *a*, inside line, or sight size, as it is occasionally called.

Set out the Cross Rails as at Fig. 175, lower sketch. The lettering in this figure is as follows:—T, tenons; the small piece of the tenon lettered J is called the haunch,

The Mortise and Tenon Joint

and the shaded portion H is cut away to allow the haunch J to fit the haunching of the stile.

The Tenons are generally one-third the thickness of the timber, thus leaving the same amount of substance at each side of the tenon as the tenon itself is composed of. The mortise gauge is set to the required distance and used as already described (see Fig. 82).

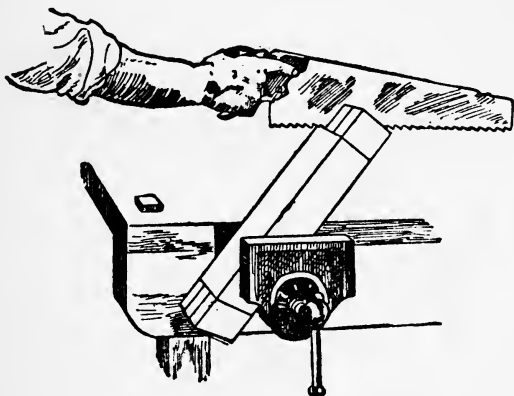

Fig. 178.—Second Operation in Sawing Tenons.

To saw the Tenons, place the rail in the vice as at Fig. 177 and, with a panel, tenon, or hand saw, according to the size of the work, cut down the outside of the tenon line as shown. Reverse your position and cut as shown at Fig. 178, then place the rail in a vertical position, and you will find little or no difficulty in sawing down square with the shoulder line. Repeat the above methods of sawing until all the tenons are sawn.

Next saw out the pieces at the side of the tenon by the following procedure. Place the rail against the bench stop, or in the vice, and cut a small channel in which to

Joints in Woodwork

run your tenon saw as shown at Fig. 179. If you have scored the line deeply with your knife when you were marking out the work, you will have little difficulty in removing a small portion with the chisel. The amount removed in the illustration is, of course, exaggerated. In the small channel thus made place the tenon saw and, guiding the saw blade with the finger so as to keep it upright

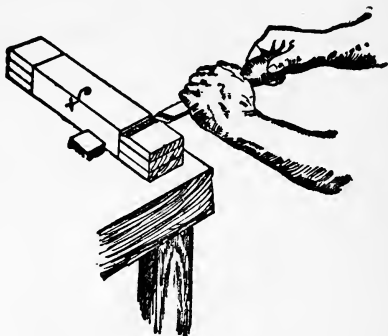

Fig. 179.—Cutting Channel at Shoulder of Tenon before Sawing.

or square (Fig. 180), saw away the waste material. Remove the waste material at the sides of the tenons in a similar way, and then saw out the portion marked H, Fig. 175, lower sketch.

The Mortising of the stiles may next be taken in hand by putting the stiles edgeways in the vice and boring away the bulk of the waste wood from the mortise with a suitable-sized twist bit and brace. This method will save a great amount of noise, as to a great extent it does away with the use of the mallet. Take the mallet and chisel and chop down about $\frac{3}{8}$ in. as shown at Fig. 181; then turn the chisel to the position shown at Fig. 182 and

The Mortise and Tenon Joint

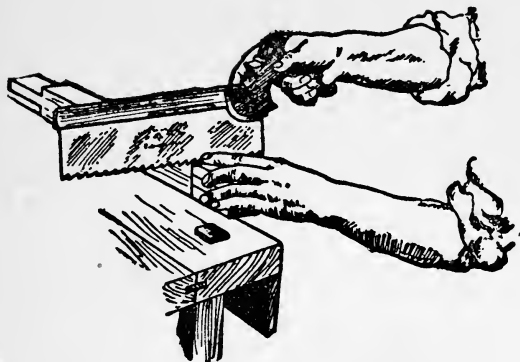

Fig. 180.—Sawing away Waste Material.

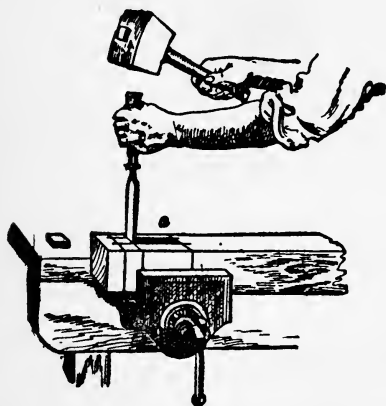

Fig. 181.—Using the Chisel and Mallet for Mortising.

remove the small piece as shown. Continue these two operations until you are about half-way through the wood and then start in a similar manner at the line *a*, Fig. 181,

Joints in Woodwork

after which turn the other edge of the timber uppermost and repeat the methods shown.

Fig. 183 shows the sketch of a mortise which has its side removed so as to show the method of successive cuts with a chisel when removing the core from a mortise; this, in conjunction with the other sketches, clearly shows

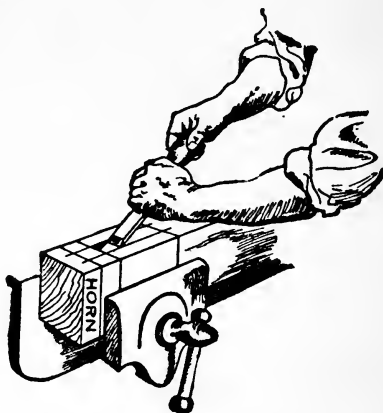

Fig. 182.—Removing Waste of Mortise with Chisel.

the methods of working. In many woodwork examinations the examiners insist that the mortise shall be removed by successive cuts with the chisel, but we certainly advise the removal of much of the waste wood with a boring bit, provided the worker can keep straight and well within the limitations of his gauge lines.

Removing Haunching.—After removing the mortise hole, the small portion which is called the haunching will require to be removed with a chisel. This calls for no special remark, as it is clearly shown in Figs. 185 and 186. Fig. 184 shows an everyday type of mortise and tenon

The Mortise and Tenon Joint

joint separated; it is used in cases where a straight joint is required on the upper or lower edge of the work, whereas

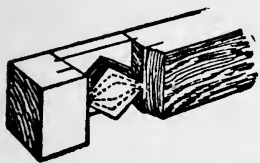

Fig. 183.—Mortise with Side Removed.

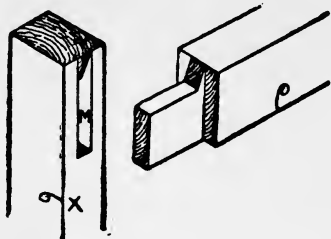

Fig. 184.—The Joint Separated.

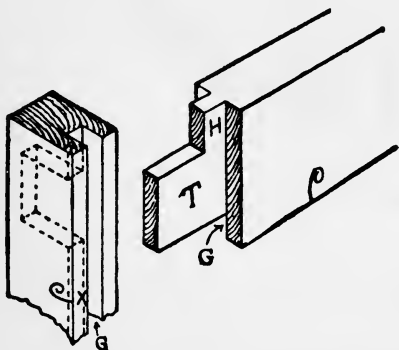

Fig. 185.—Removal of Haunching.

the upper rail of Fig. 173 shows the full haunch on the top edge. In cases such as Figs. 185 and 186, where the edges of the frames are grooved to receive panels, etc., the width of the tenon is reduced by the width of the groove.

Joints in Woodwork

This must be remembered by the worker when marking out his stiles with the marking knife. Fig. 185 (right-hand sketch) shows the haunch, tenon, and groove G at the bottom. Fig. 186 (left-hand illustration) shows G (groove) at top, and HH (the haunch) at the bottom. Tenons may be glued together and wedged as shown at Fig. 173 if for

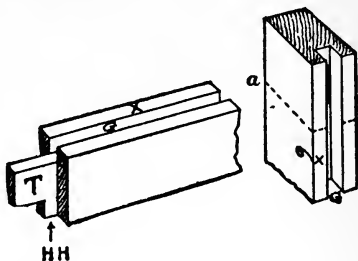

Fig. 186.—Haunching with Groove above.

inside work ; but if for outside work they are generally smeared with thick paint and wedged up. For light-class cabinet work it is usual to cut the mortise about seven-eighths of the distance through the stile and make the tenon to match it ; the edge of the finished work does not then show any indication of the joint, and it leaves a nice clean surface at the edge of the work for polishing or varnishing.

THE DOWELLING JOINT

DOWELLING is the term generally given to the method of jointing timber and other materials by wooden or metal pegs, which are called dowels.

The idea of jointing timber in this manner probably occurred to some observant woodworker whilst cleaving a piece of spruce or other variety of timber with the axe. When cleavage takes place in a piece of knotty timber it is often noticed that the fibres of the



Fig. 187.
Probable Origin
of Dowelling.



Fig. 188.
Double
Pointed
Nail.

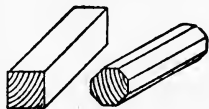

Fig. 189. Fig. 190.
Method of Making
a Dowel.

wood are severed, leaving a protruding portion of the knot which bears a remarkable resemblance to a dowel (Fig. 187), and this may probably be the origin of dowelling. It would naturally suggest to any woodworker the idea of placing pegs or dowels at right angles to the joint, thereby strengthening the work.

With regard to pegs or dowels which are not made of wood, we shall only give one or two instances in this article. Iron dowels are used to secure the uprights of door frames to the stone step, and dowels made from iron nails are occasionally used for packing case making. Fig. 188 shows a double-pointed nail, which is used as a dowel in rough work, such as the making of soap and

Joints in Woodwork

sugar packing boxes. One half of the nail is driven into the edge of the board in the ordinary manner; the two or more boards which are desired to be jointed are then laid face down on the bench, and the necessary pressure is obtained by the use of a cramp so as to force the points of the protruding nails into the adjoining board. Needless to say, this method is only used for the roughest class of work.

For cabinet-making and similar work straight-grained beechwood dowels are mostly used; these may be bought by the gross, in lengths of about 36 ins., and of any desired diameter.

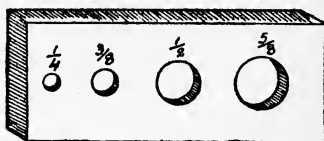

Fig. 191.—Steel Dowel Plate.

Making Dowels.—Many amateurs, however, prefer to make what they require for the work in hand, and the following is the method that is generally employed. Pieces of straight-grained wood are wrought to a square section as at Fig. 189, after which the corners are planed away to form an octagonal section as Fig. 190. The sharp corners shown at Fig. 190 are now planed away, and the roughly formed dowel is driven through a steel dowel plate, Fig. 191, by the aid of a heavy hammer, thus giving the necessary roundness and finish to the dowels. When hammering dowels through a plate the hammer should on no account be allowed to come in contact with the face of the dowel plate, or the cutting edge of the hole will be spoilt. Simply drive the dowel to within $\frac{1}{8}$ in. of the plate and knock it out with the next dowel.

The Cradle.—Planing the corners off piece Fig. 189 is a difficult matter, and to facilitate this a "cradle"

The Dowelling Joint

(Fig. 192) is made and kept for the purpose. The advantage of a cradle is obvious, preventing as it does any tendency

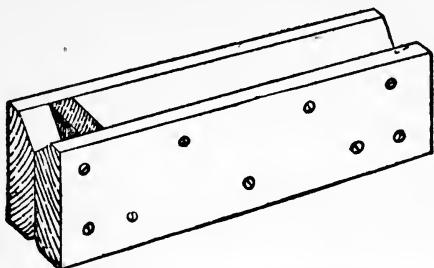

Fig. 192.—Cradle for Planing Dowels.

of the partly-formed dowel to slip or wobble. A jig, or cradle, is easily made by bevelling the edges of two separate

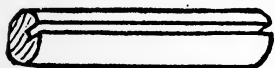

Fig. 193.



Fig. 194.

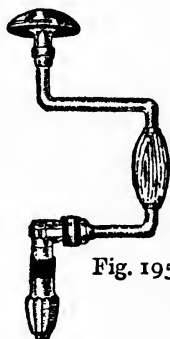

Fig. 195.

Fig. 193.—Dowel with Groove.

Fig. 194.—Method of Grooving Dowels.

Fig. 195.—Brace.

pieces of wood and then glueing and screwing them together as at Fig. 192. A small block of wood is inserted to act as a stop whilst the planing operation is in progress. It is usual to bevel both edges of the timber from which the

Joints in Woodwork

cradle is formed, thus accommodating all sizes of dowels from $\frac{1}{4}$ in. to $\frac{1}{2}$ in. in diameter.

Fig. 193 shows a completed dowel with a small groove running along its entire length. The object of this groove is to allow the air and superfluous glue to escape and thus avoid splitting the work on hand ; the groove also secretes a certain amount of glue, which increases its hold on the timber.

Fig. 194 shows the top portion of the end view of a

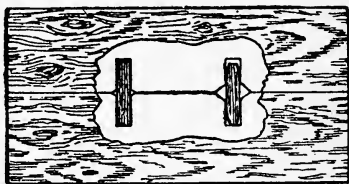

Fig. 196.—Good and Bad Dowels.

bench and illustrates the method of grooving the dowel longitudinally by means of a saw kerf. The dowel is secured in the bench screw as shown, and the top edge of the vice jaw acts as a guide to the tenon or dovetail saw whilst sawing the groove, or "saw kerf" as it is called.

Dowelling.—Fig. 196 shows a broken drawing of two boards jointed by dowelling. The dowel on the right shows a very bad method ; the countersink, or rose bit (Fig. 197), and the dowel rounder (Fig. 198) have been too liberally made use of, and the dowel has been cut much too short to engage with the hole in the upper board. The illustration at the left shows what should obtain, viz., just sufficient clearance between the top of the dowel and the hole, and a very slight countersinking at the joint of the board.

Regarding the use of the dowel rounder (Fig. 198), many experienced workmen delete this tool from their

The Dowelling Joint

kit and prefer to slightly hammer the arris or sharp edge round the end of the dowel and thus crush the fibres so that they will expand when they come in contact with the liquid glue, and in this manner spread out and wedge tightly in the hole.

Fig. 200 illustrates the method of marking out and gauging two boards for dowelling. The edges of the boards are first shot to a true joint; then the face sides

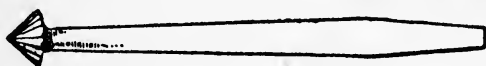

Fig. 197.—Countersink.

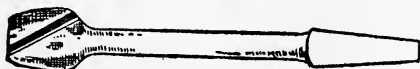

Fig. 198.—Dowel Rounder.



Fig. 199.—Twist Bit.

are placed together and the lines for the dowels are marked across the edges with a fine pencil and the aid of a try square. The boards are then gauged from the face side, thus giving the points indicated in the sketch.

To start the twist bit, Fig. 199, it is a good plan to prick the board at the point of intersection of the marked lines with a sharp, circular-pointed marking awl. This obviates any tendency of the boring bit to run out of truth and thus cause unevenness on the face side of the jointed board.

A safe rule for the spacing of dowels when jointing sideboard tops, dressing table and wardrobe ends, etc., is to place the dowels 9 ins. to 10 ins. apart, and place two dowels at each end as shown at Figs. 200 and 201.

Joints in Woodwork

The length of the dowels should be about $\frac{7}{8}$ in. to $1\frac{1}{4}$ in. long.

Fig. 201 shows the two boards prepared ready for

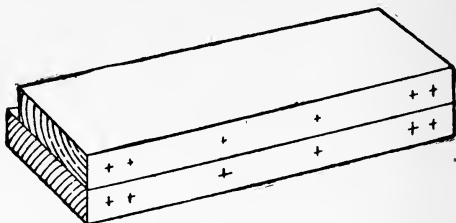

Fig. 200.—Marking and Gauging Boards for Dowelling.

glueing. The upper one is bored to receive the dowels, and the lower one shows the dowels glued in position. It is customary to warm the edges of the boards before

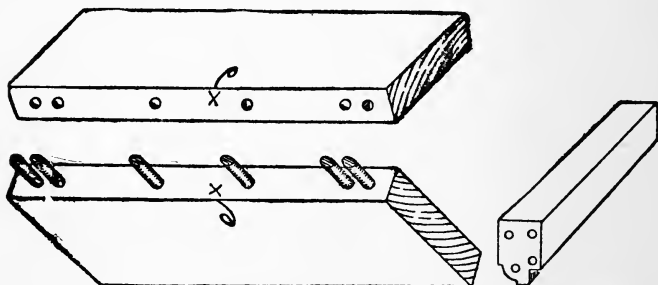

Fig. 201.—Boards ready for Glueing.

Fig. 202.—Method of Dowelling Thick Timber.

spreading the glue, and cramps are required to squeeze the joint tight. These should be left on the jointed board from one to four hours according to the state of the weather. In cases where thick timber (say 2 ins. or $2\frac{1}{2}$ -in. boards)

The Dowelling Joint

is to be jointed, two rows of dowels may be used, the position of the dowels being alternated as at Fig. 202.

VARIOUS APPLICATION OF DOWELLED JOINTS.

Fig. 203 shows the plan of a 3-in. cornice pole made to fit a bay window; the straight portions of the pole are generally turned in the lathe, the corner portions being afterwards jointed and worked up to the required shape.

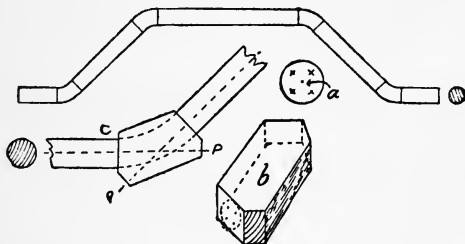

Fig. 203.—Method of Dowelling Cornice Pole by Means of Template.

To avoid any difficulty in the setting out of the dowels, a disc of cardboard or sheet metal is made to the same diameter as that of the cornice pole; this disc is called a template. The positions of the dowels are set out geometrically, and the centres are pricked through with a fine-pointed marking awl (see sketch of template, *a*, Fig. 203). The template is put on the ends of the straight pole, and the dowel centres are pricked into the wood. The process is repeated on the ends of the corner block (*b*, Fig. 203), and if the holes be now bored at the centres indicated a true fit will be obtained.

Fig. 203 *c* shows two portions of the circular pole jointed up to a corner block, and the dotted lines *P* indicate the direct line of pressure and shows the position for the cramp. When the glue is thoroughly set the corner block

Joints in Woodwork

is sawn and spokeshaved to the desired shape as shown by the dotted line. This method is illustrated to show that, by the use of a suitable template, dowels may be exactly set out even when there is no straight or square face from which to use a marking gauge, and the method may, of course, be applied to many other examples of dowelling at the discretion of the workman.

Mitred Frame.—Fig. 204 shows a mitred and dowelled frame. One corner only is shown; it needs little or no

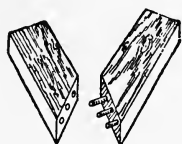

Fig. 204.
Dowelling a
Mitred Frame.

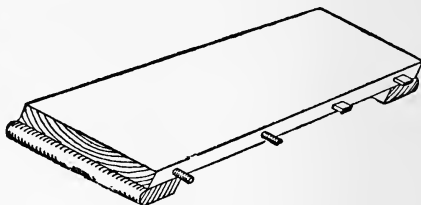

Fig. 205.—Table Leaf with Dowels.

explanation beyond the fact that the dowels should be at right angles to the line of joint, and consequently the dowel at the outside edge of the frame will have to be much shorter than the others. This gives a strong and serviceable joint, suitable for many purposes.

Dining Table.—Fig. 205 is a leaf for the screw type of table. Circular dowels are shown at one end, and rectangular wooden pegs at the other; both methods are equally good, and, of course, the dowels are only glued into the leaf. The object of these dowels is to guide the table leaf into its proper position when the leaf engages with the table proper, and to make the flat surface of the table top and leaf register correctly and thus ensure a level surface.

Frame Dowelling.—Fig. 206 shows one corner of a frame with long and short shoulder, such as occurs when the upright is rebated through its entire length. The holes in both pieces

The Dowelling Joint

are bored for the dowels before they are rebated. This avoids any difficulty in endeavouring to bore with only one side of the twist bit in the wood. A similar type of joint is used on nearly all kinds of glass and door frames in cabinet work.

Fig. 207 is a wooden block made in two portions and held together by screws; it is used to fasten around a twist bit, the object being to ensure that all the dowel holes are of uniform depth. It may be adjusted as desired

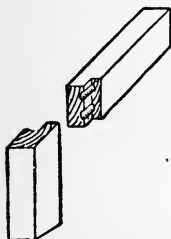

Fig. 206.—Frame Dowelling.

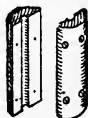

Fig. 207.
Block for
Twist Bit.

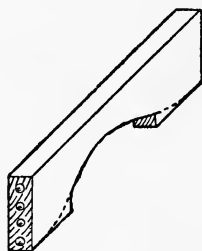

Fig. 208.—Shaped
Rail.

and firmly screwed round the twist-bit; if the hole is made $\frac{1}{2}$ in. in diameter it will clip round a $\frac{1}{4}$ -in. or $\frac{3}{8}$ -in. bit and will answer a dual purpose. It is a preventative for bad dowelling, as shown at Fig. 196.

Fig. 208 is a shaped top rail, such as is used for a wardrobe glass frame, showing position of the dowel holes and the lugs left for cramping purposes. After the frame is glued up and thoroughly set the lugs are cut away along the dotted line and this gives the desired finished shape.

Fig. 209 is an example of dowelling framing when the moulding on the edge has to be mitred. It is necessary to cut the shoulders away so as to allow the members of the moulding to intersect. The section of the mould is not shown in the sketch for clearness of representation. The portion marked H is called the "horn," and it is not

Joints in Woodwork

cut off until after the frame is glued up ; its object is to prevent the rail splitting or bursting when knocking up the frame or during the cramping process.

Fig. 210 shows the method of dowelling a moulded cap to the top of a wooden bedstead post or similar pillar where it is desired to avoid any unsightliness.

Fig. 211 is a sideboard pillar, showing the dowelling

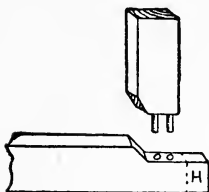

Fig. 209.—Dowelling for Moulded Frame.

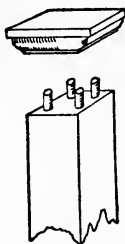

Fig. 210.
Cap.



Fig. 211.
Turned Pillar.

of the bulbous or acorn portion to the upper and lower turned shaft. An iron double-pointed screw is used to connect the dowels in the interior (see sketch, broken drawing).

Fig. 212 is a dining-table leg and portion of the framing, showing the method of dowelling the frame to the leg. Chairs, couch frames, etc., are made in a similar manner.

Fig. 213 shows the top portion of a table leg and a home-made dowel gauge. The gauge is made of any hardwood, and steel wire pins are driven through at the required positions and sharpened similar to the spur of a marking gauge. The legs are sawn and planed up true and square, and the advantage of the gauge is that all legs are marked exactly alike and are therefore inter-

The Dowelling Joint

changeable until glued up. A gauge of this type is easily and quickly made and may be kept for its specific purpose or altered for other work.

Fig. 214 indicates the Queen Anne type of leg, a sketch of same broken below the knee also being given.



Fig. 212.

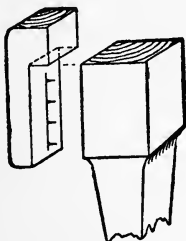

Fig. 213.

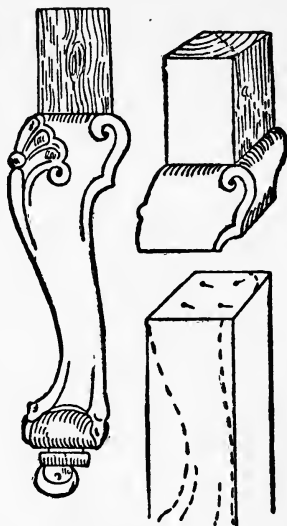

Fig. 214.

Fig. 212.—Dowelling a Dining-Table Leg.

Fig. 213.—Dowel Gauge
for Legs.

Fig. 214 —Dowelling a
Cabriole Leg.

Here we have another type of irregular setting out, which is accomplished in the following manner. Saw and plane the broken portion of the leg true as shown; take the timber which is to be jointed and treat it in a similar manner; now place four ordinary pins on the lower portion. Carefully place the top portion to the required position and smartly give it one tap with the hammer; this will cause the pin-heads to leave indentations, and

Joints in Woodwork

if these be taken as centres for boring, accurate work will result. The new portion of the leg is afterwards sawn and wrought to the desired shape.

This is an example of work where it is next to impossible to use a gauge, and as only one joint is required it is not worth the time taken to make a template.

Fig. 215 shows the dowelling of a pediment or top shaping on to a washstand back. The pediment is required

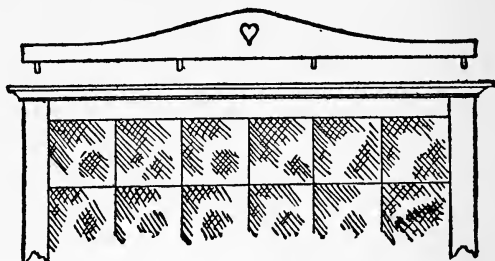

Fig. 215.—Dowelling a Washstand Pediment.

to be taken off from time to time for convenience of removal or re-polishing. As the shaping will come below the eye, screws at the top edge would appear unsightly; thus dowelling is resorted to in this and similar cases.

The tools used in dowelling are: Brace, twist-bit, dowel-rounder countersink, try-square, marking-awl, and the usual bench tools. The first four are illustrated at Figs. 195, 199, 198, and 197 respectively.

The method of working is: Plane up, mark out, bore holes, countersink, glue dowels, and complete joints.

THE SCARF JOINT

THE method known as "scarfing" is used for the joining of timber in the direction of its length, enabling the workman to produce a joint with a smooth or flush appearance on all its faces. One of the simplest forms of scarfed joint is known as the half lap, in which a portion is cut out at the end of each beam or joist, equal in depth to half the full

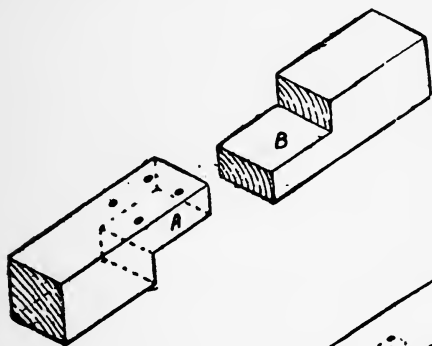

Fig. 216.—Half-Lap Scarf Joint.

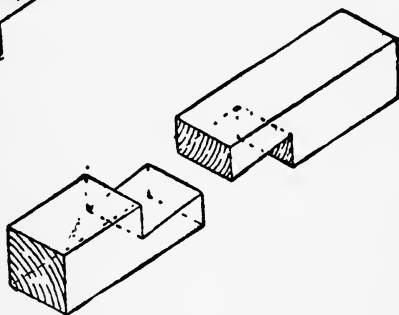

Fig. 217.—Dovetailed Scarf Joint.

depth of the beam, and of equal length to the required scarf.

Joints in Woodwork

The two pieces before they are placed together form a joint as shown at Fig. 216, the projecting part A fitting into the recessed portion marked B and the two pieces being secured in their respective positions by screws.

Fig. 217 shows a dovetailed scarf joint. This is a variation of Fig. 216, the length of the dovetail lap being from 6 ins. to 8 ins. in length.

Fig. 218 is an illustration of a joint designed to

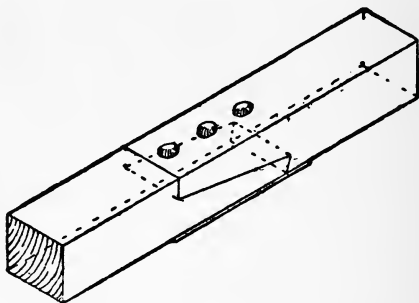

Fig. 218.—Joint Used in Roof Work.

resist a cross strain. The face side is left flush, whilst the underside is assisted by an iron plate. The joint is secured with nuts, bolts, and washers. This type of joint is frequently used for joining "purlins" in roof work; the iron plate on the underside is in this case omitted.

Fig. 219 is designed to resist both tension and compression and is an excellent joint for all purposes. The joint is brought together by using folding wedges as shown in the centre.

Fig. 220 is a variation of Fig. 219, and it will be noticed that tenons are provided on the face and underside to resist cross strain. Probably this joint is one of the best varieties of the scarfed joint. Unfortunately, however, its production is somewhat costly, and this may be the

The Scarf Joint

reason that it is not more universally used. Folding wedges are used to secure the two pieces in position.

Fig. 221 is a scarfed joint with undercut vee'd ends which prevent the joint from lipping up or down or sideways. It is a useful joint, calling for careful setting out and accurate craftsmanship. Folding wedges are used in this case to draw up and secure the joint.



Fig. 219.—Tenoned Scarf Joint.

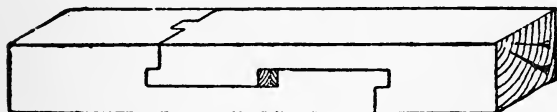

Fig. 220.—Double Tenoned Scarf Joint.

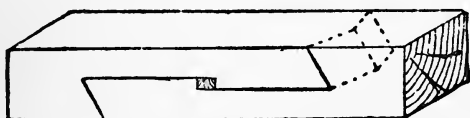

Fig. 221.—Scarf Joint with Vee'd ends.

Fig. 222 is a "fished joint," and the following difference between a scarfed and fished joint should be noted. A fished joint need not necessarily reduce the total length of the beams to be joined, and fish plates of wood or iron (or a combination of both) are fastened at each side of the joint. In a scarf joint all surfaces are flush. In Fig. 222 the beams are butt-jointed and secured by wooden plates and iron bolts. The upper plate is let into each beam, and the lower plate is provided with two wooden keys to prevent the beams sliding (or "creeping") upon the lower

Joints in Woodwork

plate. Iron nuts, bolts, and washers are used to complete the joint.

The methods of scarfing and fish-jointing are many and varied, and, in selecting a joint, the nature of the pieces to be joined and the direction and the amount of the load should be carefully taken into consideration.

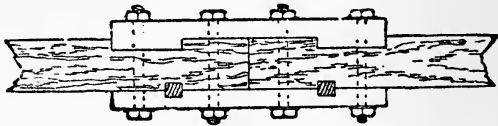

Fig. 222.—Fished Joint.

The above joints come under the heading of carpentry, and the ordinary tools such as the saw, plane, boring-bit and chisel are all that are requisite and necessary to produce a sound and serviceable joint. Scarfed joints are generally of large size, and they are usually made by placing the work upon sawing trestles owing to the bench being too small to accommodate the large timbers.

THE HINGED JOINT

ONE of the most common forms of hinged joint in use to-day is that formed by using the "butt" hinge, and many troubles experienced by the amateur, such as "hinge-bound," "stop-bound," and "screw-bound" doors, etc., are due to a lack of knowledge of the principles of hingeing. Hinges call for careful gauging and accurate fitting, otherwise trouble is certain to occur.

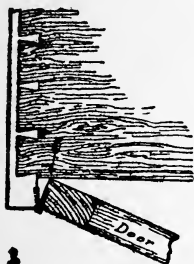

Fig. 223.—Stop-bound Door.



Fig. 224.—Butt hinge.

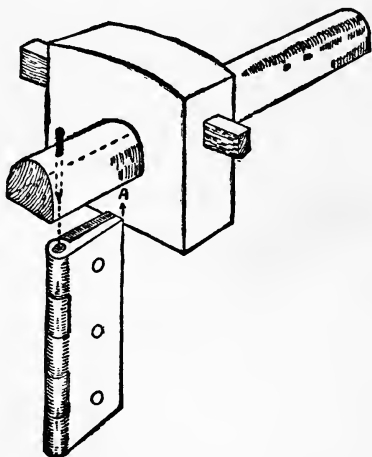

Fig. 225.—Gauging.

"BOUND" DOORS.

Hinge-bound.—A door or box lid is said to be hinge-bound when the recess which contains the hinge is cut too deep. The frame and the body portion engage too

Joints in Woodwork

tightly with each other when closed, the result being that the door has always a tendency to open a little. This fault may be in many cases remedied by packing behind the hinge with one or two thicknesses of good stiff brown paper. For packing purposes such as this paper will be found to be of much more value than thin strips of wood or knife-cut veneer, the latter always having a great tendency to split when a screw or bradawl is inserted.

A Stop-bound door is the name applied when the door is not finished to exactly the same thickness as originally intended. This causes the door to bind on the stops at the back, as shown at Fig. 223. The difficulty may be remedied by thinning the door a little at the back, or slightly rounding away the portion which binds.

Screw-bound is a common fault often overlooked by the amateur. It is caused by using screws of which the heads are too large for the countersunk holes in the hinge, and may be avoided by slightly sinking the holes in the brasswork with a countersink or rose-bit.

ALIGNMENT.

Alignment.—Another fault that is fairly common is having the axes of the hinges out of alignment. Especially is this the case when three hinges are used to hang a wardrobe or other large door. It is absolutely necessary in all cases that the exact centre of the pivot-pin of the hinges should be in a straight line.

Hingeing of Shape-Fronted Work.—Particular attention to alignment is necessary when the body and the door frame are shaped on the face side. A familiar example that every reader may inspect for himself is the curved side of a railway carriage body and railway carriage door, where he will notice that a specially wide hinge has to be used at the bottom of the door to give the necessary

The Hinged Joint

alignment. Hinges fixed on work with their centres out of truth are often overlooked by the inexperienced worker.

IMPORTANCE OF GAUGING.

Fig. 224 is a sketch of a brass butt hinge, open. Fig. 225 illustrates a similar hinge closed, and shows the gauge

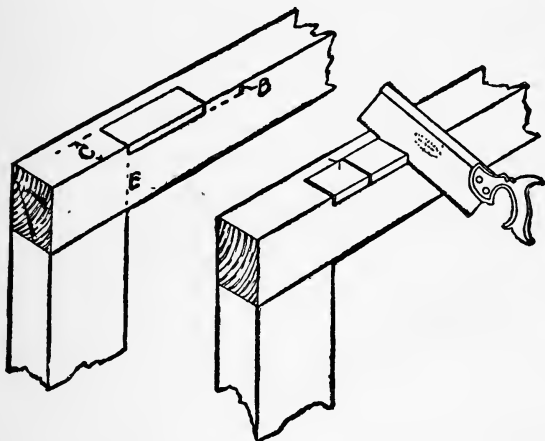

Fig. 226.—Marking.

Fig. 227.—Cutting the Recess.

set so that the point of the marker is exactly to the centre of the pivot-pin. This distance we will call C. Now turn to Fig. 226. The distance C has been gauged from the face side of the frame. The gauge is then set to the thickness of the hinge at its thickest portion, and to prevent "hinge-bind" see that the gauge is set on the *fine* side. Remember that the tapered point of the steel spur or marking-awl will part the fibres of the timber a little more than the fine point, and give you a wider gauge line than was anticipated when you set the gauge. The inex-

Joints in Woodwork

perienced worker nearly always overlooks this. The result is a hinge-bound door, the cause of which is not discovered by the worker because he is so sure that he has set the gauge correctly. The distance B, Fig. 226, shows the line gauged for the thickness of the hinge.

HINGED JOINTS.

Position of Hinges.—Another difficulty to the beginner is the position for his hinges, and it may here be stated

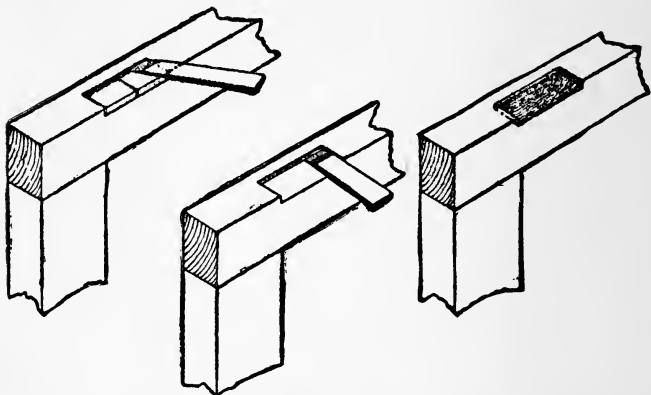

Fig. 228.
Paring.

Fig. 229.
Clearing.

Fig. 230.
The Recess.

that the general rule is to carry a line across the face of the work from the inside of the cross rail and place the hinge at E, as Fig. 226.

Sawing for the Recess.—After marking out for the hinge, as shown at Fig. 226, take a fine-toothed saw (a dovetail saw is considered the best) and saw down as shown at Fig. 227, care being taken not to cut beyond the gauge lines. In this sketch three saw kerfs are shown,

The Hinged Joint

but if the hinge is of great length, say 5 or 6 ins., the removal of the waste wood will be greatly facilitated by the addition of intermediate saw kerfs. These cuts sever the cross fibres and allow the timber to be easily pared away in short lengths.

Paring out the Recess.—Fig. 228 illustrates the method of paring away the wood by first cutting a small piece away up to the gauge line. This forms a sort of trench

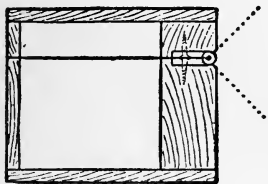

Fig. 231.

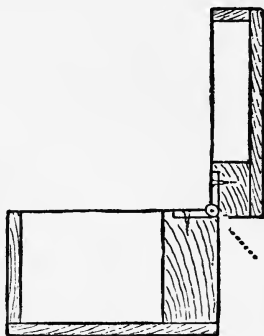

Fig. 232.

The Hingeing of a Box Lid.

or shoulder and prevents overcutting when taking away the bulk of the material. Fig. 229 shows the chisel clearing out the bottom of the recess, leaving it clean, smooth, and quite level. At Fig. 230 the recess is shown completed and ready for the hinge to be screwed in its position.

Stopped Hinged Joints for Box Work.—Fig. 231 is a section through a small box similar to a lady's workbox (the back of the box in the illustration is enlarged in thickness to clearly show the position of the hinge). In this case the knuckle of the hinge is let into the woodwork until it is flush with the back of the box, and the gauge

Joints in Woodwork

would have to be set to the total width of the hinge. The back edges of the lid and the back edge of the lower portion of the box are planed away at an angle of 45 degs. as indicated by the dotted lines.

Fig. 232 shows the same box with the lid open, and it will be observed that the chamfered edges come together and form a stop which prevents the lid falling backwards



Fig. 233.—Strap Hinge.



Fig. 235.—Pivot Hinge for Screens.

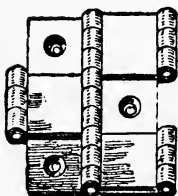

Fig. 234.—Reversible or Double-folding Screen Hinge.

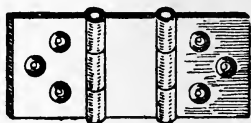

Fig. 236.—Non-reversible Screen Hinge.

and breaking the box. This method of letting-in the knuckle flush is a useful one for box work because the ordinary stock brass butt hinge can be used. Attention may, however, be called to the "stopped butt-hinge," which is specially made to answer the above purpose; in its action the same mechanical principle as the one applied to the box is used.

The Hinged Joint

VARIOUS HINGES.

Types of Hinges.—Fig. 233 is an elongated variety of the butt hinge, known in the trade as “strap hinge,” “desk hinge,” or “bagatelle hinge.” As its name indicates it is used on folding bagatelle tables, small writing desks, and other types of work that have but a narrow margin

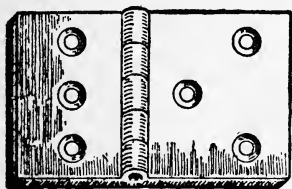

Fig. 237.—Back Flap Hinge.

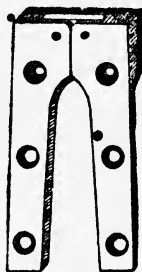

Fig. 238.—Card Table Hinge

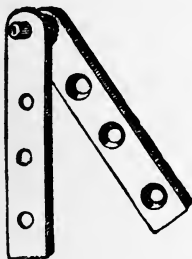

Fig. 239.—Pivot Hinge.

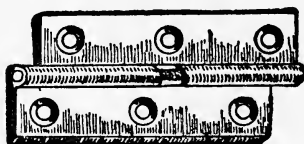

Fig. 240.—Rising Butt Hinge.

on which to fix the hinges. The long, narrow plates are sunk flush into the wood, the knuckle or rounded portion projecting.

Fig. 234 is an illustration of the reversible or double-folding screen hinge. Half the thickness of this hinge is let into each wing of the draught screen, allowing the screen to be folded either way. The hinge is costly, but effective in use.

Joints in Woodwork

Fig. 235 is a type of pivot hinge which is used to fix at the top and bottom of a screen.

Fig. 236 is the non-reversible screen hinge and, as its name implies, will only fold in one direction.

Fig. 237 is a back flap hinge with a specially wide wing, used for the fall-down leaf of small tables and similar articles.

Fig. 238 is a card table hinge. This is let into the edges of the table, so that all is flush or level both above and below the surface.

Centre or Pivot Hinges.—Fig. 239 is a centre or pivot hinge, used on the top and bottom of wardrobe doors, more particularly the interior door of a three-winged wardrobe where the method of fixing is confined to the cornice and plinth. The portion carrying the pins or pivot is let into the top and bottom of the door, the remaining (or female) portion being let into the cornice and plinth respectively.

Rising Butt Hinges.—Fig. 240 is the rising butt hinge, used on dining and drawing room doors, so that when the door is opened the door rises sufficiently to clear the thickness of the carpet. This hinge has also an advantage over the ordinary butt hinge in that it is self-closing, *i.e.*, the weight of the door *plus* the bevel on the hinge joint causes the door to close. Band and hook hinges and other ordinary varieties are too well known to require illustrating.

HINGEING IN AN ACUTE ANGLE.

Fig. 241 is a sectional drawing of a corner cupboard showing a good method of hingeing the door. The inset *a* shows an enlarged view of the corner carrying the hinge, also the adaptor piece *c*, which is fitted to the inside edge of the cupboard so that the hinged edges are at 90 degs. to the face. This is a far better and stronger method than

The Hinged Joint

that shown at *b*, which is often attempted with disastrous results. The incorrect method *b* allows insufficient wood for fixing purposes, and in nearly all cases the thin edge

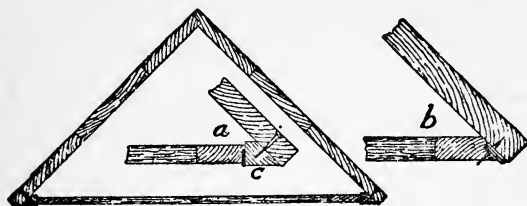

Fig. 241.—Hinging Door of Corner Cupboard.

of the door breaks away during the making and fitting, or soon after completion. The adaptor piece may have a face mould worked upon it to give a pilaster-like appearance if fancy so dictates.

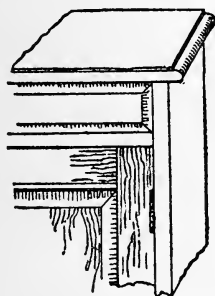

Fig. 242.—Inside Hinging.

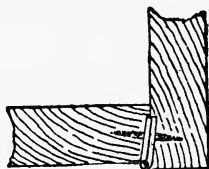

Fig. 243.—Section.

INSIDE HINGEING.

Fig. 242 is a sketch of one end of the lower carcass of a kitchen dresser, the door frame being hinged inside the carcass. In common work and in light cabinet work it

Joists in Woodwork

is permissible to let the whole thickness of the hinge into the door; and when screwing the door to the carcase it is usual to fix the knuckle of the hinge flush with the face of the carcase, thus allowing the door frame to stand back, making a break of about $\frac{1}{8}$ in. with the face. The marking gauge should be set to the full width of the hinge; the mark, gauged on the inside of the carcase end, thus forms a line to guide the worker whilst fixing the

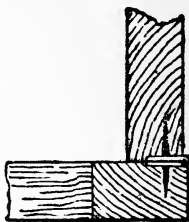
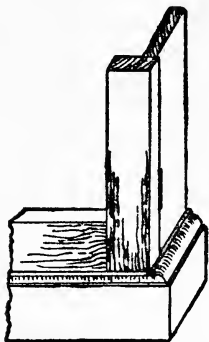

Fig. 244.—Outside Hingeing. Fig. 245.—Section.

door. To successfully fix a door it generally requires two persons, one to hold the door in position, whilst the other bores the holes and fixes the screws.

Fig. 243 shows the correct method of fitting butt hinges on high-class work. One wing of the hinge is let into the door, and the other wing is let into the carcase or door jamb, thus distributing a proportion of the weight to the carcase end instead of allowing the whole of the weight to be carried by the screws as would be the case in *a*, Fig. 241. The method of sinking each portion of the hinge into the door and carcase respectively is costly; hence it is not the general practice in cheap work.

The Hinged Joint

OUTSIDE HINGEING.

Fig. 244 illustrates the portion of a door frame and carcase end when the door is hung on the face of the carcase. The correct method of letting in the hinge is shown in the enlarged drawing (Fig. 245), but, as previously mentioned, the hinge may have its entire thickness let into the door frame where it is of a light character. The door frame projects slightly over the carcase end, and

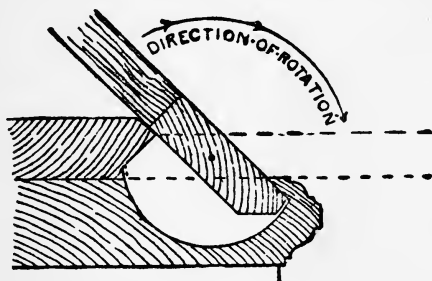

Fig. 246.—Fall Front of Writing Bureau.

occasionally a bead mould is worked on the edge of the door so as to give a finish and partly hide the joint. The bead would, of course, be the same size as the diameter of the knuckle of the hinge; and the knuckle, therefore, will form a continuation of the bead and give a workman-shiplike finish.

FALL FOR WRITING BUREAU.

Fig. 246 is a view (one end removed) of a fall front writing bureau fitted with centre or pivot hinges and arranged so that the edges form a stop when the desk front is turned to a horizontal position. The position for the fitting of the brass plates carrying the pivot-pin is somewhat awkward; but, by first sinking the plates into

Joints in Woodwork

the carcass ends, and then slotting the edges of the fall, it will be found that the fall front may be put in from its horizontal position, and that sufficient room is left to enable the screwdriver to be manipulated without inconvenience.

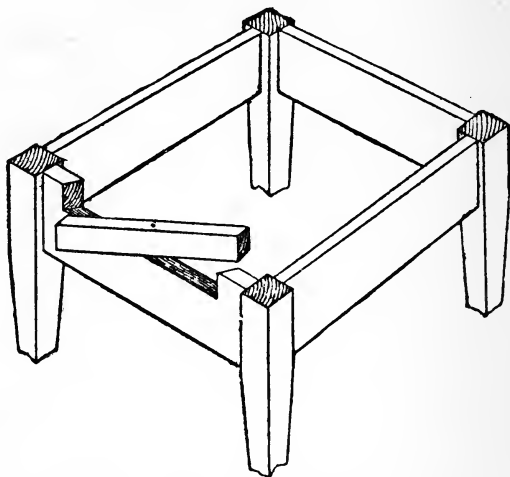

Fig. 247.—Revolving Fly Rail for Table.

REVOLVING FLY RAIL.

Fig. 247 is a sketch of a small table with the top removed. A revolving fly rail is shown pivoted upon a piece of $\frac{1}{4}$ -in. wire. The object of this fly rail is to form a support to the small hinged drop-leaf of the table. This method is suitable for small occasional tables and similar articles.

HINGEING DRAUGHT SCREENS.

Fig. 248 illustrates a portion of a draught screen which is constructed of a light framework and covered with

The Hinged Joint

baize or American cloth. The reversible double-folding hinge (Fig. 234) would answer admirably for such a screen. Cases occur, however, where it is desired to hinge a screen to be used for an invalid's bedside, and it is then important

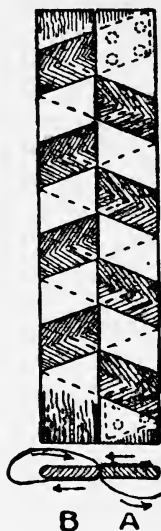
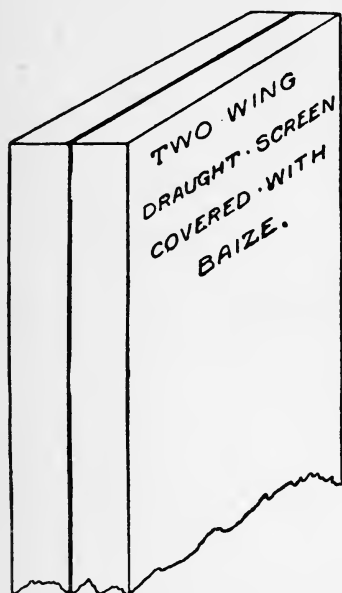

Fig. 248.—Hingeing Draught Screens. Fig. 249.—Plan.

that all draught should be excluded through the jointed edges. The double reversible hinge will not fulfil these conditions, and the following method is therefore adopted.

In the plan, Fig. 249, A and B, two laths of hardwood (beech, birch or mahogany answer splendidly) are shown. They are made the same length and the same width as the edges of the screen, the corners being slightly rounded away.

Joints in Woodwork

A double-folding, draught-proof hinge is then made as follows. Procure good fine webbing, about $1\frac{1}{4}$ in. wide, and the necessary large-headed tacks. Lay the laths side by side as shown in the elevation, Fig. 249, and proceed to web them as shown. Commence with the web under the lath A; bring it between the laths and over B; now take it round the left-hand edge of B, and round the back

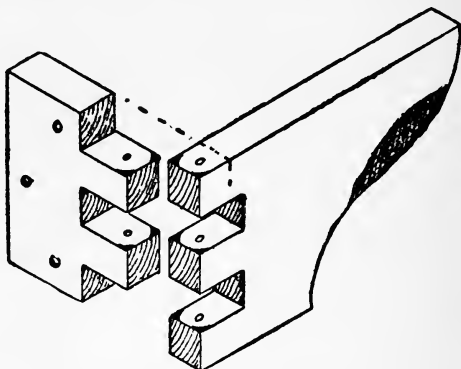

Fig. 250.—Finger Joint.

and between the laths and over A, continuing this method of wrapping the laths until the lower end is reached, and then fastening the webbing as indicated by the dotted lines which represent the tacks. This self-contained hinge is then fixed to the edges of the screen by boring suitable holes through the laths and using countersunk screws. This is a cheap and efficient method of overcoming the difficulty.

FINGER JOINT.

Fig. 250 is a finger joint—a movable interlocking joint used to support the leaf of a Pembroke table. The small portion is screwed to the table rail and the shaped bracket

The Hinged Joint

swings out to support the drop leaf. The shaded portion of the bracket shows the timber chamfered away so that the fingers may be easily put behind the bracket to manipulate it. Note that the corners are slightly rounded off, as indicated by the black portion of the sketch, and that the mortises are cut about $\frac{1}{4}$ in. deeper than the thickness of the timber used. This joint has now been almost superseded by a cheap stamped galvanised iron bracket of

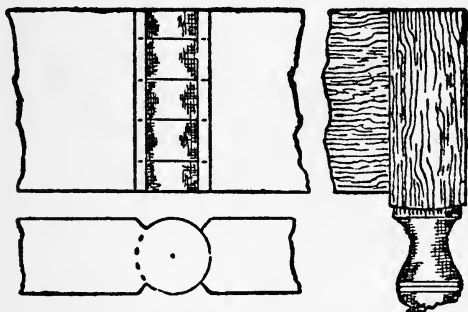
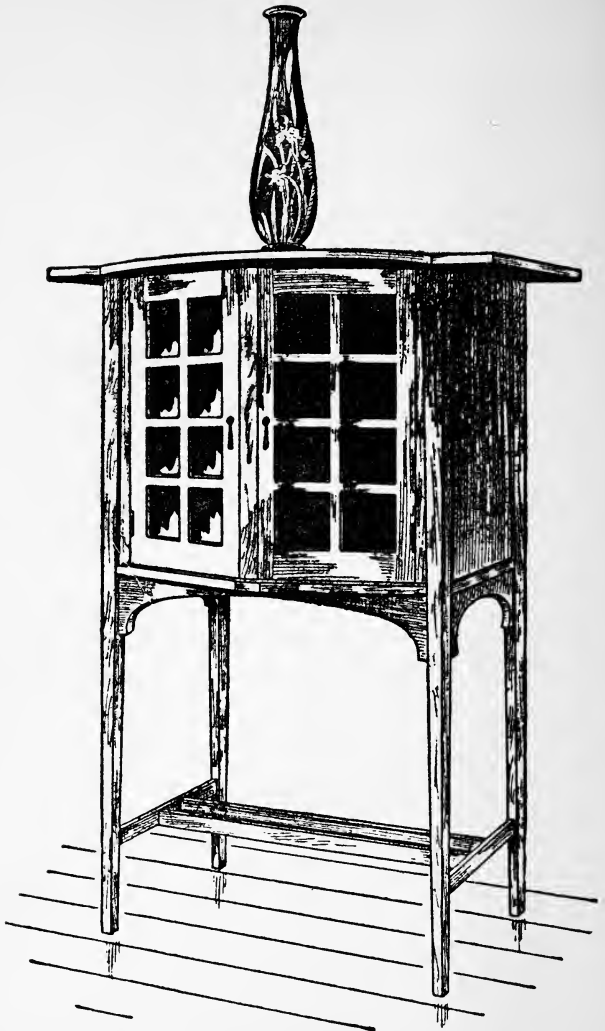

Fig. 251.—The Knuckle Joint Hinge.

exactly the same pattern sold at about 7*d.* per pair. The joint, however, is still used for repair work and in cases where a stamped metal bracket has not sufficient overhang.

NUCKLE JOINT.

Fig. 251 is a similar type of joint to the above, and is called the knuckle joint. This arrangement of hingeing allows the table leg to swing in an angle of 180 degs. and is much neater in its appearance. It is often used to connect a movable table leg to the framing, where it is necessary for the table leg and rail to swing outwards and support a drop leaf. The pivot is formed by a piece



China Cabinet.
Showing the use of loose Pilaster when hingeing.

The Hinged Joint

of $\frac{1}{8}$ -in. or $\frac{1}{4}$ -in. round iron rod running through the centre of the joint.

OPEN JOINT HINGEING.

The remaining illustrations apply more particularly to the hanging of the ordinary household door.

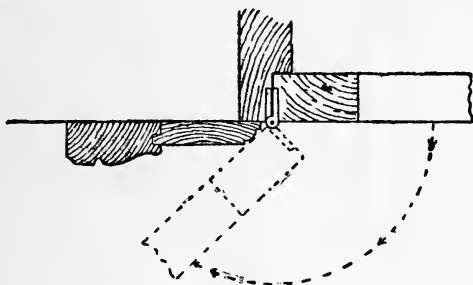

Fig. 252.—Open Joint Hingeing.

Fig. 252 is termed "open joint hanging," from the fact that when the door is open a certain amount of open

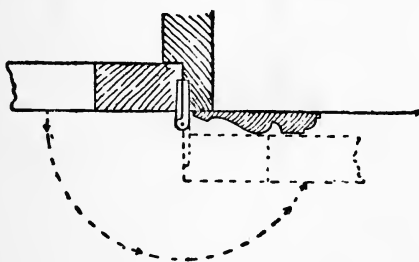

Fig. 253.—Clearing the Architrave Mould.

space exists between the edge of the door and the doorpost. This open space varies according to the position in which the butt hinge is fixed. A section is shown at which the

Joists in Woodwork

pin of the hinge is let in level with the face of the door. This will allow the door to open as shown by the dotted line, and it will not clear the architrave moulding.

HINGEING TO CLEAR THE ARCHITRAVE MOULD.

Fig. 253 indicates the position of the hinge fixed so as to allow the door to open and lay flat back to the architrave moulding. In this instance the butts are made with wider wings, and they are generally provided to take three screws (see Fig. 237, right-hand wing of hinge).

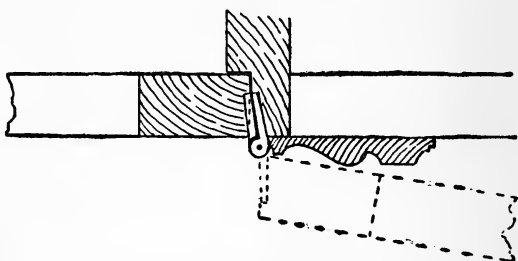

Fig. 254.—Close Joint Hingeing.

To determine the position of the centre pin of the hinge the following rule is observed. The centre of the pivot pin of the hinge must be *half the distance* between the face of the door, when closed, and the outside of the architrave moulding.

CLOSE JOINT HINGEING.

The method known as "close joint hanging" ensures the joint at the hanging stile being in close proximity to the hanging rail; this is shown at Fig. 254. The first member of the architrave moulding is generally a bead of the same diameter as the knuckle of the hinge. The butt hinge is let in as shown in the illustration, and the door when opened forms a close-fitting joint.

SHUTTING JOINTS.

THIS chapter deals with the joint made by the upright rail of a door frame which carries the lock, or handle, generally called the "slamming stile." Many and varied are the methods used to make a draught and air-tight joint at the meeting of the slamming stile and the carcase end, and our sketches illustrate some of the simplest and also some of the best and most expensive methods.



Fig. 255.

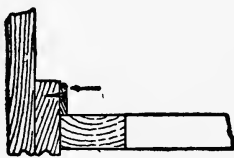

Fig. 256.

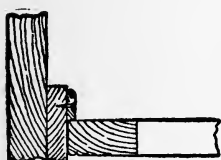

Fig. 257.

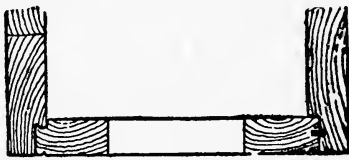

Fig. 258.

Illustrations of Cupboard Door Joints.

Fig. 255 is a part plan of the end of a simple cupboard of which the carcase end is all of one thickness (*i.e.*, not lined up in thickness). A small strip of wood is glued and screwed on the end to form a stop to the door and to prevent the access of dust to the interior of the cupboard.

Fig. 256 illustrates a similar method; the piece A has a bead formed on the back edge instead of the chamfer shown in the previous illustration. The carcase end in this case is lined up to give a pilaster-like appearance to

Joints in Woodwork

the end, and the moulding is selected on account of its suitability to hide the joint of the lining piece.

Fig. 257 is similar to Fig. 256. A bead moulding has, however, been worked on the edge of the door stile to hide the joint between the door and the end. In this case a similar bead would be worked on the hinged stile to match.

Fig. 258 is of a more intricate type, and is often used on jewellers' showcases. The end at the right hand is



Fig. 259.—Meeting Stiles.



Fig. 260.
Showing Rebated Astragal.



Fig. 261.
Showing Brass Astragal.

slightly rebated to receive the frame, and both the rail and the end are grooved with a plough plane. A separate bead is made and glued into the groove of the door frame, engaging with the groove in the carcase end when the door is closed.

The slamming stile and the end are worked with a hook joint, and if carefully made they are practically dust-tight.

Fig. 259 shows the meeting of two doors which open outwards, a separate piece of timber being made to form a rebated astragal mould and glued to the right-hand door. This method gives a neat and effective finish.

Fig. 260 is similar to the above, with the exception that the rail of the door is rebated to receive the astragal moulding. This method is preferred on the best class of work, because it shows no unsightly joint at the inside of the door frame.

Shutting Joints

Fig. 261 illustrates the type of joint made by using a brass astragal mould as employed on high-class work.

Fig. 262 is a sketch of a piece of brass astragal moulding, which may be procured from any cabinet-maker's ironmonger in suitable lengths. It is fixed in position by slightly rebating the edge of the door and fastening with ordinary countersunk brass screws.

Fig. 263 is a rebated joint, broken at the front by a double bead moulding. The illustration shows its application to a circular-fronted cupboard, and it will be noticed



Fig. 262. Fig. 263.—Curved Cupboard Doors with
Brass Astragal. Double-headed Rebated Joint.

that the hinged rails are received in a rebate which is worked on the carcase ends. The rebated joint at the centre of the two doors is worked slightly on the bevel, so as to allow for clearance when opening the door.

Fig. 264, is the hook joint used on good-class joinery and cabinet work. A pair of special wood planes are required to make the joint in a cheap and efficient manner. The cost of a pair of $\frac{5}{8}$ -in. hook joint planes is from 5s. to 6s. They are of similar size and general appearance to the ordinary ovolo moulding plane.

Fig. 265 is a special type of hook joint as used on larger work. The joint may be made by using the plough plane, the rebate plane, and a suitably-sized bead plane, the loose tongues being inserted as shown and fastened by screws and glue.

Fig. 266 is a rebated joint with loose tongue-slip and

Joints in Woodwork

astragal mould, suitable for frames over $1\frac{1}{4}$ in. in thickness. The loose tongue-slip is glued into the right-hand door frame.



Fig. 264.—Hook Joint.

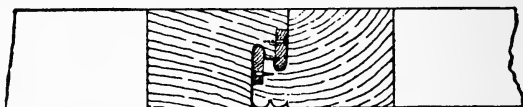

Fig. 265.—Special Type of Hook Joint.



Fig. 266.—Rebated Joint with Tongue Slip.

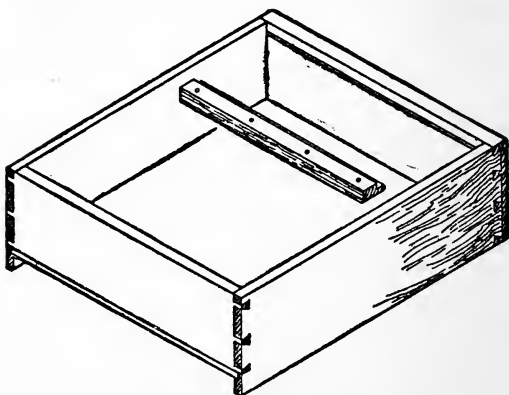

Fig. 267.—Dust-proof Drawer Joint.

Fig. 267 shows a shutting joint used to prevent permea-

Shutting Joints

tion of dust to the interior of a drawer. The drawer front is grooved and engages with a suitably-formed slip which is screwed to the bearer as at Fig. 268. Occasionally some difficulty is experienced when fitting the slip to a narrow drawer, but this can always be overcome by putting in the screws from the top of the bearer instead of from underneath.

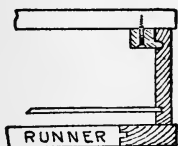

Fig. 268.—Detail of Drawer.

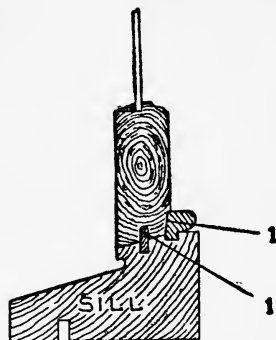

Fig. 269.—Draught Preventer. Fig. 270.—Window Sill Joint.

Fig. 269 is a sketch of a flexible draught-preventer made by inserting a rubber core A in strong canvas and cementing the joint. This can be obtained ready-made, and is used to put round any household door to check draught and noise. It is simply tacked in position with $\frac{5}{8}$ -in. tacks.

Fig. 270 is a sectional view of a window closing on to the sill which clearly shows how the joint may be made draught and rain proof; 1 and 1 show the inserted slips.

Shutting joints which are required to be "light-tight," such as those used in photographic work, are generally formed by slightly grooving the frame and inserting a strip of black velvet. The friction of the high pile of the velvet prevents the filtration of any light through the joint.

Joints in Woodwork

When making airtight showcases, one of the best and simplest tests is to place a lighted candle in the case and close all the doors; if the candle goes out within three minutes you have accomplished your object.

For the making of all the above joints a half-set of hollow and round planes, a $\frac{1}{4}$ -in., $\frac{1}{2}$ -in., and 1-in. rebate plane and a plough plane will be all that are required. Of course, those of our readers who possess a Stanley adjustable moulding plane will be able to dispense with the above tools.

THE DOVETAIL JOINT

NOTHING definite is known as to the origin of dove tailing, but a quaint and pleasing little story which is well worth repeating runs as follows:—Joyner Wood was called by Farmer Giles to do sundry repairs at the homestead. One day, whilst enjoying his dinner hour, he espied four doves occupying a position similar to that in our illustration. This suggested to him the idea of jointing his timber by the interlocking method; hence we have *dovetails* (Fig. 271).

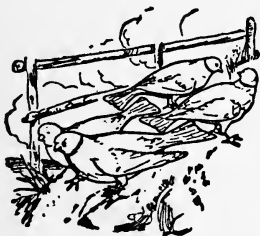

Fig. 271.—Dovetails.

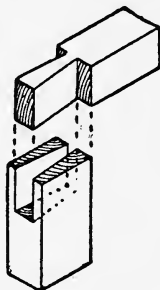

Fig. 272.—Through Dovetail.

Through Dovetailing.—One of the simplest forms of the dovetail joint is shown in Fig. 272, where two pieces of timber are joined by the method known as “through” dovetailing. This method is used in everyday practice for joining the corners of frames, bracket trusses, and a hundred and one other articles.

Fig. 273 shows the method of through dovetailing as applied to the making of boxes, plinths, and general

Joints in Woodwork

carcase work ; it is used in positions where no objection can be taken to the end grain showing on each side of the finished work. In the case of plinths and furniture cornices the foundation frame is made of yellow pine or other cheap wood, and the more expensive and rare timbers are glued and mitred around in various thicknesses and shapes, thus saving the more costly material and strengthening the construction by the method known as laminating. In

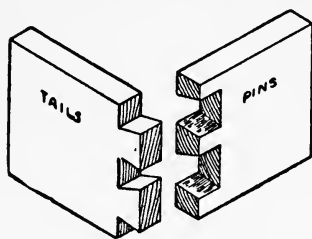

Fig. 273.—Dovetails for Boxes, etc.

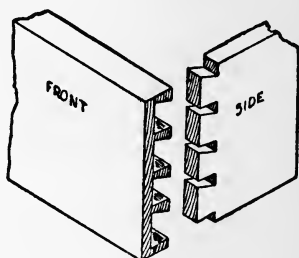

Fig. 274.—Lap-Dovetailing.

many cases all that is necessary is to veneer the face sides, thus covering and hiding any unsightliness.

Lap-dovetailing.—Fig. 274 is an example of lap-dovetailing, such as is used where a drawer side joins with the drawer front. It is not permissible to allow the end grain of the timber to show at the front of a drawer, and this is why lap-dovetailing is resorted to.

It is safe to say that the greatest use of the dovetail joint is for this and similar purposes, and we shall therefore deal fully with the methods of marking out and the making of this class of joint.

Angles.—A most important point in the construction of a dovetail is to avoid having the angles of the pins and tails too acute. An inclination of one in eight is considered

The Dovetail Joint

correct ; no hard and fast rule need be obeyed, but the variation should on no account be less than one in six.

Fig. 275 shows a simple method to obtain the correct angle. Take a piece of timber and plane up the face edge true and straight ; mark out a line at right angles to the face edge and space off 8 ins. as shown ; now measure a distance of 1 in. on either side of the line, and join this point to point eight. This will give the correct angle for the dovetails, and it may be transferred to the joiners' bevel as shown. Many workers who are constantly on

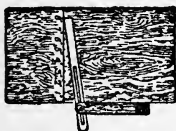

Fig. 275.—Setting out Bevels for Dovetails.



Fig. 276.—Faulty Cut ;
a shows where
Fracture will occur.

dovetail work make a zinc template to the exact angle and keep it specially for the purpose. Fig. 276 shows the result of cutting dovetails at an incorrect angle, the line *a* indicating where fracture will take place owing to shortness of grain.

Squaring.—Another important point to remember is that the drawer sides must be true and squared to an exact length and planed up to thickness ; otherwise the finished drawer will be in winding and out of square.

To true and square the ends of drawer sides, drawer backs and drawer fronts, a most useful little machine is the mitre trimmer ; failing this, excellent results can be obtained by using the shooting board.

Gauging.—After squaring up the timber accurate gauging of the ends is another important point. The

Joins in Woodwork

gauge used should be a cutting gauge, so that the line is incised about $\frac{1}{32}$ in. in depth, thus effectually cutting the cross fibres of the timber.

Fig. 277 shows the method of using the cutting gauge. The stock of the gauge must be held well up to the end of the timber. The gauge is a most difficult tool for the novice to use, and his trouble is generally caused by holding it too flat. Tilt the gauge a little, so that the

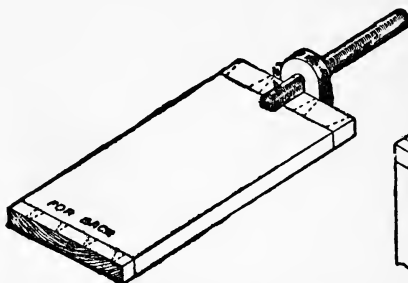

Fig. 277.—Method of Marking with Cutting Gauge.

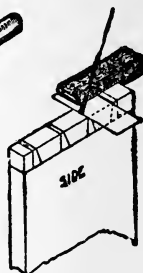

Fig. 278.—Squaring Lines across End.

thumbscrew shown in the illustration goes nearer to the floor; the blade will then not bite so keenly, and better results will be obtained. The dotted lines indicate the positions which the dovetails will occupy when marked out.

The gauge is set a trifle less than the thickness of the drawer sides so as to allow for the thickness of the steel cutter, and a gauge line is marked on the inside of the drawer front and all round the drawer back. The gauge is now readjusted so as to leave a $\frac{1}{4}$ -in. lap on the drawer front, and a line is marked on the ends of the drawer front and all round the ends of the drawer sides, which will engage with the drawer front. A glance at Figs. 274 and 277 will make this quite clear.

The dovetail pins on the drawer front and the drawer

The Dovetail Joint

back are now spaced out and marked on the end with the aid of the joiners' bevel, the lines being then squared down to the gauge line by the method shown at Fig. 278—that is, by using the try-square and marking awl.

Sawing.—The drawer front is now put into the bench vice, and the pins are cut as shown at Fig. 279. The drawer back is treated in a similar manner, but of course in this case it is not “lap” but “through” dovetailing, and the saw kerf goes through the timber and down to the gauge line.

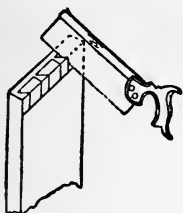

Fig. 279.—Method of Sawing Pins.



Fig. 280.—A Method of Roughing in Dovetails.

We now come to the point where it is necessary to remove the superfluous material. Fig. 280 shows a method commonly adopted and known as sawing out the waste; the saw is held at an angle and part of the inside portion of the dovetail is cut away as shown. This is a good plan for the amateur, because it clearly shows him at the commencement of his chopping out which will be the pin and which the tail.

Fig. 281 shows another method that answers well for soft woods such as pine, American whitewood and satin walnut. The drawer front is laid flat on the bench after it has been sawn, and with a mallet and sharp chisel the corner of the dovetail is knocked off as shown. This takes the bulk of the material away and the dovetail is then pared out square in the usual way.

Joints in Woodwork

A third method is shown at Fig. 282. With hard, curly timbers, such as tobacco mahogany and satinwood, it is a laborious process to carefully chop away the timber in small pieces, and to overcome this difficulty we occasionally see the workman take a twist-bit and bore a series of holes as shown. A great portion of the timber may then be split away by inserting the chisel end-way into the grain, after which it is pared to a finish.

As dovetailing is chiefly used for drawer making, it will be of interest to give several illustrations of variations of the joint and its uses.

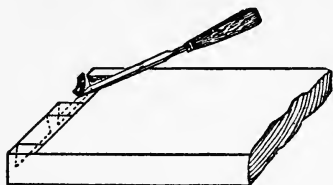

Fig. 281.—Roughing in Lap-Dovetail Pins with Chisel.



Fig. 282.—Roughing out by Boring.

MARKING DRAWER SIDES.

Fig. 283 indicates the method of marking the position of the holes in the drawer side. When the paring out of the dovetails is completed the drawer front is turned over on to the side as shown, and the position of the recesses which will engage with the pin portions are marked with the marking awl as illustrated.

The completed drawer back is marked on the sides in an exactly similar manner.

Another method of marking through dovetails is shown at Fig. 284. The side is held in position on the end, and the dovetail saw is inserted and drawn out of the saw kerf, thus leaving the exact mark on the drawer back.

The Dovetail Joint

Other workers prefer a pounce-bag instead of a saw. A pounce-bag consists of a piece of fairly open woven muslin filled with a mixture of French chalk and finely powdered whiting; the muslin is tied up with a piece of thin twine like the mouth of a flour sack. All that is necessary is to place the timber in position, as Fig. 284, and bang the bag on the top of the saw-cuts, when sufficient

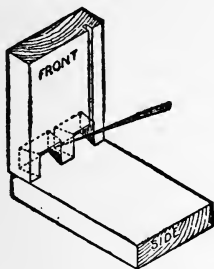

Fig. 283.—Marking Dovetail Pins on Drawer Side with Marking Awl.

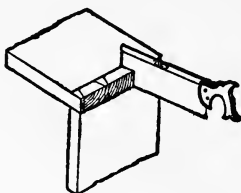

Fig. 284.—Marking through Dovetails with Saw Blade.

powder will pass through the bag and down the saw kerf to mark the exact positions of the lines.

SAWING THE DOVETAILS.

After marking out the pins on the drawer sides, we proceed with the next operation, that is, sawing the dovetails ready for chopping out the waste material. The drawer side is taken and firmly secured in the bench screw and sawn as at Fig. 285; it is most important that the saw kerf is kept *inside* the line which has been scratched by the marking awl. See Fig. 286, where the dotted line represents the gauge line and the thick outside lines indicate the scores of the marking awl. Failure to observe this

Joins in Woodwork

condition will result in faulty dovetailing, and it will also prove the necessity for using a finely-toothed and

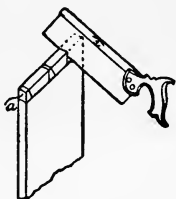

Fig. 285.
Sawing
Drawer
Side.



Fig. 286.
Showing
Gauge Lines
and Scores.

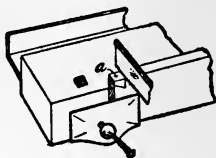

Fig. 287.
Holding
Drawer Side
in Vice.

thin-bladed dovetail saw. The writer has found an 8-in. dovetail saw to be the most convenient for drawer work.

We now come to the point where it is necessary to cut

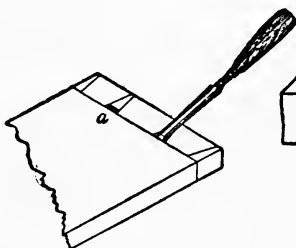

Fig. 288.
Cutting Channel.

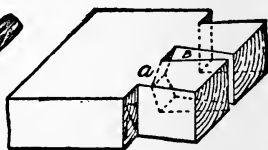

Fig. 289.
Showing Faulty Removal
of Waste Core.

away the waste wood (or core), and the usual procedure is to saw away the half-dovetails *a*, Fig. 285. With care, this can be accomplished with the dovetail saw, thus avoiding unnecessary labour and the use of the paring

The Dovetail Joint

chisel. Fig. 287 illustrates the method of holding the drawer side in the bench vice whilst the operation is completed.

After sawing, the drawer side is placed flat upon the bench, one end in contact with the bench to prevent the drawer side from slipping away; a chisel (preferably bevelled edged) of suitable width is now taken and a small channel is cut as at *a*, Fig. 288. The method of cutting

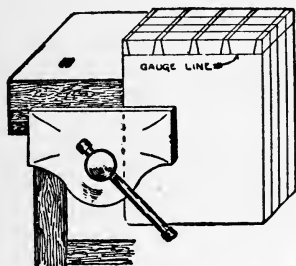

Fig. 290.—Cutting several Dovetails at once.

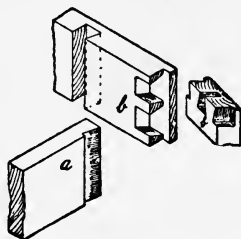

Fig. 291.—Frame Joint, showing parts separated.

this channel is shown in the same illustration. The chisel-cut is started about $\frac{1}{8}$ in. from the gauge line; the cut is made right up to the gauge line, which (when gauging) was made $\frac{1}{32}$ in. deep so as to cut the cross fibres of the timber. A small piece of waste wood will, therefore, come away as at *a*.

The object of cutting this small channel is so that, when the chisel is held vertically on the gauge line and struck with the mallet, the chisel will have no tendency to force its way backward and overshoot the gauge line. The waste or core is now removed by holding the chisel approximately vertical and applying sufficient power to drive it halfway through the timber. The drawer side is now turned over, the operation repeated, and the core pushed

Joints in Woodwork

out. Care must be exercised whilst cutting away the core B, Fig. 289, to ensure the chisel being held nearly perpendicular; if too much lead (or bevel) be given, a faulty and undercut dovetail, as shown at *a*, Fig. 289, will be the result. Undercut dovetails prevent a proper grip of the glue; they give a weak joint, and often cause the face of the drawer side to be splintered whilst driving up the joint. If it be necessary to ease one or two shavings from off the drawer side whilst fitting the completed drawer in the carcase, the joint will show a greater gap as each succeeding shaving is removed. In common work, especially in soft timbers, many workers allow the pins of a drawer back to run through the sides about $\frac{1}{16}$ in. and hammer down the pins of the dovetail. This is called "bishopsing the dovetails," and is unnecessary if the work be properly made and fitted.

An alternative method of dovetailing is that of cutting the dovetails first, as shown at Fig. 290. Four or six drawer sides are placed in the vice and the dovetails are sawn at one operation. A little lead (or bevel) from front to back is given whilst sawing, and if this method be used care must be taken to see that the parts of the drawer sides which will be on the inside of the completed drawer are towards the worker, or the lead will be given to the dovetails in the wrong direction. After sawing the dovetails in this manner the sides are placed in their respective positions on the drawer fronts or backs, and marked with a pounce-bag or by using the saw-blade method. The pins are then cut in the usual way, care being taken that the saw kerf be on the outside of the marks, otherwise the pins will finish too slack to engage with the tails.

VARIATION OF THE DOVETAIL JOINT.

Frame Dovetails.—Fig. 292 is a sketch of a constructional frame such as is used for building up a cornice or plinth. At the joint marked *a* a housed barefaced dovetail

The Dovetail Joint

is shown. Another view of the joint, separated, is sketched at *a*, Fig. 291, and it will be seen that the dovetail can be put together either from the top or the bottom of the framing as all its edges are parallel; glue is relied upon to hold it in position. The centre stretcher rail at Fig. 292 is similar, except that in this case it is a complete dovetail in place of a barefaced one.

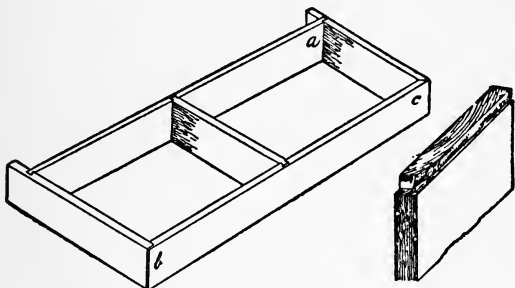

Fig. 292.—Dovetail Joints in Framing.

Fig. 293.—Top Portion of Frame Division.

Some workers, when making either of the above joints, prefer to give a slight bevel to the dovetail, so that it drives tightly into the housing when put together.

A variation of this type of dovetail is frequently used to joint internal uprights to the horizontal shelves of writing desks, cabinets, and bookcases, etc. The dovetailed portion is parallel for about three-fourths of its width; the remaining part is tapered towards the front edge and notched away at the face so as to conceal the method of construction. An illustration of the top portion of a division 14 ins. wide is shown at Fig. 293, and, of course, the other portion is trenched and dovetailed to fit it.

Blind Lap-Dovetailing.—At *b*, Fig. 292, is shown a

Joints in Woodwork

type of blind lap-dovetailing. This makes a good, sound joint, but it has the disadvantage of showing a small portion of the timber of the front rail end-way of the grain. A little sketch of the joint separated has been shown at *b*, Fig. 291. Joints of this kind are used for cornices, boxes, etc., and also for painted furniture.

A Mitred Dovetail joint is illustrated at Fig. 292, *c*; it is used in all the better class of cabinet and box work. Fig. 294 shows one of the pieces separated; note the mitre at the top and bottom edge.

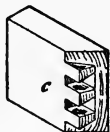

Fig. 294.
One Piece
Separated.

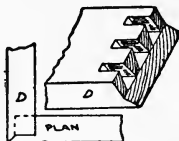

Fig. 295.
Housed and
Mitred Dove-
tail.

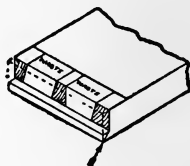

Fig. 296.
Marking out a
Housed and
Mitred Dovetail.

Housed and Mitred Dovetail.—Fig. 295 is another form of dovetail—commonly called a housed and mitred or rebated and mitred dovetail. In this instance we see that the joint is not mitred at the top and bottom edge, and when used in plinth or cornice work, or for making tea-caddies, etc., the edges are (when completing the work) covered either with the moulding, which is planted on the cornice or plinth, or with the top and bottom of the box or tea-caddy. A complete plan and a sketch of one piece separated is shown.

Fig. 296 shows the method of marking out a housed and mitred dovetail. The ends to be joined are planed up true and square and then rebated as shown. The dotted lines indicate the portion which has been worked

The Dovetail Joint

away. The dovetails are now sawn and pared out in the usual way and the part denoted by the arrow is afterwards cut away with a chisel and finally finished to a smooth surface with a rebate plane; the method of working is shown at Fig. 297, where the dovetail pins are seen with the waste portions cut away.

Fig. 297 also shows the method of cutting away the mitred part. A temporary piece of wood is planed to a true

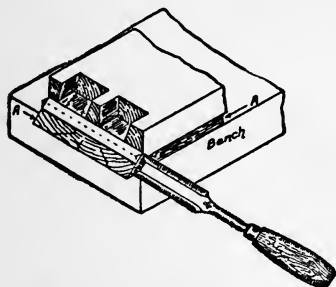

Fig. 297.—Working a Housed and Mitred Dovetail.

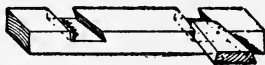

Fig. 298.—Dovetail Keying.

mitre and placed underneath the dovetailed piece to form a template. Both pieces of the timber are now secured to the bench with a handscrew or clamp; the template A will form a guide for the chisel and rebate plane and allow a sharp edge or arris to be worked on the mitre.

Dovetail Keying.—Fig. 298 is a method used to prevent wide boards such as signboards, wide and shaped pediments, etc., from casting or warping. It is called dovetail keying, and two methods are shown. Beyond calling attention to the fact that the angles at the edges of the keys, where they are bevelled, should be at or about 75 degs., nothing further need be said, as the drawing is self-explanatory. Angle dovetail keying is shown at Fig. 298A.

Joints in Woodwork

Dovetails for Small Boxes.—Fig. 299 is a good way to prepare small boxes, such as negative boxes and cases for scientific instrument cases. Fig. 299, C, shows a sketch of the ends jointed; A and B are the pieces separated,

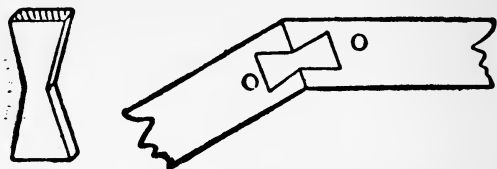

Fig. 298A.—Dovetail Keying on the Angle.

and the plan E D illustrates the method of rounding away the corners. The radius dies away at the joint, practically hiding the joint line.

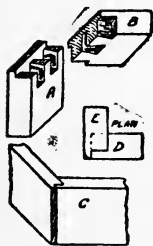

Fig. 299.—
Dovetails for
Small Boxes.

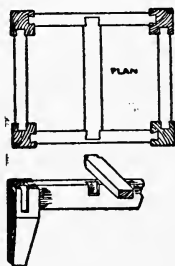

Fig. 300.—
Dovetailed
Footstool.

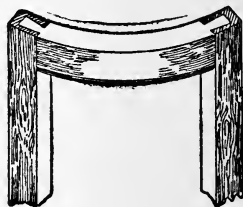

Fig. 301.—
Dovetailed
Curved Work.

OTHER VARIETIES OF THE JOINT.

Fig. 300 is a small footstool with stretcher rail, which would be finished by webbing and upholstering the top; this shows the application of dovetailing when the timber

The Dovetail Joint

is too small to admit of dowelling or tenoning. Plan and part sketch are shown.

Fig. 301.—An everyday method of jointing circular-fronted cabinet door frames. Great care must be taken in setting out and making, or a twisted frame will result.

Fig. 302.—A familiar example of dovetailing the bearer to the carcass end of a dressing table or washstand.

Fig. 303.—Lap-dovetailing the top of a wardrobe to

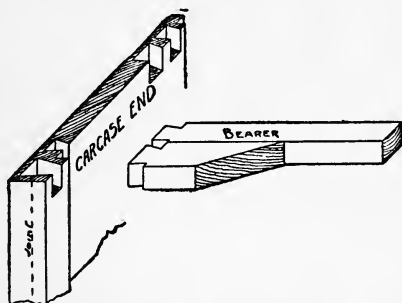

Fig. 302.—Dovetailed Bearer Rail showing the Bearer for the Back.

the carcass end. Other examples, such as the top of a bookcase to the sides, will suggest themselves.

Fig. 304.—Side view of a jewel drawer with a moulded drawer front as used on dressing tables, etc. This shows the necessity of bevelled dovetailing in order that the drawer front may be kept as thin and light as possible.

Fig. 305.—Bevelled dovetailing when pins are at right angles to the end cut. Fig. 306 shows the joint separated.

Fig. 307.—Bevelled dovetailing when the centre line of the pins is parallel to the edges of the work, used for making "hoppers," food troughs, knife boxes, etc.

Fig. 308.—An example of oblique dovetailing, as used on "hoppers" when one piece is vertical and the other piece is inclined.

Joints in Woodwork

Fig. 309.—Method of dovetailing small boxes. The box is dovetailed in one width and the top and bottom glued on ; the sides and ends are then cut along the dotted

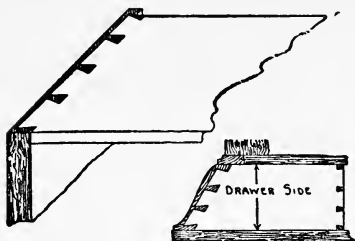

Fig. 303.—Lap-Dovetailing. Fig. 304.—Jewel Drawer Side.



Fig. 305.—Bevelled Dovetailing.

line, thus forming the lid. It will be noticed that a specially wide dovetail pin must be left so as to form part of the lid and part of the lower portion.

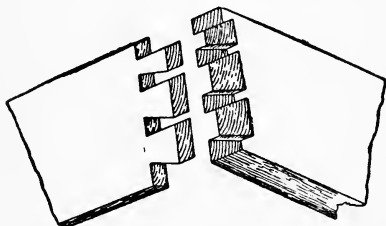

Fig. 306.—Bevelled Dovetailing. Parts separated.



Fig. 307.—Bevelled Dovetailing with Pins parallel to Edges.

SETTING OUT AND MARKING THE DOVETAIL JOINT.

For constructing a dovetail joint at the corner of a frame, as Fig. 310, it is necessary to trim up the ends of

The Dovetail Joint

the timber square and true, as at Fig. 311. This may be accomplished by neatly sawing to the line and paring the end of the wood with a sharp chisel, or by bringing the wood to a finish with a finely-set plane, such as an

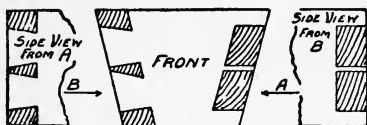

Fig. 308.—Oblique Dovetailing.

iron-faced smoothing plane. The ends of the wood must be perfectly square when tested from either the face side or from the marked edge.

Take a cutting gauge and set it to equal the thickness of the timber, and, holding it as shown at Fig. 312, strike

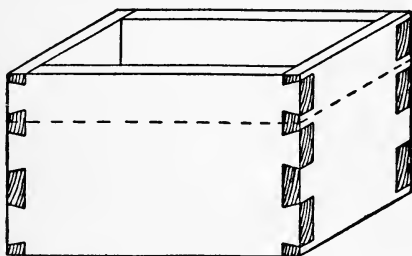

Fig. 309.—Dovetailing for Small Box.

the gauge lines on the wood as illustrated at Fig. 313, G. Proceed to mark out the dovetail pins, as at Fig. 314; in this illustration G again shows the gauge line. The inclination of the lines across the end of the wood should not be too great, or the joint will be a weak one, and the edges of the dovetails will be liable to crumble away when the work is knocked together.

Joints in Woodwork

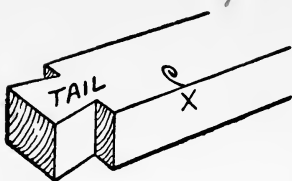

Fig. 310.—Corner Dovetail.

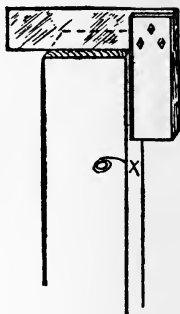

Fig. 311.—Squaring.

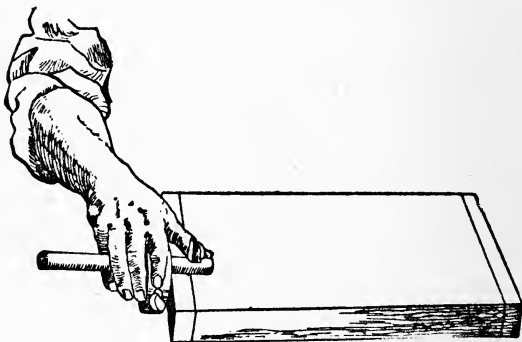

Fig. 312.—How to Use the Cutting Gauge.

The Dovetail Joint

Dovetailing Template.—Many workers who are constantly engaged upon dovetail joints make a small wooden template, as shown at Fig. 315. This template is generally of hardwood, such as beech or walnut. To obtain the correct angles of such a template proceed as follows:— Draw a line, C, at right angles to the line AB; then on the line C set off 8 ins. as shown at Fig. 316. Next set off

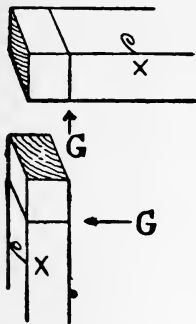

Fig. 313.—Gauging.

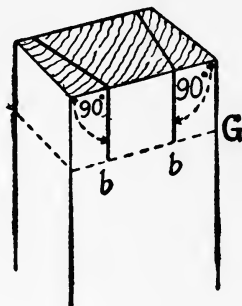

Fig. 314.—Marking the Pins.

1 in. from D to E, and draw a line from E to C; this line will give the correct bevel for a dovetail, and the template should be made to fit it. Notice that the lines *bb* (Fig. 314) of the dovetail pins do *not* bevel; they are parallel to the sides of the wood and at right angles to the end of the wood as shown.

Chisel Work.—After marking out, as shown at Fig. 314, place the wood on the bench and proceed to chop away the centre portion in the following manner. Hold the chisel on the bevel, as shown (Fig. 317), and cut out a small piece to form a channel at the gauge line. Now hold the chisel in a vertical position, as dotted lines (Fig. 317), and with a mallet strike the chisel so as to make a cut

Joints in Woodwork

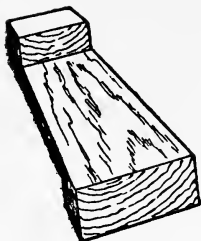

Fig. 315.—Dovetailing Template.



Fig. 316.—How to obtain Correct Angles for Dove-tail Template.

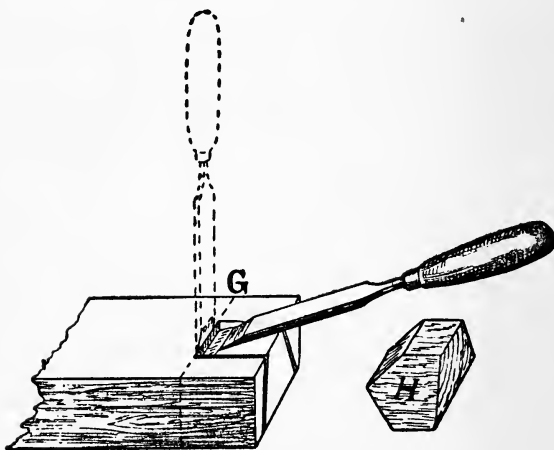

Fig. 317.—Cutting Dovetail with Chisel.

about $\frac{1}{8}$ in. deep. Then hold the chisel on the bevel again and cut away more waste wood; proceed alternately, first forcing the chisel down vertically, and then paring

The Dovetail Joint

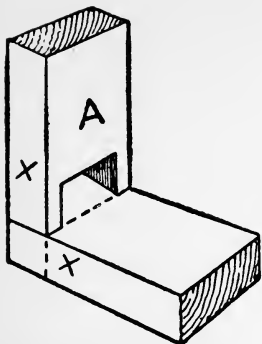

Fig. 318.—Testing.

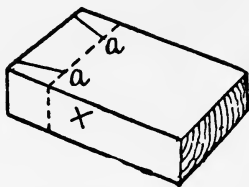

Fig. 319.—The Marked Piece.

the wood away with the chisel held obliquely, until you have cut halfway through the thickness of the wood.

Turn the wood over and repeat the various operations until the core, or waste piece, is removed, as shown at

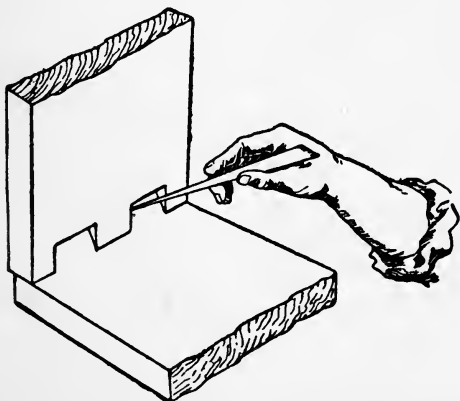

Fig. 320.—Marking Dovetails with Marking Awl,

Joins in Woodwork

H, Fig. 317. Pare away any little irregularities which may be left in the corners with an $\frac{1}{8}$ -in. chisel, thus leaving all smooth and neat. Lay the piece of wood which is to have the dovetail marked on it flat upon the bench, and take the piece with the dovetail pins cut upon it and place in the position shown at Fig. 318.

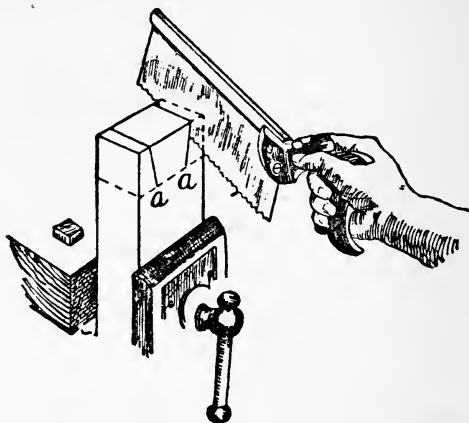

Fig. 321.—Sawing the Dovetails.

Saw Work.—Take a marking awl, or a knitting needle which has had its end sharpened, and mark the lines of the dovetail in a similar manner to that shown at Fig. 320. Remove the piece A, Fig. 318, and the lower piece shown at Fig. 318 will clearly show the marks *aa* as they appear in Fig. 319. Place the piece (Fig. 319) in the vice, and saw *outside* the lines *aa*, as shown in Fig. 321.

After sawing down the lines *aa*, Fig. 321, place the wood in the vice, as shown at Fig. 322, and, guiding the saw blade with the index finger of the left hand, cut away the small piece at the side of the wood. Repeat the operation as may be necessary, and the completed joint will be

The Dovetail Joint

similar to that shown at Fig. 310. If the sawing at Fig. 322 is not neatly done it may be found necessary to pare the shoulder with a sharp chisel.

Drawers.—When dovetailing drawers or boxes it is necessary to square up the ends of all the stock and gauge them, as shown at Fig. 312. This illustration shows how to gauge the lines on a drawer side; the dovetailed joint in this case, however, does not run through the drawer

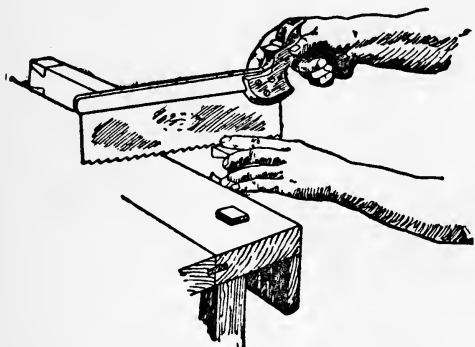
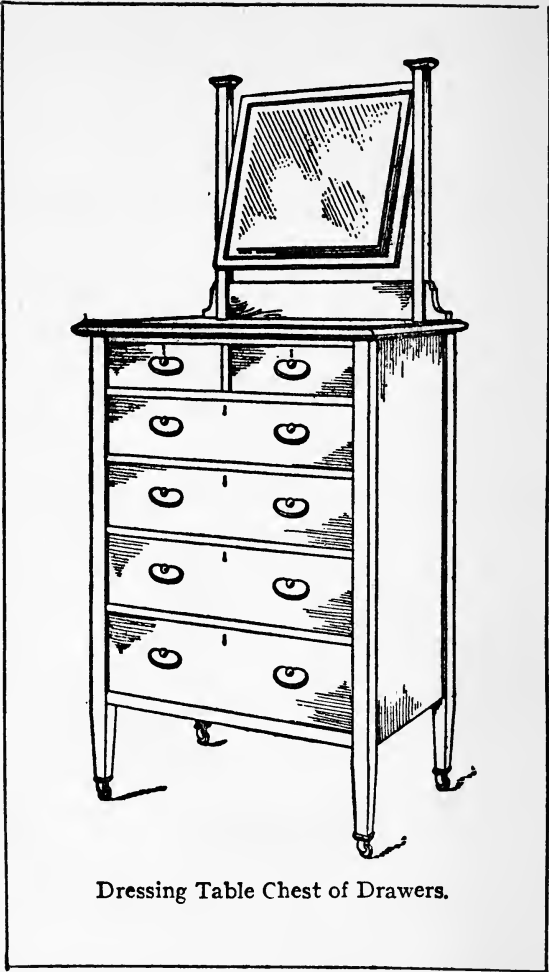

Fig. 322.—Sawing away Waste at Ends.

front and leave the work unsightly, as the joint at Fig. 310 would do. The method used is shown at Fig. 323, and it is commonly known as lap-dovetailing. Most workers cut the dovetail pins on the drawer fronts and the drawer backs first, after which they mark the drawer sides with the marking awl, as shown at Fig. 320, the dovetail pins on the drawer front being sawn as at Fig. 327. The dovetailing of the drawer back is shown at Fig. 324. This is the type known as "through dovetailing," the method being similar in regard to tool operations as the single joint shown at Fig. 310.

When the pins on the drawer front have been sawn as at Fig. 327, the waste material is cut away, as shown at



Dressing Table Chest of Drawers.

The Dovetail Joint

Fig. 325. First stab down with the vertical chisel, which must make the cut about $\frac{1}{32}$ in. in front of the gauge

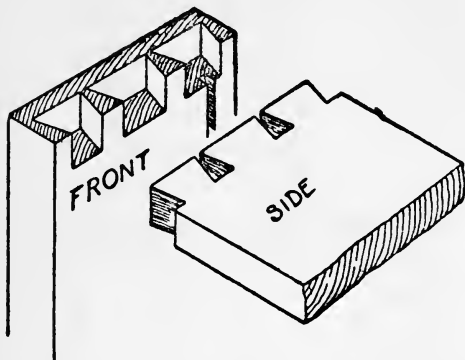

Fig. 323.—Lap-dovetailing Drawer Front to Drawer Side.

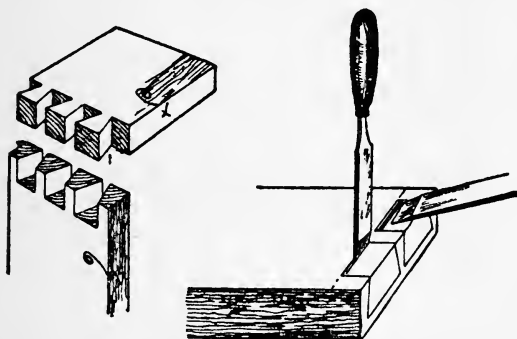

Fig. 324 —Through
Dovetailing.

Fig. 325.—Chipping Waste
of Lap Dovetail.

line (see illustration). This commencing of the cut slightly in front of the gauge line is a very important feature. The chisel may be likened to a wedge, and if the chisel edge

Joints in Woodwork

be placed exactly upon the gauge line and force be applied to the handle, it will force the timber away equally on each side of the gauge line, and the finished depth of the hole will therefore be too deep for the thickness of the drawer side; in other words, it will press itself over the gauge line on both sides.

By taking the first vertical cut on the waste side of the

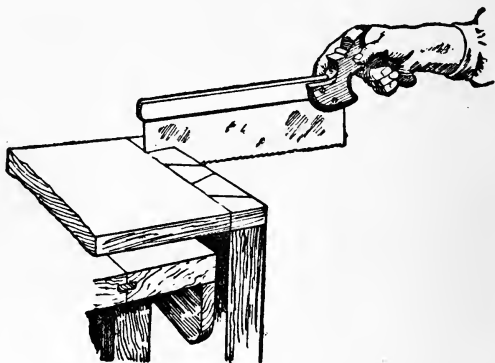

Fig. 326.—Marking Drawer Dovetails (sides or ends) with the Saw Blade, when Tails are cut before Pins.

gauge line, and then removing a small piece with the chisel held obliquely, as shown at Fig. 325, the wood is removed and less resistance is offered to the chisel when the next vertical cut is made. This overshooting the gauge line is a common fault with the beginner, who is puzzled at the result because he is certain he had his chisel exactly on the gauge line when he commenced his vertical cut. It is especially noticeable in soft-grained woods.

To cut away the waste of a lap-dovetail, as shown at Fig. 325, the vertical and oblique cuts are repeated until

The Dovetail Joint

the final trimming up is required, and now is the time to finish both the vertical and the horizontal cuts exactly on the gauge lines.

Some workers prefer to cut the drawer sides first, and if this method is preferred (and it has its advantages for cheap work) several drawer sides are cut at once by placing four or six behind one another in the vice and sawing them

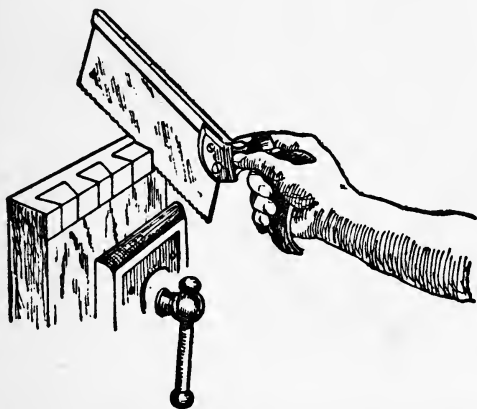

Fig. 327.—Sawing the Dovetail Pins of Drawers.

all at one operation. If this method be adopted the procedure for marking the drawer fronts and backs is shown at Fig. 326.

The drawer front is placed in the vice, and the drawer side held upon it, whilst the saw blade is placed in the saw kerf and drawn smartly forward. This will give the required marks at the exact position desired. It must be remembered, however, to saw just inside these dovetail-pin lines (as shown at Fig. 327), otherwise the finished joint will be too slack, owing to the removal of the sawdust which is practically equal to the thickness of the saw blade.

Joints in Woodwork

Dovetail saws have specially thin blades and very little set upon the teeth, so as to limit as far as possible the thickness of the saw kerf.

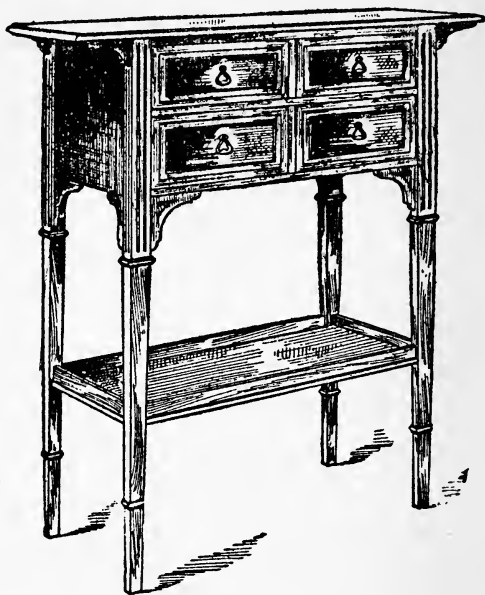

Occasional Table, with Four Drawers.

Dovetail joints are generally glued together, and when the glue is set they are levelled up with a finely-set plane and finished by glass-papering.

DOVETAIL GROOVING

THE dovetail housing joint should first be carefully marked out with a marking knife, so as to cut across the fibres of the wood. For obtaining the bevel on the edge of the wood a "joiner's bevel" may be used, and the angle should not be too acute. (See previous chapter.) Take a chisel and pare away a small channel as at A, Fig. 328, so as to form a small shoulder to guide the saw.

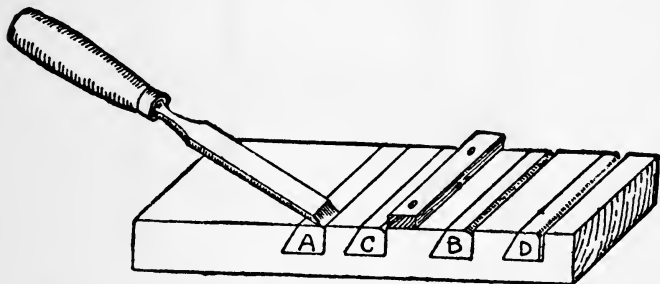

Fig. 328.—Paring away Channel for Dovetail Grooving.

With a fine tenon or dovetail saw, as shown at Fig. 329, cut the saw kerf as at D, Fig. 328. If any difficulty is experienced in cutting the saw kerf true and square, you may resort to the method shown at C, Fig. 328; a small temporary piece of timber has been screwed on the top of the work to form a guide for the saw.

Fig. 328, B, shows the small channel formed by the chisel prior to the sawing operation. The sawing of the bevelled side is worked in a similar manner; but occasionally we find amateurs who adopt the method shown

Joints in Woodwork

at Fig. 330. A block of wood H is first made by boring a $1\frac{1}{4}$ -in. hole through its entire length, and afterwards making a saw cut at the desired bevel; the object of this

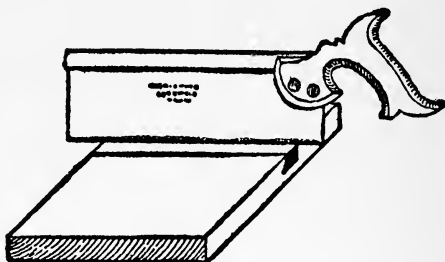

Fig. 329.—Cutting the Saw Kerf.

block, which is kept specially for the purpose, is to form a guide for those who have not full control of the dovetail saw; the back of the saw clears the hole, and the required

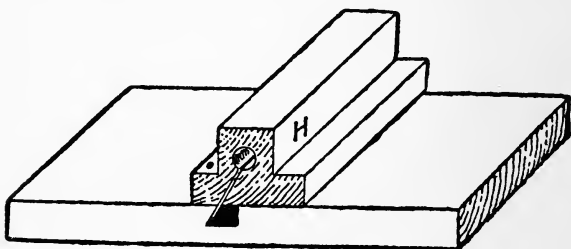

Fig. 330.—Guide Block for Bevelling.

bevel is obtained. When a saw cut has been made at each side of the groove, the surplus timber is pared away in the following manner:—Cut away portion E, Fig. 331; then cut away portion F, and lastly cut away the apex portion marked G; continue by this method of paring

Dovetail Grooving

until the approximate depth is reached. To ensure a correct depth throughout the entire groove, the router



Fig. 331.—Showing Method of Paring.

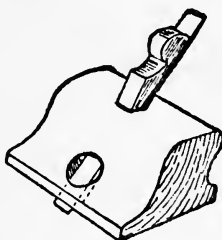

Fig. 332.—Old Woman's Tooth Plane.

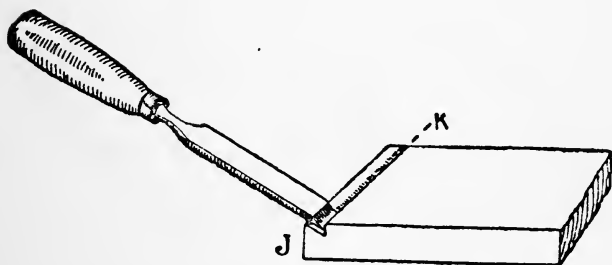

Fig. 333.—Channelling the Alternate Piece.

plane (or, as it is often called, "the old woman's tooth plane") is used (see Fig. 332).

Joints in Woodwork

With regard to cutting the alternate piece, it is necessary to first plane the end of the shelf true and square, and with a cutting gauge strike the line K, Fig. 333; the required bevel on the edge J is set out, and with the chisel a small channel is again formed. With the tenon or dovetail saw cut down the line K to the required depth, and carefully pare away the wood with a sharp chisel to the correct shape.

It is probably needless to remark that the experienced craftsman sets out his work and cuts the timber without having to resort to such mechanical means as the block H, Fig. 330, or the slip at C, Fig. 328. These aids to the amateur are fastened temporarily to their positions by ordinary screws, or, better still, with a handscrew or cramp.

JOINTS FOR CURVED WORK

FIG. 334 shows a circular frame made up in two thicknesses, the segments being screwed to each other and the joints crossed in two layers. This is a very strong method, and it is used for making circular frames and curbs up to 15 ft. in diameter. The segments can be either long or short, the only important condition being that they must be marked out

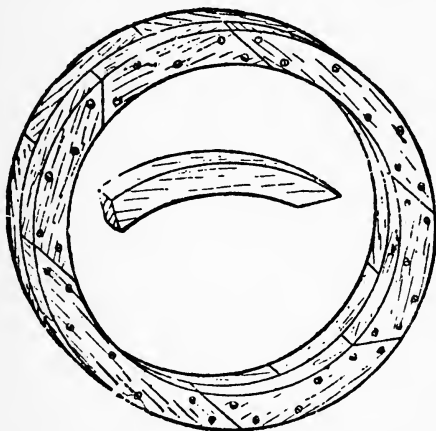

Fig. 334.—Circular Frame in Two Thicknesses.

and sawn to the correct radius. Fig. 335 shows a board marked out in segments for this class of work, and the longer the boards are the better they will cut up, as it gives more opportunities of cutting one piece out of the other as at A A.

Joints in Woodwork

Fig. 336 shows how to begin to put the work together. To continue this, fit other segments in position and screw them to D and E respectively. The completed work is illustrated at Fig. 334.

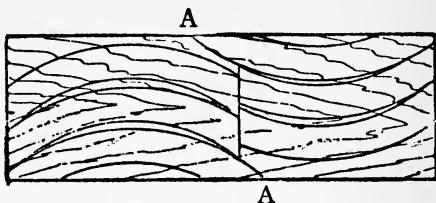

Fig. 335.—Board Marked in Segments for Circular Jointing.

Fig. 337 shows a circular rim, or curb, made of segments which are halved together. This method is suitable for heavy work, where the timbers are of considerable size. The halvings are cut on the ends of the segments to any

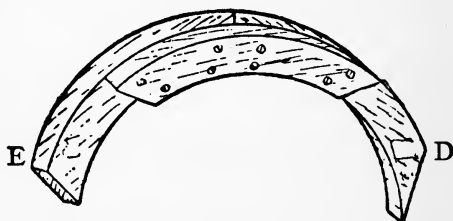

Fig. 336.—Putting Circular Work together.

convenient shape or bevel, each one being marked so as to fit its fellow.

When extra strength is required, semicircular or circular work is built up out of four or five thicknesses of wood, and the method is called laminating. The method of

Joints for Curved Work

building up the semicircular head of a door frame by this method is shown at Figs. 338 and 339.

The shaped framing for kidney-shaped writing tables and similar classes of work are built up by laminating pieces of $\frac{3}{4}$ -in. or 1-in. wood, after which the face side is veneered so as to hide the glued joints. Fig. 340 shows



Fig. 337.—Circular Rim in Halved Segments.

a sketch of one quarter of an elliptical table frame, levelled up and ready for applying the veneer.

CONSTRUCTION BY LAMINATION.

If we apply to the dictionary for the word "lamination," we find that lamellar structure is the arrangement in thin plates or layers one over the other, usually having the end joints alternating, and it is a condition which allows of cleavage in one direction only. This method is used for nearly all descriptions of free or irregular curves, such

Joints in Woodwork

as sweeps, bends, ogee shapes, and segments of circles. The timber is marked out in suitable lengths, rough-sawn,

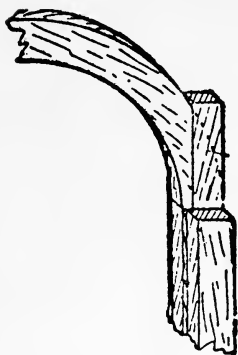

Fig. 338.

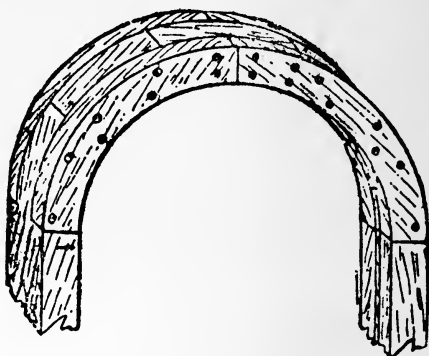

Fig. 339.

Building up Semicircular Head of Door Frame.

and then planed true on the face, glued together, and when set the sides are cleaned up to the required shape. It is

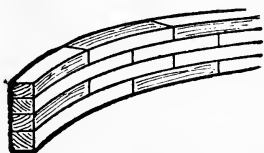

Fig. 340.—Part of Laminated Table Frame.

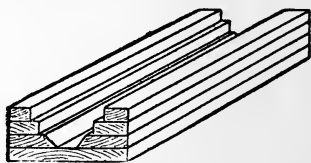

Fig. 341.—Half of Core Box, Laminated.

one of the strongest methods of construction, and necessarily costly. Pulleys, pulley rims, and a hundred and one other jobs are built by this method.

Fig. 341 shows one half of a core box built by this method, and ready to be worked to the required shape, viz., a half-circle as marked on its end.

MISCELLANEOUS JOINTS

JOINING **Weather Boards.**—At Fig. 342 the method of jointing and nailing weather boarding on such temporary buildings as garden sheds and tool-houses is shown. The weather boarding can be bought ready prepared at any local saw mill. The section A illustrates a suitable piece of timber with chamfered edges, which is nailed on the end of the weather boarding



Fig. 342.—Joining Weather Boarding.

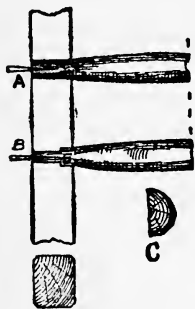

Fig. 343.—Ladder Rungs.



Fig. 344.—Finial for Cornice Pole.

to protect it from the rain, which would be liable to cause premature decay if it had access to the end grain of the hoarding.

Ladder Rungs.—Fig. 343 illustrates the method of fastening the rung (or stave) of a ladder to the side. At A the common method is shown, the stave being simply

Joints in Woodwork

driven into the hole and wedged. At B a much better but more expensive method of construction is given. The stave here is socketed and the pin turned to a smaller diameter. In both cases the rung, or stave, is painted before being driven into the side and wedged.

Ladder Sides.—Ladder sides are made in two distinct ways. One method is known as “a plank side,” the side



Fig. 345.—Joining Rustic Woodwork.



Fig. 346.—Nailed Joint for Rustic Work.

being cut from a plank as shown at the section ; the other method is called “a pole side,” and is constructed by cutting a straight larch pole in half and using half of the pole for each side of the ladder, as at section C.

Cornice Poles Ends and Finials.—Fig. 344 shows the fastening of a cornice pole end to the cornice pole, or a turned ornament to an overmantel shelf or top shaping. A double-pointed screw is used, half of which is screwed into each part of the articles to be joined. Double-pointed screws are known in the trade as dowel screws.

Joining Rustic Work.—Fig. 345 indicates the jointing of the top framing of a rustic shelter or summer house, the illustration being self-explanatory.

Miscellaneous Joints

Fig. 346 is a nailed joint for rustic work. The upright piece is sawn to receive half of the upper piece and the joint secured by the use of cut nails.

Patera Covers to Temporary Screws.—Fig. 347 shows the jointing of shaped spandrils, etc., to carcass ends of light portable cabinet work, etc. A hole is bored about $\frac{3}{8}$ of an inch deep into the end, and a screw is used to hold the shaping in position. After fixing

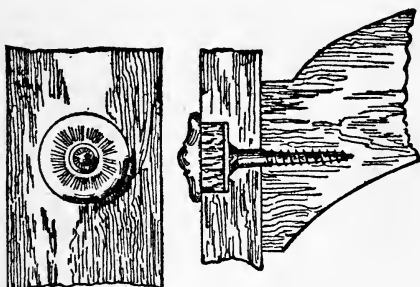

Fig. 347.—Patera Covers to Hide Screws.

the rail a small turned button, called a turned patera, is inserted in the hole, thus giving an ornamental finish, as shown in the front view. The turned patera is driven fairly tightly into the hole, but not glued. When it is required to take the article apart a chisel is carefully inserted under the edge of the patera to remove it, and the screw can then be taken out. This method is often used for the construction of light hanging bookcases and similar objects. For a bookcase having an end 8 ins. wide three of these turned buttons and three screws would be used to secure the shelf to the end. Pateras as illustrated are excellent examples of fine lathe work, and this method of construction for light articles should appeal to readers who possess a wood-turning lathe.

Joints in Woodwork

Hinged Joints for Cornice Poles.—Fig. 348 shows a hinged joint for cornice poles and should be of great

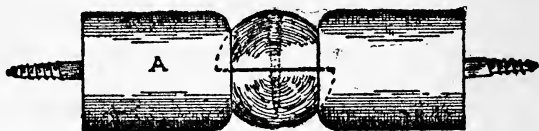

Fig. 348.—Hinged Joint for Cornice Poles, etc.

interest to those who are frequently removing from house to house. The joint will adapt itself to fit any bay window

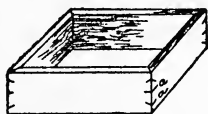

Fig. 349.—Veneer Keying.



Fig. 351.—Garden Frame or Skylight Joint.

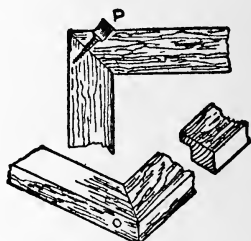

Fig. 350.—Pelleting.



Fig. 352.—Picture Frame Joint.

(even a square bay) and it is formed by turning and cutting two pieces as A. To fix a cornice pole to a bay window one of these joints is required for each angle of the bay, the pole being cut into suitable lengths and fixed to the

Miscellaneous Joints

hinged joints by the use of the dowel screw and a little hot glue. It is perhaps needless to remark that the diameter of the joint should be of the same diameter as the cornice pole, to enable the rings to easily slide over the surface.

Veneer Keying.—Fig. 349 illustrates the method of strengthening the corners of boxes which are made of $\frac{1}{4}$ -in. or $\frac{3}{8}$ -in. timber, by securing the corners with veneer keys. The box is mitred and glued in the usual manner, and after allowing sufficient time for the glue to set, saw cuts or "saw kerfs" are made as shown at *a a*. A piece of thin saw-cut veneer is afterwards glued into the saw kerfs, and when dry the face is levelled off flush. This method is often used previous to veneering the face side of the box with rare veneers, and it is also useful for repair work.

Pelleting.—Fig. 350 indicates the method of pelleting and screwing the corner of a picture frame. The mitre joint is first screwed and a pellet of the same timber is made to fill the hole which has been bored to receive the screw head. This method is similar to Fig. 347, with the exception that in the latter case the pellet P is glued in position and levelled off.

The lower illustration shows the finished edge.

Skylight and Garden Frame.—Fig. 351 shows how to fix the interior rebated rail of a skylight or garden frame to the front rail. This, after a perusal of the sketch, does not call for explanation.

Frame Joint.—Fig. 352 shows the corner of a picture frame veneer-keyed as Fig. 349 in preference to nailing.

Jointing Broken Turned Work.—At Fig. 353 is shown a turned chair leg, which has been fractured across the turned portion A. One of the neatest methods of repairing and making a new joint is shown at C. The broken part is first sawn away and the ends of the leg are planed true and square. A new portion C is turned in the lathe and the $\frac{3}{4}$ -in. dowel pins engage with suitably bored holes.

Joins in Woodwork

The joint is warmed and glued, and a cramp may be applied to give the necessary pressure.

Castor Pins and Crush Feet (Fig. 354).—Breakages frequently occur to the lower part of a dining-table or chair leg at the portion marked S, which fits into the socket of the castor. Owing to shrinkage or to continual

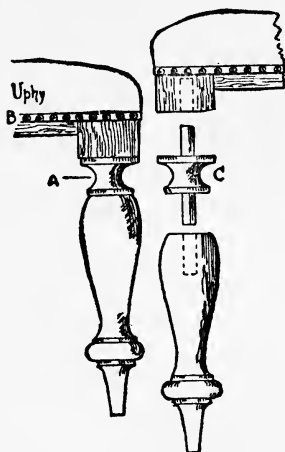

Fig. 353.—Jointing Turned Work.

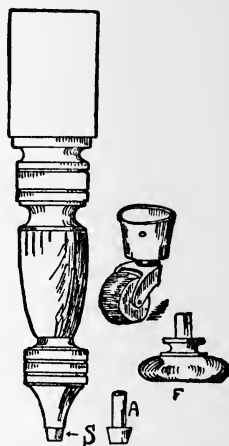

Fig. 354.—Castor Pins, etc.

vibration of the screws and the socket castor, the woodwork is eaten away and the castor becomes loose. The simplest and most effective way of making the repair is to turn a new castor pin A. Cut away the old portion, bore the leg, and glue and insert the new pin A. F illustrates a "crush," or "dinner plate foot," as used on a sideboard. The upright post of the sideboard is generally made out of timber about $1\frac{1}{2}$ ins. square; the foot is turned and fitted in position by the dowel pin as shown. Examples of this class of joint are frequent in furniture of the Queen Anne

Miscellaneous Joints

period, where the stretcher rails run through the turned legs and the feet are afterwards fixed by the above method.

Sideboard Pillars, etc. (Fig. 355).—For economy, sideboard pillars are sometimes built up as indicated, the “shaft,” the “base,” and the “swell” being made up of three distinct pieces. Turned pins are left on the

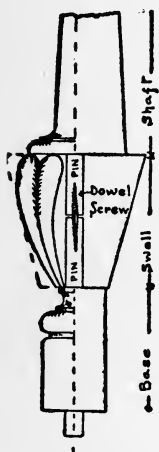

Fig. 355.—Sideboard Columns.

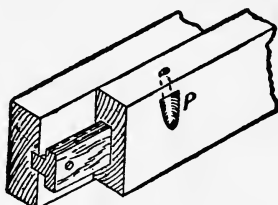

Fig. 356.—Dining-table Joint.

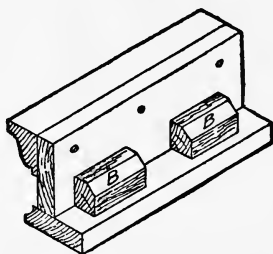

Fig. 357.—Glue-blocking.

shaft and the base, and these are secured at the joint by the use of a double-pointed screw called a dowel screw. The left-hand portion of the illustration shows the finished turning, whilst the right-hand portion shows the blocks prior to the turning and carving operations.

Dining-table Slide Joint.—At Fig. 356 is indicated a method of securing dining-table slides, or “lopers,” as they are frequently termed. This joint is called a “tee-slide,” and it has the advantage over many other types

Joints in Woodwork

owing to the fact that no cross rails are required under the table. The particular form of the inserted tee-piece makes it impossible for the slides to come asunder. The table slides are first worked to the desired shape (special planes being used to make the grooves), and the tee-piece is made separately and glued and screwed into the left-hand slide.

Pocket Screwing.—On the inside rail of Fig. 356, P, the method known as pocket-screwing is shown. Table

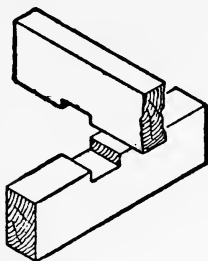

Fig. 358-9.—Notched Joint.

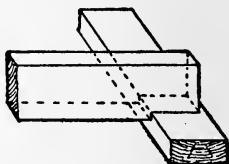

Fig. 360.—End Notch.

tops, the tops of dressing-tables and sideboards, etc., are screwed to the carcase portion by this method. A hole of the required diameter to fit the screw is bored obliquely from the top edge of the rail; a gouge is then taken and the wood is hollowed away to receive the screw head.

Blocking.—Fig. 357 illustrates a method of strengthening and stiffening a cornice or plinth by glueing small blocks of wood (generally yellow pine) into the angles of the framing. B, B show the blocks in position. This method of combining strength with lightness is greatly used on interior fittings.

Notched Joints.—Fig. 358-9 is a notched joint, where two joists, or scantlings, cross each other, the object of the joint being to prevent the joists moving from their position

Miscellaneous Joints

and not to materially weaken them. Fig. 360 shows a notched joint at the end of a joist.

Cogged Joint.—Fig. 361 is a type of joint used for connecting purlins to rafters, and joists to girders, etc.

Saddle Joint.—At Fig. 362 is shown a compromise between the notched and the cogged joint. It is used for connecting upright posts to heads or sills of framing, and undoubtedly takes its name from its similarity to the way in which the saddle fits the horse. It does not

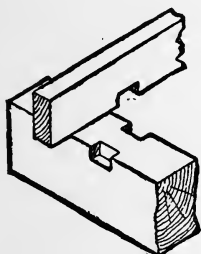

Fig. 361.—Cogged Joint.

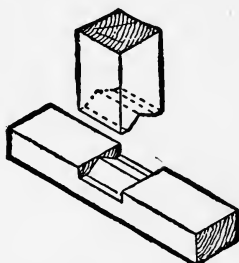

Fig. 362.—Saddle Joint.

weaken the framing as does a mortise and tenon joint, and shrinkage has little effect upon the joint. Fig. 363 is a notched joint on a rebated joist.

Roll-top Desk Fall (or Tambour Front).—Fig. 364 shows the method of making a fall-front for a roll-top desk or similar article. Sections of the rebated mouldings are shown. The various pieces are fixed together by stringing them on a wire cable, as shown. It is usual to use not less than three pieces of cable on a desk of 3 ft. ; one piece of cable near each end, and one piece at the centre. This method of joining the various pieces by means of flexible wire cable has almost superseded the old-fashioned method of glueing the mouldings on stout cloth or linen ticking.

Joints in Woodwork

Rafter Joint.—Fig. 365 shows an everyday joint, as used at the juncture of the principal rafter and the tie-beam in roof truss work. A sketch of piece A is shown separated,

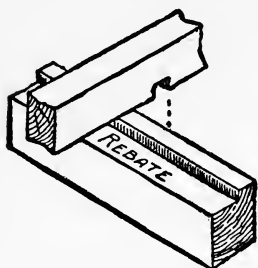

Fig. 363.—Notched Joint on Rebated Joist.



Fig. 364.—Roll-top Desk Joint.

and it should be noted that the depth of the cut portion B should not be more than one-fourth of the total width of the tie-beam.

Birdsmouth Joints.—Fig. 366 is a birdsmouth joint,

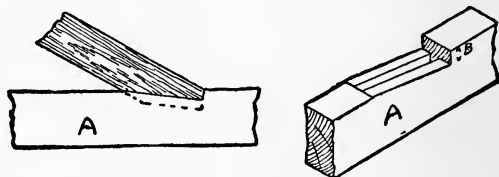

Fig. 365.—Rafter and Tie Beam Joint.

as used when a spar fits on the wall plate, a simple joint which can be readily made by the handsaw. A nail is shown securing it in position.

Fig. 367 shows the birdsmouth joint where the spar runs over the outside of the wall plate, thus allowing a fixing for an ornamental finish, such as a barge board, etc.

Miscellaneous Joints

Scribing Joints.—Fig. 368, A and B, are elevations and plans of two pieces of moulding, which are “scribed” together. In the elevation it will be seen that the left end

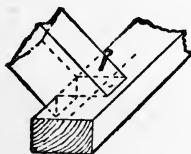

Fig. 366.—Birdsmouth Joint.

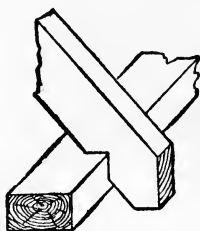

Fig. 367.—Another Type of Birdsmouth Joint.

of piece B is cut to such a shape as to form a perfect fit with the contour of piece A; this method is called scribing, and the joint is known as a scribed joint. It has an advan-

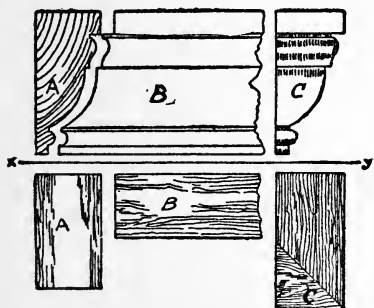

Fig. 368.—Scribing Joint.



Fig. 369.—Scribing Joint on Skirting Board.

tage over the mitred joint, shown at C, because if slight shrinkage takes place, the joint does not open to the same extent. If mouldings have undercut members, it is, of course, impossible to scribe them to fit each other.

Joints in Woodwork

Butt-jointing Counter Tops with Dovetail Keys.—

Fig. 370 indicates a method often used to secure the ends of counter tops, etc., when timber cannot be secured of

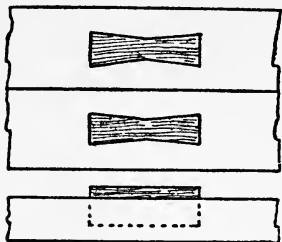

Fig. 370.—Counter Top Jointed with Dovetail Keys.

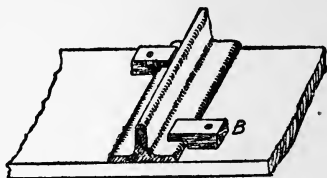

Fig. 371.—Method of Buttoning with Angle Iron.

sufficient length for the entire span of the counter. The boards are first glue-jointed and the ends are secured with dovetail keys. (See also pages 169 and 170.)

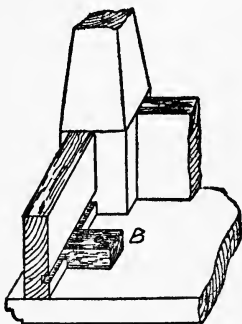

Fig. 372.—Buttoning a Table Top.

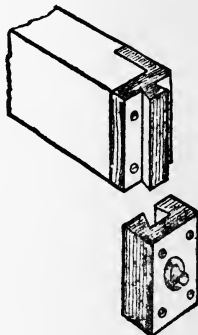

Fig. 373.—Bed Joint.

Buttoning.—A means of securing wide surfaces of woodwork to angle iron by means of wooden buttons is shown at Fig. 371, B. The advantage of this manner of

Miscellaneous Joints

securing a wide board is that it allows the board to contract or expand according to the alterations in temperature. Perhaps one of the most familiar methods of buttoning is shown at Fig. 372. This sketch represents one corner of an inverted table and shows the top secured to the rails by the buttons B; the rails, of course, are grooved in this case to receive the tongue of the buttons.

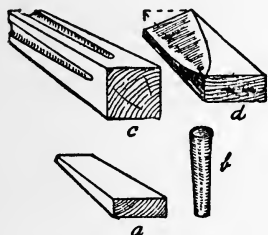

Fig. 374.—Wall Plugs,
Four Varieties.

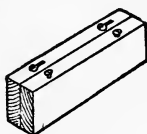

Fig. 375.
Slot Screwing.

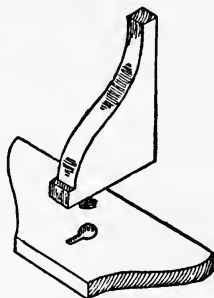

Fig. 376.—Slot
Screwing a Bracket.

Dovetail Plates for Bed Joints.—Fig. 373 illustrates the fixing of a wooden bed side to the bed foot by means of cast-iron plates, which are fitted as shown. These plates may be obtained from any of the large furnishing ironmongers.

Wall Plugs.—At Fig. 374 four types of wall plugs are shown:—*a*, the ordinary rectangular tapered wall plug to drive between the joints of the brickwork; *b*, the circular tapered wall plug as used to plug a wall after a star-shaped brick drill has been used; *d*, a twisted wall plug used for similar purposes to the wedge *a*, but considered to be superior in holding power owing to its twisted formation; *c* is another type of wall plug considered to have great tenacity by reason of its corrugations. Wall plugs

Joints in Woodwork

are required in nearly all cases where it is necessary to joint woodwork to brickwork, as, for instance, heavy-framed silvered mirrors to the walls of shops.

Slot Screwing, or Keyhole Screwing, is a most useful way of joining light woodwork in such a manner that the fixing method is not exposed to the eye. A stout screw is inserted to within $\frac{3}{8}$ in. of the head, as at Fig. 375. In the adjoining piece a hole is bored with a centre bit

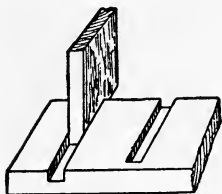

Fig. 377.—Housing Joint.

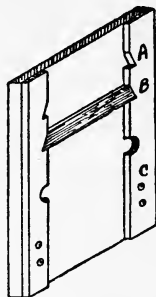

Fig. 378.—Bookcase Shelf Joints.



Fig. 379.—Studs.

and a slot is cut with an $\frac{1}{8}$ -in. chisel. The two pieces of timber are placed together, and by sliding the upper piece forward the screw runs up into the slot or keyhole and secures the joint. Fig. 376 shows the application of the joint fixing a shaped bracket to the shaped shelf; the bracket and shelf are inverted in the illustration to clearly show the method of jointing. For heavy work special brass plates are obtainable for this purpose; one plate is let flush into the upper piece and the other plate into the lower piece.

Housing Joint.—Fig. 377 shows a housing joint which is sometimes called a trenched and housed joint. A trench, groove, or housing is cut so as to receive the portion to

Miscellaneous Joints

be jointed. The left-hand portion shows the trench running the whole width of the shelf; the sketch to the right shows "stopped housing," the groove coming to within $\frac{1}{2}$ in. of the front edge of the shelf. The upright piece is, of course, notched out to engage with it.

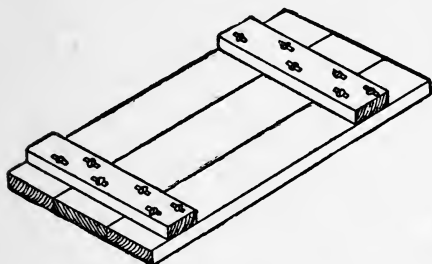

Fig. 380.—Battening.

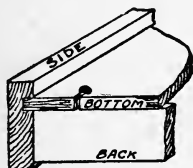

Fig. 381.—Drawer Bottom Joint.

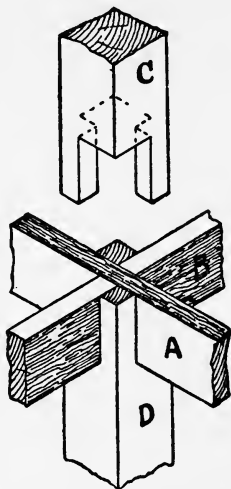

Fig. 382.—Cross-Framing Joint.

Joints for Bookcase Shelves.—Fig. 378 illustrates three methods of supporting bookcase shelves. The method shown at B consists of a strip of wood $\frac{3}{8}$ in. thick, which engages with the notched portion A. Adjustment to the required height is made by altering the strip to the desired notch. At the centre of the sketch an alternate method is shown, the notches here consisting of semi-circular recesses. This latter method is probably more favoured than the former because the two upright pieces can be placed together, and the required holes formed

Joints in Woodwork

by boring with a brace and centre bit, thus forming both recesses at one operation.

Bookcase Studs.—Fig. 379 shows two distinct types of cast-iron bookcase studs; the iron pins are usually $\frac{3}{8}$ in. in diameter, and corresponding holes are bored two-thirds through the thickness of the bookcase ends to receive the pins. Fig. 378, C, shows the holes to receive the studs. A point in favour of bookcase studs is that it is not necessary to line up the thickness of the bookcase ends as when adjustable slips are used.

Battening (Fig. 380).—A good method of joining cross battens to drawing boards and other wide surfaces is shown here. After boring for the screws, slots are cut so as to allow the screws to move along the slots when shrinkage takes place. In Fig. 381 a similar method is applied to secure the drawer bottom to the drawer back. If shrinkage takes place in the drawer bottom and it leaves the groove in the drawer front, the screws are slackened, the drawer bottom is knocked up into the groove, and the screws are again screwed. For drawing boards, etc., specially made elliptical-shaped slotted brass socket cups are made to receive the screw heads.

Fig. 382 shows a joint where two cross-pieces A and B are halved together and fitted to a supporting post C, D—a useful joint for cross-framing and fitment work.

Dovetail Keying.—A method of strengthening the mitred corners of thin boxes is shown at Fig. 383. The box is first mitred and glued. Dovetailed trenches are cut as shown, and small lengths of the tapered dovetailed key piece are cut and inserted in the trenches. Note that the dovetail key piece tapers from *a* to *c*. The small lengths are glued into the trenches formed in the box and all levelled off after sufficient time has elapsed for the glue to set. Boxes made in this manner are generally afterwards finished by the laying on of rich and rare veneers.

Figs. 384, 385, and 388 are joints seldom used in

Miscellaneous Joints

practical work, but which we illustrate for the benefit of Manual Training teachers.

A Butt Joint.—To pull up and fix a butt joint in a

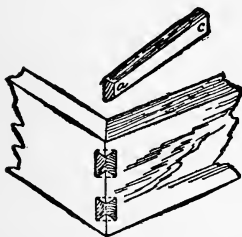

Fig. 383.—Dovetail Keying.



Fig. 384.

counter or any similar job, three pieces of deal and two folding wedges are required. The deal pieces should be about 18 ins. long by 2 ins. by 1 in., the wedges (of hard-



Fig. 385.—Useful Manual Training Exercise Joint.

wood) about 12 ins. long, both out of a piece of $2\frac{1}{2}$ ins. by $\frac{3}{8}$ in., cut as shown at Fig. 386. A 2-in. by $\frac{3}{8}$ -in. mortise is cut in the centre of each of the deal pieces. They are then screwed to underside of counter, through circled

Joints in Woodwork

holes, keeping the centre piece back as shown in diagram. The hardwood wedges are then inserted and the joint pulled up. The other screws can then be put in, giving a very firm job. (See also page 164.)

Coopered Joints.—The term “coopering joint” is seldom used in the cabinet-making trade, although we

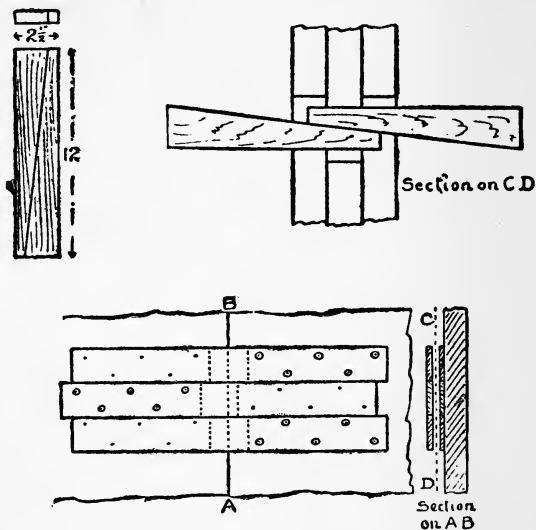

Fig. 386.—Butt Joint for Counters, etc.

find it mentioned in a few of the text-books, and also in the City and Guilds programme of the cabinet-making examination. The name evidently has come from the coopering trade, in which it is one of the commonest forms of joint used in the making of casks and barrels. The pattern-maker and the cabinet-maker have adopted this method of jointing when making and building up circular and shaped work, such as coal-boxes, wine-coolers, cylinder desk falls, curved and serpentine panels, ogee and kidney-

Miscellaneous Joints

shaped carcasses and such like. Three sketches are given at Fig. 387, two of which show the joint tongued. The

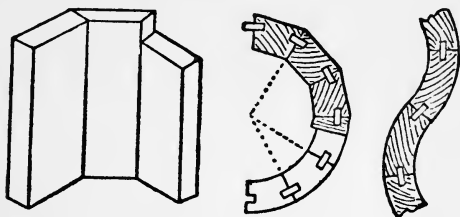

Fig. 387.—Examples of Coopering Joints.

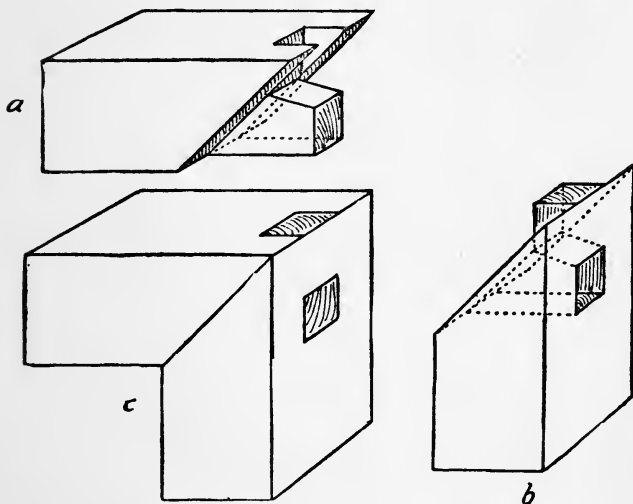

Fig. 388.—Japanese Mitred Tenon Joint (Manual Training Exercise). *a* and *b*, the two parts; *c*, finished joint. (See page 168.)

method of jointing shown in the left-hand illustration is also used to fit the woodwork around engine cylinders, etc., and it is sometimes called "lagging."

Joints in Woodwork

Frames for Oil Paintings.—The method of making joints for frames on which the canvas is stretched for oil paintings is shown at Fig. 389. They are generally mitred at the corners and fitted with loose wedges. The four parts of the frame can be held temporarily by a piece of thin board while the canvas is being tacked to the edges of the frame. In the accompanying illustrations Fig. 389A shows the action of the wedges when tightening up the

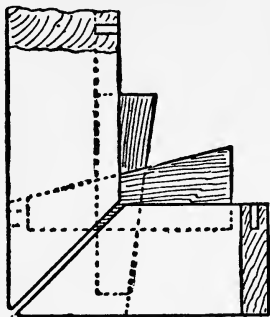

Fig. 389A.

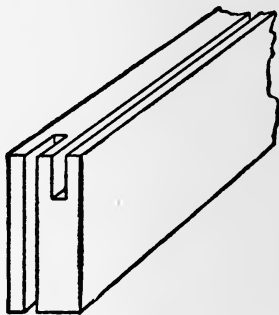

Fig. 389B.

Joint and Method of Wedging the Frames of Oil Paintings.

frame, the result being to open the mitre joint. Fig. 389B shows the position of the saw cuts for receiving the hardwood wedges. Note that the parallel groove is carried the full length of the material for greater convenience in cutting. The other groove is taken from the outer angle of the mitre joint inwards. The cut finishes with due regard to the necessary taper; see the dotted lines showing taper in Fig. 389A. The grooves will be wide enough after being cut with an ordinary hand rip saw, but for large work they are usually grooved on the circular saw bench.

CORRUGATED STEEL FASTENERS.

It is now many years ago since the steel saw-edge fastener first appeared on the market, and at the present time

Miscellaneous Joints

probably 80 per cent. of amateur woodworkers have never seen or heard of its many uses.

It is probably owing to the fact that the fastener could



Fig. 390.—Saw-edge Corrugated Steel Fasteners.

not until recently be bought in small quantities that it has not been generally seen and used.

In appearance it resembles a miniature corrugated

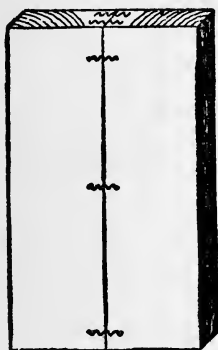

Fig. 391.—Jointing Two Boards.

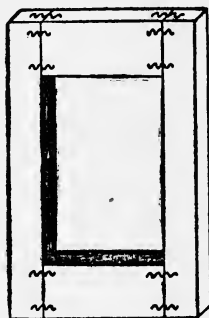
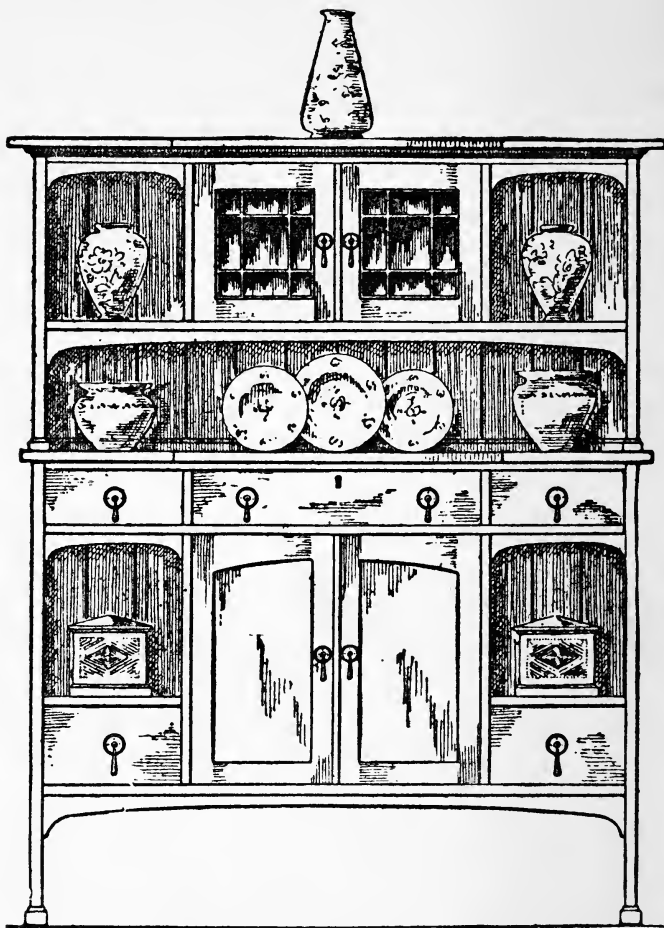

Fig. 392.—Jointing a Frame.

galvanised sheet such as is used for roofing purposes, with the exception, however, that the corrugations are divergent instead of being parallel and that one end is ground down to a cutting edge.

At Fig. 390 three sizes of fasteners are shown. These are made in various sizes from $\frac{1}{4}$ in. to 1 in. in length, and

Joints in Woodwork



Cottage Sideboard.

Miscellaneous Joints

in regard to width they are classed by the number of corrugations and not by their measurement.

To use the Fastener no special tools are required ; it is simply driven in with a hammer exactly as though it

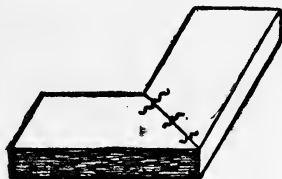

Fig. 393.—Mitred Joint with Steel Fasteners.

were a nail ; once in position, however, to get it out is worse than drawing teeth. The corrugations add to the strength of the device, the wood fibres closing around them, age and rust but emphasising their grip.

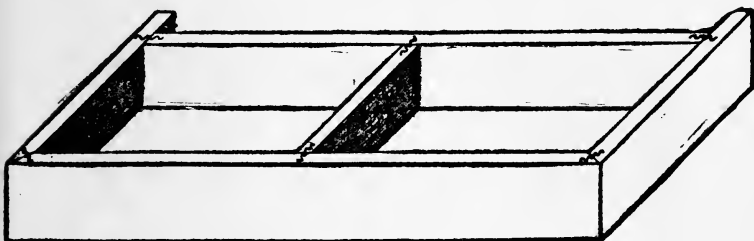

Fig. 394.—Cornice or Plinth for Wardrobe or Bookcase, secured with Steel Fasteners.

Fig. 391 shows the application of the fastener for jointing two boards. Three fasteners are put in one side and two on the reverse side ; one fastener driven into the grain at each end will in nearly all cases be sufficient.

Fig. 392 is a frame which is to be finished by painting. Here the amateur is not troubled with gauging, mortising and tenoning, etc. The ends of the cross-rails are simply

Joints in Woodwork

cut and planed dead square and the fasteners inserted as shown. The use of a cramp is not even necessary, as owing to the bevel on the fastener the shoulder is drawn up close and firm.

Fig. 393 indicates two pieces of 1-in. timber mitred at the corner. To mitre and tenon or mitre and dowel a joint such as this requires a great amount of skill; here the mitres are planed true and the fasteners driven across the joint.

Fig. 394 is a cornice or plinth frame for a wardrobe or similar piece of furniture. All the timbers are shot square, or to the mitre, as may be required, and the whole of the frame is fastened together as shown. The cornice or plinth moulding is then fitted around the frame in the usual way. Numerous examples of the use of this fastener will suggest themselves to readers, and for general repair work, cabinet and joinery work they are an exceptionally useful fastener.

Fasteners of $\frac{1}{2}$ in., with five corrugations, are probably the most useful for general purposes.

THE MITRED JOINT

ALTHOUGH mitreing is used in everyday woodwork, it comes last in our list of regular joints simply because it has been partly dealt with in almost every previous chapter. For example, we have mitre halving in Fig. 35, a mitre bridle joint in Fig. 74, a tongued and grooved mitre in Fig. 114, mitred mortise and tenon joints in Figs. 147 and 158, a dowelled mitre frame in Fig. 204, a mitred dovetail in Fig. 295, and a mitred joint with steel fasteners in Fig. 393.

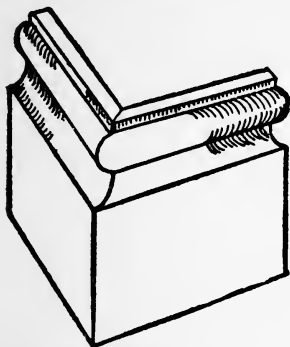

Fig. 395.—Mitred Skirting.

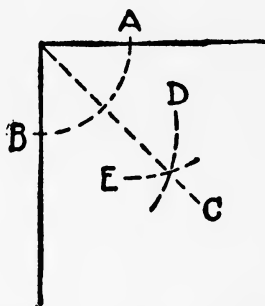

Fig. 396.—Finding a Right Angle for Mitreing.

Mitreing.—The term mitreing is generally used to denote the type of joint used at the corner of a picture frame; or where two pieces of wood are bevelled away so as to fit each other, as the skirting or plinth mould at Fig. 395. In these cases the timber is cut so that the joint is at 45 degrees to the face, and the two pieces, when placed together, form an angle of 90 degrees (a right angle).

The term mitreing, however, is not confined to the fitting of timber around a right angle; it may be justly applied

Joints in Woodwork

to the fitting of a moulding around an angle irrespective of the number of its degrees.

One often hears such terms as "a half mitre," used to denote the fitting of a moulding around an octagonal

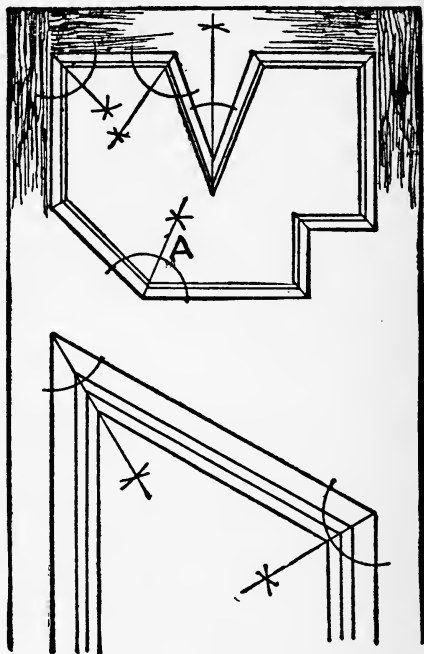

Fig. 397.—Finding Angles for Straight Mitres.

column or pedestal, and probably it would be more correct to describe the joint as a mitre cut at $22\frac{1}{2}$ degrees. Mitreing consists of halving the angle and making each piece to fit the line of bisection. Should the angle be bounded by straight lines, as at Fig. 396 or Fig. 397 A, then the mitred joint will be a straight line, but should the angle

The Mitred Joint

be bounded by a curved and a straight line, as at Fig. 405 A, or by two curved lines, then the mitred joint will have to be a curved line if the mouldings are to be of the same section.

STRAIGHT MITRES.

Finding the Angle.—We will first deal with straight mitres, such as are shown in the upper panel of Fig. 397.

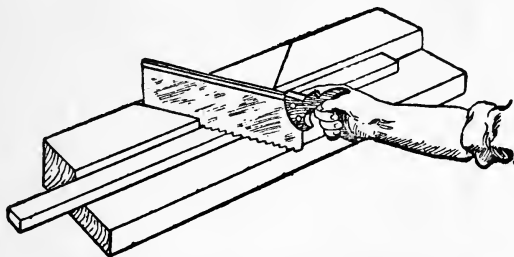

Fig. 398.—Sawing Block for Mitreing.

The mitre joint line is found by bisecting the angle, as shown in the various examples, and the following instructions are given to enable the reader to follow the enlarged diagram (Fig. 396). Take a pair of compasses, or dividers, and with any convenient opening strike out the arc A, B. Put the point of the compasses on A, and mark another arc E; then, without altering the distance between the points of the compass, put the point on B, and mark the arc D. Draw the line C from the corner, and allow it to cut through the intersection made by the arcs E and D. The angle A B is now halved by the line C, and this method may be applied to any angle—a variety of which are shown in Fig. 397.

Sawing Block.—For sawing mouldings, etc., to their

Joints in Woodwork

approximate shape, a home-made sawing block is generally used, as shown at Fig. 398. Two pieces of wood are glued

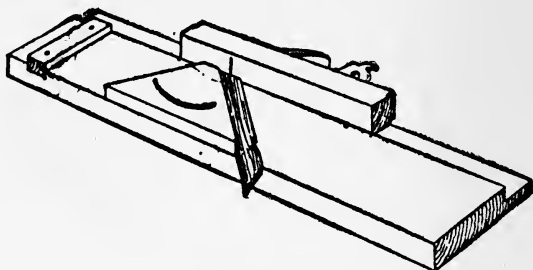

Fig. 399.—Mitre Shooting Board.

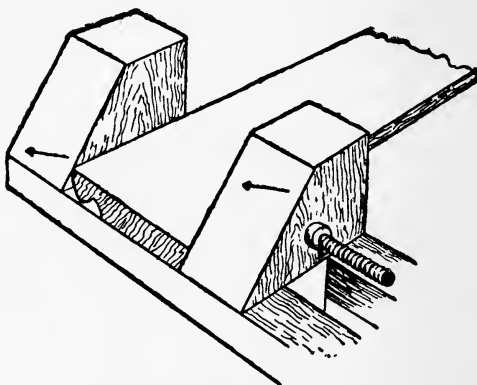

Fig. 400.—Screw Mitre Trap.

one on the top of the other, the required angle is transferred thereto, and the saw kerf made. In the sketch the saw kerfs are shown at 45 degrees, right and left; and, of course, other angles and saw kerfs may be made where desired.

The Mitred Joint

Planing.—After sawing the piece to approximately the correct angle, it is necessary on high-class work to plane the cut end so as to give a perfect finish and enable a glued joint

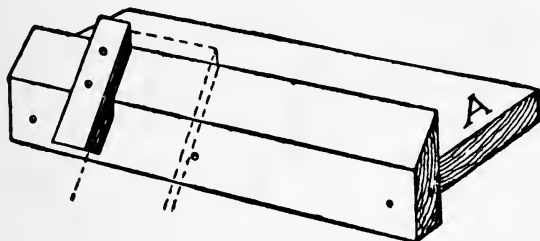

Fig. 401.—“Donkey’s Ear” Shooting Board.

to be made. This may be accomplished by using the plane on the shooting board, as shown at Fig. 399, and, if the worker is constantly using mitres of various angles, it is

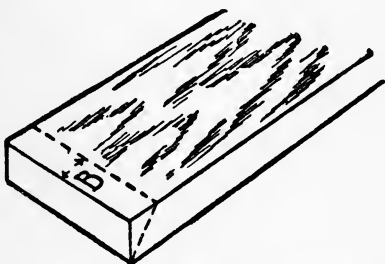

Fig. 402.—Gauging for Mitres.

an easy matter to make the angle block swivel to the required bevel by cutting a slot, as indicated, and then securing the block with a bolt and thumbscrew, or with a couple of stout gauge screws. Other workers prefer the screw mitre trap shown at Fig. 400. This apparatus takes wide plinth

Joints in Woodwork

or cornice moulds, and the angle may be altered by fitting temporary packing pieces under the work so as to tilt the moulding to the desired angle. The method of using the plane is indicated by the arrows.

Another method in everyday use by those workers who are constantly mitreing wide pieces of stock at 45 degrees is the "donkey's ear" shooting board illus-

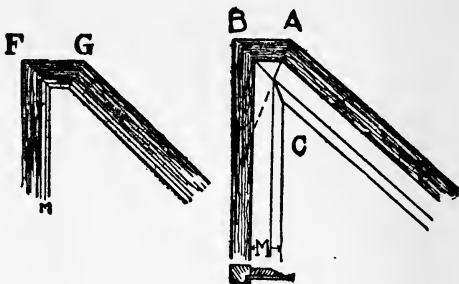

Fig. 403.—Bevelled Framing with Mitred Moulding.

Fig. 404.—Framing with wide Mitred Moulding.

trated at Fig. 401. The plane is laid on its side on the surface of the board marked A, and used in a similar manner to that shown at Fig. 399.

A simple method and one that should always be remembered because it is handy when working without a shooting board is shown at Fig. 402. Set the marking or cutting gauge to the thickness of the wood to be mitred at 45 degrees; then gauge this distance on the wood, as shown at B; draw from the line to the edge, as shown, and saw and plane to a finish. The diagonals of a square give 45 degrees, and this is the method used to mark out the work. The end of the wood must, of course, be square with its edges before marking out in this manner.

Fig. 403 shows a bevelled framing into which has been

The Mitred Joint

mitred a narrow moulding M so as to show a correct margin around the panel.

Fig. 404 shows a similar framing, but with a wide moulding M mitred around it. To obtain a correct intersection of this moulding, the angles B and A are bisected. The bisection of the angles meets before the width of the moulding is cleared, therefore the angle C will again have to be

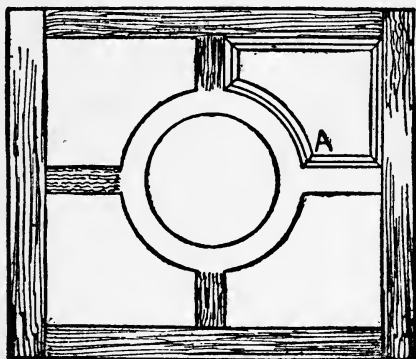

Fig. 405.—Door with Curved Mitres.

bisected, and the finished joint will appear as shown. One of the simplest of mouldings with a large flat face has been chosen to illustrate this. The moulding could be all in one width, as shown, or it could be built into the framing in separate pieces, the wide flat and the piece carrying the ogee moulding.

CURVED MITRES.

We now come to what are probably the most difficult of all mitres, viz., curved mitres, and the writer well remembers in his apprenticeship days his first experience of attempting to fit the mouldings around the door shown at Fig. 405 by using straight mitres at A. This, of course,

Joists in Woodwork

is impossible if the mouldings are of the same section, and it is desired to make all the members correctly intersect. If straight mitres are used the section of the curved moulding will have to be of a different shape to the section of the straight moulding, and in these days of machine-made mouldings this method is seldom resorted to. It is better, cheaper, and easier, to make curved mitres when the necessary machinery is at hand.

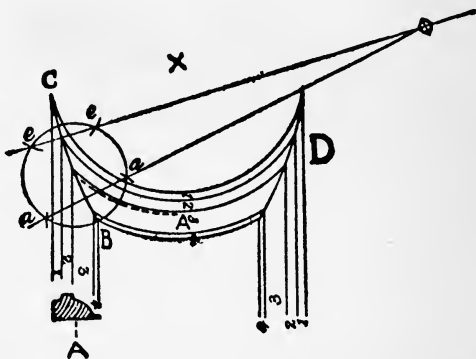

Fig. 406.—Method of Setting-out for a Curved Mitre.

Some years ago the writer had eighty panels, similar to Fig. 406, to fix around a large room, and, with the aid of a home-made "former" worked the mouldings and their respective curved mitres on a double spindle moulding machine.

The Method of Setting-out a Curved Mitre is indicated at Fig. 406 and is as follows:—Draw a section of the moulding full size, as shown at the left hand of the illustration, and project lines round the framing, as shown 1, 2, 3 and 4. Where the lines 1, 2, 3 and 4 intersect at the corner D, it clearly shows that a straight mitre will not cut all the points of intersection. A curved line will cut all the

The Mitred Joint

intersections, and a template made of cardboard, sheet zinc, or veneer, should be made to this shape. At the left-hand side the geometrical setting out is shown for obtaining the curve without having to resort to drawing it beforehand.

Take half the width of the moulding, as shown by dotted line A, and where it cuts the approximation of the curved

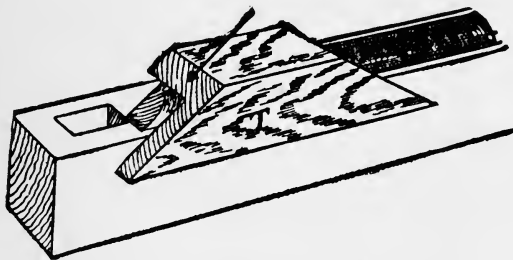

Fig. 407.—Template for Mitreing.

mitre place the point of the compasses and strike out a circle as shown; with the same radius place the compass point on B—that is the inside point of the mitre, and cut the circle on the right and left with the small arcs shown at *aa*. With the same radius put the compass point at the junction of the circle and mitre line *Cx*, and cut the circle at right and left, viz, *ee*.

Now rule a line through *aa*, and another line through *ee*, and where these lines cut each other it will give the correct radius of the curved mitre. The advantage of knowing the correct radius of a curved mitre is of great benefit to the skilled machinist, as it enables him to set up his machine so as to give a definite result. Many other instances of curved mitres could be given, but the general principles governing this class of work will be readily seen from the above examples.

Joints in Woodwork

Mitreing a Moulded Door Frame.—Fig. 407 illustrates the method of mitreing the moulded portion of a door frame where the joint is tenoned and mortised. A small wooden template T is made out of beech or other hardwood, having its ends cut at 45 degrees. This template is placed on the rail, as shown, and held in position by placing both the rail and the template in the vice. The face of the template forms a guide for a wide chisel, and enables the worker to gradually pare away the moulding to the correct angle. The chisel is used in the direction indicated by the arrow mark.

PUZZLE JOINTS

CHINESE JOINT PUZZLE

THE ingenious puzzle of the Chinese type shown here is probably older than many of us could guess, but as it is one that can be made by any woodworker we give full directions as to how it may be constructed. For the benefit of others, too, into whose hands the finished puzzle may fall, we give also the key as to how it may be taken down and fitted together again.

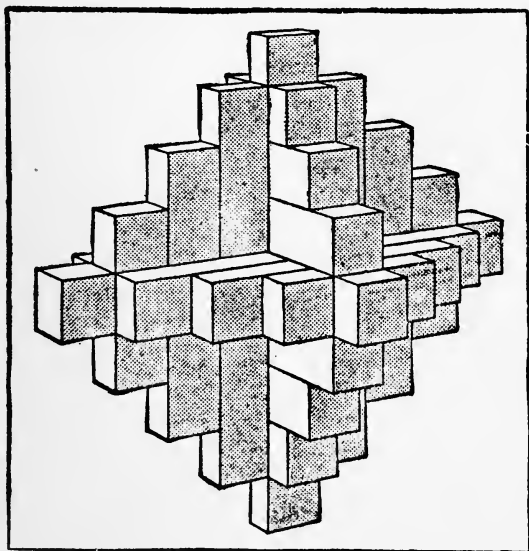

Fig. 408.—Sketch of the Completed Chinese Puzzle.

Joints in Woodwork

The complete article as shown in Fig. 408 may be called, in form, a six-pointed pyramid. It is made up of twenty-one different pieces, each cut from wood $\frac{1}{2}$ in. wide and $\frac{1}{2}$ in. thick; $\frac{3}{8}$ in. wood may be used if preferred. For the purpose either sycamore or white maple is the most useful.

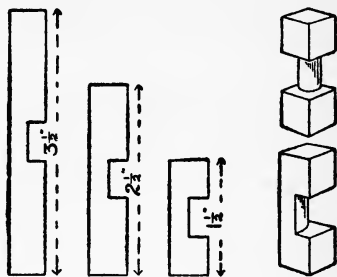

Fig. 409. Fig. 410. Fig. 411. Fig. 412.
 The Three Cross Pieces. Key Piece,

THE TWENTY-ONE PARTS.

The pieces required are as follows:—

Fig. 409.—Six pieces, $3\frac{1}{2}$ ins. long, with a half slot cut in the centre as shown. This slot must be exactly the width of the wood's thickness, and cut exactly half way through, so that, if two pieces are placed across by means of the halved joint, their surfaces will be flush. The slot must also be exactly in the centre.

Fig. 410.—Six pieces, size $2\frac{1}{2}$ ins. long, with a half-cut centre slot similar to that of Fig. 409.

Fig. 411.—Six required, these being $1\frac{1}{2}$ in. in length, and with slots in the middle as before.

Key Piece (Fig. 412).—One of these last six requires special treatment, as it forms the key block of the puzzle. After its slot has been cut, one half of the narrow part must be sawn away, as shown in Fig. 412. The inner edge must also be gently rounded. The special use of this vital

Puzzle Joints

piece, which we will call the "key," will be fully explained presently.

Fig. 413.—Then, in addition to these, there are three central bars to make. Like the other parts they are $\frac{1}{2}$ in. by $\frac{1}{2}$ in., but are each $4\frac{1}{2}$ ins long, and are cut as shown in Fig. 413. The end projections *a* are $\frac{1}{2}$ in. long, and the cut-away part is exactly half the depth of the wood. Two of the three pieces (X and Y in Fig. 413) are similar,

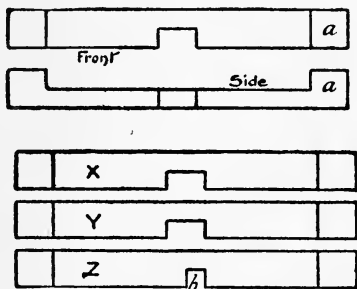

Fig. 413.—The Central Bars.

but the slot *b* of the third one Z is only $\frac{1}{4}$ in. wide instead of $\frac{1}{2}$ in. As will be noticed, this $\frac{1}{4}$ -in. slot is *not* in the centre, but corresponds with the right-hand half of the larger slots of X and Y.

In making these twenty-one pieces, what should be borne in mind is that the different parts fit closely into each other. Consequently the slots, in width, must be cut so as to grip the thickness of the wood; in depth they must be exactly half this thickness.

FITTING THE PUZZLE.

In fitting up the puzzle, the three central bars must first be joined, as those form the skeleton framework of the article. Fig. 414 shows them in position, but as it is

Joins in Woodwork

a puzzle in itself as to how they can be got thus some explanation is necessary.

First Stage.—First take the bars X and Y (see Fig. 413) and arrange them as shown in Fig. 415. It is most important that the projections *a* of X face upwards, and that the projections *a* of Y face towards the centre. Then take the bar Z and bring it flat into the slot of X. The little

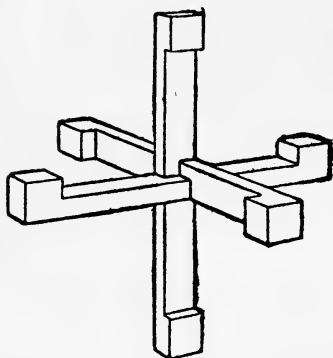

Fig. 414.—The Three Central Bars in Position.

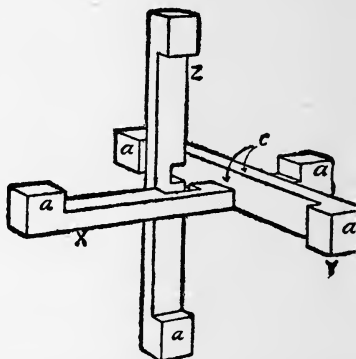

Fig. 415.—How to Adjust the Bars. (Note position of projecting ends, *a*.)

slot of Z, however, must remain *above* the slot of X. Then slide the bar Y along to the centre, so that the part lettered *c* slips into the little slot of bar Z.

This may seem confusing to read, but it is easy to follow when the pieces are in one's hand. The result of this rather clever arrangement is that the six arms of Fig. 414 are all exactly the same length, width, and thickness. They are also arranged so that in each arm may be clasped one piece each of Figs. 409, 410, and 411. The three central arms may, of course, be set up in a different order, and here we have merely chosen the way that is the most simple to describe and illustrate.

Puzzle Joints

Second Stage.—In the remaining part of the work the chief difficulty is to keep the puzzle from falling to pieces before the key finally locks it. Take the longer cross parts, Fig. 409, and clasp one to each arm. The six need not all be put on meanwhile, but only those which are most easily handled. The next size (Fig. 410) may then be put on.

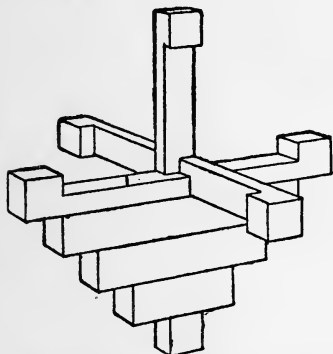

Fig. 416.—Beginning to place on the Cross Pieces.

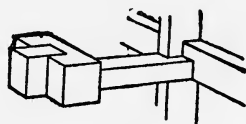

Fig. 417.—Placing the Key Piece to overlap end projection of Central Bar.

In the ordinary course each arm could be completed with its three cross pieces till the sixth was attempted, and here the reader would find that, at the last moment, his attempt was frustrated. He could not get the last small piece in, as other bars lock the puzzle. Here it is that the "key" comes in.

THE KEY PIECE.

When the writer fits up the puzzle he finds that three of the arms may straight away be fitted complete with their three cross parts. These are the ones where the longer cross piece (Fig. 409) lies flush with the back of the

Joins in Woodwork

central bar (see Fig. 416). This is easily found out when at work on the puzzle. In the case of the other three arms there is, of course, a gap caused by the long slots of the central bars. Adjust the parts on the first-named three arms, and then deal with the fourth arm, putting in all three cross parts. For the little one here, use the "key."

Inserting the Key.—By placing the "key" so that it *overlaps the end projection* of the arm (see Fig. 417) a space is left at the centre, and means is thus afforded for getting in the three cross parts on the remaining two arms.

Turning the Key.—This practically ends the puzzle. While the "key" is in its overlapping position the parts may be separated, but if it is *turned round on its narrow neck*, so that it is in exactly the same position as the other five small cross parts, it locks the whole thing so tightly that nothing but sheer force could loosen the twenty-one pieces.

So far as the order of putting together is concerned, there are many equally satisfactory ways, these being determined by the ease or difficulty that one experiences in holding the half-finished puzzle. It all comes to the same in the end, and the "key" must be placed on one bar before the last three arms can be completed. The "key," moreover, must be on one of the bars where a gap is left at the centre, and not on one where Fig. 409 lies flush against the central arm as in Fig. 416.

UNDOING THE PUZZLE.

To take the puzzle to pieces all that is required is to turn the "key" half round and push the other two cross bars on that arm towards the outer point. The cross bars below may then be removed, and the whole structure falls to pieces.

Puzzle Joints

A CURIOUS DOVETAIL JOINT.

Fig. 418 represents two blocks of wood, $2\frac{1}{2}$ ins. square, dovetailed together. All four sides are the same, and at

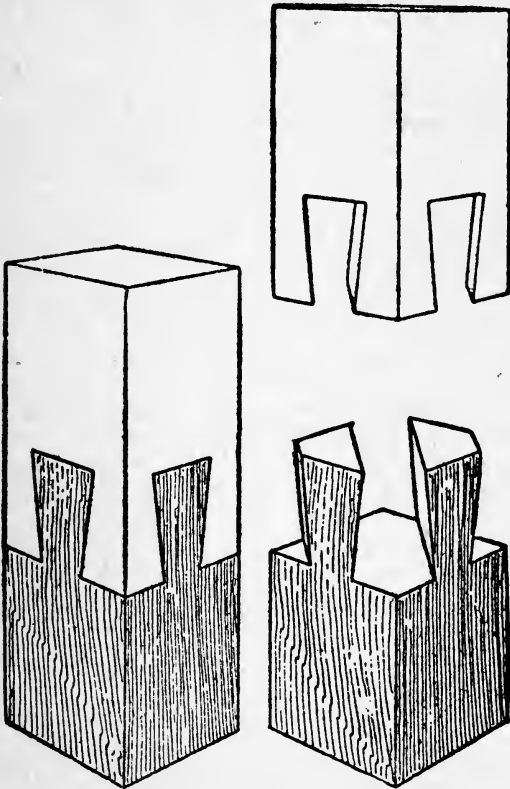
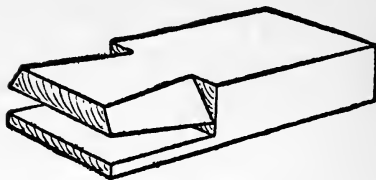

Fig. 418.

Fig. 419.

Puzzle Dovetail Joint.

Joints in Woodwork



Sketch of Dovetail Piece.

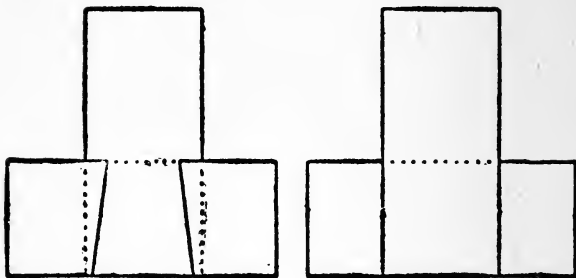

Front Elevation.

Back Elevation.



Plan, looking upwards.

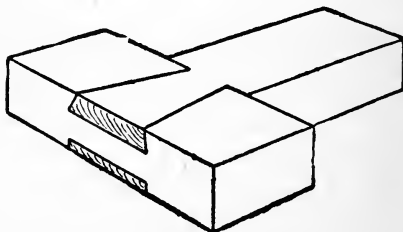

The Finished Puzzle Joint.
Fig. 420.—Dovetail Puzzle Joint.

Puzzle Joints

a first glance it would be said that such a joint could neither be put together nor taken apart.

The illusion, however, is obvious when Fig. 419 is examined. This shows the two pieces apart. The joint is a sham dovetail. The upper part is not fitted into the lower from above, but the lower piece merely slips into the other *from the side*.

To make the puzzle well, very neat work is required, and it will be easier working with wood not less than 2 ins. square. Take two blocks of wood, say $2\frac{1}{2}$ ins. square and about 5 ins. long. Let one piece be dark and the other light. If there is this contrast in colour the puzzle will be more interesting. Plane all four sides and see that the ends are true and clean.

First take the lower block, and on the top and four sides mark carefully the exact positions of the dovetails. If the wood used is $2\frac{1}{2}$ ins. square these dovetails may be 2 ins. long, $1\frac{1}{4}$ in. wide at the top, and $\frac{3}{4}$ in. wide at the neck. Saw carefully and pare away the waste wood with the chisel. The upper block, which must of course fit the lower one exactly, is then marked and cut.

DOVETAIL PUZZLE JOINT.

The dovetail puzzle joint illustrated at Fig. 420 has perhaps caused more argument and controversy amongst woodworkers than any wooden joint. It may be neatly made in yellow pine or mahogany, and afterwards glued up. The question everyone asks is: How was it put together? The sketches show reverse and obverse sides, and also a sketch of the dovetailed piece which fully explains its solution. The puzzle may, of course, be made any convenient size—say, out of timber 2 ins. wide by $1\frac{3}{4}$ ins. thick.

Joints in Woodwork

EASTERN JOINT PUZZLE.

Below are illustrated two methods of making a simple little puzzle which was introduced into this country some years ago. Take a piece of straight-grained timber, about 28 ins. long (birch answers splendidly) and plane it up to exactly $\frac{1}{2}$ in. square. Now cut and make it into six blocks, as shown at Fig. 422. The sizes of the various slots in

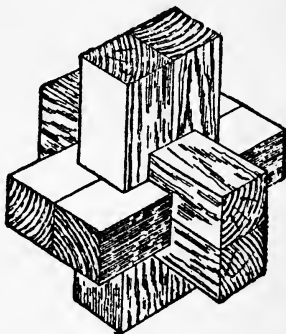

Fig. 421.—Eastern Puzzle.

the blocks are respectively 1 in., $\frac{3}{4}$ in., $\frac{1}{2}$ in., and $\frac{1}{4}$ in. Arrange the pieces so as to form the completed puzzle, as shown at Fig. 421.

Fig. 423 shows another method of slotting the blocks which will give the same result. Note, however, that piece 6 in both Fig. 422 and Fig. 423 is left square, no slots being required, owing to the fact that this is the key-piece and is fitted into position last of all.

This is an interesting puzzle and easy to make; at the first attempt it took the writer exactly sixty-five minutes to place the pieces in their correct position.

Puzzle Joints

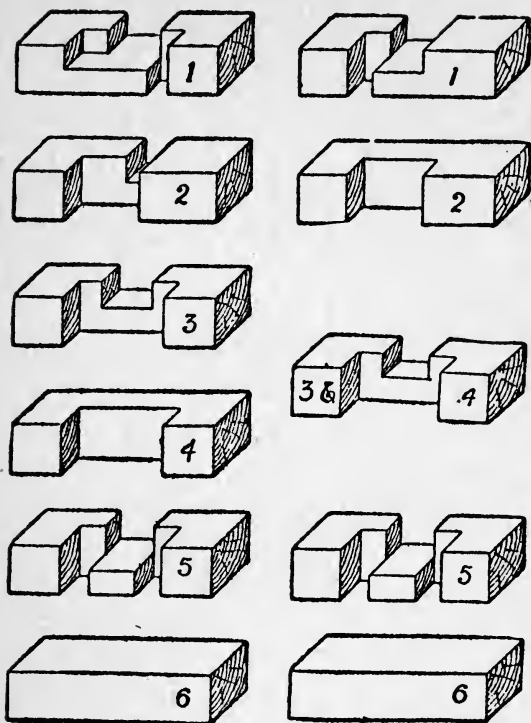

Fig. 422.

Fig. 423.

Alternative Methods of Making the Puzzle.

A MORTISING PUZZLE.

The ordinary mortising exercise is, after the first two or three attempts, generally voted as uninteresting, but, although the simple puzzle shown in Figs. 424, 425, and 426 is practically an exercise in mortising, yet, forming as it does a puzzle, it becomes a fascinating piece of work.

Joints in Woodwork

The puzzle is composed of three pieces of wood, each 4 ins. long, $1\frac{1}{2}$ ins. wide, and $\frac{1}{2}$ in. thick. In each piece a mortise $1\frac{1}{2}$ ins. by $\frac{1}{2}$ in. should be cut as shown at 1,

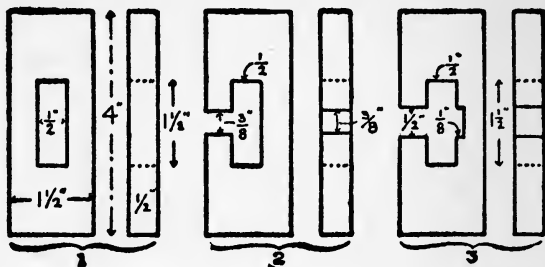

Fig. 424.—The Three Parts.

Fig. 424. In one piece, marked 2, a groove is cut on one side, $\frac{3}{8}$ in. wide, and in another piece 3 a similar slot, but $\frac{1}{2}$ in. wide, is cut, and this is continued on the other

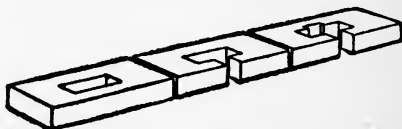

Fig. 425.—How to Cut the Parts.

side of the groove to a depth of $\frac{1}{8}$ in. The three pieces should be set out on a 13-in. by $1\frac{1}{2}$ -in. by $\frac{1}{2}$ -in. length of wood, as shown at Fig. 425, and when ready sawn apart.

The puzzle is put together as shown at Fig. 426. In the first place, hold No. 1 piece upright as shown at A, then take No. 2 piece with slot uppermost and push it through the opening in No. 1 piece until the nearest side

Puzzle Joints

of the slot projects $\frac{1}{8}$ in. as indicated at B. Next place No. 3 piece on with the slot at the back as shown at C, and push it down until it touches the bottom of the opening in No. 2 piece as illustrated at D. The only thing to do now is to push No. 2 piece as far as it will go to make the figure as shown at E.

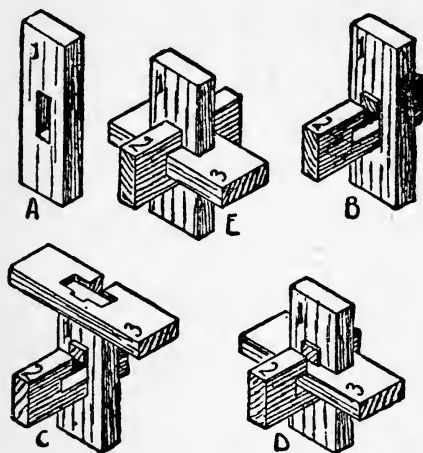

Fig. 426.—How to Put Together.

In this puzzle the parts should fit together fairly tight, but should not be too stiff.

SIX-PIECE JOINT PUZZLE.

Fig. 427 illustrates a six-piece puzzle joint, similar in some respects to Fig. 421, but in this case the pieces B, C, D, E and F are cut slightly different. Both a back and front view of the piece D is shown for clearness of illustration. The method of assembling the pieces is as follows:—Hold piece B upright, and fit piece D across;

Joints in Woodwork

at the same time note that the small *x* marks are opposite each other. Take piece E and, holding it as shown, slide it up the piece B (see arrow) until E engages with D and

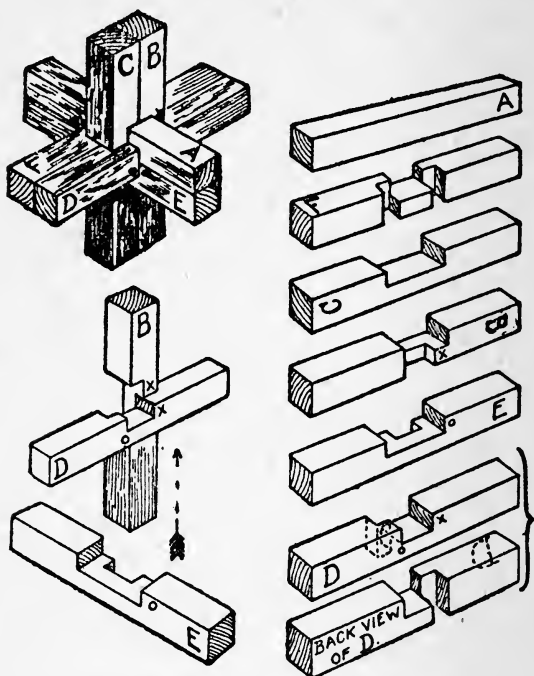

Fig. 427.—Six-piece Joint Puzzle.

the small *o* marks are opposite each other. Piece C is now fitted behind D, and then piece F will slide in position and push downwards. The key-piece A is now put in position, and the puzzle is completed.

INDEX

AIR-TIGHT joints, 116
Alignment in hingeing, 94
American whitewood, 121
Angle, bridle joint at, 38
Angle butt joint, 5
Angle dovetail keying, 129, 130
Angle dovetailing, 131, 132
Angle halved joint, 25
Angle iron, buttoning with, 164
Angle, oblique, bridle joint, 29, 30
Angles of dovetails, 118
Angle, right, for mitreing, 177
Architrave mould, hinge clearing, 109, 110
Astragal, brass, 112, 113
Astragal, rebated, 112
Awl, marking, 88, 123, 138
Awl, marking, using for dovetails, 137

BACK flap hinge, 99, 100
Bagatelle hinge, 99
Barefaced tenon, haunched, 55
Barefaced tenon joint, 53
Barred door joints, 44, 45
Barrow wheel, halved joints on, 16, 17
Battening, 167, 168
Beaded match-boarding, 40
Beam (tie) and rafter joint, 162
Beam, tie, bridle joint for, 29, 30
Beam, tie, joint 63, 64
Bearer rail, dovetailed, 131
Bed joint, dovetail plate, 164, 165
Beechwood dowels, 78
Bevel, joiner's, 21, 38, 145
Bevelled dovetail half-lapped joint, 17
Bevelled dovetailing, 131, 132
Bevels for dovetails, setting out, 119
Birdsmouth joints, 162, 163
Bit, block for twist, 85.
Bit, rose, 80, 81

Bit, twist, 81
Blind lap-dovetailing, 127
Block for twist bit, 85
Block, guide, for bevelling in dovetail grooving, 146
Block, sawing, for mitreing, 179
Blocking, glue, 159, 160
Boarding, match, 39
Boards, battening drawing, 167, 168
Boards, clamping drawing, 66
Boards, dowelled, ready for glueing, 82
Boards, flooring, 39
Boards, joining weather, 153
Boards jointed with steel fasteners, 173
Bolection mould, 63
Bolts for scarf joint, 92
Bookcase shelf joints, 166, 167
Boring for dovetails, 122
Boring waste for bridle joint, 33
Box, hinge-bound, 93
Box, laminated core, 152
Box lid, hingeing, 97
Boxes, dovetail keying for 168, 169
Boxes, dovetailing small, 132, 133
Boxes, dovetails for, 118
Boxes, dovetails for small, 129, 130
Boxes, dowelling rough, 77, 78
Boxes, knife, dovetailing, 131
Brace, 79, 88
Brace, oblique bridle joint for, 28
Bracket, slot screwing a, 165, 166
Brass astragal, 112, 113
Bridle joint at angle, 38
Bridle joint for frame (open slot mortise and tenon), 28, 29, 38
Bridle joint for truss, 29
Bridle joint, frame with, 36
Bridle joint, mitre, 28
Bridle joint, oblique, 28

Index

- Bridle joint, oblique angle, 29, 30
Bridle joint, setting out and marking, 30
Bridle joint, simple, 27, 31
Bridle joint, stopped, 28, 29
BRIDLE JOINT, THE, 27-38
Bridle jointed leg, 27
Bridle joints, boring waste for, 33
Bridle joints, chiselling, 34, 37
Bridle joints, cutting the shoulders, 35
Bridle joints, frame with, 28
Bridle joints, gauging for, 31
Bridle joints, sawing, 33
Bureau, hingeing fall front of, 103
Butt hinge, 93, 95
Butt hinge, rising, 99, 100
Butt hinges, fitting, 101, 102
Butt joint, 1
Butt joint, angle, 5
Butt joint for counters, 169, 170
Butt jointing counter tops with dovetail keys, 164
Buttoning, 164
Buttoning with angle iron, 164
Buttons (or pateras), turned, for screw fixtures, 155
- CABINET, china, 108
Cabinet joints, tongued, 41
Cabinet top with glued joint, 9
Cabriole leg, dowelling, 87
Caddies tea, housed and mitred, joint, for, 128
Canvas painting frames, 171, 172
Cap, dowelling, 86
Carcase end and bearer rail, dovetailed, 131
Carcase end, lap-dovetailing wardrobe top to, 131, 132
Card table hinge, 99, 100
Carpentry tie joint, 19
Castor pins, 158
Cellarette partition joints, 19, 20
Centre or pivot hinges, 98, 99, 100
- Chair and table legs, jointing broken, 158
Chalk, 2
Channel at shoulder of tenon, cutting, 72
Channel, cutting for dovetailing, 124, 125
Channel, paring for dovetail grooving, 145
China cabinet, 108
Chinese puzzle joint, 187
Chisel, the, 21, 23, 35, 72, 73, 74, 80, 81, 121, 122, 125, 145
Chisel, using for dovetailing, 135, 136
Chiselling bridle joints, 34, 37
Circular fronted work, dovetailed, 130, 131
Circular jointing, marking segments for, 149, 150
Circular rim in halved segments, 150, 151
Circular work, joints for, 149
Circular work, putting together, 150.
City and Guilds, 170
Clamping, 66
Close joint hingeing, 110
Cogged joint, 161
Columns, jointing wood, 159
Combing or locking joint, 45
Coopered joints, 170, 171
Core box, laminated, 152
Corner dovetail, 134
Corner joint, halved, 12
Corner jointing, glued, 5
Corner joints, tongued 45, 46
Cornice or plinth secured with steel fasteners, 175
Cornice pole, finial for, 153, 154
Cornice pole, method of dowelling, 83
Cornice poles, hinged joint for, 156
Cornices, blind lap-dovetailing for, 127
Corrugated steel fasteners, 172
Counter tops, butt jointing with dovetail keys, 164

Index

- Counters, butt joint for, 169, 170
Cradle, dowelling, 78, 79
Cradle for planing, 42
Cramp, 148
Cross framing joint, 167, 168
Cross halving joint, 15, 18
Cross halving joint with housed shoulders, 19
Cross rail and stile, framed, 56
Cross rail and upright halved joint, 19
Cross tongues, 41, 42, 43, 50
Crush feet, 158
Cupboard door shutting joints, 111, 113
Cupboard doors, curved, shutting joint for, 113
Cupboard, medicine, joints, 62
Curved mitres, 183, 184
Curved work, dovetailed, 130, 131
Curved work, hingeing, 94
CURVED WORK, JOINTS FOR, 149—152
Cutting gauge, 120, 133, 134
Cutting gauge for dovetailing, 120
Cutting gauge, how to use for dovetails, 134
Cutting the recess for hinges, 95, 96
- DESK hinge, 99
Desk, joint for roll top, 161, 162
Desk top, clamping, 66
Dining-table leaf, dowelling a, 84
Dining-table leg and framing, dowelling, 86, 87
Dining-table slide joint, 159
Donkey's ear shooting board, 181
Door, barred, joints for, 44, 45
Door, cupboard, shutting joints, 111, 113
Door frame, building up semi-circular head of, 151, 152
Door frame joints, 55
Door frame, mitreing a moulded, 186
Door with curved mitres, 183
- Doors, hinge-bound, 93, 94, 96
Doors, hingeing at an angle, 100, 101
Doors, inside hingeing of, 101
Doors, outside hingeing of, 102, 103
Doors, screw-bound, 94
Doors, shutting joint for curved, 113
Doors, stop-bound, 93, 94
Double folding or reversible screen hinge, 98, 99
Double-tenoned scarf joint, 90, 91
Dovetail and wedged tenon, 62
Dovetail (bevelled) half-lapped joint, 17
Dovetail, corner, 134
Dovetail for boxes, 118
DOVETAIL GROOVING, 145—148
Dovetail grooving, bevelling guide block for, 146
Dovetail halving, 13
Dovetail halving, oblique, 14
Dovetail halving, stopped, 14, 15
Dovetail, housed and mitred, 128
Dovetail joint, curious puzzle, 193
Dovetail joint, mitred, 128
Dovetail joint, possible origin of, 117
Dovetail joint, setting out and marking the, 132
Dovetail joint, squaring, 134
DOVETAIL JOINT, THE, 117—144
Dovetail joints, glueing, 144
Dovetail joints in framing, 127
Dovetail keying, 129, 130
Dovetail keying for boxes, 168, 169
Dovetail keys, butt jointing counter tops with, 164
Dovetail (lap) pins, roughing in, 122
Dovetail pins, 120
Dovetail pins, marking, 133, 135
Dovetail pins, sawing, 143

Index

- Dovetail plates for bed joints, 164, 165
Dovetail puzzle, 194, 195
Dovetail saw, 96, 124, 144
Dovetail tongue and groove joint, 41
Dovetail, with halved joint, 14
Dovetailed and halved joints, 16, 17
Dovetailed bearer rail, 131
Dovetailed curved work, 130, 131
Dovetailed footstool, 130
Dovetailed halved joint (one side) 14
Dovetailed halving joint for lengthening timber, 15, 16
Dovetailed scarf joint, 89, 90
Dovetailed stretcher rail, 127, 130
Dovetailed tee halving joint, 15, 16
Dovetailing, angle or bevelled, 131, 132
Dovetailing, blind lap, 127
Dovetailing, chisel work, 135, 136
Dovetailing, cutting channel for, 124, 125
Dovetailing drawers and boxes, 139
Dovetailing jewel drawer, 131, 132
Dovetailing, lap, 118
Dovetailing, lap, blind, 127
Dovetailing, lap, drawer fronts, 141
Dovetailing, lap, wardrobe top, 131, 132
Dovetailing, oblique, 131, 133
Dovetailing—removal of waste, 124, 125
Dovetailing template, 135, 136
Dovetailing, through, 117, 141
Dovetails, angles of, 118
Dovetails, boring for 122
Dovetails, cutting several at once, 125, 126
Dovetails, frame, 125, 126, 127
Dovetails, gauging for, 119, 135
Dovetails, marking with saw blade, 123,
Dovetails, method of marking with cutting gauge, 120
Dovetails, sawing, 123, 138
Dovetails, setting out bevels for, 119
Dovetails, squaring, 119
Dovetails, using marking awl for, 320
Dowel gauge for legs, 86, 87
Dowel, method of making, 77
Dowel plate, steel, 78
Dowel rounder, 80, 81
Dowel screw, 154, 159
Dowel with groove, 79
Dowelled boards ready for glueing, 82
Dowelled joints, various applications of, 83
Dowelling a cabriole leg, 87
Dowelling a mitred frame, 84
Dowelling a shaped rail, 85
Dowelling a table leaf, 84
Dowelling a washstand pediment, 88
Dowelling caps, 86
Dowelling cradle, 78, 79
Dowelling for moulded frame, 86
Dowelling for turned pillar, 86
Dowelling, frame 84, 85
DOWELLING JOINT, THE, 77—88
Dowelling, marking and gauging boards for, 81, 82
Dowelling packing cases, etc., 77, 78
Dowelling, probable origin of, 77
Dowelling table leg to framing, 86, 87
Dowelling thick timber, 82
Dowels, beechwood, 78
Dowels, cradle for planing, 78, 79
Dowels, glueing, 82
Dowels, good and bad, 80
Dowels, iron, 77
Dowels, length of, 82
Dowels, making, 78
Dowels, method of grooving, 79

Index

- Dowels, spacing, 81
Draught preventer, 115
Draught screens, hingeing, 104
Drawbore pinning, 63, 64
Drawer bottom joint, 167, 168
Drawer (cellarette) partition joints, 19, 20
Drawer front, lap-dovetailing, 141
Drawer, glueing plough-slip to, 7, 8
Drawer, jewel, dovetailing, 131, 132
Drawer joint, dust proof, 114
Drawer making (*see* dovetail joint)
Drawer runner, groove in, 43
Drawer sides, marking for, 122
Drawers and boxes, dovetailing, 139
Drawers, dressing table chest of, 140
Drawers, example of table with four, 144
Drawers, sawing dovetail pins of, 143
Drawing boards, battening, 167, 168
Drawing boards, clamping, 66
Dreadnought file, 66, 67
Dressing glass, tongued-joint for, 46, 47
Dressing table chest of drawers, 140
Dressing table, part carcass of, 44
Drop leaf of table, fly rail for, 104
Drop table, kitchen, 17
Dust-proof drawer joint, 114
- EASTERN joint puzzle, 196
End of timber, halved joint at, 26
- FALL front of writing bureau, hingeing, 103
Fasteners, corrugated steel, 172
Feather tongues, 41, 49, 50
Feet, crush, 158
- Fencing, joint for, 59
File, dreadnought, 66, 67
Finger joint hinge, 106
Finial for cornice pole, 153, 154
Fished joint (scarf), 91, 92
Flake white, 2
Flap, back, hinge, 99, 100
Flooring joints, 39
Fly rail (revolving) for table, 104
Food troughs, dovetailing, 131
Footstool, dovetailed, 130
Fox wedged tenon, 62, 63
Frame, building up semi-circular head of door, 151, 152
Frame, circular, jointing, 149
Frame dovetails, 125, 126, 127
Frame, dowelling, 84, 85
Frame, dowelling a mitred, 84
Frame, dowelling for moulded, 85, 86
Frame, garden, joint, 156, 157
Frame, haunched tenon joint for garden, 58
Frame jointed with steel fasteners, 173
Frame, keyed picture, 156, 157
Frame, laminated table, 152
Frame, lining up a glass, 7
Frame (Oxford) halved joints, 20, 21
Frame, pelleting a, 156, 157
Frame (window) moulded sash bar tenon joint for, 63, 64
Frame with bridle joint, 28, 36
Frame with halved joint, 11
Frames for oil paintings, 171, 172
Framing, bevelled with mitred moulding, 182, 183
Framing, dovetail joints in, 127
Framing, inside joint for, 55
Framing joint, cross, 167, 168
Framing joint, mortise and tenon, 55
Framing, saddle joint for, 161
Framing, table (tenon joint), 64, 65

Index

- GARDEN** frame, haunched tenon joint for, 58
Garden frame joint, 58, 156, 157
Gate joint, tenon, 57
Gauge, cutting, 133, 134
Gauge, cutting, how to use for dovetailing, 120, 134
Gauge, dowel, for legs, 86, 87
Gauge, marking, the, 21, 23, 31, 68
Gauge, mortise, 71
Gauge, using the marking, 23
Gauging and marking for dowels, 81, 82
Gauging for a bridle joint, 31
Gauging for dovetails, 119, 135
Gauging for hingeing, importance of, 93, 95
Gauging for mitres, 181, 182
Gauging for tenons, 54
Girders, cogged joint for, 161
Glue blocking, 159, 160
Glued joint, application of the, 6
Glued joint, display cabinet top with, 9
Glued joint, supporting, 2
GLUED JOINT, THE, 1—10
Glued joints, arrangement of timber for, 4
Glued joints, cramping, 2, 3
Glued joints, testing the, 3
Glued joints, their method of work, 4
Glueing dowels, 82
Glueing for glued joints, 1
Groove, housing, 166
Groove in drawer runner, 43
GROOVED AND TONGUED JOINT (see TONGUED AND GROOVED JOINT).
Grooved dowels, 79
Grooves, cutting with plane, 49
GROOVING, DOVETAIL, 145—148
Guide block for bevelling in dovetail grooving, 146

HALF lap scarf joint, 89, 90
Half-lapped bevelled dovetail joint, 17
Half mitre, a, 178
Halved and dovetailed joints, 16, 17
Halved corner joint, 12
Halved joint, angle, 25
Halved joint at end of timber, 26
Halved joint, chiselling, 23
Halved joint for cross framing, 167, 168
Halved joint, how to mark out the, 22
HALVED JOINT, THE, 11—26
Halved joint with double dovetail, 14
Halved joint with one side dovetailed, 14
Halved joints for Oxford frame, 20, 21
Halved joints (manual training exercise) 18, 19
Halved joints on barrow wheel, 16, 17
Halved joints, sawing, 24
Halved joints, tools used for making, 21
Halved moulded joint, 17, 18
Halved tee joint, 12
Halved tee joint, dovetailed, 15, 16
Halved (upright) and cross rail joint, 19
Halving, cross, joints, 15
Halving, dovetail, 13
Halving joint, cross, 18
Halving joint, cross, with housed shoulders, 19
Halving joint, (dovetailed) for lengthening timber, 15, 16
Halving, mitred, 13
Halving, oblique, 12, 13
Halving, oblique dovetail, 14, 15
Halving, oblique, with shoulder, 12, 13
Halving, stopped, dovetail, 14, 15
Hammer, the, 26
Hammer head tenon, 65
Handscrew, 148
Hanging, close joint, 110

Hanging, inside, 101
 Hanging, open joint, 109
 Hanging, outside, 103
 Haunch on cross rails, 68, 70
 Haunch on twin tenons, 64, 65
 Haunched barefaced tenon, 55
 Haunched tenon, 54
 Haunched tenon joint, 56, 58
 Haunched twin tenons, 64, 65
 Haunching, removing, 74
 Haunching with groove above,
 76
 Hinge, back flap, 99, 100
 Hinge, bagatelle, 99
 Hinge-bound doors, 93, 94, 96
 Hinge, butt, 93, 95
 Hinge, card table, 99, 100
 Hinge clearing architrave mould,
 109, 110
 Hinge, desk, 99
 Hinge, finger joint, 106
 Hinge, knuckle joint, 107
 Hinge, pivot, 98, 99, 100
 Hinge, rising butt, 99, 100
 Hinge strap, 98, 99
 Hinged joint for cornice poles,
 156
HINGED JOINT, THE, 93—110
 Hinged joints, stopped, 97
 Hingeing, alignment in, 94
 Hingeing at an acute angle, 100,
 101
 Hingeing box lid, 97
 Hingeing, close joint, 110
 Hingeing curved work, 94
 Hingeing draught screens, 104
 Hingeing, gauging for, 93, 95
 Hingeing, inside, 101
 Hingeing, open joint, 109
 Hingeing, outside 102, 103
 Hingeing shape-fronted work,
 94
 Hinges, cutting recess for, 95,
 96
 Hinges, fitting butt, 101, 102
 Hinges, marking for, 95
 Hinges, paring for, 96, 97
 Hinges, position for, 96
 Hinges, screen, 98

Hinges, tape or webbing, for
 draught screens, 105, 106
 Hinges, various, 99
 Hook joint, 113, 114
 Hoppers, dovetailing, 131
 Horn, the, on stiles, 56, 69
 Housed and mitred dovetail,
 128
 Housing joint, 166
 Housing, stopped, 166, 167

INSERTED tenons, 66
 Inside hingeing, 101
 Iron angle, buttoning with, 164
 Iron dowels, 77
 Iron nuts for scarf joints, 92

JACK-PLANE, the, 4
 Japanese mitred tenon joint, 171
 Japanese tenon joint, 59
 Jarrah, 39
 Jewel drawer side, dovetailing,
 131, 132
 Jig, dowelling (*see* Cradle).
 Joggle tenon (*see* Stub Tenon).
 Joiner's bevel, 21, 38, 145
 Joining rustic woodwork, 154
 Joining weather boarding, 153
 Joint, angle butt, 5
 Joint, butt, for counters, 169,
 170
 Joint, cogged, 161
 Joint, combing or locking, 45
 Joint, cross framing, 167, 168
 Joint, cross halving, 18
 Joint, dovetail halved, 13
 Joint, dovetail plate bed, 164,
 165
 Joint, dust proof drawer, 114
 Joint, finger, 106
 Joint, fished (scarf), 91, 92
 Joint for fencing, 59
 Joint for window sill, 115
 Joint, halved, at end of timber,
 26
 Joint, hook, 113, 114
 Joint, housing, 166
 Joint, Japanese tenon, 59
 Joint, knuckle, 107

Index

- Joint, open slot mortise and tenon, 28, 29, 38
Joint, rafter, 63, 64, 162
Joint, rafter and tie beam, 162
Joint, roll top desk, 161, 162
Joint, saddle, 161
Joint, tenon, for gate, 57
Joint (tenon), moulded and mitred, 60
Joint, twin tenon, 60
Jointing broken turned work, 157, 158
Jointing (butt) counter tops with dovetail keys, 164
Jointing with corrugated steel fasteners, 172
Jointing with shooting-board and plane, 7, 8
Joints, battening, 167, 168
Joints, birdsmouth, 162, 163
Joints, bookcase shelf, 166, 167
JOINTS, BRIDLE, 27—38
 CURVED WORK, for, 149—152
 DOVETAIL GROOVING, 145—148
 DOVETAILED, 117—144
 DOWELLED, 77—88
 GLUED, 1—10
 HALVED, 11—26
 HINGED, 93—110
 MISCELLANEOUS, 153—176
 MORTISE AND TENON, 53—76
 PUZZLE, 187—200
 SCARF, 89—92
 SHUTTING, 111—116
 TONGUED AND GROOVED, 39—51
Joints, buttoning, 164
Joints, coopered, 170, 171
Joints, dovetail keyed, 164
Joints, halved (manual training exercise), 18, 19
Joints, notched, 160, 161, 162
Joints, scribing, 163
Joists, cogged joint for, 161
Joists, notched joints for, 160, 161, 162
KERF, saw, 80
Keyed picture frame, 156, 157
Keyhole screwing, 165, 166
Keying, dovetail, 129, 130
Keying, dovetail, for boxes, 168, 169
Keying, veneer, 156, 157
Keys (dovetail), butt jointing counter tops with, 164
King post joint, 63, 64
Kitchen drop table, 17
Knife boxes, dovetailing, 131
Knife, the marking, 21, 30, 35, 69
Knuckle joint hinge, 107
LADDER RUNGS, 153
Ladder sides, 153, 154
Laminated core box, 152
Laminated table frame, 152
Laminated work, 7, 8
Lamination, 151
Lap-dovetail pins, roughing in, 122
Lap-dovetailing, 118
Lap-dovetailing, blind, 127
Lap-dovetailing, chipping waste of, 139, 141, 142
Lap-dovetailing drawer fronts, 141
Lap-dovetailing wardrobe top, 131, 132
Laths, winding, for glue jointing, 4
Lead, white, fixing tenon joints with, 67
Leaf (drop) of table, fly rail for, 104
Leaf, table, with dowels, 84
Leg (table) and framing, dowelling, 86, 87
Leg (table), bridle-jointed to rail, 27
Leg (table) fixing interior, 57
Legs, dowel gauge for, 86, 87
Legs, jointing broken table and chair, 158
Lengthening timber, dovetailed halving joint for, 15, 16

Index

- Lid, hingeing box, 97
Light-tight joints, 115
Locking or combing joint 45
Lopers, 159
- MAHOGANY, 6, 122
Mallet, 26, 72, 73, 121
Manual training joints (exercise),
14, 16, 17, 18, 19, 169, 171
Maple, 39
Marking and gauging for dowels,
81, 82
Marking awl, 88, 123, 138
Marking awl, using for dove-
tails, 137
Marking for hinges, 95
Marking gauge, 23, 31, 68
Marking knife, the, 21, 30, 35, 69
Matchboarding, 39, 40
Matchboarding, beaded, 40
Matchboarding, double dove-
tailed and tongued, 40
Matchboarding, double-tongued,
40
Matchboarding, vee'd, 40
Medicine cupboard joints, 62
Meeting stiles, 112
MISCELLANEOUS JOINTS, 153—
185
Mitre, a half, 178
Mitre bride joint, 2
MITRE JOINT, THE, 177—186
Mitre joint, tongued and grooved,
46
Mitre trap, screw, 175
Mitred and housed dovetail, 128
Mitred and moulded joint
(tenoned), 60
Mitred dovetail joint, 128
Mitred face tenon joint, 63
Mitred frame, dowelling a, 84
Mitred frame joints, wedging,
171, 172
Mitred halving, 13
Mitred joint with steel fasteners,
175
Mitred moulding on bevelled
framing, 182, 183
Mitred shooting-board, 180
- Mitred skirting, 177
Mitred tenon joint, Japanese,
171
Mitreing a moulded door frame,
186
Mitreing, finding right-angle for,
177
Mitreing, sawing block for 179
Mitreing, template for, 185,
186
Mitreing, what it denotes, 177
Mitres, curved, 183, 184
Mitres, curved, setting out for,
184
Mitres, finding angles for straight,
178, 179
Mitres, gauging for, 181, 182
Mitres, straight, 179
Moulding, bevelled framing with
mitres, 182, 183
Mouldings, sawing for mitreing,
179
Mortise and tenon joint for
inside framing, 55
Mortise and tenon joint, open
slot, 28, 29, 38
MORTISE AND TENON JOINT,
THE, 53—76
Mortise and tenon joints, light
Japanese vase stands with, 52
Mortise and tenon joints, set-
ting out and making, 68
Mortise and tenon, wheelwright's
self-wedging, 62
Mortise gauge, 71
Mortise joint, slot, 65
Mortise, removing waste of with
chisel, 74
Mortise with side removed, 75
Mortising puzzle, 197, 198
Mortising stiles, 72
Mortising tool, 57
Mortising, using chisel and mal-
let for 73, 74
Mould, bolection, 63
Mould, double skirting, building
up, 46
Mould, hinge clearing architrave,
109, 110

Index

- Moulded and mitred joint, (tenoned), 60
Moulded frame, dowelling for, 85, 86
Moulded joint, halved, 17, 18
Moulded sash bar tenon joint, 63, 64
Moulding glued on shelf, 3, 6
Moulding, scribed, 163
- NAIL**, double-pointed dowelling, 77
Non-reversible screen hinge, 98, 100
Notched joints, 160, 161, 162
Nuts, iron, for scarf joints, 92
- OAK**, 39
Oblique angle bridle joint, 29, 30
Oblique bridle joint, 28
Oblique dovetail halving, 14
Oblique dovetailing, 131, 133
Oblique halving, 12, 13
Oblique halving, with shoulder, 12, 13
Open joint hingeing, 109
Open slot mortise, 65
Open slot mortise and tenon joint, 28, 29, 38
Outside hingeing, 102, 103
Oxford frame halved joints, 20, 21
- PANEL**, jointing ogee-shaped, 5, 7
Paring, 24, 25
Paring for hinges, 96, 97
Partition joints, cellarette, 19, 20
Patera covers for screw fixtures, 155
Pattern-making joints, 17
Pediment, washstand, dowelling a, 88
Pegs (*see* Dowels).
Pelleting, 156, 157
Pencil, the, 21
Photographic "light-tight" joints, 115
- Piano-fall, building up case of, 7, 8
Picture frame, keyed, 156, 157
Picture frame, pelleting a, 156, 157
Pillar, dowelling cap to, 86
Pillars, jointing sideboard, 159
Pine, 1, 2
Pinning, 60, 61
Pinning, drawbore, 63, 64
Pins, castor, 158
Pins, dovetail, 120
Pins, marking dovetail, 133, 135
Pins, method of sawing dovetail, 121
Pins, sawing dovetail, 143
Pins, steel, wire, 86
Pivot hinge, 98, 99, 100
Plane for making tongues and grooves, 41, 42
Plane, jack, the, 4
Plane, making tongues with, 49
Plane, old woman's tooth, 147
Plane, plough, 47, 48, 49, 112
Plane, Stanley, 116
Plane, trying, 4
Plane, use of toothing, for glued joints, 2
Planes for shutting joints, 116
Planes, tongueing, 50, 51
Planing, cradle for, 42
Planing for glue jointing, 4
Planing for mitred work, 181
Planing grooves, 49
Plank side of ladder, 154
Plate, dowel, steel, 78
Plates, dovetail, for bed joints, 164, 165
Plinth or cornice secured with steel fasteners, 175
Plough plane, the, 47, 48, 49, 112
Plough slip, glueing to drawer, 7, 8
Ploughing, 47
Plugs, wall, 165
Pocket screwing, 160
Pole, cornice, method of dowelling, 83
Pole, finial for cornice, 153, 154

Index

- Pole side of ladder, 145
Poles, cornice, hinged joint for
156
Post, dowelling cap to, 86
Post, king, joint, 63, 64
Post, upright, joint of rails to,
60, 61
Pounce-bag, 123
Purlins, 90
Purlins, cogged joint for, 161
Puzzle, Eastern joint, 196
Puzzle joint, Chinese, 187
Puzzle joint, curious dovetail,
193
Puzzle joint, dovetail, 194, 195
PUZZLE JOINTS, 187—200
Puzzle, mortising, 198
Puzzle, six-piece joint, 199, 200
- QUARTERED timber, 5
Queen Anne leg, dowelling, 87
- RAFTER and tie beam joint,
162
Rafter, bridle joint for, 30
Rafter, cogged joint for, 161
Rafter joint, 30, 63, 64, 161, 162
Rail and stile, framed, 56
Rail (cross) and upright halved
joint, 19
Rail, dovetailed bearer, 131
Rail, dovetailed stretcher, 127,
130
Rail, revolving fly, for table, 104
Rails and stiles, setting out, 68
Rails, tenon joint for wide and
narrow, 66, 67
Rails, top-, tenon joints to post,
61
Rebated astragal, 112
Rebated shutting joint with
tongue slip, 113, 114
Recess for hinges, cutting and
paring, 95, 96, 97
Reversible or double-folding
screen hinge, 98, 99
Revolving fly-rail for table, 104
Rising butt hinge, 99, 100
Roll top desk fall joint, 161, 162
- Roof joint (tie beam, king post
and strut) 63, 64
Roof scarf joint, 90
Roof truss, bridle joint for, 29,
30
Rose bit, 80, 81
Rosewood, 1
Rounder, dowel, 81
Rubbed joints, 1
Rungs, ladder, 153
Rustic woodwork, joining, 154
- SADDLE joint, 161
Sash bar (moulded) tenon, 63,
64
Satin walnut, 121
Satinwood, 2, 122
Saw, dovetail, 96, 124, 144
Saw kerf, 80
Saw, the tenon, 21, 35
Saw, using for bridle joints, 34
Sawing block for mitreing, 179
Sawing dovetails, 138
Sawing halved joints, 24
Scantlings, notched joints for,
160
Scarf joint, double tenoned, 90,
91
Scarf joint, dovetailed, 89, 90
Scarf joint, half lap, 89, 90
Scarf joint, tenoned, 90, 91
SCARF JOINT, THE, 89—92
Scarf joint used in roof work, 90
Scarf joint with vee'd ends, 91
Scarf joints, iron nuts, bolts, and
washers for, 92
Screens, hingeing draught, 104
Screens, hinges for, 98, 104
Screw-bound door, 94
Screw, double-pointed, 154, 159
Screw, dowel, 154, 159
Screw fixtures, patera covers for,
155
Screw mitre trap, 175
Screwing, pocket, 160
Screwing, slot or keyhole, 165,
166
Scribed and tenoned joint, 59,
60

Index

- Scribing joints, 163
Secrétaire falls, clamping, 66
Segments, circular rim in halved, 150, 151
Segments, marking for circular jointing, 149, 150
Set-square, the, 4
Shape-fronted work, hingeing, 94
Shaped rail, dowelling a, 85
Shed, post and rail joint for, 61
Shelf joints, bookcase, 166, 167
Shelf slip-glued with hardwood, 3, 6
Shooting board, donkey's ear, 181
Shooting board, mitre, 180
Shoulder, oblique halving joint with, 12, 13
Shoulder of tenon, cutting channel at, 71, 72
Shoulder, tongued and grooved, tenon with, 64
Shouldered tenon joints, 58
Shoulders, cross halving joint with housed or notched, 19
Shoulders, cutting bridle joint, 35
Shoulders, dovetailed halved joint with 16, 17
Showcase joints, 116
SHUTTING JOINTS, 111—116
Shutting joints, planes for, 116
Sideboard, cottage, 174
Sideboard pillars, jointing, 159
Sideboard top, part of, with tongued joint, 43
Skirting board, scribed, 163
Skirting, mitred, 177
Skirting mould, double, building up, 46
Skylight joint, 156, 157
Skylight tenon (haunched) joint, 58
Slamming stile, 111
Slaped joint, 1
Slide joint, dining-table, 159
Slide, tee, 159
Slipped joint, 1
Slot mortise joint, 65
Slot (open) mortise and tenon joint, 28, 29, 38
Slot screwing 165, 166
Spandrel, jointing a shaped, 7, 8
Spandrel, tongued joint for shaped, 43
Sprocket wheel, 57
Spruce, 77
Square, the set, 4
Square, the try, 21, 30, 38, 88
Square, using the, 22, 23
Stands, Japanese vase, with mortise and tenon joints, 52
Stanley plane, 116
Steel dowel plate, 78
Steel fasteners, corrugated, 172
Steel wire pins, 86
Sticks, twist, for glue-jointing, 4
Stile and cross rail, framed, 56
Stile, meeting, 112
Stile, slamming, 111
Stiles and rails, setting out, 68
Stiles, mortising, 72
Stop-bound door, 93, 94
Stopped bridle joint, 28, 29
Stopped dovetail halving, 14, 15
Stopped hinged joints, 97
Stopped housing, 166, 167
Straight-edge, using, for glued joints, 3
Straight mitres, 179
Strap hinge, 98, 99
Stretcher rail, dovetailed, 127, 130
Strut, oblique bridle joint for, 28
Strut (roof) joint 63, 64
Stub tenon, 53, 54, 55
Studs, bookcase, 166, 168
Stump tenon, (*see* Stub Tenon).
Sycamore, 2
TABLE and chair legs, jointing broken, 158
Table (card) hinge, 99, 100
Table (dining) slide joint, 159
Table (dressing) bearer rail, dovetailed, 131

Index

- Table (dressing) chest of drawers, 140
Table (dressing), part carcass of, 44
Table (drop), kitchen, 17
Table frame, laminated, 152
Table framing (tenon joint), 64, 65
Table joint, 20
Table leaf with dowels, 84
Table leg and frame, dowelling, 86, 87
Table leg, fixing interior, 57
Table (occasional), with four drawers, 144
Table, revolving fly rail for, 104
Table top, buttoning a, 164
Table top, writing, with tongued and grooved joints, 44
Tambour front joint, 161, 162
Tape hinges for draught screens, 105, 106
Tea-caddies, housed and mitred joint for, 128
Teak, 1
Tee halving joint, dovetailed, 15, 16
Tee joint, halved, 12
Tee slide, 159
Template, dovetailing, 135, 136
Template for dowelling, 83
Template for mitreing, 185, 186
Tenon and wedge, tusk, 61
Tenon, barefaced, haunched, 55
Tenon, cutting channel at shoulder of, 72
Tenon, drawbore-pinned, 63, 64
Tenon, faulty, 59
Tenon, fox wedged, 62, 63
Tenon, hammer head, 65
Tenon, haunched, 54, 55, 56, 58
Tenon, haunched, for skylight or garden frame, 58
Tenon joint, barefaced, 53, 55
Tenon joint, Japanese, 59
Tenon joint, Japanese mitred, 171
Tenon joint, mitred and moulded, 60
Tenon joint, mitred face, 63
Tenon joint, moulded sash bar, 63, 64
Tenon joint, twin, 60, 64
Tenon joint, wheelwright's self-wedging, 62
Tenon joints, external and internal, 67, 68
TENON JOINTS (see MORTISE AND TENON JOINTS).
Tenon joints—setting out and making, 68
Tenon joints, shouldered, 58
Tenon joints, wedges for, 56
Tenon saw, the, 21
Tenon, stub, 53, 54, 55
Tenon, tusk, 61
Tenon, wedged and dovetailed, 62
Tenon with tongued and grooved shoulder, 64, 65
Tenoned and scribed joint, 59, 60
Tenoned (double) scarf joint, 90, 91
Tenoned scarf joint, 90, 91
Tenoning a wide and a narrow rail, 67
Tenoning (pinning) 60, 61
Tenons, inserted, 65
Tenons, sawing, 70, 71
Tenons, thickness of, 71
Tenons, twin with haunch, 64, 65
Tie beam and rafter joint, 162
Tie beam, bridle joint for, 29, 30
Tie beam joints, 29, 30, 63, 64, 162
Tie joint, carpentry, 19
Timber, arrangement of for glued joints, 4
Timber, dovetailed halving joint for lengthening, 15, 16
Timber, halved joint at end of, 26
Timber, heart side of in glued joints, 8, 10
Timber, quartered, 5
Toes, crush, 158

Index

- TONGUED AND GROOVED JOINT,**
39—51
Tongued and grooved joint,
applications of the, 42,
Tongued and grooved joint,
planes, for, 41, 42
Tongued and grooved mitre
joint, 46
Tongued and grooved shoulder,
tenon with 64, 65
Tongued cabinetwork joints, 41
Tongued coopered joints, 171
Tongued corner joints, 45, 46
Tongued joint for dressing glass,
46, 47
Tongued joint for shaped span-
drel, 43
Tongued joint for sideboard top,
43
Tongueing planes, 50
Tongues, cross, 41, 42, 43, 50
Tongues, feather, 41, 49, 50
Tongues, loose, 41, 42
Tongues, making with plane, 49
Tool, mortising, 57
Tooth plane (old woman's), 147
Trap, screw mitre, 175
Trench, housing, 166
Trestle joint, workshop, 19, 20
Troughs, food, dovetailing, 131
Truss, bridle joint for, 29, 30
Try square, the, 21, 30, 38, 88
Trying plane, the, 4
Turned pateras for hiding screws,
155
Turned pillar, dowelling for, 86
Turned work, jointing 157, 158
Tusk tenon, 61
Tusk tenon and wedge, 61
Twin tenon joint, 60, 64
Twin tenons with haunch, 64, 65
Twist bit, 81
Twist bit, block for, 85
Twist sticks for glue jointing, 4
- UPRIGHT** halved and cross rail
joint, 19
- VARNISH**, uniting joint with, 67
- Vee-jointed matchboarding, 40
Veneer keyed frame, 156, 157
Veneer keying, 156, 157
Vice, the, 23, 35, 80, 124, 125
- WALL** plugs, 165
Walnut, satin, 121
Wardrobe top, lap-dovetailing,
131, 132
Washers for scarf joints, 92
Washstand bearer rail, dove-
tailed, 131
Washstand pediment, dowelling
a, 88
Waste, boring, for bridle joints,
33
Waste, paring, 24, 25
Weather boards, joining, 153
Webbing hinges for draught
screens, 105, 106
Wedge and dovetail tenon, 62
Wedge tenon joint, wheel
wright's, 62
Wedge tusk tenon, 61
Wedges, folding, for counter
butt joints, 169, 170
Wedges for scarf joints, 91
Wedges for tenon joints, 56
Wedging canvas frames, 171, 172
Wheel, sprocket, 57
Wheelbarrow, joints, 16, 17
Wheelwright's self-wedging mor-
tise and tenon joint, 62
White lead, uniting tenon joints
with, 67
Whitewood, American, 121
Winding laths for glue jointing, 4
Window frame, moulded sash
bar tenon joint for, 63, 64
Window sill joint, 115
Wire, steel, pins, 86
Woodwork, joining rustic, 154
Workbox, hingeing, 97
Workshop trestle joint, 19, 20
Writing bureau, hingeing fall
front of, 103
Writing table top with tongued
and grooved joints, 44





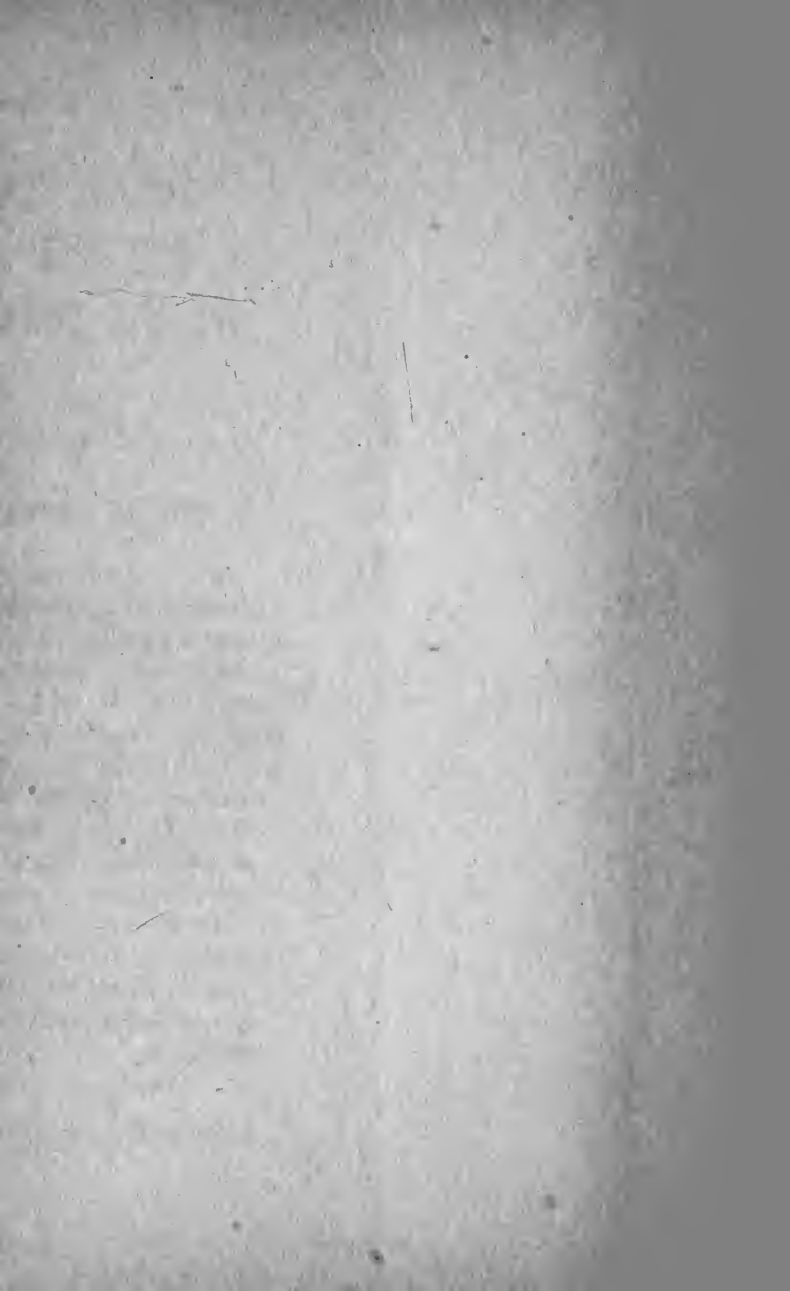



LIBRARY OF CONGRESS



0 013 960 354 0